



SAFETY

QUALITY

PERFORMANCE

SAME DAY SHIPPING

FULLY STOCKED WAREHOUSES

MANUFACTURING HEADQUARTERS

185 Boston Post Road, North Windham, CT 06256

Phone: 860-456-7131

Email: info@unitedabrasives.com

CUSTOMER SERVICE

US Toll Free: 800-428-5927

US Fax Orders: 860-456-8341

Email: orderdeskus@unitedabrasives.com

Canada Sales: 800-345-7248

Email Canada: orderdeskCN@unitedabrasives.com

UNITED ABRASIVES / SAIT

www.UnitedAbrasive.com



**2022-2023
CATALOG**



www.UnitedAbrasives.com

© 2021 United Abrasives, Inc. • Printed in the U.S.A. • Form #99002-22



2022-2023

AMERICAN MADE



INDUSTRIAL GRADE

CATALOG INDEX



GRINDING WHEELS 6

- 1/4" GRINDING WHEELS: TYPE 27 8-12
- 1/4" GRINDING WHEELS: TYPE 28 13
- FLEXIBLE GRINDING / BLENDING WHEELS: TYPE 29 14
- 1/8" PIPELINE WHEELS..... 15-17
- CUP STONES..... 18
- DIAMOND CUP WHEELS ****NEW**** 19
- MOUNTED POINTS..... 20
- CONES & PLUGS..... 21
- BENCH WHEELS..... 22
- HAND & FLOOR RUBS 23
- COTTON FIBER..... 24-25



CUTTING WHEELS 26

- HOW TO PICK A CUTTING WHEEL 28-29
- .045" CUTTING WHEELS 30-33
- .090" CUTTING & NOTCHING WHEELS ... 34-35
- .095" ULTIMATE COMBO WHEELS 36
- 3/32" & 1/8" CUTTING WHEELS 37-38
- TOOL ROOM..... 39
- THIN HIGH SPEED CUT-OFF..... 40-41
- SMALL DIAMETER PORTABLE SAW CUT-OFF WHEELS..... 42
- LARGE DIAMETER CUTTING WHEELS... 43-49
- CHOP SAW WHEELS 44-45
- PORTABLE SAW WHEELS..... 46-48
- STREET SAW WHEELS 49
- STATIONARY SAW WHEELS..... 49
- METAL-CUTTING CARBIDE BLADES ... 50-53
- DIAMOND BLADES..... 54-55



DIFFERENCE

LONGER LASTING Unlike many abrasive manufacturers, we only use premium grains, and we never use inferior fillers or bonding agents. With durable abrasives that continue to perform over time, you can avoid frequent re-orders and costly downtime.

SAFER The manufacturing process, from start to finish, incorporates state-of-the-art equipment, quality control analysis and compliance, and rigorous product evaluation to ensure our customers receive the safest, most consistent and best performing wheels on the market.

HIGHEST QUALITY We use premium heavy duty fiberglass reinforcement to ensure that our abrasives last longer and perform better.

MADE IN THE U.S.A. At our manufacturing facilities in Connecticut and Florida, we employ state-of-the-art equipment and rigorous quality control testing.

SAME DAY SHIPPING With United Abrasives, every order is a rush order. Our streamlined fulfillment operation means products go from phone order to delivery truck in minutes.



FIRST FULLY AUTOMATED BONDED ABRASIVE PRESS



MANUFACTURING FACILITY OPENED IN NAPLES, FLORIDA



PATENT FILED FOR TYPE 27 .045" CUTTING WHEEL



STATE OF THE ART ROBOTICS INTRODUCED INTO OUR MANUFACTURING PROCESS



2022 AND BEYOND



SAME DAY SHIPPING CAPABILITIES ESTABLISHED AS WE EXPANDED OUR CONNECTICUT FACILITIES TO OVER HALF A MILLION SQUARE FEET

WORLDWIDE LEADER IN THE ABRASIVES INDUSTRY



United Abrasives/SAIT continues to introduce new and innovative products to the market place. We continually update and invest in all aspects of our company – product development, manufacturing, shipping and customer service. We will always be driven to provide the highest quality and safest abrasives in the industry, continuing to be the worldwide leader in the abrasives industry.

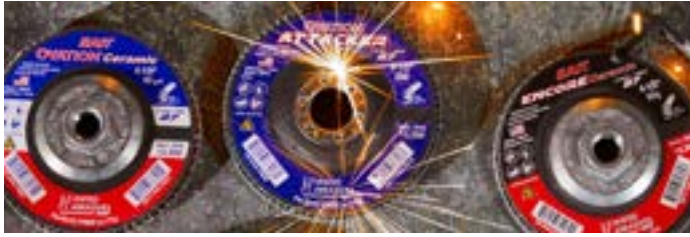

COATED ABRASIVES 56

TECHNICAL INFORMATION 58-59

FLAP DISCS 60-69

FLAP DISCS - PLASTIC BACKING 62-63

FLAP DISCS - FIBERGLASS BACKING . . 64-65

FLAP DISCS - TRIMMABLE
PLASTIC BACKING 66-67

FLAP DISCS - SPECIALTY 68-69

FLAP WHEELS - SMALL DIAMETER 70

FLAP WHEELS - LARGE DIAMETER 71

FIBER DISCS 72-77

FIBER DISCS - ALUMINUM OXIDE 74

FIBER DISCS - ZIRCONIUM 75

FIBER DISCS - CERAMIC 76-77

FIBER DISCS - SILICON CARBIDE 77

STOCK BELTS 78-83

PAPER DISCS 84-86

CLOTH DISCS 87

LAMINATED DISCS 88-89

PAPER SHEETS 90-91

CLOTH SHEETS 92

DRYWALL 93

FILE BOARD SHEETS & SPONGES 94

SHOP ROLLS 95

SPECIALTY SHOP ROLLS 96

FLOOR SANDING 97-99

CARTRIDGE ROLLS 100-101

SPIRAL BANDS 102

CROSS & SQUARE PADS 103

NON-WOVEN ABRASIVES 104

NON-WOVEN HAND PADS 106

NON-WOVEN BELTS 107

DEBURRING & CLEANING DISCS 108

SAND-LIGHT™ BLENDING DISCS 109

FLAP BRUSHES &
LINEAR POLISHING WHEELS 110

FLAP WHEELS & INTERLEAF WHEELS . . 111

INTERLEAF & NON-WOVEN
FLAP DISCS 112

SAIT-STRIP™ 113

UNITIZED WHEELS & DISCS 114

CONVOLUTE WHEELS & BUFFING ITEMS . . 115

WIRE BRUSHES 116

TECHNICAL INFORMATION 116

BENCH WIRE WHEELS &
CUP BRUSHES 118-119

WIRE WHEELS &
PIPELINE BRUSHES 120-121

JOINT BRUSHES & END BRUSHES 122

HAND BRUSHES 123

NYLON BRUSHES 124

CARBIDE BURS 125-127

ACCESSORIES 128-136

**TECHNICAL INFO &
SAFETY GUIDE 137-143**

INDEX BY PART NUMBER 144-145

COMPANY TIMELINE 146-147



WHO WE ARE

OUR STORY

Since its founding in 1970, United Abrasives/SAIT has been synonymous with quality, reliability, innovation and value. We continue as a leader in the abrasives industry with products that set new standards of excellence. We're proud of our reputation, and dedicated to continually testing, designing and improving our products to ensure quality and maximum function.

United Abrasives is a privately held company. Our relationship with SAIT, an Italian corporation founded in 1953, began as we first manufactured coated abrasive belts. By 1975 we had expanded our production to include bonded abrasives. The strong commitment between United Abrasives and SAIT continues today.

Staying true to our core values during our fifty years in business has helped us create a company we're proud to run and work for. Our focus remains on making the best abrasive products possible.



North Windham, Connecticut

PRODUCT WARRANTY

United Abrasives, Inc. warrants that all industrial products it manufactures will be as represented in its catalog and will be free from defects in material and workmanship under normal use for which the product was intended if, but only if, it has been properly stored and used. Our obligation under this Warranty shall be limited to either the exchange of any product proven to be defective under normal use or to refund the purchase price thereof, at our option, within six months from the date of purchase by the original purchaser. The term "original purchaser", as used in this Warranty, shall be deemed to mean that person or company to whom the product was originally sold. This remedy is purchaser's exclusive remedy against United Abrasives, Inc. for any damages to either person or property caused by any defect or other failure in the product. Said refund or exchange shall constitute a fulfillment of any and all liabilities of United Abrasives, Inc. with respect to the quality of the product sold by it.

THIS WARRANTY IS EXPRESSLY IN LIEU OF ALL OTHER WARRANTIES EXPRESSED OR IMPLIED, INCLUDING THE WARRANTIES OF MERCHANTABILITY AND FITNESS FOR USE AND OF ALL OTHER OBLIGATIONS OR LIABILITIES ON OUR PART, AND WE NEITHER

ASSUME NOR AUTHORIZE ANY OTHER PERSON TO ASSUME FOR US, ANY OTHER LIABILITY IN CONNECTION WITH THE SALE OF OUR PRODUCTS. THIS WARRANTY SHALL NOT APPLY TO ANY PRODUCT SOLD BY US WHICH HAS BEEN SUBJECT TO ACCIDENT, NEGLIGENCE, ALTERATION, ABUSE, OR MISUSE. WE MAKE NO WARRANTY WITH RESPECT TO ACCESSORIES OR PARTS EMPLOYED BY THE USER WITH OUR PRODUCT WHICH WERE NOT SUPPLIED BY UNITED ABRASIVES, INC. UNDER NO CIRCUMSTANCES IS UNITED ABRASIVES, INC. LIABLE FOR ANY DIRECT INCIDENTAL, SPECIAL, OR CONSEQUENTIAL DAMAGES (INCLUDING LOST PROFITS) IN ANY WAY RELATING TO THE PRODUCTS SOLD BY UNITED ABRASIVES, INC.

All products listed in this catalog must be used in accordance with the safety regulations set by OSHA, by the directive described by the American National Safety Institute B7.1 ("Safety Requirements for the Use, Care and Protection of Abrasive Wheels") and by the American Brush Manufacturers Association. The user of any United Abrasives, Inc. product should be thoroughly familiar with the above safety rules and regulations before use of the product.

WHEEL LABELS

The following is an example of a label that can be found on United Abrasives' wheels. We feel it is important to include as much information as possible on our labels so the end user has the pertinent information needed to operate the wheel. All of our labels are baked on the wheels during the manufacturing process so the label remains intact throughout the life of the wheel.

WHEEL LABEL COLOR CODING

- METAL
- STAINLESS STEEL
- ALUMINUM
- CONCRETE

Product name — SAIT TOUGH GRIND

ANSI marking system to identify wheel type — A24T-EP

Size of wheel — 4-1/2 x 1/4 TYPE 27

Tool icon for ease of selecting application — GRIND WHEEL

Maximum revolutions per minute the wheel can be used at — MAX. RPM 13,300

Safety information — AVERTISSEMENT EXTREMEMENT DANGEREUX: Lire l'INSTRUCTION PAQUE... (Warning: EXTREMELY DANGEROUS SUPERFICIAL USE MAY CAUSE WHEEL BREAKAGE AND SERIOUS INJURY...)

French safety information — AVERTISSEMENT EXTREMEMENT DANGEREUX: Lire l'INSTRUCTION PAQUE... (Warning: EXTREMELY DANGEROUS SUPERFICIAL USE MAY CAUSE WHEEL BREAKAGE AND SERIOUS INJURY...)

UPC bar code

Part number

Arbor size

UPDATED LABEL

Product name — SAIT Z-TECH

Size of wheel — 4-1/2 x .045 Type 27/42

Materials — Steel / Ac., Stainless / Inox.

Arbor size — 7/8 Arbor 23304

Part number — 5/8-11 RA6 23302

UPC bar code

Maximum revolutions per minute the wheel can be used at — 13,300 MAX. RPM

Tool icon for ease of selecting application — Use Guard

Safety icons

- Protect your face
- Protect your hands
- Use wheel guard
- Protect your eyes, ears and lungs
- No grinding
- Do not use a damaged wheel
- Read information
- Breaking wheel hazard

WHEEL LABEL COLOR CODING

- METAL
- STAINLESS STEEL
- ALUMINUM
- CONCRETE
- WOOD

GRINDING WHEELS INDEX

TYPE 27 1/4" WHEELS 8

- A24N 8
- A24R 8
- A24T 8
- SAIT Z-TECH™ - Z24R 8
- THE ULTIMATE GRIND CERAMIC™ 10
- THE ULTIMATE GRIND™ 10
- SAITECH ATTACKER® 10
- SAITECH ULTIMATE PERFORMANCE™ 10
- XA24Q 12
- A46N - ALUMINUM 12
- C24N 12

TYPE 28 1/4" WHEELS 13

- A24N 13
- A24R 13
- SAITECH ULTIMATE PERFORMANCE™ 13

**TYPE 29 FLEXIBLE GRINDING/
BLENDING WHEELS 14**

- CHALLENGER II™ 14
- CHALLENGER 3™ 14
- CHALLENGER 3™ CERAMIC ****NEW**** 14

1/8" PIPELINE WHEELS. 15

- A24R PIPELINE 16
- SAIT Z-TECH™ 16
- SAITECH™ PIPELINE 16
- THE ULTIMATE PIPELINE™ 16
- THE ULTIMATE PIPELINE™ CERAMIC ****NEW**** 17

CUP STONES. 18

- A16 - GENERAL PURPOSE CUP STONES 18
- Z16 - ZIRCONIUM CUP STONES 18
- C16 - CONCRETE CUP STONES 18
- CA16 - COMBINATION CUP STONES 18

DIAMOND CUP WHEELS 19

- DIAMOND CUP WHEELS ****NEW**** 19

MOUNTED POINTS 20

- A36Q - RESIN BONDED 20
- A60R - VITRIFIED 20

CONES & PLUGS. 21

BENCH WHEELS 22

- ALUMINUM OXIDE 22
- GREEN SILICON CARBIDE 22

HAND & FLOOR RUBS 23

- HAND & FLOOR RUBS 23
- WOOD WEDGES 23

COTTON FIBER 24

- COTTON FIBER WHEELS 24
- COTTON FIBER MOUNTED POINTS 24
- COTTON FIBER FINISHING DISCS 25
- COTTON FIBER DEBURRING WHEELS 25



GRINDING WHEELS



TYPE 27 1/4" WHEELS



FAST GRINDING

A24N

- Aluminum oxide grain
- Soft bond for **fast stock removal**

METAL Ferrous metals (iron, steel, welds, etc.)

STAINLESS Low grade stainless steel



LONG LIFE

A24R

- Aluminum oxide grain - our most popular wheel
- For general purpose grinding
- **Longer life** for fewer wheel changes

METAL Ferrous metals (iron, steel, welds, etc.)



TOUGH GRIND

A24T

- Aluminum oxide grain
- Hard bond designed for **edge and bevel grinding** and other applications where a harder wheel is preferred
- **Longer life** for fewer wheel changes

METAL Ferrous metals (iron, steel, welds, etc.)



HIGH PERFORMANCE

SAIT Z-TECH™ - Z24R

- Tough zirconium grain
- **High performance grinding for the toughest applications**

METAL Ferrous metals (iron, steel, welds, etc.)

STAINLESS Stainless steel, high tensile alloys



DIA	THICKNESS	ARBOR	MAX RPM	QTY	A24N Fast Grind	A24R Long Life	A24T Tough Grind	SAIT Z-TECH™
3"	1/4"	3/8"	18,000	25	20002	—	—	—
4"	1/4"	3/8"	13,500	25	20012	—	—	—
4"	1/4"	5/8"	13,500	25	20015	20013	—	22599
4-1/2"	3/16"	7/8"	13,300	25	20050	—	—	—
4-1/2"	3/16"	5/8-11	13,300	10	20150	—	—	—
4-1/2"	1/4"	7/8"	13,300	25	20060	20063	20065	22600
4-1/2"	1/4"	5/8-11	13,300	10	20160	20163	20165	22610
5"	1/4"	7/8"	12,200	25	20070	20073	20075	22602
5"	1/4"	5/8-11	12,200	10	20170	20173	20175	22612
6"	1/4"	7/8"	10,200	25	20078	20079	20280	22603
6"	1/4"	5/8-11	10,200	10	20178	20076	20180	22613
7"	1/4"	7/8"	8,500	25	20081	20080	20285	22604
7"	1/4"	5/8-11	8,500	10	20085	20086	20185	22614
9"	1/4"	7/8"	6,600	25	20091	20090	20295	22606
9"	1/4"	5/8-11	6,600	10	20095	20096	20195	22616

TECH INFO

- The "softer" a grinding wheel is (A24N) the faster it will remove metal.
- Highest quality grain assures consistent stock removal for tough applications.
- All wheels are internally reinforced with the highest quality fiberglass for maximum safety.
- Our unique Super-Lock™ Hub combines both a mechanical locking system and chemical bond providing one of the safest, vibration-free designs in the industry.



Type 27



5/8-11
Super-Lock™ Hub



Angle Grinder

TYPE 27 1/4" WHEELS



EXTREMELY FAST GRINDING

THE ULTIMATE GRIND™ CERAMIC

- Our best choice for maximum stock removal
- Premium high ratio ceramic grain for increased efficiency and performance

METAL Ferrous metals (iron, steel, welds, etc.)

STAINLESS Stainless steel, high tensile alloys



PREMIUM PERFORMANCE

THE ULTIMATE GRIND™

- Proprietary grain and bond system
- **Premium performance for severe edge grinding**

METAL Ferrous metals (iron, steel, welds, etc.)

STAINLESS Stainless steel, high tensile alloys



FAST GRINDING

SAITECH ATTACKER®

- **Soft bond for extremely fast stock removal** on hard metals with minimal pressure
- High performance, ceramic aluminum oxide grain, is designed to outlast standard aluminum oxide wheels
- Very uniform, high density grain structure for long life and cooler cut

STAINLESS Stainless steel and other high tensile alloys

METAL Ferrous metals (iron, steel, welds, etc.)



PREMIUM PERFORMANCE

SAITECH ULTIMATE PERFORMANCE™

- **Hard bond for long life grinding** with fast stock removal
- High performance, ceramic aluminum oxide grain, is designed to outlast standard aluminum oxide wheels
- Very uniform, high density grain structure for long life and cooler cut

STAINLESS Stainless steel and other high tensile alloys

METAL Ferrous metals (iron, steel, welds, etc.)



DIA	THICKNESS	ARBOR	MAX RPM	QTY	ULTIMATE GRIND™ CERAMIC	ULTIMATE GRIND™	SAITECH ATTACKER®	SAITECH ULTIMATE PERFORMANCE™
4"	1/4"	3/8"	13,500	25	—	—	—	20112
4"	1/4"	5/8"	13,500	25	—	—	—	20014
4-1/2"	1/4"	7/8"	13,300	25	20204	22414	20046	20064
4-1/2"	1/4"	5/8-11	13,300	10	20214	22514	20146	20164
5"	1/4"	7/8"	12,200	25	20205	22415	20047	20074
5"	1/4"	5/8-11	12,200	10	20215	22515	20147	20174
6"	1/4"	7/8"	10,200	25	20206	22416	—	—
6"	1/4"	5/8-11	10,200	10	20216	22516	—	—
7"	1/4"	7/8"	8,500	25	20207	22417	20048	20084
7"	1/4"	5/8-11	8,500	10	20217	22517	20148	20089
9"	1/4"	7/8"	6,600	25	20209	22419	20049	20094
9"	1/4"	5/8-11	6,600	10	20219	22519	20149	20099

TECH INFO

- Designed to provide very long life for fewer wheel changes and less downtime.
- All sizes reinforced with the highest quality fiberglass for maximum safety and performance.
- Our unique Super-Lock™ Hub combines both a mechanical locking system and chemical bond providing one of the safest, vibration-free designs in the industry.

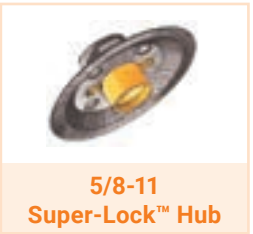
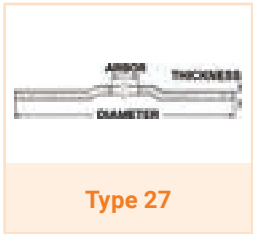

TYPE 27 1/4" WHEELS



contaminant **cf** free

XA24Q - CONTAMINANT-FREE / STAINLESS

- Specially formulated for nuclear and food processing plants where the need for **contaminant-free stock removal on stainless steel** is a concern
- Free of iron, chlorine and sulphur compounds (Fe + Cl + S < 0.1%)

STAINLESS Stainless steel and other high tensile alloys

METAL Ferrous metals (iron, steel, welds, etc.)

DIA	THICKNESS	ARBOR	MAX RPM	QTY	XA24Q
4-1/2"	1/4"	7/8"	13,300	25	24210
5"	1/4"	7/8"	12,200	25	24215
6"	1/4"	7/8"	10,200	25	24220
7"	1/4"	7/8"	8,500	25	24225
9"	1/4"	7/8"	6,600	25	24230



NOW AVAILABLE IN 6"

See page 24 for Cotton Fiber grinding and blending products for aluminum

A46N - ALUMINUM

- Special aluminum oxide formulation prevents "loading" on soft (non-ferrous) metals
- **Soft bond for aggressive removal of material without loading**
- Outlasts competition by as much as 40%

ALUMINUM Non-ferrous metals (aluminum, copper, brass, etc.)

DIA	THICKNESS	ARBOR	MAX RPM	QTY	A46N
4"	1/4"	5/8"	13,500	25	20018
4-1/2"	1/4"	7/8"	13,300	25	20062
4-1/2"	1/4"	5/8-11	13,300	10	20162
5"	1/4"	7/8"	12,200	25	20072
5"	1/4"	5/8-11	12,200	10	20172
6"	1/4"	7/8"	10,200	25	23360
6"	1/4"	5/8-11	10,200	10	23365
7"	1/4"	7/8"	8,500	25	20083
7"	1/4"	5/8-11	8,500	10	20088



C24N - CONCRETE

- Special silicon carbide grain formula is excellent for grinding masonry, concrete, stone and aggregate
- Use the C24N wheel on hard to grind metal like cast iron and carbide
- Soft bond for **fast stock removal**

CONCRETE Masonry, concrete, stone

METAL Cast iron and other ferrous metals, carbide

DIA	THICKNESS	ARBOR	MAX RPM	QTY	C24N
4-1/2"	1/4"	7/8"	13,300	25	20061
4-1/2"	1/4"	5/8-11	13,300	10	20161
5"	1/4"	7/8"	12,200	25	20071
5"	1/4"	5/8-11	12,200	10	20171
7"	1/4"	7/8"	8,500	25	20082
7"	1/4"	5/8-11	8,500	10	20087
9"	1/4"	7/8"	6,600	25	20092
9"	1/4"	5/8-11	6,600	10	20097

TECH INFO

- Designed to provide very long life for fewer wheel changes and less downtime.
- Highest quality grain assures consistent high stock removal.
- All sizes are made with uniform grain throughout.
- All sizes reinforced with the highest quality fiberglass for maximum safety and performance.
- Our unique Super-Lock™ Hub combines both a mechanical locking system and chemical bond providing one of the safest, vibration-free designs in the industry.



Type 27



5/8-11
Super-Lock™ Hub



Angle Grinder



FAST GRINDING

A24N TYPE 28

- Aluminum oxide grain
- Soft bond for fast stock removal
- Use this saucer shape (Type 28) for uniform grinding of large, flat surfaces

METAL Ferrous metals (iron, steel, welds, etc.)

STAINLESS Low grade stainless steel



LONG LIFE

A24R TYPE 28

- Aluminum oxide grain
- Medium bond for longer life and fewer wheel changes
- Use this saucer shape (Type 28) for uniform grinding of large, flat surfaces

METAL Ferrous metals (iron, steel, welds, etc.)



PREMIUM PERFORMANCE

SAITECH ULTIMATE PERFORMANCE™ TYPE 28

- High performance, ceramic aluminum oxide grain
- Very uniform, high density grain structure is extremely durable and self sharpening for long life and cooler cut
- Combines maximum material removal with long life
- Use this saucer shape (Type 28) for uniform grinding of large, flat surfaces

STAINLESS Stainless steel

METAL Ferrous metals (iron, steel, welds, etc.)

DIA	THICKNESS	ARBOR	MAX RPM	QTY	A24N Fast Grind	A24R Long Life	SAITECH ULTIMATE PERFORMANCE™
4-1/2"	1/4"	7/8"	13,300	25	21020	21021	–
4-1/2"	1/4"	5/8-11	13,300	10	21025	21026	–
7"	1/4"	7/8"	8,500	25	–	21000	21084
7"	1/4"	5/8-11	8,500	10	–	21005	21089
9"	1/4"	7/8"	6,600	25	–	21010	21094
9"	1/4"	5/8-11	6,600	10	–	21015	21099

TECH INFO

- Additional fiberglass reinforcement for maximum safety.
- Our unique Super-Lock™ Hub combines both a mechanical locking system and chemical bond providing one of the safest, vibration-free designs in the industry.

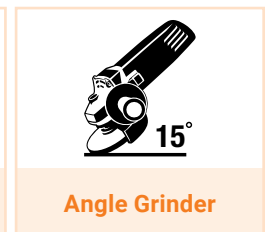
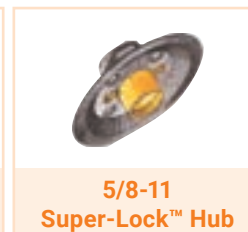
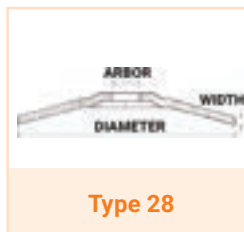

TYPE 29 FLEXIBLE GRINDING/BLENDING WHEELS

CHALLENGER II™

- Aluminum oxide grain
- Open pattern on wheel for cool grinding and blending
- Safe for use in the nuclear industry
- Use for longer life in aggressive applications
- Must be used with backing pad (one included in each box)

METAL Steel, iron, bronze

STAINLESS Stainless steel

ALUMINUM Non-ferrous metals (aluminum, copper, brass, etc.)

CONCRETE Masonry, plastic, fiberglass

CHALLENGER 3™ HIGH PERFORMANCE

- Semi-flexible
- Grind and blend welds in one step
- Open pattern on wheel for cool grinding and blending
- **Requires no backing pad**

STAINLESS Stainless steel

METAL Steel, iron, bronze

ALUMINUM Non-ferrous metals (aluminum, copper, brass, etc.)

CHALLENGER 3™ CERAMIC **NEW** PREMIUM PERFORMANCE

- Premium ceramic grain
- Open pattern on wheel for fast and cool grinding / blending
- Grinds and blends welds in one step
- Semi-flexible Type 29 design is ideal for inside diameters of pipes and contours
- **Requires no backing pad**

STAINLESS Stainless steel and high tensile alloys

METAL Steel, iron, bronze, mill scale

ALUMINUM Non-ferrous metals (aluminum, copper, brass, etc.)

DIA	THICKNESS	ARBOR	GRIT	MAX RPM	CHALLENGER II™ (QTY 25)	CHALLENGER 3™ (QTY 10)	CHALLENGER 3™ CERAMIC (QTY 10)
4-1/2"	1/8"	7/8"	36	13,280	27500	27610	27710
4-1/2"	1/8"	7/8"	60	13,280	27501	27611	-
4-1/2"	1/8"	7/8"	100	13,280	27502	-	-
4-1/2"	1/8"	5/8-11	36	13,280	-	-	27810
5"	1/8"	7/8"	36	12,200	27506	27615	27715
5"	1/8"	7/8"	60	12,200	27507	27616	-
7"	1/8"	7/8"	24	8,600	27510	-	-
7"	1/8"	7/8"	36	8,600	27511	-	-
7"	1/8"	7/8"	60	8,600	27512	-	-

Challenger II™ Packaging: Each box of 25 is supplied with a backing pad and one 5/8-11 nut.
Additional pad assembly: 4-1/2" & 5" - Part #95245; 7" - Part #95247 • Additional pads and nuts - Pg 130

TECH INFO

- Type 29 shape allows easy control in grinding and blending applications
- Honeycomb, dimpled pattern on face allows for greater cooling and longer life
- Grind and blend welds in one-step, no need for multiple steps and products
- Available in many grits for all your grinding and blending needs
- Ideal for grinding radius and contours in pipe and vessels

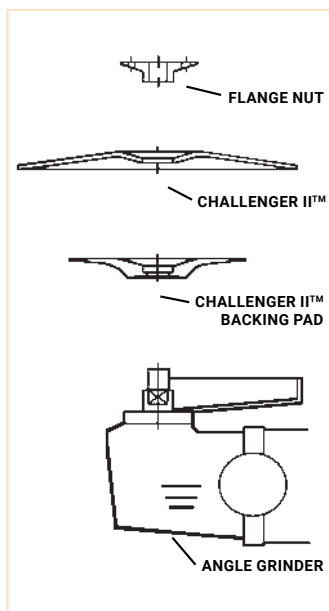

Type 29



Angle Grinder



Contaminant Free
Fe + S + Cl < 0.1%



5/8-11 Hub

Challenger II™
Proper Clamping Procedure



PIPELINE WHEELS

AMERICAN MADE  INDUSTRIAL GRADE

KEY FEATURES

- All of our American-made 1/8" pipeline wheels are reinforced with the highest quality fiberglass for maximum safety and performance, and all are designed for both cutting and light grinding – eliminating the need for two separate wheels
- This section contains four 1/8" thick specifications
- Designed and manufactured to perform both cutting and light grinding
- **Ideal for root pass grinding**
- Pipeline wire brushes also available on page 121

1/8" PIPELINE WHEELS



GENERAL PURPOSE

A24R PIPELINE

- Aluminum oxide grain
- Designed and manufactured to perform both cutting and light grinding

METAL Ferrous metals (steel, cast iron, etc.)



HIGH PERFORMANCE

SAIT Z-TECH™

- Tough zirconium grain
- High performance cutting and light grinding for the toughest applications

METAL Ferrous metals (iron, steel, welds)

STAINLESS Stainless steel, high tensile alloys



PREMIUM PERFORMANCE

SAITECH™ PIPELINE

- High performance, ceramic aluminum oxide grain
- Uniform, high-density grain structure is extremely durable and self-sharpening for long life and a cooler cut
- Manufactured with proprietary ceramic abrasive grain to outlast standard aluminum oxide wheels
- Long life combined with versatility for the pipeline industry

STAINLESS Stainless steel, high tensile alloys

METAL Ferrous metals (iron, steel, welds)



PREMIUM PERFORMANCE

THE ULTIMATE PIPELINE™

- Features our proprietary grain and bond system
- Fast, free-cutting with long-lasting life
- Premium performance cutting and light grinding for even the toughest applications

METAL Ferrous metals (iron, steel, welds)

STAINLESS Stainless steel, high tensile alloys

PIPELINE WIRE BRUSHES AVAILABLE ON PAGE 121

**** NEW ****



PREMIUM PERFORMANCE

THE ULTIMATE PIPELINE™ CERAMIC

- Features our proprietary high-ratio blend of ceramic grains for maximum stock removal
- Extremely fast, free-cutting with exceptional life for the toughest applications
- Easy to control, non-glazing design
- Ideal for root pass grinding

METAL Ferrous metals (iron, steel, welds)

STAINLESS Stainless steel, high tensile alloys

DIA	THICKNESS	ARBOR	MAX RPM	QTY	A24R PIPELINE	SAIT Z-TECH™	SAITECH™ PIPELINE	ULTIMATE PIPELINE™	ULTIMATE PIPELINE™ CERAMIC
4"	1/8"	3/8"	13,500	25	22007	-	-	-	-
4"	1/8"	5/8"	13,500	25	22015	-	-	-	-
4-1/2"	1/8"	7/8"	13,300	25	22030	22620	22264	20020	22444
4-1/2"	1/8"	5/8-11	13,300	10	22130	22630	22269	20120	22544
5"	1/8"	7/8"	12,200	25	22040	22622	22274	20025	22445
5"	1/8"	5/8-11	12,200	10	22140	22632	22279	20125	22545
6"	1/8"	7/8"	10,200	25	22042	22623	-	20030	22446
6"	1/8"	5/8-11	10,200	10	22046	22633	-	20130	22546
7"	1/8"	7/8"	8,500	25	22055	22624	22284	20035	22447
7"	1/8"	5/8-11	8,500	10	22052	22634	22289	20135	22547
9"	1/8"	7/8"	6,600	25	22065	22626	22294	20040	22449
9"	1/8"	5/8-11	6,600	10	22062	22636	22299	20140	22549

TECH INFO

- Designed for both cutting and light grinding, eliminating the need for two separate wheels
- Ideal for root pass grinding
- All sizes reinforced with the highest quality fiberglass for maximum safety and performance
- Our unique Super-Lock™ Hub combines both a mechanical locking system and chemical bond providing one of the safest, vibration-free designs in the industry

Reusable 5/8-11 adapter for use on Type 1 / Type 41 and Type 27 / Type 42 reinforced wheels with a 7/8 arbor, a maximum diameter of 5" and a wheel thickness of .045" to 1/8" available in accessories on Page 130. (Part #95055)



Type 27



5/8-11 Super-Lock™ Hub



Angle Grinder

CUP STONES



A16 – GENERAL PURPOSE CUP STONES

- Aluminum oxide grain
- Coarse grit wheel for tough grinding applications
- Excellent for cleaning castings, mold marks and removing flashing

METAL Ferrous metals

Z16 – ZIRCONIUM CUP STONES

- Special zirconium grain formulation
- Coarse grit and hard bond for the toughest grinding applications
- Outlasts standard aluminum oxide cup wheels 2:1

METAL Ferrous metals

STAINLESS Stainless steel

C16 – CONCRETE CUP STONES

- Silicon carbide grain
- Coarse grit for tough grinding applications
- Excellent for cleaning castings, mold marks and removing flashing

CONCRETE Masonry, concrete, stone

CA16 – COMBINATION CUP STONES

- Combination aluminum oxide and silicon carbide grains
- Excellent for cleaning castings, mold marks and removing flashing

METAL Ferrous metals

CONCRETE Masonry, concrete, stone

DIA	BACK DIA	THICKNESS	ARBOR	BACKING	MAX RPM	QTY	A16	Z16	C16	CA16
4"	3"	2"	5/8-11	PLAIN	9,050	12	26000	–	26001	26002
4"	3"	2"	5/8-11	METAL	9,050	12	26003	–	26004	26005
5"	4"	2"	5/8-11	PLAIN	7,250	6	26010	26050	26011	26012
5"	4"	2"	5/8-11	METAL	7,250	6	26013	26053	26014	26015
6"	4-3/4"	2"	5/8-11	PLAIN	6,050	5	26020	26060	26021	26022
6"	4-3/4"	2"	5/8-11	METAL	6,050	5	26023	26063	26024	26025

TECH INFO

- Type 11 shape provides maximum surface area coverage for grinding and cleaning applications
- Metal back option provides greater stability in tough grinding applications

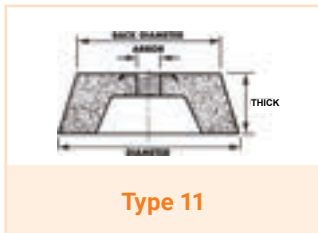

AVAILABLE WITH AN OPTIONAL METAL BACKING





DIAMOND CUP WHEELS ****NEW****

- For use on a wide range of masonry building materials (brick, blocks, pavers, etc.) and concrete tiles (roofing, etc.)
- High concentration of diamonds and large grinding segments for exceptional life and stock removal
- High strength design with ventilation holes to aid dust extraction and maximize product life

CONCRETE Masonry, concrete, stone



AVAILABLE IN 3 SPECS



SINGLE ROW

- Extremely fast stock removal



DOUBLE ROW

- Fast stock removal and long life while delivering a smooth finish



SINGLE ROW TURBO

- Aggressive cut for maximum stock removal and smooth finish

DIA	ARBOR	MAX RPM	QTY	SINGLE ROW	DOUBLE ROW	SINGLE TURBO
4"	5/8-11	15,300	1	49012	49022	49002
4-1/2"	5/8-11	15,300	1	-	49023	-
7"	5/8-11	8,750	1	49016	49026	49006



MOUNTED POINTS



A36Q - RESIN BONDED

- Aluminum oxide grain
- For deburring and finishing
- Fast stock removal
- Shank length 1-1/2"

METAL Ferrous metals (iron, steel, welds, etc.)



A60R - VITRIFIED

- Aluminum oxide grain
- Ideal for ID grinding and mold finishing
- Shank length 1-1/2"

METAL Ferrous metals

SILHOUETTES DO NOT REPRESENT ACTUAL DIMENSIONS

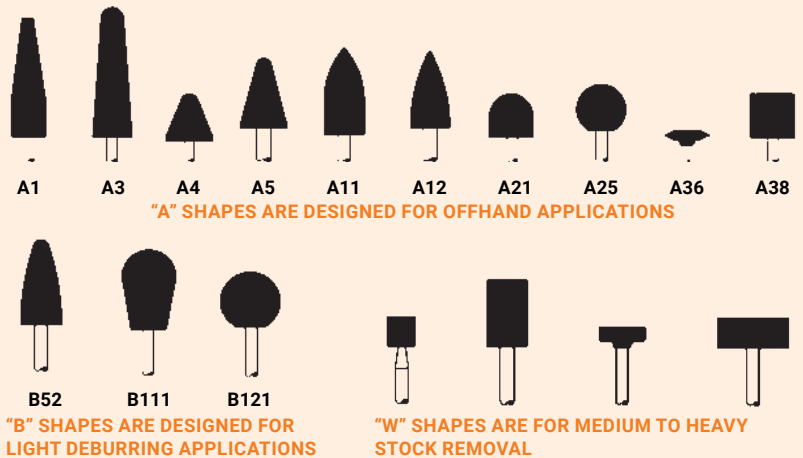

TYPE	DIA	LENGTH	SHANK DIA	MAX RPM	QTY	A36Q	A60R
A1	3/4"	2-1/2"	1/4"	19,800	10	27401	27010
A3	1"	2-3/4"	1/4"	16,100	10	27402	27020
A4	1-1/4"	1-1/4"	1/4"	30,560	10	27403	27030
A5	3/4"	1-1/8"	1/4"	45,000	10	27404	27035
A11	7/8"	2"	1/4"	19,860	10	27405	27040
A12	11/16"	1-1/4"	1/4"	48,000	10	-	27050
A21	1"	1"	1/4"	34,500	10	-	27060
A25	1"	ROUND	1/4"	35,620	10	-	27070
A36	1-5/8"	3/8"	1/4"	23,520	10	-	27086
A38	1"	1"	1/4"	34,500	10	27406	27088
B52	3/8"	3/4"	1/4"	45,370	10	27407	-
B52	3/8"	3/4"	1/8"	45,370	20	-	27110
B111	7/16"	11/16"	1/8"	33,750	20	-	27120
B121	1/2"	1/2"	1/8"	45,370	20	-	27130
W160	1/4"	1/4"	1/8"	81,370	10	-	27308
W177	3/8"	3/4"	1/8"	33,750	20	-	27310
W179	3/8"	1-1/4"	1/4"	45,750	10	27408	-
W189	1/2"	2"	1/4"	24,000	10	27409	27327
W196	5/8"	1"	1/4"	35,250	10	-	27329
W204	3/4"	3/4"	1/4"	42,750	10	27410	27320
W208	3/4"	2"	1/4"	18,750	10	27411	27330
W215	1"	1/8"	1/8"	38,200	10	-	27338
W220	1"	1"	1/4"	25,500	10	27412	27360
W222	1"	2"	1/4"	15,900	10	27413	27340
W225	1-1/4"	1/4"	1/4"	30,560	10	-	27350
W236	1-1/2"	1/2"	1/4"	25,470	10	27414	27349

TECH INFO

- These mounted bonded points are a low-cost alternative to carbide burs
- Each point is dressed for perfect balance to perform without vibration or run-out

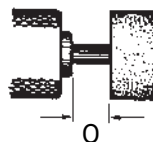

"O" = 1/2"

Mandrel overhang "O" must always be the lowest possible. Maximum speeds given refer to overhang "O" equal to 1/2"



Die Grinder

CONES & PLUGS

- Aluminum oxide grain
- For grinding and snagging in hard to reach areas
- Fast stock removal

METAL Ferrous metals (iron, steel, welds, etc.)



DIA	LENGTH	ARBOR	GRADE	MAX RPM	QTY	TYPE 16	TYPE 17	TYPE 18	TYPE 18R
1"	3"	3/8-24	A20	36,287	10	24999	-	25200	25300
1-1/4"	3"	3/8-24	A16	29,030	10	25000	-	-	-
1-1/2"	2-1/2"	3/8-24	A20	24,192	10	-	25101	25201	25301
1-1/2"	2-1/2"	5/8-11	A20	24,192	10	-	25102	25202	25302
1-1/2"	3"	3/8-24	A16	24,192	10	-	25103	25203	25303
1-1/2"	3"	5/8-11	A16	24,192	10	-	25104	25204	25304
2"	3"	5/8-11	A16	18,144	10	25006	25106	25206	25306
2-3/4"	3-1/2"	5/8-11	A16	13,195	10	25008	-	-	-
3"	3"	5/8-11	A20	12,096	10	25009	-	-	-

TECH INFO

- Available in the most common application shapes
- Large grit size for heavy-duty grinding and snagging



Die Grinder

BENCH WHEELS



ALUMINUM OXIDE

- Aluminum oxide grain
- General purpose
- For sharpening tools and light stock removal

METAL Ferrous metals (carbon steel, steel, iron, forgings, etc.)

DIA	THICKNESS	ARBOR	MAX RPM	GRADES				
				A24	A36	A46	A60	A80
6"	1/2"	1"	4,140	-	28003	-	28004	28005
6"	3/4"	1"	4,140	-	28000	-	28001	28002
6"	1"	1"	4,140	-	28006	-	28007	28008
7"	3/4"	1"	3,600	-	28010	-	28011	28012
7"	1"	1"	3,600	-	28013	-	28014	28015
8"	3/4"	1"	3,600	-	28020	-	28021	28022
8"	1"	1"	3,600	-	28023	-	28024	28025
10"	1"	1-1/4"	2,485	-	28040	28043	28041	28042
10"	1-1/2"	1-1/4"	2,485	-	28050	28053	28051	28052
12"	2"	1-1/2"	2,070	28060	28063	28061	28062	-



GREEN SILICON CARBIDE

- Green silicon carbide grain
- Extremely sharp grain for faster, burr-free cutting
- Use on carbide tipped tools, cast iron

METAL Ferrous and/or non-ferrous metals, carbide, cast iron

DIA	THICKNESS	ARBOR	MAX RPM	GRADES		
				GC60	GC80	GC120
6"	3/4"	1"	4,140	28100	28101	28102
6"	1"	1"	4,140	28103	28104	28105
7"	1"	1"	3,600	28113	28114	28115
8"	1"	1"	3,600	28123	28124	28125
10"	1"	1-1/4"	2,485	28140	28141	28142
12"	2"	1-1/2"	2,070	28160	28161	28162



Bench Grinder

WHEEL SIZE	BUSHINGS
6"	3/4, 5/8, 1/2
7"	3/4, 5/8, 1/2
8"	3/4, 5/8
10"	1, 3/4
12"	1-1/4, 1

Reduction bushings enclosed with each wheel

TECH INFO

- Vitrified bond for long life
- Individually packaged for safety and convenience
- Available in two formulations for a wide range of applications

The vitrified bonding technique uses a high temperature process whereby abrasive materials are heated to a point where the grains fuse to each other, forming the bond posts. Vitrified products, although somewhat brittle, are not affected by water, oil, most acids, or temperature changes. Used primarily for precision and fixed-feed applications, they are particularly well suited for bench grinders and offhand tool room applications.



HAND & FLOOR RUBS

- Removes form marks

- PLAIN** For cleaning castings and dressing bench grinding wheels
- FLUTED** For extra shearing action
- HANDLE** For extra comfort and working overhead
- SCORED** Breaks into two 4 x 2 x 2 floor rubs
- CONCRETE** Masonry, concrete, stone

TYPE	DESCRIPTION	LENGTH	THICKNESS	HEIGHT	GRADE	QTY	HAND & FLOOR RUBS
HR202	PLAIN	4"	2"	2"	C24R	6	25010
HR241	FLUTED	6"	2"	2"	C24R	5	25020
HR242	FLUTED	8"	2"	2"	C24R	5	25030
FR521	SCORED	8"	2"	2"	C10R	3	25060
FR521	SCORED	8"	2"	2"	C24R	3	25061
FR521	SCORED	8"	2"	2"	C80R	3	25062
HR252	HANDLE	6"	3"	1"	C24R	5	25040
HR250	HANDLE	8"	3-1/2"	1-1/2"	C24R	5	25050



TECH INFO

- Vitrified bond for long life
- Available in several configurations for a wide range of cleaning and dressing applications
- Each box of plain and scored rubs contains 6 wood wedges



WOOD WEDGES

- For use with Vitrified Bonded Floor Rubs
- Skin packaged in quantities of 2 per package

PART #
95100

COTTON FIBER



COTTON FIBER WHEELS

- Multiple layers of cotton impregnated with abrasive grain and special bonding agents allow for the coolest blending and finishing wheels
- Special cotton formula minimizes loading on soft, non-ferrous metals like aluminum

STAINLESS Stainless steel

ALUMINUM Non-ferrous metals

METAL Ferrous metals

GRADE	DESCRIPTION	ROUGHNESS AVERAGE VALUES	
		304 SS	6061 ALUM
A24UA-MTX	RESIN BOND FOR LIGHT TO MEDIUM WELD REMOVAL	140 RA	N/A
A36UA-GFX	LATEX BOND FOR WELD BLENDING	40 RA	130 RA
A54UA-GFX	LATEX BOND FOR WELD BLENDING AND FINISHING	30 RA	80 RA

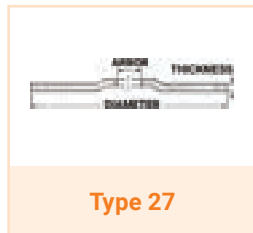

Type 27



Angle Grinder

DIA	THICKNESS	ARBOR	MAX RPM	QTY	GRADES		
					A24	A36	A54
4"	1/4"	5/8"	13,500	10	-	29201	29202
4-1/2"	1/4"	7/8"	13,500	10	29206	29207	29208
7"	1/4"	7/8"	8,500	10	29212	29213	29214

COTTON FIBER MOUNTED POINTS

- **A54MTX**: Resin Bond for light removal/blending
- **A80GFX**: Latex Bond with finer grit for ultimate finishing
- Multiple layers of cotton impregnated with abrasive grain and special bonding agents allow for the coolest blending and finishing
- Special cotton formula minimizes loading on soft, non-ferrous metals like aluminum

STAINLESS Blending on stainless steel, high tensile alloys

ALUMINUM Non-ferrous metals

METAL Ferrous metals



TYPE	DIA	LENGTH	SHANK DIA	"O" = 1/2" Max RPM	GRADES	
					A54	A80
A5	3/4"	1-1/8"	1/4"	38,550	50560	50360
B42	1/2"	3/4"	1/4"	61,120	50561	50361
B52	3/8"	3/4"	1/4"	78,340	50562	50362
B121	1/2"	1/2"	1/4"	69,310	-	50363
B122	3/8"	3/8"	1/4"	69,310	-	50364
W163	1/4"	1/2"	1/4"	33,750	-	50365
W189	1/2"	2"	1/4"	26,830	50566	50366
W220	1"	1"	1/4"	25,500	-	50367
W222	1"	2"	1/4"	15,900	-	50368



Die Grinder

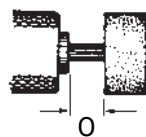

"O" = 1/2"

Mandrel overhang "O" must always be the lowest possible. Maximum speeds given refer to overhang "O" equal to 1/2"

Packaging - 10 per box



COTTON FIBER FINISHING DISCS

- Aluminum oxide grain
- Cotton fiber abrasive material will not smear on titanium and stainless steel
- SAIT-LOK-R™ discs are made of multiple layers of cotton fiber abrasive impregnated material. These quick change discs produce a smooth finish in one step. Nylon screw threaded hub for easy mounting to the backing pad.

STAINLESS Blending on stainless steel, high tensile alloys

ALUMINUM Non-ferrous metals

METAL Ferrous metals



See SAIT-LOK-R™ Backing Pads on page 132 for Cotton Fiber Discs

GRADE	DESCRIPTION	ROUGHNESS AVERAGE VALUES	
		304 SS	6061 ALUM
A24M	COARSE GRIT WITH MEDIUM FLEXIBILITY FOR AGGRESSIVE ACTION	70 RA	90 RA
A36F	MEDIUM GRIT WITH HIGHER FLEXIBILITY FOR SMOOTHER ACTION	40 RA	60 RA
A54F	FINE GRIT WITH HIGHER FLEXIBILITY FOR FINISHING	30 RA	50 RA
A80F	FINER GRIT FOR ULTIMATE FINISHING	20 RA	45 RA

DIA	MAX RPM	QTY	GRADES			
			A24M	A36F	A54F	A80F
2"	30,000	25	50300	50301	50302	50303
3"	20,000	25	50308	50309	50310	50311

COTTON FIBER DEBURRING WHEELS

- Fine grit with higher flexibility for finishing
- Cotton fiber abrasive material will not smear on titanium and stainless steel
- Ideal for light deburring without loading or discoloration
- **A54MTX**: Resin Bond for light removal/blending
- **A54GFX**: Latex Bond with finer grit for ultimate finishing

STAINLESS Deburring of stainless steel, high tensile alloys

ALUMINUM Non-ferrous metals

METAL Ferrous metals



DIA	THICKNESS	BORE	GRADE	MAX RPM	QTY	PART #
3"	1/16"	3/8"	A54MTX	18,080	10	29310
3"	1/8"	3/8"	A54GFX	12,095	10	29312
4"	1/8"	3/8"	A54GFX	9,075	10	29322

CUTTING WHEELS INDEX

HOW TO PICK A CUTTING WHEEL 28

.045 CUTTING WHEELS 30

A60S 30
 Z-TECH 30
 SAIT.M.X.™ 30
 A46N - ALUMINUM 30
 SAITECH™ 32
 THE ULTIMATE CUT™ 32
 THE ULTIMATE CERAMIC™ 32
 XA46R 32

.090 CUTTING & NOTCHING WHEELS..... 34

A60S 34
 Z-TECH™ 34
 SAITECH ULTIMATE PERFORMANCE™ 34

.095 ULTIMATE COMBO WHEELS 36

A60S ULTIMATE COMBO™ 36
 Z-TECH™ ULTIMATE COMBO 36

3/32" & 1/8" CUTTING WHEELS37

A24R 37
 Z-TECH™ 37
 SAITECH ULTIMATE PERFORMANCE™ 37
 C24R 38
 XA24Q 38

TOOL ROOM 39

A36T 39
 A60T 39

THIN HIGH SPEED CUT-OFF 40

A24R 40
 A36T 40
 A60T 40
 SAITECH ULTIMATE PERFORMANCE™ 40

SMALL DIAMETER PORTABLE SAW CUT-OFF WHEELS..... 42

A24R 42
 A30S 42
 C24R 42

LARGE DIAMETER CUTTING WHEELS 43

CHOP SAW WHEELS 44

EZ-CHOP ATTACKER® 44
 EZ-CHOP® 44
 IRON WORKER™ 44
 Z-TECH™ 45
 SAITECH STEEL WORKER® 45
 STUD KING® 45
 A46N - ALUMINUM 45

PORTABLE SAW WHEELS 46

A24R 46
 XFC™ 46
 SAIT PRO 46
 BRUTE™ 46
 HOB0® 46
 DUCTILE™ 47
 C24R 47
 BIG M.A.C.™ 47

9" PORTABLE SAW WHEELS 48

A60S 48
 THE ULTIMATE CERAMIC CUT-OFF™ 48

STREET SAW WHEELS 49

C16 49

STATIONARY SAW WHEELS 49

A24N 49
 A24R 49
 A36R 49
 C24R 49

METAL-CUTTING CARBIDE BLADES 50

STEEL WORKER® CARBIDE BLADE 52
 TMX - THIN METAL EXTRA CARBIDE BLADE 52
 STAINLESS CARBIDE BLADE 53
 ALUMINUM CARBIDE BLADE 53

DIAMOND BLADES 54

CONTINUOUS RIM 54
 SEGMENTED RIM 54
 SERRATED RIM 54
 LARGE DIAMETER DIAMOND BLADES 55



CUTTING WHEELS



HOW TO PICK A CUTTING WHEEL

CUTTING WHEELS

.045 PRODUCT SELECTION GUIDE

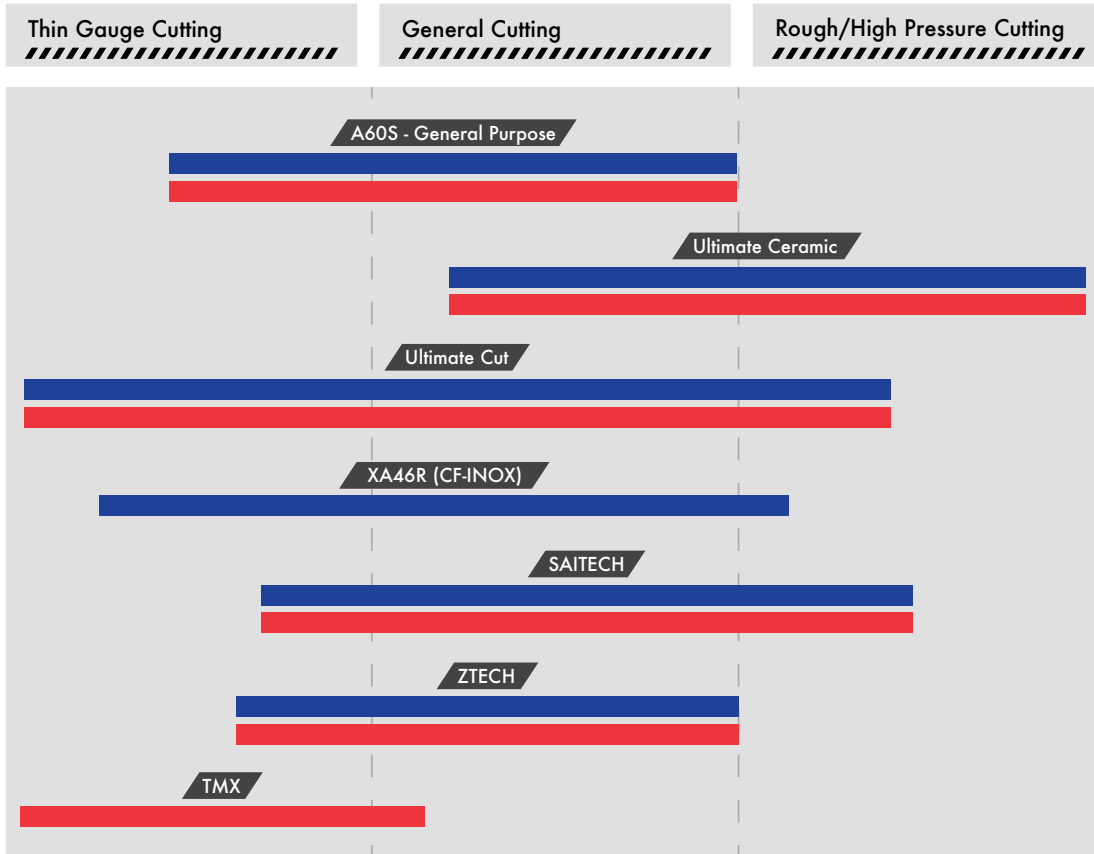

.090/.095 PRODUCTION SELECTION GUIDE

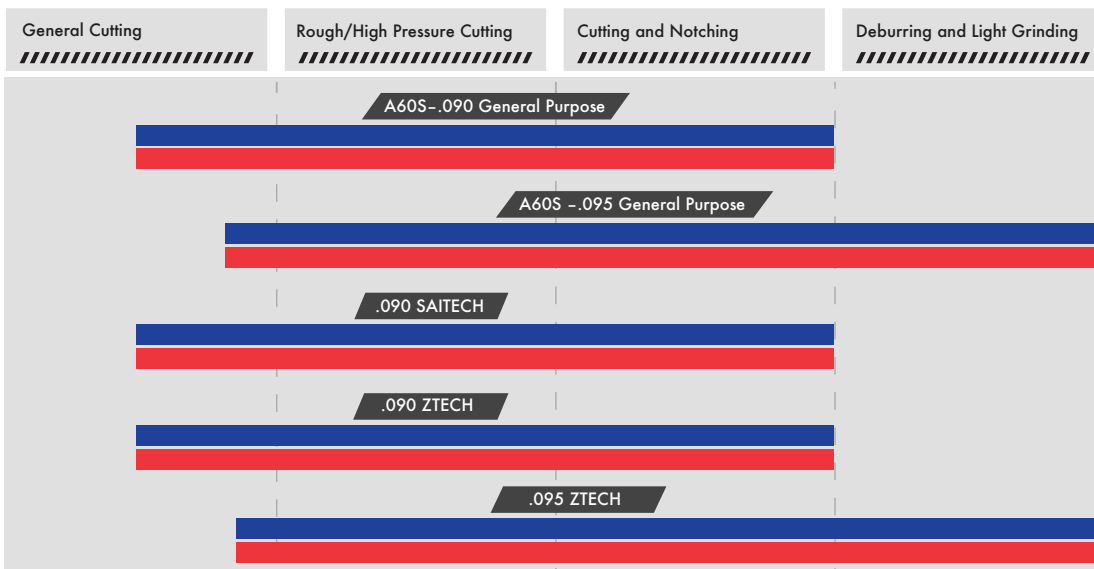

Carbon Steel/Ferrous Metals



Stainless Steel



Thin cutting wheels have made the job of the welder, fabricator and maintenance technician easier by providing them with a quick and simple way to cut a piece of metal without the need for other bulky equipment (torches, large saws, etc.). Yet the most common mistake we see is that users often choose the incorrect wheel for the job.

United Abrasives .045 Wheels

United Abrasives .045 wheels are the best choice for efficient cutting. They should never be used for deburring metal after cutting or grinding. This type of misuse could result in wheel failure resulting in severe injury.

United Abrasives .090 Wheels

United Abrasives .090 wheels are designed for cutting and notching metal. Notching is a shearing process during which a metal scrap piece is removed from the outside edge of a metal workpiece prior to welding.

Ultimate Combo™ Wheel

Our most versatile cutting wheel is the **Ultimate Combo™** wheel which has a **.095 thickness**. This product allows operators to **cut, notch, debur and light grind** without the need to change the wheel.

TYPES OF CUTTING WHEELS

There are two basic configurations of cutting wheels:

- **Type 1 / Type 41:** This is a flat cutting wheel that allows for a maximum depth of cut.
- **Type 27 / Type 42:** Originally developed and patented by United Abrasives, this design features more of a rigid feel while cutting, enhanced operator visibility of the cut, and the ability to flush cut as the raised hub allows for the locking nut to be recessed. These wheels are also available with our 5/8-11 quick change hub for ease of mounting.

GRAINS

- **Ceramic** - Ceramic cutting wheels allow for a very long life and fast cutting speeds. Ceramics also tend to cut cooler, minimizing discoloration while maximizing product life.
- **Zirconium** - Zirconium grain has an extremely durable design. These wheels are used for high performance cutting with long life and feature a low cost-per-cut ratio.
- **Aluminum Oxide** - Aluminum Oxide is the most common abrasive grain and delivers very good cut rates and durability. It tends to have a lower initial cost for the user which lends to its popularity.

.045" CUTTING WHEELS

CUTTING WHEELS



GENERAL PURPOSE

A60S

- Special aluminum oxide grain
- Extremely fast burr-free cutting with long life
- Exceptional performance

METAL Ferrous and/or non-ferrous metals (iron, steel, welds, etc)



HIGH PERFORMANCE

Z-TECH™

- Special zirconium grain formula
- Hard bond for extremely long life
- Fast, burr-free cutting

METAL Ferrous and/or non-ferrous metals (iron, steel, welds, etc)

STAINLESS Stainless steel, high tensile alloys



THIN METAL

SAIT.M.X.™

- Special bond for cutting sheet metal and other thin gauge metals
- Fast, burr-free cutting
- Only available in Type 1 / Type 41

METAL Ferrous metals (carbon steel, etc)

STAINLESS Stainless steel



NON-FERROUS METALS

A46N - ALUMINUM

- Aluminum oxide grain
- Soft bond for aggressive cutting without loading

ALUMINUM Non-ferrous metals (aluminum, copper, brass, etc)



TYPE 1 / TYPE 41

DIA	THICKNESS	ARBOR	MAX RPM	QTY	A60S	Z-TECH™	SAIT.M.X.™	A46N
4"	.045"	5/8"	19,000	50	23099	23323	-	-
4-1/2"	.045"	7/8"	13,300	50	23101	23324	23604	23314
5"	.045"	7/8"	12,200	50	23103	23325	23605	-
6"	.045"	5/8"	10,200	50	23105	-	-	-
6"	.045"	7/8"	10,200	50	23106	23327	23606	23316
7"	.045"	5/8"	8,500	50	23107	23328	-	-

TECH INFO

- Type 1 / Type 41 shape for square, burr-free cutting
- Externally reinforced with fiberglass layers to provide ultimate safety in a thin wheel
- Unique formulations offer the fastest cutting, longest lasting thin wheels
- Wide range of sizes available to fit both angle grinders and circular saws

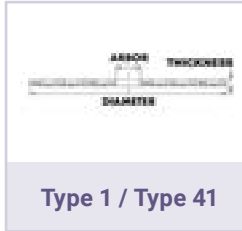

TYPE 27 / TYPE 42

DIA	THICKNESS	ARBOR	MAX RPM	QTY	A60S	Z-TECH™	A46N
4"	.045"	5/8"	19,000	50	22011	-	-
4-1/2"	.045"	7/8"	13,300	50	22021	23334	22345
4-1/2"	.045"	5/8-11	13,300	10	23318	23322	23320
5"	.045"	7/8"	12,200	50	22071	23335	22350
5"	.045"	5/8-11	12,200	10	23305	23309	23307
6"	.045"	7/8"	10,200	50	22047	23336	22360
7"	.045"	7/8"	8,500	50	22053	23337	22370

TECH INFO

- Unique, thin Type 27 / Type 42 shape can be used on all angle grinders in accordance with ANSI B7.1
- Unique formulations offer the fastest cutting, longest lasting thin wheels
- Externally reinforced with fiberglass layers to provide ultimate safety in a thin wheel
- Proprietary bonding system allows for faster, burr free cuts

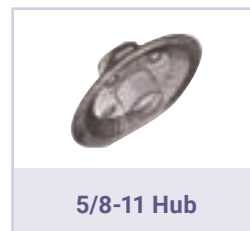
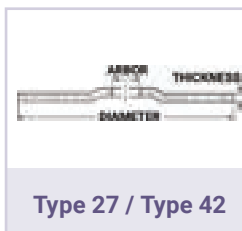

Reusable 5/8-11 adapter for use on Type 1 / Type 41 and Type 27 / Type 42 reinforced wheels with a 7/8 arbor, a maximum diameter of 5" and a wheel thickness of .045" to 1/8" available in accessories. Part #95055 Page 130

.045" CUTTING WHEELS

CUTTING WHEELS



HIGH PERFORMANCE

SAITECH™

- High performance, ceramic aluminum oxide grain
- Uniform, high density grain structure is extremely durable and self sharpening
- Fast cutting with extremely long life

STAINLESS Stainless steel, high tensile alloys

METAL Ferrous and/or non-ferrous metals



PREMIUM PERFORMANCE

THE ULTIMATE CUT™

- Best in class for cutting a wide range of stainless thin & thick gauge, flat stock, bar stock, square tubing, etc.
- Exceptional cutting performance on metal and aluminum

STAINLESS Stainless steel, high tensile alloys

METAL Ferrous metals (iron, steel, welds, etc)

ALUMINUM Non-ferrous metals (aluminum, copper, brass, etc)



PREMIUM PERFORMANCE

THE ULTIMATE CERAMIC™

- Premium ceramic aluminum oxide grain
- Exceptionally long lasting on carbon steel, stainless steel, and hard to grind alloys
- Maximizes productivity on metal and stainless

METAL Ferrous and/or non-ferrous metals (iron, steel, welds, etc)

STAINLESS Stainless steel, high tensile alloys



contaminant **cf** free

CONTAMINANT FREE

XA46R

- Specially formulated for nuclear and food processing plants
- Specially formulated for contaminant-free cutting on stainless steel
- Free of iron, chlorine and sulphur compounds (Fe + Cl + S < 0.1%)
- All wheels are 1/16" thick
- Only available in Type 1 / Type 41

STAINLESS Stainless steel & other high tensile alloys

TYPE 1 / TYPE 41

DIA	THICKNESS	ARBOR	MAX RPM	QTY	SAITECH™	ULTIMATE CUT™	ULTIMATE CERAMIC™ CUT-OFF	XA46R
4"	.045"	5/8"	19,000	50	23172	-	-	-
4-1/2"	.045"	7/8"	13,300	50	23174	22230	22480	-
4-1/2"	1/16"	7/8"	13,300	50	-	-	-	24251
5"	.045"	7/8"	12,200	50	23177	22235	22481	-
5"	1/16"	7/8"	12,200	50	-	-	-	24252
6"	.045"	5/8"	10,200	50	23181	-	-	-
6"	.045"	7/8"	10,200	50	23182	22240	22482	-
6"	1/16"	7/8"	10,200	50	-	-	-	24253
7"	.045"	5/8"	8,500	50	23184	-	-	-
7"	1/16"	7/8"	8,500	50	-	-	-	24254

TECH INFO

- Type 1 / Type 41 shape for square, burr-free cutting
- Externally reinforced with fiberglass layers to provide ultimate safety in a thin wheel
- Wide range of sizes available to fit both angle grinders and circular saws



Type 1 / Type 41



Angle Grinder



Circular Saw

TYPE 27 / TYPE 42

DIA	THICKNESS	ARBOR	MAX RPM	QTY	SAITECH™	ULTIMATE CUT™	ULTIMATE CERAMIC™ CUT-OFF
4"	.045"	5/8"	19,000	50	22068	-	-
4-1/2"	.045"	7/8"	13,300	50	22072	22380	22470
4-1/2"	.045"	5/8-11	13,300	10	23319	23321	22570
5"	.045"	7/8"	12,200	50	22073	22385	22471
5"	.045"	5/8-11	12,200	10	23306	23308	22571
6"	.045"	7/8"	10,200	50	22082	22390	22472
7"	.045"	7/8"	8,500	50	22088	-	-

TECH INFO

- Thin cutting wheel in a Type 27 / Type 42 shape makes this perfect for your angle grinder
- Designed to provide very long life for fewer wheel changes and less downtime
- All sizes reinforced with the highest quality fiberglass for maximum safety and performance



Type 27 / Type 42



5/8-11 Hub



Angle Grinder

Reusable 5/8-11 adapter for use on Type 1 / Type 41 and Type 27 / Type 42 reinforced wheels with a 7/8 arbor, a maximum diameter of 5" and a wheel thickness of .045" to 1/8" available in accessories. Part #95055 Page 130

.090" CUTTING & NOTCHING WHEELS



GENERAL PURPOSE

A60S

- Thin .090 width
- Special aluminum oxide grain
- Hard bond for extremely long life
- Excellent for notching and cutting

METAL Ferrous and/or non-ferrous metals (iron, steel, welds, etc.)



HIGH PERFORMANCE

Z-TECH™

- Tough zirconium grain
- High performance cutting and notching for the toughest applications

METAL Ferrous metals (iron, steel, welds, etc.)

STAINLESS Stainless steel, high tensile alloys



PREMIUM PERFORMANCE

SAITECH ULTIMATE PERFORMANCE™

- Premium performance, ceramic aluminum oxide grain
- Very uniform, high density grain structure is extremely durable and self sharpening for long life and cooler cut
- Combines fast stock removal with long life for tough cutting applications
- Ideal for foundry applications (gates, risers)
- Only available in Type 27 / Type 42

STAINLESS Stainless steel, high tensile alloys

METAL Ferrous metals (iron, steel, welds, etc.)

TYPE 1 / TYPE 41

DIA	THICKNESS	ARBOR	MAX RPM	QTY	A60S	Z-TECH™
4-1/2"	.090"	7/8"	13,300	25	23804	23824
5"	.090"	7/8"	12,200	25	-	23825
6"	.090"	7/8"	10,200	25	23806	23826
7"	.090"	5/8"	8,500	25	23807	23827

TECH INFO

- Type 1 / Type 41 shape for square, burr-free cutting and notching
- Externally reinforced with the highest quality fiberglass to withstand the toughest applications
- Available in multiple arbor sizes to fit a wide variety of tools

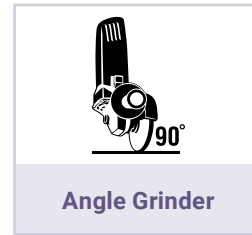
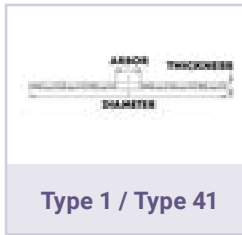

TYPE 27 / TYPE 42

DIA	THICKNESS	ARBOR	MAX RPM	QTY	A60S	Z-TECH™	SAITECH ULTIMATE PERFORMANCE™
4-1/2"	.090"	7/8"	13,300	25	20903	20943	20923
4-1/2"	.090"	5/8-11	13,300	10	20913	20953	20933
5"	.090"	7/8"	12,200	25	20904	20944	-
5"	.090"	5/8-11	12,200	10	20914	20954	-
6"	.090"	7/8"	10,200	25	20905	20945	-
6"	.090"	5/8-11	10,200	10	20915	20955	-
7"	.090"	7/8"	8,500	25	20906	20946	-
7"	.090"	5/8-11	8,500	10	20916	20956	-
9"	.090"	7/8"	6,600	25	20909	-	-
9"	.090"	5/8-11	6,600	10	20919	-	-

TECH INFO

- Unique, thin Type 27 / Type 42 shape can be used on all angle grinders in accordance with ANSI B7.1
- Special bond formulation offers the fastest cutting, longest lasting thin wheels
- Externally reinforced with fiberglass layers to provide ultimate safety in a thin wheel

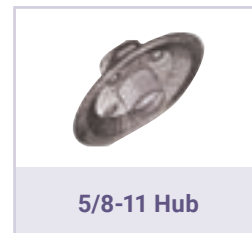
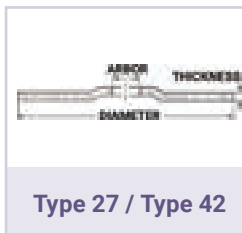

Reusable 5/8-11 adapter for use on Type 1 / Type 41 and Type 27 / Type 42 reinforced wheels with a 7/8 arbor, a maximum diameter of 5" and a wheel thickness of .045" to 1/8" available in accessories. Part #95055 Page 130

.095" ULTIMATE COMBO WHEELS

CUTTING WHEELS

4 APPLICATIONS WITH 1 WHEEL



GENERAL PURPOSE

A60S

- Aluminum oxide grain
- Provides consistent performance with long life for cutting, notching, deburring, and light grinding

METAL Ferrous metals (steel, angle iron, rebar)



HIGH PERFORMANCE

Z-TECH™

- Tough zirconium grain
- High performance cutting, notching, deburring, and light grinding for the toughest applications

METAL Ferrous metals (iron, steel, welds, etc.)

STAINLESS Stainless steel, high tensile alloys

DIA	THICKNESS	ARBOR	MAX RPM	QTY	A60S ULTIMATE COMBO™	Z-TECH ULTIMATE COMBO™
4-1/2"	.095"	7/8"	13,300	25	22320	22330
4-1/2"	.095"	5/8-11	13,300	10	22420	22430
5"	.095"	7/8"	12,200	25	22325	22335
6"	.095"	7/8"	10,200	25	22326	22336
6"	.095"	5/8-11	10,200	10	22426	22436

TECH INFO

- Increases productivity: 1 wheel to cut, notch, debur, and light grind
- Two formulas for a wide variety of applications and maintenance work
- Additional reinforcement for added strength and versatility
- Ideal product for use on cordless right angle grinders



Type 27 / Type 42



5/8-11 Hub

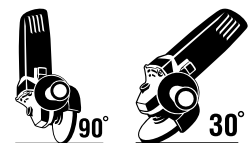

Angle Grinder



GENERAL PURPOSE A24R

- Aluminum oxide grain
- For general purpose cutting
- Combines fast cutting with long life

METAL Ferrous metals (iron, steel, welds, etc.)



HIGH PERFORMANCE Z-TECH™

- Tough zirconium grain
- High performance cutting for the toughest applications

METAL Ferrous metals (iron, steel, welds, etc.)
STAINLESS Stainless steel, high tensile alloys



PREMIUM PERFORMANCE SAITECH ULTIMATE PERFORMANCE™

- High performance, ceramic aluminum oxide grain
- Very uniform, high density grain structure is extremely durable and self sharpening for long life and cooler cut
- Combines fast stock removal with long life for tough cutting applications
- Ideal for foundry applications (gates, risers)

STAINLESS Stainless steel, high tensile alloys
METAL Ferrous metals (iron, steel, welds, etc.)

DIA	THICKNESS	ARBOR	MAX RPM	QTY	A24R	Z-TECH™	SAITECH ULTIMATE PERFORMANCE™
3"	1/8"	3/8"	18,000	25	22000	-	-
4"	1/8"	3/8"	13,500	25	22010	-	-
4-1/2"	3/32"	7/8"	13,300	25	22020	22641	22064
4-1/2"	3/32"	5/8-11	13,300	10	22120	22651	22069
5"	3/32"	7/8"	12,200	25	22070	-	22074
5"	3/32"	5/8-11	12,200	10	22170	-	22079
6"	1/8"	7/8"	10,200	25	22045	-	-
6"	3/32"	7/8"	10,200	25	-	22644	-
6"	3/32"	5/8-11	10,200	10	-	22654	-
7"	3/32"	7/8"	8,500	25	22056	-	22084
7"	3/32"	5/8-11	8,500	10	22057	-	22089
9"	3/32"	7/8"	6,600	25	22066	-	22094
9"	3/32"	5/8-11	6,600	10	22067	-	22099

TECH INFO

- Aggressive cutting performance over a wide range of applications
- Our unique Super-Lock™ Hub combines both a mechanical locking system and chemical bond providing one of the safest, vibration-free designs in the industry
- Designed to provide very long life for fewer wheel changes and less downtime

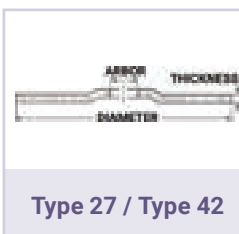

3/32" & 1/8" CUTTING WHEELS

CUTTING WHEELS



CONCRETE C24R

- Silicon carbide grain
- General purpose cutting, hard bond for long life
- Special silicon carbide grain formula is excellent for cutting masonry, concrete, stone, and aggregate

CONCRETE Masonry, concrete, stone

METAL Cast iron and other ferrous metals

DIA	THICKNESS	ARBOR	MAX RPM	QTY	C24R
4-1/2"	3/32"	7/8"	13,300	25	22025
4-1/2"	3/32"	5/8"-11"	13,300	10	22125

TECH INFO

- Aggressive cutting performance over a wide range of applications
- All sizes reinforced with the highest quality fiberglass for maximum safety and performance
- Our unique Super-Lock™ Hub combines both a mechanical locking system and chemical bond providing one of the safest, vibration-free designs in the industry



Type 27 / Type 42

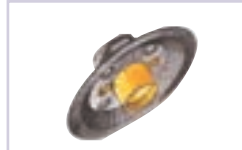

5/8-11
Super-Lock™ Hub



Angle Grinder



contaminant **cf** free

CONTAMINANT-FREE XA24Q

- Specially formulated for nuclear and food processing plants
- Free of iron, chlorine and sulphur compounds (Fe + Cl + S < 0.1%)
- Contaminant-free cutting on stainless steel

STAINLESS Stainless steel and other high tensile alloys

METAL Ferrous metals (iron, steel, welds, etc.)

DIA	THICKNESS	ARBOR	MAX RPM	QTY	XA24Q
4-1/2"	1/8"	7/8"	13,300	25	24310
5"	1/8"	7/8"	12,200	25	24315
6"	1/8"	7/8"	10,200	25	24320
7"	1/8"	7/8"	8,500	25	24325
9"	1/8"	7/8"	6,600	25	24330

TECH INFO

- Aggressive cutting performance over a wide range of applications
- All sizes reinforced with the highest quality fiberglass for maximum safety and performance



Type 27



Angle Grinder



A36T

- Aluminum oxide grain
- Hard bond for aggressive cutting on rough applications

METAL Ferrous metals (iron, steel, welds, etc.)

STAINLESS Stainless steel

DIA	THICKNESS	ARBOR	MAX RPM	QTY	A36T
6"	1/16"	1/2"	10,186	50	23202
6"	1/16"	5/8"	10,186	50	23200
6"	.035"	7/8"	10,186	50	23210
7"	1/16"	1-1/4"	8,732	50	23250*
7"	1/16"	5/8"	8,732	50	23265
7"	.035"	1-1/4"	8,732	50	23252*

* These sizes are typically used for tool room applications



A60T

- Hard bond for smooth cutting
- For use in nuclear, aerospace, automotive, foundry industries, and plant maintenance

METAL Ferrous metals (iron, steel, welds, etc.)

STAINLESS High tensile metals

DIA	THICKNESS	ARBOR	MAX RPM	QTY	A60T
6"	.035"	7/8"	10,186	50	23211
7"	1/16"	1-1/4"	8,732	50	23251*
7"	1/16"	5/8"	8,732	50	23266
7"	.035"	1-1/4"	8,732	50	23253*
8"	1/16"	5/8"	7,640	50	23276

* These sizes are typically used for tool room applications

TECH INFO

- Type 1 / Type 41 shape for square, burr-free cutting
- Externally reinforced with fiberglass layers to provide ultimate safety in a thin wheel
- Wide range of grit sizes available for aggressive action to burr-free cutting

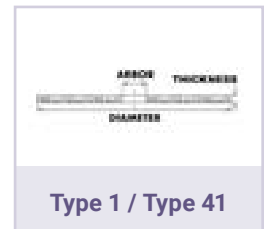

Type 1 / Type 41

THIN HIGH SPEED CUT-OFF



GENERAL PURPOSE 1/8"

A24R

- Aluminum oxide grain
- General purpose, long life

METAL Ferrous metals (iron, steel, welds, etc.)



FAST CUTTING

A36T

- Aluminum oxide grain
- Hard bond for aggressive cutting on rough applications

METAL Ferrous metals (iron, steel, welds, etc.)

STAINLESS Stainless steel



BURR FREE

A60T

- Hard bond for smooth cutting
- For use in nuclear, aerospace, automotive, foundry industries, and plant maintenance

METAL Ferrous metals (iron, steel, welds, etc.)

STAINLESS High tensile metals



PREMIUM PERFORMANCE

SAITECH ULTIMATE PERFORMANCE™

- High performance, ceramic aluminum oxide grain
- Very uniform, high density grain structure is extremely durable and self sharpening for long life and cooler cut
- High Performance
- Combines fast cutting with extremely long life

STAINLESS Stainless steel, high tensile alloys

METAL Ferrous and/or non-ferrous metals

DIA	THICKNESS	ARBOR	MAX RPM	QTY	A24R General Purpose	A36T Fast Cutting	A60T Burr Free	SAITECH ULTIMATE PERFORMANCE™
2"	1/16"	1/4"	30,558	50	-	23004	23005	-
2"	1/16"	3/8"	30,558	50	-	23002	23003	-
2"	.035"	1/4"	30,558	100	-	23012	23013	-
2"	.035"	3/8"	30,558	100	-	23010	23011	-
2-1/2"	1/16"	1/4"	24,446	50	-	23022	23023	-
2-1/2"	1/16"	3/8"	24,446	50	-	23020	23021	-
2-1/2"	.035"	1/4"	24,446	100	-	23032	23033	-
2-1/2"	.035"	3/8"	24,446	100	-	23030	23031	-
3"	1/16"	1/4"	25,000	50	-	23042	23043	23142
3"	1/16"	3/8"	25,000	50	-	23040	23041	23140
3"	.035"	1/4"	25,000	100	-	23052	23053	23152
3"	.035"	3/8"	25,000	100	-	23050	23051	23150
3"	1/8"	3/8"	20,372	25	23060	-	-	-
4"	1/16"	1/4"	19,000	50	-	23067	23068	23167
4"	1/16"	3/8"	19,000	50	-	23065	23066	23165
4"	1/16"	5/8"	19,000	50	-	23061	23062	23161
4"	.035"	1/4"	19,000	100	-	23071	23072	23171
4"	.035"	3/8"	19,000	100	-	23069	23070	23169
4"	.035"	5/8"	19,000	100	-	23063	23064	23163
4"	1/8"	3/8"	15,278	25	23075	-	-	-

1/4" shank adapters for wheels up to 3" diameter available on page 130

TECH INFO

- Type 1 / Type 41 shape for square, burr-free cutting
- Externally reinforced with fiberglass layers to provide ultimate safety in a thin wheel



Type 1 / Type 41



Die Grinder

SMALL DIAMETER PORTABLE SAW CUT-OFF WHEELS

CUTTING WHEELS



GENERAL PURPOSE

A24R

- Special aluminum oxide grain
- Provides consistent performance with long life
- Versatile dia. (5/8") arbor contains diamond knockout for use on circular saw or worm drive saw

METAL Ferrous metals (steel, angle iron, rebar)



LONG LIFE

A30S

- Special aluminum oxide grain formula
- Fast, non-binding cutting

METAL Ferrous metals

STAINLESS Stainless steel, high tensile alloys



CONCRETE

C24R

- Silicon carbide grain
- Long life
- Versatile dia. (5/8") arbor contains diamond knockout for use on circular saw or worm drive saw

CONCRETE Stone, brick, soft aggregate, masonry, concrete

DIA	THICKNESS	ARBOR	MAX RPM	QTY	A24R	A30S	C24R
4-1/2"	5/64"	7/8"	13,300	50	-	23102	-
4-1/2"	3/32"	7/8"	13,300	50	23100	-	-
7"	3/32"	Dia. (5/8")	8,500	25	23234	-	23235
8"	3/32"	Dia. (5/8")	7,600	25	23258	-	-

TECH INFO

- Type 1 / Type 41 shape for square, burr-free cutting
- External fiberglass reinforcement withstands offhand and lateral pressure for added safety and controlled performance



Type 1 / Type 41



Circular Saw



Angle Grinder



LARGE DIAMETER CUTTING WHEELS



**CHOP SAW
WHEELS**



**PORTABLE
SAW WHEELS**



**STREET
SAW WHEELS**



**STATIONARY
SAW WHEELS**

KEY FEATURES

- **Chop Saw Blades:** Designed specifically for low horsepower chop saws for fast cutting and minimal pressure
- **Portable Saw Wheels:** Utilizes the highest quality fiberglass and premium abrasives for maximum safety in the most demanding applications
- **Street Saw Wheels:** Extremely dense wheel for use on street saws
- **Stationary Saw Wheels:** Engineered for higher power stationary saws, allowing for maximum safety and controlled performance when cutting through large pieces of solid stock

CHOP SAW WHEELS

CUTTING WHEELS



FAST CUTTING EZ-CHOP ATTACKER®

- Aluminum oxide grain
- General purpose economy cutting
- Fast cutting on thin metals

METAL Metal studding, thin rebar, light gauge and medium metals



BURR FREE EZ-CHOP®

- Aluminum oxide grain
- General purpose cool cutting on thin metals
- Burr-free finish
- Externally reinforced with the highest quality fiberglass to withstand the toughest applications

METAL Metal studding, thin rebar, light gauge and heavy metals



GENERAL PURPOSE IRON WORKER™

- Aluminum oxide grain
- Fast cutting
- Excellent for use on angle iron, channel iron, heavy rebar, and other ferrous metals

METAL Structural metal applications

DIA	THICKNESS	ARBOR	MAX RPM	QTY	EZ-CHOP ATTACKER®	EZ-CHOP®	IRON WORKER™
12"	3/32"	1"	5,100	10	–	24034	24031
14"	3/32"	1"	4,400	10	24500	24039	24051
16"	3/32"	1"	3,700	10	–	–	24011

TECH INFO

- Use EZ-Chop® or EZ-Chop Attacker® as an economical alternative for general purpose cutting
- All blades are constructed using the highest quality fiberglass to withstand the toughest applications
- Specially formulated for use on low horsepower chop saw machines for fast cutting with minimal pressure

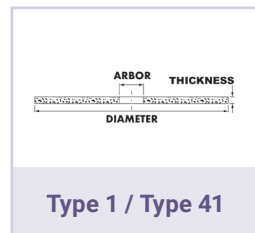



HIGH PERFORMANCE

Z-TECH™

- Special zirconium grain formula
- Fast, non-binding cutting
- Internally reinforced with the highest quality fiberglass to withstand the toughest applications

METAL Ferrous metals
STAINLESS Stainless steel, high tensile alloys



PREMIUM PERFORMANCE

SAITECH STEEL WORKER®

- Manufactured with premium ceramic grain
- Extremely fast, burr-free cutting
- Designed to outlast standard aluminum oxide wheels

STAINLESS Stainless steel, high tensile alloys
METAL Ferrous metals (iron, steel, welds, etc.)



SPECIALTY

STUD KING™

- Aluminum oxide grain
- General purpose cool cutting on thin metals
- Burr-free finish

METAL Metal studding, thin rebar, light gauge metals



SPECIALTY

A46N - ALUMINUM

- Aluminum oxide grain
- Special non-loading formulation

ALUMINUM Non-ferrous metals (aluminum, bronze, brass, etc.)

DIA	THICKNESS	ARBOR	MAX RPM	QTY	Z-TECH™	SAITECH STEEL WORKER®	STUD KING™	A46N
10"	3/32"	5/8"	6,100	25	-	-	24035	-
12"	3/32"	1"	5,100	10	-	24033	24030	-
14"	3/32"	1"	4,400	10	24414	24053	24050	24052
16"	3/32"	1"	3,700	10	-	24013	24010	-

TECH INFO

- All blades are constructed using the highest quality fiberglass to withstand the toughest applications
- Specialty formulas give you the exact wheel for your cutting application

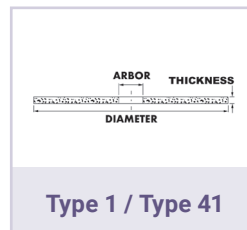

PORTABLE SAW WHEELS

CUTTING WHEELS



A24R

- Special aluminum oxide grain
- Provides consistent performance with long life

METAL Ferrous metals (steel, angle iron, rebar)



XFC™

- Special aluminum oxide grain formula
- Fast cutting action
- Non-binding cutting formula

METAL Ferrous metals
STAINLESS Stainless steel, high tensile alloys



SAIT PRO

- Aluminum oxide grain
- Best value for a fast cut

METAL Ferrous metals



BRUTE™

- Long life
- Extremely hard bond for cutting metals that present a very sharp edge to the wheel

METAL Thin metal, sheet metal, decking, other ferrous metals



HOBO®

- For use on high horsepower machines
- Rugged fiberglass reinforcement for maximum safety
- Excellent for the railroad industry

METAL Mainline, secondary, spur rail steel; Heavy sections of ferrous metals (I-beams, bar stock, etc.)

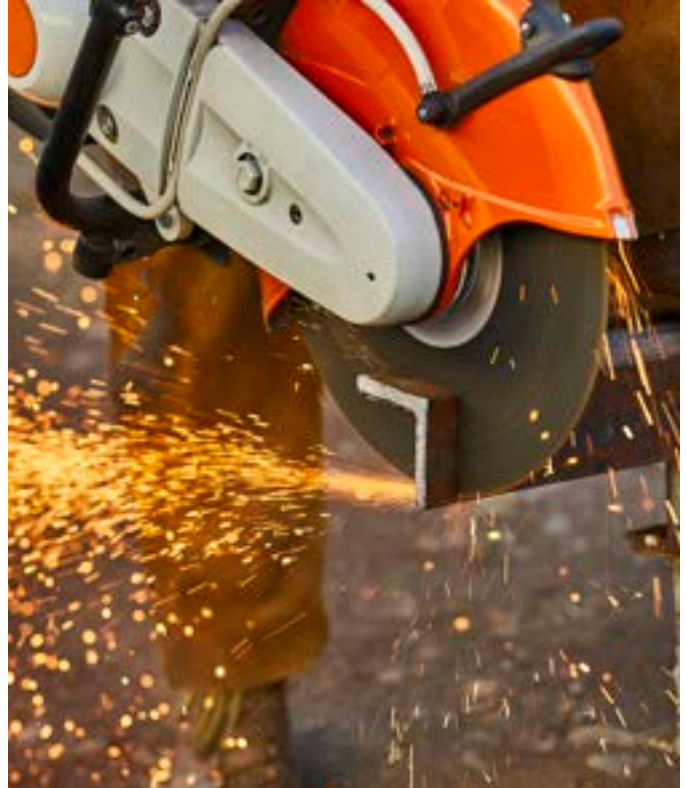

DIA	THICKNESS	ARBOR	MAX RPM	QTY	A24R	SAIT PRO METAL	BRUTE™
12"	1/8"	20MM	6,300	10	23420	23421	23422
12"	1/8"	1"	6,300	10	23410	23414	23412
14"	1/8"	20MM	5,460	10	-	24140	-
14"	1/8"	1"	5,400	10	-	24135	-

HEAVY DUTY

DIA	THICKNESS	ARBOR	MAX RPM	QTY	A24R	XFC™	BRUTE™	HOBO®
14"	1/8"	20MM	5,460	10	23455	24160	23457	-
14"	1/8"	1"	5,400	10	23450	24150	23452	23501
16"	1/8"	1"	4,800	10	23459	-	-	23502



SPECIALTY DUCTILE™

- Combination aluminum oxide and silicon carbide formulation
- Use the Ductile™ wheel for extra hard metals, hydraulic hose and PVC pipe

METAL Ductile pipe (very hard steel casing enclosing a cement lining), water mains, etc.

CONCRETE Combination metal/concrete, cast iron, hard metals, concrete coated steel, etc.



GENERAL PURPOSE - CONCRETE C24R

- Silicon carbide grain
- Long life

CONCRETE Stone, brick, soft aggregate, masonry, concrete, schedule 40 and schedule 80 PVC pipe



MASONRY, ASPHALT, CONCRETE BIG M.A.C.™

- Special silicon carbide grain
- Superior cutting action
- 40% longer life than general purpose concrete wheels

CONCRETE Masonry, asphalt, concrete

DIA	THICKNESS	ARBOR	MAX RPM	QTY	DUCTILE™	C24R	BIG M.A.C.™
12"	1/8"	20MM	6,300	10	23425	23423	23462
12"	1/8"	1"	6,300	10	23415	23413	23460

HEAVY DUTY

DIA	THICKNESS	ARBOR	MAX RPM	QTY	DUCTILE™	C24R	BIG M.A.C.™
14"	1/8"	20MM	5,460	10	23458	23456	23464
14"	1/8"	1"	5,400	10	23453	23451	23463
16"	1/8"	1"	4,800	10	23480	23461	-

TECH INFO

- Heavy Duty Wheels: Designed with greater amounts of reinforcement for use on high-speed gas powered saws
- Type 1 / Type 41 shape is ideal for square, burr-free cutting
- Available in multiple arbor sizes to fit a wide variety of tools



Type 1 / Type 41



Portable Saw

9" PORTABLE SAW WHEELS

CUTTING WHEELS



For use on 9" cordless electric portable saws.
Available in two formulations for a wide variety of applications.



GENERAL PURPOSE A60S

- Special aluminum oxide grain
- Extremely fast burr-free cutting with long life
- Exceptional performance

METAL Ferrous and/or non-ferrous metals (iron, steel, stud, rebar, etc.)



PREMIUM PERFORMANCE THE ULTIMATE CERAMIC CUT-OFF™

- Premium ceramic aluminum oxide grain
- Exceptionally long-lasting design that maximizes productivity for fewer wheel changes

METAL Ferrous and/or non-ferrous metals (iron, steel, stud, rebar, etc.)

STAINLESS Stainless steel, high tensile alloys

DIA	THICKNESS	ARBOR	MAX RPM	QTY	A60S	ULTIMATE CERAMIC™
9"	5/64"	7/8"	6,600	25	23405	20229



GENERAL PURPOSE C16

- Silicon carbide grain
- Fast, free cutting

CONCRETE Green concrete, asphalt

DIA	THICKNESS	ARBOR	MAX RPM	QTY	C16
14"	3/16"	1"	4,400	5	24061

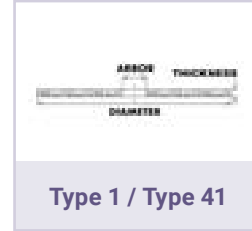

Type 1 / Type 41



Street Saw

TECH INFO

- All wheels have a pinhole for mounting on various machines, street saws, etc.
- These wheels can be used with cooling sprays for dust-free cutting needs
- Cutting wheels are balanced to provide straight cuts



FAST CUTTING A24N

- Aluminum oxide grain
- General purpose
- Soft bond for fast stock removal

METAL Ferrous metals
(iron, cast iron, etc.)

STAINLESS Low grade stainless steel



BURR-FREE A36R

- Aluminum oxide grain
- A finer grit for burr-free finish

METAL Ferrous metals
(metal tubing, etc.)

STAINLESS Stainless steel,
high tensile steel



GENERAL PURPOSE A24R

- Aluminum oxide grain
- General purpose, long life

METAL Ferrous metals
(iron, steel, angle iron, etc.)



CONCRETE C24R

- Silicon carbide grain
- General purpose, long life
- Square cutting

CONCRETE Masonry, concrete,
stone, brick

DIA	THICKNESS	ARBOR	MAX RPM	QTY	A24N	A24R	A36R	C24R
10"	1/8"	5/8"	6,100	25	-	-	24002	24003
12"	1/8"	1"	5,100	10	-	24020	-	-
14"	1/8"	1"	4,400	10	-	24040	-	-
16"	5/32"	1"	3,800	10	-	24070	-	-
18"	3/16"	1"	3,400	5	24081	24080	24082	-
20"	3/16"	1"	3,000	5	24091	24090	24092	-
24"	1/4"	1"	3,150	5	24101	24100	24102	-

TECH INFO

- Type 1 / Type 41 shape for square, burr-free cutting
- Internal fiberglass reinforcement for maximum safety and controlled performance
- Dual external mounting area reinforcement on 14" to 24" wheels
- Special grain to fiberglass ratio provides added safety and excellent cutting performance on heavy-duty stationary saws
- Cutting wheels are balanced to provide straight, even cuts

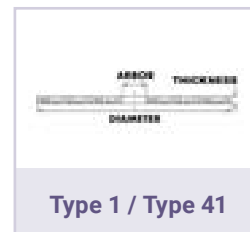

Type 1 / Type 41



Stationary Saw

TECHNICAL INFORMATION

CARBIDE GRAIN STRUCTURE

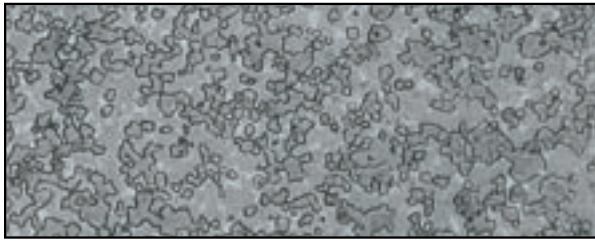

SAIT Carbide Matrix

- Consistent size of carbide grains.
- More carbide per tooth as grains are smaller.
- Smaller grain = harder tooth, more durability.

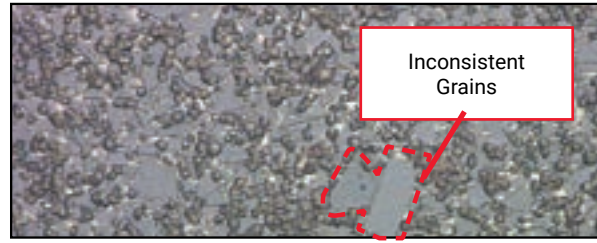

Competitor Carbide Matrix

- Very inconsistent size of carbide grains.
- Less life due to larger grain sizes.

TOOTH CONFIGURATION

Triple Chip Grind (TCG)



- FEATURE: Maximizes blade life by reducing the size of the metal chips that are produced during the cutting operations. Also provides maximum tooth strength for longer life.
- BENEFIT: Cleaner and cooler cuts; less stress on material being cut.
- WHERE USED: Steelworker® (all sizes), 7-1/4" Stainless, 8", 10" and 12" aluminum blades.

Alternate Top Bevel (ATB)



- FEATURE: A multi-purpose grind that allows for durable, long life as well as productive work across a wide range of materials.
- BENEFIT: Clean, easy cutting without binding in the material.
- WHERE USED: 6-1/2" and 7-1/4" TMX, and 14" aluminum blades.

Modified Triple Chip Grind (MTCG)



- FEATURE: Excels at reducing chip size for more effective cutting of material. Also improves cutting tooth durability.
- BENEFIT: Lower heat build-up and less blade stress while cutting.
- WHERE USED: 12" and 14" TMX and 14" stainless steel blades.

BLADE OPERATION TIPS

- Be sure to mount the blade with the rotational arrow positioned the same direction as the tool rotates
- Follow circular saw manufacturer's warnings and instruction manual
- Check blade prior to use for any visible cracks, loose or missing teeth, etc. and change blade if found
- Use blade only on recommended material
- Mount blade between designated sides of blade washers matching arbor size and shape
- Always wear ANSI-approved eye protection and proper protective equipment
- Always wear gloves
- Adjust foot-plate of the saw to proper depth (check circular saw manual - 3 teeth exposed below material surface is a common rule of thumb)
- Always work in a clean and unobstructed work environment
- Never operate saw without working blade guard
- Do not use excessive pressure when cutting (this causes the blade to wear prematurely)
- Tighten blade bolt as instructed by saw manufacturer

METAL-CUTTING CARBIDE BLADES

CUTTING WHEELS



LONG LIFE



COOL CUTTING



**FAST, BURR-FREE
CUTTING**

KEY FEATURES

- Designed for use on professional metal-cutting saws
- Premium micro grain carbide: Smaller grains mean more carbide per tooth – stays sharp and provides longer life over competitive blades
- Cuts cool and fast
- Reduced fire hazards and less dust: Metal blades cut cleanly with minimal sparks

METAL-CUTTING CARBIDE BLADES

CUTTING WHEELS



STEEL WORKER®

- Fast, burr free cutting on heavier gauge metals
- Cool cutting action with long life

METAL Angle iron, rebar, steel plate, channel iron, pipe, threaded rod, c-channel and other ferrous metals

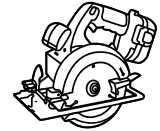

Cordless Circular Saw

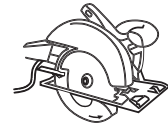

Circular Saw



Metal-Cutting Circular Saw

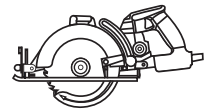

Worm Drive Saw

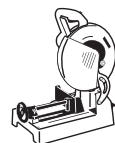

Low RPM Metal-Cutting Saw

DIA	TEETH	ARBOR	GRIND	MAX RPM	QTY	MACHINE	PART #
5-3/8" (137mm)	30T	20MM (10MM & 5/8" BUSHING)	MTCG	4,200	1	CORDLESS CIRCULAR SAW	77915
6-1/2" (165mm)	40T	5/8" (16mm)	TCG	5,800	1	CIRCULAR SAW	77920
7" (178mm)	36T	20MM	TCG	5,800	1	METAL-CUTTING CIRCULAR SAW	77936
7-1/4" (184mm)	40T	5/8" (16mm) / Diamond	MTCG	5,800	1	CIRCULAR SAW; WORM DRIVE SAW	77930
8" (203mm)	42T	5/8" (16mm) / Diamond	MTCG	5,800	1	CIRCULAR SAW; WORM DRIVE SAW	77940
9" (229mm)	48T	1" (26mm)	TCG	3,200	1	CIRCULAR SAW	77947
10" (254mm)	52T	5/8" (16mm)	TCG	5,200	1	CIRCULAR SAW; LOW RPM METAL-CUTTING SAW	77953
12" (305mm)	60T	1" (26mm)	TCG	2,000	1	LOW RPM METAL-CUTTING SAW	77962
14" (356mm)	72T	1" (26mm)	MTCG	1,800	1	LOW RPM METAL-CUTTING SAW	77972



TMX - THIN METAL XTRA

- Fast, burr free cutting on thin gauge metals
- Cool cutting action with long life

METAL Thin metals, metal studs, duct work, sheet metals, galvanized roofing, thin walled pipe, conduit, strut channel

DIA	TEETH	ARBOR	GRIND	MAX RPM	QTY	MACHINE	PART #
6-1/2" (165mm)	48T	5/8" (16mm)	ATB	5,800	1	CIRCULAR SAW	77921
7-1/4" (184mm)	68T	5/8" (16mm) / Diamond	ATB	5,800	1	CIRCULAR SAW; WORM DRIVE SAW	77931
12" (305mm)	80T	1" (26mm)	MTCG	2,000	1	LOW RPM METAL-CUTTING SAW	77965
14" (356mm)	90T	1" (26mm)	MTCG	1,800	1	LOW RPM METAL-CUTTING SAW	77975

Blades must be run in the direction of the arrow as indicated on the blade.

NOTE

TECH INFO

- Designed for use on professional metal-cutting saws
- Premium micro grain carbide; Smaller grains mean more carbide per tooth – stays sharp and provides longer life over competitive blades
- Cuts cool and fast
- Metal blades cut cleanly with minimal sparks
- Reduced fire hazards and less dust





STAINLESS

- Cool cutting action for minimal discoloration
- Fast, burr free cutting

STAINLESS Tubing, bars, pipe, and stainless steel plates

DIA	TEETH	ARBOR	GRIND	MAX RPM	QTY	MACHINE	PART #
7" (178mm)	48T	20mm	TCG	5,800	1	METAL-CUTTING CIRCULAR SAW	77938
7-1/4" (184mm)	48T	5/8" (16mm) / Diamond	TCG	5,800	1	CIRCULAR SAW; WORM DRIVE SAW	77933
14" (356mm)	90T	1" (26mm)	MTCG	1,800	1	LOW RPM METAL-CUTTING SAW	77977

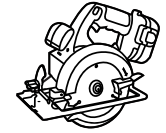

Cordless Circular Saw

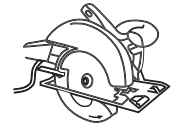

Circular Saw



Metal-Cutting Circular Saw

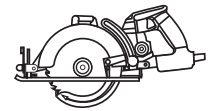

Worm Drive Saw

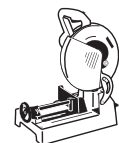

Low RPM Metal-Cutting Saw

Blades must be run in the direction of the arrow as indicated on the blade.

NOTE



ALUMINUM

- Cool cutting action with long life and minimal melting of aluminum
- Fast, burr free cutting

ALUMINUM Aluminum, other non-ferrous metals and pipe

DIA	TEETH	ARBOR	GRIND	MAX RPM	QTY	MACHINES	PART #
5-3/8" (137mm)	50T	20mm (10mm & 5/8" Bushing)	ATB	4,200	1	CORDLESS CIRCULAR SAW	77917
6-1/2" (165mm)	60T	5/8" (16mm)	ATB	5,800	1	CIRCULAR SAW	77922
7" (178mm)	54T	20mm	ATB	5,800	1	METAL-CUTTING CIRCULAR SAW	77937
7-1/4" (184mm)	60T	5/8" (16mm) / Diamond	ATB	5,800	1	CIRCULAR SAW; WORM DRIVE SAW	77932
8" (203mm)	60T	5/8" (16mm) / Diamond	TCG	5,800	1	CIRCULAR SAW; WORM DRIVE SAW	77942
10" (254mm)	80T	5/8" (16mm)	TCG	5,200	1	CIRCULAR SAW; LOW RPM METAL-CUTTING SAW	77955
12" (305mm)	80T	1" (26mm)	TCG	2,000	1	LOW RPM METAL-CUTTING SAW	77966
14" (356mm)	80T	1" (26mm)	ATB	1,800	1	LOW RPM METAL-CUTTING SAW	77976



LONG LIFE



COOL CUTTING



FAST, BURR-FREE CUTTING

SMALL DIAMETER DIAMOND BLADES

CUTTING WHEELS



CONTINUOUS RIM

- Thin .060 for precise tile cutting
- Continuous uniform rim for smooth, dry and wet cutting of tiles and ceramic materials
- Longer lasting and faster cutting
- For use on small diameter electric saws

TILE & CERAMIC



SERRATED RIM

- Continuous rim with alternating serrations for fast, cool cutting wet or dry
- Smooth cutting of almost any aggregate material
- For use on small diameter electric saws

CONCRETE Concrete, ceramic, granite, brick, blocks, marble

CE PREMIUM	General purpose cutting
CC PREMIUM +	Longer lasting and faster cutting premium wheel



SEGMENTED RIM

- Segmented rim allows for a cool cut
- Laser welded bonding to the metal core for cutting wet or dry

CONCRETE Concrete, ceramic, granite, brick, blocks, marble

LU PREMIUM	General purpose dry cutting
LV PREMIUM +	Longer lasting and faster dry cutting premium wheel

DIA	THICKNESS	ARBOR	MAX RPM	QTY	CONTINUOUS RIM	SERRATED RIM		SEGMENTED RIM	
						CE PREM	CC PREM +	LU PREM	LV PREM +
4-1/2"	.060"	5/8"	13,300	1	48521	-	-	-	-
4-1/2"	.060"	7/8"	13,300	1	48721	-	-	-	-
4-1/2"	.090"	5/8"	13,300	1	-	48501	48511	48531	48541
4-1/2"	.090"	7/8"	13,300	1	-	48701	48711	48731	48741
5"	.090"	5/8"	12,200	1	-	48502	48512	48532	48542
5"	.090"	7/8"	12,200	1	-	48702	48712	48732	48742
7"	.090"	5/8"	8,500	1	-	48504	48514	48534	48544
7"	.090"	7/8"	8,500	1	-	48704	48714	48734	48744

TECH INFO

- Premium quality diamond for exceptional cutting and long life
- 5/8" arbor for use on a circular saw
- 7/8" arbor for use on an angle grinder

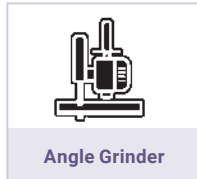

For use on portable gas saws and street saws up to 15HP. Each blade feature a 1"/20mm knockout arbor. All segments are laser welded for maximum durability and safety. Large diameter diamond blades can be used wet or dry.



GENERAL PURPOSE CONCRETE

- Designed for cutting concrete with rebar and other concrete applications
- Features 12mm segments for longer blade life

CONCRETE Cured concrete, brick, concrete block and pavers

ALL PURPOSE CONCRETE / ASPHALT

- Designed for cutting concrete, green concrete, brick, concrete block, paver and asphalt
- Features 10mm segments with deep segment/undercut protection for long life and non-binding cutting

CONCRETE Cured concrete, green concrete, brick, concrete block, pavers and asphalt

DIA	THICKNESS	ARBOR	MAX RPM	QTY	GENERAL PURPOSE CONCRETE	ALL PURPOSE CONCRETE / ASPHALT
12"	.125"	1" (20mm)	6,300	1	48800	48801
14"	.125"	1" (20mm)	5,460	1	48805	48806



TECH INFO

- Premium quality diamond for exceptional cutting and long life
- 1" (20mm) arbor for use on portable gas saws and street saws up to 15HP

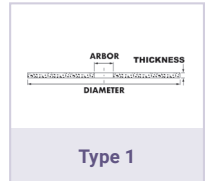

COATED ABRASIVES INDEX

TECHNICAL INFORMATION	58	FIBER DISCS – ZIRCONIUM	75	CLOTH SHEETS	92
FLAP DISCS	60	AZ-X ZIRCONIUM	75	ALUMINUM OXIDE (DA-F)	92
FLAP DISCS - PLASTIC BACKING	62	Z – ZIRCONIUM	75	DRYWALL	93
ENCORE PLUS	62	3Z – ZIRCONIUM	75	SAITSCREEN™	93
ENCORE CERAMIC PLUS	62	FIBER DISCS - CERAMIC	76	PAPER	93
OVATION® PLUS	62	7S CERAMIC	76	GIRAFFE DRYWALL DISCS **NEW**	93
OVATION® ATTACKER® PLUS	62	9S CERAMIC	76	FILE BOARD SHEETS & SPONGES	94
OVATION® CERAMIC PLUS	62	FIBER DISCS		FILE BOARD SHEETS	94
FLAP DISCS - FIBERGLASS BACKING . 64		CERAMIC & SILICON CARBIDE	77	SANDING SPONGES	94
ENCORE	64	7-II CERAMIC	77	SHOP ROLLS	95
ENCORE CERAMIC	64	9.3 POWER MAX CERAMIC **NEW**	77	HANDY ROLL – DA-F	95
OVATION®	64	SILICON CARBIDE	77	INDUSTRIAL ROLL – EA-F	95
OVATION® ATTACKER®	64	STOCK BELTS	78	EA-F CUSTOM ROLLS	95
OVATION® CERAMIC	64	1A-X / 2A-X ALUMINUM OXIDE	80	SPECIALTY SHOP ROLLS	96
OVATION® STAINLESS	64	AO-X ALUMINUM OXIDE	81	DA-F MINI SHOP ROLLS	96
FLAP DISCS - TRIMMABLE PLASTIC		SAIT-SAVER™ / LA-X	81	PLUMBER ROLL	96
BACKING	66	Z-H ZIRCONIA ALUMINA	82	AW-D MINI PAPER ROLLS	96
TRIMBACK™	66	9S-H CERAMIC		SAITSCREEN™ ROLLS	96
TRIMBACK™ CERAMIC	66	ALUMINUM OXIDE **NEW**	83	FLOOR SANDING	97
TRIMBACK™ STAINLESS	66	PAPER DISCS	84	FLOOR SANDER BELTS	97
FLAP DISCS - SPECIALTY	68	PSA DISC ROLLS	85	FLOOR SANDING SHEETS	97
SAITLAM UK™	68	INDIVIDUAL PSA DISCS	85	EDGE FLOOR SANDING DISCS	98
ENCORE MINI	68	HOOK & LOOP DISCS	86	LARGE DIAMETER FLOOR	
SAIT GF – GRIND & FINISH	69	CLOTH DISCS	87	SANDING DISCS	98
SAND-LIGHT™	69	INDIVIDUAL PSA DISCS	87	SAITSCREEN™ DISCS	98
FLAP WHEELS - SMALL DIAMETER	70	LAMINATED DISCS	88	FLOOR SANDING ROLLS	99
2A ALUMINUM OXIDE	70	PAPER SHEETS	90	SAITSCREEN™ SHEETS	99
3A ALUMINUM OXIDE	70	ALUMINUM OXIDE (AW-C & AW-D)	90	CARTRIDGE ROLLS	100
FLAP WHEELS - LARGE DIAMETER	71	GARNET	90	STRAIGHT CARTRIDGE ROLLS	100
2A ALUMINUM OXIDE	71	WATERPROOF SILICON CARBIDE		TAPERED CARTRIDGE ROLLS	101
3A ALUMINUM OXIDE	71	(CW-C)	90	SPIRAL BANDS	102
5/8-11 THREADED FLAP WHEEL	71	SAIT-PAK™	90	CROSS & SQUARE PADS	103
FIBER DISCS	72	ALUMINUM OXIDE (AY-D)	91	CROSS PADS	103
FIBER DISCS - ALUMINUM OXIDE	74	ALUMINUM OXIDE (3S)	91	SQUARE PADS	103
AO ALUMINUM OXIDE	74	ALUMINUM OXIDE (4S)	91		
2A ALUMINUM OXIDE	74				
3A ALUMINUM OXIDE	74				

The image displays various types of coated abrasives. At the top, there is a large roll of red abrasive material with a metal rod protruding from its center. To its left is a smaller roll of grey material with a black plastic component on top. In the foreground, there are several circular abrasive discs. Two are red with a central hole, and one is orange with a central hole and the text 'SAIT SAITDISC' and '180 mm' embossed on it. A black plastic component is also on the orange disc. To the right, there is a roll of blue abrasive material and a white circular disc. The background is dark, making the products stand out.

COATED ABRASIVES

WHAT IS A COATED ABRASIVE?

A coated abrasive is a product that consists of a thin layer of abrasive grain attached to a substrate such as paper, cloth, etc. Coated abrasives come in a variety of forms such as sheets, discs, rolls, specialties, or belts.

COMPONENTS OF COATED ABRASIVES – ABRASIVE GRAINS

Coated abrasives are manufactured using abrasive grains; the most common are aluminum oxide, zirconium, ceramic, silicon carbide and garnet. The crude grains are crushed and separated into sizes, called grit sizes, using calibrated screens. Grits range from 12 (very coarse) to 2,000 (very fine). Once the grains are separated into sizes, they are attached to a backing material using various bond techniques. Below are descriptions of the most common abrasive grains:

Ceramic

A high performance, man-made abrasive material. Very uniform, high density grain structure is extremely durable and self sharpening for longer life and cooler cut. Excels on tough to grind materials.

Aluminum Oxide

A tough, blocky shaped, man-made grain used for high speed grinding and finishing of metals, wood and other high tensile strength materials without excessive fracturing or shedding. Wherever the ability to resist fracturing is the main consideration, aluminum oxide will outperform all other coated abrasive grains.

Zirconium

A very fine, dense, man-made crystalline grain which can be used for aggressive stock removal. Zirconium is a very dense material with a unique self-sharpening characteristic which gives it long life on heavy stock removal operations.

Silicon Carbide

A very hard, very sharp, man-made abrasive suited for non-ferrous materials and non-metallic materials such as concrete, marble and glass. A very friable grain, silicon carbide cuts faster under light pressure than any other grain used in coated abrasives.

Garnet

Garnet is made of natural aluminum oxide which is a relatively sharp, but very weak bonding structure. Very inconsistent when compared to synthetics. It is used primarily in woodworking as garnet dulls too quickly to be used in metalworking.

BACKING MATERIALS – SUBSTRATES

Below are the four major types of backing materials:

Paper

Specialized technical papers are used as substrates for coated abrasives. They are identified by letters representing weight and flexibility:

“A” and “B” weights are light weight and highly flexible. “C”, “D”, “E”, “F” weights are medium to heavy weight for more strength and less flexibility.

Cloth

Cloth backings are more durable than paper backings. There are several types of cloth backings: cotton (ie: Egyptian), polyester and polyester-cotton blends. Cloth backings are identified by weight and flexibility:

“F” weight (J-Flex) is light and highly flexible. This lighter weight is suitable for cleaning, finishing and polishing.

“J” weight (Jeans) is highly flexible and suitable for cleaning, finishing and polishing of contour surfaces.

“X” weight (Drills) is medium to heavy weight for more strength and durability. It has low flexibility suitable for grinding, deburring and finishing.

“H” (Heavy Duty) is a heavier weight than “X” weight. It has low flexibility and is suitable for heavy duty grinding and deburring applications. Excellent edge stability.

Fiber

Fiber backing is a tough vulcanized material made from rag stock. This backing is generally used for abrasive fiber discs.

Combination

Combination backing is laminated paper and cloth and is very sturdy and shock resistant. Combination backings typically are used for a wide range of grits and mounting techniques.

Other Backing Materials

There are also a variety of other substrates such as nylon fiber or screens that can be coated for special applications. Non-woven nylon impregnated with abrasive grain is another substrate that can be used for cleaning, polishing or blending.

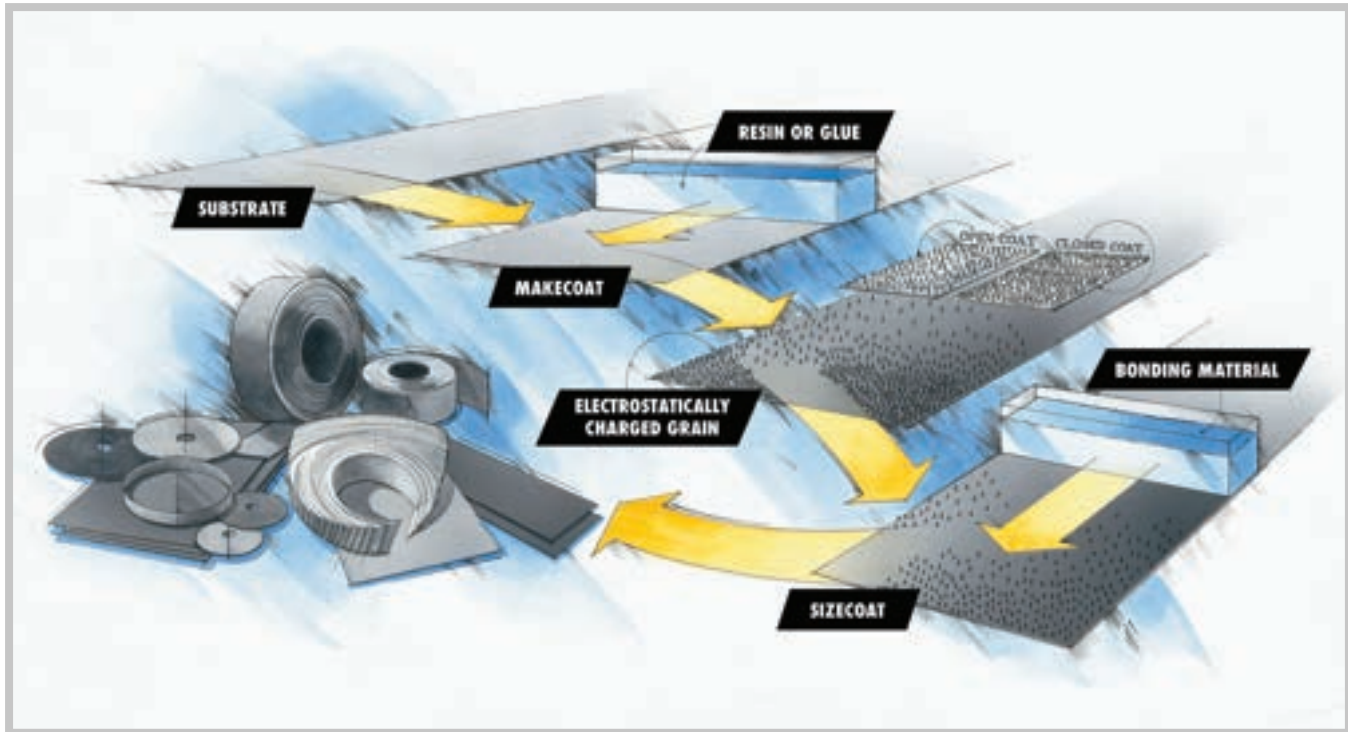

DIFFERENCE

- We use only the **highest quality raw materials**, which are stored in an environmentally controlled area. These include grains and backings (such as paper, cotton, cotton-polyester and polyester materials) as well as resins and glues used in the process.
- One of the world's most modern, **highly automated and state-of-the-art** coated abrasives production facilities.
- Our coated abrasives are cured in the latest, most updated, temperature controlled ovens to ensure that we produce a **consistent and quality finished product**, which is rigorously monitored every step of the way by our world renowned quality control department.
- SAIT Abrasives has been the world leader in producing the highest quality coated abrasives for over 50 years!

FLAP DISC INTRODUCTION

- Flap discs are constructed by layering coated abrasive flaps so they wear away and expose new, sharp grain
- Flap discs increase productivity and reduce total grinding and finishing costs by grinding, blending & finishing in 1 step

DENSITIES

High density flap discs contain approximately 40% more material than regular density flap discs.

Regular Density

High Density



COATED ABRASIVES

HIGH DENSITY



REGULAR DENSITY



BACKING SHAPE

Conical Shape Features (Type 29)

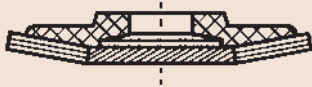

- Built-in angle for increased contact area
- Best for use on contoured surfaces and edge work
- Minimizes workpiece gouging
- More aggressive stock removal due to higher angle
- 15°-25° working angle

Flat Shape Features (Type 27)

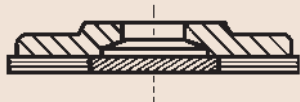

- Best for use on miter joints, corners and edges
- Best choice for finishing intricate and ornate surfaces
- Ideal for smooth finishing
- 0°-15° working angle

BACKING TYPE

Fiberglass Backing Features

- Backing will wear uniformly with abrasive cloth
- Will not splinter or smear on the workpiece
- Lighter, quieter operation

Plastic Backing Features

- Non-scratching, high strength backing
- Resistant to temperature extremes, common chemicals and solvents
- Some plastic backings are trimmable



COATED ABRASIVES

FLAP DISCS VS. GRINDING WHEELS

- Faster stock removal and smoother finish
- Quieter operation and reduced vibration minimizing operator fatigue
- Cooler cutting, reduced loading and glazing
- Easy to use – reduced gouging and rework

FLAP DISCS VS. FIBER DISCS

- Up to 20 times longer life than a fiber disc
- No backing pad needed
- Easier storage – no curling
- Flap discs should use one grit coarser than used in fiber discs (except 36 grit)
- More consistent finish

THE

DIFFERENCE

TWO TYPES OF PLASTIC BACKINGS

- ABS plastic designed to be trimmed to expose more abrasives material
- Hard plastic designed for high strength and rigidity promoting ease of use and long-life

FIBERGLASS BACKING

- Custom engineered fiberglass backing plates for strength and safety
- More fiberglass than competitors – making our flap discs among the safest on the market

ADHESIVE SYSTEM

- Specially formulated adhesive system, designed to effectively secure the abrasive flaps to the backing, maximizes abrasive performance and safety

COATED MATERIAL

- Our own coated material has been specifically designed for flap discs
- Unique materials are used for each flap disc application

FLAP DESIGN

- We utilize more and larger flaps than our competitors to yield great performance and product life

FLAP DISCS - PLASTIC BACKING

Ease of use reduces operator fatigue • Longer life than fiberglass backing at the same cost

COATED ABRASIVES

REGULAR DENSITY



ENCORE PLUS

- Tough zirconium grain provides fast grinding and reliable finishing performance
- Durable polyester-cotton backing for long life
- Exceptional value and performance

METAL Ferrous and/or non-ferrous metals
STAINLESS Stainless steel, high tensile steel, titanium
ALUMINUM Non-ferrous metals (aluminum, copper, brass, etc.)



ENCORE CERAMIC PLUS

- Premium ceramic grain outlasts conventional zirconium in most applications
- Cooler cutting and fast, consistent finishes

METAL Ferrous and/or non-ferrous metals
STAINLESS Stainless steel, high tensile steel, titanium



OVATION® PLUS

- Heavy duty zirconium grain, designed for **high pressure** applications
- Durable polyester backing for reduced edge wear and long life
- 40% more material than conventional, regular density flap discs
- Continues to grind after most flap discs stop

METAL Ferrous and/or non-ferrous metals
STAINLESS Stainless steel, high tensile steel, titanium



OVATION® ATTACKER® PLUS

- High performance zirconium grain for a wide variety of grinding and finishing applications
- Provides long life while maintaining high stock removal rates
- 40% more material than conventional, regular density flap discs

STAINLESS Stainless steel, high tensile steel, titanium
METAL Ferrous metals
ALUMINUM Non-ferrous metals (aluminum, copper, brass, etc.)



OVATION® CERAMIC PLUS

- Premium ceramic grain outlasts conventional zirconium in most applications
- Cooler cutting and fast, consistent finishes
- 40% more material than conventional, regular density flap discs

METAL Ferrous and/or non-ferrous metals
STAINLESS Stainless steel, high tensile steel, titanium



DIA	ARBOR	GRIT	MAX RPM	REGULAR DENSITY				HIGH DENSITY		
				ENCORE PLUS		ENCORE CERAMIC PLUS		OVATION PLUS	OVATION ATTACKER PLUS	OVATION CERAMIC PLUS
				TYPE 27	TYPE 29	TYPE 27	TYPE 29	TYPE 27	TYPE 27	TYPE 27
4-1/2"	7/8"	36	13,300	71285	72238	71300	72250	72200	72214	72226
4-1/2"	7/8"	40	13,300	71286	72239	71301	72251	72201	72215	72227
4-1/2"	7/8"	60	13,300	71287	72240	71302	72252	72202	72216	72228
4-1/2"	7/8"	80	13,300	71288	72241	71303	72253	72203	72217	72229
4-1/2"	7/8"	120	13,300	-	-	-	-	72204	-	-
4-1/2"	5/8-11	36	13,300	71385	72338	71400	72350	72300	72314	72326
4-1/2"	5/8-11	40	13,300	71386	72339	71401	72351	72301	72315	72327
4-1/2"	5/8-11	60	13,300	71387	72340	71402	72352	72302	72316	72328
4-1/2"	5/8-11	80	13,300	71388	72341	71403	72353	72303	72317	72329
4-1/2"	5/8-11	120	13,300	-	-	-	-	72304	-	-
5"	7/8"	36	12,200	-	72244	-	72256	72207	72220	72232
5"	7/8"	40	12,200	-	72245	-	72257	72208	72221	72233
5"	7/8"	60	12,200	-	72246	-	72258	72209	72222	72234
5"	7/8"	80	12,200	-	72247	-	72259	72210	72223	72235
5"	7/8"	120	12,200	-	-	-	-	72211	-	-

QUANTITY:
Packaged
10 per box

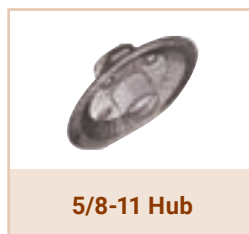
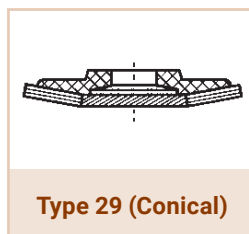
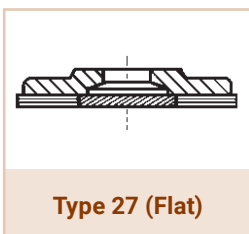

FLAP DISCS - FIBERGLASS BACKING

Backing will wear uniformly with abrasive cloth • Will not splinter or smear on the workpiece • Lighter, quieter operation

REGULAR DENSITY



ENCORE

- Tough zirconium grain provides fast grinding and reliable finishing performance
- Durable cotton backing for long life
- Exceptional value and performance

METAL Ferrous and/or non-ferrous metals
STAINLESS Stainless steel, high tensile steel, titanium
ALUMINUM Non-ferrous metals (aluminum, copper, brass, etc.)



ENCORE CERAMIC

- Premium ceramic grain outlasts conventional zirconium in most applications
- Cooler cutting and fast, consistent finishes

METAL Ferrous and/or non-ferrous metals
STAINLESS Stainless steel, high tensile steel, titanium



OVATION®

- Heavy duty zirconium grain, designed for high pressure applications
- Durable polyester backing for reduced edge wear and long life
- 40% more material than conventional, regular density flap discs
- Continues to grind after most flap discs stop

METAL Ferrous and/or non-ferrous metals
STAINLESS Stainless steel, high tensile steel, titanium



OVATION® ATTACKER®

- High performance zirconium grain for a wide variety of grinding and finishing applications
- Provides long life while maintaining high stock removal rates
- 40% more material than conventional, regular density flap discs

STAINLESS Stainless steel, high tensile steel, titanium
METAL Ferrous metals
ALUMINUM Non-ferrous metals (aluminum, copper, brass, etc.)



OVATION® CERAMIC

- Premium ceramic grain outlasts conventional zirconium in most applications
- Cooler cutting and fast, consistent finishes
- 40% more material than conventional, regular density flap discs

METAL Ferrous and/or non-ferrous metals
STAINLESS Stainless steel, high tensile steel, titanium



OVATION® STAINLESS

- Premium aluminum oxide with grinding aid for grinding and finishing on stainless steel with minimal discoloration
- Works great on aluminum and non-ferrous materials with minimal loading
- Provides long life while maintaining high stock removal rates
- 40% more material than conventional, regular density flap discs

STAINLESS Stainless steel, high tensile steel, titanium
ALUMINUM Non-ferrous metals (aluminum, copper, brass, etc.)

COATED ABRASIVES

HIGH DENSITY

DIA	ARBOR	GRIT	MAX RPM	REGULAR DENSITY				HIGH DENSITY			
				ENCORE		ENCORE CERAMIC		OVATION®	OVATION® ATTACKER®	OVATION® CERAMIC	OVATION® STAINLESS
				TYPE 27	TYPE 29	TYPE 27	TYPE 29	TYPE 27	TYPE 27	TYPE 27	TYPE 27
4-1/2"	7/8"	36	13,300	71205	79105	72261	72820	78005	-	78260	78054
4-1/2"	7/8"	40	13,300	71206	79106	72262	72821	78006	76206	78261	78055
4-1/2"	7/8"	60	13,300	71208	79108	72263	72822	78008	76208	78262	78056
4-1/2"	7/8"	80	13,300	71209	79109	72264	72823	78009	76209	78263	78057
4-1/2"	7/8"	120	13,300	71211	79111	-	-	78011	76211	-	78058
4-1/2"	5/8-11	36	13,300	71215	79115	72361	72930	78105	-	78320	78154
4-1/2"	5/8-11	40	13,300	71216	79116	72362	72931	78106	76316	78321	78155
4-1/2"	5/8-11	60	13,300	71218	79118	72363	72932	78108	76318	78322	78156
4-1/2"	5/8-11	80	13,300	71219	79119	72364	72933	78109	76319	78323	78157
4-1/2"	5/8-11	120	13,300	71221	79211	-	-	78111	76321	-	78158
5"	7/8"	36	12,200	71225	79125	-	72827	78025	-	78267	78061
5"	7/8"	40	12,200	71226	79126	-	72828	78026	76226	78268	78062
5"	7/8"	60	12,200	71228	79128	-	72829	78028	76228	78269	78063
5"	7/8"	80	12,200	71229	79129	-	72830	78029	76229	78270	78064
5"	7/8"	120	12,200	71231	79131	-	-	78031	76231	-	78065
5"	5/8-11	36	12,200	71235	-	-	72937	78125	-	78327	-
5"	5/8-11	40	12,200	71236	-	-	72938	78126	76336	78328	-
5"	5/8-11	60	12,200	71238	-	-	72939	78128	76338	78329	-
5"	5/8-11	80	12,200	71239	-	-	72940	78129	76339	78330	-
5"	5/8-11	120	12,200	71241	-	-	-	78131	76341	-	-
6"	7/8"	36	10,200	-	71245	-	-	78035	-	-	-
6"	7/8"	40	10,200	-	71246	-	-	78036	76236	-	-
6"	7/8"	60	10,200	-	71248	-	-	78038	76238	-	-
6"	7/8"	80	10,200	-	71249	-	-	78039	76239	-	-
6"	7/8"	120	10,200	-	71251	-	-	78041	76241	-	-
6"	5/8-11	36	10,200	-	71255	-	-	78135	-	-	-
6"	5/8-11	40	10,200	-	71256	-	-	78136	76346	-	-
6"	5/8-11	60	10,200	-	71258	-	-	78138	76348	-	-
6"	5/8-11	80	10,200	-	71259	-	-	78139	76349	-	-
6"	5/8-11	120	10,200	-	71261	-	-	78141	76351	-	-
7"	7/8"	36	8,500	-	71265	-	-	78045	-	-	-
7"	7/8"	40	8,500	-	71266	-	-	78046	76246	-	-
7"	7/8"	60	8,500	-	71268	-	-	78048	76248	-	-
7"	7/8"	80	8,500	-	71269	-	-	78049	76249	-	-
7"	7/8"	120	8,500	-	71271	-	-	78051	76251	-	-
7"	5/8-11	36	8,500	-	71275	-	-	78145	-	-	-
7"	5/8-11	40	8,500	-	71276	-	-	78146	76356	-	-
7"	5/8-11	60	8,500	-	71278	-	-	78148	76358	-	-
7"	5/8-11	80	8,500	-	71279	-	-	78149	76359	-	-
7"	5/8-11	120	8,500	-	71281	-	-	78151	76361	-	-

QUANTITY:
Packaged
10 per box

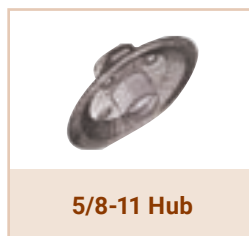
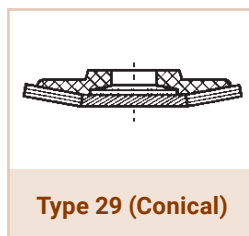
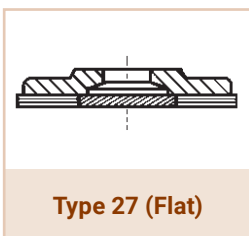

FLAP DISCS - TRIMMABLE PLASTIC BACKING

cf



TRIMBACK™

- Specially designed ABS plastic backing can easily be trimmed away to expose more abrasive material
- Unique design is ideal for hand rail and fillet weld applications
- High performance zirconium grain for a wide variety of applications

METAL Ferrous and/or non-ferrous metals
STAINLESS Stainless steel, high tensile steel, titanium
ALUMINUM Non-ferrous metals (aluminum, copper, brass, etc.)

cf



TRIMBACK™ CERAMIC

- Premium ceramic grain outlasts conventional zirconium in most applications
- Specially designed ABS plastic backing can easily be trimmed away to expose more abrasive material
- Unique design is ideal for hand rail and fillet weld applications

METAL Ferrous and/or non-ferrous metals
STAINLESS Stainless steel, high tensile steel, titanium

cf



TRIMBACK™ STAINLESS

- Premium aluminum oxide with grinding aid for grinding and finishing on stainless steel with minimal discoloration
- Works great on aluminum and non-ferrous materials with minimal loading
- Provides long life while maintaining high stock removal rates
- Trimmable design allows for easy trimming to expose more material

STAINLESS Stainless steel, high tensile alloys, titanium
ALUMINUM Non-ferrous metals (aluminum, copper, brass, etc.)

TRIMBACK DOS & DON'TS

- **DO** trim ONLY TrimBack™ flap discs to expose more abrasive overhang
- **DO** mount the TrimBack™ on a properly guarded right angle grinder
- **DO** apply the plastic backing to a secured metal workpiece while the grinder is running
- **DON'T** trim more than ¼" of the plastic backing
- **DON'T** trim beyond the maximum trim line or the ridged edge of the backing



COATED ABRASIVES

DIA	ARBOR	GRIT	MAX RPM	QTY	TRIMBACK™		TRIMBACK™ CERAMIC		TRIMBACK™ STAINLESS	
					TYPE 27	TYPE 29	TYPE 27	TYPE 29	TYPE 27	TYPE 29
4-1/2"	7/8"	36	13,300	10	70850	70800	70832	70821	70880	70844
4-1/2"	7/8"	40	13,300	10	70851	70801	70833	70822	70881	70845
4-1/2"	7/8"	60	13,300	10	70852	70802	70834	70823	70882	70846
4-1/2"	7/8"	80	13,300	10	70853	70803	70835	70824	70883	70847
4-1/2"	7/8"	120	13,300	10	-	-	-	-	70884	70848
4-1/2"	5/8-11	36	13,300	10	70960	70910	70932	70921	70980	70944
4-1/2"	5/8-11	40	13,300	10	70961	70911	70933	70922	70981	70945
4-1/2"	5/8-11	60	13,300	10	70962	70912	70934	70923	70982	70946
4-1/2"	5/8-11	80	13,300	10	70963	70913	70935	70924	70983	70947
4-1/2"	5/8-11	120	13,300	10	-	-	-	-	70984	70948
5"	7/8"	36	12,200	10	70857	70807	-	70827	-	-
5"	7/8"	40	12,200	10	70858	70808	-	70828	-	-
5"	7/8"	60	12,200	10	70859	70809	-	70829	-	-
5"	7/8"	80	12,200	10	70860	70810	-	70830	-	-

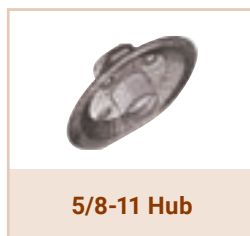
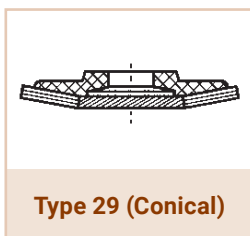
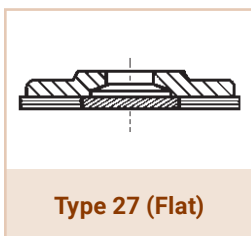

FLAP DISCS - SPECIALTY



SAITLAM UK™

- General purpose
- Zirconium grain on a durable polyester-cotton backing
- Conical shape (Type 29) ideal for working with large surfaces or complex shapes
- Working angle in is "built-in"
- For general purpose stock removal and finishing

STAINLESS Stainless steel, high tensile steel

METAL Ferrous and/or non-ferrous metals

ALUMINUM Non-ferrous metals (aluminum, copper, brass, etc.)

COATED ABRASIVES

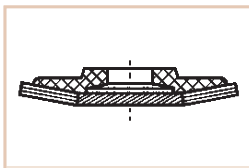

Type 29 (Conical)



Angle Grinder

DIA	ARBOR	GRIT	MAX RPM	QTY	SAITLAM UK™
4"	5/8"	40	15,300	10	73401
4"	5/8"	60	15,300	10	73402
4"	5/8"	80	15,300	10	73403
4"	5/8"	120	15,300	10	73404



ENCORE MINI

- Long life performance of a flap disc for use in confined spaces
- More material, longer life than a single layer laminated disc
- SAIT-LOK-R™ thread allows easy changeover between sanding discs, surface conditioning discs and buffing discs

METAL Ferrous and/or non-ferrous metals

STAINLESS Stainless steel, high tensile steel, titanium

ALUMINUM Non-ferrous metals (aluminum, copper, brass, etc.)



SAIT-LOK-R™

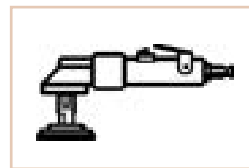

Portable Grinder

DIA	GRIT	MAX RPM	QTY	ENCORE MINI
2"	40	30,000	10	74820
2"	60	30,000	10	74822
2"	80	30,000	10	74823
2"	120	30,000	10	74825
3"	40	20,000	10	74830
3"	60	20,000	10	74832
3"	80	20,000	10	74833
3"	120	20,000	10	74835

See page 132 for SAIT-LOK-R™ backing pads



SAIT GF – GRIND & FINISH

- Combines coated and non-woven abrasives which allows you to “Grind & Finish” with one product reducing time and labor
- Cushioned grinding effect allows for effortless blending and finishing of contoured work pieces
- Aluminum oxide specifications available in coarse, medium and very fine
- Ceramic specification (High Performance) available in 40 grit and 60 grit - provides exceptionally long life

METAL STAINLESS ALUMINUM

DIA	ARBOR	GRADE	GRIT	COATED MATERIAL	SAIT GF
4-1/2"	7/8"	COARSE	60	A/O	77720
4-1/2"	7/8"	MEDIUM	80	A/O	77721
4-1/2"	7/8"	VERY FINE	150	A/O	77723
4-1/2"	7/8"	COARSE	40	CERAMIC	77760
4-1/2"	7/8"	COARSE	60	CERAMIC	77761
5"	7/8"	COARSE	60	A/O	77725
5"	7/8"	MEDIUM	80	A/O	77726
5"	7/8"	VERY FINE	150	A/O	77728
5"	7/8"	COARSE	40	CERAMIC	77766
5"	7/8"	COARSE	60	CERAMIC	77767

COATED ABRASIVES

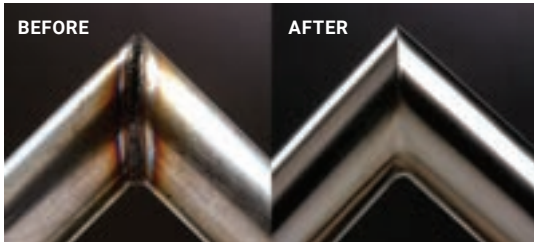

Max RPM	4-1/2": 13,300	5": 12,200
Optimal RPM	4-1/2": 4,000	5": 3,500

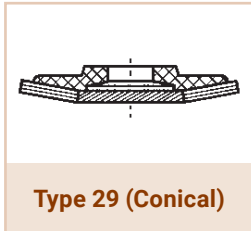

QUANTITY: Packaged 10 per box

TECH INFO

- Ideal for cleaning of weld spatter and light deburring operations
- Operate at lower speeds for optimum performance:
- Optimal RPM: 4-1/2"=4,000, 5"=3,500



SAND-LIGHT™

- Non-woven material
- Layered flaps create a thick, cushioned design which provides a nice finish
- Designed for surface preparation, cleaning and finishing applications

METAL Ferrous metals

STAINLESS Stainless steel, high tensile steel

ALUMINUM Non-ferrous metals

Max RPM	4-1/2": 13,300	5": 12,200
----------------	-----------------------	-------------------

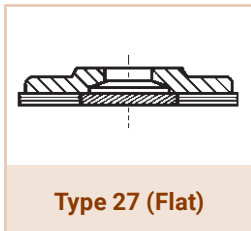

DIA	ARBOR	GRADE	COLOR	SAND-LIGHT™
4-1/2"	7/8"	Coarse	Brown	71980
4-1/2"	7/8"	Medium	Maroon	71982
4-1/2"	7/8"	Very Fine	Blue	71984
5"	7/8"	Coarse	Brown	71990
5"	7/8"	Medium	Maroon	71992
5"	7/8"	Very Fine	Blue	71994

QUANTITY: Packaged 5 per box

FLAP WHEELS - SMALL DIAMETER



2A ALUMINUM OXIDE (GENERAL PURPOSE)

- Premium aluminum oxide grain
- Excellent for cleaning, deburring, polishing, blending

METAL Ferrous and/or non-ferrous metals (iron, steel, aluminum, copper, etc.)

WOOD Wood, plastic, fiberglass, etc.

3A ALUMINUM OXIDE (GRINDING AID)

- Premium aluminum oxide grain with grinding aid
- Excellent for reducing heat build-up on heat sensitive materials
- Excellent for cleaning, deburring, polishing, blending

STAINLESS Stainless steel, high tensile steel, titanium

METAL Ferrous and/or non-ferrous metals



TECH INFO

- Resin over resin construction for a strong bond that is resistant to heat and moisture
- Closed coat structure for more material removal
- High quality Egyptian cotton cloth backing provides superior durability
- UPC bar coded labeled boxes for easy identification and inventory maintenance

DIA	THICKNESS	GRIT	MAX RPM	2A		3A	
				1/4"	1/4-20 Threaded	1/4"	1/4-20 Threaded
1"	3/4"	60	30,000	70001	71000	-	-
1"	3/4"	80	30,000	70002	71001	-	-
1"	3/4"	120	30,000	70003	71002	-	-
1"	3/4"	180	30,000	70004	71003	-	-
1"	3/4"	240	30,000	70005	-	-	-
1"	1"	60	30,000	70010	71010	-	-
1"	1"	80	30,000	70011	71011	-	-
1"	1"	120	30,000	70012	71012	-	-
1"	1"	180	30,000	70013	71013	-	-
1"	1"	240	30,000	70014	71014	-	-
1-1/2"	1/2"	40	25,000	70024	-	-	-
1-1/2"	1/2"	60	25,000	70025	71020	-	-
1-1/2"	1/2"	80	25,000	70026	71021	-	-
1-1/2"	1/2"	120	25,000	70027	71022	-	-
1-1/2"	1/2"	180	25,000	70028	71023	-	-
1-1/2"	1"	60	25,000	70040	71030	-	-
1-1/2"	1"	80	25,000	70041	71031	-	-
1-1/2"	1"	120	25,000	70042	71032	-	-
1-1/2"	1"	180	25,000	70043	71033	-	-
1-1/2"	1"	240	25,000	70044	71034	-	-
2"	1"	40	25,000	70049	-	-	-
2"	1"	60	25,000	70050	71040	74050	71160
2"	1"	80	25,000	70051	71041	74051	71161
2"	1"	120	25,000	70052	71042	74052	71162
2"	1"	180	25,000	70053	71043	-	-
2"	1"	240	25,000	70054	71044	-	-

DIA	THICKNESS	GRIT	MAX RPM	2A		3A	
				1/4"	1/4-20 Threaded	1/4"	1/4-20 Threaded
2-1/2"	1/2"	60	20,000	70060	71050	-	-
2-1/2"	1/2"	80	20,000	70061	71051	-	-
2-1/2"	1/2"	120	20,000	70062	71052	-	-
2-1/2"	1/2"	180	20,000	70063	71053	-	-
2-1/2"	1"	40	20,000	70069	-	-	-
2-1/2"	1"	60	20,000	70070	71055	74060	71170
2-1/2"	1"	80	20,000	70071	71056	74061	71171
2-1/2"	1"	120	20,000	70072	71057	74062	71172
2-1/2"	1"	180	20,000	70073	71058	-	-
2-1/2"	1"	240	20,000	70074	71059	-	-
3"	1/2"	60	20,000	70080	71060	-	-
3"	1/2"	80	20,000	70081	71061	-	-
3"	1/2"	120	20,000	70082	71062	-	-
3"	1/2"	180	20,000	70083	71063	-	-
3"	1/2"	240	20,000	70084	71064	-	-
3"	3/4"	60	20,000	70090	71070	-	-
3"	3/4"	80	20,000	70091	71071	-	-
3"	3/4"	120	20,000	70092	71072	-	-
3"	3/4"	180	20,000	70093	-	-	-
3"	1"	40	20,000	70099	-	-	-
3"	1"	60	20,000	70100	71080	74070	71180
3"	1"	80	20,000	70101	71081	74071	71181
3"	1"	120	20,000	70102	71082	74072	-
3"	1"	180	20,000	70103	71083	-	-
3"	1"	240	20,000	70104	-	-	-
3"	2"	40	10,000	70110	-	-	-
3"	2"	60	10,000	70111	-	-	-
3"	2"	80	10,000	70112	-	-	-
3"	2"	120	10,000	70113	-	-	-

QUANTITY: Packaged 10 per box • Straight 1/4" and threaded 1/4-20 mandrels available. See page 134



2A ALUMINUM OXIDE (GENERAL PURPOSE)

- Premium aluminum oxide grain
- General purpose
- Excellent for cleaning, deburring, polishing, blending

METAL Ferrous metals
ALUMINUM Non-ferrous metals
WOOD Wood, plastic, fiberglass, etc.

3A ALUMINUM OXIDE (GRINDING AID)

- Premium aluminum oxide grain with grinding aid
- Excellent for reducing heat build-up on heat sensitive materials
- Excellent for cleaning, deburring, polishing, blending

STAINLESS Stainless steel, high tensile steel, titanium

ALUMINUM Non-ferrous metals
METAL Ferrous metals

DIA	THICKNESS	SPINDLE	GRIT	QTY	2A	3A
6"	1"	1"	60	5	72000	72005
6"	1"	1"	80	5	72001	72006
6"	1"	1"	100	5	72002	-
6"	1"	1"	120	5	72003	72008
6"	1-1/2"	1"	60	5	72020	72025
6"	1-1/2"	1"	80	5	72021	72026
6"	1-1/2"	1"	120	5	72023	-
6"	2"	1"	60	5	72030	72035
6"	2"	1"	80	5	72031	72036
6"	2"	1"	100	5	72032	-
6"	2"	1"	120	5	72033	72038
8"	1"	1"	60	3	72040	-
8"	1"	1"	120	3	72043	-
8"	2"	1"	60	3	72050	-
8"	2"	1"	80	3	72051	-
8"	2"	1"	120	3	72053	-

Max RPM	6": 6,000	8": 4,400
----------------	------------------	------------------

Straight 1/4" shank adapter kit.
 See page 134



Pedestal Grinder

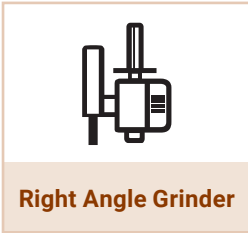

Right Angle Grinder

5/8-11 THREADED FLAP WHEEL

- For use on standard 4-1/2" and 5" angle grinders
- Applies a linear scratch pattern, instead of a swirl; narrow profile is excellent for cleaning weld beads
- Suitable for surface preparation, paint and rust removal, cleaning, and finishing

- Increases the versatility of your angle grinder

STAINLESS Stainless steel, high tensile steel, titanium

METAL Ferrous metals

ALUMINUM Non-ferrous metals

DIA	THICKNESS	ARBOR	GRIT	MAX RPM	QTY	PART #
4-1/2"	3/4"	5/8-11	40	13,300	5	72130
4-1/2"	3/4"	5/8-11	60	13,300	5	72132
4-1/2"	3/4"	5/8-11	80	13,300	5	72133
4-1/2"	3/4"	5/8-11	120	13,300	5	72135
5"	3/4"	5/8-11	40	12,200	5	72140
5"	3/4"	5/8-11	60	12,200	5	72142
5"	3/4"	5/8-11	80	12,200	5	72143
5"	3/4"	5/8-11	120	12,200	5	72145

TECH INFO

- Resin over resin construction for a strong bond that is resistant to heat and moisture
- Closed coat structure for more material removal
- High quality Egyptian cotton cloth backing provides superior durability
- UPC bar coded labeled boxes for easy identification and inventory maintenance



ALUMINUM OXIDE FIBER DISCS

AO (16 - 120 GRIT RANGE)

- Economical choice for general grinding

2A (16 - 120 GRIT RANGE)

- General purpose grinding and finishing
- Closed coat

3A (36 - 120 GRIT RANGE)

- Best for grinding and finishing heat sensitive materials and non-ferrous metals
- Closed coat with grinding aids to reduce heat and loading



ZIRCONIUM FIBER DISCS

AZ-X (24 - 80 GRIT RANGE)

- Economical zirconium fiber disc

Z (24 - 80 GRIT RANGE)

- Closed coat for aggressive grinding and finishing

3Z (24 - 80 GRIT RANGE)

- For aggressive grinding and finishing of heat sensitive materials and non-ferrous metals
- Closed coat with grinding aids to reduce heat and decrease loading



CERAMIC FIBER DISCS

7S (24 - 80 GRIT RANGE)

- High performance ceramic grain, closed coat
- Excels on carbon steel - very uniform, high density, grain structure is extremely durable and self-sharpening for long life and cooler cut

9S (24 - 120 GRIT RANGE)

- High performance ceramic grain, closed coat with grinding aids for reduced heat and decreased loading
- Excels on stainless steel and tough to grind materials

7-II (36+ - 80+ GRIT RANGE)

- Our highest performing disc for carbon steel
- High density ceramic grain for maximum performance

9.3 POWER MAX CERAMIC (36+ - 80+ GRIT RANGE) ****NEW****

- Our highest performing disc for stainless and high alloyed steels
- 100% ceramic abrasive grain for exceptional grinding performance
- Special grinding aids for reduced heat and loading and allows for cool cutting under the most demanding applications



SILICON CARBIDE FIBER DISCS

C SILICON CARBIDE (16 - 220 GRIT RANGE)

- Closed coat for performance grinding and finishing of glass, marble, ceramic, hard cast iron and ferrous/non-ferrous materials



KEY FEATURES

- Most comprehensive fiber discs product offering in the industry (11 types).
- Made with the highest quality materials using a premium resin over resin construction.
- Most renowned fiber discs in the world.



INNOVATIVE BULK PACKAGING

Our unique bulk spindle packaging assures that each disc remains perfectly flat. The unique design offers the convenience of easy access and can be re-tightened to ensure that your discs are flat when you need them.



BLUE LINE™ PACKAGING

Blue Line™ Packaging is UPC bar coded.

Used for retail packaging in convenient smaller quantities.



SAIT-LOK™ QUICK CHANGE 5/8-11 HUB

The SAIT-LOK™ hub recesses into the center cavity of the backing pad to provide a flat profile, thus increasing usable abrasive surface area up to 100% to get the job done faster and cooler.

- Eliminates the need for wrenches and spanner nuts
- Threaded backing pad must be used with SAIT-LOK™ hub
- Available in Blue Line™ packaging only

FIBER DISCS - ALUMINUM OXIDE



AO ALUMINUM OXIDE (ECONOMICAL)

- High-quality aluminum oxide grain, open coat
- Economical choice for general grinding

METAL Ferrous and/or non-ferrous metals (iron, steel, copper, aluminum, etc.)
WOOD Wood, fiberglass

2A ALUMINUM OXIDE (GENERAL PURPOSE)

- High-quality aluminum oxide grain
- General purpose, closed-coat disc for more material removal and better finishing

METAL Ferrous and/or non-ferrous metals
WOOD Wood

3A ALUMINUM OXIDE (GRINDING AID)

- Special aluminum oxide grain with grinding aids to reduce heat build up and minimize loading
- Closed coat for more material removal and better finishing

STAINLESS Stainless steel, high tensile steel, titanium
METAL Ferrous metals
ALUMINUM Non-ferrous metals (aluminum, copper, brass, etc.)

TECH INFO

- Resin over resin construction for a strong bond that is resistant to heat and moisture
- Vulcanized fiber backing for heavy duty sanding
- Available with SAIT-LOK™ quick change hub which extends disc life and requires fewer disc changes

DIA	ARBOR	GRIT	BULK (100 PCS)			BLUE LINE™				SAIT-LOK™ (15 PCS)	
			AO	2A	3A	AO	2A	3A	QTY	2A	3A
4"	5/8"	24	-	56024	-	-	50000	-	25	-	-
4"	5/8"	36	-	56036	-	-	50001	-	25	-	-
4"	5/8"	50	-	56050	-	-	50002	-	25	-	-
4"	5/8"	60	-	56060	-	-	50003	-	25	-	-
4"	5/8"	80	-	56080	-	-	50004	-	25	-	-
4"	5/8"	120	-	56120	-	-	50006	-	25	-	-
4-1/2"	7/8"	16	52416	51022	-	50090	50008	-	25	-	-
4-1/2"	7/8"	24	52424	51024	-	50091	50010	-	25	50120	-
4-1/2"	7/8"	36	52436	51036	52890	50092	50011	50060	25	50121	50148
4-1/2"	7/8"	50	52450	51050	52891	50093	50012	50061	25	50122	50149
4-1/2"	7/8"	60	52460	51060	52892	50094	50013	50062	25	50123	50150
4-1/2"	7/8"	80	52480	51080	52893	50095	50014	50063	25	50124	50151
4-1/2"	7/8"	100	52400	51100	52894	50096	50015	50064	25	50125	50152
4-1/2"	7/8"	120	52420	51120	52895	50097	50016	50065	25	50126	50153
5"	7/8"	16	52516	53016	-	50290	50018	-	25	-	-
5"	7/8"	24	52524	53024	-	50291	50020	-	25	50127	-
5"	7/8"	36	52536	53036	52810	50292	50021	50040	25	50128	50154
5"	7/8"	50	52550	53050	52811	50293	50022	50041	25	50129	50155
5"	7/8"	60	52560	53060	52812	50294	50023	50042	25	50130	50156
5"	7/8"	80	52580	53080	52813	50295	50024	50043	25	50131	50157
5"	7/8"	100	52500	53100	52814	50296	50025	50044	25	50132	50158
5"	7/8"	120	52520	53120	52815	50297	50026	50045	25	50133	50159
7"	7/8"	16	52716	57016	-	50050	50030	-	25	-	-
7"	7/8"	24	52724	57024	-	50051	50031	-	25	50134	-
7"	7/8"	36	52736	57036	52836	50052	50032	50070	25	50135	50160
7"	7/8"	50	52750	57050	52850	50383	50033	50071	25	50136	50161
7"	7/8"	60	52760	57060	52860	50384	50034	50072	25	50137	50162
7"	7/8"	80	52780	57080	52880	50385	50035	50073	25	50138	50163
7"	7/8"	100	52700	57090	52100	50386	50036	50074	25	50139	50164
7"	7/8"	120	52720	57120	52125	50387	50037	50075	25	50140	50165
9-1/8"	7/8"	16	-	58016	-	-	50080	-	20	-	-
9-1/8"	7/8"	24	-	58024	-	-	50081	-	20	50141	-
9-1/8"	7/8"	36	-	58036	-	-	50082	-	20	50142	-
9-1/8"	7/8"	50	-	58050	-	-	50083	-	25	50143	-
9-1/8"	7/8"	60	-	58060	-	-	50084	-	25	50144	-
9-1/8"	7/8"	80	-	58080	-	-	50085	-	25	50145	-
9-1/8"	7/8"	100	-	58090	-	-	50086	-	25	50146	-
9-1/8"	7/8"	120	-	58120	-	-	50087	-	25	50147	-

Bold part numbers are stock items | Blue Line™ Custom Discs minimum order - 100 | SAIT-LOK™ Custom Discs minimum order - 150
 All custom fiber discs are non-cancellable and non-returnable



Angle Grinder

Bold part numbers are stock items
 Blue Line™ Custom Discs min. order qty 100pcs
 SAIT-LOK™ Custom Discs min. order qty 150pcs

Stock and Custom

Spiralcool™ and SAIT-LOK™ backing pads available on page 131.

Backing Pads

See page 73 for packaging descriptions





AZ-X ZIRCONIUM BLEND (ECONOMICAL)

- Zirconium/Aluminum Oxide Blend
- Excellent, economical choice

STAINLESS Stainless steel, high tensile alloys

METAL Ferrous and/or non-ferrous metals (iron, steel, welds, etc.)

Z – ZIRCONIUM (AGGRESSIVE GRINDING)

- Premium zirconium grain, closed coat structure
- Good for aggressive stock removal and long life on a variety of materials

STAINLESS Stainless steel, high tensile alloys

METAL Ferrous and/or non-ferrous metals (iron, steel, welds, etc.)



3Z – ZIRCONIUM (GRINDING AID)

- Premium zirconium grain with grinding aids to reduce heat build up and minimize loading
- Closed coat structure for aggressive stock removal and long life
- Excels on stainless steel, high tensile steel, titanium and aluminum

STAINLESS Stainless steel, high tensile steel, titanium

METAL Ferrous metals

ALUMINUM Non-ferrous metals
(aluminum, copper, brass, etc.)

DIA	ARBOR	GRIT	BULK (100 PCS)			BLUE LINE™			QTY	SAIT-LOK™ (15 PCS)	
			AZ-X	Z	3Z	AZ-X	Z	3Z		Z	3Z
4-1/2"	7/8"	24	69224	59224	58224	60001	59424	58424	25	50166	-
4-1/2"	7/8"	36	69226	59236	58236	60002	59436	58436	25	50167	50187
4-1/2"	7/8"	50	69250	59250	58250	60003	59450	58450	25	50168	50188
4-1/2"	7/8"	60	69260	59260	58260	60004	59460	58460	25	50169	50189
4-1/2"	7/8"	80	69280	59280	58280	60005	59480	58480	25	50170	50190
5"	7/8"	24	69324	59324	58324	60007	59524	58524	25	50171	-
5"	7/8"	36	69336	59336	58336	60008	59536	58536	25	50172	50192
5"	7/8"	50	69350	59350	58350	60009	59550	58550	25	50173	50193
5"	7/8"	60	69360	59360	58360	60010	59560	58560	25	50174	50194
5"	7/8"	80	69380	59380	58380	60011	59580	58580	25	50175	50195
7"	7/8"	24	69624	59624	58624	60071	59724	58724	25	50176	-
7"	7/8"	36	69636	59636	58636	60072	59736	58736	25	50177	50197
7"	7/8"	50	69650	59650	58650	60073	59750	58750	25	50178	50198
7"	7/8"	60	69660	59660	58660	60074	59760	58760	25	50179	50199
7"	7/8"	80	69680	59680	58680	60075	59780	58780	25	50180	50200
9-1/8"	7/8"	24	-	59824	-	-	59924	-	20	50181	-
9-1/8"	7/8"	36	-	59836	-	-	59936	-	20	50182	-

Bold part numbers are stock items | Blue Line™ Custom Discs minimum order - 100 | SAIT-LOK™ Custom Discs minimum order - 150
All custom fiber discs are non-cancellable and non-returnable



Angle Grinder

Bold part numbers are stock items
Blue Line™ Custom Discs min. order qty 100pcs
SAIT-LOK™ Custom Discs min. order qty 150pcs

Stock and Custom

Spiralcool™ and SAIT-LOK™ backing pads available on page 131.

Backing Pads

See page 73 for packaging descriptions

TECH INFO

- Use the zirconium fiber disc for aggressive stock removal on carbon steel
- Resin over resin construction for a strong bond that is resistant to heat and moisture
- Vulcanized fiber backing for heavy duty sanding
- Available with SAIT-LOK™ quick change hub which extends disc life and requires fewer disc changes

FIBER DISCS - CERAMIC



7S CERAMIC (HIGH PERFORMANCE)

- High performance, ceramic grain
- Excellent for carbon steel grinding and finishing

METAL Carbon steel, cast iron



9S CERAMIC (GRINDING AID)

- Excels on heat sensitive materials (stainless steel, etc.) and non-ferrous metals (aluminum, etc.) with an exceptional performance and value
- High performance, ceramic aluminum oxide grain
- Grinding aids for reduced heat and decreased loading

STAINLESS Stainless steel, high tensile steel, titanium

METAL Carbon steel, cast iron

ALUMINUM Non-ferrous metals (aluminum, copper, brass, etc.)

DIA	ARBOR	GRIT	BULK (100 PCS)		BLUE LINE™ (25 PCS)		SAIT-LOK™ (15 PCS)	
			7S	9S	7S	9S	7S	9S
4-1/2"	7/8"	24	57424	51342	57224	50510	50999	50338
4-1/2"	7/8"	36	57436	51343	57225	50511	51000	50339
4-1/2"	7/8"	50	57450	51344	57226	50512	51001	50340
4-1/2"	7/8"	60	57460	51345	57227	50513	51002	50341
4-1/2"	7/8"	80	57480	59113	57228	56313	51003	50342
4-1/2"	7/8"	120	-	59115	-	-	-	50344
5"	7/8"	24	57524	51352	57234	50520	51007	50348
5"	7/8"	36	57536	51353	57235	50521	51008	50349
5"	7/8"	50	57550	51354	57236	50522	51009	50350
5"	7/8"	60	57560	51355	57237	50523	51010	50351
5"	7/8"	80	57580	59133	57238	56333	51011	50352
5"	7/8"	120	-	59135	-	-	-	50354
7"	7/8"	24	57724	51372	57244	50530	51015	50358
7"	7/8"	36	57736	51373	57245	50531	51016	50359
7"	7/8"	50	57750	51374	57246	50532	51017	50370
7"	7/8"	60	57760	51375	57247	50533	51018	50371
7"	7/8"	80	57780	59153	57248	56353	51019	50372
7"	7/8"	120	-	59155	-	-	-	50373

Bold part numbers are stock items | Blue Line™ Custom Discs minimum order - 100 | SAIT-LOK™ Custom Discs minimum order - 150
All custom fiber discs are non-cancellable and non-returnable



Angle Grinder

Bold part numbers are stock items
Blue Line™ Custom Discs
min. order qty 100pcs
SAIT-LOK™ Custom Discs
min. order qty 150pcs

Stock and Custom

Spiralcool™ and
SAIT-LOK™ backing pads
available on page 131.

Backing Pads

See page 73
for packaging
descriptions

TECH INFO

- Resin over resin construction for a strong bond that is resistant to heat and moisture
- Vulcanized fiber backing for heavy duty sanding
- Available with SAIT-LOK™ quick change hub which extends disc life and requires fewer disc changes



7-II CERAMIC (PREMIUM PERFORMANCE)

- Our highest performing disc for carbon steel
- High density ceramic grain for maximum performance

METAL Carbon steel, cast iron

DIA	ARBOR	GRIT	BULK (100 PCS)		SAIT-LOK™ (15 PCS)	
			7-II	9.3	7-II	9.3
4-1/2"	7/8"	36+	56361	58207	56461	58307
4-1/2"	7/8"	50+	56362	58208	56462	58308
4-1/2"	7/8"	60+	56363	58209	56463	58309
4-1/2"	7/8"	80+	56364	58210	56464	58310
5"	7/8"	36+	56367	58211	56467	58311
5"	7/8"	50+	56368	58212	56468	58312
5"	7/8"	60+	56369	58213	56469	58313
5"	7/8"	80+	56370	58214	56470	58314
6"	7/8"	36+	56371	58215	56471	58315
6"	7/8"	60+	56372	58217	56472	58317
7"	7/8"	36+	56373	58219	56473	58319
7"	7/8"	50+	56374	58220	56474	58320
7"	7/8"	60+	56375	58221	56475	58321
7"	7/8"	80+	56376	58222	56476	58322

Bold part numbers are stock items - SAIT-LOK™ Custom Discs minimum order - 150
All custom fiber discs are non-cancellable and non-returnable

9.3 POWER MAX CERAMIC ****NEW**** (PREMIUM PERFORMANCE WITH GRINDING AID)

- Our highest performing disc for stainless and high alloyed steels
- 100% ceramic abrasive grain for exceptional grinding performance
- Special grinding aids for reduced heat and loading and allows for cool cutting under the most demanding applications

STAINLESS Stainless steel, high tensile alloys

METAL Carbon steel, cast iron

ALUMINUM Non-ferrous metals (aluminum, copper, brass, etc.)



C SILICON CARBIDE

- Silicon carbide grain
- Close coat structure for more material removal on various materials
- Recessed center hole helps avoid scratching of the surface

CONCRETE Glass, marble, ceramic, hard cast iron

METAL Ferrous and/or non-ferrous metals

DIA	ARBOR	GRIT	BULK (100 PCS)	BLUE LINE™ (25 PCS)
			C	C
7"	7/8"	16	54016	50100
7"	7/8"	24	54024	50101
7"	7/8"	36	54036	50102
7"	7/8"	60	54060	50104
7"	7/8"	80	54080	50105
7"	7/8"	120	54120	50107
7"	7/8"	220	54220	50110

Bold part numbers are stock items - BLUE LINE™ Custom Discs minimum order - 100
All custom fiber discs are non-cancellable and non-returnable

See page 73 for packaging descriptions

TECH INFO

- Resin over resin construction for a strong bond that is resistant to heat and moisture
- Vulcanized fiber backing for heavy duty sanding
- Available with SAIT-LOK™ quick change hub which extends disc life and requires fewer disc changes



Angle Grinder

Bold part numbers are stock items
Blue Line™ Custom Discs min. order qty 100pcs
SAIT-LOK™ Custom Discs min. order qty 150pcs

Stock and Custom

Spiralcool™ and SAIT-LOK™ backing pads available on page 131.

Backing Pads

STOCK BELTS

ALUMINUM OXIDE CLOTH GENERAL PURPOSE

1A-X / 2A-X ALUMINUM OXIDE - CLOSED COAT

- Semi-friable (1A-X) / heat-treated (2A-X) aluminum oxide grain
- X-weight cotton backing
- For general purpose grinding and finishing

METAL Ferrous and/or non-ferrous metals, cast iron

STAINLESS Stainless steel, high tensile steel alloys

ALUMINUM Aluminum

WOOD Soft and/or hard woods

AO-X ALUMINUM OXIDE - OPEN COAT

- Semi-friable aluminum oxide grain
- X-weight cotton backing
- For general purpose, open coat grinding, polishing and finishing of materials that have a tendency to load

METAL Ferrous and/or non-ferrous metals, cast iron

ALUMINUM Aluminum

WOOD Soft and/or hard woods

SAIT-SAVER™ /

LA-X ALUMINUM OXIDE - ECONOMICAL

- Economic alternative for portable belts
- Economy aluminum oxide, closed coat, X-weight cotton
- For low cost sanding and finishing of ordinary and alloyed steels, ferrous and non-ferrous metals, cast iron, and wood
- A good choice where price and best value is the determining factor
- Shrink-wrapped in quantities of 10

METAL Ferrous and/or non-ferrous metals, cast iron

STAINLESS Stainless steel, high tensile steel alloys

ALUMINUM Aluminum

WOOD Soft and/or hard woods

ZIRCONIA ALUMINA CLOTH PREMIUM

Z-H ZIRCONIA ALUMINA - HEAVY DUTY - CLOSED COAT

- Heavy duty
- Zirconia alumina abrasive material
- H-weight, waterproof polyester backing for heavy duty grinding and finishing

STAINLESS Stainless steel, high tensile steel alloys

METAL Ferrous and/or non-ferrous metals, cast iron

ALUMINUM Aluminum

CERAMIC ALUMINUM OXIDE CLOTH HIGH PERFORMANCE

9S-H CERAMIC ALUMINUM OXIDE (GRINDING AID) ****NEW****

- Excels on heat sensitive materials (stainless steel, etc.) and non-ferrous metals (aluminum, etc.) with an exceptional performance and value
- High performance, ceramic aluminum oxide grain
- Grinding aids for reduced heat and decreased loading

STAINLESS Stainless steel, high tensile alloys, titanium

METAL Carbon steel, cast iron

ALUMINUM Non-ferrous metals
(aluminum, copper, brass, etc.)



Backstand Sander

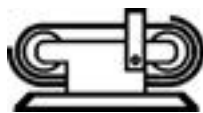

Benchstand Sander

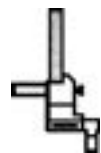

File Sander



Portable Sander

KEY FEATURES

- An expanded selection of the most popular belt sizes and materials in stock and ready to ship
- Available in aluminum oxide, zirconium and ceramic
- All United Abrasives' belts feature a high strength butt joint for maximum strength and long life
- Choose 24 – 50 grits for rough/heavy-duty applications, 60 – 100 for intermediate grinding and sanding, and 100 – 320 for finishing/polishing applications



QUICK SHIP™ (SHRINK-WRAPPED) PACKAGING

SHRINK-WRAPPED IN
QUANTITIES OF 10



BLUE LINE™ PREMIUM PACKAGING

SUPPLIED IN EITHER 5 OR 10
BELTS PER BOX

DESIGNED TO BE DISPLAYED
ON HOOKS OR SHELVING

STOCK BELTS - ALUMINUM OXIDE

1A-X / 2A-X ALUMINUM OXIDE - CLOSED COAT

- Semi-friable (1A-X) / heat-treated (2A-X) aluminum oxide grain
- X-weight cotton backing
- For general purpose grinding and finishing

METAL Ferrous and/or non-ferrous metals, cast iron

STAINLESS Stainless steel, high tensile steel alloys

ALUMINUM Aluminum

WOOD Soft and/or hard woods

QUICK SHIP™ (SHRINK-WRAPPED) PACKAGING

WIDTH	LENGTH	QTY	GRIT											
			24	36	40	50	60	80	100	120	150	180	220	320
1/4"	18"	10	-	60016	60017	60018	60019	60020	60021	60022	-	-	-	-
1/4"	24"	10	-	60030	60031	60032	60033	60034	60035	60036	-	-	-	-
3/8"	13"	10	-	61121	61122	61123	61124	61125	61126	61127	-	-	-	-
1/2"	12"	10	-	60044	60045	60046	60047	60048	60049	60050	-	-	-	-
1/2"	13"	10	-	67374	60100	-	67421	60103	-	-	-	-	-	-
1/2"	18"	10	-	60058	60059	60060	60061	60062	60063	60064	-	-	-	-
1/2"	24"	10	-	60086	60087	60088	60089	60090	60091	60092	-	-	-	-
3/4"	18"	10	-	60114	60115	60116	60117	60118	60119	60120	-	-	-	-
3/4"	20-1/2"	10	-	60128	60129	60130	60131	60132	60133	60134	-	-	-	-
1"	21"	10	-	60254	60255	60256	60257	60258	60259	60260	-	-	-	-
1"	30"	10	-	61094	61095	61096	61097	61098	61099	61100	-	-	-	-
1"	42"	10	-	60310	60311	60312	60313	60314	60315	60316	60317	60318	60319	60322
1-1/2"	60"	10	-	61133	61134	-	61136	61137	61138	61139	-	-	-	-
2"	48"	10	-	60506	60507	60508	60509	60510	60511	60512	-	-	-	-
2"	60"	10	-	60520	60521	60522	60523	60524	60525	60526	-	-	-	-
2"	72"	10	-	60534	60535	60536	60537	60538	60539	60540	-	-	-	-
2"	132"	10	-	60576	60577	60578	60579	60580	60581	60582	-	-	-	-
2-1/2"	48"	10	-	66104	66105	66106	66107	66108	-	66110	-	-	-	-
2-1/2"	60"	10	-	61108	61109	61110	61111	61112	61113	61114	-	-	-	-
3"	132"	10	-	60772	60773	60774	60775	60776	60777	60778	-	-	-	-
3-1/2"	15-1/2"	10	-	61145	61146	61147	61148	61149	61150	61151	-	-	-	-
4"	36"	10	60855	60856	60857	60858	60859	60860	60861	60862	60863	60864	60865	60868
4"	60"	10	-	60222	60223	60224	60225	60226	-	-	-	-	-	-
6"	48"	10	61023	61024	61025	61026	61027	61028	61029	61030	61031	61032	61033	61036
6"	89"	10	-	66190	66191	-	66193	66194	66195	66196	-	-	-	-

BLUE LINE™ PREMIUM PACKAGING

WIDTH	LENGTH	QTY	GRIT											
			24	36	40	50	60	80	100	120	150	180	220	320
3"	18"	10	57100*	57101*	57102*	57103	57104	57105	57106	57107	57108	57109	57110	57113
3"	21"	10	57200*	57201*	57202*	57203	57204	57205	57206	57207	57208	57209	57210	57213
3"	24"	10	57500*	57501*	57502*	57503	57504	57505	57506	57507	57508	57509	57510	57513
4"	24"	10	57900*	57901*	57902*	57903	57904	57905	57906	57907	57908	57909	57910	57913

* Packaging contains quantity of 5 belts

See page 79 for packaging descriptions

AO-X ALUMINUM OXIDE - OPEN COAT

- Semi-friable aluminum oxide grain
- X-weight cotton backing
- For general purpose, open coat grinding, polishing and finishing of materials that have a tendency to load

METAL Ferrous and/or non-ferrous metals, cast iron

ALUMINUM Aluminum

WOOD Soft and/or hard woods

QUICK SHIP™ (SHRINK-WRAPPED) PACKAGING

WIDTH	LENGTH	QTY	GRIT									
			24	36	40	50	60	80	100	120	150	180
3"	18"	10	63230	63231	63232	63233	63234	63235	63236	63237	63238	-
6"	48"	10	63250	63251	63252	63253	63254	63255	63256	63257	63258	63259

BLUE LINE™ PREMIUM PACKAGING

WIDTH	LENGTH	QTY	GRIT									
			24	36	40	50	60	80	100	120	150	180
3"	21"	10	58160*	58161*	58162*	58163	58164	58165	58166	58167	58168	58169
3"	24"	10	58170*	58171*	58172*	58173	58174	58175	58176	58177	58178	58179
4"	21"	10	58180*	58181*	58182*	58183	58184	58185	58186	58187	58188	58189
4"	24"	10	58190*	58191*	58192*	58193	58194	58195	58196	58197	58198	58199

* Packaging contains quantity of 5 belts

SAIT-SAVER™ / LA-X ALUMINUM OXIDE - ECONOMICAL

- Economic alternative for portable belts
- Economy aluminum oxide, closed coat, X-weight cotton
- For low cost sanding and finishing of ordinary and alloyed steels, ferrous and non-ferrous metals, cast iron, and wood
- A good choice where price and best value is the determining factor
- Shrink-wrapped in quantities of 10

METAL Ferrous and/or non-ferrous metals, cast iron

STAINLESS Stainless steel, high tensile steel alloys

ALUMINUM Aluminum

WOOD Soft and/or hard woods

QUICK SHIP™ (SHRINK-WRAPPED) PACKAGING

WIDTH	LENGTH	QTY	GRIT					
			40	50	60	80	100	120
1"	42"	10	60623	60624	60625	60626	60627	60628
2-1/2"	14"	10	63381	63382	63383	63384	63385	63386
3"	21"	10	55342	55343	55344	55345	55346	55347
3"	24"	10	55352	55353	55354	55355	55356	55357
4"	24"	10	55362	55363	55364	55365	55366	55367
4"	36"	10	60663	60664	60665	60666	60667	60668
6"	48"	10	60683	60684	60685	60686	60687	60688

See page 79 for packaging descriptions

STOCK BELTS - ZIRCONIUM

Z-H ZIRCONIA ALUMINA - HEAVY DUTY - CLOSED COAT

- Heavy duty
- Zirconia alumina abrasive material
- H-weight, waterproof polyester backing for heavy duty grinding and finishing

STAINLESS Stainless steel, high tensile steel alloys

METAL Ferrous and/or non-ferrous metals, cast iron

ALUMINUM Aluminum

QUICK SHIP™ (SHRINK-WRAPPED) PACKAGING

WIDTH	LENGTH	QTY	GRIT				
			36	40	50	60	80
1/4"	18"	10	64016	64017	64018	64019	64020
1/4"	24"	10	64030	64031	64032	64033	64034
3/8"	13"	10	66406	66407	66408	66409	66410
1/2"	12"	10	66411	66412	66413	66414	66415
1/2"	18"	10	64058	64059	64060	64061	64062
1/2"	24"	10	64086	64087	64088	64089	64090
3/4"	18"	10	64114	64115	64116	64117	64118
3/4"	20-1/2"	10	64128	64129	64130	64131	64132
1"	30"	10	58147	58148	-	58149	58150
1"	42"	10	58152	58153	58154	58155	58156
1-1/2"	60"	10	66436	66437	-	66439	66440
2"	48"	10	66446	66447	66448	66449	66450
2"	60"	10	64520	64521	64522	64523	64524
2"	72"	10	64534	64535	64536	64537	64538
2"	132"	10	66461	66462	-	66464	66465
2-1/2"	60"	10	65108	65109	65110	65111	65112
3"	79"	10	66472	66473	66474	66475	66476
3"	132"	10	64772	64773	64774	64775	64776
4"	36"	10	66492	66493	-	66495	66496
4"	60"	10	66502	66503	-	66505	-
4"	132"	10	64982	64983	-	64985	-
6"	48"	10	58142	58143	58144	58145	58146

BLUE LINE™ PREMIUM PACKAGING

WIDTH	LENGTH	QTY	GRIT				
			36	40	50	60	80
4"	24"	10	58132*	58133*	58134	58135	58136

* Packaging contains quantity of 5 belts

See page 79 for packaging descriptions

9S-H CERAMIC ALUMINUM OXIDE (GRINDING AID) ****NEW****

- Excels on heat sensitive materials (stainless steel, etc.) and non-ferrous metals (aluminum, etc.) with an exceptional performance and value
- High performance, ceramic aluminum oxide grain
- Grinding aids for reduced heat and decreased loading

STAINLESS Stainless steel, high tensile alloys, titanium

METAL Carbon steel, cast iron

ALUMINUM Non-ferrous metals
(aluminum, copper, brass, etc.)

QUICK SHIP™ (SHRINK-WRAPPED) PACKAGING

WIDTH	LENGTH	QTY	GRIT			
			36	40	60	80
1/4"	18"	10	61201	61202	61203	61204
1/4"	24"	10	61207	61208	61209	61210
3/8"	13"	10	61213	61214	61215	61216
1/2"	12"	10	61219	61220	61221	61222
1/2"	18"	10	61225	61226	61227	61228
1/2"	24"	10	61230	61231	61232	61233
3/4"	18"	10	61235	61236	61237	61238
3/4"	20-1/2"	10	61241	61242	61243	61244
1"	30"	10	61247	61248	61249	61250
1"	42"	10	61253	61254	61255	61256
1-1/2"	60"	10	61259	61260	61261	61262
2"	48"	10	61265	61266	61267	61268
2"	60"	10	61271	61272	61273	61274
2"	72"	10	61277	61278	61279	61280
2-1/2"	60"	10	61283	61284	61285	61286
3"	132"	10	61289	61290	-	-
3-1/2"	15-1/2"	10	61295	61296	61297	61298
4"	24"	10	61301	61302	61303	61304
6"	48"	10	61307	61308	61309	61310

See page 79 for packaging descriptions



6A STEARATED ALUMINUM OXIDE

- Our best economy disc
- Aluminum oxide grain
- Stearate coating and open coat structure lubricates and prevents loading
- Available with Hook & Loop or PSA backing

PAINT Body filler, paint, primers

METAL Ferrous metals

ALUMINUM Non-ferrous metals

WOOD Plastics, wood and fiberglass



3S STEARATED ALUMINUM OXIDE

- EXCELS ON WOOD AND BARE METAL SURFACES
- Aluminum oxide grain – For dry use only
- Stearate coating and open coat structure lubricates and prevents loading
- Available with Hook & Loop or PSA backing

PAINT Body filler, paint, primers

METAL Ferrous metals

ALUMINUM Non-ferrous metals

WOOD Plastics, wood and fiberglass



GOLD STEARATED ALUMINUM OXIDE

- Aluminum oxide grain provides a fast cut with long life
- Stearate coating and semi open coat structure prevents loading – For dry use only
- For automotive body work, removing varnish from wood, sanding fiberglass, and for use on metal
- For use on random orbital or low speed DA sanders
- Available in PSA disc rolls

PAINT Body filler, paint, primers

METAL Ferrous metals

ALUMINUM Non-ferrous metals

WOOD Plastics, wood and fiberglass



4S PREMIUM STEARATED ALUMINUM OXIDE

- EXCELS ON WOOD AND PRIMED SURFACES
- Our best performing, longest lasting paper disc
- Long lasting performance and fast removal rates for fine finishing of auto body, wood, metal, and marine applications
- Premium stearate coating and open coat structure lubricates and prevents loading – For dry use only
- Available with Hook & Loop or PSA backing

PAINT Body filler, paint, primers

METAL Ferrous metals

ALUMINUM Non-ferrous metals

WOOD Plastics, wood and fiberglass



A-E ALUMINUM OXIDE – HEAVY DUTY

- For aggressive sanding, preparation and stock removal
- Aluminum oxide grain for material removal, long life and finishing
- Available with Hook & Loop or PSA backing

WOOD Wood, auto body applications and fiberglass

METAL Ferrous metals and non-ferrous metals



Z-F PREMIUM ZIRCONIUM – HEAVY DUTY

- Best choice for aggressive sanding, preparation and stock removal
- Zirconium grain for aggressive material removal and long life
- Available with Hook & Loop or PSA backing

METAL Ferrous metals and non-ferrous metals

WOOD Wood, auto body applications and fiberglass



6S PREMIUM STEARATED CERAMIC

- BEST IN CLASS – PREMIUM CERAMIC GRAIN
- Premium stearate coating prevents loading
- Fast stock removal with exceptional long life
- Available with Hook & Loop or PSA backing

PAINT Body filler, paint, primers

METAL Ferrous metals

ALUMINUM Non-ferrous metals

WOOD Plastics, wood and fiberglass



C-E/C-F SILICON CARBIDE – HEAVY DUTY

- Premium silicon carbide grain on a tough paper backing
- Designed for fine finishing and long life
- Available with hook & loop backing

CONCRETE Marble, granite, solid surface, ceramics, concrete, plastic

METAL Ferrous metals and non-ferrous metals

PSA PAPER DISCS ROLLS

- PSA paper disc rolls are perforated for easy disc tear away from roll
- Packaged: 4 rolls per box (100 pieces per roll) / Gold Discs: 1 roll per box (100 pieces per roll)



DIA	GRIT	GOLD	6A	3S	4S	6S
5"	80	36500	35410	36800	37800	35310
5"	100	36501	-	36801	37801	35311
5"	120	36502	35412	36802	37802	35312
5"	150	36503	35413	36803	37803	35313
5"	180	36504	35414	36804	37804	35314
5"	220	36505	35415	36805	37805	35315
5"	240	36506	-	-	37806	-
5"	280	-	-	-	37807	-
5"	320	36508	35417	36808	37808	35317
5"	400	36509	-	36809	-	-
6"	80	36600	36410	36900	37900	36310
6"	100	36601	-	36901	37901	36311
6"	120	36602	36412	36902	37902	36312
6"	150	36603	36413	36903	37903	36313
6"	180	36604	36414	36904	37904	36314
6"	220	36605	36415	36905	37905	36315
6"	240	36606	-	-	37906	-
6"	280	-	-	-	37907	-
6"	320	36608	36417	36908	37908	36317
6"	400	36609	-	36909	-	-

COATED ABRASIVES

INDIVIDUAL PSA PAPER DISCS

- Individual PSA paper discs are tabbed for easy removal of release paper



DIA	GRIT	QUANTITY 100				HEAVY DUTY - QTY 50	
		6A	3S	4S	6S	A-E	Z-F
5"	40	-	-	-	-	34150	34110
5"	60	-	-	-	-	34152	34112
5"	80	35400	36520	37505	35300	34153	34113
5"	100	-	36521	37506	35301	-	-
5"	120	35402	36522	37507	35302	34155	34115
5"	150	35403	36523	37508	35303	-	-
5"	180	35404	36524	37509	35304	-	-
5"	220	35405	36525	37510	35305	-	-
5"	320	35407	36528	37511	35307	-	-
5"	400	35408	-	-	35308	-	-
6"	40	-	-	-	-	34170	34130
6"	60	-	-	-	-	34172	34132
6"	80	36400	36620	37605	36300	34173	34133
6"	100	-	36621	37606	36301	-	-
6"	120	36402	36622	37607	36302	34175	34135
6"	150	36403	36623	37608	36303	-	-
6"	180	36404	36624	37609	36304	-	-
6"	220	36405	36625	37610	36305	-	-
6"	320	36407	36628	37611	36307	-	-
6"	400	-	-	-	36308	-	-
8"	40	-	-	-	-	-	34140*
8"	80	-	-	-	-	-	34143*

* 25 per box

TECH INFO

- Strong resin over resin bond construction is resistant to heat and moisture
- Special sharp and durable grain cuts fast and is long lasting
- Pressure sensitive adhesive (PSA) backing allows for quick changes



Disc Sander

For PSA Backing Pads see page 133.

Accessories



HOOK & LOOP PAPER DISCS

- Hook and loop fastening system allows for quick changes and less downtime
- Available with or without vacuum holes for use on random orbital or low speed DA sander with capture systems

NO HOLES

DIA	GRIT	QTY	HEAVY DUTY						
			6A	3S	4S / 4V	6S	A-E	Z-F	C-E / C-F
5"	40	50	-	-	-	-	34250	34210	34510
5"	60	50	-	-	37501	35319	34252	34212	34512
5"	80	50	35420	36540	37515	35320	34253	34213	34513
5"	100	50	-	36541	37516	35321	-	-	34514
5"	120	50	35422	36542	37517	35322	34255	34215	34515
5"	150	50	35423	36543	37518	35323	-	-	34516
5"	180	50	35424	36544	37519	35324	-	-	34517
5"	220	50	35425	36545	37520	35325	-	-	34518
5"	240	50	-	-	37562	-	-	-	-
5"	280	50	-	-	37563	-	-	-	-
5"	320	50	35427	36548	37521	35327	-	-	34521
5"	400	50	35428	-	37522	35328	-	-	34522
5"	500	50	-	-	37523	35360	-	-	34523
5"	600	50	-	-	37524	35361	-	-	34524
5"	800	50	-	-	37550	35362	-	-	34525
5"	1000	50	-	-	37551	-	-	-	-
5"	1200	50	-	-	37552	35364	-	-	34527
5"	1500	50	-	-	37553	-	-	-	-
6"	40	50	-	-	-	-	34270	34230	34610
6"	60	50	-	-	37601	36319	34272	34232	34612
6"	80	50	36420	36640	37615	36320	34273	34233	34613
6"	100	50	-	36641	37616	36321	-	-	34614
6"	120	50	36422	36642	37617	36322	34275	34235	34615
6"	150	50	36423	36643	37618	36323	-	-	34616
6"	180	50	36424	36644	37619	36324	-	-	34617
6"	220	50	36425	36645	37620	36325	-	-	34618
6"	240	50	-	-	37650	-	-	-	-
6"	280	50	-	-	37651	-	-	-	-
6"	320	50	36427	36648	37621	36327	-	-	34621
6"	400	50	36428	-	37622	36328	-	-	34622
6"	500	50	-	-	37623	36360	-	-	34623
6"	600	50	-	-	37624	36361	-	-	34624
6"	800	50	-	-	37625	36362	-	-	34625
6"	1000	50	-	-	37626	-	-	-	-
6"	1200	50	-	-	37627	36364	-	-	34627
6"	1500	50	-	-	37628	-	-	-	-
8"	40	50	-	-	-	-	-	34240	-
8"	80	50	-	-	-	-	-	34243	-

5" - 5 HOLES

DIA	GRIT	QTY	HEAVY DUTY				HD
			6A	3S	4S/4V	6S	A-E
5"	40	50	-	-	-	-	34280
5"	60	50	-	-	37533	35329	34282
5"	80	50	35430	36550	37525	35330	34283
5"	100	50	-	36551	37526	35331	-
5"	120	50	35432	36552	37527	35332	34285
5"	150	50	35433	36553	37528	35333	-
5"	180	50	35434	36554	37529	35334	-
5"	220	50	35435	36555	37530	35335	-
5"	320	50	35437	36558	37531	35337	-
5"	400	50	35438	-	37532	35338	-

5" - 8 HOLES

DIA	GRIT	QTY	HEAVY DUTY				HD
			6A	3S	4S/4V	6S	A-E
5"	40	50	-	-	-	-	34290
5"	60	50	-	-	37534	35339	34292
5"	80	50	35440	36560	37535	35340	34293
5"	100	50	-	36561	37536	35341	-
5"	120	50	35442	36562	37537	35342	34295
5"	150	50	35443	36563	37538	35343	-
5"	180	50	35444	36564	37539	35344	-
5"	220	50	35445	36565	37540	35345	-
5"	320	50	35447	36568	37541	35347	-
5"	400	50	35448	-	37542	35348	-
5"	800	50	-	-	37543	-	-
5"	1000	50	-	-	37544	-	-
5"	1200	50	-	-	37545	-	-
5"	1500	50	-	-	37546	-	-

6" - 6 HOLES

DIA	GRIT	QTY	HEAVY DUTY				HD
			6A	3S	4S/4V	6S	A-E
6"	40	50	-	-	-	-	34310
6"	60	50	-	-	37634	36329	34312
6"	80	50	36430	36650	37635	36330	34313
6"	100	50	-	36651	37636	36331	-
6"	120	50	36432	36652	37637	36332	34315
6"	150	50	36433	36653	37638	36333	-
6"	180	50	36434	36654	37639	36334	-
6"	220	50	36435	36655	37640	36335	-
6"	320	50	36437	36658	37641	36337	-
6"	400	50	36438	-	37642	36338	-
6"	500	50	-	-	-	36339	-
6"	600	50	-	-	-	36340	-
6"	800	50	-	-	37643	36341	-
6"	1000	50	-	-	37644	-	-
6"	1200	50	-	-	37645	36343	-
6"	1500	50	-	-	37646	-	-

For Hook & Loop Backing Pads, Interface Pads, and Contour Hand Pads see page 133.

TECH INFO

- Strong resin over resin bond construction is resistant to heat and moisture
- Special sharp and durable grain cuts fast and is long lasting

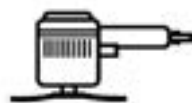

Disc Sander



INDIVIDUAL PSA CLOTH DISCS – ALUMINUM OXIDE

- Aluminum oxide grain
- Strong X-weight Egyptian cotton cloth backing
- Closed coat structure

METAL Ferrous and/non-ferrous metals (iron, steel, aluminum, copper, etc.)

WOOD Wood, plastic, fiberglass

DIA	QTY	GRIT												
		24	36	40	50	60	80	100	120	150	180	220	240	320
1"	50	-	-	-	34990	34991	34992	34993	34994	34995	34996	34997	34998	34999
1-1/2"	50	-	-	-	35003	35004	35005	-	35007	-	-	-	-	-
2"	50	35020	35021	35022	35023	35024	35025	35026	35027	35028	35029	-	35031	35033
3"	50	35040	35041	35042	35043	35044	35045	35046	35047	35048	35049	35050	35051	35053
4"	50	35060	35061	35062	35063	35064	35065	35066	35067	35068	35069	35070	35071	35073
5"	50	35080	35081	35082	35083	35084	35085	35086	35087	35088	35089	35090	35091	35093
6"	50	35094	35095	35096	35097	35098	35099	35100	35101	35102	35103	35104	35105	35107
7"	25	35108	35109	35110	35111	35112	35113	35114	35115	35116	35117	35118	35119	35121
8"	25	35122	35123	35124	35125	35126	35127	35128	35129	35130	35131	35132	35133	35135
9"	25	35136	35137	35138	35139	35140	35141	35142	35143	35144	35145	35146	35147	35149
10"	25	35150	35151	35152	35153	35154	35155	35156	35157	35158	-	-	-	-
12"	25	35164	35165	35166	35167	35168	35169	35170	35171	35172	35173	35174	35175	35177
14"	10	-	35179	35180	35181	35182	35183	-	-	-	-	-	-	-
15"	10	-	35193	35194	35195	35196	35197	-	-	-	-	-	-	-
16"	10	-	35207	35208	35209	35210	35211	35212	35213	-	-	-	-	-
18"	10	-	35221	35222	35223	35224	35225	-	-	-	-	-	-	-
20"	10	-	35235	35236	35237	35238	35239	35240	35241	-	-	-	-	-

COATED ABRASIVES



INDIVIDUAL PSA CLOTH DISCS – ZIRCONIUM

- Premium zirconium grain
- Specially formulated X-weight Egyptian cotton cloth backing
- Closed coat structure

METAL Ferrous and/non-ferrous metals (iron, steel, aluminum, copper, etc.)

STAINLESS Stainless steel, high tensile steel

DIA	QTY	GRIT				
		36	40	50	60	80
5"	50	37081	37082	37083	37084	37085
6"	50	37095	37096	37097	37098	37099
8"	25	37123	37124	37125	37126	37127
9"	25	37137	37138	37139	37140	37141
10"	25	-	-	-	37154	37155
12"	25	37165	37166	37167	37168	37169
20"	10	37235	37236	37237	37238	37239

TECH INFO

- Strong resin over resin bond construction is resistant to heat and moisture
- Hot melt adhesive back allows for quick change and less downtime
- Label UPC bar coded for easy identification and inventory maintenance

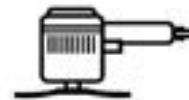

Disc Sander

For PSA Backing Pads see page 133.

Accessories

LAMINATED DISCS



2A ALUMINUM OXIDE (GENERAL PURPOSE)

- Aluminum oxide grain
- General purpose, long life
- Easy disc changes by twisting to unlock backing pad

METAL Ferrous and/or non-ferrous metals

WOOD Wood, plastic, fiberglass, etc.

3A ALUMINUM OXIDE (GRINDING AID)

- Aluminum oxide grain with grinding aid
- Cooling agents for cool cutting and long life
- Easy disc changes by twisting to unlock backing pad

STAINLESS Stainless steel, high tensile alloys

METAL Ferrous metals

ALUMINUM Non-ferrous metals
(aluminum, copper, brass, etc.)

Z -ZIRCONIUM (PREMIUM)

- Premium zirconium grain
- Very fast stock removal, long life
- Easy disc changes by twisting to unlock backing pad

STAINLESS Stainless steel, high tensile alloys

METAL Ferrous and/or non-ferrous metals
(iron, steel, welds, etc.)

3Z – ZIRCONIUM (GRINDING AID)

- Premium zirconium grain with grinding aid
- Cooling agents for cool cutting and long life
- Very fast stock removal, no discoloration
- Easy disc changes by twisting to unlock backing pad

STAINLESS Stainless steel, high tensile alloys

METAL Ferrous and/or non-ferrous metals

TECH INFO

- Triple lamination construction for severe duty applications where traditional discs fray
- Quick change backings make for fast, easy disc changes and less downtime
- Universal style backings fit most major backing pad brands on the market
- 2 ply construction is rugged enough for contoured surfaces or flat surfaces

9S – CERAMIC ALUMINUM OXIDE (GRINDING AID)

- Excels on heat sensitive materials (stainless steel, etc.) and non-ferrous metals (aluminum, etc.) with an exceptional performance and value
- High performance, ceramic aluminum oxide grain
- Grinding aids for reduced heat and decreased loading
- Easy disc changes by twisting to unlock backing pad
- Features unique composite SAIT-Lok™ hub for added strength

STAINLESS Stainless steel, high tensile alloys, titanium

METAL Carbon steel, cast iron

ALUMINUM Non-ferrous metals
(aluminum, copper, brass, etc.)

2A-H ALUMINUM OXIDE (HEAVY DUTY)

- Aluminum oxide grain
- Fast stock removal and excellent edge grain retention
- Triple laminated construction for severe pressure applications where conventional laminated discs have too much flex
- Excellent for edge grinding, deburring, and weld preparation and removal
- Features unique composite SAIT-Lok™ hub for added strength

METAL Ferrous and/or non-ferrous metals

WOOD Wood, plastic, fiberglass, etc.

Z-H ZIRCONIUM (HEAVY DUTY)

- High performance zirconium grain
- Extremely fast stock removal and long life
- Triple laminated construction for severe pressure applications where conventional laminated discs have too much flex
- Excellent for edge grinding, deburring, and weld preparation and removal
- Features unique composite SAIT-Lok™ hub for added strength

METAL Ferrous and/or non-ferrous metals

STAINLESS Stainless steel, high tensile alloys



DIA	GRIT	QTY	HEAVY DUTY														
			2A		3A		Z		3Z		9S		2A-H		Z-H		
			SAIT-LOK™	SAIT-LOK-R™	SAIT-LOK™	SAIT-LOK-R™	SAIT-LOK™	SAIT-LOK-R™	SAIT-LOK™	SAIT-LOK-R™	SAIT-LOK™	SAIT-LOK-R™	SAIT-LOK™	SAIT-LOK-R™	SAIT-LOK™	SAIT-LOK-R™	
1"	36	100	52208	-	50208	-	-	-	-	-	-	-	-	-	-	-	-
1"	40	100	52209	-	50209	-	-	-	-	-	-	-	-	-	-	-	-
1"	50	100	52210	-	50210	-	-	-	-	-	-	-	-	-	-	-	-
1"	60	100	52211	-	50211	-	-	-	-	-	-	-	-	-	-	-	-
1"	80	100	52212	-	-	-	-	-	-	-	-	-	-	-	-	-	-
1"	100	100	52213	-	50213	-	-	-	-	-	-	-	-	-	-	-	-
1"	120	100	52214	-	50214	-	-	-	-	-	-	-	-	-	-	-	-
1-1/2"	36	100	-	52264	50215	50264	55215	55264	-	56264	-	-	-	-	-	-	-
1-1/2"	40	100	52216	52265	-	50265	-	55265	-	-	-	-	-	-	-	-	-
1-1/2"	50	100	52217	52266	50217	-	55217	55266	56217	-	-	-	-	-	-	-	-
1-1/2"	60	100	52218	52267	50218	50267	55218	55267	56218	56267	-	-	-	-	-	-	-
1-1/2"	80	100	52219	52268	50219	50268	55219	-	56219	56268	-	-	-	-	-	-	-
1-1/2"	100	100	52220	52269	-	50269	-	-	-	-	-	-	-	-	-	-	-
1-1/2"	120	100	52221	52270	50221	50270	-	-	-	-	-	-	-	-	-	-	-
2"	24	100	-	-	-	-	55221	55270	-	-	50920	50950	52320	50320	55420	55450	-
2"	36	100	52222	52271	50222	50271	55222	55271	56222	56271	50921	50951	52321	50321	55421	55451	-
2"	40	100	52223	52272	50223	50272	55223	55272	-	-	50922	50952	-	-	-	-	-
2"	50	100	52224	52273	50224	50273	55224	55273	-	56276	50923	50953	52322	50322	55422	55452	-
2"	60	100	52225	52274	50225	50274	55225	55274	56225	56274	50924	50954	52323	50323	55423	55453	-
2"	80	100	52226	52275	50226	50275	55226	55275	56226	56275	50925	50955	52324	50324	55424	55454	-
2"	100	100	52227	52276	50227	50276	-	-	-	-	-	-	-	-	-	-	-
2"	120	100	52228	52277	50228	50277	-	-	-	-	-	-	-	-	-	-	-
3"	24	50	-	-	-	-	55228	55277	-	-	50930	50960	52330	50330	55430	55460	-
3"	36	50	52229	52278	50229	50278	55229	55278	56229	56278	50931	50961	52331	50331	55431	55461	-
3"	40	50	52230	52279	50230	50279	55230	55279	-	-	50932	50962	-	-	-	-	-
3"	50	50	52231	52280	50231	50280	55231	55280	-	56280	50933	50963	52332	50332	55432	55462	-
3"	60	50	52232	52281	50232	50281	55232	55281	56232	56281	50934	50964	52333	50333	55433	55463	-
3"	80	50	52233	52282	50233	50282	55233	55282	56233	56282	50935	50965	52334	50334	55434	55464	-
3"	100	50	52234	52283	50234	50283	-	-	-	-	-	-	-	-	-	-	-
3"	120	50	52235	52284	50235	50284	-	-	-	-	-	-	-	-	-	-	-

COATED ABRASIVES

For Laminated Disc Backing Pads see page 132.



PAPER SHEETS

COATED ABRASIVES



WIDTH	LENGTH	GRIT WEIGHT	QTY	PART #
9"	11"	40D	100	84211
9"	11"	50D	100	84212
9"	11"	60D	100	84213
9"	11"	80D	100	84214
9"	11"	100D	100	84215
9"	11"	120D	100	84216
9"	11"	150C	100	84200
9"	11"	180C	100	84201
9"	11"	220C	100	84202
9"	11"	240C	100	84203
9"	11"	320C	100	84204
9"	11"	400C	100	84205
9"	11"	500C	100	84206
9"	11"	600C	100	84207
9"	11"	800C	100	84208
9"	11"	1200C	100	84209

ALUMINUM OXIDE (AW-C & AW-D)

- Extremely long lasting
- Open coat structure prevents loading
- Use wet or dry

WOOD Wood, sealers, fillers

METAL Ferrous and/or non-ferrous metals



WIDTH	LENGTH	GRIT WEIGHT	QTY	PART #
5-1/2"	9"	1000C	50	84270
5-1/2"	9"	1200C	50	84271
5-1/2"	9"	1500C	50	84274
5-1/2"	9"	2000C	50	84277
9"	11"	80C	100	84249
9"	11"	100C	100	84250
9"	11"	120C	100	84251
9"	11"	150C	100	84252
9"	11"	180C	100	84253
9"	11"	220C	100	84254
9"	11"	240C	100	84255
9"	11"	320C	100	84256
9"	11"	400C	100	84257
9"	11"	500C	100	84258
9"	11"	600C	100	84259
9"	11"	800C	100	84260
9"	11"	1200C	100	84261

WATERPROOF SILICON CARBIDE (CW-C)

- Extremely long lasting
- Closed coat structure for more material removal
- Use wet or dry

WOOD Varnish, plastic, fiberglass, clear coat, primer

CONCRETE Marble, ceramics

METAL Ferrous and/or non-ferrous metals



WIDTH	LENGTH	GRIT WEIGHT	QTY	PART #
9"	11"	50D	50	84101
9"	11"	60C	50	84102
9"	11"	80C	50	84103
9"	11"	100C	100	84104
9"	11"	120C	100	84105
9"	11"	180A	100	84107
9"	11"	220A	100	84108

GARNET

- Natural garnet grain
- Open coat structure prevents loading
- Dry use only

WOOD Soft woods

SAIT-PAK™

- Long-life, non-loading sanding
- Packaged in smaller, easier-to-sell quantities
- Specifically designed for customers desiring more consumer-oriented packaging: skilled craftsmen, professional tradesmen, MRO engineers, fabricators, and the knowledgeable do-it-yourselfers



WOOD Body filler, paint, wood and fiberglass

METAL Ferrous and/or non-ferrous metals

All Purpose Aluminum Oxide Sheets

WIDTH	LENGTH	GRADE / GRIT	QTY	PART #
9"	11"	ASSORTED - 2 Very Fine, 2 Fine, 1 Medium	5	10015
9"	11"	COARSE - 60	5	10006
9"	11"	MEDIUM - 100	5	10008
9"	11"	FINE - 150	5	10010
9"	11"	VERY FINE - 220	5	10012

Waterproof Silicon Carbide Sheets

WIDTH	LENGTH	GRADE / GRIT	QTY	PART #
9"	11"	ASSORTED - 2 Super Fine, 2 Extra Fine, 1 Very Fine	5	10036
9"	11"	VERY FINE - 220	5	10028
9"	11"	EXTRA FINE - 320	5	10031
9"	11"	SUPER FINE - 400	5	10032
9"	11"	ULTRA FINE - 600	5	10034

BACKING WEIGHTS

A

light weight
high flexibility

C

medium weight
medium flexibility

D

heavy weight
low flexibility

TECH INFO

- Resin over resin construction for a strong bond that is resistant to heat and moisture
- Box label UPC bar coded for easy identification and inventory maintenance
- Our highest quality industrial paper for extra durability on all applications
- Broad assortment of grit sizes for a wide range of sanding and finishing applications



Hand Sanding



EXTRA OPEN ALUMINUM OXIDE (AY-D)

- Economical, general purpose paper sheet
- Extra open coat structure prevents loading
- Good flexibility, yet durable backing
- D-Weight - Heavy weight, low flexibility

WOOD Wood, sealers, paint, fillers, plastic materials



STEARATE ALUMINUM OXIDE (3S)

- Extremely long lasting
- Open coat structure prevents loading
- Use dry only
- C-Weight - Medium weight, medium flexibility

WOOD Sealers, body filler, paint, fiberglass, wood

METAL Aluminum



PREMIUM STEARATE ALUMINUM OXIDE (4S)

- Premium aluminum oxide
- Stearate coating and open coat structure lubricates and prevents loading
- Long lasting performance and fast removal rates for fine finishing of automotive body works and wood finishing
- Use dry only
- C-Weight - Medium weight, medium flexibility

WOOD Body filler, paint, wood and fiberglass

METAL Ferrous and/or non-ferrous metals

WIDTH	LENGTH	GRIT	QTY	AY-D	3S	4S
9"	11"	40	100	84422	-	-
9"	11"	60	100	84423	-	-
9"	11"	80	100	84424	84230	84283
9"	11"	100	100	-	84231	84284
9"	11"	120	100	84426	84232	84285
9"	11"	150	100	84427	84233	84286
9"	11"	180	100	84428	84234	84287
9"	11"	220	100	84429	84235	84288
9"	11"	240	100	-	84236	84289
9"	11"	320	100	84430	84237	84290
9"	11"	400	100	84431	84238	84291
9"	11"	500	100	-	84239	-

TECH INFO

- Resin over resin construction for a strong bond that is resistant to heat and moisture
- Box label UPC bar coded for easy identification and inventory maintenance
- Our highest quality industrial paper for extra durability on all applications
- Broad assortment of grit sizes for a wide range of sanding and finishing applications



Hand Sanding

CLOTH SHEETS



ALUMINUM OXIDE (DA-F)

- Aluminum oxide grain on a flexible cloth backing
- Open coat structure prevents loading
- Water resistant
- Long life combined with excellent stock removal
- Excellent for woodworking applications
- F-Weight - High flexibility

WOOD Wood, paint, fiberglass

METAL Ferrous and/or non-ferrous materials (iron, steel, copper, etc.)



WIDTH	LENGTH	GRIT	QTY	DA-F
9"	11"	36	25	84907
9"	11"	40	25	84908
9"	11"	50	25	84909
9"	11"	60	25	84910
9"	11"	80	25	84911
9"	11"	100	50	84912
9"	11"	120	50	84913
9"	11"	150	50	84914
9"	11"	180	50	84915
9"	11"	220	50	84916
9"	11"	240	50	84917
9"	11"	320	50	84918

TECH INFO

- Resin over resin construction for a strong bond that is resistant to heat and moisture
- Cloth backing for durability and flexibility
- Box label UPC bar coded for easy identification and inventory maintenance
- Broad assortment of grit sizes for a wide range of sanding and finishing applications



Hand Sanding

F

High Flexibility

Backing Weight



SAITSCREEN™

- Cloth screen impregnated with silicon carbide grain
- Use wet or dry
- Non-loading
- Strong, long lasting

- WOOD** Body filler, paint, fiberglass
- CONCRETE** Ceramic, marble, cement
- METAL** Ferrous and/or non-ferrous metals

WIDTH	LENGTH	GRIT	QTY	SAITSCREEN™
4-3/16"	11"	80	50	84070
4-3/16"	11"	100	50	84071
4-3/16"	11"	220	50	84075
9"	11"	80	25	84076
9"	11"	100	25	84077
9"	11"	120	25	84078
9"	11"	150	25	84079



PAPER

- Aluminum oxide grain
- Paper backing
- Open coat structure prevents loading
- Use dry
- Provides a smooth finish
- Available in sheets and rolls
- Easy to handle rolls for on the job cut to size use

- WOOD** Plaster, drywall joints

WIDTH	LENGTH	GRIT	QTY	PAPER	
3-5/16"	11"	80	100	84066	
3-5/16"	11"	100	100	84067	
3-5/16"	11"	120	100	84068	
3-5/16"	11"	150	100	84069	
4-3/16"	11"	80	100	84051	
4-3/16"	11"	100	100	84050	
4-3/16"	11"	120	100	84052	
4-3/16"	11"	150	100	84053	
Rolls	3-5/16"	50 YARDS	80	1	84056
	3-5/16"	50 YARDS	100	1	84057
	3-5/16"	50 YARDS	120	1	84058
	3-5/16"	50 YARDS	150	1	84059

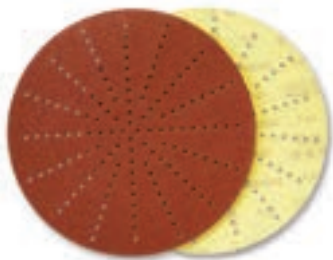

GIRAFFE DRYWALL DISCS

- For use with "giraffe" style drywall sanders
- Premium aluminum oxide abrasive for efficient sanding and long life
- Durable paper backing with hook and loop for enhanced performance and easy grit changes
- Vacuum holes for better dust extraction and life
- Also available without vacuum holes ****NEW****

- WOOD** Plaster, drywall compound, and stucco

DIA	GRIT	QTY	GIRAFFE DRYWALL DISCS	
			HOLES	NO HOLES
9"	40	100	84308	-
9"	60	100	84309	-
9"	80	100	84310	84081
9"	100	100	84311	84082
9"	120	100	84312	84083
9"	150	100	84313	84084
9"	180	100	84314	84085
9"	220	100	84315	84086

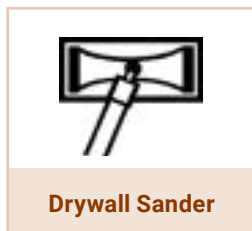

FILE BOARD SHEETS & SPONGES



FILE BOARD SHEETS

- Aluminum oxide grain
- Open coat structure prevents loading

WOOD Auto body filler, paint & fiberglass

METAL Ferrous and/or non-ferrous metals



File Board Sander

WIDTH	LENGTH	GRIT	QTY	FILEBOARD SHEETS
2-3/4"	17-1/2"	40D	50	84171
2-3/4"	17-1/2"	60D	100	84172
2-3/4"	17-1/2"	80D	100	84173
2-3/4"	17-1/2"	100D	100	84174

COATED ABRASIVES

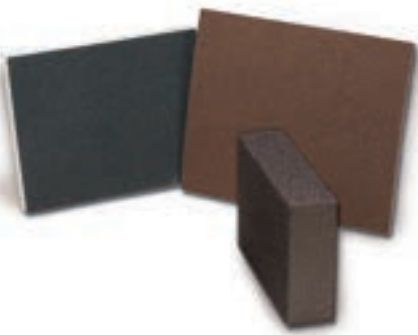

SANDING SPONGES

- Premium abrasive grain on a soft, foam backing
- Foam backing provides ultimate conformability and is washable for long life
- For use on wood moldings, metal contours, drywall sanding, and paint removal applications

WOOD Hardwoods and softwoods, plastic, paint, fiberglass, auto body filler, and drywall compounds

METAL Ferrous and/or non-ferrous metals

TYPE	WIDTH	LENGTH	THICKNESS	GRIT	QTY	SANDING SPONGES
CONTOUR SANDING PAD	4-1/2"	5-1/2"	5MM	60	100	86445
CONTOUR SANDING PAD	4-1/2"	5-1/2"	5MM	100	100	86447
CONTOUR SANDING PAD	4-1/2"	5-1/2"	5MM	180	100	86450
CONTOUR SANDING PAD	4-1/2"	5-1/2"	5MM	280	100	86451
FABRIC REINFORCED SANDING PAD	3-3/4"	4-3/4"	1/2"	60	24	86475
FABRIC REINFORCED SANDING PAD	3-3/4"	4-3/4"	1/2"	100	24	86477
FABRIC REINFORCED SANDING PAD	3-3/4"	4-3/4"	1/2"	150	24	86479
FABRIC REINFORCED SANDING PAD	3-3/4"	4-3/4"	1/2"	180	24	86480
FABRIC REINFORCED SANDING PAD	3-3/4"	4-3/4"	1/2"	220	24	86481
HI-DENSITY SANDING BLOCK	2-1/2"	3-3/4"	1"	60	24	86355
HI-DENSITY SANDING BLOCK	2-1/2"	3-3/4"	1"	80	24	86356
HI-DENSITY SANDING BLOCK	2-1/2"	3-3/4"	1"	100	24	86357
HI-DENSITY SANDING BLOCK	2-1/2"	3-3/4"	1"	120	24	86359
HI-DENSITY SANDING BLOCK	2-1/2"	3-3/4"	1"	180	24	86360

TECH INFO

- Sanding sponges can be used wet or dry for fine finishing and can be washed to extend cutting life (just wash with water)
- In general, the finish of sanding sponges will be finer than traditional coated abrasives
- Due to the ability to conform to different shapes, sanding sponges are able to sand and finish in hard to reach areas



Hand Sanding



Packaged as 1 per box

HANDY ROLL – DA-F

- Aluminum oxide grain
- High quality DA-F material for high flexibility
- Medium tensile strength
- Primarily for hand applications

METAL Ferrous and/or non-ferrous metals
WOOD Wood, fiberglass, etc.



WIDTH	LENGTH	HANDY ROLL – DA-F GRIT											
		40	50	60	80	100	120	150	180	220	240	320	400
1"	50 YDS	80405	80505	80605	80805	81005	81205	81505	81805	82205	82405	83205	83405
1-1/2"	50 YDS	80406	80506	80606	80806	81006	81206	81506	81806	82206	82406	83206	83406
2"	50 YDS	80420	80520	80620	80820	81020	81220	81520	81820	82220	82420	83220	83420

INDUSTRIAL ROLL – EA-F

- Aluminum oxide grain
- Premium quality EA-F material for very high flexibility
- High tensile strength, extra durable backing
- Long life
- Primarily for machine applications

METAL Ferrous and/or non-ferrous metals
WOOD Wood, fiberglass, etc.

WIDTH	LENGTH	INDUSTRIAL ROLL – EA-F GRIT											
		40	50	60	80	100	120	150	180	220	240	320	400
1"	50 YDS	80415	80515	80615	80815	81015	81215	81515	81815	82215	82415	83215	83415
1-1/2"	50 YDS	80416	80516	80616	80816	81016	81216	81516	81816	82216	82416	83216	83416
2"	50 YDS	80430	80530	80630	80830	81030	81230	81530	81830	82230	82430	83230	83430

EA-F CUSTOM ROLLS

- Premium quality EA-F material for very high flexibility used in industrial rolls
- Open coat structure prevents loading
- Can be slit up to 3 cuts, 3" minimum width. Specify widths when ordering

METAL Ferrous and/or non-ferrous metals
WOOD Wood, fiberglass, etc.



WIDTH	LENGTH	CUSTOM ROLLS – EA-F GRIT											
		40	50	60	80	100	120	150	180	220	240	320	400
12"	50 YDS	81640	81650	81660	81680	81610	81612	81615	81618	81622	81624	81632	81604

All custom rolls are non-cancellable and non-returnable

TECH INFO

- Resin over resin construction for a strong bond that is resistant to heat and moisture
- Egyptian cotton cloth backing for superior durability
- Available in two tensile strengths for a wide range of applications
- Open coat structure prevents loading
- Box label UPC bar coded for easy identification and inventory maintenance



Hand Sanding

SPECIALTY SHOP ROLLS

COATED ABRASIVES



DA-F MINI SHOP ROLLS

- Aluminum oxide grain
- High quality DA-F material for high flexibility
- Open coat structure prevents loading
- For hand applications

METAL Ferrous and/or non-ferrous metals

WOOD Wood, fiberglass, etc.

WIDTH	LENGTH	QTY	GRIT			
			60	80	120	180
1-1/2"	10 YDS	1	80607	80807	81207	81807



PLUMBER ROLL

- Aluminum oxide grain
- Open coat structure prevents loading
- Use dry only
- Excellent for cleaning pipe ends
- Cloth backed for durability and flexibility

METAL Ferrous and/or non-ferrous materials, copper piping

WIDTH	LENGTH	GRIT	QTY	PLUMBER ROLL
1-1/2"	25 YDS	120	1	80000



AW-D MINI PAPER ROLLS

- Aluminum oxide grain
- Open coat structure prevents loading
- For wet or dry hand operations

WOOD Wood, paint, etc.

PAINT Body filler, paint, primers

METAL Ferrous and/or non-ferrous metals

WIDTH	LENGTH	GRIT	QTY	AW-D
4-1/2"	5 YDS	40	10	81101
4-1/2"	5 YDS	60	10	81102
4-1/2"	5 YDS	80	10	81103
4-1/2"	5 YDS	100	10	81104
4-1/2"	5 YDS	120	10	81105
4-1/2"	5 YDS	150	10	81106
4-1/2"	5 YDS	180	10	81107
4-1/2"	5 YDS	220	10	81108



SAITSCREEN™ ROLLS

- Silicon carbide grain
- Double sided for long life
- Waterproof
- Non-loading screen cloth

METAL Ferrous and/or non-ferrous metals (steel, solder, copper)

CONCRETE Ceramic

WOOD Wood, paint, etc.

WIDTH	LENGTH	QTY	GRIT		
			80	120	180
1-1/2"	5 YDS	1	84089	84092	84095
1-1/2"	10 YDS	1	84090	84093	84096
1-1/2"	25 YDS	1	84091	84094	84097





FLOOR SANDER BELTS

- Premium zirconium grain for high stock removal and long life
- Belt design allows for quick changing of abrasive materials

WOOD Wood floors

WIDTH	LENGTH	GRIT	QTY	BELTS
8"	19"	36	10	85285
8"	19"	50	10	85286
8"	19"	60	10	85287
8"	19"	80	10	85288
8"	19"	120	10	85289



FLOOR SANDING SHEETS

- Silicon carbide grain
- Combination backing paper and cloth
- **Grits 16-20:** Open coat structure prevents loading and is excellent for removing heavy finishes
- **Grits 36-100:** Closed coat for more material removal and excellent for general refinishing

WOOD Wood

WIDTH	LENGTH	NEW GRIT / OLD GRIT	QTY	SHEETS
8"	19-1/2"	16 / 4	50	85000
8"	19-1/2"	20 / 3-1/2	50	85001
8"	19-1/2"	36 / 2	50	85002
8"	19-1/2"	40 / 1-1/2	50	85003
8"	19-1/2"	60 / 1/2	50	85004
8"	19-1/2"	80 / 0	50	85005
8"	19-1/2"	100 / 2/0	50	85006
8"	20"	16 / 4	50	85007
8"	20"	20 / 3-1/2	50	85008
8"	20"	36 / 2	50	85009
8"	20"	40 / 1-1/2	50	85010
8"	20"	60 / 1/2	50	85011
8"	20"	80 / 0	50	85012
8"	20"	100 / 2/0	50	85013

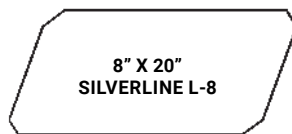
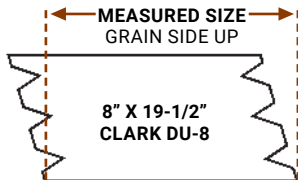

TECH INFO

- Professional quality for use in tough industrial jobs
- Shrink wrapped for easy handling and long life
- Box label UPC bar coded for easy identification and inventory maintenance

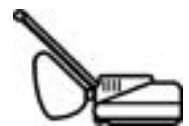

Floor Sander

FLOOR SANDING



EDGE FLOOR SANDING DISCS

- Silicon carbide grain
- Combination backing paper and cloth
- **Grits 12-20:** Open coat structure prevents loading and is excellent for removing heavy finishes
- **Grits 36-100:** Closed coat for more material removal and excellent for general refinishing

WOOD Wood

DIA	ARBOR	QUANTITY 20					QUANTITY 25			
		NEW GRIT / OLD GRIT								
		12 / 4-1/2	16 / 4	20 / 3-1/2	36 / 2	40 / 1-1/2	60 / 1/2	80 / 0	100 / 2/0	
5"	1/4"	85230	85231	85232	85233	85234	85235	85236	85237	
7"	7/8"	85219	85220	85221	85222	85223	85224	85225	85226	



LARGE DIAMETER FLOOR SANDING DISCS

- Silicon carbide grain
- Combination backing paper and cloth
- **Grits 12-20:** Open coat structure prevents loading and is excellent for removing heavy finishes
- **Grits 36-100:** Closed coat for more material removal and excellent for general refinishing

WOOD Wood

DIA	ARBOR	QUANTITY 20					QUANTITY 25			
		NEW GRIT / OLD GRIT								
		12 / 4-1/2	16 / 4	20 / 3-1/2	36 / 2	40 / 1-1/2	60 / 1/2	80 / 0	100 / 2/0	
15"	2"	85121	85100	85101	85102	85103	85104	85105	85106	
16"	2"	85122	85107	85108	85109	85110	85111	85112	85113	
17"	2"	85123	85114	85115	85116	85117	85118	85119	85120	
18"	2"	85130	85131	85132	85133	85134	85135	85136	85137	
20"	2"	85140	85141	85142	85143	85144	85145	85146	85147	

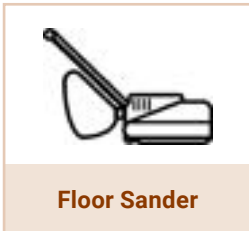

SAITSCREEN™ DISCS

- Cloth screen impregnated with silicon carbide grain
- Long life / Non-loading / Double sided
- Excellent for removing paint and varnish from floors

WOOD Wood

CONCRETE Ceramic tile, cement

DIA	QTY	GRIT			
		60	80	100	120
16"	10	88606	88608	88610	88612
17"	10	88706	88708	88710	88712
18"	10	-	88808	88810	88812
20"	10	88006	88008	88010	88012

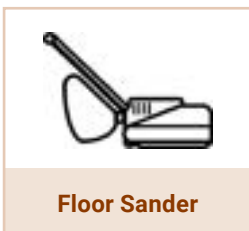



FLOOR SANDING ROLLS

- Silicon carbide grain
- Combination backing paper and cloth
- **Grits 12-20:** Open coat structure prevents loading and is excellent for removing heavy finishes
- **Grits 36-100:** Closed coat for more material removal and excellent for general refinishing

WOOD Wood floors



WIDTH	LENGTH	NEW GRIT	OLD GRIT	QTY	ROLLS
8"	50 YARDS	12	4-1/2	1	85307
8"	50 YARDS	16	4	1	85300
8"	50 YARDS	20	3-1/2	1	85301
8"	50 YARDS	36	2	1	85302
8"	50 YARDS	40	1-1/2	1	85303
8"	50 YARDS	60	1/2	1	85304
8"	50 YARDS	80	0	1	85305
8"	50 YARDS	100	2/0	1	85306



SAITSCREEN™ SHEETS

- Silicon carbide grain
- Long life / Non-loading / Double sided
- Excellent for removing paint and varnish
- Non-gouging for safe use on all floor surfaces
- Popular with DIY homeowners for ease of use
- For orbital sanding machines

WOOD Wood floors

CONCRETE Concrete

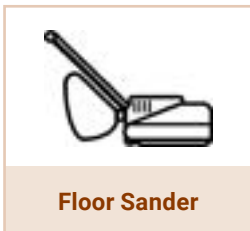

WIDTH	LENGTH	GRIT	QTY	SAITSCREEN™ SHEETS
12"	24"	80	10	88002
12"	24"	100	10	88003

CARTRIDGE ROLLS



STRAIGHT CARTRIDGE ROLLS

- Excellent for sanding and polishing channels, fillets, recesses, side walls, and bottoms of dead-end holes
- Great for high speed deburring and flash removal

METAL Ferrous and/or non-ferrous metals

STAINLESS Stainless steel, high tensile steel

COATED ABRASIVES

BASE DIA	LENGTH	ARBOR	GRIT	MAX RPM	STRAIGHT CARTRIDGE ROLLS (QTY 100)	MANDREL PART #
3/16"	1"	3/32"	80	26,000	38001	95108
3/16"	1"	3/32"	120	26,000	38003	95108
1/4"	1"	1/8"	60	26,000	38007	95105
1/4"	1"	1/8"	80	26,000	38008	95105
1/4"	1"	1/8"	120	26,000	38010	95105
1/4"	1"	1/8"	320	26,000	38013	95105
1/4"	1-1/2"	1/8"	60	26,000	38014	95104
1/4"	1-1/2"	1/8"	80	26,000	38015	95104
1/4"	1-1/2"	1/8"	120	26,000	38017	95104
1/4"	1-1/2"	1/8"	240	26,000	38019	95104
3/8"	1"	1/8"	60	26,000	38040	95105
3/8"	1"	1/8"	80	26,000	38041	95105
3/8"	1"	1/8"	120	26,000	38043	95105
3/8"	1-1/2"	1/8"	50	26,000	38047	95104
3/8"	1-1/2"	1/8"	60	26,000	38048	95104
3/8"	1-1/2"	1/8"	80	26,000	38049	95104
3/8"	1-1/2"	1/8"	120	26,000	38051	95104
3/8"	2"	1/8"	60	26,000	38055	95103
3/8"	2"	1/8"	80	26,000	38056	95103
1/2"	1"	1/8"	50	26,000	38062	95105
1/2"	1"	1/8"	60	26,000	38063	95105
1/2"	1"	1/8"	80	26,000	38064	95105
1/2"	1"	1/8"	120	26,000	38066	95105

See page 135 for Cartridge Roll Mandrels

BASE DIA	LENGTH	ARBOR	GRIT	MAX RPM	STRAIGHT CARTRIDGE ROLLS (QTY 100)	MANDREL PART #
1/2"	1-1/2"	1/8"	36	26,000	38070	95104
1/2"	1-1/2"	1/8"	40	26,000	38071	95104
1/2"	1-1/2"	1/8"	50	26,000	38072	95104
1/2"	1-1/2"	1/8"	60	26,000	38073	95104
1/2"	1-1/2"	1/8"	80	26,000	38074	95104
1/2"	1-1/2"	1/8"	120	26,000	38076	95104
1/2"	2"	1/8"	60	26,000	38080	95103
1/2"	2"	1/8"	80	26,000	38081	95103
1/2"	2"	1/8"	120	26,000	38083	95103
1/2"	2"	3/16"	60	26,000	38087	95106
1/2"	2"	3/16"	80	26,000	38088	95106
1/2"	2"	3/16"	120	26,000	38089	95106
5/8"	1-1/2"	1/8"	60	18,000	38093	95104
5/8"	1-1/2"	1/8"	80	18,000	38094	95104
5/8"	1-1/2"	1/8"	120	18,000	38095	95104
3/4"	1-1/2"	3/16"	40	18,000	38112	95107
3/4"	1-1/2"	3/16"	60	18,000	38113	95107
3/4"	1-1/2"	3/16"	80	18,000	38114	95107
3/4"	2"	3/16"	40	18,000	38119	95106
3/4"	2"	3/16"	60	18,000	38120	95106
3/4"	2"	3/16"	80	18,000	38121	95106
3/4"	2"	3/16"	120	18,000	38122	95106
1"	1-1/2"	1/4"	60	18,000	38126	95102
1"	1-1/2"	1/4"	80	18,000	38127	95102
1"	1-1/2"	1/4"	120	18,000	38128	95102
1"	2"	1/4"	60	18,000	38132	95101
1"	2"	1/4"	80	18,000	38133	95101
1"	2"	1/4"	120	18,000	38134	95101

TECH INFO

- Multi-layer, self-dressing construction - exposes sharp, new cutting abrasive as each layer wears away
- Available in straight and full taper designs - long lasting performance
- Quick removal and installation - less downtime



Cartridge Roll



Die Grinder

TAPERED CARTRIDGE ROLLS

- Excellent for sanding and polishing channels, fillets, recesses, side walls, and bottoms of dead-end holes
- Great for high speed deburring and flash removal

METAL Ferrous and/or non-ferrous metals

STAINLESS Stainless steel, high tensile steel



See page 135 for Cartridge Roll Mandrels

BASE DIA	LENGTH	ARBOR	GRIT	MAX RPM	TAPERED CARTRIDGE ROLLS (QTY 100)	MANDREL PART #
3/8"	1"	1/8"	60	26,000	38300	95105
3/8"	1"	1/8"	80	26,000	38301	95105
3/8"	1"	1/8"	120	26,000	38302	95105
3/8"	1-1/2"	1/8"	60	26,000	38306	95104
3/8"	1-1/2"	1/8"	80	26,000	38307	95104
3/8"	1-1/2"	1/8"	120	26,000	38308	95104
1/2"	1"	1/8"	60	26,000	38312	95105
1/2"	1"	1/8"	80	26,000	38313	95105
1/2"	1"	1/8"	120	26,000	38314	95105
1/2"	1-1/2"	1/8"	50	26,000	38318	95104
1/2"	1-1/2"	1/8"	60	26,000	38319	95104
1/2"	1-1/2"	1/8"	80	26,000	38320	95104
1/2"	1-1/2"	1/8"	120	26,000	38322	95104
1/2"	2"	1/8"	60	26,000	38326	95103
1/2"	2"	1/8"	80	26,000	38327	95103
1/2"	2"	1/8"	120	26,000	38328	95103
5/8"	2"	1/8"	60	18,000	38332	95103
5/8"	2"	1/8"	80	18,000	38333	95103
3/4"	1-1/2"	1/8"	60	18,000	38338	95104
3/4"	1-1/2"	1/8"	80	18,000	38339	95104
3/4"	1-1/2"	1/8"	120	18,000	38340	95104
3/4"	2"	3/16"	60	18,000	38344	95106
3/4"	2"	3/16"	80	18,000	38345	95106
3/4"	2"	3/16"	120	18,000	38346	95106

TECH INFO

- Multi-layer, self-dressing construction - exposes sharp, new cutting abrasive as each layer wears away
- Available in straight and full taper designs - long lasting performance
- Quick removal and installation - less downtime

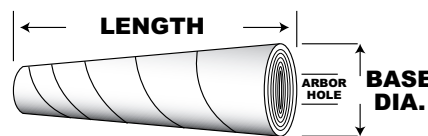

Cartridge Roll



Die Grinder

SPIRAL BANDS



See page 135 for Spiral Band Drums

SPIRAL BANDS

- Premium aluminum oxide grain
- Excellent for removing parting lines, imperfections and burrs on all surfaces
- Great in curved, corner, contoured and hard to reach areas

METAL Ferrous and/or non-ferrous metals

STAINLESS Stainless steel, high tensile steel, wood

DIA	LENGTH	GRIT	MAX RPM	QTY	SPIRAL BANDS
1/2"	1/2"	60	30,000	100	42001
1/2"	1/2"	80	30,000	100	42002
1/2"	1/2"	120	30,000	100	42003
1/2"	1"	60	15,000	100	42006
1/2"	1"	80	15,000	100	42007
1/2"	1"	120	15,000	100	42008
1/2"	1-1/2"	60	12,000	100	42011
1/2"	1-1/2"	80	12,000	100	42012
1/2"	1-1/2"	120	12,000	100	42013
3/4"	1"	36	19,000	100	42016
3/4"	1"	60	19,000	100	42017
3/4"	1"	80	19,000	100	42018
3/4"	1"	120	19,000	100	42019
3/4"	1-1/2"	60	10,000	100	42022
3/4"	1-1/2"	80	10,000	100	42023
3/4"	1-1/2"	120	10,000	100	42024
1"	1"	36	18,000	100	42027
1"	1"	60	18,000	100	42028
1"	1"	80	18,000	100	42029
1"	1"	120	18,000	100	42030
1-1/2"	1"	36	14,000	100	42033
1-1/2"	1"	60	14,000	100	42034
1-1/2"	1"	80	14,000	100	42035
1-1/2"	1"	120	14,000	100	42036
1-1/2"	1-1/2"	36	10,000	100	42039
1-1/2"	1-1/2"	60	10,000	100	42040
1-1/2"	1-1/2"	80	10,000	100	42041
1-1/2"	1-1/2"	120	10,000	100	42042
2"	2"	36	6,000	50	42045
2"	2"	60	6,000	50	42046
2"	2"	80	6,000	50	42047
2"	2"	120	6,000	50	42048
3"	3"	36	3,000	50	42051
3"	3"	60	3,000	50	42052
3"	3"	80	3,000	50	42053
3"	3"	120	3,000	50	42054



Die Grinder

TECH INFO

- Single ply of coated abrasive, spirally wound and bonded to an inner liner
- Quick removal and installation
- Smooth running for ease of use and control



CROSS PADS

- Premium aluminum oxide grain
- Excellent for deburring tubing, blending radii, polishing inside contours and polishing and finishing bell-mouth configurations, drop forge and Kirksite dies

METAL Ferrous and/or non-ferrous metals

STAINLESS Stainless steel, high tensile steel

DIA	THICKNESS	MANDREL	GRIT	RECOMMENDED RPM RANGE	MAX RPM	CROSS PADS (QTY 50)
1"	3/8"	3-48	60	20,000 - 23,000	25,000	48036
1"	3/8"	3-48	80	20,000 - 23,000	25,000	48037
1"	3/8"	3-48	120	20,000 - 23,000	25,000	48038
1-1/2"	1/2"	8-32	60	19,000 - 20,000	23,000	48041
1-1/2"	1/2"	8-32	80	19,000 - 20,000	23,000	48042
2"	1/2"	8-32	60	19,000 - 20,000	23,000	48046
2"	1/2"	8-32	80	19,000 - 20,000	23,000	48047
2"	1/2"	8-32	120	19,000 - 20,000	23,000	48048
2"	1"	1/4-20	60	19,000 - 20,000	23,000	48051
2"	1"	1/4-20	80	19,000 - 20,000	23,000	48052
2"	1"	1/4-20	120	19,000 - 20,000	23,000	48053
3"	1"	1/4-20	60	10,000 - 12,000	14,000	48056
3"	1"	1/4-20	80	10,000 - 12,000	14,000	48057
3"	1"	1/4-20	120	10,000 - 12,000	14,000	48058
4"	1"	1/4-20	60	9,000 - 10,000	14,000	48061
4"	1"	1/4-20	80	9,000 - 10,000	14,000	48062
4"	1"	1/4-20	120	9,000 - 10,000	14,000	48063



SQUARE PADS

- Premium aluminum oxide grain
- Excellent for deburring tubing, blending radii, polishing inside contours and polishing and finishing bell-mouth configurations, drop forge and Kirksite dies

METAL Ferrous and/or non-ferrous metals

STAINLESS Stainless steel, high tensile steel

DIA	THICKNESS	MANDREL	GRIT	RECOMMENDED RPM RANGE	MAX RPM	SQUARE PADS (QTY 50)
1-1/2"	1/2"	1/4-20	60	19,000 - 20,000	23,000	48006
1-1/2"	1/2"	1/4-20	80	19,000 - 20,000	23,000	48007
1-1/2"	1/2"	1/4-20	120	19,000 - 20,000	23,000	48008
2"	1/4"	8-32	60	19,000 - 20,000	23,000	48011
2"	1/4"	8-32	80	19,000 - 20,000	23,000	48012
2"	1/2"	1/4-20	60	19,000 - 20,000	23,000	48016
2"	1/2"	1/4-20	80	19,000 - 20,000	23,000	48017
2"	1/2"	1/4-20	120	19,000 - 20,000	23,000	48018
2"	3/4"	1/4-20	60	19,000 - 20,000	23,000	48021
2"	3/4"	1/4-20	80	19,000 - 20,000	23,000	48022
3"	1/4"	1/4-20	60	10,000 - 12,000	14,000	48026
3"	1/4"	1/4-20	80	10,000 - 12,000	14,000	48027
3"	1/4"	1/4-20	120	10,000 - 12,000	14,000	48028
3"	1/2"	1/4-20	60	10,000 - 12,000	14,000	48031
3"	1/2"	1/4-20	80	10,000 - 12,000	14,000	48032
3"	1/2"	1/4-20	120	10,000 - 12,000	14,000	48033



See page 135 for Cross Pad and Square Pad Mandrels

TECH INFO

- Multi-ply abrasive pad - exposes new cutting surface as each layer wears
- Cushioned, chatter free grinding and polishing for long lasting performance



Die Grinder

NON-WOVEN ABRASIVES INDEX

NON-WOVEN HAND PADS	106
NON-WOVEN BELTS	107
DEBURRING & CLEANING DISCS	108
SURFACE CONDITIONING DISCS - SAIT-LOK™ & SAIT-LOK-R™	108
ULTIMATE PERFORMANCE SURFACE CONDITIONING DISCS - SAIT-LOK™ & SAIT-LOK-R™	108
HOOK & LOOP	108
ULTIMATE PERFORMANCE DISCS WITH ARBOR HOLE	108
SAND-LIGHT™ BLENDING DISCS	109
SAIT-LOK™	109
HOOK & LOOP	109
WITH ARBOR HOLE	109
FLAP BRUSHES & GF LINEAR POLISHING WHEELS	110
FLAP BRUSH	110
GRIND AND FINISH NON-WOVEN LINEAR POLISHING WHEELS	110
GRIND AND FINISH INTERLEAF LINEAR POLISHING WHEELS	110
FLAP WHEELS & INTERLEAF WHEELS	111
FLAP WHEEL	111
INTERLEAF WHEEL	111
INTERLEAF & NON-WOVEN FLAP DISCS	112
SAIT GF – GRIND AND FINISH	112
SAND-LIGHT™	112
SAIT-STRIP™	113
SAIT-LOK™ & SAIT-LOK-R™ **NEW**	113
ARBOR HOLE DISCS	113
SAIT-STRIP™ TYPE 27 **NEW**	113
UNITIZED WHEELS	114
UNITIZED WHEELS	114
TYPE 27 UNITIZED DISCS	114
CONVOLUTE WHEELS & BUFFING ITEMS	115
CONVOLUTE WHEEL	115
BUFFING DISCS	115



NON-WOVEN ABRASIVES



NON-WOVEN HAND PADS



BROWN – HEAVY DUTY

- Excellent for removing heavy rust and cleaning welds

METAL Ferrous metals

ALUMINUM Non-ferrous metals

MAROON – GENERAL PURPOSE

- For removing light rust
- Excellent for cleaning and brightening

METAL Ferrous metals

ALUMINUM Non-ferrous metals

BLACK – STAINLESS

- For blending and finishing
- Excellent for paint removal

STAINLESS Stainless steel

METAL Ferrous metals

ALUMINUM Non-ferrous metals

GREEN – GENERAL CLEANING

- Excellent for stripping paint and varnish

METAL Ferrous metals

ALUMINUM Non-ferrous metals

WOOD Paint, varnish

GRAY – ULTRA FINE

- For light finishing
- Excellent for sanding before/between finish coats

METAL Ferrous metals

ALUMINUM Non-ferrous metals

WOOD Wood

WHITE – LIGHT DUTY

- For light cleaning and polishing

WOOD Fiberglass, vinyl, plastic

CONCRETE Ceramic

ALUMINUM Non-ferrous metals



HAND PADS

- Non-woven synthetic fiber impregnated with abrasive grain for surface conditioning without damage to or removal of base material. Resists loading and heat build-up
- Wet/dry construction for use in a wide range of applications
- Available in a variety of grades from heavy duty to polishing applications
- Reusable and long lasting design for economical use
- Box label UPC bar coded for easy identification and inventory maintenance

WIDTH	LENGTH	COLOR	GRADE	QTY	HAND PADS
6"	9"	BROWN	HEAVY DUTY	20	77440
6"	9"	MAROON	GENERAL	20	77447
6"	9"	BLACK	STAINLESS	20	77446
6"	9"	GREEN	SCOURING	20	77496
6"	9"	GRAY	ULTRA FINE	20	77448
6"	9"	WHITE	LIGHT DUTY	20	77486



Hand Sanding

**HANDLE AVAILABLE
FOR UNIFORM
FINISHING ON
PAGE 136**

Handle



BELTS

- Non-woven synthetic fiber impregnated with abrasive grain for surface conditioning without damage to or removal of base material. Resists loading and heat build-up
- Offered in very narrow widths for use on tight radii and hard to reach applications
- Flexible yet extra durable splice method for resistance to breaking or cracking under severe stress

STAINLESS Stainless steel

METAL Ferrous metals

ALUMINUM Non-ferrous metals

WOOD Fiberglass and rubber

WIDTH	LENGTH	QTY	COARSE BROWN	MEDIUM MAROON	VERY FINE BLUE
1/2"	18"	10	77510	77511	77512
1/2"	24"	10	77515	77516	77517
3/4"	18"	10	77520	77521	77522
3/4"	20-1/2"	10	77575	77576	77577
2"	60"	10	77535	-	-
3"	21"	10	77570	77571	77572
3"	24"	10	77560	77561	77562
3-1/2"	15-1/2"	10	77500	77501	77502
4"	24"	10	-	77566	-
6"	48"	5	77540	77541	-

BROWN – COARSE

- Excellent for deburring, blending
- For use on mill marks, tool marks, to create a smooth transition on surface profiles

STAINLESS Stainless steel

METAL Ferrous metals

ALUMINUM Non-ferrous metals

WOOD Fiberglass and rubber

MAROON – GENERAL PURPOSE

- Excellent for blending and cleaning
- Reduce uneven edges on adjoining surfaces
- Remove coatings, gaskets and surface discolorations

STAINLESS Stainless steel

METAL Ferrous metals

ALUMINUM Non-ferrous metals

WOOD Fiberglass and rubber

BLUE – VERY FINE

- Excellent for cleaning and finishing
- Reduce surface roughness
- Polish welds
- Use to apply cosmetic grain or scratch patterns

STAINLESS Stainless steel

METAL Ferrous metals

ALUMINUM Non-ferrous metals

WOOD Fiberglass and rubber

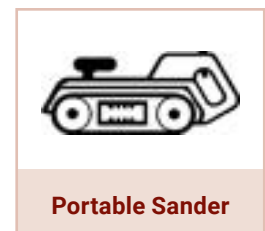

DEBURRING & CLEANING DISCS

SURFACE CONDITIONING DISCS

- Used in a wide variety of applications including cleaning, polishing, blending and deburring
- Non-woven synthetic fiber coated with aluminum oxide grain resists loading for long life without damage to or removal of base material

- STAINLESS** Stainless steel
METAL Ferrous and/or non-ferrous metals
WOOD Fiberglass, gaskets



ULTIMATE PERFORMANCE SURFACE CONDITIONING DISCS

- High durability with superior edge retention and minimal smearing
- For aggressive applications where traditional surface conditioning products fail
- Ideal for highly contoured surfaces, heavy blending and finishing, and sharp edges

- STAINLESS** Stainless steel
METAL Ferrous and/or non-ferrous metals
WOOD Fiberglass, gaskets

AVAILABLE IN THREE FINISHES

COARSE (BROWN)

- Excellent for heavy deburring, removing weld spatter and blending tool/mill marks, rust removal

MEDIUM (MAROON)

- Excellent for light deburring, blending scratch patterns, removing coating/adhesives

VERY FINE (BLUE)

- Excellent for cosmetic grain finishing, polishing welds and reducing grinding marks

AVAILABLE IN TWO STYLES



SAIT-LOK™
Nylon attachment on disc ensures a secure fit to the backing pad



SAIT-LOK-R™
Nylon screw threaded hub for easy mounting to the backing pad

NON-WOVEN

DIA	QTY	COARSE BROWN		MEDIUM MAROON		VERY FINE BLUE		ULTIMATE PERFORMANCE COARSE		ULTIMATE PERFORMANCE MEDIUM	
		SAIT-LOK™	SAIT-LOK-R™	SAIT-LOK™	SAIT-LOK-R™	SAIT-LOK™	SAIT-LOK-R™	SAIT-LOK™	SAIT-LOK-R™	SAIT-LOK™	SAIT-LOK-R™
1-1/2"	50	77200	77300	77202	77302	77203	77303	-	-	-	-
2"	50	77206	77306	77208	77308	77209	77309	77260	77360	77261	77361
3"	25	77212	77312	77214	77314	77215	77315	77264	77364	77265	77365
4"	25	-	77318	-	77320	-	77321	-	-	-	-



Portable Grinder

See page 132 for backing pads

HOOK & LOOP

- Hook & Loop fastening system allows for quick changes and less downtime



DIA	QTY	COARSE BROWN	MEDIUM MAROON	VERY FINE BLUE
4"	10	77116	77117	77115
4-1/2"	10	77118	77120	77122
5"	10	77124	77126	77128
6"	10	77130	77132	77134
7"	10	77136	77138	77140
8"	10	77142	-	77146



Portable Grinder

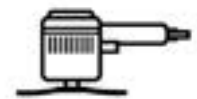

Disc Sander

See page 136 for backing pads

ULTIMATE PERFORMANCE DISCS WITH ARBOR HOLE

- For use with right angle grinder utilizing fiber disc backing pads



DIA	ARBOR	MAX RPM	QTY	ULTIMATE PERFORMANCE COARSE	ULTIMATE PERFORMANCE MEDIUM
4-1/2"	7/8"	10,500	20	77648	77649
5"	7/8"	9,650	20	77652	77653
7"	7/8"	6,800	20	77661	77662



Angle Grinder

See page 131 for fiber disc backing pads

SAND-LIGHT™ BLENDING DISCS

- For minor finishing and blending applications
- Less aggressive cutting than traditional surface conditioning discs
- Great for final finishing prior to buffing with compounds
- Use the slowest speed possible for optimum results
- Available in three styles shown below: SAIT-LOK™, Hook & Loop and with Arbor Hole



AVAILABLE IN TWO FINISHES

MEDIUM – GENERAL PURPOSE

- Excellent for blending surface imperfections, coated abrasives sanding scratches
- Use the Medium grade for light finishing after using surface conditioning discs

VERY FINE

- Excellent for blending surface imperfections, final finishing and preparation prior to coating
- Use the Very Fine grade followed by the SAIT Buffing Discs and compounds for a near mirror finish

ALUMINUM Aluminum

STAINLESS Stainless steel

METAL Ferrous and/or non-ferrous metals

SAIT-LOK™

- Nylon attachment on disc ensures a secure fit to the backing pad



SAIT-LOK™

Portable Grinder

Disc Sander

See page 132 for backing pads

DIA	GRADE	QTY	SAIT-LOK™
2"	MEDIUM	50	77672
2"	VERY FINE	50	77675
3"	MEDIUM	25	77682
3"	VERY FINE	25	77685

HOOK & LOOP

- Hook & Loop fastening system allows for quick changes and less downtime

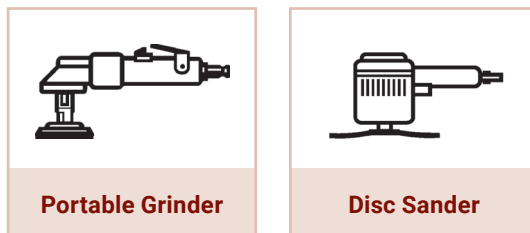

Portable Grinder

Disc Sander

See page 136 for backing pads

DIA	GRADE	QTY	HOOK & LOOP
5"	MEDIUM	10	77382
5"	VERY FINE	10	77385
6"	MEDIUM	10	77392
6"	VERY FINE	10	77395

WITH ARBOR HOLE

- Arbor hole for easy mounting to grinder shaft

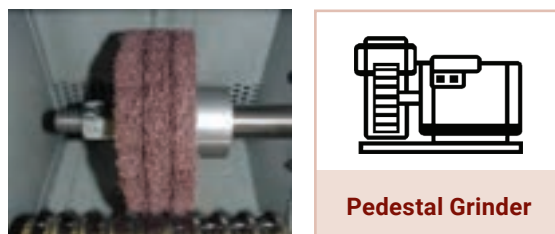

Pedestal Grinder

DIA	ARBOR	GRADE	QTY	ARBOR HOLE
6"	1/2"	MEDIUM	10	77162
6"	1/2"	VERY FINE	10	77165
8"	1/2"	MEDIUM	10	77182
8"	1/2"	VERY FINE	10	77185

FLAP BRUSHES & LINEAR POLISHING WHEELS



NON-WOVEN FLAP BRUSH

- Capable of conforming to concave, flat and irregular surfaces
- Creates matte and satin finishes without lines on work piece
- Excellent for blending, cleaning welds, and removing corrosion, rust or scaling
- Excellent for grain, antique and satin finishes, finishing aluminum extrusions and applying an inline brushed finish on aluminum & stainless steel

ALUMINUM Aluminum, brass

STAINLESS Stainless steel

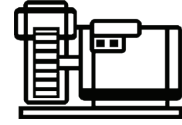

Pedestal Grinder

TECH INFO

- Flexible, consistent face for ease of use
- Cool, smooth running for less operator fatigue
- Non-woven synthetic fiber impregnated with abrasive grain for surface conditioning without damage to or removal of base material
- Resists loading and heat build-up

DIA	THICKNESS	ARBOR	GRADE	MAX RPM	QTY	FLAP BRUSH
6"	1"	2"	MEDIUM	3400	3	77325
6"	1"	2"	VERY FINE	3400	3	77327
8"	1"	3"	MEDIUM	3200	3	77330
8"	1"	3"	VERY FINE	3200	3	77332

GF - GRIND AND FINISH LINEAR POLISHING WHEELS

- Capable of conforming to concave, flat and irregular surfaces
- Excellent for blending, cleaning welds, and removing corrosion, rust, or scaling
- Excellent for grain, antique, matte and satin finishes, finishing aluminum extrusions and applying an inline brushed finish on aluminum and stainless steel
- Available in slotted keyway arbor or with 5/8-11 for use on a wide variety of portable finishing machines

ALUMINUM Aluminum, brass

STAINLESS Stainless steel



GF Interleaf Linear Wheel (more aggressive)

SIZE	GRADE	MAX RPM	QTY	INTERLEAF
4-1/4" x 4" x 5/8-11	COARSE / 60	5,000	1	71720
4-1/4" x 4" x 5/8-11	MEDIUM / 80	5,000	1	71721
4-1/4" x 4" x 5/8-11	FINE / 120	5,000	1	71722
4-1/4" x 4" x 5/8-11	VERY FINE / 150	5,000	1	71723
4-1/4" x 4" x 5/8-11	VERY FINE / 240	5,000	1	71724
4-1/4" x 4" x 3/4-Slot	COARSE / 60	5,000	1	71820
4-1/4" x 4" x 3/4-Slot	MEDIUM / 80	5,000	1	71821
4-1/4" x 4" x 3/4-Slot	FINE / 120	5,000	1	71822
4-1/4" x 4" x 3/4-Slot	VERY FINE / 150	5,000	1	71823
4-1/4" x 4" x 3/4-Slot	VERY FINE / 240	5,000	1	71824

GF Non-Woven Linear Wheel (better finish)

SIZE	GRADE	MAX RPM	QTY	NON-WOVEN
4-1/4" x 4" x 5/8-11	COARSE	5,000	1	71710
4-1/4" x 4" x 5/8-11	MEDIUM	5,000	1	71711
4-1/4" x 4" x 5/8-11	FINE	5,000	1	71712
4-1/4" x 4" x 5/8-11	VERY FINE	5,000	1	71713
4-1/4" x 4" x 3/4-Slot	COARSE	5,000	1	71810
4-1/4" x 4" x 3/4-Slot	MEDIUM	5,000	1	71811
4-1/4" x 4" x 3/4-Slot	FINE	5,000	1	71812
4-1/4" x 4" x 3/4-Slot	VERY FINE	5,000	1	71813

TECH INFO

- **MUST BE USED ON BURNISHER EQUIPMENT. NOT FOR USE ON TRADITIONAL RIGHT ANGLE GRINDERS.**
- Slower speed = Better performance
- Fine grades have a coarser effect at low speed, coarse grades have a finer effect at high speed
- Heavy pressure will result in increased wear. Apply only light pressure for best performance
- Interleaf wheels utilize both coated abrasives and non-woven abrasives to provide a faster material removal
- Non-woven wheels provide a smoother finish



Burnisher



NON-WOVEN FLAP WHEEL

- Capable of conforming to concave, flat and irregular surfaces
- Creates matte and satin finishes without lines on work piece
- Excellent for blending, cleaning welds and removing corrosion, rust, or scaling
- Excellent for grain, antique and satin finishes, finishing aluminum extrusions and applying an inline brushed finish on aluminum and stainless steel

ALUMINUM Aluminum, brass

STAINLESS Stainless steel

DIA	THICKNESS	SPINDLE	GRADE	MAX RPM	QTY	FLAP WHEEL
1"	1"	1/4"	COARSE	20,000	10	77780
1"	1"	1/4"	MEDIUM	20,000	10	77781
1"	1"	1/4"	FINE	20,000	10	77782
2"	1"	1/4"	COARSE	15,000	10	77785
2"	1"	1/4"	MEDIUM	15,000	10	77786
2"	1"	1/4"	FINE	15,000	10	77787
3"	1"	1/4"	COARSE	8,600	10	77790
3"	1"	1/4"	MEDIUM	8,600	10	77791
3"	1"	1/4"	FINE	8,600	10	77792
3"	2"	1/4"	COARSE	8,600	5	77805
3"	2"	1/4"	MEDIUM	8,600	5	77806
3"	2"	1/4"	FINE	8,600	5	77807



AVAILABLE IN TWO GRADES

MEDIUM – GENERAL PURPOSE

- Excellent for removing heavy oxidation, blending, cleaning and deburring
- Medium surface conditioning material with either 60 or 80 grit coated abrasive material

VERY FINE

- Excellent for grain finishing, satin finishing and linear scratch patterns
- Very Fine surface conditioning material with either 120 or 180 grit coated abrasive material

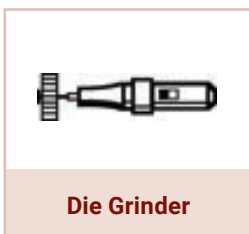

NON-WOVEN INTERLEAF WHEEL

- Interleaf flap wheels are constructed with alternating flaps of surface conditioning material and coated abrasives material for a high cut rate and a uniform scratch pattern
- Provides blending action while leaving final finish on work piece
- Smear-resistant non-woven material for clean, smear-proof work surfaces
- Interleaf design makes product more aggressive than SAIT non-woven flap brushes and less aggressive than SAIT coated abrasive flap wheels

ALUMINUM Aluminum, brass

STAINLESS Stainless steel

METAL Ferrous and non-ferrous metals

WOOD Fiberglass

DIA	THICKNESS	SPINDLE	GRIT	GRADE	MAX RPM	QTY	INTERLEAF WHEEL
1"	1"	1/4"	60	MEDIUM	20,000	10	77700
1"	1"	1/4"	80	MEDIUM	20,000	10	77702
1"	1"	1/4"	120	VERY FINE	20,000	10	77704
1"	1"	1/4"	180	VERY FINE	20,000	10	77706
2"	1"	1/4"	60	MEDIUM	15,000	10	77710
2"	1"	1/4"	80	MEDIUM	15,000	10	77712
2"	1"	1/4"	120	VERY FINE	15,000	10	77714
2"	1"	1/4"	180	VERY FINE	15,000	10	77716
3"	1"	1/4"	60	MEDIUM	8,600	10	77730
3"	1"	1/4"	80	MEDIUM	8,600	10	77732
3"	1"	1/4"	120	VERY FINE	8,600	10	77734
3"	1"	1/4"	180	VERY FINE	8,600	10	77736
3"	2"	1/4"	60	MEDIUM	8,600	5	77750
3"	2"	1/4"	80	MEDIUM	8,600	5	77752
3"	2"	1/4"	120	VERY FINE	8,600	5	77754
3"	2"	1/4"	180	VERY FINE	8,600	5	77756

INTERLEAF & NON-WOVEN FLAP DISCS



SAIT GF – GRIND & FINISH

- Combines coated and non-woven abrasives which allows you to “Grind & Finish” with one product reducing time and labor
- Cushioned grinding effect allows for effortless blending and finishing of contoured work pieces
- Aluminum oxide specifications available in coarse, medium and very fine
- Ceramic specification (High Performance) available in 40 grit and 60 grit - provides exceptionally long life

METAL STAINLESS ALUMINUM

DIA	ARBOR	GRADE	GRIT	COATED MATERIAL	SAIT GF
4-1/2"	7/8"	COARSE	60	A/O	77720
4-1/2"	7/8"	MEDIUM	80	A/O	77721
4-1/2"	7/8"	VERY FINE	150	A/O	77723
4-1/2"	7/8"	COARSE	40	CERAMIC	77760
4-1/2"	7/8"	COARSE	60	CERAMIC	77761
5"	7/8"	COARSE	60	A/O	77725
5"	7/8"	MEDIUM	80	A/O	77726
5"	7/8"	VERY FINE	150	A/O	77728
5"	7/8"	COARSE	40	CERAMIC	77766
5"	7/8"	COARSE	60	CERAMIC	77767

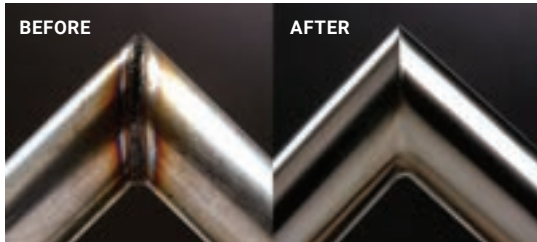

Max RPM	4-1/2": 13,300	5": 12,200
Optimal RPM	4-1/2": 4,000	5": 3,500

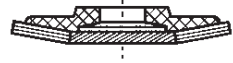

Type 29 (Conical)



Angle Grinder

QUANTITY: Packaged 10 per box

TECH INFO

- Ideal for cleaning of weld spatter and light deburring operations
- Operate at lower speeds for optimum performance
- Optimal RPM: 4-1/2"=4,000, 5"=3,500



SAND-LIGHT™

- Non-woven material
- Layered flaps create a thick, cushioned design which provides a nice finish
- Designed for surface preparation, cleaning and finishing applications

METAL Ferrous metals

STAINLESS Stainless steel, high tensile steel

ALUMINUM Non-ferrous metals

Max RPM	4-1/2": 13,300	5": 12,200
----------------	----------------	------------

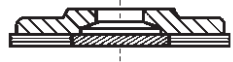

Type 27 (Flat)



Angle Grinder

DIA	ARBOR	GRADE	COLOR	SAND-LIGHT™
4-1/2"	7/8"	Coarse	Brown	71980
4-1/2"	7/8"	Medium	Maroon	71982
4-1/2"	7/8"	Very Fine	Blue	71984
5"	7/8"	Coarse	Brown	71990
5"	7/8"	Medium	Maroon	71992
5"	7/8"	Very Fine	Blue	71994

QUANTITY: Packaged 5 per box



SAIT-STRIP™ SILICON CARBIDE PRODUCTS

- Fast, safe removal of surface contaminants
- Excellent for cleaning welds, removing corrosion, rust, scaling and blending
- Great for removing paints, varnishes and sealants from difficult to reach surfaces

METAL Ferrous and/or non-ferrous metals

STAINLESS Stainless steel, high tensile steel

SAIT-STRIP™ RED CERAMIC BLEND PRODUCTS

- Premium ceramic blend
- Highly resistant open structure allows for very fast removal of surface contaminants
- Very aggressive material removal
- Exceptional performance for removing paints, sealants, rust, scale and varnishes

METAL Ferrous and/or non-ferrous metals, rust, mill scale

STAINLESS Stainless steel, high tensile steel

TECH INFO

- Constructed of large nylon filament, providing an open, non-loading surface
- Utilizes coarse silicon carbide grain for rapid removal of surface contaminants, while producing fine finishes



SAIT-LOK™

See page 132 for backing pads



SAIT-LOK-R™

SAIT-LOK™ & SAIT-LOK-R™

- SAIT-LOK™ Nylon attachment on disc ensures a secure fit to the backing pad
- SAIT-LOK-R™ Nylon screw threaded hub for easy mounting to the backing pad

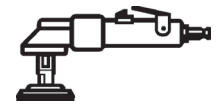

Portable Grinder

DIA	SPEC	MAX RPM	QTY	SAIT-LOK™	SAIT-LOK-R™
2"	Silicon Carbide	12,000	25	77250	77350
2"	Ceramic Blend **NEW**	12,000	25	-	77340
3"	Silicon Carbide	8,500	10	77255	77355
3"	Ceramic Blend **NEW**	8,500	10	-	77345

NON-WOVEN

ARBOR HOLE DISCS

- Arbor hole for easy mounting to grinder shaft



DIA	THICKNESS	ARBOR	MAX RPM	QTY	ARBOR HOLE DISC
4"	1/2"	1/4"	6,000	10	77270
6"	1/2"	1/2"	4,000	5	77275
8"	1/2"	1/2"	3,000	5	77280

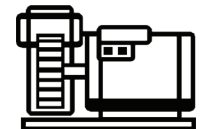

Pedestal Grinder

SAIT-STRIP™ TYPE 27

- Convenient option when using a right angle grinder



DIA	THICKNESS	ARBOR	SPEC	MAX RPM	QTY	SAIT-STRIP™
4-1/2"	1/2"	7/8"	Silicon Carbide	10,000	4	77230
4-1/2"	1/2"	7/8"	Ceramic Blend **NEW**	10,000	4	77335



Angle Grinder

UNITIZED WHEELS & DISCS



UNITIZED WHEELS

- Great for controlled material removal while imparting a final finish
- Able to remove coated abrasive grind marks and polish welds
- Applications include cleaning, deburring, blending and polishing
- Great for edge breaking and final finishing

STAINLESS Stainless steel, high tensile steel

ALUMINUM Aluminum

METAL Ferrous metals

Soft density, silicon carbide grain, medium grade

- Series 2SM / 524
- General purpose cleaning, finishing and polishing

Soft density, silicon carbide grain, fine grade

- Series 2SF / 532
- Requires light pressure for fine finishing and polishing
- Highly conformable material
- Provides clean, bright surface on stainless steel
- Finer finish than the 2SM series

Medium density, silicon carbide grain, fine grade

- Series 3SF / 632
- Requires light pressure for fine finishing and polishing
- Highly conformable material
- Provides clean, bright surface on stainless steel finishes, blends tool marks and removes slight surface imperfections

Medium density, aluminum oxide grain, fine grade

- Series 6AM / 731
- Light pressure for blending and finishing
- High edge durability
- High degree of stock removal, while maintaining bright finish

Hard density, aluminum oxide grain, coarse grade

- Series 8AC / 811
- Highest stock removal and edge breaking capability
- Most aggressive for deburring

Hard density, aluminum oxide grain, medium grade

- Series 8AM / 821
- Provides high stock removal, long life and productivity
- Very durable on edge

Hard density, zirconium grain, coarse grade ****NEW****

- Series 8ZC
- Provides extremely fast stock removal and exceptional durability
- Extremely durable on edge

New Product Types Conversion Chart

Previous	Current	Density	Grain	Grade
524	2SM	2 Soft	S Silicon Carbide	C Coarse
532	2SF	3 Medium	A Aluminum Oxide	M Medium
632	3SF	6 Medium/ Hard	Z Zirconium	F Fine
731	6AM			
811	8AC			
821	8AM	8 Hard		
—	8ZC			

UNITIZED WHEELS

DIA	THICKNESS	ARBOR	SERIES	DENSITY	GRAIN	GRADE	MAX RPM	UNITIZED WHEELS (QTY 10)	MANDREL PART #
1"	1"	3/16"	8AM	HARD	ALUMINUM OXIDE	MEDIUM	30,000	77830	—
3"	1/2"	1/4"	8AM	HARD	ALUMINUM OXIDE	MEDIUM	18,000	77835	95002
3"	1/4"	1/4"	2SM	SOFT	SILICON CARBIDE	MEDIUM	18,000	77840	95002
3"	1/4"	1/4"	2SF	SOFT	SILICON CARBIDE	FINE	18,000	77845	95002
3"	1/4"	1/4"	3SF	MEDIUM	SILICON CARBIDE	FINE	18,000	77850	95002
3"	1/4"	1/4"	6AM	MEDIUM	ALUMINUM OXIDE	FINE	18,000	77855	95002
3"	1/4"	1/4"	8AC	HARD	ALUMINUM OXIDE	COARSE	18,000	77860	95002
3"	1/4"	1/4"	8AM	HARD	ALUMINUM OXIDE	MEDIUM	18,000	77865	95002

TYPE 27 UNITIZED DISCS

DIA	ARBOR	SERIES	DENSITY	GRAIN	GRADE	MAX RPM	TYPE 27 UNITIZED DISCS (QTY 5)
4-1/2"	7/8"	2SM	SOFT	SILICON CARBIDE	MEDIUM	10,000	77875
4-1/2"	7/8"	3SF	MEDIUM	SILICON CARBIDE	FINE	10,000	77880
4-1/2"	7/8"	8AC	HARD	ALUMINUM OXIDE	COARSE	10,000	77885
4-1/2"	7/8"	8AM	HARD	ALUMINUM OXIDE	MEDIUM	10,000	77890
4-1/2"	7/8"	8ZC	HARD	ZIRCONIUM	COARSE	10,000	77900



Die Grinder

See page 130 for mandrels



Angle Grinder



Wheels must be run in the direction of the arrow as indicated on the wheel. See page 136 for reducing bushing

CONVOLUTE WHEEL

- Silicon carbide grain for fast cut rate and finest finish
- Provides best durability, stock removal, and finest finish for increased productivity

- METAL** Ferrous and non-ferrous materials
ALUMINUM Aluminum
STAINLESS Stainless steel, high tensile materials

DIA	THICKNESS	ARBOR	GRADE	DENSITY	MAX RPM	QTY	CONVOLUTE
6"	1/2"	1"	FINE	HARD - 9SF	6,000	4	77810
6"	1"	1"	FINE	HARD - 9SF	6,000	2	77820
6"	1"	1"	FINE	MEDIUM - 8SF	6,000	2	77815
8"	1"	3"	FINE	HARD - 9SF	4,500	2	77825

TECH INFO

- Convolute wheels are constructed by wrapping non-woven nylon, impregnated with abrasive grains, around a hard core to form a homogeneous wheel
- Dense, non-woven construction for long lasting wear and high edge durability
- Smooth running for less operator fatigue
- Non-metallic for no workpiece contamination
- Smear-resistant formulation to greatly reduce the possibility of smearing

AVAILABLE IN TWO DENSITIES

MEDIUM

- Excellent for general purpose deburring, blending and weld polishing
- Comparable to competitive 8SF

HARD

- Excellent for aggressive deburring, blending
- Comparable to competitive 9SF products

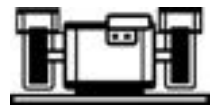

Bench Grinder

NON-WOVEN



BUFFING DISCS

- Premium quality buffing material
- Designed for final cosmetic finishing
- Available in hook and loop and SAIT-LOK-R™
- A slower speed achieves a better finish and reduces heat

- STAINLESS** Stainless steel and other high tensile alloys
ALUMINUM Aluminum, brass and other non-ferrous metals

DIA	QTY	SAIT-LOK-R™	HOOK & LOOP
2"	50	41012	-
3"	25	41013	-
5"	10	-	41055
7"	10	-	41057



SAIT-LOK-R™



See page 136 for backing pads and buffing compound bars and kits



Angle Grinder

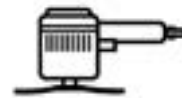

Disc Sander



Portable Grinder

TECHNICAL INFORMATION

United Abrasives' brushes consist of only the highest grade industrial tempered wire and state-of-the-art construction, designed for off-hand equipment. The various styles cover a multitude of applications.

FEATURES AND BENEFITS

Brushes are available in a variety of wire types. The proper brush for the application should be selected based on the characteristics of the brush, including wire type.

WIRE SIZE SPECIFICATIONS

The thickness of brush wire will impact the end result of the workpiece. Fine wire, such as .008, will produce a finer finish and will yield a longer brush life. Thicker wires, such as .014 and .020 or higher, will be more aggressive and will decrease production times.

BRUSH FILL MATERIALS

Carbon steel, the most durable, high strength fill material available for general purpose cleaning applications, is suitable for light to heavy duty cleaning depending on the wire diameter.

Stainless Steel fill material is suitable on metals such as aluminum and stainless steel when corrosion resistance and non-contaminant brushing actions are required.

POWER BRUSH SAFETY REQUIREMENTS

1. Safety Goggles: Safety goggles, or full face shields worn over safety glasses with side shields, **MUST BE WORN** by all OPERATORS and OTHERS IN THE AREA OF POWER BRUSH OPERATIONS. Comply with the requirements of ANSI Z87.1 ("Occupational Eye and Face Protection").
2. Guards: Keep all machine guards in place.
3. Speeds: Observe all speed restrictions indicated on the brushes, containers, labels, or printed in pertinent literature. "MSFS" or "MAX.SFS" means Maximum Safe Free Speed (R.P.M.) - spinning free with no work applied. For reasons of safety, the "MSFS/MAX.SFS" should not be exceeded under any circumstances.
4. Safety Standard: Comply with the safety standards of the American National Standards Institute, ANSI B165.1 and ANSI B165.2 - "Safety Requirements - Power Brushes."
5. Protective Equipment: Appropriate protective clothing and equipment (such as full face shield, gloves, respirator, etc.) must be used where a possibility of injury exists that can be prevented by such equipment.
6. Before starting brush: Use eye protection and safety equipment. Inspect brush for rust, damage, speed limit, etc. If no-load speed marked on the power tool is higher than the brush speed limit, do not mount brush. Inspect and jog machine to assure the brush is mounted properly and securely, machine guards are in place, no vibration, etc. Run machine at operating speed for at least one minute before applying work. **DO NOT STAND IN FRONT OF OR IN LINE WITH BRUSH.**

COMMON BRUSH TERMINOLOGY

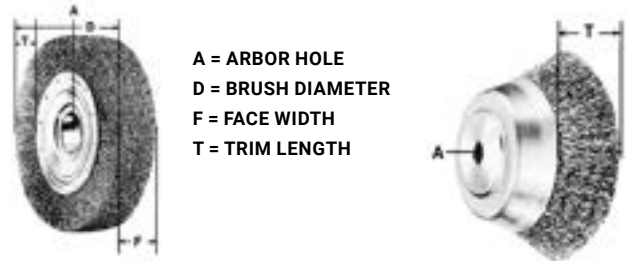

APPLICATION INFORMATION

- Always check warning labels for safety information
- Always follow safety guidelines included with each brush package
- Proper application of wire brushes is for the removal of various surface contaminants, not the removal of the base stock material
- The power tool determines the size and speed of the brush to be used
- Check the R.P.M. rating of the tool to verify that it does not exceed the Maximum Safe Free Speed (M.S.F.S.) of the brush
- The slowest speed that will do the job is the most efficient use of the brush. Running at the M.S.F.S. is not necessarily the most efficient speed
- The tool shaft must match the arbor hole of the brush
- The tips of wire at the end of the brush do the work. Excessive pressure will cause premature wire breakage, reduced brush life, increased heat build-up and rapid dulling

PACKAGING INFORMATION

- All BlueLine™ wire brush packaging is one piece per package
- BlueLine™ packaging is designed to be displayed on hooks or shelving

KNOT WIRE BRUSHES provide high impact action and offer low to medium flexibility through the use of twisted wire tufts for heavy duty applications, such as weld cleaning. Knot wire brushes are available in 2 knot configurations.



REGULAR TWIST KNOT: Flag at end of wire tuft provides additional brush flexibility for irregular surface preparation.



STRINGER BEAD KNOT: Extremely narrow tufted face is ideal for bead weld preparation.



CRIMPED WIRE BRUSHES are general purpose brushes that provide higher flexibility and cleaning action through the use of flexible wire points. They offer a wider work face than knot style and are ideal for light applications such as rust or paint removal.

Flexible wire points provide cleaning action for light applications.



WIRE BRUSHES



BENCH WIRE WHEELS & CUP BRUSHES



BENCH WIRE WHEELS

- Dense, compact crimped carbon steel wire brush face
- May be stacked to achieve wider work face
- Primary application: For general scale removal, cleaning and surface preparation
- Standard 2" arbor, with adapter to listed arbor
- Includes bushing pairs to adapt to variety of arbors

All BlueLine™ wire brush packaging is one piece per package

Blue Line™ Packaging



Bench Grinder

CARBON STEEL WIRE

METAL

Additional Arbors Available

DIA	WIRE SIZE	ARBOR	FACE WIDTH	TRIM LENGTH	MAX RPM	QTY	CARBON STEEL	
							INDUSTRIAL	BLUE LINE™
6"	.008"	5/8", 1/2"	NARROW (1/2")	1-1/16"	6,000	1	09555	06555
6"	.014"	5/8", 1/2"	WIDE (1")	1-1/16"	6,000	1	09557	06557
6"	.014"	5/8", 1/2"	NARROW (1/2")	1-3/16"	6,000	1	09558	06558
7"	.014"	5/8"	WIDE (1")	1-9/16"	6,000	1	09559	06559
8"	.014"	5/8"	WIDE (1")	1-1/2"	4,000	1	01411	06556
10"	.014"	3/4"	WIDE (1")	2"	3,600	1	09560	-

ARBOR	PART #
2 X 5/8	95203
2 X 3/4	95204
2 X 1	95206

Arbors not available for part number 09555 and 09558

LARGE CUP BRUSHES

- Primary application: For fast cleaning of large surfaces
- **KNOT WIRE:** For low to medium flexibility and aggressive cutting action
- **CRIMPED WIRE:** Higher flexibility for light cleaning and removal, especially on irregular surfaces

All BlueLine™ wire brush packaging is one piece per package

Blue Line™ Packaging



Angle Grinder

CARBON STEEL WIRE

METAL

STAINLESS STEEL WIRE

METAL STAINLESS ALUMINUM

DIA	WIRE SIZE	ARBOR	TRIM LENGTH	TYPE	MAX RPM	INDUSTRIAL QTY	CARBON STEEL		STAINLESS STEEL*	
							INDUSTRIAL	BLUE LINE™	INDUSTRIAL	BLUE LINE™
4"	.020"	5/8-11	1-1/8"	CRIMPED	9,000	1	09551	06551	-	-
4"	.020"	5/8-11	1-3/8"	KNOT	9,000	1	03407	06407	03406	-
5"	.020"	5/8-11	1-1/2"	CRIMPED	8,000	1	09552	-	09554	06554
6"	.020"	5/8-11	1-3/4"	KNOT	6,600	1	03409	06409	-	-
6"	.020"	5/8-11	1-3/4"	KNOT	6,000	1	03411	06411	03413	-
6"	.020"	5/8-11	1-1/2"	CRIMPED	6,600	1	09553	06553	-	-
6"	.035"	5/8-11	1-3/4"	KNOT	6,600	1	03410	06410	-	-
6"	.035"	5/8-11	1-3/4"	KNOT	6,000	1	03412	06412	-	-

* 302 stainless steel wire used



SMALL CUP BRUSHES

- For use on small grinders
- **KNOT WIRE:** For low to medium flexibility and aggressive cutting action
- **CRIMPED WIRE:** For light cleaning and where greater flexibility is required
- Variety of threaded arbors available



Angle Grinder

All BlueLine™ wire brush packaging is one piece per package

Blue Line™ Packaging

CARBON STEEL WIRE	STAINLESS STEEL WIRE		
METAL	METAL	STAINLESS	ALUMINUM

DIA	WIRE SIZE	ARBOR	TYPE	MAX RPM	INDUSTRIAL QTY	CARBON STEEL		STAINLESS STEEL*	
						INDUSTRIAL	BLUE LINE™	INDUSTRIAL	BLUE LINE™
2-3/4"	.014"	1/2-13	CRIMPED	14,000	6	01402	06402	-	-
2-3/4"	.014"	1/2-13	KNOT	14,000	6	03418	06418	03420	-
2-3/4"	.014"	5/8-11	CRIMPED	14,000	6	01401	06401	01408	06408
2-3/4"	.014"	5/8-11	KNOT	14,000	6	03414	06414	03419	06419
2-3/4"	.014"	M10 X 1.25	CRIMPED	14,000	6	01404	06404	-	-
2-3/4"	.014"	M10 X 1.25	KNOT	14,000	6	03416	06416	03422	-
2-3/4"	.014"	M10 X 1.5	CRIMPED	14,000	6	-	06403	-	-
2-3/4"	.014"	M14 X 2.0	KNOT	14,000	6	03415	06415	-	-
2-3/4"	.020"	1/2-13	KNOT	14,000	6	03505	06505	-	-
2-3/4"	.020"	5/8-11	KNOT	14,000	6	03501	06501	03506	06506
2-3/4"	.020"	M10 X 1.25	KNOT	14,000	6	03503	06503	-	-
2-3/4"	.020"	M10 X 1.5	KNOT	14,000	6	03504	06504	-	-
3-1/2"	.014"	5/8-11	CRIMPED	12,500	1	03513	06513	03514	06514
3-1/2"	.020"	5/8-11	KNOT	12,500	1	03511	06511	03512	06512

* 302 stainless steel wire used

WIRE WHEELS & PIPELINE BRUSHES



REGULAR TWIST KNOT WIRE WHEELS

- For use on small grinders and portable power tools
- Provides aggressive action in the removal of bead scale, weld flash or splatter
- Covers more surface area in a single pass
- Carbon steel wire for low to medium flexibility and aggressive cutting action

CARBON STEEL WIRE	STAINLESS STEEL WIRE		
METAL	METAL	STAINLESS	ALUMINUM



Angle Grinder

All BlueLine™ wire brush packaging is one piece per package

Blue Line™ Packaging

THREADED

DIA	WIRE SIZE	ARBOR	TYPE	MAX RPM	INDUSTRIAL QTY	CARBON STEEL		STAINLESS STEEL*	
						INDUSTRIAL	BLUE LINE™	INDUSTRIAL	BLUE LINE™
4"	.014"	5/8-11	REGULAR TWIST	20,000	6	03426	06426	03431	06431
4"	.020"	5/8-11	REGULAR TWIST	20,000	6	03460	06460	03461	06461
4"	.014"	1/2-13	REGULAR TWIST	20,000	6	03430	06430	-	-
4"	.014"	M10 X 1.25	REGULAR TWIST	20,000	6	03428	06428	-	-
5"	.020"	5/8-11	REGULAR TWIST	12,000	1	03373	06373	03374	06374
6"	.020"	5/8-11	REGULAR TWIST	9,000	1	03388	06388	-	-
6"	.025"	5/8-11	REGULAR TWIST	9,000	3	03385	06385	-	-

* 302 stainless steel wire used

NON-THREADED

DIA	WIRE SIZE	ARBOR	TYPE	MAX RPM	INDUSTRIAL QTY	CARBON STEEL		STAINLESS STEEL*	
						INDUSTRIAL	BLUE LINE™	INDUSTRIAL	BLUE LINE™
3"	.014"	3/8"	REGULAR TWIST	25,000	4	03377	06377	-	-
3"	.014"	1/2", 3/8"	REGULAR TWIST	25,000	-	-	-	03376	06376
4"	.014"	1/2"	REGULAR TWIST	20,000	4	03378	06378	-	-
6"	.016"	5/8, 1/2	REGULAR TWIST	9,000	-	-	-	03387	06387
6"	.020"	5/8, 1/2	REGULAR TWIST	9,000	1	03386	06386	-	-

* 302 stainless steel wire used



CRIMPED WIRE WHEELS

- For use on small grinders
- Provides flexibility and a wider work face than knot style

CARBON STEEL WIRE

METAL



Angle Grinder

All BlueLine™ wire brush packaging is one piece per package

Blue Line™ Packaging

DIA	WIRE SIZE	ARBOR	TYPE	MAX RPM	INDUSTRIAL QTY	CARBON STEEL	
						INDUSTRIAL	BLUE LINE™
4"	.014"	1/2-13	CRIMPED	12,500	6	03454	06454
4"	.014"	5/8-11	CRIMPED	12,500	6	03450	06450

PIPELINE/STRINGER BEAD BRUSHES

- Excellent for use in the pipeline industry
- Twisted wire wheels for higher impact action
- Stringer bead wire provides aggressive action in the removal of bead scale, weld flash or splatter
- Primary application: Cleaning, deburring and scale removal

CARBON STEEL WIRE

METAL

STAINLESS STEEL WIRE

METAL STAINLESS ALUMINUM



Angle Grinder

All BlueLine™ wire brush packaging is one piece per package

Blue Line™ Packaging



DIA	WIRE SIZE	ARBOR	TYPE	MAX RPM	INDUSTRIAL QTY	CARBON STEEL		STAINLESS STEEL *	
						INDUSTRIAL	BLUE LINE™	INDUSTRIAL	BLUE LINE™
4"	.020"	1/2-13	STRINGER BEAD/ PIPELINE	20,000	6	03444	–	03449	–
4"	.020"	5/8-11	STRINGER BEAD/ PIPELINE	20,000	6	03440	06440	03445	06445
4"	.020"	M14 X 2.0	STRINGER BEAD/ PIPELINE	20,000	6	03441	06441	–	–
4-1/2"	.020"	5/8-11	STRINGER BEAD / PIPELINE	20,000	6	03455	06455	03459	06459
5"	.020"	5/8-11	STRINGER BEAD / PIPELINE	12,000	6	03380	06380	03382	06382
6"	.020"	5/8-11	STRINGER BEAD / PIPELINE	12,000	6	03384	06384	03383	06383
6-1/2"	.020"	5/8-11	STRINGER BEAD / PIPELINE	9,000	6	03391	06391	03389	06389

* 302 stainless steel wire used

JOINT BRUSHES & END BRUSHES



JOINT BRUSH

- For use on street saws
- Primary application: Cleaning concrete expansion joints

CARBON STEEL WIRE

CONCRETE



Street Saw

DIA	WIRE SIZE	ARBOR	MAX RPM	QTY	JOINT BRUSH
12"	.035"	1" ARBOR, 7/16" PINHOLE	6,000	1	09570



END BRUSHES

- For use on portable power tools
- Excellent for use in cleaning and finishing recessed areas or pipes
- 1/4" shank diameter
- **KNOT WIRE:** Provides aggressive cutting action
- **CIRCULAR FLARED:** Excellent for side cleaning action
- **CRIMPED WIRE:** For high flexibility

CARBON STEEL WIRE

METAL

STAINLESS STEEL WIRE

METAL STAINLESS ALUMINUM



Die Grinder

All BlueLine™ wire brush packaging is one piece per package

Blue Line™ Packaging

DIA	WIRE SIZE	TYPE	TRIM LENGTH	OVERALL LENGTH	MAX RPM	INDUSTRIAL QTY	CARBON STEEL		STAINLESS STEEL *	
							INDUSTRIAL	BLUE LINE™	INDUSTRIAL	BLUE LINE™
3/4"	.014"	CRIMPED	1"	2-5/8"	22,000	12	02702	06702	-	-
3/4"	.014"	KNOT	1-1/8"	2-5/8"	22,000	12	02703	06703	-	-
1"	.020"	CRIMPED	1"	2-5/8"	22,000	12	02709	06709	-	-
1"	.020"	KNOT	1"	2-5/8"	22,000	12	02701	06701	02704	06704
1-1/2"	.012"	CIRCULAR FLARED CRIMPED	5/16"	1-3/4"	20,000	12	02710	06710	-	-
2"	.014"	CIRCULAR CRIMPED	7/16"	1-1/4"	25,000	12	02712	06712	-	-
2-1/2"	.014"	CIRCULAR FLARED CRIMPED	11/16"	1-3/4"	20,000	12	02705	06705	-	-
3"	.014"	CIRCULAR FLARED CRIMPED	7/8"	1-3/4"	25,000	12	-	-	02711	06711
3"	.014"	CRIMPED	3/4"	1-1/4"	25,000	12	02713	06713	02714	06714

* 302 stainless steel wire used



ACID HAND BRUSHES

- Quality horsehair bristles
- Machine trimmed and crimped to specification

WIDTH	TRIM LENGTH	OVERALL LENGTH	QTY	PART #
3/8"	3/4"	6"	144	00501
7/16"	7/8"	6-1/2"	144	00502
9/16"	7/8"	6-1/8"	144	00503



PAINT BRUSHES

- Quality horsehair bristles
- Wood handle
- Use for solvents and chemicals

WIDTH	TRIM LENGTH	OVERALL LENGTH	QTY	PART #
1/2"	1-1/2"	7"	72	00511
1"	1-1/2"	7-1/2"	72	00512
1-1/2"	1-1/2"	7-1/2"	72	00513
2"	1-1/2"	7-1/2"	72	00514
3"	1-1/2"	8"	48	00515
4"	2-1/4"	9-1/2"	12	00516



METAL CHIP BRUSHES

- Durable, long lasting
- For cleaning metal chips from work surfaces

LENGTH	WIRE SIZE	TRIM LENGTH	QTY	PART #
5-5/16"	1-12"	1-3/8"	12	00510



SCRATCH BRUSHES

- Excellent for light scale removal
- Available in the following wire types:
 - Carbon steel wire for general purpose cleaning
 - Stainless steel wire is carbon free
 - Brass wire for general purpose cleaning
- Primary application: maintenance cleaning



SIZE	WIRE SIZE	MATERIAL	TYPE	QTY	PART #
3 X 7	.006"	BRASS	SMALL CLEANING BRUSH WITH PLASTIC HANDLE	12	05768
3 X 7	.006"	BRASS	SMALL CLEANING BRUSH	12	05762
3 X 14	.014"	CARBON STEEL	V-GROOVE SCRATCH	12	05764
3 X 15	-	CARBON STEEL	CHIPPING HAMMER BRUSH	12	05757
3 X 19	.014"	CARBON STEEL	CURVED HANDLE WITH SCRAPER	12	05760
3 X 19	.014"	CARBON STEEL	CURVED HANDLE	12	05751
4 X 16	.014"	CARBON STEEL	SHOE HANDLE WITH SCRAPER	12	05761
4 X 16	.014"	CARBON STEEL	SHOE HANDLE	12	05753
4 X 19	.014"	CARBON STEEL	CURVED HANDLE	12	05752
3 X 7	.006"	STAINLESS STEEL	SMALL CLEANING BRUSH	12	05759
3 X 7	.006"	STAINLESS STEEL	SMALL CLEANING BRUSH WITH PLASTIC HANDLE	12	05766
3 X 14	.012"	STAINLESS STEEL	V-GROOVE SCRATCH	12	05765
3 X 19	.012"	STAINLESS STEEL	CURVED	12	05755
4 X 16	.012"	STAINLESS STEEL	SHOE HANDLE	12	05763

NYLON BRUSHES

NYLON BRUSHES

- Available in silicon carbide grain
- Use on steel, aluminum, copper, brass, stainless steel, super alloys, plastics, composites, ceramics, wood, leather

METAL **STAINLESS** **ALUMINUM** **WOOD**



Hand Brush

NYLON TUBE BRUSHES

DIA	TRIM LENGTH	OVERALL LENGTH	GRIT	QTY	PART #
1/2"	2"	5"	80	12	04270
5/8"	2"	5"	120	12	04285
1"	2-1/2"	5-1/2"	80	12	04275
1"	2-1/2"	5-1/2"	120	12	04290
1-1/4"	2-1/2"	5-1/2"	80	12	04280



Angle Grinder

NYLON CUP BRUSHES

DIA	ARBOR	TRIM LENGTH	GRIT	MAX RPM	QTY	PART #
4"	5/8-11	1-1/2"	80	6,000	1	04310
6"	5/8-11	1-1/2"	80	6,000	1	04340

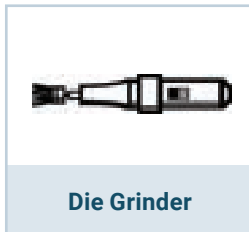

Die Grinder

NYLON END BRUSHES

DIA	TRIM LENGTH	OVERALL LENGTH	GRIT	MAX RPM	QTY	PART #
1"	1"	2-3/4"	80	9,000	6	04390
1"	1"	2-3/4"	120	19,000	12	04380



Bench Grinder

LARGE DIAMETER NYLON WHEELS

DIA	ARBOR	FACE WIDTH	TRIM LENGTH	GRIT	MAX RPM	QTY	PART #
3"	5/8"	1/2"	5/8"	80	18,000	1	04110
3"	5/8"	1/2"	5/8"	320	18,000	1	04120
4"	5/8"	5/8"	3/4"	120	12,000	1	04130
4"	5/8"	5/8"	3/4"	180	12,000	1	04140
6"	2"	7/8"	1-1/16"	120	6,000	1	04150



Die Grinder

SMALL DIAMETER NYLON WHEELS

DIA	ARBOR	FACE WIDTH	TRIM LENGTH	GRIT	MAX RPM	QTY	PART #
2-1/2"	5/8"	3/8"	11/16"	120	15,000	4	04230



CARBIDE BURS

TECHNICAL INFORMATION

United Abrasives offers a complete line of tungsten carbide burs in the most popular shapes and sizes to meet your needs. Choosing the right bur depends on the material to be ground, grinding speed, desired shape and finish requirements. United Abrasives' burs are precision ground with diamond wheels resulting in a concentric tool with very sharp, uniform teeth. This manufacturing method produces the highest quality bur, properly balanced for vibration-free operation and long tool life. Tungsten burs are best suited for efficient material removal at high RPMs. United Abrasives' burs are made in the U.S.A.



Wooden display case holds up to 8 burs - Part #99046

FEATURES

- Tungsten carbide construction for long life and precision cutting
- Highest quality construction for proper balance which delivers vibration-free operation
- Double cut provides smooth operation and maximum tool control
- Non-ferrous burs have an open design for non-loading on softer materials

APPLICATIONS

- Excellent for confined or hard-to-reach areas
- Use for deburring and finishing on ferrous and non-ferrous metals
- Shaping and enlarging holes in steel
- Removing welds
- Smoothing castings

MAXIMUM RECOMMENDED RPMs FOR CARBIDE BURS

FILE DIA.	RPM(1)	RPM(2)
1/4"	22,000	33,000
5/16"	20,000	30,000
3/8"	18,000	27,000
1/2"	16,000	24,000

Use RPM(1) for iron, steel welds, cast iron, tool steels, die steels, bronze, brass and aluminum.

Use RPM(2) for stainless steel.

DOUBLE CUT (ALTERNATE CUT)

Double cut or alternate cut is the most popular bur in ferrous applications. Manufactured with cuts made on the left and right spirals, this design produces a finer finish on material producing smaller chips and slivers. The double cut offers much smoother operation and greater tool control.



NON-FERROUS (ALUMINUM CUT)

Non-ferrous or aluminum cut burs have a more open, aggressive cut to avoid loading on softer materials. This design provides outstanding stock removal on aluminum, magnesium, copper, soft steel, brass, zinc alloys, hard rubber, most plastics, and nonferrous metals. These burs provide easy chip flow with little or no clogging.



DOUBLE CUT (ALTERNATE CUT)

TYPE	DIA	LENGTH	SHANK DIA	QTY	PART #
SA1	1/4"	5/8"	1/4"	1	45000
SA3	3/8"	3/4"	1/4"	1	45001
SA5	1/2"	1"	1/4"	1	45002
SB1	1/4"	5/8"	1/4"	1	45111
SB3	3/8"	3/4"	1/4"	1	45004
SB5	1/2"	1"	1/4"	1	45113
SC1	1/4"	5/8"	1/4"	1	45005
SC3	3/8"	3/4"	1/4"	1	45006
SC5	1/2"	1"	1/4"	1	45007
SD1	1/4"	7/32"	1/4"	1	45010
SD3	3/8"	5/16"	1/4"	1	45011
SD5	1/2"	7/16"	1/4"	1	45012
SE1	1/4"	3/8"	1/4"	1	45015
SE5	1/2"	7/8"	1/4"	1	45016
SF1	1/4"	5/8"	1/4"	1	45020
SF3	3/8"	3/4"	1/4"	1	45021
SF5	1/2"	1"	1/4"	1	45022
SG1	1/4"	5/8"	1/4"	1	45030
SG3	3/8"	3/4"	1/4"	1	45031
SG5	1/2"	1"	1/4"	1	45032
SH1	1/4"	5/8"	1/4"	1	45115
SH2	5/16"	3/4"	1/4"	1	45116
SH5	1/2"	1-1/4"	1/4"	1	45117
SL1	1/4"	5/8"	1/4"	1	45025
SL3	3/8"	1-1/16"	1/4"	1	45026
SL4	1/2"	1-1/4"	1/4"	1	45027
SM1	1/4"	1/2"	1/4"	1	45035
SM2	1/4"	3/4"	1/4"	1	45036
SM4	3/8"	3/4"	1/4"	1	45037
SM5	1/2"	1"	1/4"	1	45038

NON-FERROUS (ALUMINUM CUT)

TYPE	DIA	LENGTH	SHANK DIA	QTY	PART #
SA3NF	3/8"	3/4"	1/4"	1	45050
SA5NF	1/2"	1"	1/4"	1	45051
SC3NF	3/8"	3/4"	1/4"	1	45052
SF3NF	3/8"	3/4"	1/4"	1	45053
SF5NF	1/2"	1"	1/4"	1	45054
SL4NF	1/2"	1-1/8"	1/4"	1	45055

HEAVY DUTY

TYPE	DIA	LENGTH	SHANK DIA	QTY	PART #
SA5	1/2"	1"	1/4"	1	45125
SC5	1/2"	1"	1/4"	1	45130
SE5	1/2"	7/8"	1/4"	1	45135
SF3	3/8"	3/4"	1/4"	1	45140
SF5	1/2"	1"	1/4"	1	45145
SG5	1/2"	1"	1/4"	1	45150
SL3	3/8"	1-1/16"	1/4"	1	45155
SL4	1/2"	1-1/4"	1/4"	1	45160

6" LENGTH SHANK

TYPE	DIA	LENGTH	SHANK DIA	QTY	PART #
SA3L6	3/8"	3/4"	1/4"	1	45603
SA5L6	1/2"	1"	1/4"	1	45605
SB1L6	1/4"	5/8"	1/4"	1	45611
SB3L6	3/8"	3/4"	1/4"	1	45613
SC3L6	3/8"	3/4"	1/4"	1	45623
SD1L6	1/4"	7/32"	1/4"	1	45631
SD3L6	3/8"	5/16"	1/4"	1	45633
SE5L6	1/2"	7/8"	1/4"	1	45645
SF3L6	3/8"	3/4"	1/4"	1	45653
SF5L6	1/2"	1"	1/4"	1	45655
SG3L6	3/8"	3/4"	1/4"	1	45663
SG5L6	1/2"	1"	1/4"	1	45665
SH2L6	5/16"	3/4"	1/4"	1	45672
SL3L6	3/8"	1-1/16"	1/4"	1	45683
SM3L6	1/4"	1"	1/4"	1	45693

6" LENGTH SHANK NON-FERROUS (ALUMINUM CUT)

TYPE	DIA	LENGTH	SHANK DIA	QTY	PART #
SC3NFL6	3/8"	3/4"	1/4"	1	45063
SD3NFL6	3/8"	5/16"	1/4"	1	45083
SF3NFL6	3/8"	3/4"	1/4"	1	45073

TECH INFO

- Tungsten carbide construction for long life and durability
- High quality manufacturing method delivers vibration-free operation
- Precision ground with diamond wheels to produce a very sharp uniform cutting edge
- Each enclosed in individual plastic capsules for storage and protection



Die Grinder

BONDED ABRASIVE ACCESSORIES	130
TYPE 27 / TYPE 42 REUSABLE ADAPTER KIT.....	130
TYPE 1 / TYPE 41 & TYPE 27 / TYPE 42 REUSABLE 5/8-11 ADAPTER.....	130
CHALLENGER II™ BACKING PAD.....	130
TYPE 1 / TYPE 41 CUT-OFF WHEEL REDUCING BUSHINGS.....	130
TYPE 1 / TYPE 41 CUT-OFF ADAPTER.....	130
SPANNER WRENCH.....	130
BACKING PADS FOR FIBER DISCS	131
BACKING PADS FOR RESIN FIBER DISCS.....	131
SPIRALCOOL™ SAIT-LOK™ BACKING PADS FOR RESIN FIBER DISCS.....	131
SAIT-LOK™ BACKING PADS FOR RESIN FIBER DISCS.....	131
CENTER NUTS.....	131
LAMINATED, SURFACE CONDITIONING & COTTON FIBER ACCESSORIES.	132
SPIRALCOOL™ SAIT-LOK™ BACKING PADS FOR QUICK CHANGE DISCS.....	132
SPIRALCOOL™ SAIT-LOK-R™ BACKING PADS FOR QUICK CHANGE DISCS.....	132
SAIT-LOK™ BACKING PADS FOR QUICK CHANGE DISCS.....	132
SAIT-LOK-R™ BACKING PADS FOR QUICK CHANGE DISCS.....	132
PSA / HOOK & LOOP ACCESSORIES.	133
PSA BACKING PADS.....	133
HOOK & LOOP BACKING PADS FOR PAPER DISCS.....	133
HOOK & LOOP SOFT INTERFACE PADS.....	133
CONTOUR HAND PADS.....	133
PALM HAND SANDER.....	133
FLAP WHEEL & COATED ABRASIVE ACCESSORIES	134
1/4" SHANK ADAPTER KIT FOR FLAP WHEELS.....	134
1/4" SHANK THREADED ADAPTER FOR FLAP WHEELS.....	134
ABRASIVES CLEANING STICK.....	134
HAND SANDING BLOCK.....	134
SPECIALTY COATED ABRASIVE ACCESSORIES	135
SPIRAL BAND DRUMS.....	135
CARTRIDGE ROLL MANDRELS.....	135
CROSS PAD & SQUARE PAD MANDRELS.....	135
NON-WOVEN ACCESSORIES.	136
CONVOLUTE WHEEL AND NON-WOVEN FLAP BRUSH REDUCING BUSHING.....	136
HANDLE FOR NON-WOVEN HAND PADS.....	136
SURFACE CONDITIONING BACKING PADS.....	136
SUPER SOFT BUFFING DISC BACKING PADS.....	136
BUFFING COMPOUND BARS & KITS.....	136
SAITLAB INOX POLISHING COMPOUND **NEW**	136



ACCESSORIES

BONDED ABRASIVE ACCESSORIES



TYPE 27 REUSABLE ADAPTER KIT

- For use with Type 27 wheels on 7" and 9" 5/8-11 spindle grinders
- Alternative to a throwaway hub

PART #

95000



TYPE 1 / TYPE 41 & TYPE 27 / TYPE 42 REUSABLE 5/8-11 ADAPTER

- Reusable 5/8-11 adapter for use on Type 1 / Type 41 and Type 27 / Type 42 reinforced wheels with a 7/8 arbor, a max. diameter of 5" and a wheel thickness of .045 to 1/8"

PART #

95055



CHALLENGER II™ BACKING PAD

- For use with Challenger II™ flexible grinding / blending wheels
- Set includes 5/8-11 nut and pad

DIA	MAX RPM	PART #
4-1/2" & 5"	13,300/12,200	95245
7"	8,600	95247



TYPE 1 / TYPE 41 CUT-OFF WHEEL REDUCING BUSHINGS

- For use with Type 1 / Type 41 cut-off wheels
- Reduces wheel arbor size

SIZE	PART #	SIZE	PART #
1-5/8"	95030	7/8" - 5/8"	95034
1-20MM	95031	DIA - 5/8"	95035
1-7/8"	95032	DIA - 1/2"	95036
1-3/4"	95033	1/2" - 3/8"	95037



TYPE 1 / TYPE 41 CUT-OFF ADAPTER

- For use with Type 1 / Type 41 thin high speed cut-off wheels up to 3" diameter only

SIZE	PART #
1/4 X 1/4-20	95002
1/4 X 3/8-24	95003



SPANNER WRENCH

- Adjustable wrench for tightening and loosening center nuts
- Fits all center nuts

PART #

95008



SPIRALCOOL™ BACKING PADS FOR RESIN FIBER DISCS

- Spiralcool™ backing pads' exclusive rubber, fabric and fiber board construction provide extra strength and reliability
- Spiral ribs provide contact points and form channels for air flow extending discs life 30% to 50%
- Each pad is supplied with a nut as indicated

DIA	ARBOR	TYPE	MAX RPM	PART #
4"	5/8-11"	MEDIUM	12,000	95010
4-1/2"	5/8"	MEDIUM	11,000	95011
4-1/2"	1/2"	MEDIUM	11,000	95012
4-1/2"	5/8"	HARD	11,000	95110
5"	5/8"	MEDIUM	10,000	95016
5"	5/8"	HARD	10,000	95111
6"	5/8"	MEDIUM	8,500	95112
6"	5/8"	HARD	8,500	95113
7"	5/8-11	SOFT	8,600	95017
7"	5/8-11	MEDIUM	8,600	95018
7"	5/8-11	HARD	8,600	95019
9"	5/8-11	MEDIUM	6,500	95021
9"	5/8-11	HARD	6,500	95022

Additional nuts may be purchased separately. This backing pad is not to be used with SAIT-LOK™ quick change fiber discs



SPIRALCOOL™ SAIT-LOK™ BACKING PADS FOR RESIN FIBER DISCS

- Unique spiral face increases aggressiveness and improves disc life by staying cooler
- For use with SAIT-LOK™ fiber discs
- Minimizes change-over downtime
- No additional mounting hardware required

SIZE	MAX RPM	PART #
4-1/2" X 5/8-11	15,000	95115
5" X 5/8-11	15,000	95116
6" X 5/8-11	8,500	95119
7" X 5/8-11	8,600	95117
9" X 5/8-11	6,600	95118



CENTER NUTS

- For attaching fiber discs to backing pad and tool
- Use small for 4", 4-1/2", 5" diameter pads
- Use large for 7", 9" diameter pads

SIZE	PART #
5/8-11 SMALL	95040
5/8-11 LARGE	95041
1/2-13	95042
M10 X 1.25	95043



SPIRALCOOL™ SAIT-LOK™ & SAIT-LOK-R™ BACKING PADS FOR QUICK CHANGE DISCS

- Unique spiral face increases aggressiveness and improves disc life by staying cooler
- Available in hard density for aggressive cutting action
- Minimizes change-over time
- 1/4" shank

SAIT-LOK™

- Disc twists into metal threaded center of backing pad for fast and easy disc changes
- For use with SAIT-LOK™ laminated and surface conditioning discs



SIZE	MAX RPM	PART #
1" MEDIUM	40,000	95285
1-1/2" MEDIUM	25,000	95286
1-1/2" HARD	25,000	95386
2" MEDIUM	30,000	95287
2" HARD	30,000	95387
3" MEDIUM	20,000	95288
3" HARD	20,000	95388

SAIT-LOK-R™

- Nylon threaded hub of disc twists into backing pad for secure fit
- For use with SAIT-LOK-R™ laminated and surface conditioning discs, cotton fiber discs and Encore Mini Flap Discs



SIZE	MAX RPM	PART #
1-1/2" MEDIUM	25,000	95292
1-1/2" HARD	25,000	95392
2" MEDIUM	30,000	95293
2" HARD	30,000	95393
3" MEDIUM	20,000	95294
3" HARD	20,000	95394
4" MEDIUM	12,000	95295



PSA BACKING PADS

- For use with PSA adhesive backed sanding discs
- 1/4" Shank pads for die grinders
- Threaded pads for dual action/random orbital sanders and right angle grinders/sanders

	SIZE	MAX RPM	PART #
Portable Grinder	1 X 1/4	30,000	95059
	1-1/2 X 1/4	30,000	95060
	2 X 1/4	28,000	95061
	3 X 1/4	20,000	95062
	4 X 1/4	16,000	95063
	5 X 1/4	12,000	95064
Disc Sander	5 X 5/16-24	10,000	95065
	5 X 5/16-24 5 HOLES	10,000	95085
	6 X 5/16-24	10,000	95066
	6 X 5/16-24 6 HOLES	10,000	95086
	8" W/MOUNTING HOLES	10,000	95180
Angle Grinder	7 X 5/8-11	4,800	95068
	8 X 5/8-11	4,800	95067



HOOK & LOOP BACKING PADS FOR PAPER DISCS

- For use with Hook & Loop backed paper discs
- Available 5/16-24 thread

DESCRIPTION	MAX RPM	PART #
5 X 5/16-24	10,000	95047
5 X 5/16-24 5 HOLES	10,000	95057
5 X 5/16-24 8 HOLES	10,000	95058
6 X 5/16-24	10,000	95046
6 X 5/16-24 6 HOLES	10,000	95056
8" W/ 5 MOUNTING HOLES	1,500	95185
8 X 5/8-11	1,500	95187



HOOK & LOOP SOFT INTERFACE PADS

- For use with 5" and 6" Hook & Loop backing pads
- Excellent for final finishing as the soft foam backing makes the grain cut less and finish finer
- The perfect complement for the 4S/4V Hook & Loop products

DESCRIPTION	PART #
5" SOFT INTERFACE HOOK & LOOP PAD	95175
6" SOFT INTERFACE HOOK & LOOP PAD	95176



CONTOUR HAND PADS

- For manual use with Hook & Loop discs
- For more uniform finish when hand sanding

LENGTH	HOOK & LOOP PART #	PSA PART #
6"	95250	95260



PALM HAND SANDER

- For manual use with PSA or Sand-Light™ / Hook & Loop discs
- For more uniform finish when hand sanding

DIA	SAND-LIGHT™ PART #	PSA PART #
5"	95081	95091
6"	95082	95092

FLAP WHEEL & COATED ABRASIVE ACCESSORIES



1/4" SHANK ADAPTER KIT FOR FLAP WHEELS

- For converting 1" or 5/8" arbors to a 1/4" shank
- 1/4" shank adapter kit

PART #

95009



1/4" SHANK THREADED ADAPTER FOR FLAP WHEELS

- For use on United Abrasives 1/4-20 threaded flap wheels
- Facilitates a quick change, thus less downtime

PART #

95050



ABRASIVES CLEANING STICK

- For removing loaded material from sanding belts
- Increases abrasive life
- 100% natural rubber; environmentally safe
- Lasts twice as long as conventional (crepe) belt cleaners and will not cause gummy residue

SIZE

1-5/8 X 1-5/8 X 8

PART #

95083



HAND SANDING BLOCK

- For use with SAIT-PAK 9" x 11" Sheets

PART #

16000



SPIRAL BAND DRUMS

- For use with spiral bands

SIZE	MAX RPM	PART #
1/2 X 1/2 X 1/4	30,000	95121
1/2 X 1 X 1/4	15,000	95122
1/2 X 1-1/2 X 1/4	12,000	95123
3/4 X 1 X 1/4	19,000	95126
3/4 X 1-1/2 X 1/4	10,000	95127
1 X 1 X 1/4	18,000	95130
1-1/2 X 1 X 1/4	14,000	95133
1-1/2 X 1-1/2 X 1/4	10,000	95134
2 X 2 X 1/4	6,000	95137
3 X 3 X 1/4	3,000	95140



CARTRIDGE ROLL MANDRELS

- For use with straight and full taper cartridge rolls

SIZE	PART #
1/4 X 1-1/2 X 1/4	95101
1/4 X 1 X 1/4	95102
1/8 X 1-1/2 X 1/4	95103
1/8 X 1 X 1/4	95104
1/8 X 3/4 X 1/4	95105
3/16 X 1-1/2 X 1/4	95106
3/16 X 1 X 1/4	95107
3/32 X 3/4 X 1/8	95108



CROSS PAD & SQUARE PAD MANDRELS

- For use with cross and square pads
- 1/4" shank

SIZE	PART #
3-48	95095
8-32	95096
1/4-20	95097

NON-WOVEN ACCESSORIES



CONVOLUTE WHEEL REDUCING BUSHING

- Re-usable reducing bushings for use with convolute wheels
- Packaged per pair

DESCRIPTION	PART #
1" OD TO 3/4" ID FOR USE WITH 6" DIAMETER CONVOLUTE WHEEL	95210



HANDLE FOR NON-WOVEN HAND PADS

- For manual use with non-woven 6 x 9 hand pads
- For more uniform finish when hand sanding

PART #
95080



SURFACE CONDITIONING BACKING PADS

- For use with Hook & Loop style Sand-Light™ and surface conditioning discs
- 1/4" shank pads
- Threaded pads available for dual action random orbital sanders and right angle grinder/sander

	SIZE	MAX RPM	PART #
Portable Grinder	4 X 1/4	15,000	95154
	5 X 1/4	10,000	95153
Disc Sander	4 X 5/16-24	10,000	95157
	5 X 5/16-24	10,000	95155
	6 X 5/16-24	10,000	95156
Angle Grinder	4-1/2 X 5/8-11	6,000	95159
	5 X 5/8-11	6,000	95160
	6 X 5/8-11	6,000	95161
	7 X 5/8-11	4,800	95162
	8 X 5/8-11	4,800	95163



SUPER SOFT BUFFING DISC BACKING PADS

- For use with buffing discs
- Available in 5" & 7" with 5/8-11 thread

DESCRIPTION	MAX RPM	PART #
5" SUPER SOFT FOAM PAD	3,200	95255
7" SUPER SOFT FOAM PAD	3,200	95257

BUFFING COMPOUND BARS & KITS



COLOR	DESCRIPTION	SIZE	PART #
BROWN	Used for buffing aluminum, brass, copper, wood, plastics, hard rubber, and painted surfaces. Also called tripoli rouge.	1 lb. Bar	41024
WHITE	Used for buffing stainless steel, carbon steel, nickel, aluminum, and chromium to a high luster shine.	1 lb. Bar	41022
RED	For buffing precious metals like gold, silver, platinum, sterling, and other high-end metals. Can also be used to further enhance materials that have already been buffed with other compounds. The finest grade.	1 lb. Bar	41020
BLACK	Used to buff contaminants out prior to finishing. Will remove rust, stains, scale, and other contaminants. An extremely fast cutting material. Also called emery cake.	1 lb. Bar	41026
KIT	Buffing Compound Kit (Includes 1 - 6oz bar of each color)	-	41000

**** NEW ****



SAITLAB INOX POLISHING COMPOUNDS

SPEC	COLOR	DESCRIPTION	SIZE	PART #
CELESTE	LIGHT BLUE	Fine grade abrasive compound for polishing and mirror finishing of stainless steel and aluminum. Also called celeste.	500g Bar	41202
	BLU	Medium grade abrasive compound for polishing and finishing of stainless steel and aluminum.	500g Bar	41201





TECHNICAL INFO & SAFETY GUIDE



BONDED ABRASIVES

WHAT IS A BONDED ABRASIVE?

A resin bonded abrasive is a grinding or cutting tool composed of abrasive grains which are held tightly together by a bonding agent and typically reinforced with a woven material. Within the bonded abrasives category are grinding and cutting wheels, as well as “stones” in a variety of shapes and sizes.

MAIN COMPONENTS OF RESINOID BONDED ABRASIVES

Abrasive Grains

Abrasive grains, sometimes referred to as grit, are particles of man-made compounds. The chemical structure of the grains determines the physical properties such as the shape and sharpness of each particle along with its hardness and friability (the propensity to break down). Common grain types used in making bonded abrasives include:

A - Aluminum Oxide: A tough blocky shaped grain used for cutting metals and other high tensile strength materials without excessive fracturing.

C - Silicon Carbide: A very hard and very sharp abrasive suited for non-metallic materials such as concrete.

Z - Zirconium: A very fine, dense crystalline grain which can be used for rugged stock removal.

SG - Ceramic: A unique ceramic aluminum oxide that is two or three times tougher than standard aluminum oxide.

Bonding Agent

The bonding agent that holds the grains together determines the resistance of the wheel.

Reinforcement

The reinforcement material provides strength to operate the abrasive product at the marked maximum RPMs and to withstand lateral pressure that is applied during use. This critical element, unseen to the naked eye, determines the structural strength of the product.

COMBINING THE COMPONENTS

During the manufacturing process, these three components are combined to form an abrasive tool. The grains and bonding agents are measured, combined and then pressed in an automated hydraulic press. The items are then cured in temperature controlled ovens.

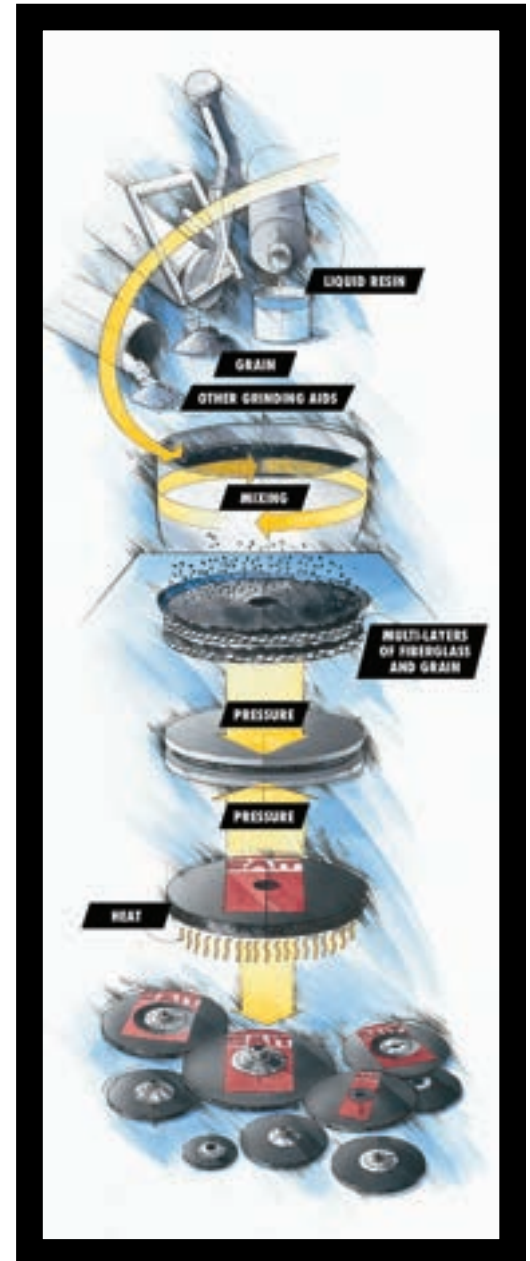

THE
U[®] ABRASIVES
SAIT
DIFFERENCE

- Only uses first quality, premium grains that are made to our specifications
- Never uses inferior fillers or bonding agents
- Always uses first quality, heavy duty fiberglass to ensure your safety
- The manufacturing process, from start to finish, incorporates state-of-the-art equipment, quality control analysis and compliance, and rigorous product evaluation to ensure our customers receive the safest, most consistent and best performing wheels on the market

HOW A WHEEL WORKS

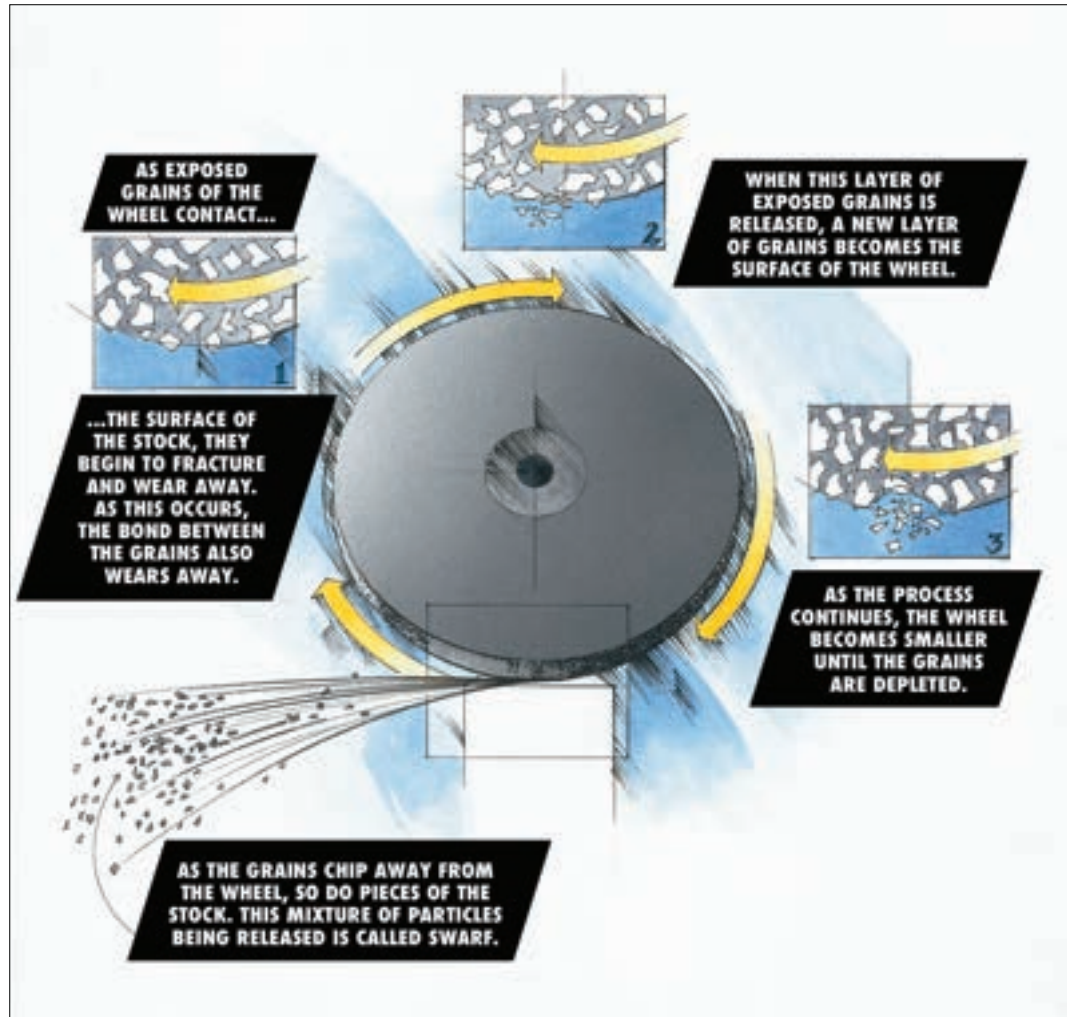

COMMON OCCURRENCES WITH GRINDING/CUTTING APPLICATIONS

As a wheel is grinding and/or cutting, some situations may occur with the application such as glazing or loading.



Solutions to Glazing

- Dress the wheel for a temporary solution
- Use a softer bond and/or coarser grit wheel



Solutions to Loading

- Dress the wheel for a temporary solution
- Use the correct wheel for the application

RESIN BONDED ABRASIVES



ANSI STANDARD MARKING SYSTEM

The following chart is an example of the ANSI standard marking system for identifying grinding wheels and other bonded abrasives.

A	25				R	BF	
Primary grain used to make the wheel	Size of the abrasive grain				Hardness of the bond	Type of bond used	
	Coarse	Medium	Fine	Very Fine	Soft	B = Resinoid	
A = Aluminum Oxide	8	30	70	220	Medium	BF = Resinoid Reinforced	
C = Silicon Carbide	10	36	80	240		N	E = Shellac
Z = Alumina Zirconium	12	46	90	280		R	O = Oxychloride
SG = Seeded Gel	14	54	100	320		T	R = Rubber
	16	60	120	400	Hard	RF = Rubber Reinforced	
	20		150	500		Z	S = Silicate
	24		180	600			V = Vitrified

WHEEL CONFIGURATIONS

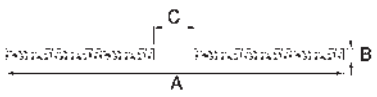
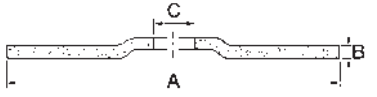
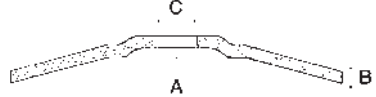
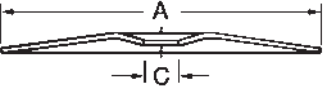
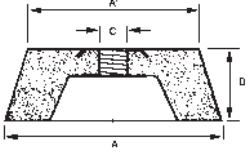
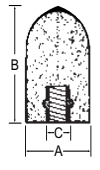
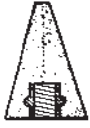
Bonded abrasive wheels have different configurations depending upon the tool the wheel is used on and the desired end result. Below are the configurations that a wheel can have:

<p>TYPE 1 / TYPE 41 – STRAIGHT WHEEL</p> 	<p>TYPE 27 / TYPE 42 – DEPRESSED CENTER WHEEL</p> 	<p>TYPE 28 – SAUCER-SHAPED WHEEL</p> 
<p>TYPE 29 – FLEXIBLE WHEEL</p> 	<p>TYPE 11 – FLARING CUP WHEEL</p> 	<p>TYPE 16 – ROUNDED CONE</p> 
<p>TYPE 17 – STRAIGHT-SIDED CONE</p> 	<p>TYPE 18 – PLUG</p> 	<p>TYPE 18R – ROUND PLUG</p> 

A = The diameter of the wheel

B = The width or thickness of the wheel

C = The bore of the wheel

EXCLUSIVE SUPER-LOCK™ HUB

Super-Lock™ combines a mechanically interlocked transversed key lock system with a unique two-part bonding system to give it superior performance capabilities. Other manufacturers use hubs that depend only on two-part epoxy which can fail in many instances due to poor surface preparation, improper curing conditions, incorrect ratio of catalyst and epoxy, or the quantity of epoxy material applied.

UNIQUE IN THE INDUSTRY

The United Abrasives Super-Lock™ system is our exclusive, fail-safe throw-away hub assembly. This is a unique hubbing system that is used on Type 27 and Type 28 grinding and cutting wheels where hub mounting is preferred.

UNSURPASSED PERFORMANCE

The rotational torque placed upon wheels can vary based on material being removed and pressure that is applied. While the chemical bonds that other manufacturers use can fail, the Super-Lock™ Hub ensures the stability of the hub-to-wheel connection.

MILLIONS SOLD - NOT ONE FAILURE

Since 1983, United Abrasives has manufactured and sold millions of depressed center wheels with Super-Lock™ Hubs. Not a single one has ever been reported as a failure.

PATENTED

The Super-Lock™ Hub system is so safe that it was originally protected by United States patent #4,541,205. United Abrasives is the only manufacturer to utilize this outstanding hub system.

USE ON TYPE 27 AND TYPE 28 WHEELS

The Super-Lock™ Hub System is available on 4-1/2", 5", 6", 7" and 9" Type 27 and Type 28 depressed center grinding and cutting wheels. Turbo 5" x 1/8", .045" wheels, .090" wheels, .095" wheels and flap discs do not have Super-Lock™ Hubs but use a non-keyway hub with the same unique two-part bonding system.

Look for this drawing throughout the catalog indicating the wheels that are available with the Super-Lock™ Hub.

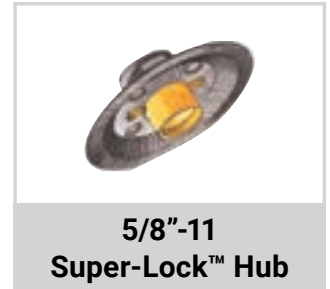

BEFORE

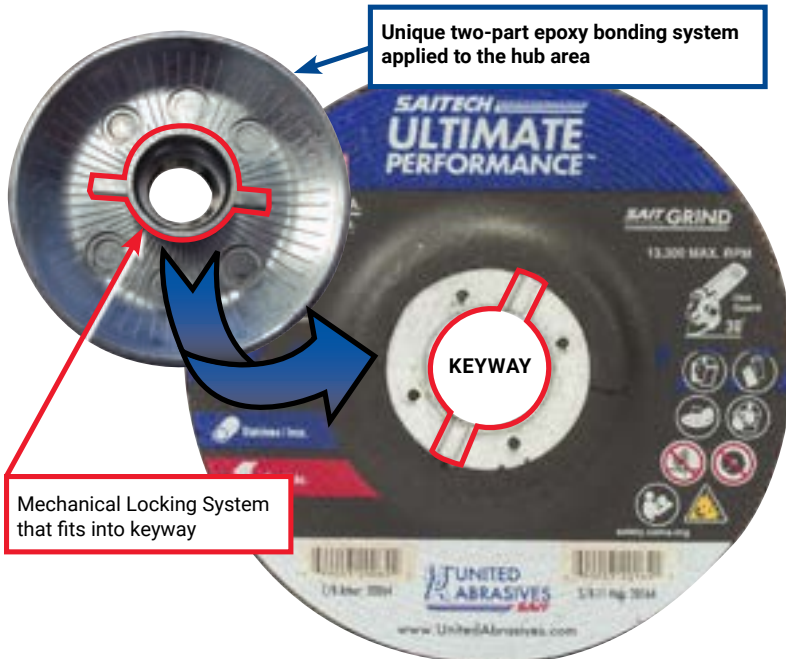

AFTER



SAFETY GUIDE

Important

The following information about safety should be used only as a guide. All products listed in this catalog shall be used in accordance with safety regulations set by OSHA and by the directive described by the American National Safety Institute B7.1, the Canadian Standard Association Safety Code B-173-5 and by the American Brush Manufacturers Association covering: Speed, Safety Guards, Flanges, Mounting Procedures, General Operating Rules, Handling, Storage, and Inspection of General Machine Conditions.

Operate Wheels at Recommended Speeds

It is imperative that abrasive wheels be operated at recommended safe speeds. For safety reasons no abrasive wheel shall be operated at a speed greater than that indicated on the blotter or wheel.

Warning

Avoid inhalation of dust generated by grinding and cutting operations. Exposure to dust may cause respiratory ailments as well as irritation to eyes and skin. In most cases, a greater hazard is the exposure to the dust/fumes from the base material being ground or paint or coatings applied to it. Use approved NIOSH or MSHA respirators, safety glasses or face shields, gloves and protective clothing. Provide adequate ventilation to eliminate dust or to maintain dust levels below the permissible exposure level for nuisance dust as classified by OSHA. Refer to Material Safety Data Sheet for further information.

All operators must read and understand safety information thoroughly.

Follow Safety Instructions

You must follow all operator and safety instructions, as well as all common safety practices which reduce the likelihood of physical injury.

DOs & DON'Ts

The information below is designed as a guide for the individual user of abrasive wheels, whether he be in the employ of a large corporation or in the confines of his home work shop. It is based on the premise that grinding/cutting is a safe operation when a few basic rules are followed. These rules are based on material contained in the American National Standards Institute Safety Requirements B7.1 - "Use, Care & Protection of Abrasive Wheels." Follow Them. A pamphlet including these Do's and Don'ts and other safety information is included in each box of wheels.

- **DO** always handle and store wheels in a careful manner.
- **DO** visually inspect all wheels before mounting for possible damage.
- **DO** make sure operating speed of machine does not exceed speed marked on wheel, its blotter or container.
- **DO** check mounting flanges for equal size, relieved as required and correct diameter.
- **DO** use mounting blotters as required by ANSI standards.
- **DO** be sure work rest is properly adjusted on bench, pedestal and floor stand grinders.
- **DO** always use safety guard that covers a minimum of one-half (1/2) the abrasive wheel.
- **DO** allow newly mounted wheels to run at operating speed, with guard in place, for at least one minute before grinding.
- **DO** always wear safety glasses or some type of approved eye protection while grinding or cutting.
- **DO** turn off coolant before stopping wheel to avoid creating an out-of-balance condition.
- **DO** follow common sense safety considerations.
- **DO** follow federal, state and local laws and regulations.
- **DON'T** use a wheel that has been dropped or appears to have been abused.
- **DON'T** force a wheel onto the machine or alter the size of the mounting hole. If the wheel won't fit the machine, get one that will.
- **DON'T** ever exceed maximum operating speed established for the wheel.
- **DON'T** use mounting flanges on which the bearing surfaces are not clean, flat and smooth.
- **DON'T** tighten the mounting nut excessively.
- **DON'T** grind on the side of conventional, straight or Type 1 wheels.
- **DON'T** use a wheel on any machine that is not properly designed for the specific application of the wheel.
- **DON'T** start the machine until the safety guard is properly and securely in place.
- **DON'T** jam work into the wheel.
- **DON'T** stand directly in front of a grinding/cutting wheel whenever a machine is in operation.
- **DON'T** grind or cut material for which the wheel is not designed.

STORAGE AND HANDLING

BONDED ABRASIVES

All abrasive wheels are breakable and therefore care shall be exercised in handling and storage to prevent damage.

The following rules, which are based on experience, shall be observed:

- Handle wheel carefully to prevent dropping or bumping
- Do not roll wheels (hoop fashion)
- Use trucks or other suitable conveyances to provide support and protection in transporting all wheels which cannot be carried by hand
- Suitable racks, bins, drawers or boxes shall be provided to store the various types of wheels used
- Abrasive wheels should be stored in a dry area not subject to extreme temperature changes since some bonds may be affected by excessive humidity and temperature differentials
- Racks should be located as near as practical to the grinding location, but never where there is danger of damage from passing trucks, crane handling equipment or excessive vibration
- Please refer to the Safety Guide accompanying the product and on the previous page of this catalog

COATED ABRASIVES

Incorrect storage of coated abrasives will significantly affect performance. All types of backings are susceptible to variations in temperature and humidity during storage:

- Keep stockroom at constant levels of humidity (35-50%) and temperature (60-80° F)
- Keep cartons away from damp or cold walls and floors where they may absorb moisture
- Store coated abrasives away from any heat source
- Keep products in original packages for easy handling and stacking
- Flap wheels removed from the original packaging should be spread out on a clean shelf, always placed face down, never resting on edge
- Fiber discs removed from the original packaging should be stored in a suitable disc holder and kept under pressure
- Store bulk rolls flat on shelves or pallets, not on edge
- Belts removed from packing case should be rolled up and stood on edge on a clean shelf. They may be draped over a large cylinder but never hang a belt from a nail or peg (the backing will crease and the abrasive coat will crack)
- Precondition the coated abrasive products in a humidity and temperature controlled environment before use for maximum efficiency

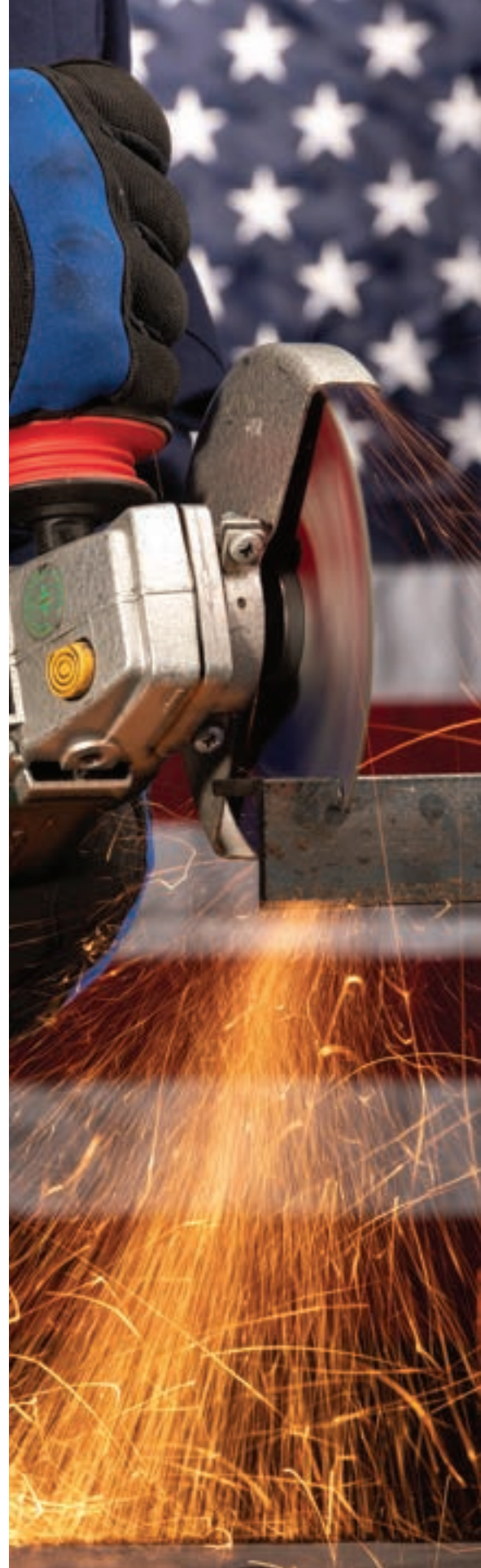

INDEX BY PART NUMBER

Product No.	Page	Product No.	Page	Product No.	Page
00501-00516	123	20171-20172	12	23265-23276	39
01401-01408	119	20173.....	9	23305.....	31
01411.....	118	20174.....	11	23306.....	33
02701-02714	122	20175-20195	9	23307.....	31
03373-03378	120	20204-20219	11	23308.....	33
03380-03384	121	20229.....	48	23309-23318	31
03385-03388	120	20280-20295	9	23319.....	33
03389-03391	121	20903-20956	35	23320.....	31
03406-03413	118	21000-21099	13	23321.....	33
03414-03422	119	22000.....	37	23322-23337	31
03426-03431	120	22007.....	17	23360-23365	12
03440-03459	121	22010.....	37	23405.....	48
03460-03461	120	22011.....	31	23410-23412	46
03501-03514	119	22015.....	17	23413.....	47
04110-04390	124	22020.....	37	23414.....	46
05751-05768	123	22021.....	31	23415.....	47
06373-06378	120	22025.....	38	23420-23422	46
06380-06384	121	22030-22042	17	23423-23425	47
06385-06388	120	22045.....	37	23450.....	46
06389-06391	121	22046.....	17	23451.....	47
06401-06404	119	22047.....	31	23452.....	46
06407.....	118	22052.....	17	23453.....	47
06408.....	119	22053.....	31	23455.....	46
06409-06412	118	22055.....	17	23456.....	47
06414-06419	119	22056-22057	37	23457.....	46
06426-06431	120	22062.....	17	23458.....	47
06440-06459	121	22064.....	37	23459.....	46
06460-06461	120	22065.....	17	23460-23480	47
06501-06514	119	22066-22067	37	23501-23502	46
06551-06559	118	22068.....	33	23604-23606	31
06701-06714	122	22069-22070	37	23804-23827	35
09551-09560	118	22071.....	31	24002-24003	49
09570.....	122	22072-22073	33	24010.....	45
10006-10036	90	22074-22079	37	24011.....	44
16000.....	134	22082.....	33	24013.....	45
20002-20013	9	22084.....	37	24020.....	49
20014.....	11	22088.....	33	24030.....	45
20015.....	9	22089-22120	37	24031.....	44
20018.....	12	22125.....	38	24033.....	45
20020-20040	17	22130-22140	17	24034.....	44
20046-20049	11	22170.....	37	24035.....	45
20050-20060	9	22230-22240	33	24039.....	44
20061-20062	12	22264-22299	17	24040.....	49
20063.....	9	22320-22336	36	24050.....	45
20064.....	11	22345-22370	31	24051.....	44
20065-20070	9	22380-22390	33	24052-24053	45
20071-20072	12	22414-22419	11	24061-24102	49
20073.....	9	22420-22436	36	24135-24160	46
20074.....	11	22444-22449	17	24210-24230	12
20075-20081	9	22470-22482	33	24251-24254	33
20082-20083	12	22514-22519	11	24310-24330	38
20084.....	11	22544-22549	17	24414.....	45
20085-20086	9	22570-22571	33	24500.....	44
20087-20088	12	22599-22616	9	24999-25009	21
20089.....	11	22620-22636	17	25010-25062	23
20090-20091	9	22641-22654	37	25101-25306	21
20092.....	12	23002-23075	41	26000-26063	18
20094.....	11	23099.....	31	27010-27414	20
20095-20096	9	23100.....	42	27500-27810	14
20097.....	12	23101.....	31	28000-28162	22
20099-20112	11	23102.....	42	29201-29214	24
20120-20140	17	23103-23107	31	29310-29322	25
20146-20149	11	23140-23171	41	34110-34175	85
20150-20160	9	23172-23184	33	34210-34627	86
20161-20162	12	23200-23211	39	34990-35241	87
20163.....	9	23234-23235	42	35300-35317	85
20164.....	11	23250-23253	39	35319-35364	86
20165-20170	9	23258.....	42	35400-35417	85

Product No.	Page	Product No.	Page	Product No.	Page
35420-35448	86	59113-59155	76	80807	96
36300-36317	85	59224-60011	75	80815-81030	95
36319-36364	86	60016-60064	80	81101-81108	96
36400-36417	85	60071-60075	75	81205-81206	95
36420-36438	86	60086-60582	80	81207	96
36500-36528	85	60623-60688	81	81215-81806	95
36540-36568	86	60772-61151	80	81807	96
36600-36628	85	61201-61310	83	81815-83430	95
36640-36658	86	63230-63386	81	84050-84086	93
36800-36909	85	64016-65112	82	84089-84097	96
37081-37239	87	66104-66196	80	84101-84108	90
37501	86	66406-66505	82	84171-84174	94
37505-37511	85	67374-67421	80	84200-84216	90
37515-37601	86	69224-69680	75	84230-84239	91
37605-37611	85	70001-70113	70	84249-84277	90
37615-37651	86	70800-70984	67	84283-84291	91
37800-37908	85	71000-71181	70	84308-84315	93
38001-38134	100	71205-71281	65	84422-84431	91
38300-38346	101	71285-71403	63	84907-84918	92
41000	136	71710-71824	110	85000-85013	97
41012-41013	115	71980-71994	69, 112	85100-85237	98
41020-41026	136	72000-72145	71	85285-85289	97
41055-41057	115	72200-72259	63	85300-85307	99
41201-41202	136	72261-72264	65	86355-86481	94
42001-42054	102	72300-72353	63	88002-88003	99
45000-45693	127	72361-72940	65	88006-88812	98
48006-48063	103	73401-73404	68	95000	130
48501-48744	54	73520	68, 115	95002-95002	114
48800-48806	55	74050-74072	70	95002-95008	130
49002-49026	19	74820-74835	68	95009	134
50000-50097	74	76206-76361	65	95010-95022	131
50100-50110	77	77115-77146	108	95030-95037	130
50120-50165	74	77162-77185	109	95040-95043	131
50166-50200	75	77200-77215	108	95046-95047	133
50208-50284	89	77230-77255	113	95050	134
50290-50297	74	77260-77265	108	95055	130
50300-50311	25	77270-77280	113	95056-95068	133
50320-50334	89	77300-77321	108	95080	136
50338-50359	76	77325-77332	110	95081-95082	133
50360-50368	24	77335-77355	113	95083	134
50370-50373	76	77360-77365	108	95085-95092	133
50383-50387	74	77382-77395	109	95095-95097	135
50510-50533	76	77440-77496	106	95100	23
50560-50566	24	77500-77577	107	95101-95108	135
50920-50965	89	77648-77662	108	95110-95119	131
50999-51019	76	77672-77685	109	95121-95140	135
51022-51120	74	77700-77716	111	95153-95163	136
51342-51375	76	77720-77728	69, 112	95175-95187	133
52100-52125	74	77730-77756	111	95203-95206	118
52208-52334	89	77760-77767	69, 112	95210	136
52400-53120	74	77780-77807	111	95245-95247	130
54016-54220	77	77810-77825	115	95250	133
55215-55282	89	77830-77900	114	95255-95257	136
55342-55367	81	77915	52	95260	133
55420-55464	89	77917	53	95285-95394	132
56024-56120	74	77920-77921	52		
56217-56282	89	77922	53		
56313-56353	76	77930-77931	52		
56361-56476	77	77932-77933	53		
57016-57090	74	77936	52		
57100-57113	80	77937-77938	53		
57120	74	77940	52		
57200-57213	80	77942	53		
57224-57480	76	77947-77953	52		
57500-57513	80	77955	53		
57524-57780	76	77962-77965	52		
57900-57913	80	77966	53		
58016-58120	74	77972-77975	52		
58132-58156	82	77976-77977	53		
58160-58199	81	78005-79211	65		
58207-58222	77	80000	96		
58224-58280	75	80405-80606	95		
58307-58322	77	80607	96		
58324-58780	75	80615-80806	95		



COMPANY TIMELINE

UNITED ABRASIVES, INC.
ESTABLISHED MOUNT
VERNON, NEW YORK



COMPANY MOVED TO
NORTH WINDHAM,
CONNECTICUT

DISTRIBUTION
CENTER OPENED IN
MISSISSAUGA, CANADA



1953

1975 - 1983

1993

1970

1984

1990



SAIT ABRASIVI
FOUNDED IN ITALY



SUPER-LOK™ HUB
INVENTED AND
PATENTED

SUPER-LOK™
HUB



FIRST UNITED ABRASIVES/ SAIT BONDED ABRASIVE
WHEEL PRODUCED IN THE USA



DISTRIBUTION
CENTER OPENED
IN SALT LAKE
CITY, UTAH