

RELIABLE CUTTING TOOLS FOR EVERY MACHINE SHOP

# CUTTING TOOLS

INCH | 2022



**WIDIA** 

 **HANITA**

For more than 95 years, the WIDIA™ brand has delivered high-quality milling, turning, holemaking, tapping, and systems tooling to metalcutting customers across the globe. Customers experience reliability from selection to post-delivery support through product availability, digital connectivity, and an accessible network of authorized distribution partners.

For more information regarding the WIDIA brand or products, visit [widia.com](http://widia.com) or connect with us on Instagram, Facebook, LinkedIn, and YouTube.



WIDIA is a brand for machinists, mechanical engineers, and machine shop owners who are depending on a reliable tool to keep their shop running through the night.

The brand offers a full portfolio of standard milling, drilling, holemaking tools, technical information, and support to everyday consumers.

WIDIA tools are sold through distribution partners. Find a distributor in your area by using the distributor finder on [widia.com](http://widia.com).



Hanita™ solutions are developed for customers who have a passion for performance. Hanita delivers not only the tool for the job but the experience to develop a solution for the customer.

The Hanita brand offers a comprehensive range of custom and standard end mills spanning a broad range of diameters and lengths, all boasting unparalleled metal removal rates through innovative geometries.

Hanita solutions are sold primarily through WIDIA channel partners, alongside WIDIA.



# Table of Contents

## Rotating Tools

<b>Indexable Milling</b> .....	<b>A3–A207</b>
Face Milling .....	A4–A77
0°/90° Shoulder Milling.....	A78–A145
High-Speed Milling.....	A146–A153
High-Feed Milling .....	A154–A179
Copy Milling .....	A180–A199
ISO and General Milling Inserts.....	A200–A207
<b>Solid End Milling</b> .....	<b>B3–B370</b>
WIDIA Multi-Purpose End Mills.....	B4–B91
Burs.....	B92–B115
Hanita High-Performance Solid Carbide End Mills.....	B119–B370
<b>Holemaking</b> .....	<b>C3–C117</b>
Solid Carbide Drills.....	C8–C46
Modular Drills .....	C48–C87
Indexable Drills.....	C88–C117
<b>Tapping</b> .....	<b>D3–D133</b>
High-Performance Taps Selection Guide .....	D4–D19
General Purpose .....	D20–D63
Multipurpose .....	D64–D88
Aerospace Fastener .....	D90–D95
High Performance .....	D96–D126
Technical Information.....	D127–D133

## Stationary Tools

<b>Turning</b> .....	<b>E3–E520</b>
External Turning and Internal Boring.....	E4–E300
Grooving and Cut-Off.....	E302–E439
Threading .....	E440–E520
<b>Customer Application Support</b> .....	<b>F2</b>
<b>Informational Icons Guide</b> .....	<b>F3–F7</b>
<b>All-Star Program</b> .....	<b>F8–F9</b>
<b>Material Cross Reference</b> .....	<b>F10–F11</b>

# Spare Parts & Accessories Information

**Lost a screw? Have to replace worn-out clamping wedges?  
Need to find and re-order those spare parts?**

Are you in need of some accessories, like a torque wrench or coolant shower plate? These tools are at your fingertips!  
Go to **widia.com** and find what you need in seconds. Enter the catalog number of the corresponding tool, and it will display.

**STEP 1** Enter the tool catalog number here

SAP Material Number	648303
ISO Coding Number	M120001060373324N11
[D1] Effective Cutting Diameter	100.0000
[D1MAX] Maximum Cutting Diameter	111.8000
[D] Adapter / Shank / Bore Diameter	32.0
[Dn] Hub Diameter	78.0000
[L] Overall Length	90.0000
[L1] Oage Length	80.0000
[AP1 MAX] 1st Maximum Cutting Depth	7.5000
Number of Inserts	7
Coolant Supply	N
Weight Kilograms	1.49

**STEP 2** Select the spare parts & accessories

Spare Parts for M1200 MAX Screw Clamping • 56° • Shell Mills • Metric

- INSERT SCR M1200
- 2030 TORX SCREWDRIVER T20
- Spare Part ANH 5003 LUBRICANT



# WIDIA™ Digital Solutions



## WIDIA Machining Central

WIDIA™ Machining Central Mobile App  
Download for iOS or Android™:  
[widia.com/en/featured/WidiaMobileApp](http://widia.com/en/featured/WidiaMobileApp)

## Product Data

- Tooling Dimensional Data
- Feeds and Speeds
- Inventory Availability
- ...and More!

## Tools and Resources at Your Fingertips



## DOWNLOAD THE WIDIA MOBILE APPS TODAY!



[www.youtube.com/c/widiatools](http://www.youtube.com/c/widiatools)



[www.linkedin.com/company/widiatools/](http://www.linkedin.com/company/widiatools/)



[www.instagram.com/widiatools/](http://www.instagram.com/widiatools/)



[www.facebook.com/widiatools](http://www.facebook.com/widiatools)



TO SEE ALL PRODUCT LINES, VISIT OUR DIGITAL RESOURCES



**WIDIA™ Machining Central  
Mobile App**  
Download for iOS or Android™:  
[widia.com/en/featured/  
WidiaMobileApp](https://www.widia.com/en/featured/WidiaMobileApp)



[widia.com](https://www.widia.com)



[www.youtube.com/c/widiatools](https://www.youtube.com/c/widiatools)



[www.linkedin.com/company/widiatools/](https://www.linkedin.com/company/widiatools/)



[www.instagram.com/widiatools/](https://www.instagram.com/widiatools/)



[www.facebook.com/widiatools](https://www.facebook.com/widiatools)





## Speed

The WIDIA™ brand encompasses a variety of standard tooling designed to perform well in a range of typical machine shop operations. A team of experienced application support specialists is readily available to help increase productivity in your shop via WIDIA website chat or over the phone for every step of the way.

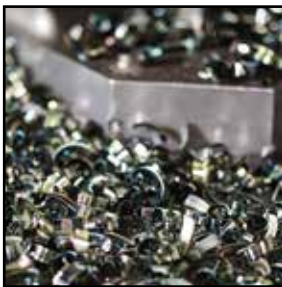

## Simplicity

Machinists can rely on the NOVO™ machining advisor or [widia.com](http://widia.com) to easily select the right tool for the job.



## Reliability

Trust our network of authorized distributors to put WIDIA tools to work for you — in your industry, in your region, and in your business. Together we will keep your machine running through the night.

---

For more than 95 years, the WIDIA brand has delivered quality milling, turning, holmaking, tapping, and systems tooling to metalcutting customers across the globe. Customers experience reliability from selection to post-delivery support through product availability, digital connectivity, and an accessible network of authorized distribution partners.

Test WIDIA tooling today by selecting tools from the All-Star program. The All-Star program is comprised of proven tooling solutions that are easy to find and always available. This includes solid end mills, turning tools, drills, and taps from our most popular platforms, grades, and sizes grouped into one program and guaranteed to be in stock with same-day shipping on orders placed before 6pm ET.

Visit [widia.com](http://widia.com) to see what products are available for same-day shipping through All-Star.





# Indexable Milling

<b>Technical Information</b> .....	<b>A4–A13</b>
<b>Face Milling</b> .....	<b>A14–A77</b>
Portfolio Overview .....	A14–A15
M640 .....	A16–A21
M1600 Series .....	A22–A29
M1200 Series .....	A30–A47
M8065HD .....	A48–A52
M8090 Series .....	A54–A61
M4070 .....	A62–A66
SuperFeed .....	A68–A73
M4000 .....	A74–A76
<b>0°/90° Shoulder Milling</b> .....	<b>A78–A145</b>
Portfolio Overview .....	A78–A79
VSM11 .....	A80–A89
VSM17 .....	A90–A99
VSM22 .....	A100–A104
VSM490 Series .....	A106–A120
VSM890 Series .....	A122–A127
M680 Series .....	A128–A133
M690 .....	A134–A145
<b>High-Speed Milling</b> .....	<b>A146–A153</b>
VHSC .....	A146–A153
<b>High-Feed Milling</b> .....	<b>A154–A179</b>
VXF Series .....	A154–A171
M370 Series .....	A172–A179
<b>Copy Milling</b> .....	<b>A180–A199</b>
M100 Series .....	A180–A199
<b>ISO and General Milling Inserts</b> .....	<b>A200–A207</b>
Copy Milling ISO Inserts .....	A202–A203
Face Milling ISO Inserts .....	A204–A206
Shoulder Milling ISO Inserts .....	A207

## Choosing the Correct Cutter

### Find and Select the Right Milling Cutter

**1. Identify material to be machined:**

A Each tool has a material grid marked with a letter indicating the materials that can be machined.

**2. Select tool based on maximum depth of cut and diameter required:**

B Information is given in this area to provide specific detail as a quick reference.  
 C Informational Icons. Connection type and possible operations.

**3. Select product name**

D Navigate to introduction detail, toolbodies, inserts, and cutting data within section.

Face Milling Portfolio Overview						
Face Milling	SuperFeed™	MA40	MA60	M1600 Mini-F	M1600	M1200 Mini
Page	A66-A69	A16-A17	Find at <a href="#">widia.com</a>	A22-A23	A22-A23	A30-A31
Work Piece Materials						
Max. Axial Depth of Cut (Ap1 Max)	0.250" 6.35mm	0.06" 1.52mm	0.250" 6.4/8.0mm	0.06" 1.52mm	0.140" 3.7mm	0.186" 4.7mm
Approach/Lead Angle Metric (inch)	90° (0°)	50° (32°)	45°	45°	43° (47°)	15/45/59° (75/45/31°)
Effective Cutting Edges	1	6	4	16	16	12
Diameter Range	1-3" 25-200mm	1.25-4" 32-125mm	1-6" 20-160mm	2-6" 80-160mm	3-6" 50-160mm	1-5" 25-125mm
Insert Style	Single-Sided	Single-Sided	Single-Sided	Double-Sided	Double-Sided	Double-Sided
Ground Insert						
Pressed to Size Insert						
Insert Nose Radii	0.03/0.060" 0.8/2.36mm	0.035/0.039" 0.90/0.98mm	Not applicable	0.031" 0.8mm	0.047" 1.2mm	0.047/0.126" 1.2/3.2mm
Embedded Wiper Facet	0.06" 1.52mm	—	0.61-0.079" 1.54-2.0mm	0.024" 0.6mm	0.03" 0.76mm	0.057-0.064" 1.454-1.6mm
Separate Wiper Insert						
Cutter Pitch	fine	coarse	regular	regular	regular	coarse & fine
Workpiece Floor Finish						
Screw Clamping						
Wedge Clamping						
Additional Operations						
Shell Mills						
Screw-On End Mills						
Cylindrical End Mills						
Weldon® End Mills						
Cartridge for MA000						



You can also use our NOVO app to guide you to the correct choice!

For more information, please visit [www.widia.com/novo](http://www.widia.com/novo).



## Determining Cutting Data

### Selecting Tool Body, Insert, and Cutting Data

#### 4. Choose the tool body:

Choose diameter (D1) and pitch (Z) of tool body.

NOTE: Make sure you select the correct shank style for your toolholder. For toolholders, visit [widia.com](http://widia.com).

**Face Mills • M1200 Series**

**M1200 Mini • Shell Mills**

order number	catalog number	D1	D1 max	D	D6	L	Ap1 max	Z	max RPM	coolant supply	Rs
4158481	M1200D150Z645550HNC7	1.500	1.813	.500	1.440	1.375	.136	4	15800	Yes	.58
4158482	M1200D150Z645550HNC7	1.500	1.813	.500	1.440	1.375	>.136	4	15800	Yes	.67

#### 5. Choose the inserts with the WIDIA™ insert selection guide:

- A Determine light machining, general purpose, or heavy machining according to workpiece material. See the Material Overview at the end of the catalog for material descriptions.
- B Select the grade given in the insert selection guide. Use the six-digit order number to easily place your order.

Material Group	Light Machining		General Purpose		Heavy Machining	
	Geometry	Grade	Geometry	Grade	Geometry	Grade
P1-P2	E, LD	WP45PM	S, GD	WP40PM	S, HD	WP45PM
P3-P4	E, LD	WP35PM	S, GD	WP35CM	S, HD	WP35CM
P5-P6	E, LD	WP25PM	S, GD	WP25CM	S, HD	WP25CM
M1-M2	E, LD	WP25PM	S, GD	WP25PM	S, HD	WP25PM
M3	E, LD	WP35CM	S, GD	WP35CM	S, HD	WP35CM

**5A**

ISO catalog number	ANSI catalog number	cutting edges	D	L10	S	BS	Rr	hm	THM-U	THM-O	THM-S	THM-T	THM-V	THM-W	THM-X	THM-Y	THM-Z
HNPJ5704ANSNGD	HNPJ5704ANSNGD	12	13	.500	.800	.360	4.45	.175	1.45	.067	1.20	.047	0.10	.004			

**5B**

#### 6. Determine cutting data — with the WIDIA Recommended Speeds and Feeds tables:

- A Choose the recommended speed value according to the workpiece material and grade.
- B Choose the recommended starting feed rate according to the insert geometry and % of radial engagement ae.

Starting values are given in bold.

Material Group	WP35CM			WK15CM			WU20PM			
	1	2	3	1	2	3	1	2	3	
P	1400	1300	1310	—	—	—	1080	550	880	
K	920	840	750	—	—	—	900	620	660	
M	840	750	670	—	—	—	840	620	570	
N	620	570	520	—	—	—	740	620	490	
S	850	750	690	—	—	—	610	670	490	
H	520	440	—	—	—	—	540	430	330	
B	610	510	—	—	—	—	610	390	540	
I	2	610	520	490	—	—	610	520	430	
J	3	480	430	380	—	—	460	390	310	
L	1	970	870	790	1380	1260	1120	820	720	610
M	2	770	690	620	1100	970	900	660	590	490
N	3	640	570	520	920	820	750	590	490	390
O	1	—	—	—	—	—	—	1800	1540	1310
P	2	—	—	—	—	—	—	1800	1540	1310
Q	3	—	—	—	—	—	—	1310	1150	980
R	1	—	—	—	—	—	—	130	110	80
S	2	—	—	—	—	—	—	130	110	80
T	3	—	—	—	—	—	—	180	130	80
U	1	—	—	—	—	—	—	230	180	110
V	2	—	—	—	—	—	—	360	260	230

**6A**

Insert Geometry	Programmed Feed per Tooth (fz) as a % of Radial Depth of Cut (ae)															
	5%	10%	15%	20%	30%	40-100%	Insert Geometry									
E, LD	.007	.013	.020	.025	.039	.070	.004	.007	.014	.023	.036	.012	.021	.036	.011	F, LD
S, HD	.007	.020	.025	.025	.014	.009	.004	.007	.011	.023	.039	.019	.033	.055	.017	F, LD
S, HD	.010	.020	.025	.025	.024	.008	.008	.018	.028	.035	.015	.025	.034	.014	.021	S, LD
S, HD	.013	.020	.025	.025	.024	.008	.007	.018	.028	.035	.015	.025	.034	.014	.021	S, LD
S, Ceramic	.007	.013	.020	.025	.009	.014	.004	.007	.011	.023	.036	.009	.021	.036	.006	S, Ceramic

**6B**

NOTE: Use "Light Machining" value as starting feed rate.

## Inserts • Catalog Numbering System

Each character in our catalog number signifies a specific trait of that product. Use the following key columns and corresponding images to easily identify which attributes apply.

### H

Insert Shape

### N

Insert Clearance Angle

### P

Tolerance Class

### J

Geometry and Clamping Type

symbol	hole	shape of hole	chipbreaker	shape of insert's section
N	without		without	
R			single-sided	
F			double-sided	
A	with	cylindrical hole	without	
M			single-sided	
G			double-sided	
W	with	partly cylindrical hole, 40-60° countersink	without	
T			single-sided	
Q	with	partly cylindrical hole, 40-60° double countersink	without	
U			double-sided	
B	with	partly cylindrical hole, 70-90° countersink	without	
H			single-sided	
C	with	partly cylindrical hole, 70-90° double countersink	without	
J			double-sided	
X	special design			

indexable inserts with facets/wipers

indexable inserts with corner radii

insert thickness

iC	tolerances on "iC"		tolerances on "M"	
	classes J, K, L, M, N (+/-)	class U (+/-)	classes M & N (+/-)	class U (+/-)
4,76-10,00	0,051	0,076	0,076	0,127
11,11-14,29	0,076	0,127	0,127	0,203
15,00-20,64	0,102	0,178	0,152	0,279
22,00-31,16	0,127	0,254	0,178	0,381
31,75-35,00	0,152	0,254	0,2	0,381

	iC (+/-)	M (+/-)	T (+/-)		iC (+/-)	M (+/-)	T (+/-)
A	0,025	0,005	0,025	J	0,05-0,15*	0,005	0,025
B	0,025	0,005	0,013	K	0,05-0,15*	0,013	0,025
C	0,025	0,013	0,025	L	0,05-0,15*	0,025	0,025
D	0,025	0,013	0,013	M	0,05-0,15*	0,08-0,20*	0,013
E	0,025	0,025	0,025	N	0,05-0,15*	0,08-0,20*	0,025
F	0,013	0,005	0,025	P**	0,038	0,038	0,038
G	0,025	0,025	0,013	U	0,08-0,25*	0,13-0,30*	0,013
H	0,013	0,013	0,025				

\*See table above for tolerances according to insert size and class.  
\*\*WIDIA standard only.

## Inserts • Catalog Numbering System

(continued)

<b>07</b>	<b>04</b>	<b>AN</b>	<b>S</b>	<b>N</b>	<b>GD</b>																		
Size (Cutting Edge Length)	Insert Thickness	Corner Configuration	Cutting Edge Form	Insert Hand	Edge Geometry																		
	<table border="1"> <thead> <tr> <th>symbol</th> <th>thickness</th> </tr> </thead> <tbody> <tr><td>T1</td><td>1,98</td></tr> <tr><td>02</td><td>2,38</td></tr> <tr><td>03</td><td>3,18</td></tr> <tr><td>T3</td><td>3,97</td></tr> <tr><td>04</td><td>4,76</td></tr> <tr><td>05</td><td>5,56</td></tr> <tr><td>06</td><td>6,35</td></tr> <tr><td>07</td><td>7,94</td></tr> </tbody> </table>	symbol	thickness	T1	1,98	02	2,38	03	3,18	T3	3,97	04	4,76	05	5,56	06	6,35	07	7,94		<p>F sharp</p> <p>E honed</p> <p>T T-land</p> <p>S honed + T-land</p>	<p>direction of cutter rotation</p>	
symbol	thickness																						
T1	1,98																						
02	2,38																						
03	3,18																						
T3	3,97																						
04	4,76																						
05	5,56																						
06	6,35																						
07	7,94																						

inscribed circle "iC" versus cutting edge length "L"  
For shapes A, L, and X, see position #1; use length of leading cutting edge.

iC	"L" for shapes						
	S	T	R	O	C	H	E
6,00	-	-	06	-	-	-	-
6,35	06	11	06	02	06	03	06
8,00	-	-	08	-	-	-	-
9,52	09	16	09	04	09	05	09
10,00	-	-	10	-	-	-	-
12,00	-	-	12	-	-	-	-
12,70	12	22	12	05	12	07	13
15,88	15	27	15	06	16	09	16
16,00	-	-	16	-	-	-	-
19,05	19	33	19	07	19	11	19
20,00	-	-	20	-	-	-	-
25,00	-	-	25	-	-	-	-
25,40	25	4					

radius			
		<p>leading or major cutting edge</p> <p>facet or wiper edge</p> <p>assumed direction of feed motion</p>	
<b>M0</b>	<b>round insert</b>		<b>wiper edge clearance P</b>
01	0,1mm	If letter is replaced by number(s), refer to table for radius "r."	A
02	0,2mm		B
04	0,4mm		C
05	0,5mm		D
08	0,8mm		E
10	1,0mm		F
12	1,2mm		G
15	1,5mm		N
16	1,6mm		P
24	2,4mm		
32	3,2mm		
		<b>lead angle K</b>	
		A	3°
		B	5°
		C	7°
		D	15°
		E	20°
		F	25°
		G	30°
		N	0°
		P	11°







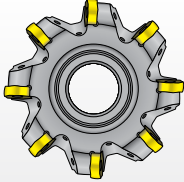





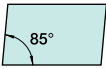
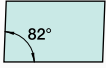



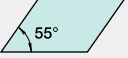
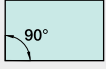





## Tool Bodies • Catalog Numbering System

Each character in our catalog number signifies a specific trait of that product. Use the following key columns and corresponding images to easily identify which attributes apply.

<p><b>M1200</b></p>	<p><b>D</b></p>	<p><b>100</b></p>	<p><b>Z</b></p>	<p><b>03</b></p>	<p><b>C</b></p>
<p>Series</p>	<p>Cutting Diameter</p>		<p>Number of Flutes</p>		<p>Shank Form</p>
			<p>Z = Number of effective flutes</p> 	<p>C = Cylindrical W = Weldon® M = Modular S = Shell Mill</p>	

## Tool Bodies • Catalog Numbering System

(continued)

100	H	N	07	L	800
Shank/Pilot Diameter	Insert Shape	Insert Clearance Angle	Insert Size (Cutting Edge Length)	Overall Length of Tool Used for all cylindrical shank and long version Weldon® if required (standard Weldon without)	
<p><b>A</b> </p> <p><b>B</b> </p> <p><b>C</b> </p> <p><b>D</b> </p> <p><b>E</b> </p> <p><b>H</b> </p> <p><b>K</b> </p> <p><b>L</b> </p>	<p><b>M</b> </p> <p><b>O</b> </p> <p><b>P</b> </p> <p><b>R</b> </p> <p><b>S</b> </p> <p><b>T</b> </p> <p><b>V</b> </p> <p><b>W</b> </p> <p><b>X</b> Special Design</p>	<p><b>C</b> </p> <p><b>D</b> </p> <p><b>E</b> </p> <p><b>F</b> </p> <p><b>G</b> </p> <p><b>N</b> </p> <p><b>P</b> </p>	<p>Optional uses as required</p> <p><b>LH</b> Left Hand</p> <p><b>C</b> Carbide Shank</p> <p><b>HM</b> Heavy Metal Shank</p> <p><b>J</b> JIS Standard</p>		

INDEXABLE MILLING

SOLID END MILLING

HOLE/MAKING

TAPPING

TURNING

## Grades and Grade Descriptions

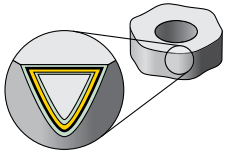

Modern coating technologies provide higher speed capabilities, greater productivity, and longer tool life.

Each insert has a material grid indicating primary and alternate uses for that tool, as well as whether it can be operated dry or with coolant.

<b>P</b>	Steel
<b>M</b>	Stainless Steel
<b>K</b>	Cast Iron
<b>N</b>	Non-Ferrous
<b>S</b>	High-Temp Alloys
<b>H</b>	Hardened Materials

primary use		alternate use	
▽▽▽	Light (finishing)	▽▽▽	Light (finishing)
▽▽	Medium	▽▽	Medium
▽	Heavy (roughing)	▽	Heavy (roughing)

Grade		P	M	K	N	S	H	dry	with coolant
TN2505		▽▽▽		▽▽▽			▽▽▽	•	
HC-H05 • PVD-TiAlN									
TN2510		▽▽		▽▽			▽▽	•	
HC-H10 • MT-CVD/CVD-TiN-TiCN-(ZrO <sub>2</sub> -Al <sub>2</sub> O <sub>3</sub> -TiOx)									
TN2525		▽▽		▽▽			▽▽	•	
HC-H20 • PVD-TiAlN									
TN6501					▽▽▽			•	•
HC-N03 • PVD-TiB <sub>2</sub>									
TN6510				▽▽				•	
HC-K10 • PVD-TiAlN Nanolayer									
TN6520				▽▽				•	•
HC-K20 • PVD-TiAlN Nanolayer									

### Grades and Grade Descriptions

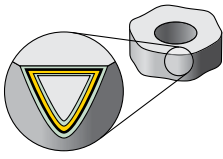

Modern coating technologies provide higher speed capabilities, greater productivity, and longer tool life.

Each insert has a material grid indicating primary and alternate uses for that tool, as well as whether it can be operated dry or with coolant.

<b>P</b>	Steel
<b>M</b>	Stainless Steel
<b>K</b>	Cast Iron
<b>N</b>	Non-Ferrous
<b>S</b>	High-Temp Alloys
<b>H</b>	Hardened Materials

primary use		alternate use	
▼▼▼	Light (finishing)	▽▽▽	Light (finishing)
▼▼	Medium	▽▽	Medium
▼	Heavy (roughing)	▽	Heavy (roughing)

Grade		P	M	K	N	S	H	dry	with coolant
<b>TN6525</b>		▼▼	▽▽	▽▽				•	
HC-P25 • PVD-TiAlN Nanolayer									
<b>TN6540</b>		▼	▼	▽		▼▼		•	•
HC-P40 • PVD-TiAlN Nanolayer									
<b>TTI25</b>		▼▼▼	▽▽▽					•	•
HT-P15 • Cermet									
<b>THM</b>				▽	▼	▽		•	•
HW-K15 • Uncoated									
<b>THM-U</b>					▼▼▼			•	•
HF-N05 • Uncoated									
<b>TTM/TTM08</b>		▼▼	▽▽	▽▽				•	•
HW-P25 • Uncoated									

INDEXABLE MILLING

SOLID END MILLING

HOLE/MAKING

TAPPING

TURNING



## Grades and Grade Descriptions

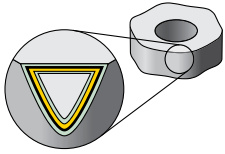

Modern coating technologies provide higher speed capabilities, greater productivity, and longer tool life.

Each insert has a material grid indicating primary and alternate uses for that tool, as well as whether it can be operated dry or with coolant.

<b>P</b>	Steel
<b>M</b>	Stainless Steel
<b>K</b>	Cast Iron
<b>N</b>	Non-Ferrous
<b>S</b>	High-Temp Alloys
<b>H</b>	Hardened Materials

primary use		alternate use	
▼▼▼	Light (finishing)	▽▽▽	Light (finishing)
▼▼	Medium	▽▽	Medium
▼	Heavy (roughing)	▽	Heavy (roughing)

Grade		P	M	K	N	S	H	dry	with coolant
<b>WK15PM</b>				▼▼				•	•
PVD-TiAlN Nanolayer									
<b>WK15CM™</b>				▼▼				•	
MT-CVD/TiN-TiCN-Al <sub>2</sub> O <sub>3</sub>									
<b>WP20CM</b>		▼▼		▽▽					
MT-CVD/TiN-TiCN-Al <sub>2</sub> O <sub>3</sub>									
<b>WP25PM</b>		▼▼	▼▼	▽▽			▽▽	•	•
PVD-AlTiN Multilayer									
<b>WS30PM™</b>		▽▽	▼▼					•	•
PVD-AlTiN Multilayer									
<b>WS40PM</b>		▽	▼					•	•
PVD-TiAlN/TiN Multilayer									

### Grades and Grade Descriptions

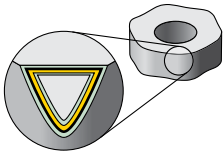

Modern coating technologies provide higher speed capabilities, greater productivity, and longer tool life.

Each insert has a material grid indicating primary and alternate uses for that tool, as well as whether it can be operated dry or with coolant.

<b>P</b>	Steel
<b>M</b>	Stainless Steel
<b>K</b>	Cast Iron
<b>N</b>	Non-Ferrous
<b>S</b>	High-Temp Alloys
<b>H</b>	Hardened Materials

primary use		alternate use	
▽▽▽	Light (finishing)	▽▽▽	Light (finishing)
▽▽	Medium	▽▽	Medium
▽	Heavy (roughing)	▽	Heavy (roughing)

Grade		P	M	K	N	S	H	dry	with coolant
<b>WU20PM</b>		▽▽	▽▽	▽▽		▽▽	▽▽	•	•
PVD-TiAlN									
<b>WU35PM</b>		▽	▽			▽		•	•
PVD-AlTiN Multilayer									
<b>WP35CM</b>		▽	▽	▽				•	
MT-CVD/TiN-TiCN-Al <sub>2</sub> O <sub>3</sub>									
<b>WP40PM™</b>		▽	▽			▽		•	•
PVD TiAlN-AlCrN Multilayer									
<b>WK25YM</b>				▽▽				•	
Silicon Nitride									
<b>WDN00U™</b>					▽▽▽ ▽▽▽ ▽				•
Ultra-fine grain PCD									

INDEXABLE MILLING

SOLID END MILLING

HOLEMAKING

TAPPING

TURNING

# Face Milling Portfolio Overview































































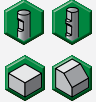























INDEXABLE MILLING

SOLID END MILLING



























































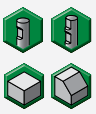

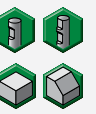



















HOLEMAKING





TAPPING

TURNING

Face Milling						
	SuperFeed™	M640	M660	M1600 Mini-F	M1600	M1200 Mini
Page	A68–A69	A16–A17	Find at widia.com	A22–A23	A22–A23	A30–A31
Work Piece Materials						
Max. Axial Depth of Cut (Ap1 Max)	0.250" 6,35mm	0.06" 1,52mm	0.250" 6,4/8,0mm	0.06" 1,52mm	0.146" 3,7mm	0.186" 4,7mm
Approach/Lead Angle Metric (Inch)	90° (0°)	58° (32°)	45°	45°	43° (47°)	15/45/59° (75/45/31°)
Effective Cutting Edges	1	6	4	16	16	12
Diameter Range	1–8" 25–200mm	1.25–4" 32–125mm	1–6" 20–160mm	2–6" 80–160mm	3–6" 50–160mm	1–5" 25–125mm
Insert Style	Single-Sided	Single-Sided	Single-Sided	Double-Sided	Double-Sided	Double-Sided
Ground Insert						
Pressed to Size Insert						
Insert Nose Radii	0.03/0.093" 0,8/2,36mm	0.035/0.039" 0,90/0,98mm	Not applicable	0.031" 0,8mm	0.047" 1,2mm	0.047/0.126" 1,2/3,2mm
Embedded Wiper Facet	0.06" 1,52mm	—	.061–0.079" 1,54–2,0mm	0.024" 0,6mm	0.03" 0,765mm	0.057–0.064" 1,454–1,6mm
Separate Wiper Insert						
Cutter Pitch	fine	coarse	regular	regular	regular	coarse & fine
Workpiece Floor Finish						
Screw Clamping						
Wedge Clamping						
Additional Operations						
 Shell Mills						
 Screw-On End Mills						
 Cylindrical End Mills	 <i>Shoulder Mill only</i>					
 Weldon® End Mills						
Cartridge for M4000						

# Face Milling Portfolio Overview

							
M1200	M1200 Max Screw	M1200 Max Wedge	M8065HD	M8090	M8090-F	M4070	M4000
A30–A31	A30–A31	A30–A31	A48–A49	A54–A55	A54–A55	A62–A63	A74–A75
							—
0.236" 6mm	0.295" 7,5mm	0.295" 7,5mm	0.354" 9,0mm	0.45" 11,5mm	0.039" 1mm	0.67" 17mm	—
15/45/59° (75/45/31°)	56° (34°)	56° (34°)	64° (26°)	89° (1°)	89° (1°)	70° (20°)	—
12	12	12	8	8	8	4	—
2–12" 50–315mm	3–6" 80–250mm	3–6" 63–250mm	3–8" 50–315mm	4–8" 63–250mm	4–8" 80–250mm	6–12" 125–315mm	6–12" 125–315mm
Double-Sided	Double-Sided	Double-Sided	Double-Sided	Double-Sided	Double-Sided	Double-Sided	—
							—
							—
0.047/0.171" 1,2/4,34mm	Not applicable	Not applicable	0.047" 1,2mm	0.047" 1,2mm	0.047" 1,2mm	0.047" 1,2mm	—
0.071" 1,8mm	0.045" 1,2mm	0.046" 1,2mm	0.093" 2,37mm	—	—	—	—
							—
coarse & fine	regular	regular	regular	coarse & fine	regular	regular	—
							
							—
							—
							
							
							
							
							
							—

 Good
  Perfect
  Yes
  No
  All-Star Program

INDEXABLE MILLING

SOLID END MILLING

HOLEMAKING

TAPPING

TURNING



# M640

## M640 Face Mills

Use the M640 face mill to create smooth finishes in all workpiece materials using soft cutting action on low-power machines.

Through-tool coolant up to 3.1496" (80mm) diameter.

One insert screw enables fast, accurate indexing.

Insert with six effective cutting edges.

Highly positive rake for low-power machines.



The M640 face mill's highly positive rake and six cutting edges on the insert enhances productivity in finishing operations on low-power machines and driven units.

### WIPER INSERT



P M K N S H

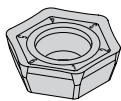

-GD

Positive and stable geometry for medium machining. The positive stabilized cutting edge improves the milling action.



-3W

Geometry with wiper facet for best surface qualities. Only to be used in conjunction with the ground geometry -GD

### INSERT



P M K N S H

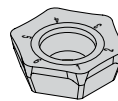

-LD

Highly positive geometry for smooth and soft cutting action. Geometry with face cutting edge for finish machining.

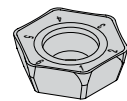

-AL

Geometry for machining aluminum. The main and secondary cutting edges are sharp edged.

# LOW CUTTING FORCES, FINISHING OPERATIONS

## PRODUCT

### SERIES

M640

### DIAMETER RANGE

1.2598-4.2913"  
(32-125mm)

## SHANK TYPES

Weldon® End Mills  
Shell Mills

## INDUSTRY



## APPLICATIONS



FACE  
MILLING

## SLEEK FINISH

## LOW CUTTING FORCES

Highly positive rake  
angle for extremely low  
cutting forces.



## M640 • Shell Mills

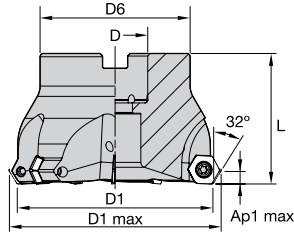

order number	catalog number	D1	D1 max	D	D6	L	Ap1 max	Z	max RPM	coolant supply	lbs
2961910	M640D200Z05S075HP06	2.000	2.251	.750	1.700	1.500	.192	5	11500	Yes	.69
2961912	M640D300Z07S100HP06	3.000	3.251	1.000	2.300	2.000	.192	7	7900	Yes	2.25

FOR SPARE PARTS, PLEASE VISIT [WIDIA.COM](http://WIDIA.COM) OR [WIDIANOVO.COM](http://WIDIANOVO.COM).

MOUNTING SCREWS ARE NOT INCLUDED IN STANDARD PACKAGING.

M640 • HPGT-LDAL

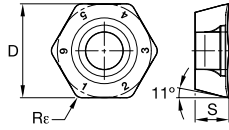
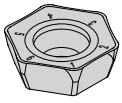

● first choice  
○ alternate choice

P	■					●	●	●	●	○	○
M	■					○	○	○	○	○	○
K	■	●	●	●	○	○	○	○	○	○	○
N	■	●	○								○
S	■						●			○	○
H	■								○	○	○

catalog number	cutting edges	D	S	Re	hm	THM	THM-U	TN6510	TN6520	TN6525	TN6540	WK15CM	WP25PM	WP40PM	WS30PM	WS40PM
HPGT225DZFRDAL	6	.433	.158	.035	.003	2288106	2288107	-	-	-	-	-	-	-	-	-

M640 • HPGT-LD

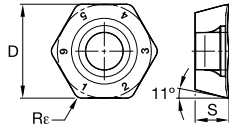
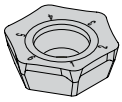

● first choice  
○ alternate choice

P	■					●	●	●	●	○	○	
M	■					○	○	○	○	○	○	
K	■	●	●	●	○	○	○	○	○	○	○	
N	■	●	○								○	
S	■								●		○	○
H	■									○	○	○

catalog number	cutting edges	D	S	Re	hm	THM	THM-U	TN6510	TN6520	TN6525	TN6540	WK15CM	WP25PM	WP40PM	WS30PM	WS40PM
HPGT225DZERLD	6	.429	.157	.039	.003	-	-	-	2957585	2957547	-	-	5895784	5895785	-	6180312

M640 • HPPT-GD

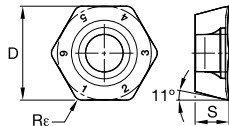
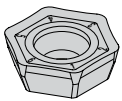

● first choice  
○ alternate choice

P	■					●	●	●	●	○	○	
M	■					○	○	○	○	○	○	
K	■	●	●	●	○	○	○	○	○	○	○	
N	■	●	○								○	
S	■								●		○	○
H	■									○	○	○

catalog number	cutting edges	D	S	Re	hm	THM	THM-U	TN6510	TN6520	TN6525	TN6540	WK15CM	WP25PM	WP40PM	WS30PM	WS40PM
HPPT225DZENGD	6	.432	.156	.039	.004	-	-	-	2957583	2957586	2957552	-	5895788	5895789	-	6180315

INDEXABLE MILLING

SOLID END MILLING

HOLEMAKING

TAPPING

TURNING





M640 • Recommended Starting Speeds [SFM]

Material Group		THM			THM-U			TN6510			TN6520			TN6525			TN6540		
P	1	-	-	-	-	-	-	-	-	-	-	-	-	1340	1045	925	1180	925	785
	2	-	-	-	-	-	-	-	-	-	-	-	-	1045	830	710	830	630	550
	3	-	-	-	-	-	-	-	-	-	-	-	-	925	710	610	710	550	450
	4	-	-	-	-	-	-	-	-	-	-	-	-	770	550	475	590	430	355
	5	-	-	-	-	-	-	-	-	-	-	-	-	1025	770	650	785	590	490
	6	-	-	-	-	-	-	-	-	-	-	-	-	670	535	430	535	395	335
M	1	-	-	-	-	-	-	-	-	-	-	-	-	630	395	260	430	260	200
	2	-	-	-	-	-	-	-	-	-	-	-	-	395	260	155	260	155	140
	3	-	-	-	-	-	-	-	-	-	-	-	-	415	260	180	275	155	140
K	1	475	355	295	750	670	590	1570	1140	845	1475	1045	750	905	805	725	725	670	590
	2	490	395	275	-	-	-	1380	925	670	1280	830	630	710	630	590	570	510	450
	3	510	370	235	-	-	-	1105	845	650	985	750	535	590	535	475	510	475	415
N	1	3540	2365	1970	7870	4720	3935	-	-	-	-	-	-	-	-	-	-	-	-
	2	2695	1830	1520	5370	3210	2615	-	-	-	-	-	-	-	-	-	-	-	-
	3	1770	1105	785	3150	1970	1570	-	-	-	-	-	-	-	-	-	-	-	-
S	1	-	-	-	-	-	-	-	-	-	-	-	-	-	-	-	155	120	95
	2	-	-	-	-	-	-	-	-	-	-	-	-	-	-	-	80	60	40
	3	-	-	-	-	-	-	-	-	-	-	-	-	-	-	-	235	140	95
	4	-	-	-	-	-	-	-	-	-	-	-	-	-	-	-	200	95	80
H	1	-	-	-	-	-	-	-	-	-	-	-	-	-	-	-	-	-	-
	2	-	-	-	-	-	-	-	-	-	-	-	-	-	-	-	-	-	-
	3	-	-	-	-	-	-	-	-	-	-	-	-	-	-	-	-	-	-

Material Group		WK15CM			WP25PM			WP40PM			WS30PM			WS40PM		
P	1	-	-	-	1295	1120	1060	1165	1025	965	-	-	-	915	800	750
	2	-	-	-	1080	940	785	985	845	710	-	-	-	770	670	555
	3	-	-	-	1000	845	690	905	770	630	-	-	-	705	605	490
	4	-	-	-	890	725	590	805	670	535	-	-	-	635	520	425
	5	-	-	-	725	670	590	670	610	535	-	-	-	520	455	425
	6	-	-	-	650	490	395	590	450	355	-	-	-	455	360	275
M	1	-	-	-	805	710	650	770	670	610	890	785	725	850	620	375
	2	-	-	-	725	630	510	690	590	490	805	710	570	750	555	340
	3	-	-	-	550	475	370	510	450	355	610	535	415	620	455	260
K	1	1655	1520	1340	905	805	725	-	-	-	-	-	-	-	-	-
	2	1320	1165	1080	710	630	590	-	-	-	-	-	-	-	-	-
	3	1105	985	905	590	535	475	-	-	-	-	-	-	-	-	-
N	1	-	-	-	-	-	-	-	-	-	-	-	-	3525	3100	3100
	2	-	-	-	-	-	-	-	-	-	-	-	-	3100	2870	2770
	3	-	-	-	-	-	-	-	-	-	-	-	-	2870	2490	2490
S	1	-	-	-	155	140	95	155	140	120	180	155	120	200	145	85
	2	-	-	-	155	140	95	155	140	120	180	155	120	180	130	85
	3	-	-	-	200	155	95	200	155	120	215	180	120	205	150	95
	4	-	-	-	275	200	140	260	200	140	335	235	155	295	215	135
H	1	-	-	-	-	-	-	-	-	-	-	-	-	-	-	-
	2	-	-	-	-	-	-	-	-	-	-	-	-	-	-	-
	3	-	-	-	-	-	-	-	-	-	-	-	-	-	-	-

NOTE: FIRST choice starting speeds are in bold type.  
As the average chip thickness increases, the speed should be decreased.

M640 • Recommended Starting Feeds [IPT]

Light Machining	General Purpose	Heavy Machining
-----------------	-----------------	-----------------

Insert Geometry	Programmed Feed per Tooth (fz) as a % of Radial Depth of Cut (ae)															Insert Geometry
	5%			10%			20%			30%			40-100%			
.F..LDAL	.005	<b>.013</b>	.018	.004	<b>.010</b>	.013	.003	<b>.007</b>	.010	.003	<b>.006</b>	.009	.002	<b>.006</b>	.008	.F..LDAL
.E..LD	.005	<b>.013</b>	.018	.004	<b>.010</b>	.013	.003	<b>.007</b>	.010	.003	<b>.006</b>	.009	.002	<b>.006</b>	.008	.E..LD
.E..GD	.005	<b>.019</b>	.021	.004	<b>.014</b>	.015	.003	<b>.010</b>	.011	.003	<b>.009</b>	.010	.002	<b>.008</b>	.009	.E..GD

NOTE: Use "Light Machining" value as starting feed rate.

# M1600 Series

## M1600, M1600 Mini-F Face Mills

The M1600 Series includes versatile, 16-edged face mills for roughing, semi-finishing, and finishing in steel, cast iron, and nodular iron materials that will run in low-power machines, unstable and non-rigid set-ups, and long overhang conditions.



### M1600 MINI-F

The M1600 Mini-F face mill is the finishing solution with an  $A_p$  max of 0.0827" (2,1mm) to achieve surface finish below Ra 1.6.



### M1600

The M1600 standard sized face mill is a reliable semi-finishing and roughing tool with an  $A_p$  max of 0.1457" (4mm) and lead angle of 47 degrees.

### M1600 MINI-F INSERTS

#### SEMI-FINISH INSERTS



WK15CM



WU10PM



WU20PM



#### WIPER INSERTS

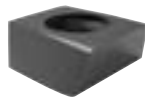

THM-F



WU10PM



### M1600 INSERTS

-MM



WK15CM



WK15CM is a wear-resistant grade with balanced toughness for general milling of cast irons. Best results in dry machining, but can also be used wet.

WP35CM





WP35CM has a wide range of applications in general and rough milling of steels and cast iron. Performs best in dry, but can also be used under wet conditions.

WU20PM



WU20PM is a universal grade for machining of steel, stainless steel, and high-temperature alloys. Also suitable for machining of gray and nodular irons. Resists breakage and offers improved wear resistance and increased strength. Can be used for both dry and wet machining.

# VERSATILE FACE MILL FOR ALL MACHINE CONDITIONS

PRODUCT		INSERTS		
SERIES	DIAMETER RANGE	INSERT TYPE	GRADE	MATERIALS
<b>M1600 MINI-F</b>	3–6.2992" (80–160mm)	MM, Wiper	WK15CM, WU10PM, WU20PM Wiper: THM-F, WU10PM	
<b>M1600</b>	1.9685–6.2992" (50–160mm)	MM	WK15CM, WP35CM, WU20PM	

## APPLICATIONS



FACE  
MILLING

## INDUSTRY



**47°**  
**LEAD ANGLE**  
redistributes cutting forces in  
the spindle z-axis direction.





INDEXABLE MILLING

SOLID END MILLING

HOLEMAKING

TAPPING

TURNING

## M1600 Mini-F • 48° • Shell Mills • Inch

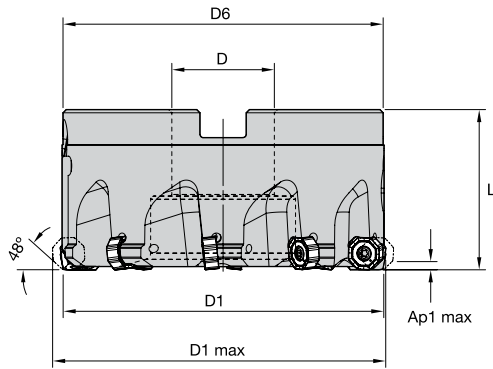

order number	catalog number	D1	D1 max	D	D6	L	Ap1 max	Z	coolant supply	lbs
6921235	M1600U300Z08W2S100ON04	3.000	3.403	1.000	3.150	1.969	0.083	8	No	3.31
6921236	M1600U400Z10W2S150ON04	4.000	4.254	1.500	3.810	1.969	0.083	10	No	4.75
6921237	M1600U600Z16W4S200ON04	6.000	6.254	2.000	4.875	2.480	0.083	16	No	13.02

FOR SPARE PARTS, PLEASE VISIT [WIDIA.COM](http://WIDIA.COM) OR [WIDIANOVO.COM](http://WIDIANOVO.COM).

MOUNTING SCREWS ARE NOT INCLUDED IN STANDARD PACKAGING.

M1600 Mini-F • ONGX-MM

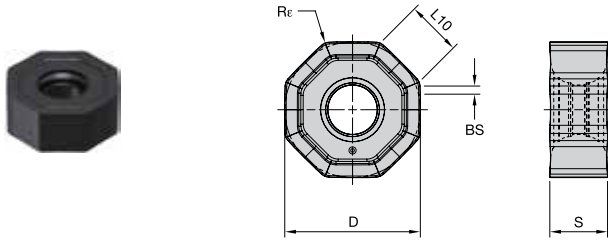

- first choice
- alternate choice

P	■	■	■	■	■	■
M	■	■	■	■	■	■
K	■	●	●	●	○	○
N	■	●	■	■	○	○
S	■	■	■	■	○	○
H	■	■	■	■	●	○

ISO catalog number	ANSI catalog number	cutting edges	D		L10		S		BS		Re		hm		THM-F	WK15CM	WU10PM	WU20PM
			mm	in	mm	in	mm	in	mm	in	mm	in	mm	in				
ONGX04T308ANSNMM	ONGX04T308ANSNMM	16	10	.394	4,10	.162	3,97	.156	0,60	.024	0,80	.031	0,04	.002	■	6095310	■	■
ONGX04T308ANSNMM	ONGX04T308ANSNMM	16	10	.394	4,10	.162	3,97	.156	0,60	.024	0,80	.031	0,04	.001	■	■	6243772	■
ONGX04T308ANSNMM	ONGX04T308ANSNMM	16	10	.394	4,10	.162	3,97	.156	0,60	.024	0,80	.031	0,05	.002	■	■	■	6291724

M1600 Mini-F • Wiper Inserts • XDHX-W2C

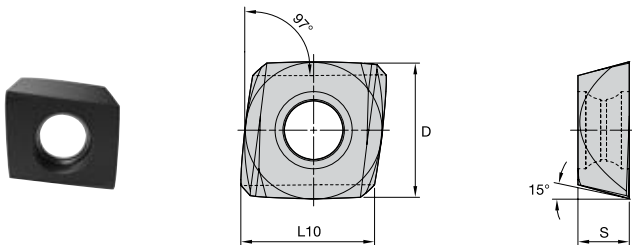

- first choice
- alternate choice

P	■	■	■	■	■	■
M	■	■	■	■	■	■
K	■	●	●	●	○	○
N	■	●	■	■	○	○
S	■	■	■	■	○	○
H	■	■	■	■	●	○

ISO catalog number	ANSI catalog number	cutting edges	D		L10		S		hm		THM-F	WK15CM	WU10PM	WU20PM
			mm	in	mm	in	mm	in	mm	in				
XDHX1004RW2C	XDHX1004RW2C	2	13	.500	8,72	4,76	.188	0,00	0,02	.001	6739214	■	■	■
XDHX1004RW2C	XDHX1004RW2C	2	13	.500	—	4,76	.188	—	0,02	.001	■	■	6877620	■

### M1600 Mini-F • Insert Selection Guide

Material Group	Light Machining		General Purpose		Heavy Machining	
	Geometry	Grade	Geometry	Grade	Geometry	Grade
P1-P2	.S..MM	WU10PM	.S..MM	WU10PM	.S..MM	WU20PM
P3-P4	.S..MM	WU10PM	.S..MM	WU20PM	.S..MM	WU20PM
P5-P6	.S..MM	WU20PM	.S..MM	WU20PM	.S..MM	WU20PM
M1-M2	.S..MM	WU20PM	.S..MM	WU20PM	.S..MM	WU20PM
M3	.S..MM	WU20PM	.S..MM	WU20PM	.S..MM	WU20PM
K1-K2	.S..MM	WK15CM	.S..MM	WK15CM	.S..MM	WU20PM
K3	.S..MM	WU20PM	.S..MM	WU10PM	.S..MM	WK15CM
N1-N2	.S..MM	WU10PM	.S..MM	WU10PM	.S..MM	WU20PM
N3	.S..MM	WU10PM	.S..MM	WU10PM	.S..MM	WU20PM
S1-S2	.S..MM	WU20PM	.S..MM	WU20PM	.S..MM	WU20PM
S3	.S..MM	WU20PM	.S..MM	WU20PM	.S..MM	WU20PM
S4	.S..MM	WU20PM	.S..MM	WU20PM	.S..MM	WU20PM
H1	.S..MM	WU10PM	.S..MM	WU20PM	.S..MM	WU20PM

### M1600 Mini-F • Recommended Starting Speeds [SFM]

Material Group		WK15CM			WU10PM			WU20PM			THM-F		
		1	2	3	1	2	3	1	2	3	1	2	3
P	1	—	—	—	—	—	—	1080	950	890	—	—	—
	2	—	—	—	—	—	—	900	820	660	—	—	—
	3	—	—	—	—	—	—	840	720	570	—	—	—
	4	—	—	—	800	660	560	740	620	490	—	—	—
	5	—	—	—	—	—	—	610	570	490	—	—	—
	6	—	—	—	—	—	—	540	430	330	—	—	—
M	1	—	—	—	—	—	—	670	590	540	—	—	—
	2	—	—	—	—	—	—	610	520	430	—	—	—
	3	—	—	—	—	—	—	460	390	310	—	—	—
K	1	1380	1260	1120	970	870	790	820	720	610	620	560	490
	2	1100	970	900	750	670	620	660	590	490	—	—	—
	3	920	820	750	640	570	520	590	490	390	—	—	—
N	1	—	—	—	2100	1870	1720	1800	1540	1310	2610	2280	1970
	2	—	—	—	2100	1870	1720	1800	1540	1310	2610	2280	1970
	3	—	—	—	1900	1760	1610	1310	1150	980	—	—	—
S	1	—	—	—	—	—	—	130	110	80	—	—	—
	2	—	—	—	—	—	—	130	110	80	—	—	—
	3	—	—	—	—	—	—	160	130	80	—	—	—
	4	—	—	—	—	—	—	230	160	110	—	—	—
H	1	—	—	—	520	430	300	360	260	230	—	—	—

NOTE: FIRST choice starting speeds are in **bold** type.  
As the average chip thickness increases, the speed should be decreased.

### M1600 Mini-F • Recommended Starting Feeds [IPT]

Light Machining	General Purpose	Heavy Machining
-----------------	-----------------	-----------------

Insert Geometry	Programmed Feed per Tooth (fz) as a % of Radial Depth of Cut (ae)															Insert Geometry
	5%			10%			20%			30%			40-100%			
.S..MM	.007	<b>.023</b>	.046	.005	<b>.016</b>	.033	.004	<b>.012</b>	.024	.003	<b>.011</b>	.021	.003	<b>.010</b>	.019	.S..MM

NOTE: FIRST choice starting feed (fz) is in **bold** type.  
Use corresponding speed (vc).  
fz and vc are valid for ae ≥ 0.4 D1.  
For smaller ae, fz and vc should be multiplied by the factor given below:

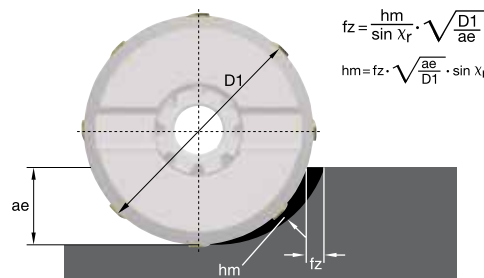

FOR SPARE PARTS, PLEASE VISIT [WIDIA.COM](http://WIDIA.COM) OR [WIDIANOVO.COM](http://WIDIANOVO.COM).  
MOUNTING SCREWS ARE NOT INCLUDED IN STANDARD PACKAGING.

M1600 • 47° • Shell Mills • Inch

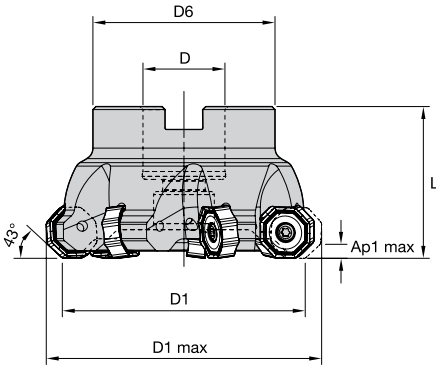

order number	catalog number	D1	D1 max	D	D6	L	Ap1 max	Z	max RPM	coolant supply	lbs
6921229	M1600U200Z04S075ON06	2.000	2.423	.750	1.750	1.575	.146	4	—	Yes	.69
6921230	M1600U250Z05S075ON06	2.500	2.923	.750	1.750	1.575	.146	5	—	Yes	1.03
6921231	M1600U300Z07S100ON06	3.000	3.423	1.000	2.750	1.750	.146	7	—	Yes	2.05
6921232	M1600U400Z09S150ON06	4.000	4.423	1.500	3.380	2.000	.146	9	—	Yes	3.28
6921233	M1600U500Z11S150ON06	5.000	5.423	1.500	3.810	2.380	.146	11	6900	Yes	5.99
6921234	M1600U600Z13S200ON06	6.000	6.423	2.000	4.875	2.380	.146	13	—	Yes	9.31

INDEXABLE MILLING

SOLID END MILLING

HOLEMAKING

TAPPING

TURNING

## M1600 • ONGX-MM • General Purpose Face Milling

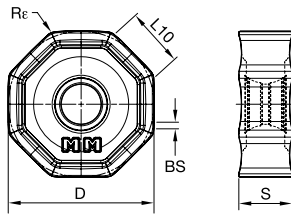

- first choice
- alternate choice

P	■	■	●	●
M	■	■	●	●
K	■	■	●	●
N	■	■	○	○
S	■	■	○	○
H	■	■	○	○

ISO catalog number	ANSI catalog number	cutting edges	D		L10		S		BS		R <sub>ε</sub>		hm		WK15CM	WP35CM	WU20PM
			mm	in	mm	in	mm	in	mm	in	mm	in	mm	in			
ONGX060512ANSNMM	ONGX060512ANSNMM	16	17	.665	6,87	.271	5,47	.216	0,77	.030	1,20	.047	0,04	.002	6072424	■	■
ONGX060512ANSNMM	ONGX060512ANSNMM	16	17	.665	6,87	.271	5,47	.216	0,77	.030	1,20	.047	0,06	.002	6652431	■	3778942

INDEXABLE MILLING

SOLID END MILLING

HOLE/MAKING

TAPPING

TURNING

M1600 • Insert Selection Guide

Material Group	Light Machining		General Purpose		Heavy Machining	
	Geometry	Grade	Geometry	Grade	Geometry	Grade
P1-P2	.S.MM	WP35CM	.S.MM	WP35CM	.S.MM	WU20PM
P3-P4	.S.MM	WP35CM	.S.MM	WP35CM	.S.MM	WU20PM
P5-P6	.S.MM	WP35CM	.S.MM	WP35CM	.S.MM	WP35CM
M1-M2	.S.MM	WU20PM	.S.MM	WU20PM	.S.MM	WU20PM
M3	.S.MM	WP35CM	.S.MM	WP35CM	.S.MM	WP35CM
K1-K2	.S.MM	WK15CM	.S.MM	WK15CM	.S.MM	WU20PM
K3	.S.MM	WU20PM	.S.MM	WU20PM	.S.MM	WK15CM
N1-N2	.S.MM	WU20PM	.S.MM	WU20PM	.S.MM	WU20PM
N3	.S.MM	WU20PM	.S.MM	WU20PM	.S.MM	WU20PM
S1-S2	.S.MM	WU20PM	.S.MM	WU20PM	.S.MM	WU20PM
S3	.S.MM	WU20PM	.S.MM	WU20PM	.S.MM	WU20PM
S4	.S.MM	WP35CM	.S.MM	WU20PM	.S.MM	WU20PM
H1	.S.MM	WU20PM	-	-	-	-

M1600 • Recommended Starting Speeds [SFM]

Material Group		WP35CM			WK15CM			WU20PM		
		1	1490	<b>1300</b>	1210	-	-	-	1080	<b>950</b>
P	2	920	<b>840</b>	750	-	-	-	900	<b>820</b>	660
	3	840	<b>750</b>	670	-	-	-	840	<b>720</b>	570
	4	620	<b>570</b>	520	-	-	-	740	<b>620</b>	490
	5	850	<b>750</b>	690	-	-	-	610	<b>570</b>	490
	6	520	<b>440</b>	-	-	-	-	540	<b>430</b>	330
M	1	670	<b>610</b>	510	-	-	-	670	<b>590</b>	540
	2	610	<b>520</b>	460	-	-	-	610	<b>520</b>	430
	3	480	<b>430</b>	380	-	-	-	460	<b>390</b>	310
K	1	970	<b>870</b>	790	1380	<b>1260</b>	1120	820	<b>720</b>	610
	2	770	<b>690</b>	620	1100	<b>970</b>	900	660	<b>590</b>	490
	3	640	<b>570</b>	520	920	<b>820</b>	750	590	<b>490</b>	390
N	1	-	-	-	-	-	-	1800	<b>1540</b>	1310
	2	-	-	-	-	-	-	1800	<b>1540</b>	1310
	3	-	-	-	-	-	-	1310	<b>1150</b>	980
S	1	-	-	-	-	-	-	130	<b>110</b>	80
	2	-	-	-	-	-	-	130	<b>110</b>	80
	3	-	-	-	-	-	-	160	<b>130</b>	80
	4	-	-	-	-	-	-	230	<b>160</b>	110
H	1	-	-	-	-	-	-	360	<b>260</b>	230

NOTE: FIRST choice starting speeds are in **bold** type.  
As the average chip thickness increases, the speed should be decreased.

M1600 • Recommended Starting Feeds [IPT]

Light Machining	General Purpose	Heavy Machining
-----------------	-----------------	-----------------

Insert Geometry	Programmed Feed per Tooth (fz) as a % of Radial Depth of Cut (ae)												Insert Geometry			
	5%	10%		20%			30%		40-100%							
.S.MM	.010	<b>.034</b>	.056	.007	<b>.024</b>	.040	.005	<b>.018</b>	.030	.005	<b>.016</b>	.026	.004	<b>.014</b>	.024	.S.MM

NOTE: FIRST choice starting feed (fz) is in **bold** type.  
Use corresponding speed (vc).  
fz and vc are valid for ae ≥ 0.4 D1.  
For smaller ae, fz and vc should be multiplied by the factor given below:

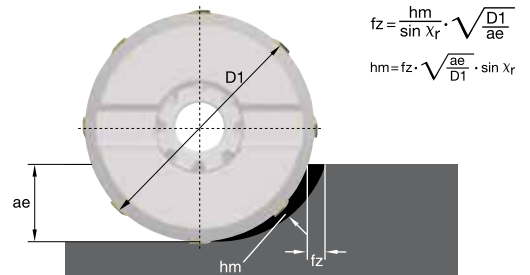



# M1200 Series

## M1200 Mini, M1200, M1200 MAX Face Mills



### M1200 MINI

The M1200 mini face mill is a first-choice for low DOC face milling that will improve productivity on taper 40 spindle milling machines.



### M1200

The M1200 standard sized face mill is an all-inclusive series that will improve productivity on taper 50 spindle milling machines and driven tools using 75-, 45-, and 31-degree lead angles.



### M1200 MAX SCREW CLAMPING • FOR BIGGER STOCK REMOVAL

The M1200 Max is a 12-edged face mill for customers who need to run at a higher DOC (up to 0.295" [7,5mm]) in steel, stainless steel, gray cast iron, and nodular iron.



### M1200 MAX WEDGE CLAMPING • FOR CAST IRON COMPONENTS

The M1200 Max wedge clamping is a 12-edged face mill for medium roughing - semi-finishing while running higher DOC (up to 0.295" [7,5mm]) in gray cast iron and nodular iron components.

## ONE INSERT STYLE FITS INTO ALL DIFFERENT CUTTER BODY VERSIONS

M1200 &  
M1200 MINI HF  
High-Feed 15°

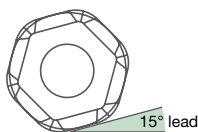

M1200 &  
M1200 MINI  
45°

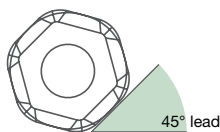

M1200 &  
M1200 MINI HD  
60°

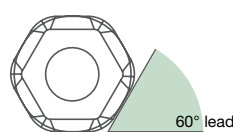



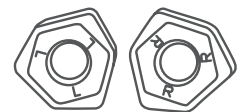











WIPER  
(XNGJ)



3RH + 3LH

# 12-EDGED FACE MILL

PRODUCT		INSERTS		
<b>SERIES</b>	<b>DIAMETER RANGE</b>	<b>GEOMETRY</b>	<b>GRADE</b>	<b>MATERIALS</b>
<b>M1200 MINI</b> HNPJ0905... - PRESSED AND SINTERED TO SIZE HNGJ0905... - PRECISION GROUND	1.5–5" (25–125mm)	LDJ — Machining Aluminum	WK15CM, WK25YM	
<b>M1200</b> HNPJ0905... - PRESSED AND SINTERED TO SIZE HNGJ0905... - PRECISION GROUND	2–12" (40–315mm)	LD — Light Machining	WP35CM, WP25PM	  
<b>M1200 MAX</b> HNMU1107... - PRESSED AND SINTERED TO SIZE HNMF1107... - PRESSED AND SINTERED TO SIZE	3–6" 63–250mm	GD — General Purpose	WP40PM	 
		HD — Heavy Machining	WS30PM	
		MM — Medium Machining	WS40PM	  
			TN6501, THM-U	
			WK15CM, WP35CM, WU20PM	  

## APPLICATIONS



WELDON®  
SHANK



WELDON: 2  
FLAT



FACE  
MILLING



EASED  
CHAMFER

## INDUSTRY



## M1200 Mini High Feed • Cylindrical Shank

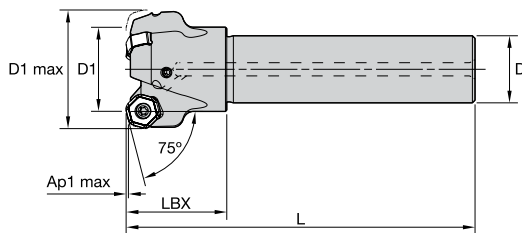

order number	catalog number	D1 max	D1	D	L	LBX	Ap1 max	Z	max RPM	coolant supply	lbs
4136453	M1200HF100Z02C075HN07L480	1.556	1.000	.750	4.800	1.250	.068	2	19800	Yes	.73

## M1200 Mini High Feed • Shell Mills

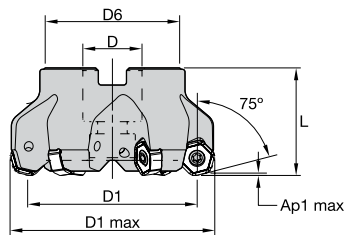

order number	catalog number	D1	D1 max	D	D6	L	Ap1 max	Z	max RPM	coolant supply	lbs
4136457	M1200HF150Z05S050HN07	1.500	2.057	.750	1.440	1.575	.068	5	15800	Yes	.62
4136458	M1200HF200Z05S075HN07	2.000	2.557	.750	1.750	1.575	.068	5	12500	Yes	1.12
4136459	M1200HF250Z06S075HN07	2.500	3.056	.750	1.750	1.575	.068	6	10000	Yes	1.48
4136460	M1200HF300Z08S100HN07	3.000	3.556	1.000	2.189	1.750	.068	8	8300	Yes	2.32

NOTE: Socket-head cap screw with coolant groove must be ordered separately.

## M1200 Mini • Weldon® Shank

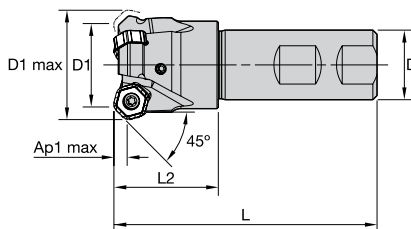

order number	catalog number	D1	D1 max	D	L	L2	Ap1 max	Z	max RPM	coolant supply	lbs
3953893	M1200D100Z02W075HN07	1.000	1.343	.750	3.280	1.250	.138	2	19800	Yes	.46
3953894	M1200D100Z03W075HN07	1.000	1.343	.750	3.280	1.250	.138	3	19800	Yes	.45
3953896	M1200D125Z04W100HN07	1.250	1.593	1.000	3.783	1.500	.138	4	17700	Yes	.88

M1200 Mini • Shell Mills

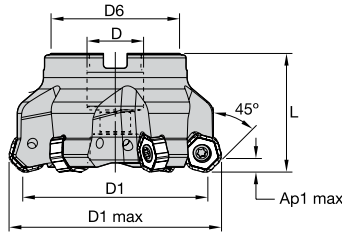

order number	catalog number	D1	D1 max	D	D6	L	Ap1 max	Z	max RPM	coolant supply	lbs
4136461	M1200D150Z04S050HN07	1.500	1.813	.500	1.440	1.575	.136	4	15800	Yes	.58
4136462	M1200D150Z05S050HN07	1.500	1.813	.500	1.440	1.575	.136	5	15800	Yes	.57
3954485	M1200D200Z04S075HN07	2.000	2.343	.750	1.750	1.575	.138	4	12500	Yes	1.00
3954486	M1200D200Z05S075HN07	2.000	2.343	.750	1.750	1.575	.138	5	12500	Yes	1.01
3954487	M1200D200Z06S075HN07	2.000	2.343	.750	1.750	1.575	.138	5	12500	Yes	1.01
3954488	M1200D250Z04S075HN07	2.500	2.843	.750	1.750	1.575	.138	4	10000	Yes	1.27
3954489	M1200D250Z06S075HN07	2.500	2.843	.750	1.750	1.575	.138	6	10000	Yes	1.40
3954490	M1200D250Z08S075HN07	2.500	2.843	.750	1.750	1.575	.138	8	10000	Yes	1.36
3954491	M1200D300Z05S100HN07	3.000	3.343	1.000	2.189	1.750	.138	5	8300	Yes	2.00
3954492	M1200D300Z08S100HN07	3.000	3.343	1.000	2.189	1.750	.138	8	8300	Yes	2.26
3954503	M1200D300Z10S100HN07	3.000	3.343	1.000	2.189	1.750	.138	10	8300	Yes	2.12
3954504	M1200D400Z06S150HN07	4.000	4.342	1.500	3.661	1.750	.138	6	6300	Yes	3.73
3954505	M1200D400Z09S150HN07	4.000	4.342	1.500	3.661	1.750	.138	9	6300	Yes	3.68
3954506	M1200D400Z12S150HN07	4.000	4.342	1.500	3.661	1.750	.138	12	6300	Yes	3.65
4130534	M1200D500Z08S150HN07	5.000	5.343	1.500	3.652	2.380	.138	8	5000	Yes	6.32

NOTE: Socket-head cap screw with coolant groove must be ordered separately.

M1200 Mini 30° • Shell Mills

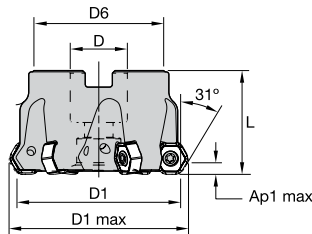

order number	catalog number	D1	D1 max	D	D6	L	Ap1 max	Z	max RPM	coolant supply	lbs
4136418	M1200HD200Z05S075HN07	2.000	2.266	.750	1.750	1.575	.186	5	12500	Yes	.91
4136421	M1200HD300Z05S100HN07	3.000	3.266	1.000	2.188	1.750	.186	5	8300	Yes	1.95
4136433	M1200HD400Z06S150HN07	4.000	4.266	1.500	3.661	1.750	.185	6	6300	Yes	3.33
4136435	M1200HD500Z08S150HN07	5.000	5.265	1.500	3.661	2.380	.185	8	5000	Yes	6.29

NOTE: Socket-head cap screw with coolant groove must be ordered separately.

FOR SPARE PARTS, PLEASE VISIT [WIDIA.COM](http://WIDIA.COM) OR [WIDIANOVO.COM](http://WIDIANOVO.COM).  
MOUNTING SCREWS ARE NOT INCLUDED IN STANDARD PACKAGING.

## M1200 Mini • HNGJ-LDJ • HN0704

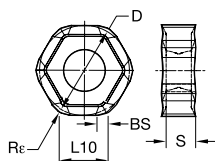
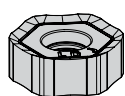

● first choice

○ alternate choice

P						●	●	●	●	●	●	○	●
M						○	○	○	○	○	○	○	○
K	●	●	●	○	○	○	○	○	○	○	○	○	○
N	○	●											○
S								●			○	○	○
H										○		○	

ISO catalog number	ANSI catalog number	cutting edges	D		L10		S		BS		Re		hm		THM-U	TN6501	TN6510	TN6520	TN6525	TN6540	WK15CM	WP25PM	WP35CM	WP40PM	WS30PM	WS40PM	
			mm	in	mm	in	mm	in	mm	in	mm	in	mm	in													mm
HNGJ0704ANFNLDJ	HNGJ0704ANFNLDJ	12	13	.500	6,84	.269	4,48	.176	1,51	.060	1,20	.047	0,08	.003	3954332	3954414											

## M1200 Mini • HNGJ-LD • HN0704

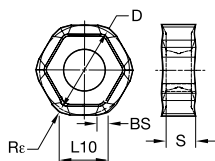

● first choice

○ alternate choice

P						●	●	●	●	●	●	○	●
M						○	○	○	○	○	○	○	○
K	●	●	●	○	○	○	○	○	○	○	○	○	○
N	○	●											○
S								●			○	○	○
H										○		○	

ISO catalog number	ANSI catalog number	cutting edges	D		L10		S		BS		Re		hm		THM-U	TN6501	TN6510	TN6520	TN6525	TN6540	WK15CM	WP25PM	WP35CM	WP40PM	WS30PM	WS40PM	
			mm	in	mm	in	mm	in	mm	in	mm	in	mm	in													mm
HNGJ070432ANENLD	HNGJ070432ANENLD	12	13	.500	6,00	.236	4,48	.176	—	—	3,21	.126	0,08	.003													
HNGJ0704ANENLD	HNGJ0704ANENLD	12	13	.500	6,84	.269	4,48	.176	1,60	.064	1,20	.047	0,08	.003			3954419	3954420	3954421	3954422		5895291	5895292	5550905	5528975	6180295	6180300

M1200 Mini • HNPJ-GD • HN0704

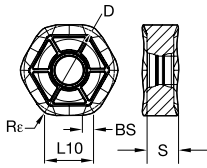

● first choice  
○ alternate choice

P					●	●	●	●	●	○	○
M					○	○	○	○	○	○	○
K	●	●	●	○	○	○	○	○	○	○	○
N	○	●									○
S								●		○	○
H									○	○	○

ISO catalog number	ANSI catalog number	cutting edges	D		L10		S		BS		Re		hm		THM-U	TN6501	TN6510	TN6520	TN6525	TN6540	WK15CM	WP25PM	WP35CM	WP40PM	WS30PM	WS40PM	
			mm	in	mm	in	mm	in	mm	in	mm	in	mm	in													
HNPJ0704ANSNGD	HNPJ0704ANSNGD	12	13	.500	6,80	.269	4,45	.175	1,45	.057	1,20	.047	0,10	.004	●	●	○	○	○	○	○	○	○	○	○	○	○

M1200 Mini • HNPJ-HD • HN0704

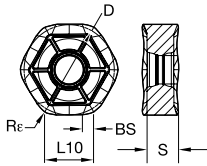

● first choice  
○ alternate choice

P					●	●	●	●	●	○	○
M					○	○	○	○	○	○	○
K	●	●	●	○	○	○	○	○	○	○	○
N	○	●									○
S								●		○	○
H									○	○	○

ISO catalog number	ANSI catalog number	cutting edges	D		L10		S		BS		Re		hm		THM-U	TN6501	TN6510	TN6520	TN6525	TN6540	WK15CM	WP25PM	WP35CM	WP40PM	WS30PM	WS40PM
			mm	in	mm	in	mm	in	mm	in	mm	in	mm	in												
HNPJ0704ANSNHD	HNPJ0704ANSNHD	12	13	.500	6,80	.269	4,41	.174	1,45	.057	1,20	.047	0,14	.006	●	●	○	○	○	○	○	○	○	○	○	○
HNPJ070432ANSNHD	HNPJ070432ANSNHD	12	13	.500	6,84	.269	4,42	.174	—	—	3,20	.126	0,14	.006	●	●	○	○	○	○	○	○	○	○	○	○



M1200 Mini • XNGJ-LDJ-3 Wiper • XN0704

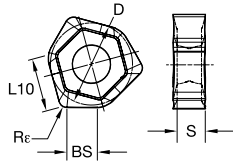
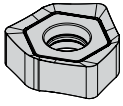

- first choice
- alternate choice

P M K N S H	THM-U		TN6501		TN6510		TN6520		TN6525		TN6540		WK15CM		WP25PM		WP35CM		WP40PM		WS30PM		WS40PM	
	mm	in	mm	in	mm	in	mm	in	mm	in	mm	in	mm	in	mm	in	mm	in	mm	in	mm	in	mm	in
	3954433																							

ISO catalog number	ANSI catalog number	cutting edges	D		L10		S		BS		Re		hm		THM-U	TN6501	TN6510	TN6520	TN6525	TN6540	WK15CM	WP25PM	WP35CM	WP40PM	WS30PM	WS40PM
			mm	in	mm	in	mm	in	mm	in	mm	in	mm	in												
XNGJ0704ANFNLDJ3W	XNGJ0704ANFNLDJ3W	3	13	.500	6,78	.267	4,47	.176	6,78	.267	1,30	.051	0,08	.003	3954433											

M1200 Mini • XNGJ-LD3 Wiper • XN0704

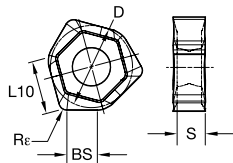
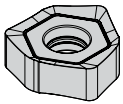

- first choice
- alternate choice

P M K N S H	THM-U		TN6501		TN6510		TN6520		TN6525		TN6540		WK15CM		WP25PM		WP35CM		WP40PM		WS30PM		WS40PM	
	mm	in	mm	in	mm	in	mm	in	mm	in	mm	in	mm	in	mm	in	mm	in	mm	in	mm	in	mm	in

ISO catalog number	ANSI catalog number	cutting edges	D		L10		S		BS		Re		hm		THM-U	TN6501	TN6510	TN6520	TN6525	TN6540	WK15CM	WP25PM	WP35CM	WP40PM	WS30PM	WS40PM
			mm	in	mm	in	mm	in	mm	in	mm	in	mm	in												
XNGJ0704ANENLD3W	XNGJ0704ANENLD3W	3	13	.500	6,78	.267	4,47	.176	6,78	.267	1,30	.051	0,08	.003				3954425	3954426	3954427	5427373	5895298		5895299		6180296

M1200 Mini • Insert Selection Guide

Material Group	Light Machining		General Purpose		Heavy Machining	
	Geometry	Grade	Geometry	Grade	Geometry	Grade
P1-P2	.E..LD	WP40PM	.S..GD	WP40PM	.S..HD	WP40PM
P3-P4	.E..LD	WP25PM	.S..GD	WP35CM	.S..HD	WP35CM
P5-P6	.E..LD	WP25PM	.S..GD	WP35CM	.S..HD	WP35CM
M1-M2	.E..LD	WP25PM	.S..GD	WP25PM	.S..HD	WP25PM
M3	.E..LD	WP35CM	.S..GD	WP35CM	.S..HD	WP35CM
K1-K2	.E..LD	TN6510	.S..GD	WK15CM	.S..HD	WK15CM
K3	.E..LD	WP35CM	.S..GD	WP35CM	.S..HD	WP35CM
N1-N2	.F..LDJ	TN6501	.F..LDJ	TN6501	.F..LDJ	TN6501
N3	.F..LDJ	TN6501	.F..LDJ	TN6501	.F..LDJ	TN6501
S1-S2	.E..LD	WS30PM	.S..GD	WS30PM	.S..HD	WP25PM
S3	.E..LD	WS30PM	.S..GD	WS30PM	.S..GD	WS30PM
S4	.E..LD	WS30PM	.S..GD	WS30PM	.S..HD	WP40PM

M1200 Mini • Recommended Starting Speeds [SFM]

Material Group		THM-U	TN6501			TN6510			TN6520			TN6525			TN6540			
P	1	-	-	-	-	-	-	-	-	-	1340	1045	925	1180	925	785		
	2	-	-	-	-	-	-	-	-	-	1045	830	710	830	630	550		
	3	-	-	-	-	-	-	-	-	-	925	710	610	710	550	450		
	4	-	-	-	-	-	-	-	-	-	770	550	475	590	430	355		
	5	-	-	-	-	-	-	-	-	-	1025	770	650	785	590	490		
	6	-	-	-	-	-	-	-	-	-	670	535	430	535	395	335		
M	1	-	-	-	-	-	-	-	-	-	630	395	260	430	260	200		
	2	-	-	-	-	-	-	-	-	-	395	260	155	260	155	140		
	3	-	-	-	-	-	-	-	-	-	415	260	180	275	155	140		
K	1	-	-	-	-	-	1570	1140	845	1475	1045	750	905	805	725	670	590	
	2	-	-	-	-	-	1380	925	670	1280	830	630	710	630	590	570	510	450
	3	-	-	-	-	-	1105	845	650	985	750	535	590	535	475	510	475	415
N	1	7870	4720	3935	7870	4720	3935	-	-	-	-	-	-	-	-	-	-	
	2	5370	3210	2615	5370	3210	2615	-	-	-	-	-	-	-	-	-	-	
	3	3150	1970	1570	3150	1970	1570	-	-	-	-	-	-	-	-	-	-	
S	1	-	-	-	-	-	-	-	-	-	-	-	-	-	-	155	120	95
	2	-	-	-	-	-	-	-	-	-	-	-	-	-	-	80	60	40
	3	-	-	-	-	-	-	-	-	-	-	-	-	-	-	235	140	95
	4	-	-	-	-	-	-	-	-	-	-	-	-	-	-	200	95	80
H	1	-	-	-	-	-	475	360	230	-	-	-	-	-	-	-	-	-
	2	-	-	-	-	-	475	360	230	-	-	-	-	-	-	-	-	-
	3	-	-	-	-	-	380	260	150	-	-	-	-	-	-	-	-	-

Material Group		WK15CM	WP25PM			WP35CM			WP40PM			WS30PM			WS40PM		
P	1	-	1295	1120	1060	1790	1555	1460	970	855	805	-	-	-	-	-	-
	2	-	1080	940	785	1105	1000	905	820	705	590	-	-	-	-	-	-
	3	-	1000	845	690	1000	905	805	755	640	525	-	-	-	-	-	-
	4	-	890	725	590	750	690	630	675	560	445	-	-	-	-	-	-
	5	-	725	670	590	1025	905	830	560	510	445	-	-	-	560	475	395
	6	-	650	490	395	630	535	430	490	375	295	-	-	-	490	360	260
M	1	-	805	710	650	805	725	610	640	560	510	890	785	725	690	560	460
	2	-	725	630	510	725	630	550	575	490	410	805	710	570	590	475	395
	3	-	550	475	370	570	510	450	425	375	295	610	535	415	475	360	280
K	1	1655	1520	1340	905	805	725	1165	1045	940	-	-	-	-	-	-	-
	2	1320	1165	1080	710	630	590	925	830	750	-	-	-	-	-	-	-
	3	1105	985	905	590	535	475	770	690	630	-	-	-	-	-	-	-
N	1	-	-	-	-	-	-	-	-	-	-	-	-	-	-	-	-
	2	-	-	-	-	-	-	-	-	-	-	-	-	-	-	-	-
	3	-	-	-	-	-	-	-	-	-	-	-	-	-	-	-	-
S	1	-	155	140	95	-	-	-	-	-	-	180	155	120	130	115	80
	2	-	155	140	95	-	-	-	-	-	-	180	155	120	130	115	80
	3	-	200	155	95	-	-	-	-	-	-	215	180	120	165	130	80
	4	-	275	200	140	260	200	130	-	-	-	335	235	155	195	165	100
H	1	-	475	355	275	-	-	-	-	-	-	-	-	-	-	-	-
	2	-	-	-	-	-	-	-	-	-	-	-	-	-	-	-	-
	3	-	-	-	-	-	-	-	-	-	-	-	-	-	-	-	-

NOTE: FIRST choice starting speeds are in bold type.  
As the average chip thickness increases, the speed should be decreased.

M1200 Mini • Recommended Starting Feeds [IPT]

Light Machining	General Purpose	Heavy Machining
-----------------	-----------------	-----------------

Insert Geometry	Programmed Feed per Tooth (fz) as a % of Radial Depth of Cut (ae)															Insert Geometry
	5%			10%			20%			30%			40-100%			
.F..LDJ	.019	<b>.035</b>	.072	.014	<b>.025</b>	.051	.010	<b>.019</b>	.038	.009	<b>.016</b>	.033	.008	<b>.015</b>	.030	.F..LDJ
.E..LD	.019	<b>.055</b>	.112	.014	<b>.039</b>	.079	.010	<b>.029</b>	.058	.009	<b>.025</b>	.051	.008	<b>.023</b>	.046	.E..LD
.S..GD	.036	<b>.093</b>	.153	.026	<b>.066</b>	.106	.019	<b>.049</b>	.078	.017	<b>.042</b>	.068	.015	<b>.039</b>	.062	.S..GD
.S..HD	.036	<b>.093</b>	.153	.026	<b>.066</b>	.106	.019	<b>.049</b>	.078	.017	<b>.042</b>	.068	.015	<b>.039</b>	.062	.S..HD

NOTE: Use "Light Machining" value as starting feed rate.

## M1200 • 15° • High Feed • Shell Mills • Inch

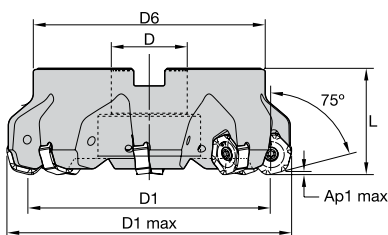

order number	catalog number	D1	D1 max	D	D6	L	Ap1 max	Z	max RPM	coolant supply	lbs
3954510	M1200HF200Z04S075HN09	2.000	2.704	.750	1.593	1.575	.087	4	11300	Yes	1.17
3954511	M1200HF250Z05S075HN09	2.500	3.204	.750	1.986	1.575	.087	5	8900	Yes	1.56
3954512	M1200HF300Z06S100HN09	3.000	3.704	1.000	2.189	1.750	.087	6	7400	Yes	2.25
3954563	M1200HF400Z08S150HN09	4.000	4.703	1.500	3.661	1.750	.086	8	5800	Yes	3.96
3954564	M1200HF500Z09S150HN09	5.000	5.704	1.500	3.652	2.380	.087	9	4700	Yes	6.88

NOTE: Socket head cap screw with coolant grooves, coolant lock screw assembly, coolant lock screw, and coolant cap must be ordered separately.

## M1200 • 45° • Shell Mills • Inch

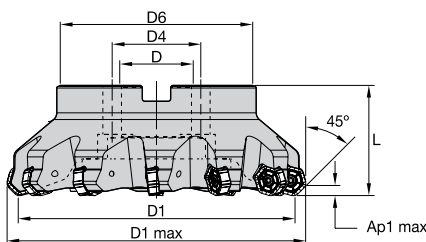

order number	catalog number	D1	D1 max	D	D4	D6	L	Ap1 max	Z	max RPM	coolant supply	lbs
3323871	M1200D200Z04S075HN09	2.000	2.434	.750	—	1.750	1.570	.177	4	12500	Yes	.81
3323872	M1200D200Z05S075HN09	2.000	2.434	.750	—	1.750	1.570	.177	5	12500	Yes	.82
3323873	M1200D250Z06S075HN09	2.500	2.933	.750	—	2.144	1.570	.177	6	10000	Yes	1.32
3323874	M1200D250Z07S075HN09	2.500	2.933	.750	—	2.144	1.570	.177	7	10000	Yes	1.34
3650540	M1200D300Z05S100HN09	3.000	3.433	1.000	—	2.189	1.750	.177	5	8300	Yes	1.86
3323875	M1200D300Z06S100HN09	3.000	3.433	1.000	—	2.189	1.750	.177	6	8300	Yes	1.79
3323876	M1200D300Z09S100HN09	3.000	3.433	1.000	—	2.189	1.750	.177	9	8300	Yes	1.97
3650541	M1200D400Z06S125HN09	4.000	4.432	1.250	—	2.722	1.750	.177	6	6300	Yes	3.17
3323877	M1200D400Z08S125HN09	4.000	4.432	1.250	—	2.880	1.750	.177	8	6300	Yes	2.93
3958019	M1200D400Z06S150HN09	4.000	4.432	1.500	—	3.661	1.750	.177	6	6300	Yes	4.15
3958020	M1200D400Z08S150HN09	4.000	4.432	1.500	—	3.661	1.750	.177	8	6300	Yes	3.46
3958021	M1200D400Z11S150HN09	4.000	4.432	1.500	—	3.661	1.750	.172	11	6300	Yes	3.50
3650542	M1200D500Z08S150HN09	5.000	5.431	1.500	—	3.652	2.380	.177	8	5000	Yes	6.20
3323879	M1200D500Z10S150HN09	5.000	5.431	1.500	—	3.810	2.380	.177	10	5000	Yes	5.94
3323880	M1200D500Z14S150HN09	5.000	5.431	1.500	—	3.810	2.380	.177	14	5000	Yes	6.21
4086796	M1200D600Z09S200HN09	6.000	6.430	2.000	—	4.722	2.380	.177	9	4100	Yes	9.08
3323881	M1200D600Z12S200HN09	6.000	6.432	2.000	—	4.879	2.380	.177	12	4100	Yes	9.10
3323882	M1200D600Z16S200HN09	6.000	6.432	2.000	—	4.879	2.380	.177	16	4100	Yes	9.36
3954507	M1200D800Z16S250HN09	8.000	8.432	2.500	4.000	5.118	2.380	.180	16	3130	Yes	13.22
4086797	M1200D800Z10S250HN09	8.000	8.433	2.500	4.000	5.118	2.380	.177	10	3130	Yes	13.01
4086798	M1200D1000Z12S250HN09	10.000	10.433	2.500	4.000	7.120	2.380	.177	12	2510	Yes	24.22
3954508	M1200D1000Z20S250HN09	10.000	10.433	2.500	4.000	7.120	2.380	.177	20	2510	Yes	24.52
4086799	M1200D1200Z14S250HN09	12.000	12.433	2.500	4.000	9.016	3.150	.177	14	2090	Yes	41.50

NOTE: Socket-head cap screw with coolant groove, coolant lock screw assembly, coolant lock screw, and coolant cap must be ordered separately.

M1200 HD • Shell Mills

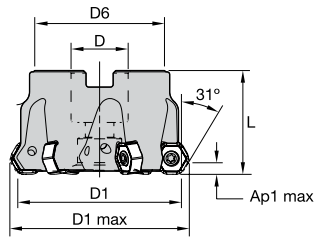

order number	catalog number	D1	D1 max	D	D6	L	Ap1 max	Z	max RPM	coolant supply	lbs
4147879	M1200HD250Z06S075HN09	2.500	2.836	.750	1.986	1.575	.236	6	10000	Yes	1.36
4147880	M1200HD300Z05S100HN09	3.000	3.336	1.000	2.189	1.750	.236	5	8300	Yes	1.98
4147881	M1200HD300Z08S100HN09	3.000	3.336	1.000	2.189	1.750	.236	8	8300	Yes	2.01

NOTE: Socket-head cap screw with coolant groove, coolant screw assembly, coolant lock screw, and coolant cap must be ordered separately.

INDEXABLE MILLING

SOLID END MILLING

HOLE/MAKING

TAPPING

TURNING

FOR SPARE PARTS, PLEASE VISIT [WIDIA.COM](http://WIDIA.COM) OR [WIDIANOVO.COM](http://WIDIANOVO.COM).  
MOUNTING SCREWS ARE NOT INCLUDED IN STANDARD PACKAGING.

## M1200 • HNGJ-LDJ • HN0905

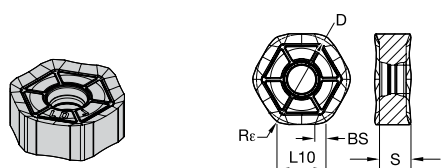

- first choice
- alternate choice

P	■					●	●			●	●	●	●	○	●
M	■					○	●			○	●	●	●	●	●
K	■	●		●	●	○	○	●	●	○	○	○	○	○	○
N	■	○	●												○
S	■					●	○			●	○	○	○	○	●
H	■													○	○

ISO catalog number	ANSI catalog number	cutting edges	D		L10		S		BS		Re		hm		THM-U	TN6501	TN6510	TN6520	TN6525	TN6540	WK15CM	WK25YM	WP25PM	WP35CM	WP40PM	WS30PM	WS40PM		
			mm	in	mm	in	mm	in	mm	in	mm	in	mm	in														mm	in
HNGJ0905ANFNLDJ	HNGJ535ANFNLDJ	12	16	.625	8,58	.338	5,56	.219	1,81	.071	1,20	.047	0,02	.001	3606383														

## M1200 • HNGJ-LD • HN0905

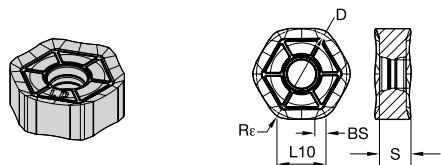

- first choice
- alternate choice

P	■					●	●			●	●	●	●	○	●
M	■					○	●			○	●	●	●	●	●
K	■	●		●	●	○	○	●	●	○	○	○	○	○	○
N	■	○	●												○
S	■					●	○			●	○	○	○	○	●
H	■													○	○

ISO catalog number	ANSI catalog number	cutting edges	D		L10		S		BS		Re		hm		THM-U	TN6501	TN6510	TN6520	TN6525	TN6540	WK15CM	WK25YM	WP25PM	WP35CM	WP40PM	WS30PM	WS40PM	
			mm	in	mm	in	mm	in	mm	in	mm	in	mm	in														mm
HNGJ0905ANENLD	HNGJ535ANENLD	12	16	.625	8,58	.338	5,56	.219	1,76	.069	1,20	.047	0,05	.002	■	■	■	■	■	■	■	■	■	■	■	■	■	■
															3093559													
															3330950													
															3030034													
															5895346													
															5895347													
															5895348													
															5528973													
															6180276													

## M1200 • HNPJ-GD • HN0905

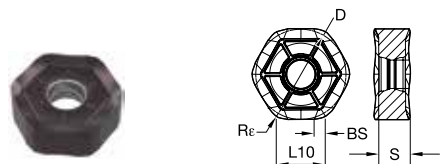

- first choice
- alternate choice

P	■					●	●			●	●	●	●	○	●
M	■					○	●			○	●	●	●	●	●
K	■	●		●	●	○	○	●	●	○	○	○	○	○	○
N	■	○	●												○
S	■					●	○			●	○	○	○	○	●
H	■													○	○

ISO catalog number	ANSI catalog number	cutting edges	D		L10		S		BS		Re		hm		THM-U	TN6501	TN6510	TN6520	TN6525	TN6540	WK15CM	WK25YM	WP25PM	WP35CM	WP40PM	WS30PM	WS40PM	
			mm	in	mm	in	mm	in	mm	in	mm	in	mm	in														mm
HNPJ0905ANSNGD	HNPJ535ANSNGD	12	16	.625	8,58	.338	5,56	.219	1,80	.071	1,20	.047	0,10	.004	■	■	■	■	■	■	■	■	■	■	■	■	■	
															3761185													
															3761187													
															5427372													
															5895374													
															5895375													
															5550908													
															6180278													

M1200 • HNGJ-GD • HN0905

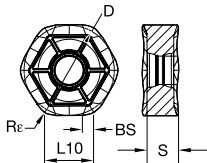

- first choice
- alternate choice

P	●					●					●								
M	●																		
K	●																		
N	○	●																	
S	○																		
H																			

ISO catalog number	ANSI catalog number	cutting edges	D		L10		S		BS		Re		hm		THM-U	TN6501	TN6510	TN6520	TN6525	TN6540	WK15CM	WK25YM	WP25PM	WP35CM	WP40PM	WS30PM	WS40PM	
			mm	in	mm	in	mm	in	mm	in	mm	in	mm	in														mm
HNGJ0905ANSNGD	HNGJ535ANSNGD	12	16	.625	8,59	.338	5,56	.219	1,71	.068	1,20	.047	0,10	.004														

M1200 • HNPJ-HD • HN0905

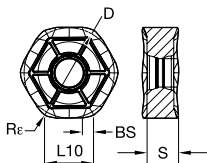

- first choice
- alternate choice

P	●					●																					
M	●																										
K	●																										
N	○	●																									
S	○																										
H																											

ISO catalog number	ANSI catalog number	cutting edges	D		L10		S		BS		Re		hm		THM-U	TN6501	TN6510	TN6520	TN6525	TN6540	WK15CM	WK25YM	WP25PM	WP35CM	WP40PM	WS30PM	WS40PM
			mm	in	mm	in	mm	in	mm	in	mm	in	mm	in													
HNPJ090543ANSNHD	HNPJ53511ANSNHD	12	16	.625	8,50	.334	5,44	.214	—	—	4,35	.171	0,13	.005													
HNPJ0905ANSNHD	HNPJ535ANSNHD	12	16	.625	8,59	.338	5,46	.215	1,65	.065	1,20	.047	0,18	.007													

INDEXABLE MILLING

SOLID END MILLING

HOLEMAKING

TAPPING

TURNING



## M1200 • HNGJ-HD • HN0905

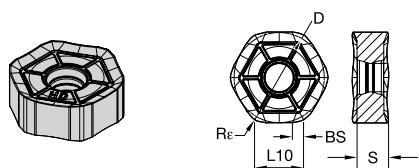

- first choice
- alternate choice

P	■	■	■	■	●	●	■	■	■	■	○	○
M	■	■	■	■	○	○	■	■	■	■	■	■
K	■	■	■	■	○	○	■	■	○	○	■	■
N	○	●	■	■	■	■	■	■	○	○	○	○
S	■	■	■	■	■	■	■	■	○	○	■	■
H	■	■	■	■	■	■	■	■	○	○	○	○

ISO catalog number	ANSI catalog number	cutting edges	D		L10		S		BS		Re		hm		THM-U	TN6501	TN6510	TN6520	TN6525	TN6540	WK15CM	WK25YM	WP25PM	WP35CM	WP40PM	WS30PM	WS40PM
			mm	in	mm	in	mm	in	mm	in	mm	in	mm	in													
HNGJ090543ANSNHD	HNGJ53511ANSNHD	12	16	.625	8,50	.335	5,44	.214	—	—	4,35	.171	0,20	.008	■	■	■	○	○	■	■	■	■	○	○	■	■
HNGJ0905ANSNHD	HNGJ535ANSNHD	12	16	.625	8,59	.338	5,46	.215	1,65	.065	1,20	.047	0,17	.007	■	■	■	○	○	■	■	■	■	○	○	■	■

## M1200 • HNEW-AN • HN0905

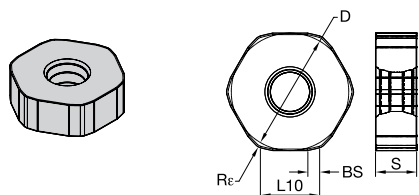

- first choice
- alternate choice

P	■	■	■	■	●	●	■	■	■	■	○	○
M	■	■	■	■	○	○	■	■	■	■	■	■
K	■	■	■	■	○	○	■	■	○	○	■	■
N	○	●	■	■	■	■	■	■	○	○	○	○
S	■	■	■	■	■	■	■	■	○	○	■	■
H	■	■	■	■	■	■	■	■	○	○	○	○

ISO catalog number	ANSI catalog number	cutting edges	D		L10		S		BS		Re		hm		THM-U	TN6501	TN6510	TN6520	TN6525	TN6540	WK15CM	WK25YM	WP25PM	WP35CM	WP40PM	WS30PM	WS40PM
			mm	in	mm	in	mm	in	mm	in	mm	in	mm	in													
HNEC0905ANSN	HNEC535ANSN	12	16	.625	9,17	.361	5,56	.219	1,95	.077	1,20	.047	0,19	.008	■	■	■	■	■	■	■	■	○	○	■	■	



M1200 • Recommended Starting Speeds [SFM]

Material Group		THM-U			TN6501			TN6510			TN6520			TN6525			TN6540			WK15CM		
P	1	-	-	-	-	-	-	-	-	-	-	-	-	1340	1045	925	1180	925	785	-	-	-
	2	-	-	-	-	-	-	-	-	-	-	-	-	1045	830	710	830	630	550	-	-	-
	3	-	-	-	-	-	-	-	-	-	-	-	-	925	710	610	710	550	450	-	-	-
	4	-	-	-	-	-	-	-	-	-	-	-	-	770	550	475	590	430	355	-	-	-
	5	-	-	-	-	-	-	-	-	-	-	-	-	1025	770	650	785	590	490	-	-	-
	6	-	-	-	-	-	-	-	-	-	-	-	-	670	535	430	535	395	335	-	-	-
M	1	-	-	-	-	-	-	-	-	-	-	-	-	630	395	260	430	260	200	-	-	-
	2	-	-	-	-	-	-	-	-	-	-	-	-	395	260	155	260	155	140	-	-	-
	3	-	-	-	-	-	-	-	-	-	-	-	-	415	260	180	275	155	140	-	-	-
K	1	750	670	590	-	-	-	1310	950	705	1475	1045	750	905	805	725	725	670	590	1655	1520	1340
	2	-	-	-	-	-	-	1145	770	555	1280	830	630	710	630	590	570	510	450	1320	1165	1080
	3	-	-	-	-	-	-	915	705	540	985	750	535	590	535	475	510	475	415	1105	985	905
N	1	7870	4720	3935	7870	4720	3935	-	-	-	-	-	-	-	-	-	-	-	-	-	-	-
	2	5370	3210	2615	5370	3210	2615	-	-	-	-	-	-	-	-	-	-	-	-	-	-	-
	3	3150	1970	1570	3150	1970	1570	-	-	-	-	-	-	-	-	-	-	-	-	-	-	-
S	1	-	-	-	-	-	-	-	-	-	-	-	-	-	-	-	155	120	95	-	-	-
	2	-	-	-	-	-	-	-	-	-	-	-	-	-	-	-	80	60	40	-	-	-
	3	-	-	-	-	-	-	-	-	-	-	-	-	-	-	-	235	140	95	-	-	-
	4	-	-	-	-	-	-	-	-	-	-	-	-	-	-	-	200	95	80	-	-	-
H	1	-	-	-	-	-	-	-	-	-	-	-	-	-	-	-	-	-	-	-	-	-
	2	-	-	-	-	-	-	-	-	-	-	-	-	-	-	-	-	-	-	-	-	-
	3	-	-	-	-	-	-	-	-	-	-	-	-	-	-	-	-	-	-	-	-	-

Material Group		WK25YM			WP25PM			WP35CM			WP40PM			WS30PM			WS40PM		
P	1	-	-	-	1295	1120	1060	1790	1555	1460	970	855	805	-	-	-	-	-	-
	2	-	-	-	1080	940	785	1105	1000	905	820	705	590	-	-	-	-	-	-
	3	-	-	-	1000	845	690	1000	905	805	755	640	525	-	-	-	-	-	-
	4	-	-	-	890	725	590	750	690	630	675	560	445	-	-	-	-	-	-
	5	-	-	-	725	670	590	1025	905	830	560	510	445	-	-	-	560	475	395
	6	-	-	-	650	490	395	630	535	430	490	375	295	-	-	-	490	360	260
M	1	-	-	-	805	710	650	805	725	610	640	560	510	890	785	725	690	560	460
	2	-	-	-	725	630	510	725	630	550	575	490	410	805	710	570	590	475	395
	3	-	-	-	550	475	370	570	510	450	425	375	295	610	535	415	475	360	280
K	1	3170	2880	2560	905	805	725	1165	1045	940	-	-	-	-	-	-	-	-	-
	2	2510	2240	2090	710	630	590	925	830	750	-	-	-	-	-	-	-	-	-
	3	2110	1870	1720	590	535	475	770	690	630	-	-	-	-	-	-	-	-	-
N	1	-	-	-	-	-	-	-	-	-	-	-	-	-	-	-	-	-	-
	2	-	-	-	-	-	-	-	-	-	-	-	-	-	-	-	-	-	-
	3	-	-	-	-	-	-	-	-	-	-	-	-	-	-	-	-	-	-
S	1	-	-	-	155	140	95	-	-	-	-	-	-	180	155	120	130	115	80
	2	-	-	-	155	140	95	-	-	-	-	-	-	180	155	120	130	115	80
	3	-	-	-	200	155	95	-	-	-	-	-	-	215	180	120	165	130	80
	4	-	-	-	275	200	140	260	200	130	-	-	-	335	235	155	195	165	100
H	1	-	-	-	475	355	275	-	-	-	-	-	-	-	-	-	-	-	-
	2	-	-	-	-	-	-	-	-	-	-	-	-	-	-	-	-	-	-
	3	-	-	-	-	-	-	-	-	-	-	-	-	-	-	-	-	-	-

NOTE: FIRST choice starting speeds are in **bold** type.  
As the average chip thickness increases, the speed should be decreased.

M1200 • Recommended Starting Feeds [IPT]

Light Machining	General Purpose	Heavy Machining
-----------------	-----------------	-----------------

Insert Geometry	Programmed Feed per Tooth (fz) as a % of Radial Depth of Cut (ae)															Insert Geometry
	5%			10%			20%			30%			40-100%			
.F..LDJ	.007	<b>.013</b>	.026	.005	<b>.009</b>	.019	.004	<b>.007</b>	.014	.003	<b>.006</b>	.012	.003	<b>.006</b>	.011	.F..LDJ
.E..LD	.007	<b>.020</b>	.040	.005	<b>.014</b>	.029	.004	<b>.011</b>	.021	.003	<b>.009</b>	.019	.003	<b>.008</b>	.017	.E..LD
.S..GD	.010	<b>.033</b>	.053	.007	<b>.024</b>	.038	.006	<b>.018</b>	.028	.005	<b>.015</b>	.025	.004	<b>.014</b>	.023	.S..GD
.S..HD	.013	<b>.033</b>	.053	.009	<b>.024</b>	.038	.007	<b>.018</b>	.028	.006	<b>.015</b>	.025	.006	<b>.014</b>	.023	.S..HD
.S..Ceramic	.007	<b>.013</b>	.020	.005	<b>.009</b>	.014	.004	<b>.007</b>	.011	.003	<b>.006</b>	.009	.003	<b>.006</b>	.008	.S..Ceramic

NOTE: Use "Light Machining" value as starting feed rate.

M1200 Max Screw Clamping • 56° • Shell Mills • Metric

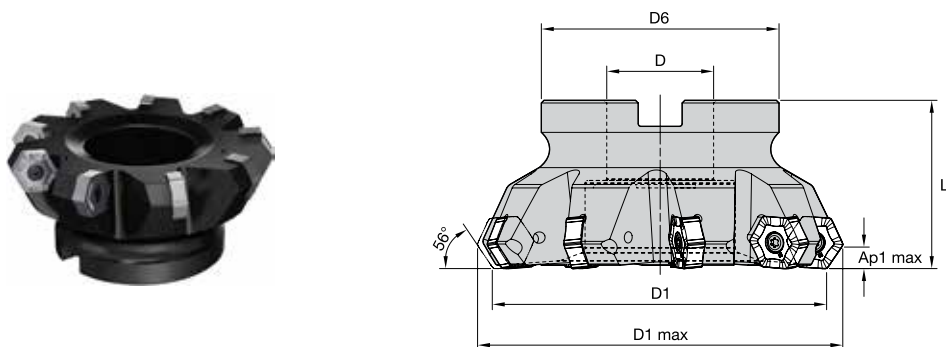

order number	catalog number	D1	D1 max	D	D6	L	Ap1 max	Z	max RPM	coolant supply	kg
6921238	M1200U300Z05S100HN11	76	88,0	25	70	44	7,5	5	—	No	0,87
6581490	M1200D080Z05S27HN11	80	91,8	27	60	50	7,5	5	—	No	0,99
6495103	M1200D100Z07S32HN11	100	111,8	32	78	50	7,5	7	8100	No	1,49
6921239	M1200U400Z07S150HN11	102	113,4	38	86	51	7,5	7	—	No	1,55
6495104	M1200D125Z09S40HN11	125	136,7	40	89	63	7,5	9	—	No	2,72
6921240	M1200U600Z10S200HN11	152	164,1	51	124	60	7,5	10	—	No	4,25
6581561	M1200D160Z10S40HN11	160	171,7	40	90	63	7,5	10	—	No	3,81
6626921	M1200D200Z12S60HN11	200	211,7	60	130	63	7,5	12	—	No	6,88
6852419	M1200D250Z14S60HN11	250	261,7	60	130	63	7,5	14	—	No	6,88

INDEXABLE MILLING

SOLID END MILLING

HOLEMAKING

TAPPING

TURNING

FOR SPARE PARTS, PLEASE VISIT WIDIA NOVO™ OR WIDIA.COM.

MOUNTING SCREWS ARE NOT INCLUDED IN STANDARD PACKAGING.

## M1200 Max Screw Clamping Inserts • HNMU-MM • Heavy-Duty Face Milling

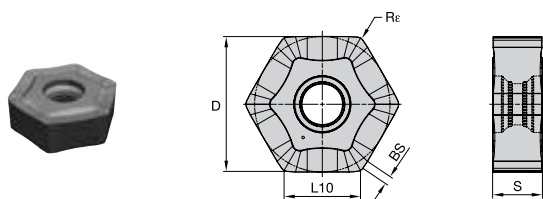

- first choice
- alternate choice

P	■	■	●	○
M	■	■	●	○
K	■	■	●	○
N	■	■	○	○
S	■	■	○	○
H	■	■	○	○

ISO catalog number	ANSI catalog number	cutting edges	D		L10		S		BS		R <sub>e</sub>		hm		WK15CM	WP35CM	WU20PM
			mm	in	mm	in	mm	in	mm	in	mm	in	mm	in			
HNMU110710ZNSNMM	HNMU110710ZNSNMM	12	19	.750	10,75	.423	6,92	.272	1,20	.046	1,00	.039	0,06	.002	6495106	6495105	6852420

## M1200 Max Screw Clamping Inserts • HNMF-MM

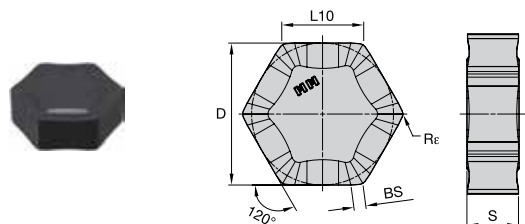

- first choice
- alternate choice

P	■	■	●	○
M	■	■	●	○
K	■	■	●	○
N	■	■	○	○
S	■	■	○	○
H	■	■	○	○

ISO catalog number	ANSI catalog number	cutting edges	D		L10		S		BS		R <sub>e</sub>		hm		WK15CM	WP35CM
			mm	in	mm	in	mm	in	mm	in	mm	in	mm	in		
HNMF110710ZNSNMM	HNMF110710ZNSNMM	12	19	.750	10,75	.423	6,87	.271	1,20	.046	1,00	.039	0,06	.002	6465300	6870109

M1200 Max • Insert Selection Guide

Material Group	Light Machining		General Purpose		Heavy Machining	
	Geometry	Grade	Geometry	Grade	Geometry	Grade
P1-P2	.S.MM	WP35CM	.S.MM	WP35CM	.S.MM	WU20PM
P3-P4	.S.MM	WP35CM	.S.MM	WP35CM	.S.MM	WU20PM
P5-P6	.S.MM	WP35CM	.S.MM	WP35CM	.S.MM	WP35CM
M1-M2	.S.MM	WU20PM	.S.MM	WU20PM	.S.MM	WU20PM
M3	.S.MM	WP35CM	.S.MM	WP35CM	.S.MM	WP35CM
K1-K2	.S.MM	WK15CM	.S.MM	WK15CM	.S.MM	WU20PM
K3	.S.MM	WU20PM	.S.MM	WU20PM	.S.MM	WK15CM
N1-N2	.S.MM	WU20PM	.S.MM	WU20PM	.S.MM	WU20PM
N3	.S.MM	WU20PM	.S.MM	WU20PM	.S.MM	WU20PM
S1-S2	.S.MM	WU20PM	.S.MM	WU20PM	.S.MM	WU20PM
S3	.S.MM	WU20PM	.S.MM	WU20PM	.S.MM	WU20PM
S4	.S.MM	WP35CM	.S.MM	WU20PM	.S.MM	WU20PM

M1200 Max • Recommended Starting Speeds [SFM]

Material Group	Insert	WP35CM			WK15CM			WU20PM		
		Speed	Speed	Speed	Speed	Speed	Speed	Speed	Speed	Speed
P	1	1490	<b>1300</b>	1210	—	—	—	1080	<b>950</b>	890
	2	920	<b>840</b>	750	—	—	—	900	<b>820</b>	660
	3	840	<b>750</b>	670	—	—	—	840	<b>720</b>	570
	4	620	<b>570</b>	520	—	—	—	740	<b>620</b>	490
	5	850	<b>750</b>	690	—	—	—	610	<b>570</b>	490
	6	520	<b>440</b>	—	—	—	—	540	<b>430</b>	330
M	1	670	<b>610</b>	510	—	—	—	670	<b>590</b>	540
	2	610	<b>520</b>	460	—	—	—	610	<b>520</b>	430
	3	480	<b>430</b>	380	—	—	—	460	<b>390</b>	310
K	1	970	<b>870</b>	790	1380	<b>1260</b>	1120	820	<b>720</b>	610
	2	770	<b>690</b>	620	1100	<b>970</b>	900	660	<b>590</b>	490
	3	640	<b>570</b>	520	920	<b>820</b>	750	590	<b>490</b>	390
N	1	—	—	—	—	—	—	1800	<b>1540</b>	1310
	2	—	—	—	—	—	—	1800	<b>1540</b>	1310
	3	—	—	—	—	—	—	1310	<b>1150</b>	980
S	1	—	—	—	—	—	—	130	<b>110</b>	80
	2	—	—	—	—	—	—	130	<b>110</b>	80
	3	—	—	—	—	—	—	160	<b>130</b>	80
	4	—	—	—	—	—	—	230	<b>160</b>	110
H	1	—	—	—	—	—	—	360	<b>260</b>	230

NOTE: FIRST choice starting speeds are in **bold** type.  
As the average chip thickness increases, the speed should be decreased.

M1200 Max • Recommended Starting Feeds [IPT]

Light Machining	General Purpose	Heavy Machining
-----------------	-----------------	-----------------

Insert Geometry	Programmed Feed per Tooth (fz) as a % of Radial Depth of Cut (ae)												Insert Geometry			
	5%			10%			20%			30%				40-100%		
.S.MM	.008	<b>.028</b>	.045	.006	<b>.020</b>	.032	.004	<b>.015</b>	.024	.004	<b>.013</b>	.021	.004	<b>.012</b>	.019	.S.MM

NOTE: FIRST choice starting feed (fz) is in **bold** type.  
Use corresponding speed (vc).  
fz and vc are valid for ae ≥ 0.4 D1.  
For smaller ae, fz and vc should be multiplied by the factor given below:

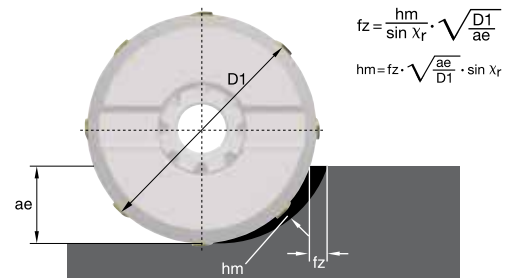

# M8065HD

## M8065HD Face Mill

Use the M8065HD to easily confront heavy-duty milling jobs in steel and cast-iron materials by applying deep depths of cut while consistently maintaining high metal removal rates.

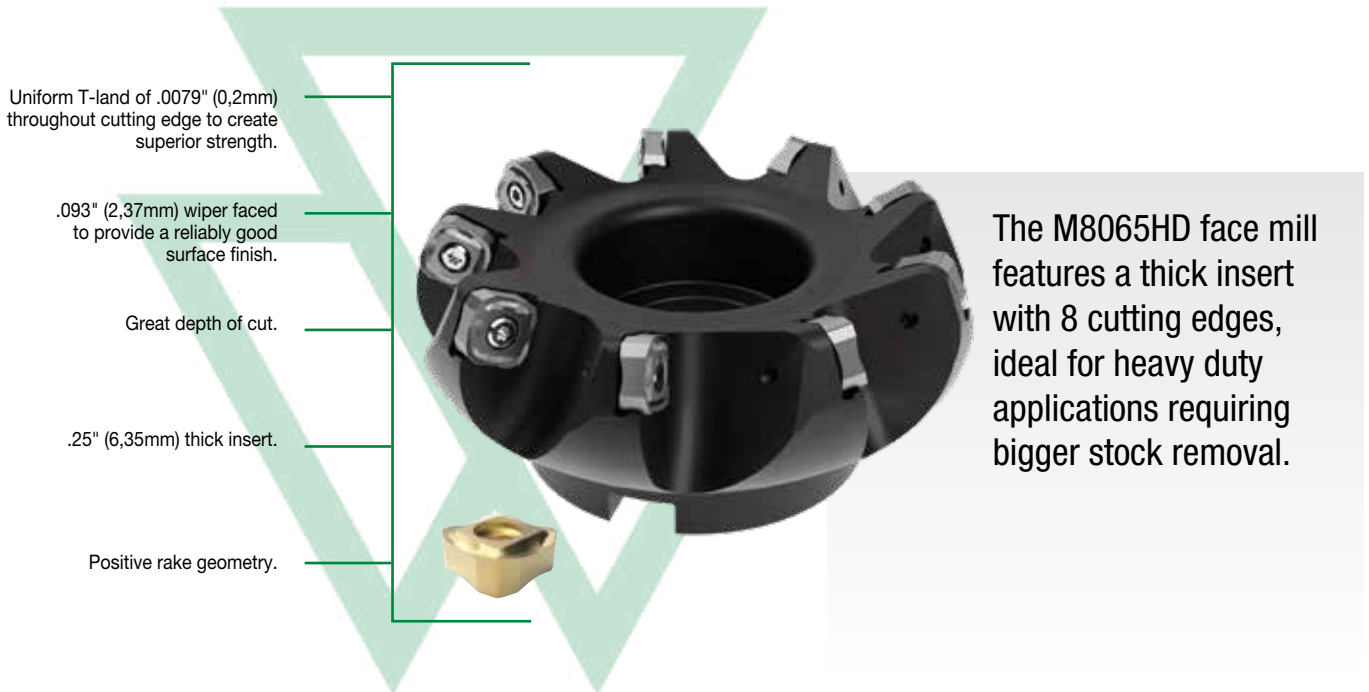

-MM



### WK15CM



WK15CM is a wear-resistant grade with balanced toughness for general milling of cast irons. Best results in dry machining, but can also be used wet.

### WP35CM



WP35CM has a wide range of applications in general and rough milling of steels and cast iron. Performs best in dry, but can also be used under wet conditions.

### WU20PM



WU20PM is a universal grade for machining of steel, stainless steel, and high-temperature alloys. Also suitable for machining of gray and nodular irons. Resists breakage and offers improved wear resistance and increased strength. Can be used for both dry and wet machining.



# DIVE INTO THE DOC WITH M8065HD

## PRODUCT

### SERIES

M8065HD

### DIAMETER RANGE

3.0–8.0" (50–315 mm)

## SHANK TYPES

Shell Mills

## INDUSTRY



## APPLICATIONS



FACE  
MILLING



SIDE/SHOULDER MILLING:  
EASED CHAMFER

**HEAVY  
DUTY**

**RELIABLE**



## M8065HD • 26° • Shell Mills • Inch

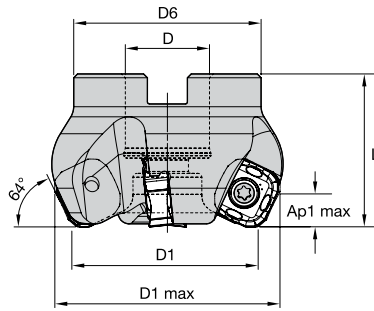

order number	catalog number	D1	D1 max	D	D6	L	Ap1 max	Z	coolant supply	lbs
6921244	M8065HU300Z06S100SN15	3.000	3.348	1.000	2.750	1.750	.354	6	No	2.31
6921245	M8065HU400Z07S150SN15	4.000	4.348	1.250	2.875	2.000	.354	7	No	8.64
6921246	M8065HU500Z09S150SN15	5.000	5.348	1.500	3.810	2.380	.354	9	No	7.21
6921247	M8065HU600Z11S200SN15	6.000	6.348	2.000	4.875	2.380	.354	11	No	9.99
6921248	M8065HU800Z14S250SN15	8.000	8.348	2.500	5.118	2.380	.354	14	No	15.37

FOR SPARE PARTS, PLEASE VISIT [WIDIA.COM](http://WIDIA.COM) OR [WIDIANOVO.COM](http://WIDIANOVO.COM).  
MOUNTING SCREWS ARE NOT INCLUDED IN STANDARD PACKAGING.

M8065HD • SNMX-MM • Heavy-Duty Face Milling

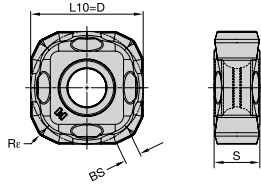

- first choice
- alternate choice

P	■	■	●	●
M	■	■	●	●
K	■	■	●	○
N	■	■	○	○
S	■	■	○	○
H	■	■	○	○

ISO catalog number	ANSI catalog number	cutting edges	D		L10		S		BS		R <sub>e</sub>		hm		WK15CM 5649102	WP35CM 6852432	WU20PM 4137987
			mm	in	mm	in	mm	in	mm	in	mm	in	mm	in			
SNMX150612ZNSNMM	SNMX150612ZNSNMM	8	16	.625	15,88	.625	6,35	.250	2,37	.093	1,20	.047	0,05	.002	■	■	■
SNMX150612ZNSNMM	SNMX150612ZNSNMM	8	16	.625	15,88	.625	6,35	.250	2,37	.093	1,20	.047	0,06	.002	■	■	■
SNMX1506ZZXP	SNMX1506ZZXP	8	16	.625	15,88	.625	6,35	.250	2,37	.093	1,20	.047	—	—	■	■	■

INDEXABLE MILLING

SOLID END MILLING

HOLE/MAKING

TAPPING

TURNING

## M8065HD • Insert Selection Guide

Material Group	Light Machining		General Purpose		Heavy Machining	
	Geometry	Grade	Geometry	Grade	Geometry	Grade
P1-P2	.S.MM	WP35CM	.S.MM	WP35CM	.S.MM	WU20PM
P3-P4	.S.MM	WP35CM	.S.MM	WP35CM	.S.MM	WU20PM
P5-P6	.S.MM	WP35CM	.S.MM	WP35CM	.S.MM	WP35CM
M1-M2	.S.MM	WU20PM	.S.MM	WU20PM	.S.MM	WU20PM
M3	.S.MM	WP35CM	.S.MM	WP35CM	.S.MM	WP35CM
K1-K2	.S.MM	WK15CM	.S.MM	WK15CM	.S.MM	WU20PM
K3	.S.MM	WU20PM	.S.MM	WU20PM	.S.MM	WK15CM
N1-N2	.S.MM	WU20PM	.S.MM	WU20PM	.S.MM	WU20PM
N3	.S.MM	WU20PM	.S.MM	WU20PM	.S.MM	WU20PM
S1-S2	.S.MM	WU20PM	.S.MM	WU20PM	.S.MM	WU20PM
S3	.S.MM	WU20PM	.S.MM	WU20PM	.S.MM	WU20PM
S4	.S.MM	WP35CM	.S.MM	WU20PM	.S.MM	WU20PM

## M8065HD • Recommended Starting Speeds [SFM]

Material Group		WP35CM			WK15CM			WU20PM		
		1	2	3	1	2	3	1	2	3
P	1	1490	<b>1300</b>	1210	—	—	—	1080	<b>950</b>	890
	2	920	<b>840</b>	750	—	—	—	900	<b>820</b>	660
	3	840	<b>750</b>	670	—	—	—	840	<b>720</b>	570
	4	620	<b>570</b>	520	—	—	—	740	<b>620</b>	490
	5	850	<b>750</b>	690	—	—	—	610	<b>570</b>	490
	6	520	<b>440</b>	—	—	—	—	540	<b>430</b>	330
M	1	670	<b>610</b>	510	—	—	—	670	<b>590</b>	540
	2	610	<b>520</b>	460	—	—	—	610	<b>520</b>	430
	3	480	<b>430</b>	380	—	—	—	460	<b>390</b>	310
K	1	970	<b>870</b>	790	1380	<b>1260</b>	1120	820	<b>720</b>	610
	2	770	<b>690</b>	620	1100	<b>970</b>	900	660	<b>590</b>	490
	3	640	<b>570</b>	520	920	<b>820</b>	750	590	<b>490</b>	390
N	1	—	—	—	—	—	—	1800	<b>1540</b>	1310
	2	—	—	—	—	—	—	1800	<b>1540</b>	1310
	3	—	—	—	—	—	—	1310	<b>1150</b>	980
S	1	—	—	—	—	—	—	130	<b>110</b>	80
	2	—	—	—	—	—	—	130	<b>110</b>	80
	3	—	—	—	—	—	—	160	<b>130</b>	80
	4	—	—	—	—	—	—	230	<b>160</b>	110
H	1	—	—	—	—	—	—	360	<b>260</b>	230

NOTE: FIRST choice starting speeds are in **bold** type.  
As the average chip thickness increases, the speed should be decreased.

## M8065HD • Recommended Starting Feeds [IPT]

Light Machining	General Purpose	Heavy Machining
-----------------	-----------------	-----------------

Insert Geometry	Programmed Feed per Tooth (fz) as a % of Radial Depth of Cut (ae)													Insert Geometry		
	5%	10%	20%	30%	40-100%											
.S.MM	.008	<b>.026</b>	.042	.006	<b>.018</b>	.030	.005	<b>.014</b>	.023	.004	<b>.012</b>	.020	.004	<b>.011</b>	.018	.S.MM

NOTE: FIRST choice starting feed (fz) is in **bold** type.  
Use corresponding speed (vc).  
fz and vc are valid for ae ≥ 0.4 D1.  
For smaller ae, fz and vc should be multiplied by the factor given below:

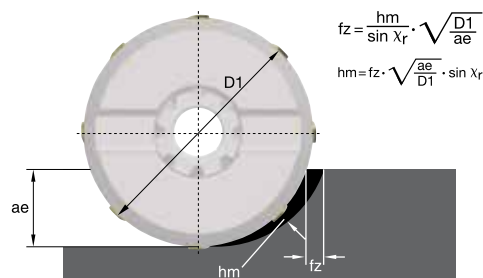



# M8090 Series

## M8090, M8090-F Face Mills

The M8090 Series is a fine pitch face milling series for rough, semi-finish and finish milling of a variety of cast and nodular irons at high-feed rates.

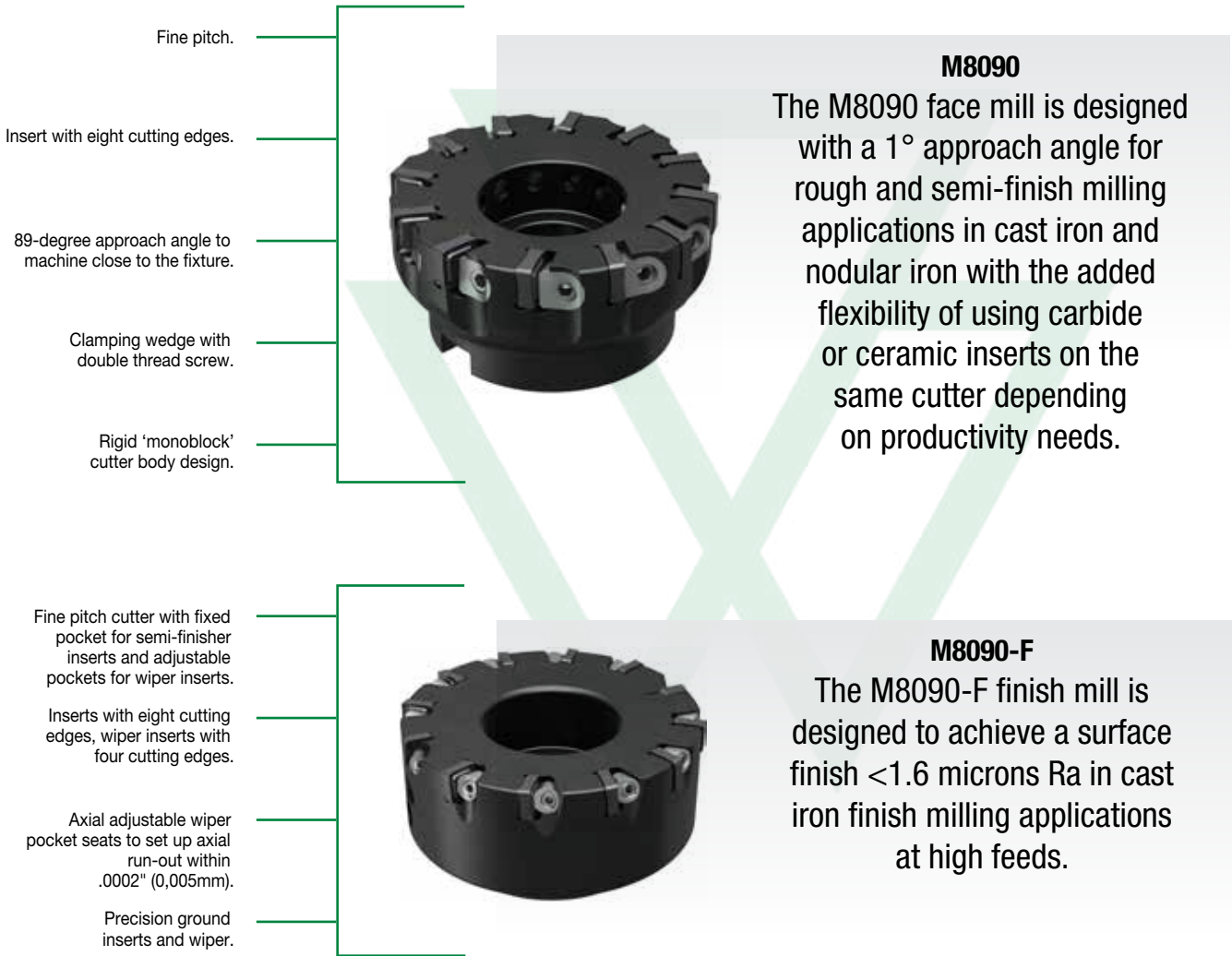

### INSERTS OFFERED IN CARBIDE GRADE WK15PM, CERAMICS WK25YM, AND PCBN WBK40U



**SNEN Insert**



Ceramic insert with eight effective cutting edges



**-MM Insert**



Insert with eight effective cutting edges and a positive geometry to work on weak fixtures.



**M8090-F Wiper Insert**



Wiper inserts with four effective cutting edges.

# HIGH-FEED CAST IRON ROUGHING, SEMI-FINISHING, AND FINISHING

## PRODUCT

**SERIES**  
M8090,  
M8090-F

## DIAMETER RANGE

M8090:  
3–6" (63–250mm)

M8090-F:  
4–8" (80–250mm)

## SHANK TYPES

Shell Mills

## INDUSTRY



## APPLICATIONS



FACE  
MILLING

## IRON MILLING

Versatile, productive face mill  
for cast iron and ductile iron.

## HIGH-FEED

Multiple insert configurations  
provide high surface quality  
at high cutting parameters  
in cast iron.





## M8090 • 1° • Shell Mills • Inch

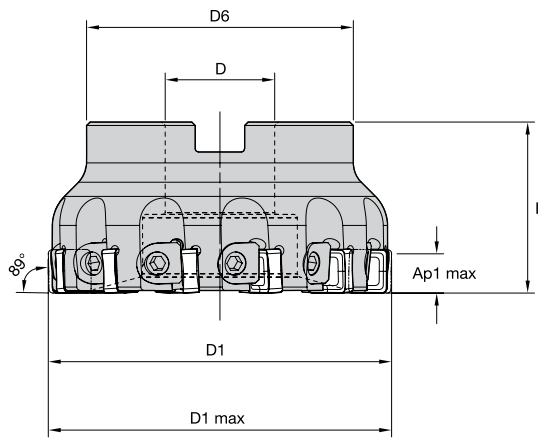

order number	catalog number	D1	D1 max	D	D6	L	Ap1 max	Z	coolant supply	lbs
6921193	M8090U400Z10S150SN12	4.000	4.015	1.250	2.875	2.000	.453	10	No	3.92
6921194	M8090U400Z12S150SN12	4.000	4.015	1.250	2.875	2.000	.453	12	No	3.85
6921195	M8090U600Z15S200SN12	6.000	6.015	2.000	4.875	2.380	.453	15	No	10.66
6921196	M8090U600Z18S200SN12	6.000	6.015	2.000	4.875	2.380	.453	18	No	10.56
6921197	M8090U800Z18S250SN12	8.000	8.015	2.500	5.118	2.380	.453	18	No	15.21
6921198	M8090U800Z24S250SN12	8.000	8.015	2.500	5.118	2.380	.453	24	No	15.01

FOR SPARE PARTS, PLEASE VISIT [WIDIA.COM](http://WIDIA.COM) OR [WIDIANOVO.COM](http://WIDIANOVO.COM).  
MOUNTING SCREWS ARE NOT INCLUDED IN STANDARD PACKAGING.

M8090 • Roughing Inserts • SNHF

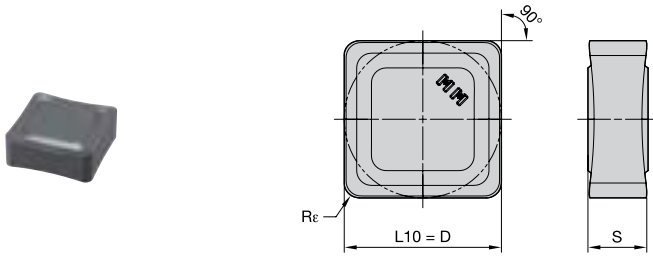

● first choice  
○ alternate choice

P	■	■	■	■
M	■	■	■	■
K	■	●	●	●
N	■	■	■	■
S	■	■	■	■
H	■	■	■	■

ISO catalog number	ANSI catalog number	cutting edges	D		L10		S		Re		hm		WK15CM	WK15PM	WK25YM
			mm	in	mm	in	mm	in	mm	in	mm	in			
SNHF120412SNMM	SNHF120412SNMM	8	12,70	.500	12,70	.500	4,76	.188	1,20	.047	0,05	.002	■	■	■
SNHF120412SNMM	SNHF120412SNMM	8	12,70	.500	12,70	.500	4,76	.188	1,20	.047	—	—	6342141	6870510	■

M8090 • Ceramic Inserts • SNEN

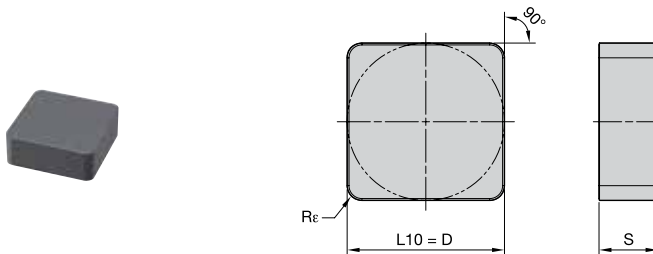

● first choice  
○ alternate choice

P	■	■	■	■
M	■	■	■	■
K	■	●	●	●
N	■	■	■	■
S	■	■	■	■
H	■	■	■	■

ISO catalog number	ANSI catalog number	cutting edges	D		L10		S		Re		hm		WK15CM	WK15PM	WK25YM
			mm	in	mm	in	mm	in	mm	in	mm	in			
SNEN120412SNHN	SNEN120412SNHN	4	12,70	.500	12,70	.500	4,76	.188	1,20	.047	0,04	.001	■	■	6880278

### M8090 • Insert Selection Guide

Material Group	Light Machining		General Purpose		Heavy Machining	
	Geometry	Grade	Geometry	Grade	Geometry	Grade
P1-P2	-	-	-	-	-	-
P3-P4	-	-	-	-	-	-
P5-P6	-	-	-	-	-	-
M1-M2	-	-	-	-	-	-
M3	-	-	-	-	-	-
K1-K2	.S..HN	WK25YM	.S..MM	WK15CM	.S..MM	WK15CM
K3	.S..MM	WK15PM	.S..MM	WK15PM	.S..MM	WK15PM
N1-N2	-	-	-	-	-	-
N3	-	-	-	-	-	-
S1-S2	-	-	-	-	-	-
S3	-	-	-	-	-	-
S4	-	-	-	-	-	-

### M8090 • Recommended Starting Speeds [SFM]

Material Group		WK15CM			WK15PM			WK25YM		
P	1	-	-	-	-	-	-	-	-	-
	2	-	-	-	-	-	-	-	-	-
	3	-	-	-	-	-	-	-	-	-
	4	-	-	-	-	-	-	-	-	-
	5	-	-	-	-	-	-	-	-	-
	6	-	-	-	-	-	-	-	-	-
M	1	-	-	-	-	-	-	-	-	-
	2	-	-	-	-	-	-	-	-	-
	3	-	-	-	-	-	-	-	-	-
K	1	1380	<b>1260</b>	1120	1060	<b>965</b>	845	3170	<b>2875</b>	2555
	2	1100	<b>970</b>	900	830	<b>750</b>	690	2500	<b>2245</b>	2090
	3	920	<b>820</b>	750	690	<b>630</b>	570	2105	<b>1870</b>	1710
N	1	-	-	-	-	-	-	-	-	-
	2	-	-	-	-	-	-	-	-	-
	3	-	-	-	-	-	-	-	-	-
S	1	-	-	-	-	-	-	-	-	-
	2	-	-	-	-	-	-	-	-	-
	3	-	-	-	-	-	-	-	-	-
	4	-	-	-	-	-	-	-	-	-
H	1	-	-	-	-	-	-	-	-	-
	2	-	-	-	-	-	-	-	-	-
	3	-	-	-	-	-	-	-	-	-

NOTE: FIRST choice starting speeds are in **bold** type.  
As the average chip thickness increases, the speed should be decreased.

### M8090 • Recommended Starting Feeds [IPT]

Light Machining	General Purpose	Heavy Machining
-----------------	-----------------	-----------------

Insert Geometry	Programmed Feed per Tooth (fz) as a % of Radial Depth of Cut (ae)															Insert Geometry
	5%			10%			20%			30%			40-100%			
.S..MM	.007	<b>.023</b>	.037	.005	<b>.017</b>	.027	.004	<b>.013</b>	.020	.003	<b>.011</b>	.017	.003	<b>.010</b>	.016	.S..MM
.S..HN	.005	<b>.016</b>	.032	.003	<b>.012</b>	.023	.003	<b>.009</b>	.018	.002	<b>.008</b>	.015	.002	<b>.007</b>	.014	.S..HN

NOTE: Use "Light Machining" value as starting feed rate.  
For new applications, starting at a lighter feed rate is recommended.  
% = ae/Dc X 100 (ae = radial depth of cut, Dc = cutting diameter)

M8090-F • 1° • Shell Mills • Inch

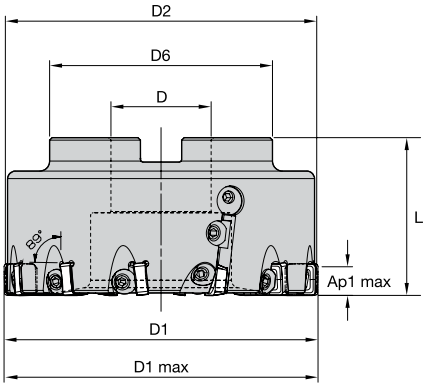

order number	catalog number	D1	D1 max	D	D2	D6	L	Ap1 max	Z	coolant supply	lbs
6921199	M8090FU400Z10W2S150SN12	4.000	4.015	1.250	3.921	3.780	2.000	.453	10	No	5.12
6921200	M8090FU600Z18W2S200SN12	6.000	6.015	2.000	5.921	4.815	2.480	.453	18	No	13.16
6921221	M8090FU800Z24W4S250SN12	8.000	8.015	2.500	7.921	5.118	2.480	.453	24	No	22.11

INDEXABLE MILLING

SOLID END MILLING

HOLE/MAKING

TAPPING

TURNING

INDEXABLE MILLING

SOLID END MILLING

HOLEMAKING

TAPPING

TURNING

## M8090-F • Wiper Inserts • SDEN

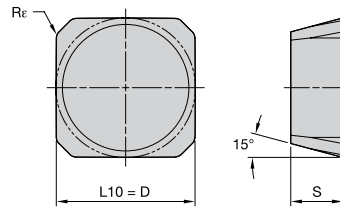

- first choice
- alternate choice

P					
M					
K	●	●	●	●	●
N	●				
S					
H					

ISO catalog number	ANSI catalog number	cutting edges	D		L10		S		BS		THM-F	WBK40U	WK15CM	WK15PM	WK25YM
			mm	in	mm	in	mm	in	mm	in					
SDEN1204PDEN4WC	SDEN1204PDEN4WC	4	12,70	.500	12,70	.500	4,76	.188	9,00	.354	6458851	6296241			

FOR SPARE PARTS, PLEASE VISIT [WIDIA.COM](http://WIDIA.COM) OR [WIDIANOVO.COM](http://WIDIANOVO.COM).  
MOUNTING SCREWS ARE NOT INCLUDED IN STANDARD PACKAGING.

M8090 • Insert Selection Guide

Material Group	Light Machining		General Purpose		Heavy Machining	
	Geometry	Grade	Geometry	Grade	Geometry	Grade
P1-P2	-	-	-	-	-	-
P3-P4	-	-	-	-	-	-
P5-P6	-	-	-	-	-	-
M1-M2	-	-	-	-	-	-
M3	-	-	-	-	-	-
K1-K2	.S..HN	WK25YM	.S..MM	WK15CM	.S..MM	WK15CM
K3	.S..MM	WK15PM	.S..MM	WK15PM	.S..MM	WK15PM
N1-N2	-	-	-	-	-	-
N3	-	-	-	-	-	-
S1-S2	-	-	-	-	-	-
S3	-	-	-	-	-	-
S4	-	-	-	-	-	-

M8090-F • Recommended Starting Speeds [SFM]

Material Group		THM-F			WBK40U			WK15CM			WK15PM			WK25YM		
P	1	-	-	-	-	-	-	-	-	-	-	-	-	-	-	
	2	-	-	-	-	-	-	-	-	-	-	-	-	-	-	
	3	-	-	-	-	-	-	-	-	-	-	-	-	-	-	
	4	-	-	-	-	-	-	-	-	-	-	-	-	-	-	
	5	-	-	-	-	-	-	-	-	-	-	-	-	-	-	
	6	-	-	-	-	-	-	-	-	-	-	-	-	-	-	
M	1	-	-	-	-	-	-	-	-	-	-	-	-	-	-	
	2	-	-	-	-	-	-	-	-	-	-	-	-	-	-	
	3	-	-	-	-	-	-	-	-	-	-	-	-	-	-	
K	1	475	<b>360</b>	295	4590	<b>2620</b>	1800	1380	<b>1260</b>	1120	1060	<b>965</b>	845	3170	<b>2875</b>	2555
	2	490	<b>390</b>	275	3280	<b>2180</b>	1640	1100	<b>970</b>	900	830	<b>750</b>	690	2500	<b>2245</b>	2090
	3	505	<b>375</b>	225	325	<b>2180</b>	1640	920	<b>820</b>	750	690	<b>630</b>	570	2105	<b>1870</b>	1710
N	1	-	-	-	-	-	-	-	-	-	-	-	-	-	-	-
	2	-	-	-	-	-	-	-	-	-	-	-	-	-	-	-
	3	-	-	-	-	-	-	-	-	-	-	-	-	-	-	-
S	1	-	-	-	-	-	-	-	-	-	-	-	-	-	-	-
	2	-	-	-	-	-	-	-	-	-	-	-	-	-	-	-
	3	-	-	-	-	-	-	-	-	-	-	-	-	-	-	-
	4	-	-	-	-	-	-	-	-	-	-	-	-	-	-	-
H	1	-	-	-	-	-	-	-	-	-	-	-	-	-	-	-
	2	-	-	-	-	-	-	-	-	-	-	-	-	-	-	-
	3	-	-	-	-	-	-	-	-	-	-	-	-	-	-	-

NOTE: FIRST choice starting speeds are in **bold** type.  
As the average chip thickness increases, the speed should be decreased.

M8090 • Recommended Starting Feeds [IPT]

Light Machining	General Purpose	Heavy Machining
-----------------	-----------------	-----------------

Insert Geometry	Programmed Feed per Tooth (fz) as a % of Radial Depth of Cut (ae)															Insert Geometry
	5%			10%			20%			30%			40-100%			
.S..MM	.007	<b>.023</b>	.037	.005	<b>.017</b>	.027	.004	<b>.013</b>	.020	.003	<b>.011</b>	.017	.003	<b>.010</b>	.016	.S..MM
.S..HN	.005	<b>.016</b>	.032	.003	<b>.012</b>	.023	.003	<b>.009</b>	.018	.002	<b>.008</b>	.015	.002	<b>.007</b>	.014	.S..HN

NOTE: Use "Light Machining" value as starting feed rate.  
For new applications, starting at a lighter feed rate is recommended.  
% = ae/Dc X 100 (ae = radial depth of cut, Dc = cutting diameter)

# M4070

## M4070 Face Mills

The M4070 heavy-duty face mill has powerful features trusted to continuously perform in demanding machining conditions while running high cutting parameters on uneven, non-uniform surfaces.



-MH



**WK15CM**

**K**

WK15CM is a wear-resistant grade with balanced toughness for general milling of cast irons. Best results in dry machining, but can also be used wet.

**WP35CM**

**P M K S**

WP35CM has a wide range of applications in general and rough milling of steels and cast iron. Performs best in dry, but can also be used under wet conditions.

# RELIABILITY AND SECURITY WITH M4070

## PRODUCT

SERIES  
M4070

## DIAMETER RANGE

6.0–12.0" (125–315mm)

## SHANK TYPES

Shell Mills

## INDUSTRY



## APPLICATIONS



FACE  
MILLING



## RELIABILITY

Hardened anvils to protect the cutter body from heavy-duty machining conditions.

## SECURITY

Tangential design with an M6 insert clamping screw for secure insert seating.

TO TACKLE HEAVY-DUTY MACHINING CONDITIONS



## M4070 • 20° • Shell Mills • Inch

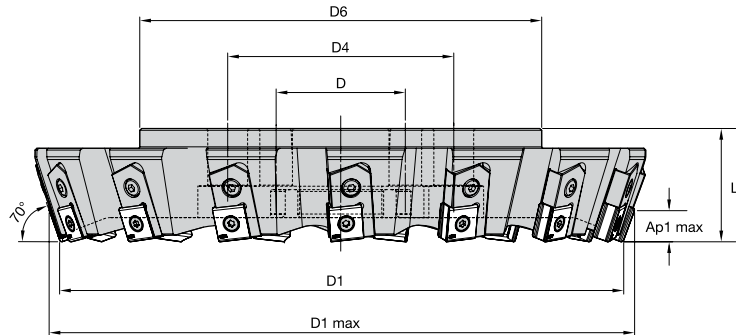

order number	catalog number	D1	D1 max	D	D4	D6	L	Ap1 max	Z	coolant supply	lbs
6921222	M4070U600Z08S200LN20	6.000	6.502	2.000	—	4.875	2.380	.681	8	No	12.90
6921223	M4070U800Z10S250LN20	8.000	8.501	2.500	4.000	5.118	2.380	.681	10	No	20.79
6921224	M4070U1000Z12S250LN20	10.000	10.501	2.500	4.000	8.857	2.380	.681	12	No	36.20
6921225	M4070U1200Z15S250LN20	12.000	12.501	2.500	4.000	8.875	3.150	.681	15	No	66.85

FOR SPARE PARTS, PLEASE VISIT [WIDIA.COM](http://WIDIA.COM) OR [WIDIANOVO.COM](http://WIDIANOVO.COM).  
MOUNTING SCREWS ARE NOT INCLUDED IN STANDARD PACKAGING.

M4070 • LNGX-MH

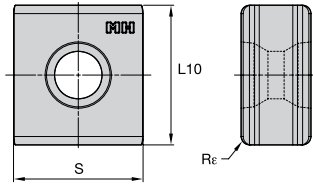

- first choice
- alternate choice

P	<input checked="" type="checkbox"/>	<input type="checkbox"/>	<input type="checkbox"/>
M	<input type="checkbox"/>	<input type="checkbox"/>	<input checked="" type="checkbox"/>
K	<input checked="" type="checkbox"/>	<input type="checkbox"/>	<input type="checkbox"/>
N	<input type="checkbox"/>	<input type="checkbox"/>	<input type="checkbox"/>
S	<input type="checkbox"/>	<input type="checkbox"/>	<input type="checkbox"/>
H	<input type="checkbox"/>	<input type="checkbox"/>	<input type="checkbox"/>

ISO catalog number	ANSI catalog number	cutting edges	L10		S		Rε		hm		WK15CM	WP35CM
			mm	in	mm	in	mm	in	mm	in		
LNGU201012SNMH	LNGU201012SNMH	4	20,00	.787	10,00	.394	1,20	.047	0,07	.003	6852417	6852418

INDEXABLE MILLING

SOLID END MILLING

HOLE/MAKING

TAPPING

TURNING

### M4070 • Insert Selection Guide

Material Group	Light Machining		General Purpose		Heavy Machining	
	Geometry	Grade	Geometry	Grade	Geometry	Grade
P1-P2	.S..MH	WP35CM	.S..MH	WP35CM	.S..MH	WP35CM
P3-P4	.S..MH	WP35CM	.S..MH	WP35CM	.S..MH	WP35CM
P5-P6	.S..MH	WP35CM	.S..MH	WP35CM	.S..MH	WP35CM
M1-M2	.S..MH	WP35CM	.S..MH	WP35CM	.S..MH	WP35CM
M3	.S..MH	WP35CM	.S..MH	WP35CM	.S..MH	WP35CM
K1-K2	.S..MH	WK15CM	.S..MH	WK15CM	.S..MH	WK15CM
K3	.S..MH	WK15CM	.S..MH	WK15CM	.S..MH	WK15CM
N1-N2	-	-	-	-	-	-
N3	-	-	-	-	-	-
S1-S2	-	-	-	-	-	-
S3	-	-	-	-	-	-
S4	.S..MH	WP35CM	.S..MH	WP35CM	.S..MH	WP35CM

### M4070 • Recommended Starting Speeds [SFM]

Material Group		WP35CM			WK15CM		
		1	2	3	1	2	3
P	1	1790	1555	1460	—	—	—
	2	1105	1000	905	—	—	—
	3	1000	905	805	—	—	—
	4	750	690	630	—	—	—
	5	1025	905	830	—	—	—
	6	630	535	360	—	—	—
M	1	805	725	610	—	—	—
	2	725	630	550	—	—	—
	3	570	510	450	—	—	—
K	1	1165	1045	940	1655	1520	1340
	2	925	830	750	1320	1165	1080
	3	770	690	630	1105	985	905
N	1	—	—	—	—	—	—
	2	—	—	—	—	—	—
	3	—	—	—	—	—	—
S	1	—	—	—	—	—	—
	2	—	—	—	—	—	—
	3	—	—	—	—	—	—
	4	260	200	130	—	—	—
H	1	—	—	—	—	—	—
	2	—	—	—	—	—	—
	3	—	—	—	—	—	—

NOTE: FIRST choice starting speeds are in **bold** type.  
As the average chip thickness increases, the speed should be decreased.

### M4070 • Recommended Starting Feeds [IPT]

Light Machining	General Purpose	Heavy Machining
-----------------	-----------------	-----------------

Insert Geometry	Programmed Feed per Tooth (fz) as a % of Radial Depth of Cut (ae)															Insert Geometry
	5%			10%			20%			30%			40-100%			
.S..MH	.010	<b>.025</b>	.039	.007	<b>.018</b>	.028	.005	<b>.013</b>	.021	.005	<b>.012</b>	.019	.004	<b>.011</b>	.017	.S..MH

NOTE: Use "Light Machining" value as starting feed rate.  
For new applications, starting at a lighter feed rate is recommended.  
% = ae/Dc X 100 (ae = radial depth of cut, Dc = cutting diameter)

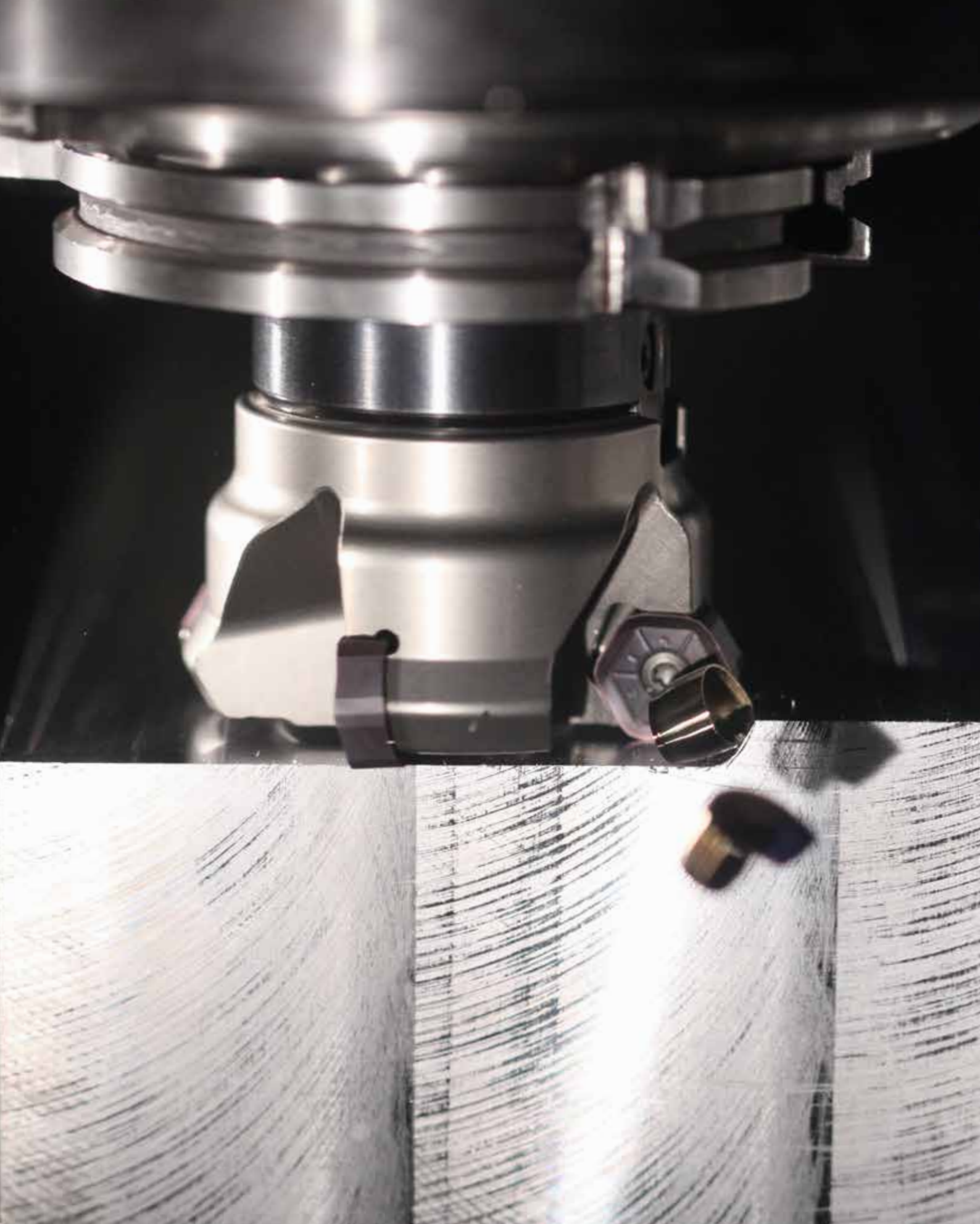

The SuperFeed is a PCD face mill for finishing milling of non-ferrous materials.

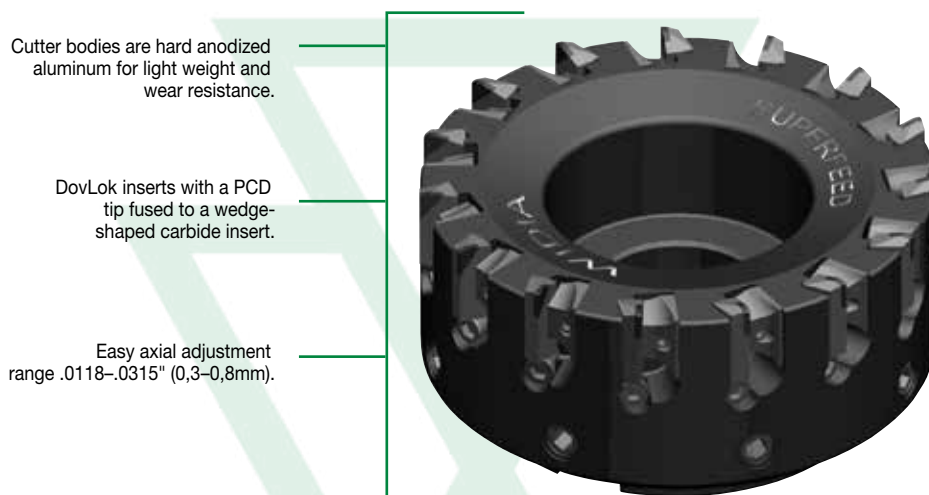

### INSERTS OFFERED IN GRADE WDN00U

FOR SHOULDER MILLING

FOR FACE MILLING



**EDR Insert**

**SDR Insert**



Corner radii .0315" (0,8mm).  
Axial DOC .25" (6,35mm) max.

Corner radii .0315" (0,8mm)  
and .0929" (2,36mm).  
Axial DOC .25" (6,35mm) max.

# NON-FERROUS PCD FACE MILLING

## PRODUCT

### SERIES

SuperFeed™

### DIAMETER RANGE

2.5–8" (63–200mm)

## SHANK TYPES

Shell Mills  
Cylindrical End Mills

## INDUSTRY



## APPLICATIONS



FACE  
MILLING



THROUGH  
COOLANT:  
RADIAL:  
INDEXABLE  
MILLING



PCD



SIDE MILLING/  
SHOULDER  
MILLING:  
SQUARE END

# NON-FERROUS

# PCD

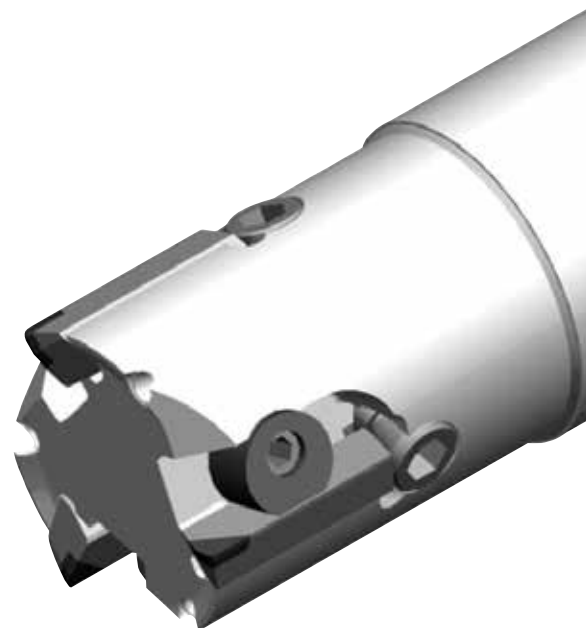

## SuperFeed • Face Mills • Inch

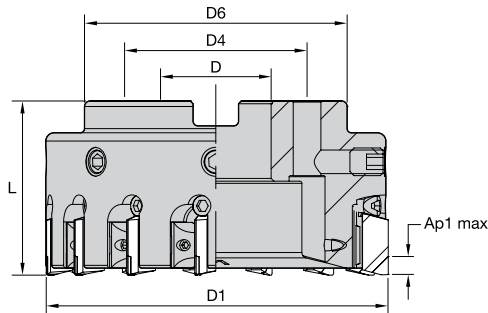

order number	catalog number	D1	D	D4	D6	L	Ap1 max	Z	Z ADJ	lbs	max RPM
5363040	SF02506RH	2.50	1.00	—	2.38	2.00	.25	6	6	1.00	20000
5363041	SF0308RH	3.00	1.00	—	2.88	2.00	.25	8	8	1.40	20000
5363042	SF0412RH	4.00	1.25	—	3.88	2.00	.25	12	12	2.50	17320
5363043	SF0515RH	5.00	1.50	—	4.88	2.38	.25	15	15	5.10	15500
5363044	SF0618RH	6.00	1.50	—	5.88	2.38	.25	18	18	7.00	14150
5363045	SF0824RH	8.00	2.50	4.00	7.94	2.38	.25	24	24	9.30	12240

NOTE: Z = Number of cartridges

Z ADJ = Number of adjustable cartridges

NOTE: Coolant cap screw or coolant shower plate must be ordered separately.  
SDR insert

## SuperFeed • End Mills • Inch

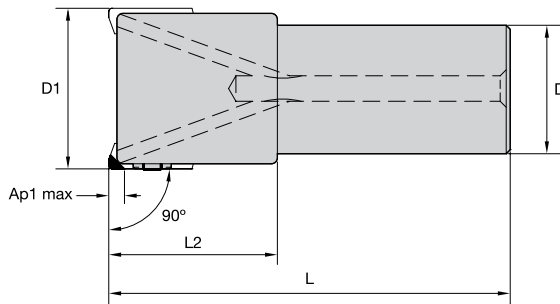

order number	catalog number	D1	D	L2	L	Ap1 max	Z	Z ADJ	lbs	max RPM
5363198	WSSEM1002RH	1.00	.75	1.50	3.50	.25	2	2	0.50	35500
5363199	WSSEM12503RH	1.25	1.00	1.75	4.00	.25	3	3	1.20	31700
5363250	WSSEM1504RH	1.50	1.00	1.75	4.00	.25	4	4	1.15	29000
5363251	WSSEM2005RH	2.00	1.00	1.70	4.50	.25	5	5	1.10	25100

NOTE: Z = Number of cartridges

Z ADJ = Number of adjustable cartridges

NOTE: For setting procedure, see page A73.  
EDR insert

FOR SPARE PARTS, PLEASE VISIT [WIDIA.COM](http://WIDIA.COM) OR [WIDIANOVO.COM](http://WIDIANOVO.COM).

MOUNTING SCREWS ARE NOT INCLUDED IN STANDARD PACKAGING.

SuperFeed • PCD Inserts • Face Mills • SDR

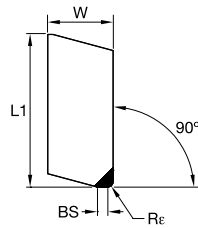

- first choice
- alternate choice

P	■
M	■
K	■
N	●
S	■
H	■

catalog number	cutting edges	L1	BS	W	Rε	hm	WDN00U
SDR100031E0NW	1	22,23	—	9,53	0,80	0,02	5358450
SDR100031E0W4	1	22,23	1,52	9,53	0,80	0,02	5358407
SDR100031E1W4	1	22,23	1,52	9,53	0,80	0,02	5358408
SDR100093E1W4	1	22,23	1,52	9,53	2,36	0,02	5358409
SDR102	1	22,22	—	9,52	3,17	0,02	5358451

NOTE: hm = Average chip thickness  
BS = Wiper facet length

SuperFeed • PCD Inserts • End Mills • EDR

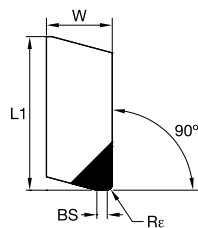

- first choice
- alternate choice

P	■
M	■
K	■
N	●
S	■
H	■

catalog number	cutting edges	L1	BS	W	Rε	hm	WDN00U
EDR100031E1W4	1	22,23	1,52	6,36	0,79	0,02	5358452

NOTE: hm = Average chip thickness  
BS = Wiper facet length  
E0 = 2,5 ap1 max  
E1 = 6,3 ap1 max.

INDEXABLE MILLING

SOLID END MILLING

HOLE/MAKING

TAPPING

TURNING



## SuperFeed • Insert Selection Guide

Material Group	Light Machining		General Purpose		Heavy Machining	
	Geometry	Grade	Geometry	Grade	Geometry	Grade
P1-P2	-	-	-	-	-	-
P3-P4	-	-	-	-	-	-
P5-P6	-	-	-	-	-	-
M1-M2	-	-	-	-	-	-
M3	-	-	-	-	-	-
K1-K2	-	-	-	-	-	-
K3	-	-	-	-	-	-
N1-N2	SDR.../EDR...	WDN00U	SDR.../EDR...	WDN00U	SDR.../EDR...	WDN00U
N3	SDR.../EDR...	WDN00U	SDR.../EDR...	WDN00U	SDR.../EDR...	WDN00U
S1-S2	-	-	-	-	-	-
S3	-	-	-	-	-	-
S4	-	-	-	-	-	-
H1	-	-	-	-	-	-

## SuperFeed • Recommended Starting Speeds [SFM]

Material Group		WDN00U	
P	1	-	-
	2	-	-
	3	-	-
	4	-	-
	5	-	-
	6	-	-
M	1	-	-
	2	-	-
	3	-	-
K	1	-	-
	2	-	-
	3	-	-
N	1-2	3000	6500
	3	1500	2000
S	1	-	-
	2	-	-
	3	-	-
	4	-	-
H	1	-	-

NOTE: FIRST choice starting speeds are in **bold** type.  
As the average chip thickness increases, the speed should be decreased

## SuperFeed • Recommended Starting Feeds [IPT]

Light Machining	General Purpose	Heavy Machining
-----------------	-----------------	-----------------

Insert Geometry	Programmed Feed per Tooth (fz) as a % of Radial Depth of Cut (ae)															Insert Geometry
	10%			20%			30%			40%			50-100%			
SDR...	.003	<b>.007</b>	.011	.003	<b>.005</b>	.008	.002	<b>.004</b>	.007	.002	<b>.004</b>	.006	.002	<b>.004</b>	.006	SDR...
EDR...	.003	<b>.007</b>	.011	.003	<b>.005</b>	.008	.002	<b>.004</b>	.007	.002	<b>.004</b>	.006	.002	<b>.004</b>	.006	EDR...

NOTE: FIRST choice starting feed (fz) is in **bold** type.  
Use corresponding speed (vc).  
fz and vc are valid for ae ≥ 0.4 D1.  
For smaller ae, fz and vc should be multiplied by the factor given below:

ae/D1 =	0.2	0.3	0.4
fz-Factor	1.5	1.3	1.0
vc-Factor	1.3	1.2	1.1

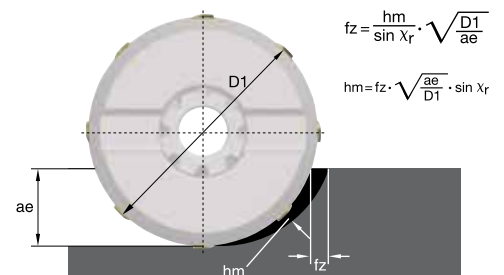

## Insert Setting and Fine Adjustment Procedure

### ▼ General

- Non-contact gages are preferred.
- Contact gages can be used with the following precautions:
  - Indicator must be flat and parallel to the base.
  - Always approach the PCD cartridge from the relief angle under the PCD segment.
  - Do NOT let the indicator drop on the PCD segment.
- Remove all worn PCD cartridges.
- Clean the pockets of the cutter completely.

### ▼ Face Mills

- Apply a small amount of lubricant to the following areas:
  - Pocket area where the wedge slides.
  - Threads of the cartridge locking screw.
  - Threads of the axial adjustment screw.
- Install cartridges applying light torque to the wedge assembly locking screw.
- Turn axial adjustment screw until the cartridge is 0,01–0,015mm below the final set height.
- Tighten the wedge assembly locking screw to 4 Nm.
- Turn the axial adjustment screw moving the PCD cartridge 0,005mm to the final set height position.
- Set all cartridges as above.

### ▼ End Mills

- Apply a small amount of lubricant to the following areas:
  - Threads of the cartridge locking screw.
  - Threads of the axial adjustment screw.
- Install cartridges applying light torque to the locking screws.
- Turn axial adjustment screw until the cartridge is 0,01–0,015mm below the final set height.
- Tighten the locking screw (left-hand threads) to 8 Nm leaving 0,005mm below the final set height.
- Turn the axial adjustment screw moving the PCD cartridge 0,005mm to the final set height position.
- Set all cartridges as above.

# M4000

## Cartridge Milling System

The M4000 cartridge milling system is a roughing and finishing solution with a single tool featuring easy-change cartridges with different insert styles and lead angles.

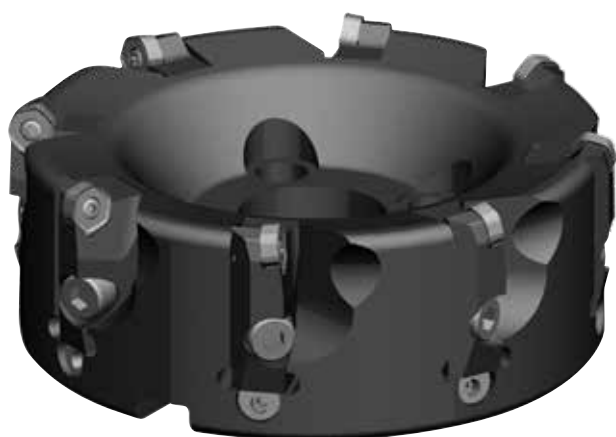

Quick cartridge stop — ready to go in a minute with no adjustment for roughing.

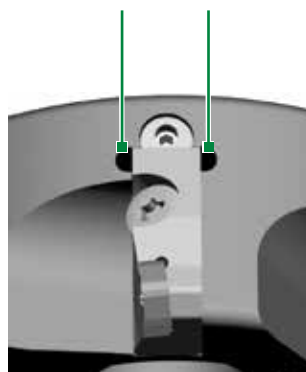

# ROUGHING AND FINISHING USING

**PRODUCT**

**SERIES**  
M4000

**DIAMETER RANGE**

4.921–12.400"  
(125–315mm)

**SHANK TYPES**

Face Mills

**INDUSTRY**



**APPLICATIONS**



FACE MILLING



SIDE MILLING/  
SHOULDER MILLING:  
SQUARE END

**VSM890-12**  
CARTRIDGE FOR M4000

M4000CA-SNHX12  
(MM6602179)

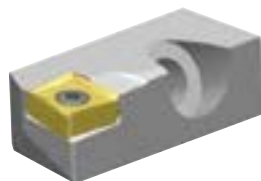

## M4000 • Face Mills • Inch

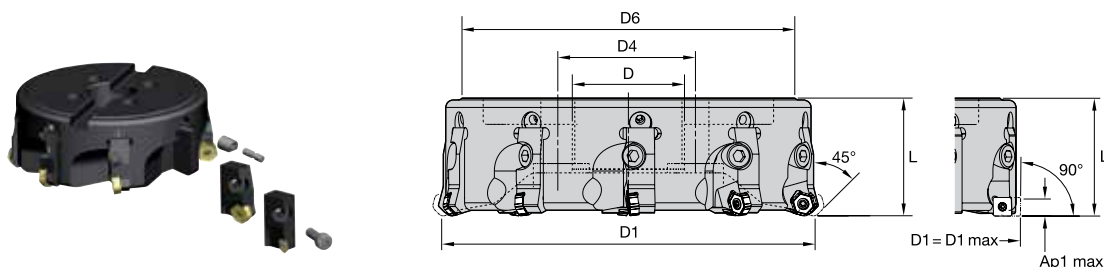

order number	catalog number	D1	D	D4	D6	L	L1	number of cartridges	max RPM	coolant supply	lbs
4136312	M4000D600Z08ADJ	6.000	2.000	—	5.394	2.480	2.480	8	1800	No	9.73
4136353	M4000D600Z12ADJ	6.000	2.000	—	5.394	3.150	3.150	12	1800	No	13.53
4136358	M4000D1200Z16ADJ	12.000	2.500	4.000	11.260	3.150	3.150	16	1000	No	50.57
4136359	M4000D1200Z22ADJ	12.000	2.500	4.000	11.260	3.150	3.150	22	1000	No	50.42

\* For all details regarding insert offering and cutting conditions, please refer to the master platforms.

## Face Mills • M4000 • Cartridge Milling System • Inch

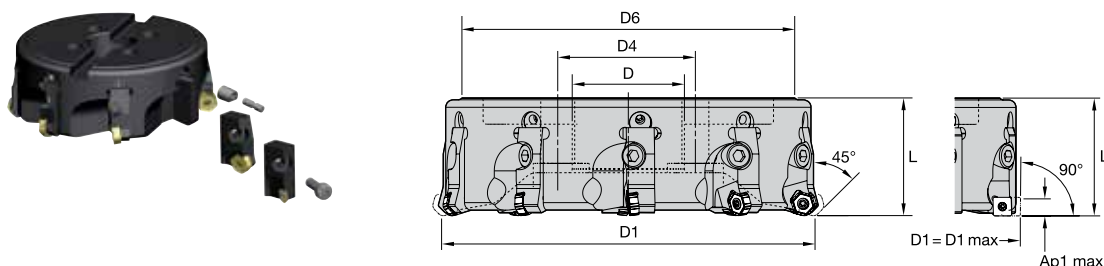

order number	catalog number	insert style	master platform *	Ap max
3968124	M4000CA-HN07	HN.J0704/XNG.J0704	M1200 Mini	.138
4159018	M4000CA-HN07HD	HN.J0704	M1200 Mini	.186
4159017	M4000CA-HN07HF	HN.J0704	M1200 Mini	.040
3126691	M4000CA-HN09	HN.J0905/XNG.J0905	M1200	.171
4159019	M4000CA-HN09HD	HN.J0905	M1200	.236
2511344	M4000CA-HP06	HP.T06T3	M640	.189
2006361	M4000CA-MDHX10	MDHX1004	M76	.040
2006346	M4000CA-RC1606	RC.T1606	M100	.315
2067492	M4000CA-SD1204	SDM.1204	M690	.459
2006359	M4000CA-SD1506	SDM.1506	M690	.587
2033495	M4000CA-SE1204	SE.N1204/SE.R1204	M68	—
2006377	M4000CA-SE1504	SE.N1504/SE.R1504	M68	—
2006348	M4000CA-SN12	SN.T1205/XNKT1205	M660	2.480
2006360	M4000CA-SN15	SN.T1505	M660	—
6602179	M4000CA-SNHX12	SNHX1204	VSM890-12	.387
2006362	M4000CA-SP12	121358680	M40Wiper	.354
2006373	M4000CA-SP1203	SP.N1203/SP.R1203	M40	—
2006376	M4000CA-SP1504	SP.N1504	M40	—
2033496	M4000CA-TP1603	TP.N1603/TP.R1603	M40	—
6152926	M4000CA-XDPT11	XDCT / XDET / XDPT / XDCW 1104	VSM11	.453
6152927	M4000CA-XDPT17	XDCT / XDET / XDPT 1704	VSM17	.625
6433216	M4000CA-XN10	XNPU / XNGU 1004	VSM490-10	.394
6357989	M4000CA-XN15	XNPU / XNGU 15T6	VSM490-15	.621
2006347	M4000CA-XP16	XP.T1604	M680	—

FOR SPARE PARTS, PLEASE VISIT [WIDIA.COM](http://WIDIA.COM) OR [WIDIANOVO.COM](http://WIDIANOVO.COM).

MOUNTING SCREWS ARE NOT INCLUDED IN STANDARD PACKAGING.



# Shoulder Milling Portfolio Overview





























































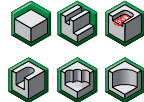
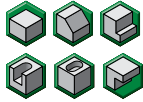
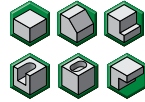
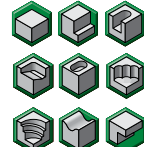
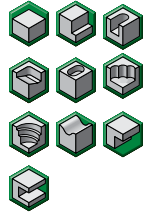



INDEXABLE MILLING

SOLID END MILLING

HOLEMAKING











TAPPING



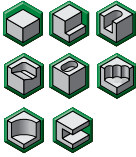
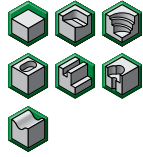
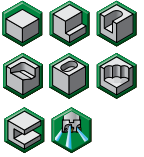
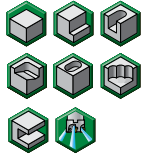
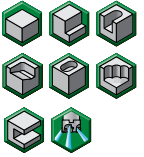

TURNING

					
Product					
	VSM890™ -12	VSM490™ -15	VSM490™ -10	VSM11™	VSM17™
Page	A122–A123	A106–A107	A106–A107	A80–A81	A90–A91
Victory™ – High-Performance					
Versatility					
Insert Style	Double-Sided	Double-Sided	Double-Sided	Single-Sided	Single-Sided
Pressed Inserts (PSTS)					
Ground Inserts					
Cutting Edge	8	4	4	2	2
Corner Radii	.032–.063" (0,8–1,6mm)	.016–.079" (0,4–2,0mm)	.016–.062" (0,4–1,6mm)	.0–.125" (0,2–2,4mm)	.0–.235" (0,4–6,0mm)
Max Depth-of-Cut	.3873" (9,8mm)	.6102" (15mm)	.394" (10mm)	.461" (11mm)	.647" (16mm)
Internal Coolant Supply					
Materials					
Achievable Surface Quality Wall					
Achievable Surface Quality Bottom					
Additional Operations					
 Shell Mills	2–10" (40–250mm)	1.5–6" (40–125mm)	1.5–5" (40–125mm)	1.5–3" (40–125mm)	1.5–6" (40–160mm)
 Shank Mills – Cylindrical	–	1–1.5" (25–32mm)	.625–1.5" (16–32mm)	.5–1" (12–32mm)	1–1.5" (25–40mm)
 Shank Mills – Weldon®	1.25–1.5" (32mm)	1–1.5" (25–32mm)	.625–1.5" (16–40mm)	.625–1.25" (12–32mm)	1–1.5" (25–40mm)
 Screw-On	–	– (25–35mm)	– (16–32mm)	.75–1.5" (16–40mm)	1–1.5" (25–40mm)
M4000 Cartridge					
Helical Mills					



# Shoulder Milling Portfolio Overview

	 	 					
	VSM22™	VHSC	M680	M680+	M680-09	M690-12	M690-15
	A100–A101	A146–A147	A128–A129	A128–A129	A128–A129	A134–A135	A134–A135
	✓	✓	✓	✓	✓	✓	✓
	✓	✓	✓	✓	✓	✓	✓
	Single-Sided	Single-Sided	Single-Sided	Single-Sided	Single-Sided	Single-Sided	Single-Sided
	○	○	⊙	○	○	○	○
	⊙	⊙	⊙	⊙	○	⊙	⊙
	2	2	2	2	2	4	4
	.0469 (1,2mm)	.010–.205" (0,4–5mm)	.016–.157" (0,4–4,0mm)	.0313" (0,8mm)	.015–.080" (0,4–2,0mm)	.0313–.126" (0,4–3,2mm)	.0469–.0625" (1,2–1,6mm)
	.7874" (20mm)	.630" (16mm)	.6046" (14mm)	.374" (9,5mm)	.3543" (9mm)	.4" (10mm)	.5" (12mm)
	⊙	⊙	○	○	○	○	○
	<b>P M K</b>	<b>N</b>	<b>P M K N S H</b>	<b>P M K N</b>	<b>P M K N</b>	<b>P M K N S H</b>	<b>P M K S H</b>
	✓	✓	✓	✓	✓	✓	✓
	✓	✓	✓	✓	✓	✓	✓
							
	3–6" (50–125mm)	1.5–4" (40–80mm)	.75" (40–125mm)	– (40mm)	–	2–3" (50–125mm)	3–4" (50–125mm)
	–	1–1.5" (25–32mm)	–	–	.625–1.25" (16–32mm)	–	–
	–	–	1" (25–40mm)	– (32mm)	–	1.5" –	–
	–	–	– (25–40mm)	– (25–32mm)	–	–	–
	○	○	⊙	⊙	⊙	○	⊙
	○	○	⊙	⊙	○	⊙	○

 Good    
  Perfect    
  Yes    
  No    
  All-Star Program

INDEXABLE MILLING

SOLID END MILLING

HOLEMAKING

TAPPING

TURNING



# VSM Single-Sided Series

## VSM11™ Shoulder Mill

The VSM11 shoulder mill will thrive in precise machining to medium roughing applications. Its two-edged, single-sided inserts deliver low horsepower consumption and soft cutting action on a variety of workpieces.



**Body:**

- Internal coolant supply.
- Optimized chip gash for improved cutter stability and chip flow.







**Insert:**

- Embedded wiper facet for great surface floor finish.
- Multiple corner nose radii R.008" to R.125" (.20–3.20mm) available; includes uses for aerospace applications.
- Super-positive rake design for soft cutting action and low machine power consumption.

The VSM11 shoulder mill is built for high DOC scenarios with  $A_p$  capabilities up to .453" (11mm) and a super-positive rake design for soft cutting action and low machine power consumption.

Six insert geometries are available to apply in a variety of applications and materials.

### GEOMETRIES FOR ALL MATERIAL GROUPS IN SHOULDER MILLING APPLICATIONS

<p><b>-ALP</b></p>  <p><b>N</b></p> <p>Roughing and finishing of aluminum alloys. High precision. Periphery ground.</p>	<p><b>-PCD</b></p>  <p><b>N</b></p> <p>Roughing and finishing of aluminum alloys. Abrasive non-ferrous materials. High precision. Periphery ground.</p>	<p><b>-ML</b></p>  <p><b>P M S H</b></p> <p>Light machining and finishing. First choice for stainless steel and titanium. Periphery ground.</p>	<p><b>-MM</b></p>  <p><b>P M K S H</b></p> <p>Medium machining. First choice for general purpose. Precision pressed to size.</p>	<p><b>-MH</b></p>  <p><b>P M K S</b></p> <p>First choice for heavy-duty machining. Steel and cast iron materials. Precision pressed to size.</p>	<p><b>-MU</b></p>  <p><b>P M K N S</b></p> <p>First choice for low to medium cutting parameters. Precision pressed to size and periphery ground.</p>
--	--	--	--	---	---

Finishing Capabilities/Lower Cutting Forces

Geometry Strengthening

# LOW POWER CONSUMPTION, HIGH DEPTH OF CUT

## PRODUCT

### SERIES

VSM11™

### DIAMETER RANGE

Screw-On: .75–1.5" (16–40mm)  
 Weldon®: .625–1.25" (12–32mm)  
 Cylindrical: .5–1.25" (12–32mm)  
 Shell: 1.5–4" (40–125mm)  
 Helical: 1–2" (25–50mm)

## SHANK TYPES

Screw-On End Mills  
 Weldon® End Mills  
 Cylindrical End Mills  
 Shell Mills  
 Helical End Mills

## INDUSTRY



## APPLICATIONS



SIDE MILLING/  
 SHOULDER  
 MILLING:  
 SQUARE END



SLOTTING:  
 SQUARE END



FACE  
 MILLING



RAMPING  
 BLANK



POCKETING



PLUNGE  
 MILLING



HELICAL  
 INTERPOLATION/  
 POCKET MILLING



3D  
 PROFILING



SIDE MILLING/  
 SHOULDER  
 MILLING:  
 BOTTOM  
 SHOULDERING

**LOW POWER  
 CONSUMPTION**

**SINGLE-SIDED  
 INSERTS**



## VSM11™ • Weldon® End Mills • Inch

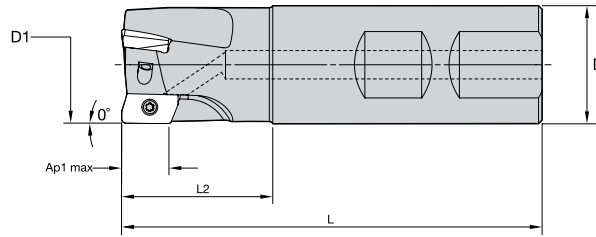

order number	catalog number	D1	D	L	L2	Ap1 max	Z	max ramp angle	max RPM	coolant supply	lbs
5416416	VSM11D062Z02W062XD11	.625	.625	2.750	.844	.454	2	12.5°	41700	Yes	.18
5416417	VSM11D075Z02W075XD11	.750	.750	3.200	1.170	.455	2	8.6°	36300	Yes	.30
5416418	VSM11D075Z03W075XD11	.750	.750	3.200	1.170	.455	3	8.6°	36300	Yes	.31
6025663	VSM11D100Z03W075XD11	1.000	.750	3.250	1.220	.453	3	5.1°	29900	Yes	.37
5416419	VSM11D100Z03W100XD11	1.000	1.000	3.500	1.220	.453	3	5.1°	29900	Yes	.62
5416450	VSM11D100Z04W100XD11	1.000	1.000	3.500	1.220	.453	4	5.1°	29900	Yes	.64
5416451	VSM11D125Z04W125XD11	1.250	1.250	4.000	1.720	.451	4	3.6°	25900	Yes	1.12
5416452	VSM11D125Z05W125XD11	1.250	1.250	4.000	1.720	.451	5	3.6°	25900	Yes	1.12

NOTE: Weldon type not recommended for finishing operations.  
 NOTE: Standard milling cutters will accept insert nose radii up to .062" without modification.  
 For tool body modification instructions, see page A96.

## VSM11 • Cylindrical End Mills (regular and long version) • Inch

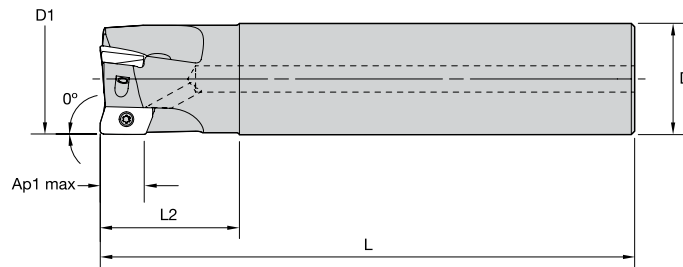

order number	catalog number	D1	D	L	L2	Ap1 max	Z	max ramp angle	max RPM	coolant supply	lbs
5416485	VSM11D050Z01C062XD11L400	.500	.625	4.000	.800	.461	1	4.2°	50400	Yes	.29
5416486	VSM11D062Z02C062XD11L400	.625	.625	4.000	1.000	.454	2	12.5°	41700	Yes	.28
5416487	VSM11D075Z02C075XD11L450	.750	.750	4.500	1.100	.455	2	8.6°	36300	Yes	.46
5416726	VSM11D075Z02C075XD11L670	.750	.750	6.700	1.610	.455	2	8.6°	36300	Yes	.69
5416488	VSM11D075Z03C075XD11L450	.750	.750	4.500	1.100	.455	3	8.6°	36300	Yes	.47
5416727	VSM11D075Z03C075XD11L670	.750	.750	6.700	1.610	.455	3	8.6°	36300	Yes	.70
6025664	VSM11D100Z03C075XD11L480	1.000	.750	4.800	1.282	.453	3	5.1°	29900	Yes	—
5416489	VSM11D100Z03C100XD11L480	1.000	1.000	4.800	1.250	.453	3	5.1°	29900	Yes	.90
5416728	VSM11D100Z03C100XD11L800	1.000	1.000	8.000	2.100	.453	3	5.1°	29900	Yes	1.54
5416520	VSM11D100Z04C100XD11L480	1.000	1.000	4.800	1.250	.453	4	5.1°	29900	Yes	.92
5416729	VSM11D100Z04C100XD11L800	1.000	1.000	8.000	2.100	.453	4	5.1°	29900	Yes	1.56
5416750	VSM11D125Z03C125XD11L980	1.250	1.250	9.800	2.510	.451	3	3.6°	25900	Yes	3.00
5416522	VSM11D125Z05C125XD11L520	1.250	1.250	5.200	1.600	.451	5	3.6°	25900	Yes	1.56

NOTE: Standard milling cutters will accept insert nose radii up to .062" without modification.  
 For tool body modification instructions, see page A96.

VSM11™ • Shell Mills • Inch

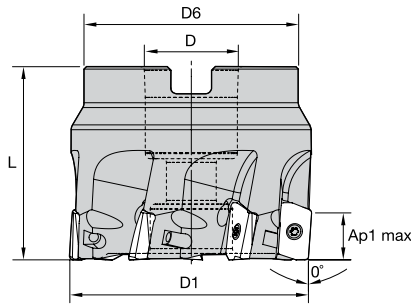

order number	catalog number	D1	D	D6	L	Ap1 max	Z	max ramp angle	max RPM	coolant supply	lbs
5416391	VSM11D150Z04S075XD11	1.500	.750	1.420	1.575	.449	4	2.8°	23300	Yes	.41
5416392	VSM11D150Z06S075XD11	1.500	.750	1.420	1.575	.449	6	2.8°	23300	Yes	.42
5416393	VSM11D200Z05S075XD11	2.000	.750	1.750	1.575	.446	5	1.9°	19700	Yes	.79
5416394	VSM11D200Z08S075XD11	2.000	.750	1.750	1.575	.446	8	1.9°	19700	Yes	.80
5416395	VSM11D250Z06S075XD11	2.500	.750	1.750	1.575	.446	6	1.5°	17400	Yes	1.19
5416396	VSM11D250Z09S075XD11	2.500	.750	1.750	1.575	.446	9	1.5°	17400	Yes	1.21
5416397	VSM11D300Z08S100XD11	3.000	1.000	2.190	1.750	.446	8	1.2°	15700	Yes	1.96
5416399	VSM11D400Z09S150XD11	4.000	1.500	3.380	2.000	.446	9	.9°	13500	Yes	3.95

NOTE: Standard milling cutters will accept insert nose radii up to .062" without modification.  
For tool body modification instructions, see page A96.

VSM11 • Helical Shell Mills • Inch

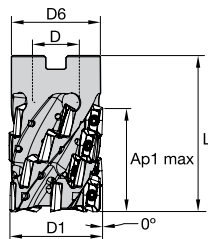

order number	catalog number	D1	D	D6	L	Ap1 max	Z	Z U	max ramp angle	max RPM	coolant supply	lbs
6081973	VHM11D200Z06S300XD11	2.000	1.000	1.910	3.000	2.032	30	6	1.8°	19700	Yes	1.60

FOR SPARE PARTS, PLEASE VISIT [WIDIA.COM](http://WIDIA.COM) OR [WIDIANOVO.COM](http://WIDIANOVO.COM).  
MOUNTING SCREWS ARE NOT INCLUDED IN STANDARD PACKAGING.

# 0°/90° Shoulder Mills • VSM Single-Sided Series

INDEXABLE MILLING

## VSM11H™ • Helical End Mills with Weldon® Shank • Inch

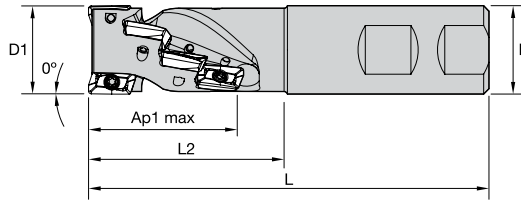

order number	catalog number	D1	D	L	L2	Ap1 max	Z	Z U	max ramp angle	max RPM	coolant supply	lbs
6740596	VSM11H100Z02W100XD11	1.000	1.000	4.530	2.250	1.700	8	2	4.4°	29700	Yes	.74
6740598	VSM11H125Z03W125XD11	1.250	1.250	4.530	2.250	1.700	12	3	3.2°	26500	Yes	1.20
6740599	VSM11H125Z04W125XD11	1.250	1.250	4.530	2.250	1.701	16	4	3.2°	26500	Yes	1.16

NOTE: Z = number of pockets; ZU = number of flutes.

SOLID END MILLING

## VSM11H • Helical Shell Mills • Inch

HOLEMAKING

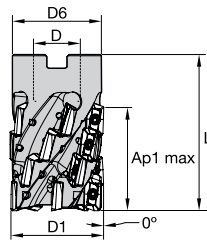

order number	catalog number	D1	D	D6	L	Ap1 max	Z	Z U	max ramp angle	max RPM	coolant supply	lbs
6740600	VSM11H150Z04S075XD11	1.500	.750	1.350	2.500	1.700	16	4	2.5°	23300	Yes	.65
6740671	VSM11H150Z05S075XD11	1.500	.750	1.350	2.500	1.650	20	5	2.5°	23300	Yes	.64
6740672	VSM11H200Z04S075XD11	2.000	.750	1.750	2.750	2.030	20	4	1.8°	19700	Yes	1.51
6740673	VSM11H200Z06S075XD11	2.000	.750	1.750	2.750	2.030	30	6	1.8°	19700	Yes	1.43

NOTE: Z = number of pockets; ZU = number of flutes.

TAPPING

TURNING

FOR SPARE PARTS, PLEASE VISIT [WIDIA.COM](http://WIDIA.COM) OR [WIDIANOVO.COM](http://WIDIANOVO.COM).  
MOUNTING SCREWS ARE NOT INCLUDED IN STANDARD PACKAGING.









# 0°/90° Shoulder Mills • VSM Single-Sided Series

INDEXABLE MILLING

SOLID END MILLING

HOLEMAKING

TAPPING

TURNING

## VSM11™ • XDPT-MH

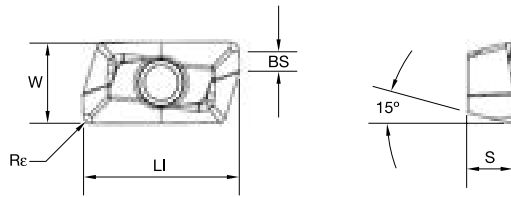

● first choice  
○ alternate choice

P	●								●	●	●	○	●	●	●
M	●								○	○	○	○	○	○	○
K	●	●	●												
N	●												○	○	○
S	●												○	○	○
H	●												○	○	○

ISO catalog number	ANSI catalog number	cutting edges	LI		BS		S		W		Rε		hm		WDN10U	WK15CM	WK15PM	WN10HM	WN25PM	WP25PM	WP35CM	WP40PM	WS30PM	WS40PM	WU20PM	WU35PM	
			mm	in	mm	in	mm	in	mm	in	mm	in	mm	in													mm
XDPT110408PDSRMH	XDPT1102SRMH	2	13,44	.529	1,68	.066	4,00	.157	6,90	.272	0,79	.031	0,13	.005	●	●	●	○	○	○	○	○	○	○	○	○	○
XDPT110412PDSRMH	XDPT1103SRMH	2	13,44	.529	1,29	.051	4,00	.157	6,90	.272	1,20	.047	0,13	.005	●	●	●	○	○	○	○	○	○	○	○	○	○
XDPT110416PDSRMH	XDPT1104SRMH	2	13,44	.529	0,90	.035	4,00	.157	6,90	.272	1,59	.062	0,13	.005	●	●	●	○	○	○	○	○	○	○	○	○	○

## VSM11 • XDPT-MU

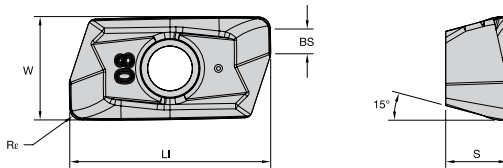

● first choice  
○ alternate choice

P	●														●	●	●	○	○	○	○	○	○	○	○	○	
M	●														○	○	○	○	○	○	○	○	○	○	○	○	○
K	●	●	●																								
N	●																										
S	●																										
H	●																										

ISO catalog number	ANSI catalog number	cutting edges	LI		BS		S		W		Rε		hm		WDN10U	WK15CM	WK15PM	WN10HM	WN25PM	WP25PM	WP35CM	WP40PM	WS30PM	WS40PM	WU20PM	WU35PM	
			mm	in	mm	in	mm	in	mm	in	mm	in	mm	in													mm
XDPT110408PDSRMU	XDPT1102SRMU	2	13,50	.531	1,66	.065	4,13	.163	6,94	.273	0,80	.031	0,06	.003	●	●	●	○	○	○	○	○	○	○	○	○	○
XDPT110416PDSRMU	XDPT1104SRMU	2	13,51	.532	0,85	.034	4,13	.163	6,95	.274	1,60	.063	0,06	.003	●	●	●	○	○	○	○	○	○	○	○	○	○

## VSM11 • Insert Selection Guide

Material Group	Light Machining		General Purpose		Universal		Heavy Machining	
	Geometry	Grade	Geometry	Grade	Geometry	Grade	Geometry	Grade
P1-P2	XDCT-ML	WP40PM	XDPT-MM	WP40PM	XD..-MU	WU20PM	XDPT-MH	WP40PM
P3-P4	XDCT-ML	WP40PM	XDPT-MM	WP40PM	XD..-MU	WU20PM	XDPT-MH	WP40PM
P5-P6	XDPT-MM	WP25PM	XDPT-MM	WP35CM	XD..-MU	WU20PM	XDPT-MH	WP40PM
M1-M2	XDCT-ML	WS40PM	XDPT-MM	WS40PM	XD..-MU	WU20PM	XDPT-MH	WS40PM
M3	XDCT-ML	WS40PM	XDPT-MM	WS40PM	XD..-MU	WU20PM	XDPT-MH	WS40PM
K1-K2	XDCT-ML	WK15CM	XDPT-MM	WK15CM	XD..-MU	WU20PM	XDPT-MH	WK15CM
K3	XDCT-ML	WP35CM	XDPT-MM	WP35CM	XD..-MU	WU20PM	XDPT-MH	WP35CM
N1-N2	XDCT-ALP	WN10HM	XDCT-ALP	WN25PM	-	-	XDCT-ALP	WN25PM
N3	XDCW-PCD	WDN10U	XDCW-PCD	WDN10U	-	-	XDCW-PCD	WDN10U
S1-S2	XDCT-ML	WP25PM	XDPT-MM	WS40PM	XD..-MU	WU20PM	XDPT-MH	WS40PM
S3	XDCT-ML	WS40PM	XDPT-MM	WS40PM	XD..-MU	WU20PM	XDPT-MH	WS40PM
S4	XDCT-ML	WS40PM	XDPT-MM	WS40PM	XD..-MU	WU20PM	XDPT-MH	WS40PM
H1	XDCT-ML	WP25PM	XDPT-MM	WP25PM	XD..-MU	WU20PM	XDPT-MU	WU20PM

NOTE: Use XDCT/XDET for precision.

VSM11™ • Recommended Starting Speeds [SFM]

Material Group		WDN10U			WK15CM			WK15PM			WN10HM			WN25PM			WP25PM		
P	1	—	—	—	—	—	—	—	—	—	—	—	—	—	—	—	1085	935	885
	2	—	—	—	—	—	—	—	—	—	—	—	—	—	—	—	900	785	655
	3	—	—	—	—	—	—	—	—	—	—	—	—	—	—	—	835	705	575
	4	—	—	—	—	—	—	—	—	—	—	—	—	—	—	—	740	605	490
	5	—	—	—	—	—	—	—	—	—	—	—	—	—	—	—	605	560	490
	6	—	—	—	—	—	—	—	—	—	—	—	—	—	—	—	540	410	330
M	1	—	—	—	—	—	—	—	—	—	—	—	—	—	—	—	675	590	540
	2	—	—	—	—	—	—	—	—	—	—	—	—	—	—	—	605	525	425
	3	—	—	—	—	—	—	—	—	—	—	—	—	—	—	—	460	395	310
K	1	—	—	—	1380	<b>1265</b>	1115	885	<b>805</b>	705	—	—	—	—	—	—	755	<b>675</b>	605
	2	—	—	—	1100	<b>970</b>	900	690	<b>625</b>	575	—	—	—	—	—	—	590	<b>525</b>	490
	3	—	—	—	920	<b>820</b>	755	575	<b>525</b>	475	—	—	—	—	—	—	490	<b>445</b>	395
N	1	13155	<b>11500</b>	9810	—	—	—	—	—	—	2605	<b>2275</b>	1965	3525	<b>3100</b>	2870	—	—	—
	2	5250	<b>4905</b>	4595	—	—	—	—	—	—	2605	<b>2275</b>	1965	3100	<b>2870</b>	2495	—	—	—
	3	5250	<b>4905</b>	4595	—	—	—	—	—	—	1835	<b>1590</b>	1375	3100	<b>2870</b>	2495	—	—	—
S	1	—	—	—	—	—	—	—	—	—	—	—	—	—	—	—	130	<b>115</b>	80
	2	—	—	—	—	—	—	—	—	—	—	—	—	—	—	—	130	<b>115</b>	80
	3	—	—	—	—	—	—	—	—	—	—	—	—	—	—	—	165	<b>130</b>	80
	4	—	—	—	—	—	—	—	—	—	—	—	—	—	—	—	230	<b>165</b>	115
H	1	—	—	—	—	—	—	—	—	—	—	—	—	—	—	—	395	<b>295</b>	230

Material Group		WP35CM			WP40PM			WS30PM			WS40PM			WU20PM			WU35PM		
P	1	1495	<b>1295</b>	1215	970	<b>855</b>	805	—	—	—	—	—	—	1080	<b>950</b>	885	855	<b>755</b>	705
	2	920	<b>835</b>	755	820	<b>705</b>	590	—	—	—	—	—	—	900	<b>820</b>	655	720	<b>625</b>	525
	3	835	<b>755</b>	675	755	<b>640</b>	525	—	—	—	—	—	—	835	<b>720</b>	570	655	<b>560</b>	460
	4	625	<b>575</b>	525	675	<b>560</b>	445	—	—	—	—	—	—	735	<b>620</b>	490	590	<b>490</b>	395
	5	855	<b>755</b>	690	560	<b>510</b>	445	—	—	—	560	<b>475</b>	395	605	<b>570</b>	490	490	<b>445</b>	395
	6	525	<b>445</b>	360	490	<b>375</b>	295	—	—	—	490	<b>360</b>	260	540	<b>425</b>	325	425	<b>330</b>	260
M	1	675	<b>605</b>	510	640	<b>560</b>	510	740	<b>655</b>	605	690	<b>560</b>	460	670	<b>590</b>	540	560	<b>490</b>	445
	2	605	<b>525</b>	460	575	<b>490</b>	410	675	<b>590</b>	475	590	<b>475</b>	395	605	<b>520</b>	425	510	<b>425</b>	360
	3	475	<b>425</b>	375	425	<b>375</b>	295	510	<b>445</b>	345	475	<b>360</b>	280	455	<b>390</b>	310	375	<b>330</b>	260
K	1	970	<b>870</b>	785	—	—	—	—	—	—	—	—	—	820	<b>720</b>	605	—	—	—
	2	770	<b>690</b>	625	—	—	—	—	—	—	—	—	—	655	<b>590</b>	490	—	—	—
	3	640	<b>575</b>	525	—	—	—	—	—	—	—	—	—	590	<b>490</b>	390	—	—	—
N	1	—	—	—	—	—	—	—	—	—	—	—	—	1800	<b>1540</b>	1310	—	—	—
	2	—	—	—	—	—	—	—	—	—	—	—	—	1800	<b>1540</b>	1310	—	—	—
	3	—	—	—	—	—	—	—	—	—	—	—	—	1310	<b>1145</b>	980	—	—	—
S	1	—	—	—	—	—	—	150	<b>130</b>	100	130	<b>115</b>	80	130	<b>110</b>	80	115	<b>100</b>	80
	2	—	—	—	—	—	—	150	<b>130</b>	100	130	<b>115</b>	80	130	<b>110</b>	80	115	<b>100</b>	80
	3	—	—	—	—	—	—	180	<b>150</b>	100	165	<b>130</b>	80	160	<b>130</b>	80	150	<b>115</b>	80
	4	—	—	—	—	—	—	230	<b>195</b>	130	195	<b>165</b>	100	225	<b>160</b>	110	195	<b>150</b>	100
H	1	—	—	—	—	—	—	—	—	—	—	—	—	360	<b>260</b>	225	—	—	—

NOTE: FIRST choice starting speeds are in **bold** type.  
 As the average chip thickness increases, the speed should be decreased.  
 \*Material groups P, M, K, and H show recommended starting speeds for dry machining. For wet machining, reduce speed by 20%.  
 \*Material groups N and S show recommended starting speeds for wet machining. Not recommended for dry machining.

VSM11 • Recommended Starting Feeds [IPT]

Light Machining	General Purpose	Heavy Machining
-----------------	-----------------	-----------------

Insert Geometry	Programmed Feed per Tooth (fz) as a % of Radial Depth of Cut (ae)															Insert Geometry
	5%			10%			20%			30%			40-100%			
.F..PCD	.005	<b>.007</b>	.011	.003	<b>.005</b>	.008	.003	<b>.004</b>	.006	.002	<b>.003</b>	.005	.002	<b>.003</b>	.005	.F..PCD
.F..ALP	.005	<b>.009</b>	.013	.003	<b>.006</b>	.009	.003	<b>.005</b>	.007	.002	<b>.004</b>	.006	.002	<b>.004</b>	.005	.F..ALP
.E..ML	.007	<b>.011</b>	.014	.005	<b>.008</b>	.010	.004	<b>.006</b>	.008	.003	<b>.005</b>	.007	.003	<b>.005</b>	.006	.E..ML
.S..MM/S..MU	.009	<b>.013</b>	.019	.007	<b>.009</b>	.013	.005	<b>.007</b>	.010	.004	<b>.006</b>	.009	.004	<b>.006</b>	.008	.S..MM/S..MU
.S..MH	.009	<b>.014</b>	.022	.007	<b>.010</b>	.016	.005	<b>.008</b>	.012	.004	<b>.007</b>	.010	.004	<b>.006</b>	.009	.S..MH

NOTE: Use "Light Machining" values as starting feed rate.

# VSM Single-Sided Series

## VSM17™ Shoulder Mill



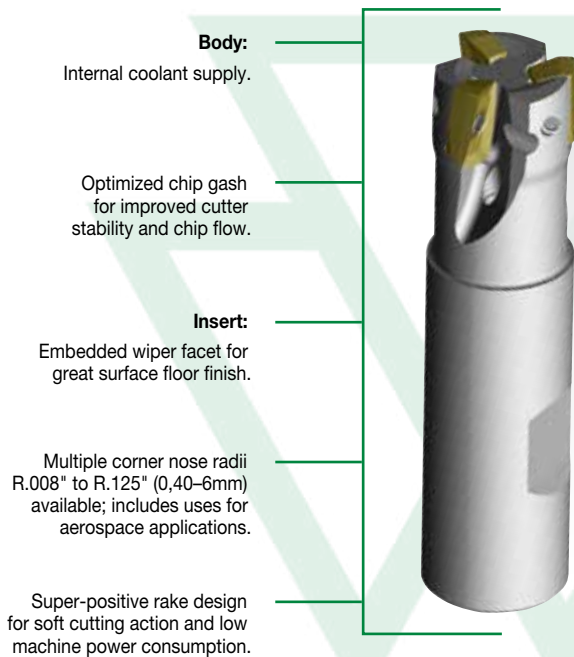

The VSM17 shoulder mill will thrive in precise machining to medium roughing applications. Its two-edged, single-sided inserts deliver low horsepower consumption and soft cutting action on a variety of workpieces.

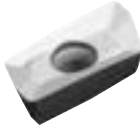

The VSM17 shoulder mill is built for high DOC scenarios with  $A_p$  capabilities up to .638" (16mm) and a super-positive rake design for soft cutting action and low machine power consumption.

Six insert geometries are available to apply in a variety of applications and materials.

### GEOMETRIES FOR ALL MATERIAL GROUPS IN SHOULDER MILLING APPLICATIONS

-ALP	-ML	-MM	-MH	-MU
				
<b>N</b>	<b>P M S H</b>	<b>P M K S H</b>	<b>P M K S</b>	<b>P M K N S</b>
Roughing and finishing of aluminum alloys. High precision. Periphery ground.	Light machining and finishing. First choice for stainless steel and titanium. Periphery ground.	Medium machining. First choice for general purpose. Precision pressed to size.	First choice for heavy-duty machining. Steel and cast iron materials. Precision pressed to size.	First choice for low to medium cutting parameters. Precision pressed to size and periphery ground.

Finishing Capabilities/Lower Cutting Forces

Geometry Strengthening

# LOW POWER CONSUMPTION, HIGH DEPTH OF CUT

**PRODUCT**

**SERIES**

VSM17™

**DIAMETER RANGE**

Screw-On: .1–1.5" (25–40mm)  
 Weldon: 1–1.25" (25–40mm)  
 Cylindrical: 1–1.5" (25–40mm)  
 Shell: 1.5–6" (40–125mm)  
 Helical: 2–2.5" (50–80mm)

**SHANK TYPES**

Screw-On End Mills  
 Weldon® End Mills  
 Cylindrical End Mills  
 Shell Mills  
 Helical End Mills

**INDUSTRY**



SIDE MILLING/  
SHOULDER  
MILLING:  
SQUARE END



SIDE MILLING/  
SHOULDER  
MILLING:  
BOTTOM  
SHOULDERING



SLOTING:  
SQUARE END



SLOTING  
SIDE



FACE  
MILLING



RAMPING  
BLANK



HELICAL  
INTERPOLATION/  
POCKET MILLING



3D  
PROFILING



POCKETING



PLUNGE  
MILLING

**LOW POWER  
CONSUMPTION**

**SINGLE-SIDED  
INSERTS**

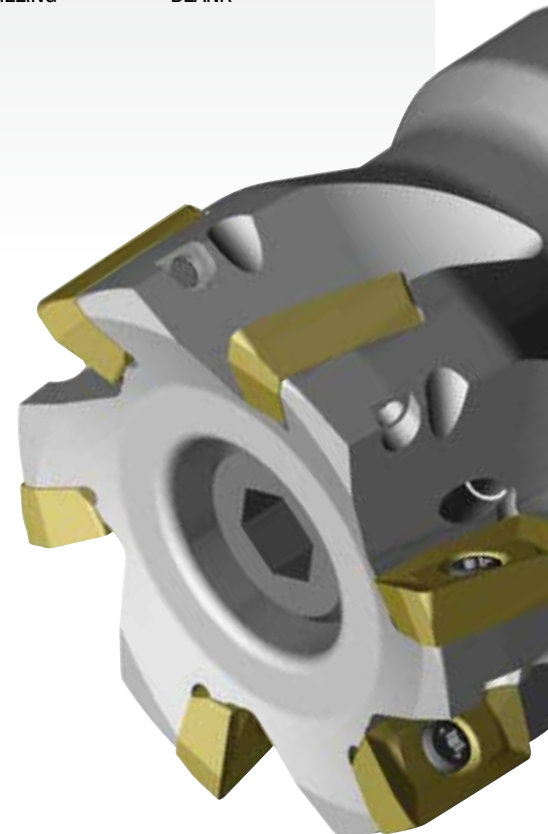

## VSM17™ • Weldon® End Mills • Inch

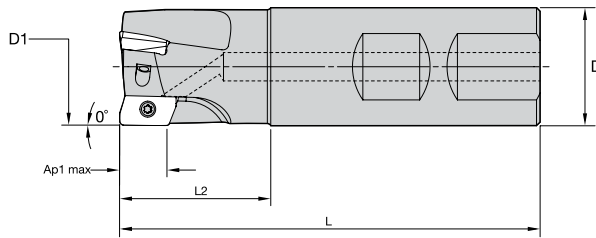

order number	catalog number	D1	D	L	L2	Ap1 max	Z	max ramp angle	max RPM	coolant supply	lbs
5988028	VSM17D100Z02W100XD17	1.000	1.000	3.500	1.220	.642	2	8.5°	41300	Yes	.59
5988052	VSM17D125Z02W125XD17	1.250	1.250	4.000	1.720	.641	2	5.8°	34700	Yes	1.06
5988029	VSM17D125Z03W125XD17	1.250	1.250	4.000	1.720	.641	3	5.8°	34700	Yes	1.05
5988051	VSM17D150Z03W150XD17	1.500	1.500	4.500	1.810	.638	3	4.3°	30700	Yes	1.77
5988030	VSM17D150Z04W150XD17	1.500	1.500	4.500	1.810	.638	4	4.3°	30700	Yes	1.77

NOTE: Weldon type not recommended for finishing operations.  
 NOTE: Standard milling cutters will accept insert nose radii up to .062" without modification.  
 For tool body modification instructions, see page A96.

## VSM17 • Cylindrical End Mills (regular and long version) • Inch

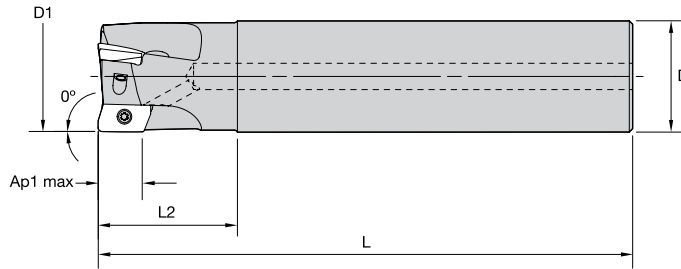

order number	catalog number	D1	D	L	L2	Ap1 max	Z	max ramp angle	max RPM	coolant supply	lbs
5988011	VSM17D100Z02C100XD17L450	1.000	1.000	4.500	1.750	.642	2	8.5°	41300	Yes	.78
5988012	VSM17D100Z02C100XD17L670	1.000	1.000	6.700	1.750	.642	2	8.5°	41300	Yes	1.23
5988013	VSM17D125Z03C125XD17L480	1.250	1.250	4.800	2.000	.641	3	5.8°	34700	Yes	1.31
5988014	VSM17D125Z03C125XD17L800	1.250	1.250	8.000	2.000	.641	3	5.8°	34700	Yes	2.36
5988043	VSM17D150Z03C150XD17L520	1.500	1.500	5.200	2.000	.638	3	4.3°	30700	Yes	2.11
5988044	VSM17D150Z03C150XD17L980	1.500	1.500	9.800	2.000	.638	3	4.3°	30700	Yes	4.33
5988015	VSM17D150Z04C150XD17L520	1.500	1.500	5.200	2.000	.638	4	4.3°	30700	Yes	2.11
5988016	VSM17D150Z04C150XD17L980	1.500	1.500	9.800	2.000	.638	4	4.3°	30700	Yes	4.33

NOTE: Standard milling cutters will accept insert nose radii up to .062" without modification.  
 For tool body modification instructions, see page A96.

FOR SPARE PARTS, PLEASE VISIT [WIDIA.COM](http://WIDIA.COM) OR [WIDIANOVO.COM](http://WIDIANOVO.COM).  
 MOUNTING SCREWS ARE NOT INCLUDED IN STANDARD PACKAGING.

VSM17™ • Shell Mills • Inch

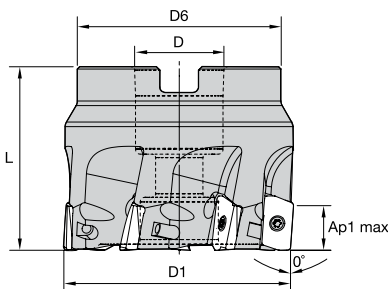

order number	catalog number	D1	D	D6	L	Ap1 max	Z	max ramp angle	max RPM	coolant supply	lbs
5988020	VSM17D150Z04S075XD17	1.500	.750	1.417	1.575	.638	4	4.3°	30700	Yes	.38
5988021	VSM17D200Z04S075XD17	2.000	.750	1.750	1.575	.635	4	3.0°	25600	Yes	.68
5988022	VSM17D200Z05S075XD17	2.000	.750	1.750	1.575	.635	5	3.0°	25600	Yes	.71
5988050	VSM17D200Z06S075XD17	2.000	.750	1.750	1.575	.635	6	3.0°	25600	Yes	.66
5988023	VSM17D250Z05S075XD17	2.500	.750	1.750	1.575	.629	5	2.1°	22300	Yes	.98
5988048	VSM17D250Z06S075XD17	2.500	.750	1.750	1.575	.629	6	2.1°	22300	Yes	.97
5988024	VSM17D300Z06S100XD17	3.000	1.000	2.188	1.750	.626	6	1.7°	20100	Yes	1.73
5988047	VSM17D300Z07S100XD17	3.000	1.000	2.188	1.750	.626	7	1.7°	20100	Yes	1.68
5988025	VSM17D400Z08S150XD17	4.000	1.500	3.375	2.000	.623	8	1.2°	17100	Yes	3.52
5988026	VSM17D500Z09S150XD17	5.000	1.500	3.375	2.000	.617	9	.9°	15100	Yes	5.07
5988027	VSM17D600Z12S150XD17	6.000	1.500	3.375	2.000	.616	12	.7°	13700	Yes	6.88

NOTE: Standard milling cutters will accept insert nose radii up to .062" without modification.  
For tool body modification instructions, see page A96.

VSM17H • Helical Shell Mills • Long Reach • Inch

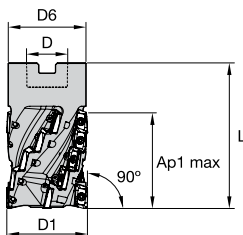

order number	catalog number	D1	D	D6	L	Ap1 max	Z	Z U	max ramp angle	max RPM	coolant supply	lbs
6083082	VHM17D200Z04S350XD17	2.000	1.000	1.910	3.500	2.380	16	4	3.0°	25600	Yes	1.79
6083085	VHM17D200Z04S550XD17	2.000	1.000	1.910	5.500	4.120	28	4	3.0°	25600	Yes	2.81

NOTE: Z = number of pockets; ZU = number of flutes.

VSM17H™ • Helical Shell Mills • Inch

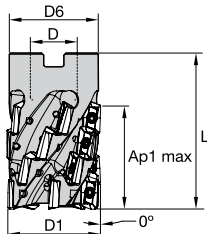

order number	catalog number	D1	D	D6	L	Ap1 max	Z	Z U	max ramp angle	max RPM	coolant supply	lbs
6740681	VSM17H200Z04S075XD17	2.000	.750	1.750	3.500	2.380	16	4	2.8°	25500	Yes	1.85
6740682	VSM17H200Z05S075XD17	2.000	.750	1.750	3.500	2.380	20	5	2.8°	25500	Yes	1.81
6740683	VSM17H250Z04S100XD17	2.500	1.000	2.190	4.000	2.950	20	4	2.1°	22300	Yes	3.39
6740684	VSM17H250Z05S100XD17	2.500	1.000	2.190	4.000	2.900	25	5	2.1°	22300	Yes	3.30
6740685	VSM17H300Z05S125XD17	3.000	1.250	2.875	4.000	2.950	25	5	1.7°	20000	Yes	5.41

# 0°/90° Shoulder Mills • VSM Single-Sided Series

INDEXABLE MILLING

SOLID END MILLING

HOLEMAKING

TAPPING

TURNING

## VSM17™ • XDCT-ALP

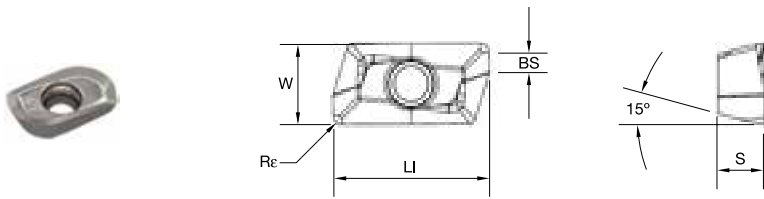

- first choice
- alternate choice

P	●							●	●	●	●	●	●	●	●	●	●
M	●							●	●	●	●	●	●	●	●	●	●
K	●	●	●					○	○	○	○	○	○	○	○	○	○
N	●							○	○	○	○	○	○	○	○	○	○
S	○							○	○	○	○	○	○	○	○	○	○
H								○	○	○	○	○	○	○	○	○	○

ISO catalog number	ANSI catalog number	cutting edges	LI		BS		S		W		Re		hm		WK15CM	WK15PM	WN10HM	WN25PM	WP25PM	WP35CM	WP40PM	WS40PM	WU20PM	WU35PM		
			mm	in	mm	in	mm	in	mm	in	mm	in	mm	in											mm	in
XDCT170404PEFRALP	XDCT1701RALP	2	19,15	.754	2,62	.103	4,90	.193	9,60	.378	0,40	.016	0,02	.001	●	●	○	○	○	○	○	○	○	○	○	○
XDCT170408PEFRALP	XDCT1702RALP	2	19,15	.754	2,22	.088	4,90	.193	9,60	.378	0,80	.031	0,02	.001	●	●	○	○	○	○	○	○	○	○	○	○
XDCT170412PEFRALP	XDCT1703RALP	2	19,16	.754	1,82	.072	4,90	.193	9,60	.378	1,20	.047	0,02	.001	●	●	○	○	○	○	○	○	○	○	○	○
XDCT170416PEFRALP	XDCT1704RALP	2	19,17	.755	1,42	.056	4,90	.193	9,60	.378	1,60	.063	0,02	.001	●	●	○	○	○	○	○	○	○	○	○	○
XDCT170420PEFRALP	XDCT1705RALP	2	19,17	.755	1,01	.040	4,90	.193	9,60	.378	2,00	.079	0,02	.001	●	●	○	○	○	○	○	○	○	○	○	○
XDCT170424PEFRALP	XDCT1706RALP	2	19,17	.755	0,63	.025	4,90	.193	9,60	.378	2,40	.094	0,02	.001	●	●	○	○	○	○	○	○	○	○	○	○
XDCT170432PEFRALP	XDCT1708RALP	2	18,85	.742	—	—	4,88	.192	9,59	.378	3,20	.125	0,02	.001	●	●	○	○	○	○	○	○	○	○	○	○
XDCT170440PEFRALP	XDCT1710RALP	2	18,33	.722	—	—	4,87	.192	9,59	.377	4,00	.157	0,02	.001	●	●	○	○	○	○	○	○	○	○	○	○
XDCT170460PEFRALP	XDCT1715RALP	2	17,02	.670	—	—	4,80	.189	9,56	.376	6,00	.235	0,02	.001	●	●	○	○	○	○	○	○	○	○	○	○

FOR SPARE PARTS, PLEASE VISIT [WIDIA.COM](http://WIDIA.COM) OR [WIDIANOVO.COM](http://WIDIANOVO.COM).  
MOUNTING SCREWS ARE NOT INCLUDED IN STANDARD PACKAGING.

## VSM17™ • XDCT-ML

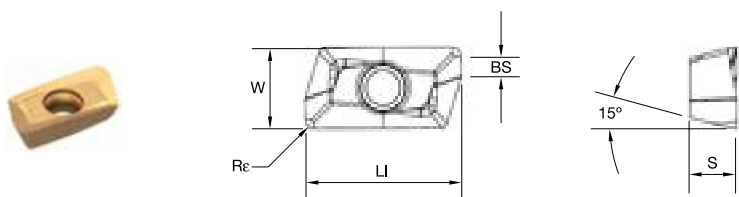

● first choice  
○ alternate choice

P					●	●	●	●	●	●	●	●	●	●
M					○	○	○	○	○	○	○	○	○	○
K	●	●												
N					●	●								
S											○	○	○	○
H											○	○	○	○

ISO catalog number	ANSI catalog number	cutting edges	LI		BS		S		W		Re		hm		WK15CM	WK15PM	WN10HM	WN25PM	WP25PM	WP35CM	WP40PM	WS40PM	WU20PM	WU35PM	
			mm	in	mm	in	mm	in	mm	in	mm	in	mm	in											mm
XDCT170404PEERML	XDCT1701ERML	2	19,15	.754	2,62	.103	4,90	.193	9,60	.378	0,40	.016	0,04	.002	•	•	•	•	•	•	•	•	•	•	•
XDCT170408PEERML	XDCT1702ERML	2	19,15	.754	2,22	.088	4,90	.193	9,60	.378	0,80	.031	0,04	.002	•	•	•	•	○	○	○	○	○	○	○
XDCT170412PEERML	XDCT1703ERML	2	19,16	.754	1,82	.072	4,90	.193	9,60	.378	1,20	.047	0,04	.002	•	•	•	•	5989988	5989982	5989981	6180180			
XDCT170416PEERML	XDCT1704ERML	2	19,17	.755	1,42	.056	4,90	.193	9,60	.378	1,60	.062	0,04	.002	•	•	•	•	6001257	6001256	6425261	6425263			
XDCT170420PEERML	XDCT1705ERML	2	19,17	.755	1,01	.040	4,90	.193	9,60	.378	2,00	.079	0,04	.002	•	•	•	•	6001255	6001255	6425263				
XDCT170424PEERML	XDCT1706ERML	2	19,17	.755	0,63	.025	4,90	.193	9,60	.378	2,40	.094	0,04	.002	•	•	•	•	6001253	6001253	6425264	6425265			
XDCT170432PEERML	XDCT1708ERML	2	18,85	.742	—	—	4,89	.192	9,59	.378	3,20	.125	0,04	.002	•	•	•	•	6001251	6001251	6425265				
XDCT170440PEERML	XDCT1710ERML	2	18,33	.722	—	—	4,87	.192	9,59	.377	4,00	.157	0,04	.002	•	•	•	•	6001239	6001239	6425266				
XDCT170460PEERML	XDCT1715ERML	2	17,02	.670	—	—	4,80	.189	9,56	.376	6,00	.235	0,04	.002	•	•	•	•	6118069	6118069	6232053				

INDEXABLE MILLING

SOLID END MILLING

HOLE/MAKING

TAPPING

TURNING



## VSM17™ • XDET -MU

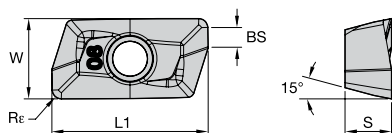
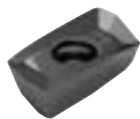

● first choice  
○ alternate choice

P					●	●	●	●	●	●	●	●	●	●
M					●	●	●	●	●	●	●	●	●	●
K					●	●	●	●	●	●	●	●	●	●
N					●	●	●	●	●	●	●	●	●	●
S					●	●	●	●	●	●	●	●	●	●
H					○	○	○	○	○	○	○	○	○	○

ISO catalog number	ANSI catalog number	cutting edges	LI		BS		S		W		Re		hm		WK15CM	WK15PM	WN10HM	WN25PM	WP25PM	WP35CM	WP40PM	WS40PM	WU20PM	WU35PM
			mm	in	mm	in	mm	in	mm	in	mm	in	mm	in										
XDET170408PEERMU	XDET1702ERMU	2	19,15	.754	2,22	.088	4,90	.193	9,60	.378	0,80	.031	0,04	.002									6862947	

## Application Example

Modification Instructions for Use of Larger Radii Inserts  
(Shoulder Mills and Helical Mills)

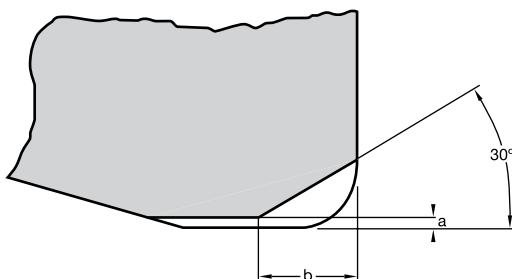

insert corner radius	material to remove	
	a	b
0.122"	0.008"	0.071"

VSM17™ • XDPT-MM

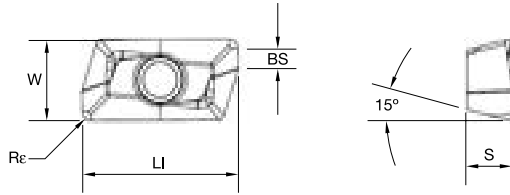

● first choice  
○ alternate choice

P	■	■	■	■	●	●	●	●	●	●	●	●	●
M	■	■	■	■	●	●	●	●	●	●	●	●	●
K	■	■	■	■	●	●	●	●	●	●	●	●	●
N	■	■	■	■	●	●	●	●	●	●	●	●	●
S	■	■	■	■	●	●	●	●	●	●	●	●	●
H	■	■	■	■	●	●	●	●	●	●	●	●	●

ISO catalog number	ANSI catalog number	cutting edges	LI		BS		S		W		Re		hm		WK15CM	WK15PM	WN10HM	WN25PM	WP25PM	WP35CM	WP40PM	WS40PM	WU20PM	WU35PM	
			mm	in	mm	in	mm	in	mm	in	mm	in	mm	in											mm
XDPT170404PESRMM	XDPT1701SRMM	2	19,15	.754	2,52	.099	4,90	.193	9,60	.378	0,40	.016	0,10	.004	■	■	■	■	■	■	■	■	■	■	■
XDPT170408PESRMM	XDPT1702SRMM	2	19,15	.754	2,15	.085	4,90	.193	9,60	.378	0,80	.031	0,10	.004	■	■	■	■	■	■	■	■	■	■	■
XDPT170412PESRMM	XDPT1703SRMM	2	19,16	.754	1,77	.070	4,90	.193	9,60	.378	1,20	.047	0,10	.004	■	■	■	■	■	■	■	■	■	■	■
XDPT170416PESRMM	XDPT1704SRMM	2	19,17	.755	1,38	.054	4,90	.193	9,60	.378	1,60	.063	0,10	.004	■	■	■	■	■	■	■	■	■	■	■
XDPT170420PESRMM	XDPT1705SRMM	2	19,17	.755	0,99	.039	4,90	.193	9,60	.378	2,00	.079	0,10	.004	■	■	■	■	■	■	■	■	■	■	■
XDPT170424PESRMM	XDPT1706SRMM	2	19,17	.755	0,62	.024	4,90	.193	9,60	.378	2,40	.094	0,10	.004	■	■	■	■	■	■	■	■	■	■	■
XDPT170432PESRMM	XDPT1708SRMM	2	18,85	.742	—	—	4,89	.192	9,59	.378	3,20	.125	0,10	.004	■	■	■	■	■	■	■	■	■	■	■
XDPT170440PESRMM	XDPT1710SRMM	2	18,33	.722	—	—	4,87	.192	9,59	.377	4,00	.157	0,10	.004	■	■	■	■	■	■	■	■	■	■	■

INDEXABLE MILLING

SOLID END MILLING

HOLEMAKING

TAPPING

TURNING

## VSM17™ • XDPT-MH

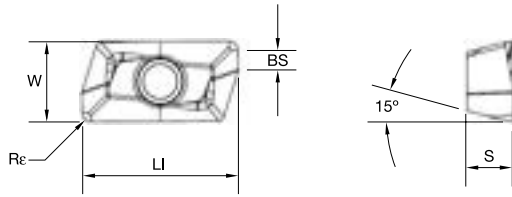

● first choice  
○ alternate choice

P	■	■	■	■	●	●	●	●	●	●	●	●	●
M	■	■	■	■	●	●	●	●	●	●	●	●	●
K	■	■	■	■	●	●	●	●	○	○	○	○	○
N	■	■	■	■	●	●	●	●	○	○	○	○	○
S	■	■	■	■	●	●	●	●	○	○	○	○	○
H	■	■	■	■	●	●	●	●	○	○	○	○	○

ISO catalog number	ANSI catalog number	cutting edges	LI		BS		S		W		Re		hm		WK15CM	WK15PM	WN10HM	WN25PM	WP25PM	WP35CM	WP40PM	WS40PM	WU20PM	WU35PM	
			mm	in	mm	in	mm	in	mm	in	mm	in	mm	in											mm
XDPT170408PESRMH	XDPT1702SRMH	2	19,15	.754	2,10	.083	4,91	.193	9,60	.378	0,80	.031	0,13	.005	5989053	■	■	■	■	■	■	■	■	■	■
XDPT170412PESRMH	XDPT1703SRMH	2	19,16	.754	1,73	.068	4,91	.193	9,60	.378	1,20	.047	0,13	.005	5991817	■	■	■	■	■	5989054	5989052	6425148	■	■

## VSM17 • XDPT-MU

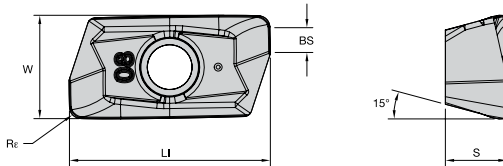

● first choice  
○ alternate choice

P	■	■	■	■	●	●	●	●	●	●	●	●	●
M	■	■	■	■	●	●	●	●	○	○	○	○	○
K	■	■	■	■	●	●	●	●	○	○	○	○	○
N	■	■	■	■	●	●	●	●	○	○	○	○	○
S	■	■	■	■	●	●	●	●	○	○	○	○	○
H	■	■	■	■	●	●	●	●	○	○	○	○	○

ISO catalog number	ANSI catalog number	cutting edges	LI		BS		S		W		Re		hm		WK15CM	WK15PM	WN10HM	WN25PM	WP25PM	WP35CM	WP40PM	WS40PM	WU20PM	WU35PM
			mm	in	mm	in	mm	in	mm	in	mm	in	mm	in										
XDPT170408PESRMU	XDPT1702SRMU	2	19,15	.754	2,15	.085	4,90	.193	9,60	.378	0,80	.031	0,05	.002	■	■	■	■	■	■	■	■	■	■

VSM17™ • Insert Selection Guide

Material Group	Light Machining		General Purpose		Universal		Heavy Machining	
	Geometry	Grade	Geometry	Grade	Geometry	Grade	Geometry	Grade
P1-P2	XDCT-ML	WP40PM	XDPT-MM	WP40PM	XD.-MU	WU20PM	XDPT-MH	WP40PM
P3-P4	XDCT-ML	WP40PM	XDPT-MM	WP40PM	XD.-MU	WU20PM	XDPT-MH	WP40PM
P5-P6	XDPT-MM	WP25PM	XDPT-MM	WP35CM	XD.-MU	WU20PM	XDPT-MH	WP40PM
M1-M2	XDCT-ML	WS40PM	XDPT-MM	WS40PM	XD.-MU	WU20PM	XDPT-MM	WS40PM
M3	XDCT-ML	WS40PM	XDPT-MM	WS40PM	XD.-MU	WU20PM	XDPT-MH	WS40PM
K1-K2	XDPT-MM	WK15CM	XDPT-MM	WK15CM	XD.-MU	WU20PM	XDPT-MH	WK15CM
K3	XDPT-MM	WP35CM	XDPT-MM	WP35CM	XD.-MU	WU20PM	XDPT-MH	WP35CM
N1-N2	XDCT-ALP	WN10HM	XDCT-ALP	WN25PM	-	-	XDCT-ALP	WN25PM
N3	XDCT-ALP	WN10HM	XDCT-ALP	WN25PM	-	-	XDCT-ALP	WN25PM
S1-S2	XDCT-ML	WP25PM	XDPT-MM	WS40PM	XD.-MU	WU20PM	XDPT-MM	WS40PM
S3	XDCT-ML	WS40PM	XDPT-MM	WS40PM	XD.-MU	WU20PM	XDPT-MM	WS40PM
S4	XDCT-ML	WS40PM	XDPT-MM	WS40PM	XD.-MU	WU20PM	XDPT-MM	WS40PM
H1	-	-	-	-	XD.-MU	WU20PM	-	-

NOTE: Use XDCT/XDET for precision.

VSM17 • Recommended Starting Speeds [SFM]

Material Group	WK15CM	WK15PM	WN10HM	WN25PM	WP25PM	WP35CM	WP40PM	WS40PM	WU20PM	WU35PM
P	1	-	-	-	1085 935 885	1495 1295 1215	970 855 805	-	1080 950 885	855 755 705
	2	-	-	-	900 785 655	920 835 755	820 705 590	-	900 820 655	720 625 525
	3	-	-	-	835 705 575	835 755 675	755 640 525	-	835 720 570	655 560 460
	4	-	-	-	740 605 490	625 575 525	675 560 445	-	735 620 490	590 490 395
	5	-	-	-	605 560 490	855 755 690	560 510 445	560 475 395	605 570 490	490 445 395
	6	-	-	-	540 410 330	525 445 360	490 375 295	490 360 260	540 425 325	425 330 260
M	1	-	-	-	675 590 540	675 605 510	640 560 510	690 560 460	670 590 540	560 490 445
	2	-	-	-	605 525 425	605 525 460	575 490 410	590 475 395	605 520 425	510 425 360
	3	-	-	-	460 395 310	475 425 375	425 375 295	475 360 280	455 390 310	375 330 260
K	1	1380 1265 1115	885 805 705	-	755 675 605	970 870 785	-	-	820 720 605	-
	2	1100 970 900	690 625 575	-	590 525 490	770 690 625	-	-	655 590 490	-
	3	920 820 755	575 525 475	-	490 445 395	640 575 525	-	-	590 490 390	-
N	1	-	2605 2275 1965	3525 3100 2870	-	-	-	-	1800 1540 1310	-
	2	-	2605 2275 1965	3100 2870 2495	-	-	-	-	1800 1540 1310	-
	3	-	1835 1590 1375	3100 2870 2495	-	-	-	-	1310 1145 980	-
S	1	-	-	-	130 115 80	-	-	130 115 80	130 110 80	115 100 80
	2	-	-	-	130 115 80	-	-	130 115 80	130 110 80	115 100 80
	3	-	-	-	165 130 80	-	-	165 130 80	160 130 80	150 115 80
	4	-	-	-	230 165 115	-	-	195 165 100	225 160 110	195 150 100
H	1	-	-	-	395 295 230	-	-	-	360 260 225	-

NOTE: FIRST choice starting speeds are in bold type.

As the average chip thickness increases, the speed should be decreased.

\*Material groups P, M, K, and H show recommended starting speeds for dry machining. For wet machining, reduce speed by 20%.

\*Material groups N and S show recommended starting speeds for wet machining. Not recommended for dry machining.

VSM17 • Recommended Starting Feeds [IPT]

Light Machining	General Purpose	Heavy Machining
-----------------	-----------------	-----------------

Insert Geometry	Programmed Feed per Tooth (fz) as a % of Radial Depth of Cut (ae)														Insert Geometry	
	5%			10%			20%			30%			40-100%			
.F..ALP	.005	<b>.009</b>	.016	.003	<b>.007</b>	.012	.003	<b>.005</b>	.009	.002	<b>.004</b>	.008	.002	<b>.004</b>	.007	.F..ALP
.E..ML	.007	<b>.014</b>	.019	.005	<b>.010</b>	.013	.004	<b>.008</b>	.010	.003	<b>.007</b>	.009	.003	<b>.006</b>	.008	.E..ML
.S..MM/.S..MU	.007	<b>.016</b>	.026	.005	<b>.012</b>	.018	.004	<b>.009</b>	.014	.003	<b>.008</b>	.012	.003	<b>.007</b>	.011	.S..MM/.S..MU
.S..MH	.009	<b>.019</b>	.030	.007	<b>.013</b>	.021	.005	<b>.010</b>	.016	.004	<b>.009</b>	.014	.004	<b>.008</b>	.013	.S..MH

NOTE: Use "Light Machining" value as starting feed rate.

# VSM Single-Sided Series

## VSM22 Shoulder Mill

The VSM22 shoulder mill will continuously face large-walled, big components in stainless steel, cast iron, and steel using high depth of cuts while providing free chip flow for a clean workpiece.

.787" (20mm) long insert cutting edge length, .25" (6,35mm) thick.

Precision ground insert with a positive rake and helical cutting edge to enable smooth cutting action, even in unstable conditions.

.084" (2,14mm) wiper facet for accurate indexing.

Through-coolant cutter body.

Cutters with a chip gash for free chip flow and clean workpiece.



The VSM22 shoulder mill is built for heavy-duty machining equipped with precision ground inserts featuring .787" (20mm) long cutting edges to face big components with high DOCs.

Two insert geometries are available for heavy roughing or general-purpose applications.

### TWO INSERTS, EACH AVAILABLE IN THREE GRADES

-MH



-MM



#### WK15CM



WK15CM is a wear-resistant grade with balanced toughness for general milling of cast irons. Best results in dry machining, but can also be used wet.

#### WP35CM



WP35CM has a wide range of applications in general and rough milling of steels and cast iron. Performs best in dry, but can also be used under wet conditions.

#### WU20PM



WU20PM is a universal grade for machining of steel, stainless steel, and high-temperature alloys. Also suitable for machining of gray and nodular irons. Resists breakage and offers improved wear resistance and increased strength. Can be used for both dry and wet machining.

# RELIABILITY, WHEN IT MATTERS MOST

## PRODUCT

### SERIES

VSM22

### DIAMETER RANGE

3-6" (50-125mm)

## SHANK TYPES

Shell Mills

## INDUSTRY



## APPLICATIONS



FACE MILLING



PLUNGE MILLING



POCKETING



RAMPING



SIDE MILLING/  
SHOULDER MILLING:  
SQUARE END



SLOTTING:  
SQUARE END



POCKET MILLING



SLOTTING SIDE

## HEAVY DUTY

.25" (6,35mm) thick -MH insert for heavy roughing.

## HIGH DEPTH OF CUT

Insert with .787" (20mm) long cutting edge coupled with large chip gash to achieve high DOC.



## VSM22 • 0° • Shell Mills • Inch

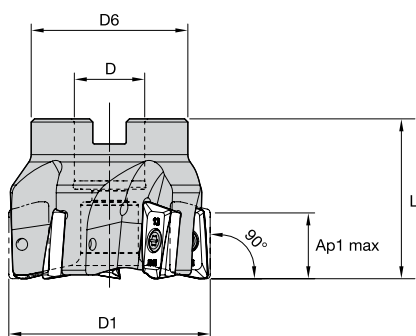

order number	catalog number	D1	D	D6	L	Ap1 max	Z	max RPM	coolant supply	lbs
6921226	VSM22U300Z06S100XP22	3.000	1.000	2.750	1.750	.787	6	—	Yes	1.77
6921227	VSM22U400Z08S150XP22	4.000	1.250	2.875	2.000	.787	8	—	Yes	3.09
6921228	VSM22U600Z10S200XP22	6.000	2.000	4.875	2.380	.787	10	6800	Yes	9.17

FOR SPARE PARTS, PLEASE VISIT [WIDIA.COM](http://WIDIA.COM) OR [WIDIANOVO.COM](http://WIDIANOVO.COM).  
MOUNTING SCREWS ARE NOT INCLUDED IN STANDARD PACKAGING.

## VSM22 • XPHT-MM

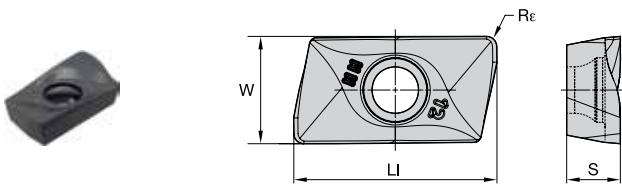

- first choice
- alternate choice

P	■	■	●	●
M	■	■	●	●
K	■	●	○	○
N	■	■	○	○
S	■	■	○	○
H	■	■	○	○

ISO catalog number	ANSI catalog number	cutting edges	LI		S		W		Rε		hm		WK15CM 6870184	WP35CM 6852415	WU20PM 2567049
			mm	in	mm	in	mm	in	mm	in	mm	in			
XPHT220612PDSRMM	XPHT220612PDSRMM	2	22,55	.888	6,35	.250	12,70	.500	1,20	.047	0,23	.009			
XPHT220612PDSRMM	XPHT220612PDSRMM	2	22,55	.888	6,35	.250	12,70	.500	1,20	.047	0,05	.002			

## VSM22 • XPHT-MH

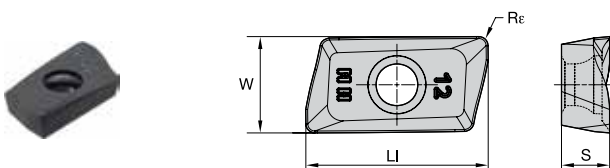

- first choice
- alternate choice

P	■	■	●	●
M	■	■	●	●
K	■	●	○	○
N	■	■	○	○
S	■	■	○	○
H	■	■	○	○

ISO catalog number	ANSI catalog number	cutting edges	LI		S		W		Rε		hm		WK15CM 6094886	WP35CM 6852416	WU20PM 3789524
			mm	in	mm	in	mm	in	mm	in	mm	in			
XPHT220612PDSRMH	XPHT220612PDSRMH	2	22,55	.888	6,35	.250	12,70	.500	1,20	.047	0,23	.009			



VSM22 • Insert Selection Guide

Material Group	Light Machining		General Purpose		Heavy Machining	
	Geometry	Grade	Geometry	Grade	Geometry	Grade
P1-P2	.S..MM	WP35CM	.S..MH	WU20PM	.S..MH	WP35CM
P3-P4	.S..MM	WP35CM	.S..MH	WP35CM	.S..MH	WP35CM
P5-P6	.S..MM	WP35CM	.S..MH	WP35CM	.S..MH	WP35CM
M1-M2	.S..MH	WU20PM	.S..MH	WU20PM	.S..MH	WU20PM
M3	.S..MM	WP35CM	.S..MH	WP35CM	.S..MH	WP35CM
K1-K2	.S..MM	WK15CM	.S..MM	WK15CM	.S..MH	WK15CM
K3	.S..MM	WK15CM	.S..MM	WK15CM	.S..MH	WU20PM
N1-N2	.S..MH	WU20PM	.S..MH	WU20PM	.S..MH	WU20PM
N3	.S..MH	WU20PM	.S..MH	WU20PM	.S..MH	WU20PM
S1-S2	.S..MH	WU20PM	.S..MH	WU20PM	.S..MH	WU20PM
S3	.S..MH	WU20PM	.S..MH	WU20PM	.S..MH	WU20PM
S4	.S..MM	WP35CM	.S..MM	WP35CM	.S..MH	WP35CM
H1	.S..MH	WU20PM	.S..MH	WU20PM	-	-

VSM22 • Recommended Starting Speeds [SFM]

Material Group		WK15CM			WU20PM			WP35CM		
P	1	—	—	—	1080	950	885	1490	1295	1215
	2	—	—	—	900	820	655	920	835	755
	3	—	—	—	835	720	570	835	755	670
	4	—	—	—	735	620	490	625	575	525
	5	—	—	—	605	570	490	855	755	690
	6	—	—	—	540	425	325	525	445	—
M	1	—	—	—	670	590	540	670	605	510
	2	—	—	—	605	520	425	605	525	460
	3	—	—	—	455	390	310	475	425	375
K	1	1380	1265	1115	820	720	605	970	870	785
	2	1100	970	900	655	590	490	770	690	625
	3	920	820	755	590	490	390	640	575	525
N	1	—	—	—	1800	1540	1310	—	—	—
	2	—	—	—	1800	1540	1310	—	—	—
	3	—	—	—	1310	1145	980	—	—	—
S	1	—	—	—	130	110	80	—	—	—
	2	—	—	—	130	110	80	—	—	—
	3	—	—	—	160	130	80	—	—	—
	4	—	—	—	225	160	110	215	165	110
H	1	—	—	—	360	260	225	—	—	—
	2	—	—	—	—	—	—	—	—	—
	3	—	—	—	—	—	—	—	—	—

NOTE: FIRST choice starting speeds are in **bold** type.  
As the average chip thickness increases, the speed should be decreased.

VSM22 • Recommended Starting Feeds [IPT]

Light Machining	General Purpose	Heavy Machining
-----------------	-----------------	-----------------

Insert Geometry	Programmed Feed per Tooth (fz) as a % of Radial Depth of Cut (ae)															Insert Geometry
	5%			10%			20%			30%			40-100%			
.S..MM	.009	<b>.022</b>	.036	.007	<b>.016</b>	.026	.005	<b>.012</b>	.019	.004	<b>.010</b>	.017	.004	<b>.009</b>	.015	.S..MM
.S..MH	.009	<b>.023</b>	.037	.007	<b>.017</b>	.027	.005	<b>.013</b>	.020	.004	<b>.011</b>	.017	.004	<b>.010</b>	.016	.S..MH

NOTE: Use "Light Machining" value as starting feed rate.  
For new applications, starting at a lighter feed rate is recommended.  
% = ae/Dc X 100 (ae = radial depth of cut, Dc = cutting diameter)

Find the offering of slotting mills at [widia.com](http://widia.com)



## M16 T-SLOTTING

Designed for maximum chip evacuation and optimum security, the M16 slot mill series is an excellent choice for T-slot milling of steel and cast-iron materials.

### APPLICATIONS

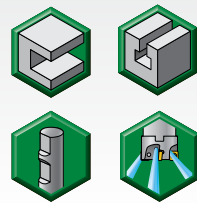

## M94 PRECISE SLOTTING AND GROOVING

Designed for the most demanding small width slotting and grooving operations, the M94 slot mill series is an excellent choice for thin slotting and grooving of steel, stainless steel and cast-iron materials.

### APPLICATIONS

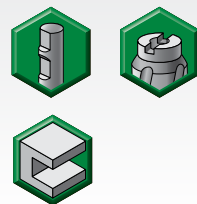

## M95 SQUARE STYLE INSERT SLOTTING

The M95 slotting cutter is designed for deeper applications that require the cutting load to be shared from one insert to the other. Use in steel, stainless steel and cast-iron materials.

### APPLICATIONS

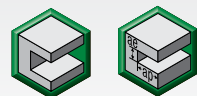

## M900 ADJUSTABLE SLOTTING

The M900 slotting cutter is a multipurpose slotting cutter with high-precision capabilities in numerous operations. Use on steel, stainless steel, cast iron and superalloys.

### APPLICATIONS

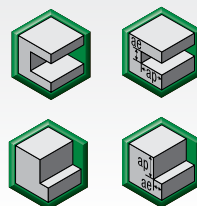

# VSM Series

## VSM490-10™, VSM490-15™ Shoulder Mills

The VSM Series is a four-edged, double-sided roughing shoulder mill with embedded finishing capabilities known for producing a smooth wall finish in axial step-down jobs.



**VSM490-10**  
Ap1 max = .394", 10mm  
Taper 40 spindles



**VSM490-15**  
Ap1 max = .591", 15mm  
Taper 50 spindles

### FOUR INSERT GEOMETRIES FOR ALL MATERIAL GROUPS IN SHOULDER MILLING APPLICATIONS

★ -ALP



**N**

For non-ferrous materials.

★ -ML



**P M K S H**

First choice for stainless steel, light machining, and finishing jobs.

★ -MM



**P M K S H**

First choice for general purpose in all material groups.

★ -MH



**P K**

First choice for HPC roughing cast iron. Strongest edge protection with additional margins.

Finishing Capabilities/Lower Cutting Forces

Geometry Strengthening

# FOUR-EDGED SHOULDER MILL

PRODUCT		INSERTS		
SERIES	DIAMETER RANGE	INSERT TYPE	GRADE	MATERIALS
<b>VSM490-10™</b>	Screw-On End Mills: — (16–32mm) Cylindrical End Mills: .62–1" (16–25mm) Shell Mills: 1.50–5" (40–125mm) Weldon® End Mills: .62–1" (16–25mm)	ALP, ML, MM, MH	WP40PM, WS40PM, WP25PM, WU10PM	<b>P M K S H</b>
<b>VSM490-15™</b>	Weldon End Mills: .625–1.5" (16–32mm) Cylindrical End Mills: .625–1.5" (16–32mm) Shell Mills: 1.5–5" (40–125mm)	ALP, ML, MM, MH	WS40PM, WP25PM, WP40PM	<b>P M S</b>

## APPLICATIONS



FACE MILLING



EASED  
CHAMFER



SIDE MILLING/  
SHOULDER  
MILLING:  
SQUARE END



SLOTTING:  
SQUARE END



POCKETING



SIDE MILLING/  
SHOULDER  
MILLING:  
BOTTOM  
SHOULDERING

## INDUSTRY



TRANSPORTATION



AEROSPACE



ENERGY



GENERAL  
ENGINEERING

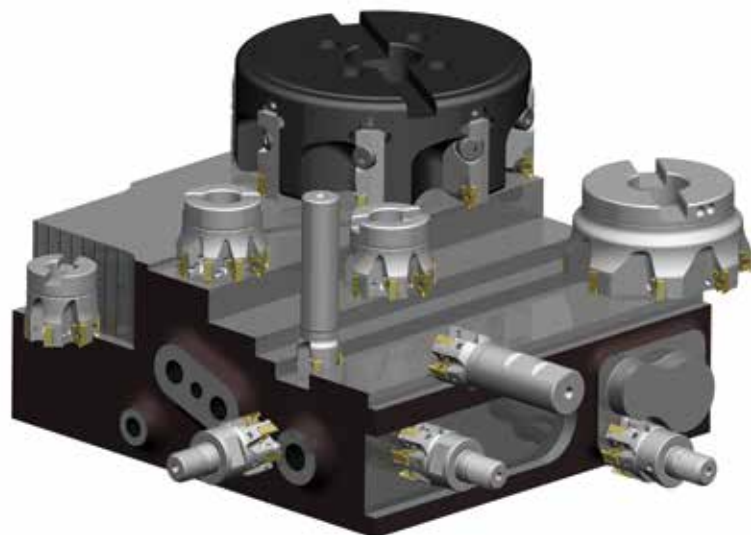

VSM490-10 • Weldon® End Mills • Inch

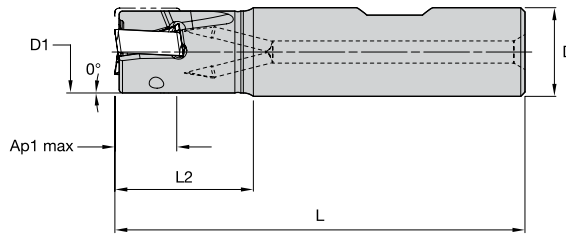

Regular Shank

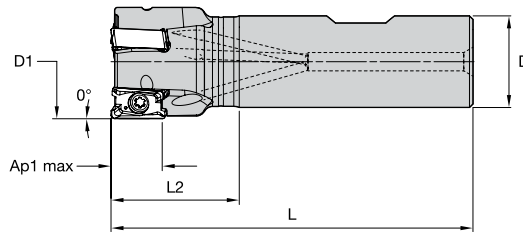

Reduced Shank

order number	catalog number	D1	D	L	L2	Ap1 max	Z	max RPM	coolant supply	lbs
6425459	VSM490D062Z02W062XN10	.625	.625	2.750	.844	.394	2	48000	Yes	.20
6425460	VSM490D075Z02W075XN10	.750	.750	3.250	1.220	.394	2	41700	Yes	.34
6425471	VSM490D075Z03W075XN10	.750	.750	3.250	1.220	.394	3	41700	Yes	.33
6425472	VSM490D100Z03W075XN10	1.000	.750	3.250	1.220	.394	3	33900	Yes	.39
6425473	VSM490D100Z03W100XN10	1.000	1.000	3.750	1.470	.394	3	33900	Yes	.71
6425474	VSM490D100Z04W100XN10	1.000	1.000	3.750	1.470	.394	4	33900	Yes	.71
6425475	VSM490D125Z04W075XN10	1.250	.750	3.250	1.220	.394	4	29200	Yes	.46
6425476	VSM490D125Z04W100XN10	1.250	1.000	3.750	1.470	.394	4	29200	Yes	.79
6425477	VSM490D125Z04W125XN10	1.250	1.250	4.000	1.720	.394	4	29200	Yes	1.20
6425478	VSM490D125Z05W125XN10	1.250	1.250	4.000	1.720	.394	5	29200	Yes	1.20
6425479	VSM490D150Z05W125XN10	1.500	1.250	4.500	2.220	.394	5	26200	Yes	1.48

NOTE: Weldon type not recommended for finishing operations.

VSM490-10 • Cylindrical End Mills (regular and long version) • Inch

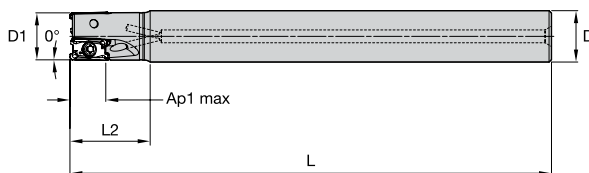
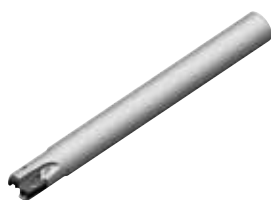

Regular Shank

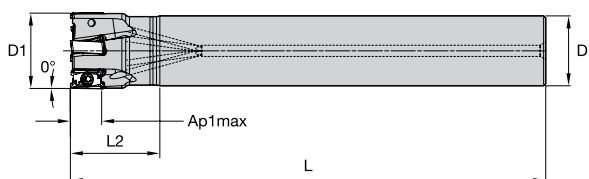

Reduced Shank

order number	catalog number	D1	D	L	L2	Ap1 max	Z	max RPM	coolant supply	lbs
6425419	VSM490D062Z02C062XN10L360	.625	.625	3.600	.850	.394	2	48000	Yes	.27
6425420	VSM490D062Z02C062XN10L600	.625	.625	6.000	1.000	.394	2	48000	Yes	.47
6425442	VSM490D075Z02C075XN10L600	.750	.750	6.000	1.250	.394	2	41700	Yes	.67
6425441	VSM490D075Z03C075XN10L360	.750	.750	3.600	.900	.394	3	41700	Yes	.38
6425443	VSM490D075Z03C075XN10L600	.750	.750	6.000	1.250	.394	3	41700	Yes	.66
6425444	VSM490D100Z03C075XN10L400	1.000	.750	4.000	1.250	.394	3	33900	Yes	.49
6425446	VSM490D100Z03C100XN10L670	1.000	1.000	6.700	1.600	.394	3	33900	Yes	1.36
6425445	VSM490D100Z04C100XN10L400	1.000	1.000	4.000	1.250	.394	4	33900	Yes	.78
6425448	VSM490D100Z04C100XN10L670	1.000	1.000	6.700	1.600	.394	4	33900	Yes	1.35
6425450	VSM490D125Z04C075XN10L430	1.250	.750	4.300	1.600	.394	4	29200	Yes	.62
6425452	VSM490D125Z04C100XN10L430	1.250	1.000	4.300	1.600	.394	4	29200	Yes	.92
6425454	VSM490D125Z05C100XN10L430	1.250	1.000	4.300	1.600	.394	5	29200	Yes	.92
6425455	VSM490D125Z04C125XN10L800	1.250	1.250	8.000	1.900	.394	4	29200	Yes	2.58
6425456	VSM490D125Z05C125XN10L800	1.250	1.250	8.000	1.900	.394	5	29200	Yes	2.58
6425457	VSM490D150Z05C125XN10L800	1.500	1.250	8.000	2.000	.394	5	26200	Yes	2.69

FOR SPARE PARTS, PLEASE VISIT [WIDIA.COM](http://WIDIA.COM) OR [WIDIANOVO.COM](http://WIDIANOVO.COM).  
MOUNTING SCREWS ARE NOT INCLUDED IN STANDARD PACKAGING.

## VSM490-10 • Shell Mills • Inch

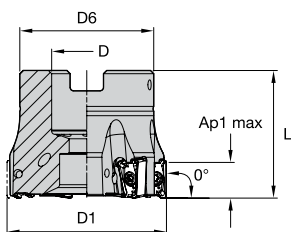

order number	catalog number	D1	D	D6	L	Ap1 max	Z	max RPM	coolant supply	lbs
6425383	VSM490D150Z04S075XN10	1.500	.750	1.421	1.577	.394	4	26200	Yes	.44
6425384	VSM490D150Z06S075XN10	1.500	.750	1.421	1.577	.394	6	26200	Yes	.44
6425385	VSM490D150Z07S075XN10	1.500	.750	1.421	1.577	.394	7	26200	Yes	.42
6425386	VSM490D200Z05S075XN10	2.000	.750	1.750	1.577	.394	5	22100	Yes	.81
6425387	VSM490D200Z07S075XN10	2.000	.750	1.750	1.577	.394	7	22100	Yes	.81
6425388	VSM490D200Z09S075XN10	2.000	.750	1.750	1.577	.394	9	22100	Yes	.83
6425389	VSM490D250Z05S075XN10	2.500	.750	1.928	1.577	.394	5	22100	Yes	1.25
6425390	VSM490D250Z07S075XN10	2.500	.750	1.928	1.577	.394	7	22100	Yes	1.22
6425401	VSM490D250Z09S075XN10	2.500	.750	1.928	1.577	.394	9	22100	Yes	1.24
6425402	VSM490D300Z06S100XN10	3.000	1.000	2.190	1.750	.394	6	17600	Yes	2.06
6425403	VSM490D300Z08S100XN10	3.000	1.000	2.190	1.750	.394	8	17600	Yes	2.03
6425404	VSM490D300Z10S100XN10	3.000	1.000	2.190	1.750	.394	10	17600	Yes	2.05
6425405	VSM490D400Z08S150XN10	4.000	1.500	3.380	2.000	.394	8	15000	Yes	3.40
6425406	VSM490D400Z12S150XN10	4.000	1.500	3.380	2.000	.394	12	15000	Yes	3.37
6425407	VSM490D500Z10S150XN10	5.000	1.500	3.907	2.380	.394	10	13400	Yes	7.21
6425408	VSM490D500Z14S150XN10	5.000	1.500	3.907	2.380	.394	14	13400	Yes	7.19

FOR SPARE PARTS, PLEASE VISIT [WIDIA.COM](http://WIDIA.COM) OR [WIDIANOVO.COM](http://WIDIANOVO.COM).

MOUNTING SCREWS ARE NOT INCLUDED IN STANDARD PACKAGING.

VSM490-10 • XNGU-ML • Precision Finishing and Light Machining

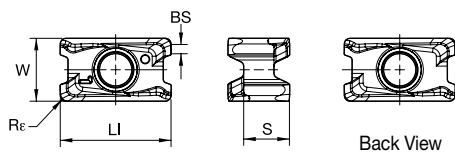

- first choice
- alternate choice

P	■	■	■	●	●	●	●
M	■	■	■	●	●	●	●
K	■	●	●	○	○	○	●
N	■	■	■	●	●	○	○
S	■	■	■	○	○	○	○
H	■	■	■	○	○	○	●

ISO catalog number	ANSI catalog number	cutting edges	LI		S		W		BS		Rε		hm		WK15CM	WK15PM	WN25PM	WP25PM	WP35CM	WP40PM	WS40PM	WU10PM
			mm	in	mm	in	mm	in	mm	in	mm	in	mm	in								
XNGU100404ERML	XNGU1001ERML	4	11,66	.459	4,83	.190	6,60	.260	1,37	.054	0,40	.016	0,02	.001	■	■	■	■	■	■	■	■
XNGU100408ERML	XNGU1002ERML	4	11,66	.459	4,83	.190	6,60	.260	1,00	.039	0,80	.031	0,02	.001	■	■	■	○	○	○	○	○

VSM490-10 • XNPU-ML • Light Machining

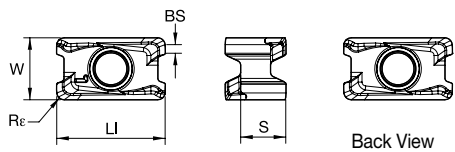

- first choice
- alternate choice

P	■	■	■	●	●	●	●
M	■	■	■	●	●	●	●
K	■	●	●	○	○	○	●
N	■	■	■	●	●	○	○
S	■	■	■	○	○	○	○
H	■	■	■	○	○	○	●

ISO catalog number	ANSI catalog number	cutting edges	LI		S		W		BS		Rε		hm		WK15CM	WK15PM	WN25PM	WP25PM	WP35CM	WP40PM	WS40PM	WU10PM
			mm	in	mm	in	mm	in	mm	in	mm	in	mm	in								
XNPU100408ERML	XNPU1002ERML	4	11,60	.457	4,83	.190	6,60	.260	0,90	.036	0,80	.031	0,02	.001	■	○	○	○	○	○	○	○



VSM490-10 • XNGU-MM • Universal Geometry for Medium Machining

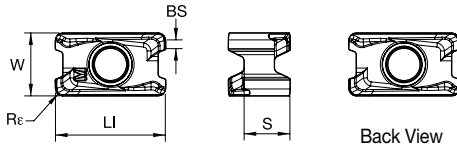

- first choice
- alternate choice

P	■	■	■	●	●	●	●
M	■	■	■	●	●	●	●
K	■	●	●	○	○	○	●
N	■	■	■	●	●	○	○
S	■	■	■	○	○	○	○
H	■	■	■	○	○	○	●

ISO catalog number	ANSI catalog number	cutting edges	LI		S		W		BS		Re		hm		WK15CM	WK15PM	WN25PM	WP25PM	WP35CM	WP40PM	WS40PM	WU10PM
			mm	in	mm	in	mm	in	mm	in	mm	in	mm	in								
XNGU100404SRMM	XNGU1001SRMM	4	11,66	.459	4,83	.190	6,60	.260	1,37	.054	0,40	.016	0,08	.003	■	■	■	■	■	■	■	■
XNGU100408SRMM	XNGU1002SRMM	4	11,66	.459	4,83	.190	6,60	.260	1,00	.039	0,80	.031	0,08	.003	■	■	■	○	○	○	○	○

VSM490-10 • XNPU-MM • Universal Geometry for Medium Machining

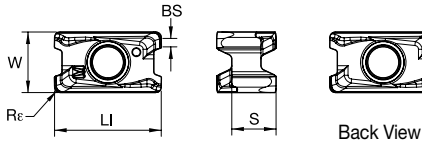

- first choice
- alternate choice

P	■	■	■	●	●	●	●
M	■	■	■	●	●	●	●
K	■	●	●	○	○	○	●
N	■	■	■	●	●	○	○
S	■	■	■	○	○	○	○
H	■	■	■	○	○	○	●

ISO catalog number	ANSI catalog number	cutting edges	LI		S		W		BS		Re		hm		WK15CM	WK15PM	WN25PM	WP25PM	WP35CM	WP40PM	WS40PM	WU10PM
			mm	in	mm	in	mm	in	mm	in	mm	in	mm	in								
XNPU100408SRMM	XNPU1002SRMM	4	11,60	.457	4,83	.190	6,60	.260	0,90	.036	0,80	.031	0,08	.003	○	○	○	○	○	○	○	○
XNPU100412SRMM	XNPU1003SRMM	4	11,61	.457	4,83	.190	6,60	.260	0,50	.022	1,20	.047	0,08	.003	○	○	○	○	○	○	○	○
XNPU100416SRMM	XNPU1004SRMM	4	11,61	.457	4,83	.190	6,60	.260	0,10	.002	1,60	.062	0,08	.003	■	■	■	○	○	○	○	○

VSM490-10 • XNGU-MH • Heavy Roughing

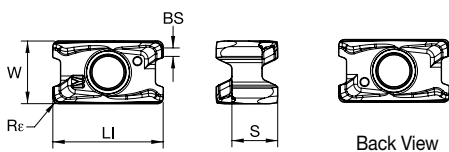

● first choice

○ alternate choice

P	■	■	■	●	●	●	●
M	■	■	■	●	●	●	●
K	■	●	●	○	○	○	●
N	■	■	■	●	○	○	○
S	■	■	■	●	○	○	●
H	■	■	■	○	○	○	●

ISO catalog number	ANSI catalog number	cutting edges	LI		S		W		BS		Re		hm		WK15CM	WK15PM	WN25PM	WP25PM	WP35CM	WP40PM	WS40PM	WU10PM	
			mm	in	mm	in	mm	in	mm	in	mm	in	mm	in									
XNGU100408SRMH	XNGU1002SRMH	4	11,66	.459	4,83	.190	6,60	.260	0,90	.036	0,80	.032	0,08	.003	6425359	■	■	■	■	■	■	■	■

VSM490-10 • XNGU-ALP • For Aluminum and Other Non-Ferrous Alloys

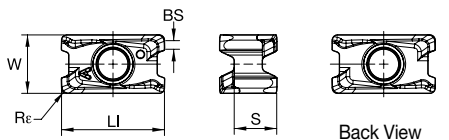

● first choice

○ alternate choice

P	■	■	■	●	●	●	●
M	■	■	■	●	●	●	●
K	■	●	●	○	○	○	●
N	■	■	■	●	○	○	○
S	■	■	■	●	○	○	●
H	■	■	■	○	○	○	●

ISO catalog number	ANSI catalog number	cutting edges	LI		S		W		BS		Re		hm		WK15CM	WK15PM	WN25PM	WP25PM	WP35CM	WP40PM	WS40PM	WU10PM	
			mm	in	mm	in	mm	in	mm	in	mm	in	mm	in									
XNGU100404ERALP	XNGU1001ERALP	4	11,66	.459	4,83	.190	6,60	.260	1,37	.054	0,40	.016	0,02	.001	■	■	6425382	■	■	■	■	■	■
XNGU100408ERALP	XNGU1002ERALP	4	11,66	.459	4,83	.190	6,60	.260	1,00	.039	0,80	.031	0,02	.001	■	■	6425411	■	■	■	■	■	■

VSM490™ -10 • Insert Selection Guide

Material Group	Light Machining		General Purpose		Heavy Machining	
	Geometry	Grade	Geometry	Grade	Geometry	Grade
P1-P2	XNGU-ML	WP40PM	XNPU-MM	WP40PM	XNPU-MM	WP40PM
P3-P4	XNGU-ML	WP40PM	XNPU-MM	WP40PM	XNPU-MM	WP40PM
P5-P6	XNGU-MM	WP25PM	XNPU-MM	WP35CM	XNPU-MM	WP40PM
M1-M2	XNGU-ML	WS40PM	XNGU-ML	WS40PM	XNPU-MM	WS40PM
M3	XNGU-ML	WS40PM	XNGU-ML	WS40PM	XNPU-MM	WS40PM
K1-K2	XNPU-ML	WK15PM	XNGU-MH	WK15CM	XNGU-MH	WK15CM
K3	XNPU-MM	WK15PM	XNGU-MH	WP35CM	XNGU-MH	WP35CM
N1-N2	XNGU-ALP	WN25PM	XNGU-ALP	WN25PM	XNGU-ALP	WN25PM
N3	XNGU-ALP	WN25PM	XNGU-ALP	WN25PM	XNGU-ALP	WN25PM
S1-S2	XNGU-ML	WP25PM	XNGU-ML	WS40PM	XNPU-MM	WS40PM
S3	XNGU-ML	WS40PM	XNGU-ML	WS40PM	XNPU-MM	WS40PM
S4	XNGU-ML	WS40PM	XNGU-ML	WS40PM	XNPU-MM	WS40PM
H1	XNGU-ML	WU10PM	XNGU-MM	WU10PM	-	-

VSM490-10 • Recommended Starting Speeds [SFM]

Material Group		WK15CM			WK15PM			WN25PM			WP25PM			WP35CM			WP40PM			WS40PM			WU10PM		
		P	1	-	-	-	-	-	-	-	-	-	1085	935	885	1495	1295	1215	970	855	805	-	-	-	-
P	2	-	-	-	-	-	-	-	-	-	900	785	655	920	835	755	820	705	590	-	-	-	-	-	-
P	3	-	-	-	-	-	-	-	-	-	835	705	575	835	755	675	755	640	525	-	-	-	-	-	-
P	4	-	-	-	-	-	-	-	-	-	740	605	490	625	575	525	675	560	445	-	-	-	-	-	-
P	5	-	-	-	-	-	-	-	-	-	605	560	490	855	755	690	560	510	445	560	475	395	-	-	-
P	6	-	-	-	-	-	-	-	-	-	540	410	330	525	445	360	490	375	295	490	360	260	-	-	-
M	1	-	-	-	-	-	-	-	-	-	675	590	540	675	605	510	640	560	510	690	560	460	-	-	-
M	2	-	-	-	-	-	-	-	-	-	605	525	425	605	525	460	575	490	410	590	475	395	-	-	-
M	3	-	-	-	-	-	-	-	-	-	460	395	310	475	425	375	425	375	295	475	360	280	-	-	-
K	1	1380	1265	1115	885	805	705	-	-	-	755	675	605	970	870	785	-	-	-	-	-	-	970	870	785
K	2	1100	970	900	690	625	575	-	-	-	590	525	490	770	690	625	-	-	-	-	-	-	755	675	625
K	3	920	820	755	575	525	475	-	-	-	490	445	395	640	575	525	-	-	-	-	-	-	640	575	525
N	1	-	-	-	-	-	-	3525	3100	2870	-	-	-	-	-	-	-	-	-	-	-	-	-	-	-
N	2	-	-	-	-	-	-	3100	2870	2495	-	-	-	-	-	-	-	-	-	-	-	-	-	-	-
N	3	-	-	-	-	-	-	3100	2870	2495	-	-	-	-	-	-	-	-	-	-	-	-	-	-	-
S	1	-	-	-	-	-	-	-	-	-	130	115	80	-	-	-	130	115	100	130	115	80	-	-	-
S	2	-	-	-	-	-	-	-	-	-	130	115	80	-	-	-	130	115	100	130	115	80	-	-	-
S	3	-	-	-	-	-	-	-	-	-	165	130	80	-	-	-	165	130	100	165	130	80	-	-	-
S	4	-	-	-	-	-	-	-	-	-	230	165	115	-	-	-	215	165	115	195	165	100	-	-	-
H	1	-	-	-	-	-	-	-	-	-	-	-	-	-	-	-	-	-	-	-	-	-	525	425	295

NOTE: FIRST choice starting speeds are in **bold** type.  
 As the average chip thickness increases, the speed should be decreased.  
 \*Material groups P, M, K, and H show recommended starting speeds for dry machining. For wet machining, reduce speed by 20%.  
 \*Material groups N and S show recommended starting speeds for wet machining. Not recommended for dry machining.

VSM490-10 • Recommended Starting Feeds [IPT]

Light Machining	General Purpose	Heavy Machining
-----------------	-----------------	-----------------

Insert Geometry	Programmed Feed per Tooth (fz) as a % of Radial Depth of Cut (ae)															Insert Geometry
	5%			10%			20%			30%			40-100%			
.E..ALP	.005	<b>.009</b>	.013	.003	<b>.007</b>	.009	.003	<b>.005</b>	.007	.002	<b>.004</b>	.006	.002	<b>.004</b>	.006	.E..ALP
.E..ML	.007	<b>.011</b>	.015	.005	<b>.008</b>	.011	.004	<b>.006</b>	.008	.003	<b>.005</b>	.007	.003	<b>.005</b>	.006	.E..ML
.S..MM	.009	<b>.014</b>	.018	.007	<b>.010</b>	.013	.005	<b>.007</b>	.010	.004	<b>.006</b>	.008	.004	<b>.006</b>	.008	.S..MM
.S..MH	.009	<b>.016</b>	.022	.007	<b>.012</b>	.016	.005	<b>.009</b>	.012	.004	<b>.008</b>	.010	.004	<b>.007</b>	.010	.S..MH

NOTE: Use "Light Machining" value as starting feed rate.

VSM490-15 • Weldon® End Mills • Inch

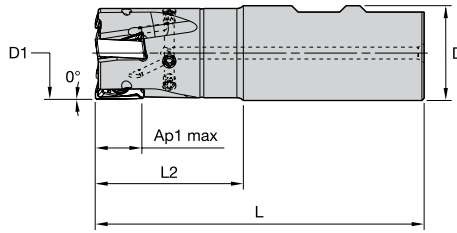

order number	catalog number	D1	D	L	L2	Ap1 max	Z	max RPM	coolant supply	lbs
5873069	VSM490D100Z02W075XN15	1.000	.750	3.780	1.750	.591	2	26300	Yes	.40
5710590	VSM490D100Z02W100XN15	1.000	1.000	4.030	1.750	.591	2	26300	Yes	.70
5710591	VSM490D125Z03W100XN15	1.250	1.000	4.530	2.250	.591	3	22100	Yes	.88
5873070	VSM490D150Z03W125XN15	1.500	1.250	4.530	2.250	.591	3	19500	Yes	1.41
5710592	VSM490D150Z04W125XN15	1.500	1.250	4.530	2.250	.591	4	19500	Yes	1.42

NOTE: Weldon type not recommended for finishing operations.

VSM490-15 • Cylindrical End Mills • Inch

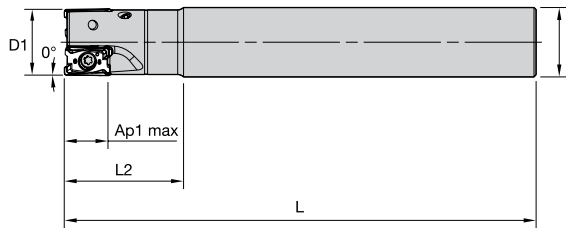

order number	catalog number	D1	D	L	L2	Ap1 max	Z	max RPM	coolant supply	lbs
5873101	VSM490D100Z02C100XN15L800	1.000	1.000	8.000	1.750	.610	2	26300	Yes	1.55
5873102	VSM490D125Z03C125XN15L800	1.250	1.250	8.000	2.250	.591	3	22100	Yes	2.50
5873103	VSM490D150Z04C125XN15L800	1.500	1.250	8.000	2.250	.591	4	19500	Yes	2.56

## VSM490-15 • Shell Mills • Inch

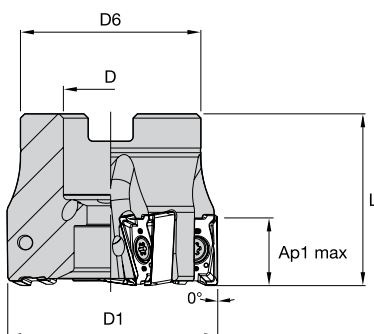

order number	catalog number	D1	D	D6	L	Ap1 max	Z	max RPM	coolant supply	lbs
5710593	VSM490D150Z05S050XN15	1.500	.500	1.420	1.575	.591	5	19500	Yes	.43
5710594	VSM490D200Z05S075XN15	2.000	.750	1.750	1.575	.591	5	16100	Yes	.78
5710595	VSM490D200Z06S075XN15	2.000	.750	1.750	1.575	.591	6	16100	Yes	.77
5873104	VSM490D250Z05S075XN15	2.500	.750	1.750	1.575	.591	5	14100	Yes	1.11
5710596	VSM490D250Z06S075XN15	2.500	.750	1.750	1.575	.591	6	14100	Yes	1.06
5710597	VSM490D250Z07S100XN15	2.500	1.000	2.190	1.750	.591	7	14100	Yes	1.31
5710598	VSM490D300Z07S100XN15	3.000	1.000	2.190	1.750	.591	7	12700	Yes	1.83
5873105	VSM490D300Z09S100XN15	3.000	1.000	2.190	1.750	.610	9	12700	Yes	1.94
5873106	VSM490D400Z08S150XN15	4.000	1.500	3.380	2.000	.591	8	10800	Yes	3.26
5710599	VSM490D400Z11S150XN15	4.000	1.500	3.380	2.000	.591	11	10800	Yes	3.26
5873107	VSM490D500Z09S150XN15	5.000	1.500	3.907	2.380	.591	9	9600	Yes	7.67
5873108	VSM490D500Z12S150XN15	5.000	1.500	3.907	2.380	.591	12	9600	Yes	6.83
5873109	VSM490D600Z10S200XN15	6.000	2.000	4.880	2.380	.591	10	8600	Yes	10.42

FOR SPARE PARTS, PLEASE VISIT [WIDIA.COM](http://WIDIA.COM) OR [WIDIANOVO.COM](http://WIDIANOVO.COM).  
MOUNTING SCREWS ARE NOT INCLUDED IN STANDARD PACKAGING.

VSM490-15 • XNGU-ML • Precision Finishing and Light Machining

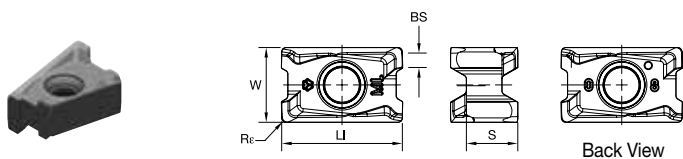

● first choice

○ alternate choice

P	■	■	■	●	●	●	●
M	■	■	■	●	●	●	●
K	■	■	■	○	○	○	○
N	■	■	■	●	●	●	●
S	■	■	■	○	○	○	○
H	■	■	■	○	○	○	○

ISO catalog number	ANSI catalog number	cutting edges	LI		S		W		BS		Re		hm		WK15CM	WK15PM	WN25PM	WP25PM	WP35CM	WP40PM	WS40PM	WU35PM
			mm	in	mm	in	mm	in	mm	in	mm	in	mm	in								
XNGU15T604ERML	XNGU1501ERML	4	16,20	.638	6,88	.271	10,00	.394	2,20	.088	0,40	.016	0,08	.003	■	■	■	■	■	■	■	■
XNGU15T608ERML	XNGU1502ERML	4	16,20	.638	6,88	.271	10,00	.394	1,80	.072	0,80	.032	0,08	.003	■	■	■	■	■	■	■	■

VSM490-15 • XNPU-ML • Light Machining

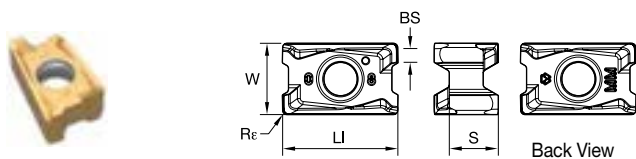

● first choice

○ alternate choice

P	■	■	■	●	●	●	●
M	■	■	■	●	●	●	●
K	■	■	■	○	○	○	○
N	■	■	■	●	●	●	●
S	■	■	■	○	○	○	○
H	■	■	■	○	○	○	○

ISO catalog number	ANSI catalog number	cutting edges	LI		S		W		BS		Re		hm		WK15CM	WK15PM	WN25PM	WP25PM	WP35CM	WP40PM	WS40PM	WU35PM
			mm	in	mm	in	mm	in	mm	in	mm	in	mm	in								
XNPU15T608ERML	XNPU1502ERML	4	16,10	.634	6,88	.271	10,00	.394	1,90	.073	0,80	.032	0,08	.003	■	■	■	■	■	■	■	■



VSM490-15 • XNGU-MH • Heavy Roughing

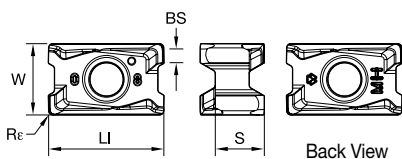

● first choice

○ alternate choice

P	■	■	■	●	●	●	●
M	■	■	■	●	●	●	●
K	■	■	■	○	○	○	○
N	■	■	■	●	●	●	●
S	■	■	■	○	○	○	○
H	■	■	■	○	○	○	○

ISO catalog number	ANSI catalog number	cutting edges	LI		S		W		BS		Re		hm		WK15CM	WK15PM	WN25PM	WP35CM	WP40PM	WS40PM	WU35PM
			mm	in	mm	in	mm	in	mm	in	mm	in	mm	in							
XNGU15T608SRMH	XNGU1502SRMH	4	16,20	.638	6,88	.271	10,00	.394	1,80	.069	0,80	.032	0,10	.004	6003725	6003724	6003570	6003723	6003721	6003722	
XNGU15T616SRMH	XNGU1504SRMH	4	16,20	.638	6,88	.271	10,00	.394	1,00	.040	1,60	.063	0,10	.004	6030380	6030378	6030376	6030377			

VSM490-15 • XNGU-ALP • For Aluminum and Other Non-Ferrous Alloys

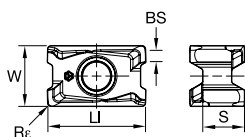

● first choice

○ alternate choice

P	■	■	■	●	●	●	●
M	■	■	■	●	●	●	●
K	■	■	■	○	○	○	○
N	■	■	■	●	●	●	●
S	■	■	■	○	○	○	○
H	■	■	■	○	○	○	○

ISO catalog number	ANSI catalog number	cutting edges	LI		S		W		BS		Re		hm		WK15CM	WK15PM	WN25PM	WP35CM	WP40PM	WS40PM	WU35PM
			mm	in	mm	in	mm	in	mm	in	mm	in	mm	in							
XNGU15T604ERALP	XNGU1501ERALP	4	16,20	.638	6,88	.271	10,00	.394	2,20	.088	0,40	.016	0,03	.001			6082644				
XNGU15T608ERALP	XNGU1502ERALP	4	16,20	.638	6,88	.271	10,00	.394	1,80	.072	0,80	.032	0,03	.001			6082645				



VSM490-15 • Insert Selection Guide

Material Group	Light Machining		General Purpose		Heavy Machining	
	Geometry	Grade	Geometry	Grade	Geometry	Grade
P1-P2	XNGU-ML	WP40PM	XNPU-MM	WP40PM	XNPU-MM	WP40PM
P3-P4	XNGU-ML	WP40PM	XNPU-MM	WP40PM	XNPU-MM	WP40PM
P5-P6	XNGU-MM	WP25PM	XNPU-MM	WP35CM	XNPU-MM	WP40PM
M1-M2	XNGU-ML	WS40PM	XNGU-ML	WS40PM	XNPU-MM	WS40PM
M3	XNGU-ML	WS40PM	XNGU-ML	WS40PM	XNPU-MM	WS40PM
K1-K2	XNPU-MM	WK15PM	XNGU-MH	WK15CM	XNGU-MH	WK15CM
K3	XNPU-MM	WK15PM	XNGU-MH	WP35CM	XNGU-MH	WP35CM
N1-N2	XNGU-ALP	WN25PM	XNGU-ALP	WN25PM	XNGU-ALP	WN25PM
N3	XNGU-ALP	WN25PM	XNGU-ALP	WN25PM	XNGU-ALP	WN25PM
S1-S2	XNGU-ML	WP25PM	XNGU-ML	WS40PM	XNPU-MM	WS40PM
S3	XNGU-ML	WS40PM	XNGU-ML	WS40PM	XNPU-MM	WS40PM
S4	XNGU-ML	WS40PM	XNGU-ML	WS40PM	XNPU-MM	WS40PM
H1	-	-	-	-	-	-

VSM490-15 • Recommended Starting Speeds [SFM]

Material Group		WK15CM			WK15PM			WN25PM			WP25PM			WP35CM			WP40PM			WS40PM			WU35PM		
		P	1	-	-	-	-	-	-	-	-	-	1085	935	885	1495	1295	1215	970	855	805	-	-	-	855
P	2	-	-	-	-	-	-	-	-	-	900	785	655	920	835	755	820	705	590	-	-	-	720	625	525
P	3	-	-	-	-	-	-	-	-	-	835	705	575	835	755	675	755	640	525	-	-	-	655	560	460
P	4	-	-	-	-	-	-	-	-	-	740	605	490	625	575	525	675	560	445	-	-	-	590	490	395
P	5	-	-	-	-	-	-	-	-	-	605	560	490	855	755	690	560	510	445	560	475	395	490	445	395
P	6	-	-	-	-	-	-	-	-	-	540	410	330	525	445	360	490	375	295	490	360	260	425	330	260
M	1	-	-	-	-	-	-	-	-	-	675	590	540	675	605	510	640	560	510	690	560	460	560	490	445
M	2	-	-	-	-	-	-	-	-	-	605	525	425	605	525	460	575	490	410	590	475	395	510	425	360
M	3	-	-	-	-	-	-	-	-	-	460	395	310	475	425	375	425	375	295	475	360	280	375	330	260
K	1	1380	1265	1115	885	805	705	-	-	-	755	675	605	970	870	785	-	-	-	-	-	-	-	-	-
K	2	1100	970	900	690	625	575	-	-	-	590	525	490	770	690	625	-	-	-	-	-	-	-	-	-
K	3	920	820	755	575	525	475	-	-	-	490	445	395	640	575	525	-	-	-	-	-	-	-	-	-
N	1	-	-	-	-	-	-	3525	3100	2870	-	-	-	-	-	-	-	-	-	-	-	-	-	-	-
N	2	-	-	-	-	-	-	3100	2870	2495	-	-	-	-	-	-	-	-	-	-	-	-	-	-	-
N	3	-	-	-	-	-	-	3100	2870	2495	-	-	-	-	-	-	-	-	-	-	-	-	-	-	-
S	1	-	-	-	-	-	-	-	-	-	130	115	80	-	-	-	130	115	100	130	115	80	115	100	80
S	2	-	-	-	-	-	-	-	-	-	130	115	80	-	-	-	130	115	100	130	115	80	115	100	80
S	3	-	-	-	-	-	-	-	-	-	165	130	80	-	-	-	165	130	100	165	130	80	150	115	80
S	4	-	-	-	-	-	-	-	-	-	230	165	115	-	-	-	215	165	115	195	165	100	195	150	100
H	1	-	-	-	-	-	-	-	-	-	-	-	-	-	-	-	-	-	-	-	-	-	-	-	-

NOTE: FIRST choice starting speeds are in **bold** type.  
 As the average chip thickness increases, the speed should be decreased.  
 \*Material groups P, M, K, and H show recommended starting speeds for dry machining. For wet machining, reduce speed by 20%.  
 \*Material groups N and S show recommended starting speeds for wet machining. Not recommended for dry machining.

VSM490-15 • Recommended Starting Feeds [IPT]

Light Machining	General Purpose	Heavy Machining
-----------------	-----------------	-----------------

Insert Geometry	Programmed Feed per Tooth (fz) as a % of Radial Depth of Cut (ae)															Insert Geometry
	5%			10%			20%			30%			40-100%			
.E.AL	.005	<b>.008</b>	.012	.003	<b>.006</b>	.009	.002	<b>.004</b>	.007	.002	<b>.004</b>	.006	.002	<b>.004</b>	.005	.E.AL
.E.ML	.007	<b>.012</b>	.018	.005	<b>.009</b>	.013	.004	<b>.006</b>	.010	.003	<b>.006</b>	.008	.003	<b>.005</b>	.008	.E.ML
.S.MM	.008	<b>.015</b>	.024	.006	<b>.011</b>	.017	.005	<b>.008</b>	.013	.004	<b>.007</b>	.011	.004	<b>.007</b>	.010	.S.MM
.S.MH	.009	<b>.017</b>	.028	.006	<b>.012</b>	.020	.005	<b>.009</b>	.015	.004	<b>.008</b>	.013	.004	<b>.007</b>	.012	.S.MH

NOTE: Use "Light Machining" value as starting feed rate.



Use VSM890 shoulder mills to perform a true 90-degree wall and axial step down in light machining to heavy roughing jobs while maintaining a smooth surface finish in all material groups.

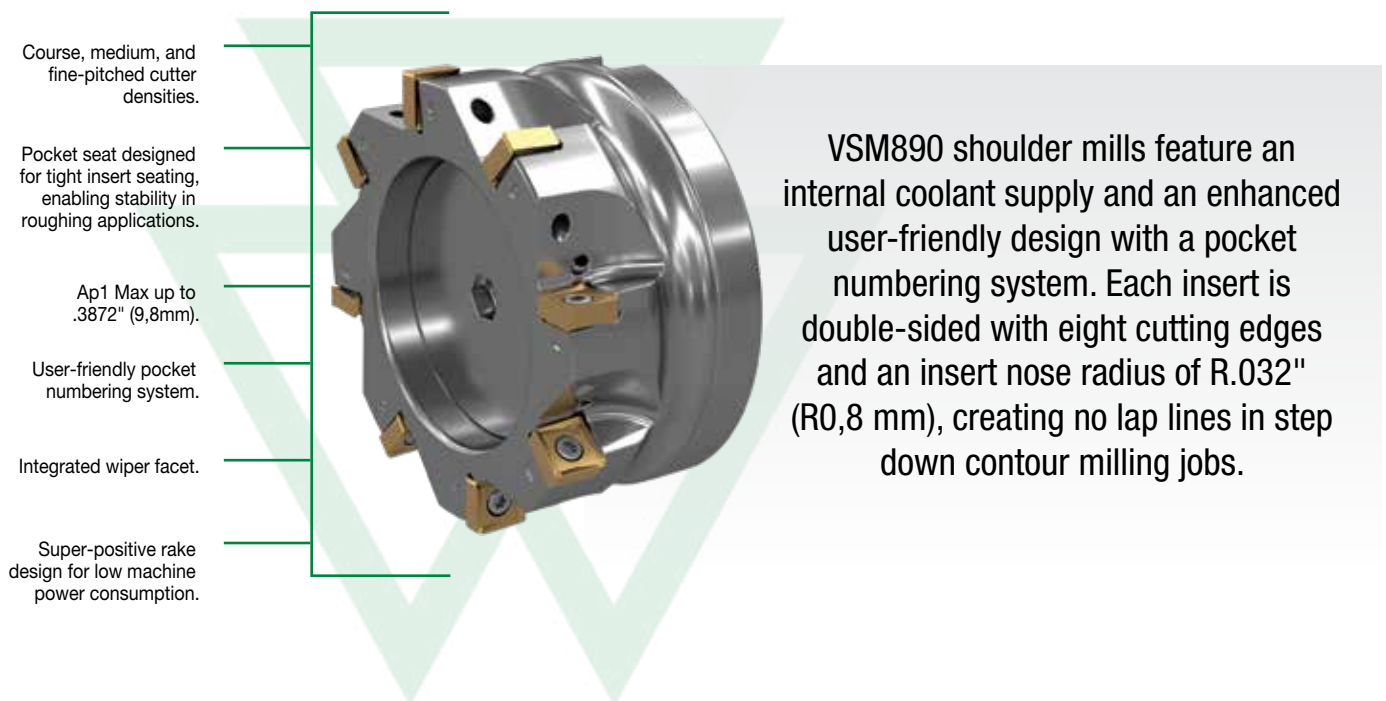

**UNIQUE INSERT RAKE DESIGN TO REDUCE AND PERFECTLY BALANCE AXIAL AND RADIAL CUTTING FORCES. ENGINEERED FOR LIGHT MACHINING TO HEAVY ROUGHING IN ALL MATERIAL GROUPS.**

**-ALP**



**N**

First choice for Non-Ferrous materials.

**-ML**

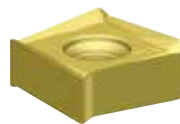

**P M S**

First choice for Stainless Steel, light machining, and finishing jobs.

**-MM**



**P M K S H**

First choice for general purpose in all workpiece materials. Engineered for high-feed rates.

Finishing Capabilities/Lower Cutting Forces

Geometry Strengthening

# TRUE 90-DEGREE WALL AND AXIAL STEP DOWN WITH VSM890™

## PRODUCT

### SERIES

VSM890

### DIAMETER RANGE

Weldon End Mills:  
1.25–1.5" (32mm)  
Shell Mills: 2–10" (40–250mm)

## SHANK TYPES

Weldon® End Mills  
Shell Mills

## INDUSTRY



## APPLICATIONS



FACE MILLING



SIDE/  
SHOULDER MILLING:  
SLOTting:  
SHOULDER



SLOTting:  
TROCHOIDAL MILLING



PLUNGE MILLING



SLOTting:  
SQUARE END



POCKET MILLING

## VERSATILITY

Apply VSM890 in a variety of applications.

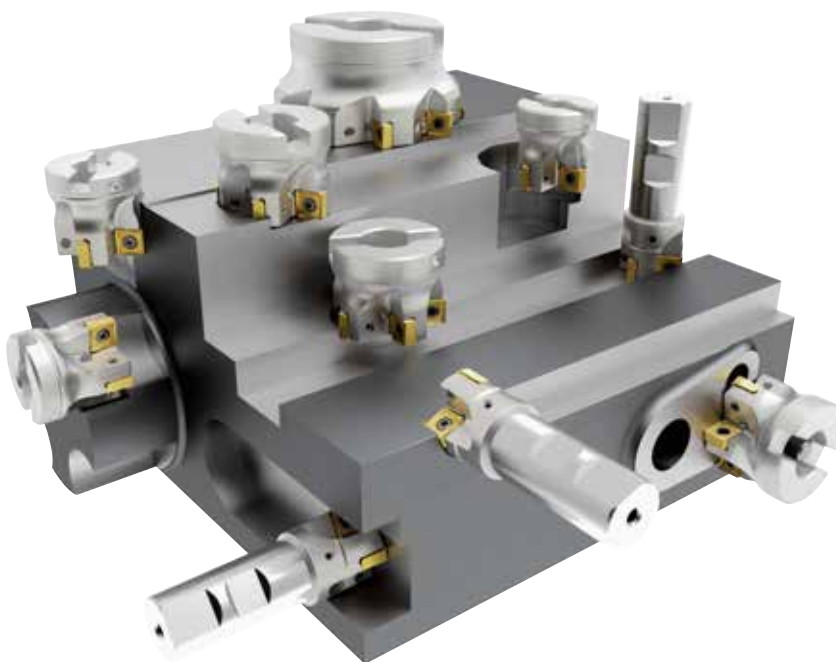

## VSM890-12 • Weldon® End Mills • Inch

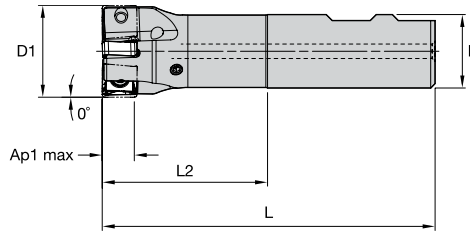

order number	catalog number	D1	D	L	L2	Ap1 max	Z	max RPM	coolant supply	lbs
6596129	VSM890D125Z03W100SN12	1.250	1.000	4.530	2.250	.387	3	33400	Yes	.89
6596130	VSM890D150Z04W100SN12	1.500	1.000	4.530	2.250	.387	4	29100	Yes	1.18

## VSM890-12 • Shell Mills • Inch

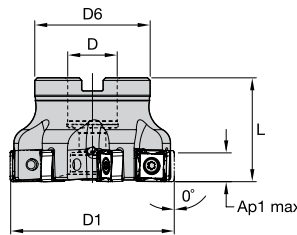

order number	catalog number	D1	D	D6	L	Ap1 max	Z	max RPM	coolant supply	lbs
6596131	VSM890D200Z04S075SN12	2.000	.750	1.750	1.575	.387	4	23800	Yes	.73
6596132	VSM890D200Z05S075SN12	2.000	.750	1.750	1.575	.387	5	23800	Yes	.70
6596133	VSM890D250Z05S075SN12	2.500	.750	1.750	1.575	.387	5	20700	Yes	1.06
6596134	VSM890D250Z07S075SN12	2.500	.750	1.750	1.575	.387	7	20700	Yes	.99
6596135	VSM890D300Z05S100SN12	3.000	1.000	2.190	1.750	.387	5	18500	Yes	1.63
6596136	VSM890D300Z07S100SN12	3.000	1.000	2.190	1.750	.387	7	18500	Yes	1.73
6596137	VSM890D300Z09S100SN12	3.000	1.000	2.190	1.750	.387	9	18500	Yes	1.69
6596138	VSM890D400Z06S150SN12	4.000	1.500	3.810	2.000	.387	6	15700	Yes	3.51
6596139	VSM890D400Z08S150SN12	4.000	1.500	3.810	2.000	.387	8	15700	Yes	3.76
6596151	VSM890D400Z11S150SN12	4.000	1.500	3.810	2.000	.387	11	15700	Yes	3.67
6596152	VSM890D500Z07S150SN12	5.000	1.500	3.810	2.380	.387	7	13800	Yes	6.02
6596153	VSM890D500Z10S150SN12	5.000	1.500	3.810	2.380	.387	10	13800	Yes	6.40
6596154	VSM890D500Z14S150SN12	5.000	1.500	3.810	2.380	.387	14	13800	Yes	6.14
6596155	VSM890D600Z08S200SN12	6.000	2.000	4.875	2.380	.387	8	12500	Yes	9.44
6596156	VSM890D600Z12S200SN12	6.000	2.000	4.875	2.380	.387	12	12500	Yes	9.43
6596157	VSM890D600Z16S200SN12	6.000	2.000	4.875	2.380	.387	16	12500	Yes	9.64
6596158	VSM890D800Z10S250SN12	8.000	2.500	5.118	2.380	.387	10	10700	Yes	12.08
6596159	VSM890D800Z14S250SN12	8.000	2.500	5.118	2.380	.387	14	10700	Yes	12.60
6596160	VSM890D800Z22S250SN12	8.000	2.500	5.118	2.380	.387	22	10700	Yes	12.45
6613696	VSM890D1000Z16S250SN12	10.000	2.500	5.118	2.380	.387	16	9500	Yes	18.01

FOR SPARE PARTS, PLEASE VISIT [WIDIA.COM](http://WIDIA.COM) OR [WIDIANOVO.COM](http://WIDIANOVO.COM).  
MOUNTING SCREWS ARE NOT INCLUDED IN STANDARD PACKAGING.

VSM890-12 • SNHX-ML • Precision Finishing and Light Machining

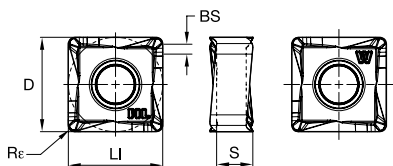

- first choice
- alternate choice

P	■	■	●	●	●	●
M	■	■	●	●	●	●
K	■	■	○	○	○	○
N	■	■	●	●	●	●
S	■	■	○	○	○	○
H	■	■	○	○	○	○

ISO catalog number	ANSI catalog number	cutting edges	LI		S		D		BS		Re		WK15CM	WN25PM	WP25PM	WP35CM	WP40PM	WS40PM	WU10PM	
			mm	in	mm	in	mm	in	mm	in	mm	in								
SNHX120408PNERML	SNHX1202PNERML	8	12,00	.472	4,61	.181	12,00	.472	1,34	.053	0,80	.032	■	■	●	●	●	●	●	●

VSM890-12 • SNHX-MM • Universal Geometry for Medium Machining

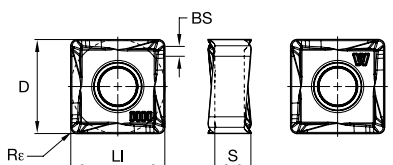

- first choice
- alternate choice

P	■	■	●	●	●	●
M	■	■	●	●	●	●
K	■	■	○	○	○	○
N	■	■	●	●	●	●
S	■	■	○	○	○	○
H	■	■	○	○	○	○

ISO catalog number	ANSI catalog number	cutting edges	LI		S		D		BS		Re		WK15CM	WN25PM	WP25PM	WP35CM	WP40PM	WS40PM	WU10PM
			mm	in	mm	in	mm	in	mm	in	mm	in							
SNHX120408PNSRMM	SNHX1202PNSRMM	8	12,00	.472	4,61	.181	12,00	.472	1,34	.053	0,80	.032	■	■	●	●	●	●	●
SNHX120416PNSRMM	SNHX1204PNSRMM	8	12,00	.472	4,58	.180	12,00	.472	1,00	.039	1,60	.063	■	■	○	○	○	○	○

VSM890-12 • SNHX-ALP • For Aluminum and Other Non-Ferrous Alloys

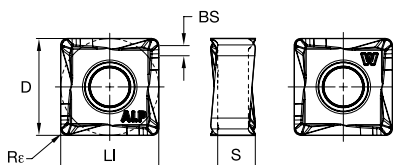

- first choice
- alternate choice

P	■	■	●	●	●	●
M	■	■	●	●	●	●
K	■	■	○	○	○	○
N	■	■	●	●	●	●
S	■	■	○	○	○	○
H	■	■	○	○	○	○

ISO catalog number	ANSI catalog number	cutting edges	LI		S		D		BS		Re		WK15CM	WN25PM	WP25PM	WP35CM	WP40PM	WS40PM	WU10PM
			mm	in	mm	in	mm	in	mm	in	mm	in							
SNHX120408PNERALP	SNHX1202PNERALP	8	12,00	.472	4,61	.181	12,00	.472	1,34	.053	0,80	.032	■	■	○	○	○	○	○

VSM890-12 • Insert Selection Guide

INDEXABLE MILLING

SOLID END MILLING

Material Group	Light Machining		General Purpose		Heavy Machining	
	Geometry	Grade	Geometry	Grade	Geometry	Grade
P1-P2	SNHX-ML	WS40PM	SNHX-MM	WP40PM	SNHX-MM	WP40PM
P3-P4	SNHX-ML	WS40PM	SNHX-MM	WP40PM	SNHX-MM	WP40PM
P5-P6	SNHX-ML	WP25PM	SNHX-MM	WP40PM	SNHX-MM	WP40PM
M1-M2	SNHX-ML	WS40PM	SNHX-ML	WS40PM	SNHX-MM	WS40PM
M3	SNHX-ML	WS40PM	SNHX-ML	WS40PM	SNHX-MM	WS40PM
K1-K2	SNHX-MM	WK15CM	SNHX-MM	WK15CM	SNHX-MM	WK15CM
K3	SNHX-MM	WK15CM	SNHX-MM	WK15CM	SNHX-MM	WK15CM
N1-N2	SNHX-ALP	WN25PM	SNHX-ALP	WN25PM	SNHX-ALP	WN25PM
N3	SNHX-ALP	WN25PM	SNHX-ALP	WN25PM	SNHX-ALP	WN25PM
S1-S2	SNHX-ML	WP25PM	SNHX-ML	WS40PM	SNHX-MM	WS40PM
S3	SNHX-ML	WS40PM	SNHX-ML	WS40PM	SNHX-MM	WS40PM
S4	SNHX-ML	WS40PM	SNHX-ML	WS40PM	SNHX-MM	WS40PM
H1	SNHX-MM	WU10PM	SNHX-MM	WU10PM	-	-

VSM890-12 • Recommended Starting Speeds [SFM]

HOLEMAKING

TAPPING

Material Group	WK15CM	WN25PM	WP25PM	WP35CM	WP40PM	WS40PM	WU10PM
P	1	- - -	- - -	1085 935 885	1490 1295 1210	970 855 805	- - -
	2	- - -	- - -	900 785 655	915 835 750	820 705 590	- - -
	3	- - -	- - -	835 705 575	835 750 670	755 640 525	- - -
	4	- - -	- - -	740 605 490	620 570 520	675 560 445	- - -
	5	- - -	- - -	605 560 490	850 750 685	560 510 445	560 475 395
	6	- - -	- - -	540 410 330	520 440 360	490 375 295	490 360 260
M	1	- - -	- - -	675 590 540	670 605 505	640 560 510	690 560 460
	2	- - -	- - -	605 525 425	605 520 455	575 490 410	590 475 395
	3	- - -	- - -	460 395 310	475 425 375	425 375 295	475 360 280
K	1	1380 1265 1115	- - -	755 675 605	965 865 785	- - -	970 870 785
	2	1100 970 900	- - -	590 525 490	770 685 620	- - -	755 675 625
	3	920 820 755	- - -	490 445 395	635 570 520	- - -	640 575 525
N	1	- - -	3525 3100 2870	- - -	- - -	- - -	- - -
	2	- - -	3100 2870 2495	- - -	- - -	- - -	- - -
	3	- - -	3100 2870 2495	- - -	- - -	- - -	- - -
S	1	- - -	- - -	130 115 80	- - -	130 115 100	130 115 80
	2	- - -	- - -	130 115 80	- - -	130 115 100	130 115 80
	3	- - -	- - -	165 130 80	- - -	165 130 100	165 130 80
	4	- - -	- - -	230 165 115	215 160 105	215 165 115	195 165 100
H	1	- - -	- - -	- - -	- - -	- - -	525 425 295

NOTE: FIRST choice starting speeds are in bold type.  
 As the average chip thickness increases, the speed should be decreased.  
 \*Material groups P, M, K, and H show recommended starting speeds for dry machining. For wet machining, reduce speed by 20%.  
 \*Material groups N and S show recommended starting speeds for wet machining. Not recommended for dry machining.

VSM890-12 • Recommended Starting Feeds [IPT]

TURNING

Light Machining	General Purpose	Heavy Machining
-----------------	-----------------	-----------------

Insert Geometry	Programmed Feed per Tooth (fz) as a % of Radial Depth of Cut (ae)															Insert Geometry
	5%			10%			20%			30%			40-100%			
.E..ALP	.005	<b>.010</b>	.015	.003	<b>.007</b>	.011	.003	<b>.005</b>	.008	.002	<b>.005</b>	.007	.002	<b>.004</b>	.006	.E..ALP
.E..ML	.007	<b>.012</b>	.023	.005	<b>.009</b>	.017	.004	<b>.007</b>	.012	.003	<b>.006</b>	.011	.003	<b>.005</b>	.010	.E..ML
.S..MM	.009	<b>.014</b>	.032	.007	<b>.010</b>	.023	.005	<b>.008</b>	.017	.004	<b>.007</b>	.015	.004	<b>.006</b>	.014	.S..MM

NOTE: Use "Light Machining" value as starting feed rate.



Best Practices

True 0° roughing tool with embedded finishing capabilities all in one tool.

Best-in-class wall finish with VSM890-12 in axial stepping-down jobs. For many shop floor setups, no additional finishing is required resulting in shorter machining time and lower tooling cost.

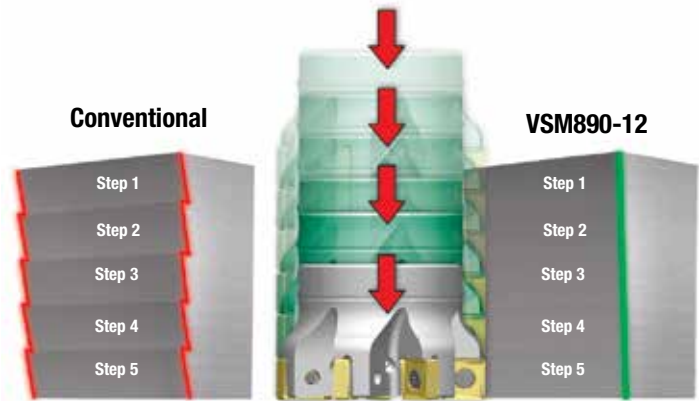

Excellent wall finish with VSM890-12

Coarse Pitch

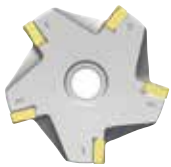

- Unstable setup.
- Low spindle power.
- High axial depth of cut Ap1.
- Low feed rate.
- Machining aluminum.
- Driven tools.

Medium Pitch



- Regular setup.
- Regular spindle power.
- Medium feed rate.

Fine Pitch



- Rigid setup.
- High spindle power.
- Low axial depth of cut Ap1.
- High feed rate.
- Boost productivity and cut into cycle time.

Machining Stability



VSM890-12 Z-Axis Plunge Milling

cutting diameter (D1)	Y max	X
1.25	0.3504	1.1228
1.5	0.3504	1.2693
2	0.3504	1.5205
2.5	0.3504	1.7358
3	0.3504	1.9272
4	0.3504	2.2618
5	0.3504	2.5528
6	0.3504	2.8138
8	0.3504	3.2744
10	0.3504	3.6776

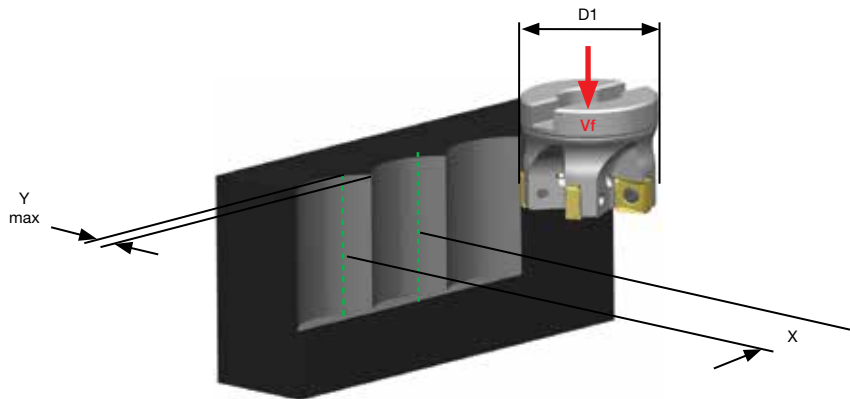

VSM890-12 Ap1 max at Full Slotting, 100% Radial Cutter Engagement

D1 diameter	Recommended Cutter Density	Ap1 max		
		Gray Cast Iron EN-GJL-250 EN-JL1040 GG25	Steel AISI 4140 1.7225 42CrMo4	Stainless Steel AISI 316L, 1.4404, X2CrNiMo1810
1.5"	4	.300"	.250"	.195"
2.0"	4	.300"	.250"	.195"
2.5"	5	.300"	.250"	.195"
3.0"	5	.300"	.250"	.195"
4.0"	6	.300"	.250"	.195"

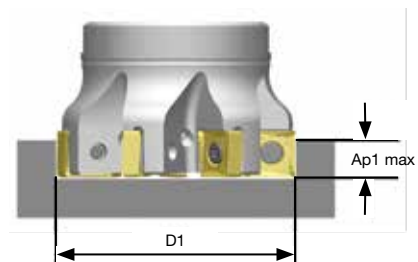



# M680 Series

M680-09, M680-16, and M680+ Shoulder Mills



## M680-09

The M680-09 shoulder mill provides the length needed to machine deep cavities or wall machines. The axially positive geometry makes this tool suitable for machining in unstable conditions.



## M680-16

The M680-16 is a versatile 90° shoulder mill with optimized strong tool design for challenging milling operations. A wide selection of inserts are available to machine all material types.



## M680+

The M680+ is a general purpose shoulder mill that features strong inserts for high reliability in roughing applications and interrupted cuts.

### M680 TO M680-16



#### AL

Additional choice for aluminum and non-ferrous alloy machining.



#### XP.16..

First choice for general machining operations in steel and cast iron.

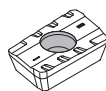

#### MR

First choice for heavy machining and unstable conditions (e.g., long reach).

### M680-09



#### -XDHT

Versatile choice for general machining operations in steel, stainless steel, cast iron, non-ferrous, high-temp alloys, and hardened materials.



#### -MM

First choice for general machining in steel and cast iron.

# WIDE RANGE OF INSERTS FOR OPTIMAL PERFORMANCE

PRODUCT		INSERTS		
SERIES	DIAMETER RANGE	INSERT TYPE	GRADE	MATERIALS
<b>M680-09</b>	.625–1.25" (16–32mm)	XDHT, MM	WK15PM, WU20PM	<b>P M K N S H</b>
<b>M680-16</b>	1–2" (16–160mm)	ALP, AL, GE, XP.16, MR	THR, THM-U, TN6501, TN6502, TN6510, TN6520, TN6525, TN6540, TTM08, WK15PM, WP35CM, WU20PM, TTI25, THM, WK15CM, WP40PM, WS30PM	<b>P M K N S H</b>
<b>M680+</b>	25–40mm (only available in metric sizes)	ML, MM, MH	THM, TN6510, TN6520, TN6540, WK15CM, WP35CM	<b>P M K N S</b>

## APPLICATIONS

							
SIDE MILLING/ SHOULDER MILLING: SQUARE END	SLOTTING: SQUARE END	FACE MILLING	THROUGH COOLANT: RADIAL: INDEXABLE MILLING	SLOTTING: SIDE MILLING	PLUNGE MILLING	POCKETING	RAMPING: BLANK

## INDUSTRY



## M680-09 • Cylindrical End Mills • XD09 • Inch

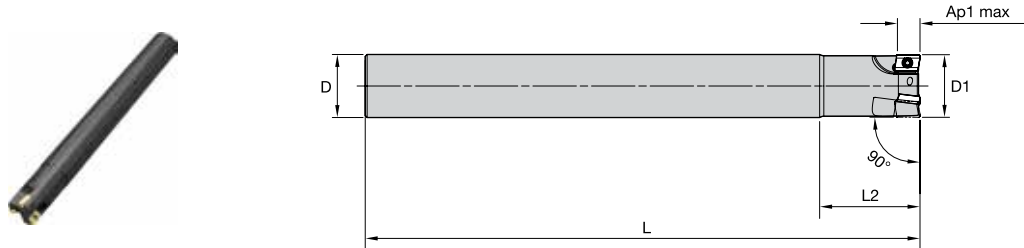

order number	catalog number	D1	D	L	L2	Ap1 max	Z	max RPM	coolant supply	lbs
6921188	M680U062Z02C062XD09L600	.625	.625	6.000	1.250	.354	2	22000	No	.48
6921189	M680U075Z02C075XD09L800	.750	.750	8.000	1.610	.354	2	—	No	.95
6921191	M680U100Z03C100XD09L800	1.000	1.000	8.000	2.100	.354	3	—	No	1.67
6921192	M680U125Z04C125XD09L980	1.250	1.250	9.800	2.510	.354	4	—	No	3.26

NOTE: Please order wrench separately.

INDEXABLE MILLING

SOLID END MILLING

HOLEMAKING

TAPPING

TURNING

FOR SPARE PARTS, PLEASE VISIT [WIDIA.COM](http://WIDIA.COM) OR [WIDIANOVO.COM](http://WIDIANOVO.COM).  
MOUNTING SCREWS ARE NOT INCLUDED IN STANDARD PACKAGING.



M680-09 • XDHT-AL

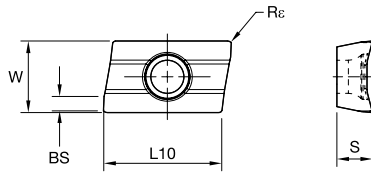
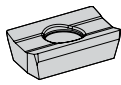

● first choice  
○ alternate choice

P											●	●	●	●		●	●	○	●
M											○	○	○			○	○	○	○
K											○	○	○			○	○	○	○
N											○	○	○			○	○	○	○
S											○	○	○			○	○	○	○
H											○	○	○			○	○	○	○

ISO catalog number	ANSI catalog number	cutting edges	W		L10		S		BS		Re		hm		THM	THM-J	THR	TN6501	TN6502	TN6510	TN6520	TN6525	TN6540	TTI25	TTM08	WK15CM	WK15PM	WP35CM	WP40PM	WS30PM	WU20PM		
			mm	in	mm	in	mm	in	mm	in	mm	in	mm	in																		mm	in
XDHT090308AL	XDHT222AL	2	6,71	.264	9,46	.372	3,08	.121	1,00	.039	0,80	.031	0,02	.001	2031793																		

M680-09 • Insert Selection Guide

Material Group	Light Machining		General Purpose		Heavy Machining	
	Geometry	Grade	Geometry	Grade	Geometry	Grade
P1-P2	.XDHT..	WU20PM	.XDHT..	WU20PM	..SRMM	WU20PM
P3-P4	.XDHT..	WU20PM	.XDHT..	WU20PM	..SRMM	WU20PM
P5-P6	.XDHT..	WU20PM	..SRMM	WU20PM	..SRMM	WU20PM
M1-M2	.XDHT..	WU20PM	.XDHT..	WU20PM	..SRMM	WU20PM
M3	.XDHT..	WU20PM	..SRMM	WU20PM	..SRMM	WU20PM
K1-K2	.XDHT..	WK15CM	.XDHT..	WK15CM	..SRMM	WK15PM
K3	.XDHT..	WK15CM	..SRMM	WK15PM	..SRMM	WK15PM
N1-N2	.XDHT..	WU20PM	.XDHT..	WU20PM	.XDHT..	WU20PM
N3	.XDHT..	WU20PM	.XDHT..	WU20PM	..SRMM	WU20PM
S1-S2	.XDHT..	WU20PM	.XDHT..	WU20PM	..SRMM	WU20PM
S3	.XDHT..	WU20PM	..SRMM	WU20PM	..SRMM	WU20PM
S4	..SRMM	WU20PM	..SRMM	WU20PM	..SRMM	WU20PM
H1	.XDHT..	WU20PM	-	-	-	-

M680 XD09 • Recommended Starting Speeds [SFM]

Material Group		THM			THM-U			THR			TN6501			TN6502			TN6510			TN6520			TN6525			
P	1	-	-	-	-	-	-	-	-	-	-	-	-	-	-	-	-	-	-	-	-	-	1345	1050	920	
	2	-	-	-	-	-	-	-	-	-	-	-	-	-	-	-	-	-	-	-	-	-	1050	820	705	
	3	-	-	-	-	-	-	-	-	-	-	-	-	-	-	-	-	-	-	-	-	-	920	705	605	
	4	-	-	-	-	-	-	-	-	-	-	-	-	-	-	-	-	-	-	-	-	-	770	560	475	
	5	-	-	-	-	-	-	-	-	-	-	-	-	-	-	-	-	-	-	-	-	-	1015	770	640	
	6	-	-	-	-	-	-	-	-	-	-	-	-	-	-	-	-	-	-	-	-	-	670	525	425	
M	1	-	-	-	-	-	-	-	-	-	-	-	-	-	-	-	-	-	-	-	-	-	-	625	395	260
	2	-	-	-	-	-	-	-	-	-	-	-	-	-	-	-	-	-	-	-	-	-	395	260	165	
	3	-	-	-	-	-	-	-	-	-	-	-	-	-	-	-	-	-	-	-	-	-	410	260	180	
K	1	390	295	245	620	555	490	490	440	390	-	-	-	-	-	-	1575	1150	835	1475	1050	755	-	-	-	
	2	410	325	225	-	-	-	605	455	390	-	-	-	-	-	-	1380	920	670	1280	820	625	-	-	-	
	3	425	310	195	-	-	-	340	245	160	-	-	-	-	-	-	1100	855	655	985	740	525	-	-	-	
N	1	2950	1965	1640	6560	3935	3280	2950	1965	1640	6560	3935	3280	5245	3115	2620	-	-	-	-	-	-	-	-	-	
	2	2245	1525	1260	4475	2670	2180	2245	1525	1260	4475	2670	2180	3605	2180	1800	-	-	-	-	-	-	-	-	-	
	3	1475	915	655	2620	1640	1310	1475	915	655	2620	1640	1310	2130	1310	980	-	-	-	-	-	-	-	-	-	
S	1	-	-	-	-	-	-	110	80	65	-	-	-	-	-	-	-	-	-	-	-	-	-	-	-	
	2	-	-	-	-	-	-	80	65	45	-	-	-	-	-	-	-	-	-	-	-	-	-	-	-	
	3	-	-	-	-	-	-	160	130	95	-	-	-	-	-	-	-	-	-	-	-	-	-	-	-	
	4	-	-	-	-	-	-	110	80	55	-	-	-	-	-	-	-	-	-	-	-	-	-	-	-	
H	1	-	-	-	-	-	-	-	-	-	-	-	-	-	-	-	-	-	-	-	-	-	-	-	-	
	2	-	-	-	-	-	-	-	-	-	-	-	-	-	-	-	-	-	-	-	-	-	-	-	-	
	3	-	-	-	-	-	-	-	-	-	-	-	-	-	-	-	-	-	-	-	-	-	-	-	-	

Material Group		TN6540			TTI25			TTM08			WK15CM			WK15PM			WP35CM			WP40PM			WS30PM			WU20PM		
P	1	1180	920	785	1180	985	820	750	655	620	-	-	-	-	-	1490	1295	1210	970	855	805	1215	1050	985	1080	950	885	
	2	820	625	540	855	690	590	635	555	455	-	-	-	-	-	915	835	750	820	705	590	1000	885	720	900	820	655	
	3	705	540	460	855	690	590	590	490	410	-	-	-	-	-	835	750	670	755	640	525	935	785	640	835	720	570	
	4	590	425	360	720	590	490	520	425	340	-	-	-	-	-	620	570	520	670	560	445	820	670	540	735	620	490	
	5	785	590	490	870	640	540	-	-	-	-	-	-	-	-	850	750	685	560	510	445	670	625	540	605	570	490	
	6	525	395	330	395	295	245	-	-	-	-	-	-	-	-	520	440	360	490	375	295	605	460	360	540	425	325	
M	1	425	260	195	1310	855	590	-	-	-	-	-	-	-	670	605	505	640	560	510	740	655	605	670	590	540		
	2	260	165	130	885	560	395	-	-	-	-	-	-	-	605	520	455	575	490	410	670	590	475	605	520	425		
	3	280	165	130	870	575	395	-	-	-	-	-	-	-	475	425	375	425	375	295	510	445	345	455	390	310		
K	1	-	-	-	605	510	425	-	-	-	1380	1265	1115	1310	950	705	965	865	785	-	-	835	740	640	820	720	605	
	2	-	-	-	490	395	345	-	-	-	1100	970	900	1145	770	555	770	685	620	-	-	655	590	540	655	590	490	
	3	-	-	-	395	345	280	-	-	-	920	820	755	915	800	540	635	570	520	-	-	540	490	445	590	490	390	
N	1	-	-	-	-	-	-	-	-	-	-	-	-	-	-	-	-	-	-	-	-	-	-	-	1800	1540	1310	
	2	-	-	-	-	-	-	-	-	-	-	-	-	-	-	-	-	-	-	-	-	-	-	-	1800	1540	1310	
	3	-	-	-	-	-	-	-	-	-	-	-	-	-	-	-	-	-	-	-	-	-	-	-	1310	1145	980	
S	1	150	115	100	-	-	-	-	-	-	-	-	-	-	-	-	-	-	130	115	100	150	130	100	130	110	80	
	2	80	65	35	-	-	-	-	-	-	-	-	-	-	-	-	-	-	130	115	100	150	130	100	130	110	80	
	3	230	130	100	-	-	-	-	-	-	-	-	-	-	-	-	-	-	165	130	100	180	150	100	160	130	80	
	4	195	100	80	-	-	-	-	-	-	-	-	-	-	-	-	215	160	105	215	165	115	280	195	130	225	160	110
H	1	-	-	-	-	-	-	-	-	-	-	-	-	-	-	-	-	-	-	-	-	445	330	245	360	260	225	
	2	-	-	-	-	-	-	-	-	-	-	-	-	-	-	-	-	-	-	-	-	-	-	-	-	-	-	
	3	-	-	-	-	-	-	-	-	-	-	-	-	-	-	-	-	-	-	-	-	-	-	-	-	-	-	

NOTE: FIRST choice starting speeds are in bold type.  
As the average chip thickness increases, the speed should be decreased.

M680-09 • Recommended Starting Feeds [IPT]

Light Machining	General Purpose	Heavy Machining
-----------------	-----------------	-----------------

Insert Geometry	Programmed Feed per Tooth (fz) as a % of Radial Depth of Cut (ae)															Insert Geometry
	5%			10%			20%			30%			40-100%			
.XDHT..	.006	.017	.026	.004	.012	.018	.003	.009	.014	.003	.008	.012	.003	.007	.011	.XDHT..
..SRMM	.007	.019	.029	.005	.014	.020	.004	.010	.015	.003	.009	.013	.003	.008	.012	..SRMM

NOTE: Use "Light Machining" value as starting feed rate.

# M690 Series

M690 IC12, M690 IC15

The M690 is an economical, four-edged shoulder mill designed to deliver optimal chip evacuation, excellent shoulder finish, and free cutting action.



## IC12 AND IC15 INSERTS OFFERED IN 4 GEOMETRIES



**-ALP**



Recommended as a first choice for machining non-ferrous and aluminum materials.

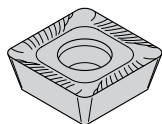

**-ML**



Steel, cast iron with secondary uses on stainless and titanium.



**-MH**



This geometry is reserved for heavy or interrupted cut machining operations that require additional edge protection.



**-MM**



Steel, cast iron with secondary uses on stainless and titanium.

Recommended as a first choice for general machining of all materials.

# ECONOMICAL SHOULDER MILLING

## PRODUCT

### SERIES

M690

### DIAMETER RANGE

1.5–6" (125–315mm)

## SHANK TYPES

Shell Mills  
Weldon® End Mills

## INDUSTRY



## APPLICATIONS



SIDE MILLING/  
SHOULDER  
MILLING:  
SQUARE END



FACE  
MILLING



SLOTING:  
SQUARE END





INDEXABLE MILLING

SOLID END MILLING

## M690 • Weldon® End Mills • SD1204 • Inch

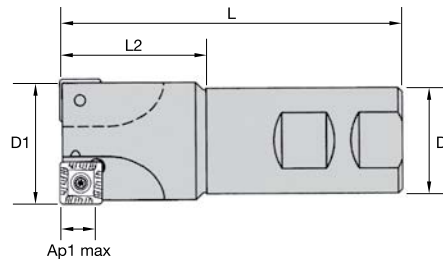

order number	catalog number	D1	D	L	L2	Ap1 max	Z	max RPM	coolant supply	lbs
2646782	M690D150Z03W125SD12	1.500	1.250	4.000	1.720	.400	3	22400	Yes	1.40

HOLEMAKING

TAPPING

## M690 • Shell Mills • SD1204 • Inch

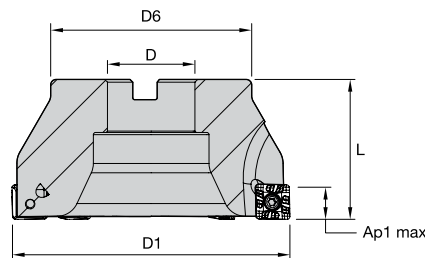

order number	catalog number	D1	D	D6	L	Ap1 max	Z	max RPM	coolant supply	lbs
2646785	M690D200Z05S075SD12	2.000	.750	1.700	1.500	.400	5	22400	Yes	.50
2646788	M690D250Z06S100SD12	2.500	1.000	2.200	1.750	.400	6	20000	Yes	1.35
2646790	M690D300Z06SD12	3.000	1.000	2.305	2.000	.400	6	17200	No	1.84

NOTE: Standard milling cutters will accept insert nose radius up to 0.79" without modification.  
For larger radii, clearance must be added.

TURNING

FOR SPARE PARTS, PLEASE VISIT WIDIA NOVO™ OR WIDIA.COM.

MOUNTING SCREWS ARE NOT INCLUDED IN STANDARD PACKAGING.





M690 • SDEX-ALP • SD1204..

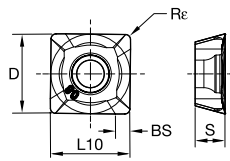

- first choice
- alternate choice

P	■	■	■	●	●	●	○	○	○
M	■	■	○	●	●	●	○	○	○
K	■	■	○	○	○	○	○	○	○
N	■	○	○	○	○	○	○	○	○
S	■	○	○	○	○	○	○	○	○
H	■	○	○	○	○	○	○	○	○

catalog number	cutting edges	D	L10	S	BS	Rε	hm	THM-U	TN6520	TN6525	TN6540	WK15CM	WP35CM	WS30PM	WS40PM
SDEX120408FRALP	4	.500	.504	.187	.060	.031	.001	5281790	■	■	■	■	■	○	○

INDEXABLE MILLING

SOLID END MILLING

HOLE/MAKING

TAPPING

TURNING

M690 SD1204 • Insert Selection Guide

Material Group	Light Machining		General Purpose		Heavy Machining	
	Geometry	Grade	Geometry	Grade	Geometry	Grade
P1-P2	.E..ML	TN6540	.S..MM	TN6540	.S..MH	TN6540
P3-P4	.E..ML	TN6540	.S..MM	TN6540	.S..MH	TN6540
P5-P6	.E..ML	TN6540	.S..MM	TN6540	.S..MH	TN6540
M1-M2	.E..ML	TN6540	.S..MM	TN6540	.S..MH	TN6540
M3	.E..ML	WS40PM	.S..MM	WS40PM	.S..MH	WP35CM
K1-K2	.E..ML	WK15CM	.E..ML	WK15CM	.S..MH	WK15CM
K3	.E..ML	WK15CM	.S..MM	TN6525	.S..MH	TN6525
N1-N2	.ALP	THM-U	.E..ML	THM-U	.S..ML	THM-U
N3	.ALP	THM-U	.E..ML	THM-U	.S..ML	THM-U
S1-S2	.E..ML	TN6540	.S..MM	TN6540	.S..MM	TN6540
S3	.E..ML	TN6540	.S..MM	WS30PM	.S..MM	TN6540
S4	.E..ML	TN6540	.S..MM	WS30PM	.S..MM	TN6540
H1	.S..MM	WS30PM	.S..MM	WS30PM	.S..MM	WS30PM

M690 SD1204 • Recommended Starting Speeds [SFM]

Material Group		TN6520			TN6525			TN6540			WK15CM		
		P	1	-	-	-	1115	870	770	985	770	655	-
	2	-	-	-	870	690	590	690	525	460	-	-	-
	3	-	-	-	770	590	510	590	460	375	-	-	-
	4	-	-	-	640	460	395	490	360	295	-	-	-
	5	-	-	-	855	640	540	655	490	410	-	-	-
	6	-	-	-	560	445	360	445	330	280	-	-	-
M	1	-	-	-	525	330	215	360	215	165	-	-	-
	2	-	-	-	330	215	130	215	130	115	-	-	-
	3	-	-	-	345	215	150	230	130	115	-	-	-
K	1	1230	870	625	755	670	605	605	560	490	1380	1265	1115
	2	1065	690	525	590	525	490	475	425	375	1100	970	900
	3	820	625	445	490	445	395	425	395	345	920	820	755
N	1	-	-	-	-	-	-	-	-	-	-	-	-
	2	-	-	-	-	-	-	-	-	-	-	-	-
	3	-	-	-	-	-	-	-	-	-	-	-	-
S	1	-	-	-	-	-	-	130	100	80	-	-	-
	2	-	-	-	-	-	-	65	50	35	-	-	-
	3	-	-	-	-	-	-	195	115	80	-	-	-
	4	-	-	-	-	-	-	165	80	65	-	-	-
H	1	-	-	-	-	-	-	-	-	-	-	-	-
	2	-	-	-	-	-	-	-	-	-	-	-	-
	3	-	-	-	-	-	-	-	-	-	-	-	-

Material Group		WP35CM			WS30PM			WS40PM			THM-U		
		P	1	1490	1295	1210	-	-	-	-	-	-	-
	2	915	835	750	-	-	-	-	-	-	-	-	
	3	835	750	670	-	-	-	-	-	-	-	-	
	4	620	570	520	-	-	-	-	-	-	-	-	
	5	850	750	685	-	-	-	560	475	395	-	-	
	6	520	440	360	-	-	-	490	360	260	-	-	
M	1	670	605	505	740	655	605	690	560	460	-	-	
	2	605	520	455	670	590	475	590	475	395	-	-	
	3	475	425	375	510	445	345	475	360	280	-	-	
K	1	965	865	785	-	-	-	-	-	-	625	560	490
	2	770	685	620	-	-	-	-	-	-	-	-	-
	3	635	570	520	-	-	-	-	-	-	-	-	-
N	1	-	-	-	-	-	-	-	-	-	6560	3935	3280
	2	-	-	-	-	-	-	-	-	-	4475	2675	2180
	3	-	-	-	-	-	-	-	-	-	2625	1640	1310
S	1	-	-	-	150	130	100	130	115	80	-	-	-
	2	-	-	-	150	130	100	130	115	80	-	-	-
	3	-	-	-	180	150	100	165	130	80	-	-	-
	4	215	160	105	280	195	130	195	165	100	-	-	-
H	1	-	-	-	445	330	245	-	-	-	-	-	-
	2	-	-	-	-	-	-	-	-	-	-	-	-
	3	-	-	-	-	-	-	-	-	-	-	-	-

NOTE: FIRST choice starting speeds are in **bold** type.  
As the average chip thickness increases, the speed should be decreased.

M690 SD1204 • Recommended Starting Feeds [IPT]

Light Machining	General Purpose	Heavy Machining
-----------------	-----------------	-----------------

Insert Geometry	Programmed Feed per Tooth (fz) as a % of Radial Depth of Cut (ae)															Insert Geometry
	5%			10%			20%			30%			40-100%			
.F..ALP	.005	<b>.009</b>	.019	.003	<b>.007</b>	.013	.003	<b>.005</b>	.010	.002	<b>.004</b>	.009	.002	<b>.004</b>	.008	.F..ALP
.E..ML	.005	<b>.014</b>	.022	.003	<b>.010</b>	.016	.003	<b>.007</b>	.012	.002	<b>.006</b>	.010	.002	<b>.006</b>	.010	.E..ML
.S..MM	.005	<b>.016</b>	.027	.003	<b>.012</b>	.020	.003	<b>.009</b>	.015	.002	<b>.008</b>	.013	.002	<b>.007</b>	.012	.S..MM
.S..MH	.009	<b>.021</b>	.033	.007	<b>.015</b>	.024	.005	<b>.011</b>	.018	.004	<b>.010</b>	.016	.004	<b>.009</b>	.014	.S..MH

NOTE: Use "Light Machining" value as starting feed rate.

INDEXABLE MILLING

SOLID END MILLING

HOLE/MAKING

TAPPING

TURNING

INDEXABLE MILLING

SOLID END MILLING

HOLEMAKING

TAPPING

TURNING

M690 • Shell Mills • SD1506 • Inch

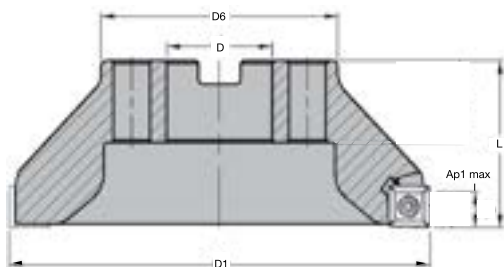

order number	catalog number	D1	D	D6	L	Ap1 max	Z	max RPM	coolant supply	lbs
2646791	M690D300Z06S100SD15	3.000	1.000	2.300	2.000	.500	6	17700	Yes	2.00
2646793	M690D400Z08S150SD15	4.000	1.500	3.100	2.000	.500	8	15800	No	2.70

FOR SPARE PARTS, PLEASE VISIT WIDIA NOVO™ OR WIDIA.COM.

MOUNTING SCREWS ARE NOT INCLUDED IN STANDARD PACKAGING.

M690 • SDMT-ML • SD1506..

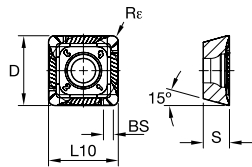
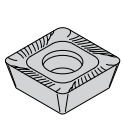

- first choice
- alternate choice

P	■	■	■	■	■	■	■	○	○
M	■	■	○	○	○	○	○	○	○
K	■	■	○	○	○	○	○	○	○
N	■	○	○	○	○	○	○	○	○
S	■	○	○	○	○	○	○	○	○
H	■	○	○	○	○	○	○	○	○

catalog number	cutting edges	D	L10	S	BS	Rε	hm	THM-U	TN6520	TN6525	TN6540	WK15CM	WP35CM	WS30PM	WS40PM
SDMT1506PDRML	4	.625	.625	.249	.043	.047	.003	■	■	■	■	■	■	○	○

M690 • SDMX-MM • SD1506..

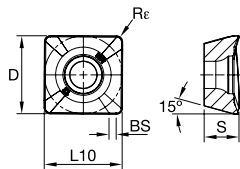

- first choice
- alternate choice

P	■	■	■	■	■	■	○	○
M	■	■	○	○	○	○	○	○
K	■	■	○	○	○	○	○	○
N	■	○	○	○	○	○	○	○
S	■	○	○	○	○	○	○	○
H	■	○	○	○	○	○	○	○

catalog number	cutting edges	D	L10	S	BS	Rε	hm	THM-U	TN6520	TN6525	TN6540	WK15CM	WP35CM	WS30PM	WS40PM
SDMX150612RMM	4	.625	.625	.250	.057	.047	.006	■	■	■	■	■	■	○	○

M690 • SDMT-MH • SD1506..

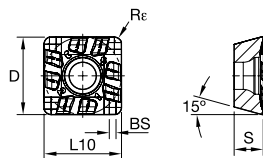

- first choice
- alternate choice

P	■	■	■	■	■	■	○	○
M	■	■	○	○	○	○	○	○
K	■	■	○	○	○	○	○	○
N	■	○	○	○	○	○	○	○
S	■	○	○	○	○	○	○	○
H	■	○	○	○	○	○	○	○

catalog number	cutting edges	D	L10	S	BS	Rε	hm	THM-U	TN6520	TN6525	TN6540	WK15CM	WP35CM	WS30PM	WS40PM
SDMT1506PDRMH	4	.625	.625	.250	.043	.047	.003	■	■	■	■	■	■	○	○



## M690 • SDMX-MM • SD1506..

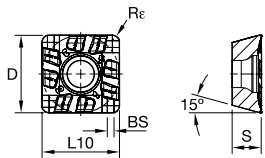

- first choice
- alternate choice

P	●	○	○	○	○	○	○	○	○
M	●	○	○	○	○	○	○	○	○
K	●	○	○	○	○	○	○	○	○
N	○	○	○	○	○	○	○	○	○
S	○	○	○	○	○	○	○	○	○
H	○	○	○	○	○	○	○	○	○

catalog number	cutting edges	D	L10	S	BS	Rε	hm	THM-U	TN6520	TN6525	TN6540	3949811	5427426	WK15CM	WP35CM	WS30PM	WS40PM
SDMX150612RMH	4	.625	.625	.250	.057	.047	.008	●	●	●	○	○	○	○	○	○	○
SDMX150616RMH	4	.625	.625	.250	.059	.063	.008	●	●	●	○	○	○	○	○	○	○

## M690 SD1506 • Insert Selection Guide

Material Group	Light Machining		General Purpose		Heavy Machining	
	Geometry	Grade	Geometry	Grade	Geometry	Grade
P1-P2	.E..ML	TN6540	.S..MM	TN6540	.S..MH	TN6540
P3-P4	.E..ML	TN6540	.S..MM	TN6540	.S..MH	TN6540
P5-P6	.E..ML	TN6540	.S..MM	TN6540	.S..MH	TN6540
M1-M2	.E..ML	TN6540	.S..MM	TN6540	.S..MH	TN6540
M3	.E..ML	TN6540	.S..MM	WP35CM	.S..MH	WP35CM
K1-K2	.E..ML	WK15CM	.E..ML	WK15CM	.S..MH	WK15CM
K3	.E..ML	WK15CM	.S..MM	WK15CM	.S..MH	WK15CM
N1-N2	-	-	-	-	-	-
N3	-	-	-	-	-	-
S1-S2	.E..ML	TN6540	.S..MM	TN6540	.S..MM	TN6540
S3	.E..ML	TN6540	.S..MM	TN6540	.S..MM	TN6540
S4	.E..ML	TN6540	.S..MM	TN6540	.S..MM	TN6540
H1	.S..MM	TN6540	.S..MM	TN6540	.S..MM	TN6540

M690 SD1506 • Recommended Starting Speeds [SFM]

Material Group		TN6520			TN6525			TN6540			WK15CM		
P	1	-	-	-	1115	870	770	985	770	655	-	-	-
	2	-	-	-	870	690	590	690	525	460	-	-	-
	3	-	-	-	770	590	510	590	460	375	-	-	-
	4	-	-	-	640	460	395	490	360	295	-	-	-
	5	-	-	-	855	640	540	655	490	410	-	-	-
	6	-	-	-	560	445	360	445	330	280	-	-	-
M	1	-	-	-	525	330	215	360	215	165	-	-	-
	2	-	-	-	330	215	130	215	130	115	-	-	-
	3	-	-	-	345	215	150	230	130	115	-	-	-
K	1	1230	870	625	755	670	605	605	560	490	1380	1265	1115
	2	1065	690	525	590	525	490	475	425	375	1100	970	900
	3	820	625	445	490	445	395	425	395	345	920	820	755
N	1	-	-	-	-	-	-	-	-	-	-	-	-
	2	-	-	-	-	-	-	-	-	-	-	-	-
	3	-	-	-	-	-	-	-	-	-	-	-	-
S	1	-	-	-	-	-	-	130	100	80	-	-	-
	2	-	-	-	-	-	-	65	50	35	-	-	-
	3	-	-	-	-	-	-	195	115	80	-	-	-
	4	-	-	-	-	-	-	165	80	65	-	-	-
H	1	-	-	-	-	-	-	-	-	-	-	-	-
	2	-	-	-	-	-	-	-	-	-	-	-	-
	3	-	-	-	-	-	-	-	-	-	-	-	-

Material Group		WP35CM			WS30PM			WS40PM			THM-U		
P	1	1490	1295	1210	-	-	-	-	-	-	-	-	-
	2	915	835	750	-	-	-	-	-	-	-	-	-
	3	835	750	670	-	-	-	-	-	-	-	-	-
	4	620	570	520	-	-	-	-	-	-	-	-	-
	5	850	750	685	-	-	-	560	475	395	-	-	-
	6	520	440	360	-	-	-	490	360	260	-	-	-
M	1	670	605	505	740	655	605	690	560	460	-	-	-
	2	605	520	455	670	590	475	590	475	395	-	-	-
	3	475	425	375	510	445	345	475	360	280	-	-	-
K	1	965	865	785	-	-	-	-	-	-	625	560	490
	2	770	685	620	-	-	-	-	-	-	-	-	-
	3	635	570	520	-	-	-	-	-	-	-	-	-
N	1	-	-	-	-	-	-	-	-	-	6560	3935	3280
	2	-	-	-	-	-	-	-	-	-	4475	2675	2180
	3	-	-	-	-	-	-	-	-	-	2625	1640	1310
S	1	-	-	-	150	130	100	130	115	80	-	-	-
	2	-	-	-	150	130	100	130	115	80	-	-	-
	3	-	-	-	180	150	100	165	130	80	-	-	-
	4	215	160	105	280	195	130	195	165	100	-	-	-
H	1	-	-	-	445	330	245	-	-	-	-	-	-
	2	-	-	-	-	-	-	-	-	-	-	-	-
	3	-	-	-	-	-	-	-	-	-	-	-	-

NOTE: FIRST choice starting speeds are in **bold** type.  
As the average chip thickness increases, the speed should be decreased.

M690 SD1506 • Recommended Starting Feeds [IPT]

Light Machining	General Purpose	Heavy Machining
-----------------	-----------------	-----------------

Insert Geometry	Programmed Feed per Tooth (fz) as a % of Radial Depth of Cut (ae)															Insert Geometry
	5%			10%			20%			30%			40-100%			
.E..ML	.007	<b>.019</b>	.032	.005	<b>.014</b>	.023	.004	<b>.010</b>	.017	.003	<b>.009</b>	.015	.003	<b>.008</b>	.014	.E..ML
.S..MM	.008	<b>.021</b>	.035	.006	<b>.015</b>	.025	.004	<b>.011</b>	.019	.004	<b>.010</b>	.016	.003	<b>.009</b>	.015	.S..MM
.S..MH	.009	<b>.023</b>	.037	.007	<b>.017</b>	.027	.005	<b>.013</b>	.020	.004	<b>.011</b>	.017	.004	<b>.010</b>	.016	.S..MH

NOTE: Use "Light Machining" value as starting feed rate.

The VHSC high-speed cutter is designed to perform true high-speed profiling and pocket milling operations on thin-walled aluminum alloy components using heavy feeds and high ramping angles.



Flute engineered for maximum chip evacuation.

Cylindrical shank designed and balanced to G6.3 at 30,000 RPM.

Internal coolant to enable chip evacuation.

Inserts with different radii are held without losing and gauge height of the cutter length.

The VHSC high-speed cutter's proprietary pocket design allows multiple insert radii (R0.4–R6.0) for one body definition while also maintaining axial positioning regardless of the size of the insert corner nose radius. This feature saves time for CNC programmers and operators by removing the step to re-balance and modify the body during the insert change process.

Seven different corner nose radii are available, each with .630" (16mm) axial cutting depth.

### HIGH-SPEED CUTTING INSERTS XDET-ALP FOR NON-FERROUS MATERIALS

FR-ALP



Sharp cutting edge "F" preparation for roughing and finishing jobs.

ER-ALP



Honed cutting edge "E" preparation for heavy roughing jobs and demanding castings.

Finishing Capabilities/Lower Cutting Forces

Geometry Strengthening

### TRUE HSC

Developed to achieve true HSC cutting of aluminum components up to 9843 SFM or 3,000m/min.



# THIN-WALLED ALUMINUM HIGH SPEED CUTTING

## PRODUCT

### SERIES

VHSC

### DIAMETER RANGE

Cylindrical: 1–1.5" (25–32mm)  
 Monoblocks: .9843–1.9685"  
 (25–50mm)  
 Shell Mills: 1.5–3" (40–80mm)

## SHANK TYPES

Cylindrical End Mills  
 Monoblocks  
 Shell Mills

## INDUSTRY



## APPLICATIONS



FACE  
MILLING



RAMPING  
BLANK



HELICAL  
MILLING



POCKETING



SIDE/  
SHOULDER  
MILLING:  
SLOTING:  
SHOULDER



SPIRAL/  
CIRCULAR



3D  
PROFILING

## USER-FRIENDLY SETUP MAKES A BIG DIFFERENCE

### LARGE CORNER RADIUS

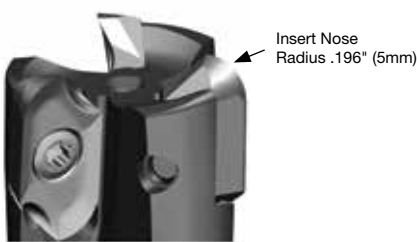

### SMALL CORNER RADIUS

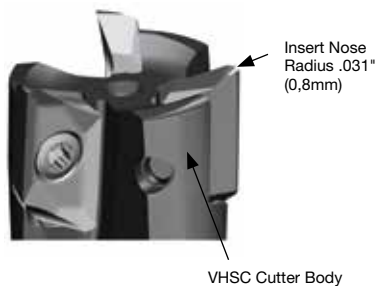

- Unique feature has a great impact on significant cost savings.
- Only one cutter body needed to load inserts with corner nose radii from R.020" to R.236" (R0,4–R0,6mm) max.
- All other suppliers require modification and rebalance of the cutter body.

### INSERT OVERLAY

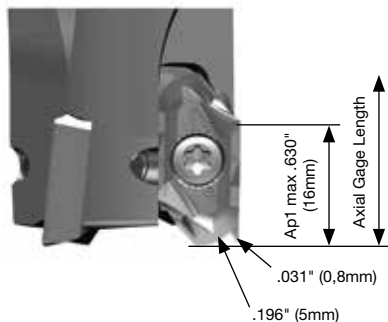

- Axial gage length on the cutter body will always be the same, no matter which insert nose radius is applied.
- Preferred by CNC programmers and operators.
- Ap1 max will always remain .630" (16mm), no matter which insert nose radius is applied.

## VHSC • Shell Mills • Inch

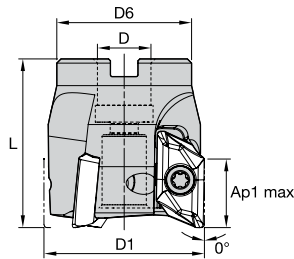

order number	catalog number	D1	D	D6	L	Ap1 max	Z	max ramp angle	max RPM	coolant supply	lbs
6425429	VHSC150Z03S050XD16	1.500	.500	1.260	1.575	.630	3	8.1°	36500	Yes	.34
6630200	VHSC200Z03S075XD16	2.000	.750	1.772	1.575	.630	3	7.8°	30000	Yes	.70
6425430	VHSC200Z04S075XD16	2.000	.750	1.772	1.575	.630	4	7.7°	30000	Yes	.62
6425431	VHSC250Z04S100XD16	2.500	1.000	1.969	1.969	.630	4	5.8°	26000	Yes	1.38
6425432	VHSC300Z05S100XD16	3.000	1.000	1.969	1.969	.630	5	4.6°	23000	Yes	1.78
6425433	VHSC400Z05S125XD16	4.000	1.250	2.441	1.969	.630	5	3.7°	23000	Yes	3.51

NOTE: It is important to change the screw each time the insert is changed to ensure the highest security. A dynamometric key and the correct insert screw torque value are key for VHSC applications. Adjustable torque wrench (order number 6197561) and Torx Plus 20 bit (order number 6205891) may be purchased separately.

## VHSC • Cylindrical End Mills • Inch

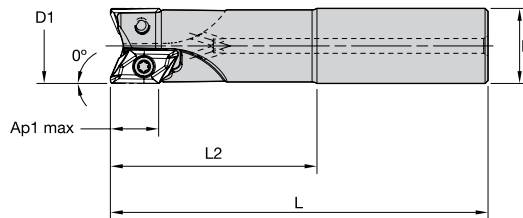

order number	catalog number	D1	D	L	L2	Ap1 max	Z	max ramp angle	max RPM	coolant supply	lbs
6425425	VHSC100Z02C100XD16	1.000	1.000	5.030	2.750	.630	2	14.7°	50000	Yes	.87
6425426	VHSC125Z02C125XD16	1.250	1.250	5.280	2.997	.630	2	11.5°	41500	Yes	1.49
6425427	VHSC125Z03C125XD16	1.250	1.250	5.280	3.000	.630	3	11.5°	41500	Yes	1.39
6425428	VHSC150Z03C150XD16	1.500	1.500	6.030	3.750	.630	3	7.6°	36500	Yes	1.39

NOTE: Pre-balanced to G6.3/30,000 RPM.

NOTE: It is important to change the screw each time the insert is changed to ensure the highest security. A dynamometric key and the correct insert screw torque value are key for HSC applications. Adjustable torque wrench (order number 6197561) and Torx Plus 20 bit (order number 6205891) may be purchased separately.

FOR SPARE PARTS, PLEASE VISIT WIDIA NOVO™ OR WIDIA.COM.

MOUNTING SCREWS ARE NOT INCLUDED IN STANDARD PACKAGING.

VHSC • XDET-ALP

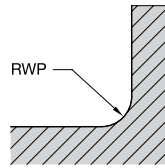
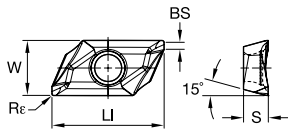

- first choice
- alternate choice

P	■
M	■
K	■
N	■
S	●
H	■

ISO catalog number	ANSI catalog number	cutting edges	LI		S		W		BS		Rc		RWP*		hm		WN10HM
			mm	in	mm	in	mm	in	mm	in	mm	in	mm	in	mm	in	
XDET16M5PDFRALP	XDET16M5PDFRALP	2	22,92	.902	5,00	.197	11,25	.443	1,42	.056	0,30	.010	0,30	.010	0,02	.001	6425772
XDET16M504FRALP	XDET16M504FRALP	2	23,02	.906	5,00	.197	11,25	.443	1,27	.050	0,40	.020	0,40	.020	0,02	.001	6425773
XDET16M508FRALP	XDET16M508FRALP	2	23,02	.906	5,00	.197	11,25	.443	0,87	.034	0,80	.032	0,80	.032	0,02	.001	6425774
XDET16M512FRALP	XDET16M512FRALP	2	23,02	.906	5,00	.197	11,25	.443	0,87	.034	1,24	.049	1,20	.047	—	—	6797599
XDET16M516FRALP	XDET16M516FRALP	2	23,02	.906	5,00	.197	11,25	.443	0,87	.034	1,68	.066	1,60	.063	—	—	6797600
XDET16M520FRALP	XDET16M520FRALP	2	23,02	.906	5,00	.197	11,25	.443	0,58	.023	2,10	.083	2,00	.079	0,02	.001	6425775
XDET16M530ERALP	XDET16M530ERALP	2	23,02	.906	5,00	.197	11,25	.443	0,48	.019	3,10	.123	3,00	.118	0,03	.001	6425776
XDET16M530FRALP	XDET16M530FRALP	2	23,02	.906	5,00	.197	11,25	.443	0,48	.019	3,10	.123	3,00	.118	0,02	.001	6425777
XDET16M540ERALP	XDET16M540ERALP	2	23,02	.906	5,00	.197	11,25	.443	0,60	.023	4,10	.161	4,00	.157	0,03	.001	6425778
XDET16M540FRALP	XDET16M540FRALP	2	23,02	.906	5,00	.197	11,25	.443	0,60	.023	4,10	.161	4,00	.157	0,02	.001	6425779
XDET16M550FRALP	XDET16M550FRALP	2	23,02	.906	5,00	.197	11,25	.443	0,24	.009	5,20	.205	5,00	.197	0,02	.001	6425780

NOTE: RWP\* = Resultant workpiece radius.

INDEXABLE MILLING

SOLID END MILLING

HOLENMAKING

TAPPING

TURNING

## VHSC • Insert Selection Guide

Material Group	Light Machining		General Purpose		Heavy Machining	
	Geometry	Grade	Geometry	Grade	Geometry	Grade
N1-N2	.F..ALP	WN10HM	.F..ALP	WN10HM	.E..ALP	WN10HM
N3	.F..ALP	WN10HM	.F..ALP	WN10HM	.E..ALP	WN10HM

## VHSC • Recommended Starting Speeds [SFM]

Material Group	WN10HM		
	N	1	<b>9640</b>
	2	9640	2860
	3	5230	1565

NOTE: FIRST choice starting speeds are in **bold** type.

As the average chip thickness increases, the speed should be decreased.

## VHSC • Recommended Starting Feeds [IPT]

Light Machining	General Purpose	Heavy Machining
-----------------	-----------------	-----------------

Insert Geometry	Programmed Feed per Tooth (fz) as a % of Radial Depth of Cut (ae)															Insert Geometry
	5%			10%			20%			30%			40-100%			
.F..ALP	.005	.018	.032	.003	.013	.023	.003	.010	.017	.002	.009	.015	.002	.008	.014	.F..ALP
.E..ALP	.006	.020	.037	.004	.014	.027	.003	.011	.020	.003	.009	.017	.003	.009	.016	.E..ALP

NOTE: Use "Light Machining" values as starting feed rate.

### Recommendations for High Speed Machining at 8,000 RPM or above

- Check spindle condition:
  - Runout
  - Clamping of the attachment in traction
  - Marking and cleanliness
- Check that the tool is suitable for the required use.
- Inserts must be locked positively in the pocket and secured using the torx screw provided. The screw must be torqued to the correct value as indicated in the charts on the product pages.
- Because of heavy force to the screw, it is important to change the screw when changing the insert.
- Check the balancing of the assembled tool: cutter body, inserts, and attachment.
- Before start up, note the maximum RPM engraved on the tool. The maximum RPM is linked to a precise balancing value.
- Ensure that the field of application of the tool shown in our technical documents and technological parameters is observed:
 

$A_0$ (inch)	Width of cut, lateral engagement (radial)
$a_p$ (inch)	Axial depth of cut
$f_z$ (IPT/tooth)	Inch per tooth
$n$ (RPM)	Revolutions per minute



### WIDIA™ cannot accept responsibility for misuse of this product due to:

- Non-observance of the above instructions
- Machine without casing
- Incorrect clamping of workpieces
- No safety device on the machine
- Any misuse or incorrect clamping

The optimum rotation must be determined by condition of the spindle. The spindle must be rigid to run at these higher RPMs.

Under no circumstances must any attempt be made to repair this tool. The only permitted maintenance is the indexing or replacement of the inserts.

When assembling the cutter to a Shrink Fit holder, the maximum protrusion cannot exceed 10% of the reach of tool.

### Balancing:

- Cylindrical shank and HSK63A integral shanks are designed and balanced to G6.3 at 30,000 RPM for diameters up to 2".
- Cylindrical shank tools mounted in a Shrink Fit holder or any other chuck mill holder + inserts + screws must be re-inspected for balance as an assembly by the end-user when at or exceeding 8,000 RPM. End-user must balance the assembly at a G6.3 at 30,000 RPM maximum.
- Shell mills are not balanced. These tools must be re-inspected for balance as an assembly, cutter + inserts + screws by the end-user for high speed machining at 8,000 RPM or above. End-user must balance the assembly at a G6.3 value minimum.
- Balancing requires removing some material by drilling or milling operations.
- For each new shell mill installed on the same toolholder, re-balance the assembly.

Tighten the bolt between the shell mill and toolholder, with lubricant, apply the torque value of:

Thread sizes (inch)	Cutter Bore Size (inch)	Torque Values ft. lbs.
.250	.500	7.37
.375	.750	22.12
.500	1.000	36.87
.625	1.250	59.00
.750	1.500	81.13



## Technical Information

### ▼ Machinability by Materials • Aluminum

Alloy Group	Alloy Designation	Chemical Composition Limits (WT%)												Typical Temper	Rm (Mpa)	Machinability Chip Formation	Machinability
		Cu	Si	Fe	Mn	Mg	Zn	Cr	Ti	Pb	Bi	Al	Others				
Al	1050	0.05	0.25	0.40	0.50	0.05	0.05	-	-	-	-	99.50min	-	H14	105	D	A
	1100	0.05-0.20	Si+Fe 1.00 max	-	0.05	-	0.10	-	-	-	-	99.00min	-	H14	90	D	A
AlCu	2011	5.00-6.00	0.40	0.70	-	-	0.30	-	-	0.20	0.60	remaining	-	T3	310	A	A
	2014	3.90-5.00	0.50-1.20	0.70	0.40-1.20	0.20-0.80	0.25	0.10	0.15	-	-	remaining	-	T6	430	B	A
	2017	3.50-4.50	0.20-0.80	0.70	0.40-1.00	0.40-0.80	0.25	0.10	0.15	-	-	remaining	-	T4	390	B	A
	2024	3.80-4.90	0.50	0.50	0.30-0.90	1.20-1.80	0.25	0.10	0.15	-	-	remaining	-	T4	465	B	A
	2218	3.50-4.50	0.90	1	0.20	1.20-1.80	0.25	0.10	-	-	-	remaining	Ni1.7-2.3	T72	331	B	B
	2224	3.80-4.40	0.12	0.15	0.30-0.90	1.20-1.80	0.25	0.10	0.15	-	-	remaining	-	-	-	A	A
AlMn	3003	0.05-0.20	0.60	0.70	1.00-1.50	-	0.10	-	-	-	-	remaining	-	H14	140	D	B
AlSi	4032	0.50-1.30	11.00-13.50	1	-	0.80-1.30	0.25	0.10	-	-	-	remaining	Ni0.5-1.3	T6	379	B	D
AlMg	5083	0.10	0.40	0.40	0.40-1.00	4.00-4.90	0.25	0.05-0.25	0.15	-	-	remaining	-	H112	335	C	A
AlMgSi	6061	0.15-0.40	0.40-0.80	0.70	0.15	0.80-1.20	0.25	0.04-0.35	0.15	-	-	remaining	-	T6	300	C	B
	6063	0.10	0.20-0.60	0.35	0.10	0.45-0.90	0.10	0.10	0.10	-	-	remaining	-	T5	200	C	B
	6070	0.15-0.40	1.00-1.70	0.50	0.40-1.00	0.50-1.20	0.25	0.10	0.15	-	-	remaining	-	T6	379	C	C
	6151	0.35	0.60-1.20	1	0.20	0.45-0.80	0.25	0.15-0.35	0.15	-	-	remaining	-	T6	-	C	C
	6262	0.15-0.40	0.40-0.80	0.70	0.15	0.80-1.20	0.25	0.04-0.14	0.15	0.40	0.70	remaining	-	T9	400	B	B
	6351	0.10	0.70-1.30	0.50	0.40-0.80	0.40-0.80	0.20	-	0.20	-	-	remaining	-	T6	310	D	C
	6463	0.20	0.20-0.60	0.15	0.05	0.45-0.90	0.05	-	-	-	-	remaining	-	T6	241	C	B
AlZn	7001	1.60-2.60	0.35	0.40	0.20	2.60-3.40	6.80-8.00	0.18-0.35	0.20	-	-	remaining	-	O	-	B	A
	7003	0.20	0.30	0.35	0.30	0.50-1.00	5.00-6.50	0.20	0.20	-	-	remaining	Zr0.05-0.25	T5	400	B	A
	7050	2.00-2.60	0.12	0.15	0.10	1.90-2.60	5.70-6.70	0.04	0.06	-	-	remaining	Zr0.08-0.15	T73	530	B	A
	7075	1.20-2.00	0.40	0.50	0.30	2.10-2.90	5.10-6.10	0.18-0.28	0.20	-	-	remaining	-	T6	570	B	A
	7178	1.60-2.40	0.40	0.50	0.30	2.40-3.10	6.30-7.30	0.18-0.35	0.20	-	-	remaining	-	T6	600	B	A
	7475	1.20-1.90	0.10	0.12	0.06	1.90-2.60	5.20-6.20	0.18-0.25	0.06	-	-	remaining	-	T61	565	B	A

Machinability: A (Excellent), B (Good to Excellent), C (Good), D (Not Good)

1. Face milling
2. First choice for deep pocketing and thin wall machining
3. Boring by circular interpolation into full material
4. Ramping
5. Pocketing
6. Slotting
7. Shoulder milling with excellent step-down capability and wall finish

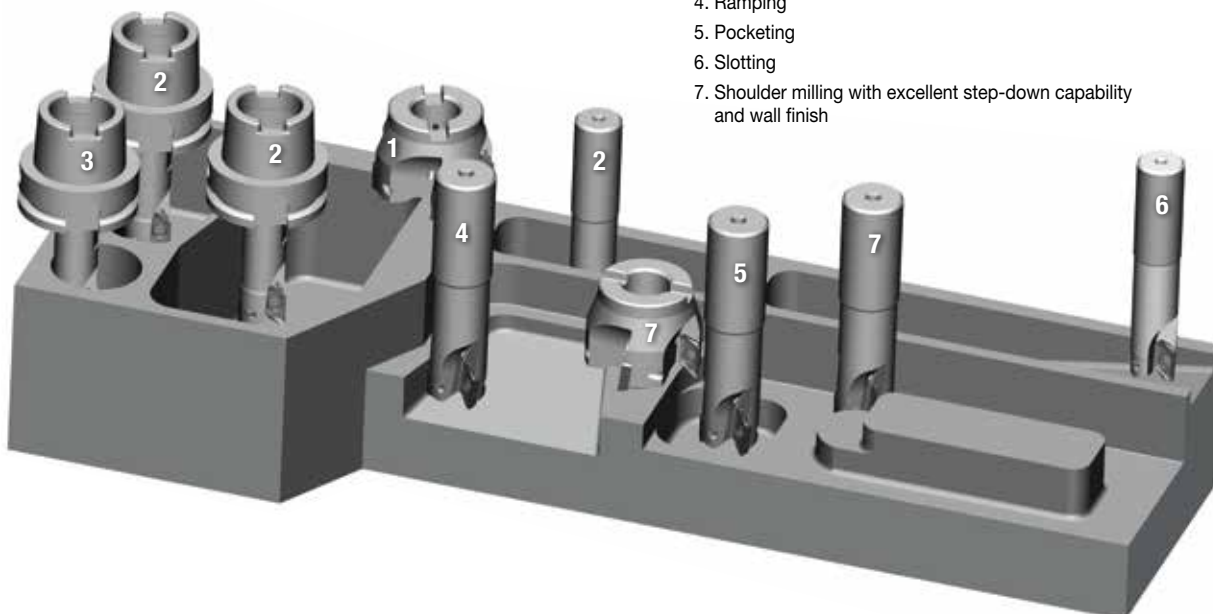

## Best Practices

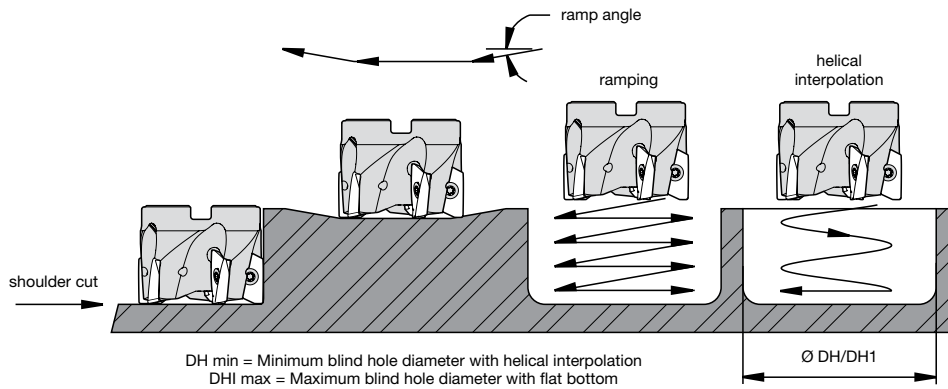

### ▼ Ramp Angle

cutter diameter	Max. Ramping Angle Related to Insert Corner Nose Radius and Cutter D1						
	Facet	R .020	R .032	R .079	R .118	R .157	R .197
1.000	14.8°	14.8°	14.8°	9.2°	18.5°	8.8°	10.9°
1.250	11.5°	11.5°	11.5°	12.1°	12.7°	13.4°	14.0°
1.500	8.1°	8.1°	8.1°	8.5°	8.8°	9.1°	9.5°
2.000	7.7°	7.3°	7.7°	7.5°	7.7°	8.2°	8.8°
2.500	5.8°	5.5°	5.8°	5.6°	5.7°	6.1°	6.3°
3.000	4.6°	4.3°	4.6°	4.5°	4.6°	4.8°	5.0°
4.000	3.3°	3.3°	3.3°	3.2°	3.3°	3.4°	3.5°

### ▼ Helical Min. Hole and Helical Max. Hole

cutter diameter	DH min	DH1 max
1.000	1.193	1.921
1.250	1.693	2.421
1.500	2.193	2.921
2.000	3.193	3.921
2.500	4.193	4.921
3.000	5.193	5.921
4.000	7.193	7.921

### ▼ Ap1 max at Helical Interpolation for 360° Tool Path

cutter diameter	Helical interpolation depth Ap1 max for 360° tool path
1.000	.160
1.250	.160
1.500	.160
2.000	.160
2.500	.160
3.000	.160
4.000	.160

NOTE: Ap max depends on connection with cutter diameter, rigidity of the cutter, rigidity of the machine, and size of the flute.

### ▼ Ap1 max at Full Slotting

cutting diameter (D1)	Number of inserts Z	Ap1 max
1.000	2	.300
1.250	2	.435
1.250	3	.240
1.500	3	.350
2.000	4	.350
2.500	4	.435
3.000	5	.435
4.000	5	.435

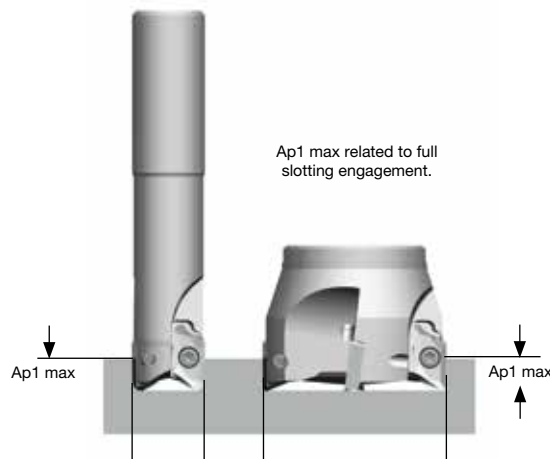

# VXF™ Series

VXF-07, VXF-09, VXF-12, and VXF-16

The VXF Series high-feed mills have a nickel-plated body and four durable cutting edges to run at high feeds in deep cavities on primarily steel, stainless steel, titanium, and high-temp alloys.



**VXF-07**  
Ap1 Max:  
0.0354" (0,9mm)  
Fz Max:  
0.047"/z (1,2mm/z)



**VXF-12**  
Ap1 Max:  
0.1057" (2,5mm)  
Fz Max:  
0.118"/z (3,0mm/z)



**VXF-09**  
Ap1 Max:  
0.0591" (1,5mm)  
Fz Max:  
0.079"/z (2,0mm/z)



**VXF-16**  
Ap1 Max:  
0.1378" (3,5mm)  
Fz Max:  
0.079" (2,0 mm/z)

## ALL-IN-ONE INSERT STYLE COMBINED FROM SQUARE AND ROUND DESIGNS TO ACHIEVE POWERFUL HIGH FEEDS

### VXF-07

-MM

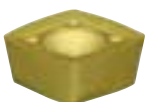

P M S

First choice for soft steel, stainless steel, and high-temp alloys. Best fit for pocketing and profiling operations.

-MH



P K H

First choice for P3 and P4 materials. Stronger edge protection for heavy roughing jobs and hardened steel up to 48 HRC.

### VXF-09

-MM



P M S

First choice for soft steel, stainless steel, and high-temp alloys. Best fit for pocketing and profiling operations.

-MH



P K H

First choice for P3 and P4 materials. Stronger edge protection for heavy roughing jobs.

### VXF-12

-MM

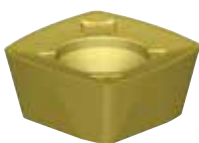

P M S

First choice for soft steel, stainless steel, and high-temp alloys. Best fit for pocketing and profiling operations.

-MH

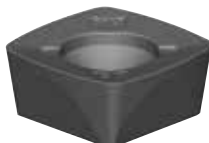

P K H

First choice for P3 and P4 materials. Stronger edge protection for heavy roughing jobs.

### VXF-16

-MM



P M S

First choice for soft steel, stainless steel, and high-temp alloys. Best fit for pocketing and profiling operations.

# HIGH-FEEDS, DEEP CAVITIES

PRODUCT		INSERTS		
SERIES	DIAMETER RANGE	INSERT TYPE	GRADE	MATERIALS
<b>VXF-07</b>	.625–2" (16–50mm)	MM, MH	WP40PM, WS40PM, WP25PM, WU10PM	<b>P M K S H</b>
<b>VXF-09</b>	1–2" (25–63mm)	MM, MH	WS40PM, WP25PM, WP40PM	<b>P M S</b>
<b>VXF-12</b>	1.25–5" (32–100mm)	MM, MH	WS40PM, WP25PM, WP40PM	<b>P M K S H</b>
<b>VXF-16</b>	2–5" (50–125mm)	MM	WS40PM, WP25PM	<b>P M S</b>

## APPLICATIONS



FACE  
MILLING



3D  
PROFILING



POCKETING



HELICAL  
MILLING



RAMPING  
BLANK



SLOTTING:  
TROCHOIDAL  
MILLING



PLUNGE  
MILLING

## INDUSTRY



TRANSPORTATION



AEROSPACE



ENERGY



GENERAL  
ENGINEERING

# 73.5°

## LEAD ANGLE

redistributes cutting forces in the spindle z-axis direction.

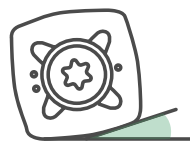

## VXF-07 • Screw-On End Mills • Inch

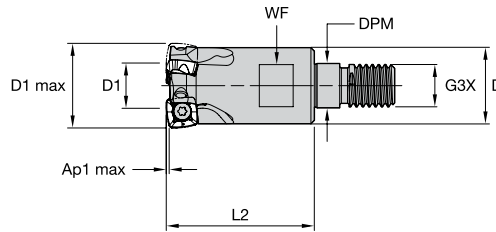

order number	catalog number	D1 max	D1	D	DPM	G3X	L2	WF	Ap1 max	Z	max ramp angle	max RPM	coolant supply	lbs
6712878	VXF075Z03M10XP07	.750	.384	.709	.413	M10	1.378	.589	.035	3	6.7°	57000	Yes	.13
6712879	VXF100Z04M12XP07	1.000	.631	.827	.492	M12	1.378	.667	.035	4	4.3°	49000	Yes	.21
6712880	VXF125Z05M16XP07	1.250	.879	1.142	.669	M16	1.693	.943	.035	5	2.7°	41500	Yes	.48

## VXF-07 • Cylindrical End Mills • Inch

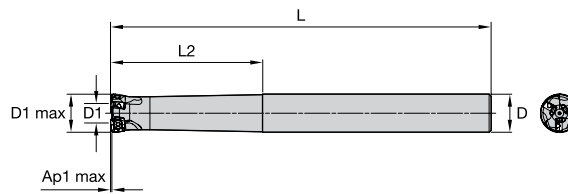

order number	catalog number	D1 max	D1	D	L	L2	Ap1 max	Z	max ramp angle	max RPM	coolant supply	lbs
6712971	VXF062Z02C062XP07L700	.625	.271	.625	7.000	2.500	.035	2	8.2°	65000	Yes	.51
6712972	VXF075Z03C075XP07L750	.750	.384	.750	7.500	3.000	.035	3	6.7°	57000	Yes	.51
6712973	VXF100Z04C100XP07L800	1.000	.631	1.000	8.000	3.500	.035	4	2.2°	49000	Yes	1.56
6712974	VXF125Z05C125XP07L800	1.250	.879	1.250	8.000	3.500	.035	5	2.7°	41500	Yes	2.47

## VXF-07 • Shell Mills • Inch

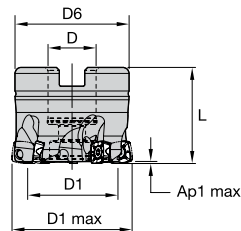

order number	catalog number	D1 max	D1	D	D6	L	Ap1 max	Z	max ramp angle	max RPM	coolant supply	lbs
6712975	VXF150Z05S075XP07	1.500	1.129	.750	1.417	1.260	.035	5	1.0°	35800	Yes	.33
6712976	VXF200Z07S075XP07	2.000	1.629	.750	1.654	1.575	.035	7	.7°	31000	Yes	.80

FOR SPARE PARTS, PLEASE VISIT WIDIA NOVO™ OR WIDIA.COM.

MOUNTING SCREWS ARE NOT INCLUDED IN STANDARD PACKAGING.

VXF-07 • XPPT-MM

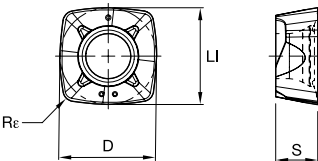

- first choice
- alternate choice

P	●	●	●	●
M	●	●	●	●
K	○	○	○	○
N	○	○	○	○
S	○	○	○	○
H	○	○	○	○

ISO catalog number	ANSI catalog number	cutting edges	LI		S		D		Re		WP25PM	WP40PM	WS40PM	WU10PM
			mm	in	mm	in	mm	in	mm	in				
XPPT070308ERMM	XPPT070308ERMM	4	7,30	.288	3,17	.125	7,30	.288	0,80	.031	6595619	6595620	6595620	

VXF-07 • XPPW-MH

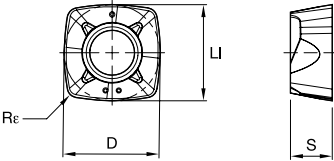
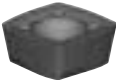

- first choice
- alternate choice

P	●	●	●	●
M	●	●	●	●
K	○	○	○	○
N	○	○	○	○
S	○	○	○	○
H	○	○	○	○

ISO catalog number	ANSI catalog number	cutting edges	LI		S		D		Re		WP25PM	WP40PM	WS40PM	WU10PM
			mm	in	mm	in	mm	in	mm	in				
XPPW070310SRMH	XPPW070310SRMH	4	7,30	.288	3,17	.125	7,30	.288	1,00	.039	6595770	6595769	6595769	

VXF-07 • Insert Selection Guide

Material Group	Light Machining		General Purpose		Heavy Machining	
	Geometry	Grade	Geometry	Grade	Geometry	Grade
P1-P2	XPPT-MM	WP25PM	XPPT-MM	WS40PM	XPPW-MH	WP40PM
P3-P4	XPPT-MM	WP25PM	XPPT-MM	WS40PM	XPPW-MH	WP40PM
P5-P6	XPPT-MM	WP25PM	XPPT-MM	WS40PM	XPPW-MH	WP40PM
M1-M2	XPPT-MM	WS40PM	XPPT-MM	WS40PM	XPPW-MH	WP40PM
M3	XPPT-MM	WS40PM	XPPT-MM	WS40PM	XPPW-MH	WP40PM
K1-K2	XPPW-MH	WU10PM	XPPW-MH	WU10PM	XPPW-MH	WU10PM
K3	XPPW-MH	WU10PM	XPPW-MH	WU10PM	XPPW-MH	WU10PM
S1-S2	XPPT-MM	WP25PM	XPPT-MM	WS40PM	-	-
S3	XPPT-MM	WS40PM	XPPT-MM	WS40PM	-	-
S4	XPPT-MM	WS40PM	XPPT-MM	WS40PM	-	-
H1	XPPW-MH	WU10PM	XPPW-MH	WU10PM	-	-

INDEXABLE MILLING

SOLID END MILLING

HOLE/MAKING

TAPPING

TURNING

## VXF-07 • Recommended Starting Speeds [SFM]

Material Group		WP25PM			WP40PM			WS40PM			WU10PM		
P	1	1295	<b>1115</b>	1065	1165	<b>1015</b>	970	1085	<b>920</b>	785	-	-	-
	2	1085	<b>950</b>	785	985	<b>855</b>	705	900	<b>805</b>	605	-	-	-
	3	1000	<b>855</b>	690	900	<b>770</b>	625	835	<b>705</b>	540	-	-	-
	4	885	<b>720</b>	590	805	<b>675</b>	525	755	<b>625</b>	490	-	-	-
	5	720	<b>675</b>	590	675	<b>605</b>	525	675	<b>575</b>	475	-	-	-
	6	655	<b>490</b>	395	590	<b>460</b>	360	590	<b>425</b>	310	-	-	-
M	1	805	<b>705</b>	655	770	<b>675</b>	605	820	<b>675</b>	560	-	-	-
	2	720	<b>625</b>	510	690	<b>590</b>	490	705	<b>575</b>	475	-	-	-
	3	560	<b>475</b>	375	510	<b>460</b>	360	575	<b>425</b>	330	-	-	-
K	1	900	<b>805</b>	720	-	-	-	-	-	-	1165	<b>1050</b>	950
	2	705	<b>625</b>	590	-	-	-	-	-	-	900	<b>805</b>	755
	3	590	<b>525</b>	475	-	-	-	-	-	-	770	<b>690</b>	625
S	1	165	<b>130</b>	100	165	<b>130</b>	115	165	<b>130</b>	100	-	-	-
	2	165	<b>130</b>	100	165	<b>130</b>	115	165	<b>130</b>	100	-	-	-
	3	195	<b>165</b>	100	195	<b>165</b>	115	195	<b>165</b>	100	-	-	-
	4	280	<b>195</b>	130	260	<b>195</b>	130	230	<b>195</b>	115	-	-	-
H	1	475	<b>360</b>	280	-	-	-	-	-	-	625	<b>510</b>	360

NOTE: FIRST choice starting speeds are in **bold** type.

As the average chip thickness increases, the speed should be decreased.

\*Material groups P, M, K, and H show recommended starting speeds for dry machining. For wet machining, reduce speed by 20%.

\*Material groups N and S show recommended starting speeds for wet machining. Not recommended for dry machining.

## VXF-07 • Recommended Starting Feeds [IPT]

Light Machining	General Purpose	Heavy Machining
-----------------	-----------------	-----------------

### At .024 Axial Depth of Cut (AP1)

Insert Geometry	Recommended Starting Feed per Tooth (Fz) in Relation to % of Radial Engagement (ae)															Insert Geometry
	5%			10%			20%			30%			40-100%			
.E.MM	.020	<b>.058</b>	.109	.014	<b>.039</b>	.067	.010	<b>.028</b>	.047	.009	<b>.025</b>	.041	.008	<b>.022</b>	.037	.E.MM
.S.MH	.036	<b>.080</b>	.141	.025	<b>.052</b>	.080	.019	<b>.037</b>	.056	.016	<b>.032</b>	.048	.015	<b>.029</b>	.043	.S.MH

### At .028 Axial Depth of Cut (AP1)

Insert Geometry	Recommended Starting Feed per Tooth (Fz) in Relation to % of Radial Engagement (ae)															Insert Geometry
	5%			10%			20%			30%			40-100%			
.E.MM	.018	<b>.051</b>	.094	.013	<b>.035</b>	.059	.009	<b>.025</b>	.042	.008	<b>.022</b>	.037	.007	<b>.020</b>	.033	.E.MM
.S.MH	.032	<b>.070</b>	.118	.023	<b>.046</b>	.071	.017	<b>.033</b>	.050	.014	<b>.029</b>	.043	.013	<b>.026</b>	.039	.S.MH

### At .035 Axial Depth of Cut (AP1)

Insert Geometry	Recommended Starting Feed per Tooth (Fz) in Relation to % of Radial Engagement (ae)															Insert Geometry
	5%			10%			20%			30%			40-100%			
.E.MM	.015	<b>.043</b>	.076	.011	<b>.029</b>	.050	.008	<b>.022</b>	.036	.007	<b>.019</b>	.031	.006	<b>.017</b>	.028	.E.MM
.S.MH	.027	<b>.058</b>	.093	.019	<b>.039</b>	.059	.014	<b>.028</b>	.042	.012	<b>.024</b>	.036	.011	<b>.022</b>	.033	.S.MH

NOTE: Use "Light Machining" values as starting feed rate.

VXF-09 • Weldon® End Mills • Inch

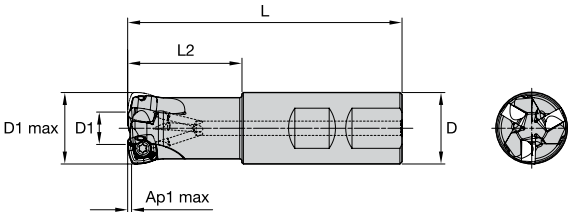
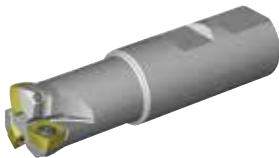

order number	catalog number	D1 max	D1	D	L	L2	Ap1 max	Z	max ramp angle	max RPM	coolant supply	lbs
6597756	VXF100Z03W100XD09	1.000	.462	1.000	3.856	1.575	.059	3	2.7°	48000	Yes	.67
6597757	VXF125Z03W100XD09	1.250	.711	1.000	3.856	1.575	.059	3	1.5°	40500	Yes	.82
6597758	VXF125Z04W100XD09	1.250	.711	1.000	3.856	1.575	.059	4	1.5°	40500	Yes	.82

NOTE: Please order wrench separately.

VXF-09 • Cylindrical End Mills • Inch

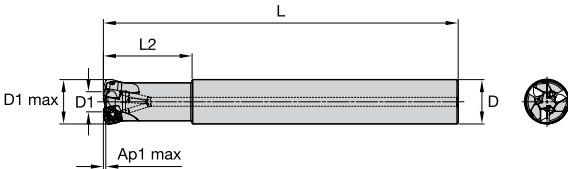

order number	catalog number	D1 max	D1	D	L	L2	Ap1 max	Z	max ramp angle	max RPM	coolant supply	lbs
6597759	VXF100Z02C100XD09L780	1.000	.462	1.000	7.874	1.969	.059	2	2.7°	48000	Yes	1.52
6597760	VXF100Z03C100XD09L780	1.000	.462	1.000	8.000	2.000	.059	3	2.7°	48000	Yes	1.54
6597771	VXF125Z03C125XD09L980	1.250	.711	1.250	9.843	2.756	.059	3	1.5°	40500	Yes	3.03

NOTE: Please order wrench separately.

VXF-09 • Shell Mills • Inch

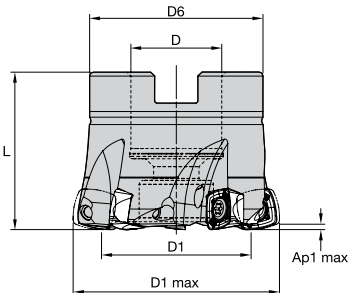

order number	catalog number	D1 max	D1	D	D6	L	Ap1 max	Z	max ramp angle	max RPM	coolant supply	lbs
6597772	VXF150Z04S050XD09	1.500	.960	.500	1.339	1.260	.059	4	1.1°	36000	Yes	.32
6597773	VXF150Z05S050XD09	1.500	.960	.500	1.339	1.260	.059	5	1.1°	36000	Yes	.32
6597774	VXF200Z05S075XD09	2.000	1.458	.750	1.654	1.575	.059	5	.7°	30000	Yes	.76
6597775	VXF200Z06S075XD09	2.000	1.458	.750	1.654	1.575	.059	6	.7°	30000	Yes	.75

NOTE: Please order wrench separately.



## VXF-09 • XDPT-MM

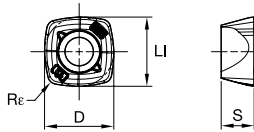

- first choice
- alternate choice

P	●	●	●
M	●	●	●
K	○	○	○
N	○	○	○
S	●	○	●
H	○	○	○

ISO catalog number	ANSI catalog number	cutting edges	LI		S		D		Rε		WP25PM	WP40PM	WS40PM
			mm	in	mm	in	mm	in	mm	in			
XDPT090412ERMM	XDPT090412ERMM	4	10,00	.394	4,76	.187	10,00	.394	1,20	.047	6596471	6596472	6596472

## VXF-09 • XDPT-MH

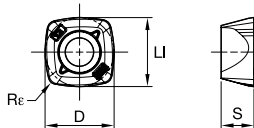

- first choice
- alternate choice

P	●	●	●
M	●	●	●
K	○	○	○
N	○	○	○
S	●	○	●
H	○	○	○

ISO catalog number	ANSI catalog number	cutting edges	LI		S		D		Rε		WP25PM	WP40PM	WS40PM
			mm	in	mm	in	mm	in	mm	in			
XDPT090412SRMH	XDPT090412SRMH	4	10,00	.394	4,76	.187	10,00	.394	1,20	.047	6596822	6596822	6596822

## VXF-09 • Insert Selection Guide

Material Group	Light Machining		General Purpose		Heavy Machining	
	Geometry	Grade	Geometry	Grade	Geometry	Grade
P1-P2	XDPT-MM	WP25PM	XDPT-MM	WS40PM	XDPT-MH	WP40PM
P3-P4	XDPT-MM	WP25PM	XDPT-MM	WS40PM	XDPT-MH	WP40PM
P5-P6	XDPT-MM	WP25PM	XDPT-MM	WS40PM	XDPT-MH	WP40PM
M1-M2	XDPT-MM	WS40PM	XDPT-MM	WS40PM	XDPT-MH	WP40PM
M3	XDPT-MM	WS40PM	XDPT-MM	WS40PM	XDPT-MH	WP40PM
S1-S2	XDPT-MM	WP25PM	XDPT-MM	WS40PM	XDPT-MH	WP40PM
S3	XDPT-MM	WS40PM	XDPT-MM	WS40PM	XDPT-MH	WP40PM
S4	XDPT-MM	WS40PM	XDPT-MM	WS40PM	XDPT-MH	WP40PM

FOR SPARE PARTS, PLEASE VISIT WIDIA NOVO™ OR WIDIA.COM.

MOUNTING SCREWS ARE NOT INCLUDED IN STANDARD PACKAGING.

VXF-09 • Recommended Starting Speeds [SFM]

Material Group		WP25PM			WP40PM			WS40PM		
P	1	1295	<b>1115</b>	1065	1165	<b>1015</b>	970	-	-	-
	2	1085	<b>950</b>	785	985	<b>855</b>	705	-	-	-
	3	1000	<b>855</b>	690	900	<b>770</b>	625	-	-	-
	4	885	<b>720</b>	590	805	<b>675</b>	525	-	-	-
	5	720	<b>675</b>	590	675	<b>605</b>	525	675	<b>575</b>	475
	6	655	<b>490</b>	395	590	<b>460</b>	360	590	<b>425</b>	310
M	1	805	<b>705</b>	655	770	<b>675</b>	605	820	<b>675</b>	560
	2	720	<b>625</b>	510	690	<b>590</b>	490	705	<b>575</b>	475
	3	560	<b>475</b>	375	510	<b>460</b>	360	575	<b>425</b>	330
S	1	165	<b>130</b>	100	165	<b>130</b>	115	165	<b>130</b>	100
	2	165	<b>130</b>	100	165	<b>130</b>	115	165	<b>130</b>	100
	3	195	<b>165</b>	100	195	<b>165</b>	115	195	<b>165</b>	100
	4	280	<b>195</b>	130	260	<b>195</b>	130	230	<b>195</b>	115

NOTE: FIRST choice starting speeds are in **bold** type.  
 As the average chip thickness increases, the speed should be decreased.  
 \*Material groups P, M, K, and H show recommended starting speeds for dry machining. For wet machining, reduce speed by 20%.  
 \*Material groups N and S show recommended starting speeds for wet machining. Not recommended for dry machining.

VXF-09 • Recommended Starting Feeds [IPT]

Light Machining	General Purpose	Heavy Machining
-----------------	-----------------	-----------------

At .035 Axial Depth of Cut (AP1)

Insert Geometry	Recommended Starting Feed per Tooth (Fz) in Relation to % of Radial Engagement (ae)													Insert Geometry		
	5%			10%			20%			30%		40-100%				
.E.MM	.021	<b>.062</b>	.097	.015	<b>.043</b>	.066	.011	<b>.032</b>	.048	.010	<b>.028</b>	.042	.009	<b>.025</b>	.038	.E.MM
.S.MH	.030	<b>.068</b>	.114	.021	<b>.047</b>	.077	.016	<b>.035</b>	.056	.014	<b>.030</b>	.048	.013	<b>.028</b>	.044	.S.MH

At .040 Axial Depth of Cut (AP1)

Insert Geometry	Recommended Starting Feed per Tooth (Fz) in Relation to % of Radial Engagement (ae)													Insert Geometry		
	5%			10%			20%			30%		40-100%				
.E.MM	.018	<b>.053</b>	.083	.013	<b>.038</b>	.057	.010	<b>.028</b>	.042	.009	<b>.024</b>	.036	.008	<b>.022</b>	.033	.E.MM
.S.MH	.026	<b>.058</b>	.097	.019	<b>.041</b>	.067	.014	<b>.030</b>	.049	.012	<b>.026</b>	.042	.011	<b>.024</b>	.038	.S.MH

At .060 Axial Depth of Cut (AP1)

Insert Geometry	Recommended Starting Feed per Tooth (Fz) in Relation to % of Radial Engagement (ae)													Insert Geometry		
	5%			10%			20%			30%		40-100%				
.E.MM	.015	<b>.044</b>	.067	.011	<b>.031</b>	.047	.008	<b>.023</b>	.034	.007	<b>.020</b>	.030	.006	<b>.018</b>	.027	.E.MM
.S.MH	.021	<b>.048</b>	.079	.015	<b>.034</b>	.054	.011	<b>.025</b>	.040	.010	<b>.022</b>	.035	.009	<b>.020</b>	.032	.S.MH

NOTE: Use "Light Machining" values as starting feed rate.

## VXF-12 • Screw-On End Mills • Inch

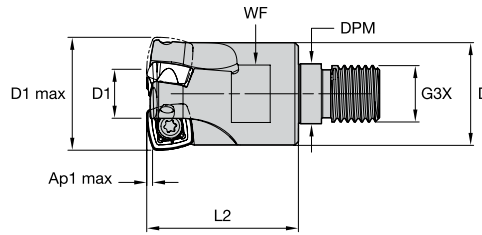

order number	catalog number	D1 max	D1	D	DPM	G3X	L2	WF	Ap1 max	Z	max ramp angle	max RPM	coolant supply	lbs
6733676	VXF125Z03M16XD12	1.250	.537	1.142	.669	M16	1.700	.394	.106	3	2.6°	31500	Yes	.42

NOTE: Please order wrench separately.

## VXF-12 • Cylindrical End Mills • Inch

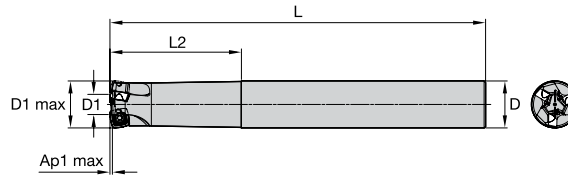

order number	catalog number	D1 max	D1	D	L	L2	Ap1 max	Z	max ramp angle	max RPM	coolant supply	lbs
6733677	VXF125Z03C125XD12L1000	1.250	.537	1.250	10.000	3.500	.098	3	2.6°	31500	Yes	3.09

NOTE: Please order wrench separately.

## VXF-12 • Shell Mills • Inch

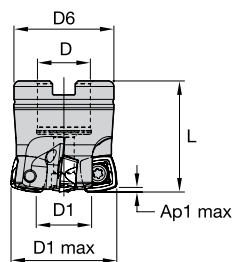

order number	catalog number	D1 max	D1	D	D6	L	Ap1 max	Z	max ramp angle	max RPM	coolant supply	lbs
6596763	VXF150Z04S075XD12	1.500	.785	.750	1.417	1.575	.098	4	1.0°	27500	Yes	.38
6596764	VXF200Z05S075XD12	2.000	1.284	.750	1.811	1.575	.098	5	.9°	22500	Yes	.69
6596765	VXF200Z06S075XD12	2.000	1.284	.750	1.811	1.575	.098	6	.9°	22500	Yes	.72
6596766	VXF250Z05S100XD12	2.500	1.784	1.000	1.969	1.575	.098	5	.6°	19500	Yes	.92
6596767	VXF250Z07S100XD12	2.500	1.784	1.000	1.969	1.575	.098	7	.6°	19500	Yes	.99
6596768	VXF300Z05S100XD12	3.000	2.283	1.000	2.087	1.969	.098	5	.5°	17500	Yes	1.56
6596769	VXF300Z08S100XD12	3.000	2.283	1.000	2.087	1.969	.098	8	.5°	17500	Yes	1.76
6596770	VXF400Z06S125XD12	4.000	3.283	1.250	2.559	1.969	.098	6	.3°	14500	Yes	3.10
6596780	VXF400Z09S125XD12	4.000	3.283	1.250	2.559	1.969	.098	9	.3°	14500	Yes	3.34
6596781	VXF500Z08S150XD12	5.000	4.283	1.500	3.150	2.480	.098	8	.2°	13000	Yes	6.50

NOTE: Please order wrench separately.

FOR SPARE PARTS, PLEASE VISIT WIDIA NOVO™ OR WIDIA.COM.

MOUNTING SCREWS ARE NOT INCLUDED IN STANDARD PACKAGING.

VXF-12 • XDPT-MM

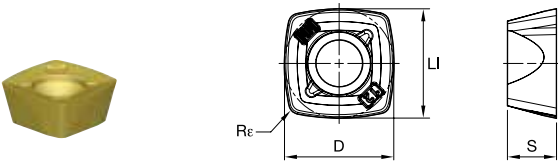

- first choice
- alternate choice

P	●	●	●
M	●	●	●
K	○	○	○
N	○	○	○
S	●	○	○
H	○	○	○

ISO catalog number	ANSI catalog number	cutting edges	LI		S		D		Re		WP25PM	WP40PM	WS40PM
			mm	in	mm	in	mm	in	mm	in			
XDPT120512ERMM	XDPT120512ERMM	4	12,70	.500	5,56	.219	12,70	.500	1,20	.047	6596438	6596439	6596439

VXF-12 • XDPT-MH

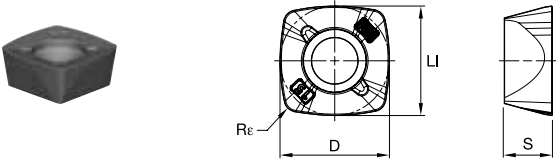

- first choice
- alternate choice

P	●	●	●
M	●	●	●
K	○	○	○
N	○	○	○
S	●	○	○
H	○	○	○

ISO catalog number	ANSI catalog number	cutting edges	LI		S		D		Re		WP25PM	WP40PM	WS40PM
			mm	in	mm	in	mm	in	mm	in			
XDPT120515SRMH	XDPT120515SRMH	4	12,70	.500	5,56	.219	12,70	.500	1,50	.059	6596440	6596440	6596440

VXF-12 • Insert Selection Guide

Material Group	Light Machining		General Purpose		Heavy Machining	
	Geometry	Grade	Geometry	Grade	Geometry	Grade
P1-P2	XDPT-MM	WP25PM	XDPT-MM	WS40PM	XDPT-MH	WP40PM
P3-P4	XDPT-MM	WP25PM	XDPT-MM	WS40PM	XDPT-MH	WP40PM
P5-P6	XDPT-MM	WP25PM	XDPT-MM	WS40PM	XDPT-MH	WP40PM
M1-M2	XDPT-MM	WS40PM	XDPT-MM	WS40PM	XDPT-MH	WP40PM
M3	XDPT-MM	WS40PM	XDPT-MM	WS40PM	XDPT-MH	WP40PM
S1-S2	XDPT-MM	WP25PM	XDPT-MM	WS40PM	XDPT-MH	WP40PM
S3	XDPT-MM	WS40PM	XDPT-MM	WS40PM	XDPT-MH	WP40PM
S4	XDPT-MM	WS40PM	XDPT-MM	WS40PM	XDPT-MH	WP40PM

INDEXABLE MILLING

SOLID END MILLING

HOLE/MAKING

TAPPING

TURNING

## VXF-12 • Recommended Starting Speeds [SFM]

Material Group		WP25PM			WP40PM			WS40PM		
P	1	1295	<b>1115</b>	1065	1165	<b>1015</b>	970	-	-	-
	2	1085	<b>950</b>	785	985	<b>855</b>	705	-	-	-
	3	1000	<b>855</b>	690	900	<b>770</b>	625	-	-	-
	4	885	<b>720</b>	590	805	<b>675</b>	525	-	-	-
	5	720	<b>675</b>	590	675	<b>605</b>	525	675	<b>575</b>	475
	6	655	<b>490</b>	395	590	<b>460</b>	360	590	<b>425</b>	310
M	1	805	<b>705</b>	655	770	<b>675</b>	605	820	<b>675</b>	560
	2	720	<b>625</b>	510	690	<b>590</b>	490	705	<b>575</b>	475
	3	560	<b>475</b>	375	510	<b>460</b>	360	575	<b>425</b>	330
S	1	165	<b>130</b>	100	165	<b>130</b>	115	165	<b>130</b>	100
	2	165	<b>130</b>	100	165	<b>130</b>	115	165	<b>130</b>	100
	3	195	<b>165</b>	100	195	<b>165</b>	115	195	<b>165</b>	100
	4	280	<b>195</b>	130	260	<b>195</b>	130	230	<b>195</b>	115

NOTE: FIRST choice starting speeds are in **bold** type.  
 As the average chip thickness increases, the speed should be decreased.  
 \*Material groups P, M, K, and H show recommended starting speeds for dry machining. For wet machining, reduce speed by 20%.  
 \*Material groups N and S show recommended starting speeds for wet machining. Not recommended for dry machining.

## VXF-12 • Recommended Starting Feeds [IPT]

Light Machining	General Purpose	Heavy Machining
-----------------	-----------------	-----------------

At .055 Axial Depth of Cut (AP1)

Insert Geometry	Recommended Starting Feed per Tooth (Fz) in Relation to % of Radial Engagement (ae)															Insert Geometry
	5%			10%			20%			30%			40-100%			
.E..MM	.020	<b>.058</b>	.109	.014	<b>.039</b>	.067	.010	<b>.028</b>	.047	.009	<b>.025</b>	.041	.008	<b>.022</b>	.037	.E..MM
.S..MH	.036	<b>.080</b>	.141	.025	<b>.052</b>	.080	.019	<b>.037</b>	.056	.016	<b>.032</b>	.048	.015	<b>.029</b>	.043	.S..MH

At .070 Axial Depth of Cut (AP1)

Insert Geometry	Recommended Starting Feed per Tooth (Fz) in Relation to % of Radial Engagement (ae)															Insert Geometry
	5%			10%			20%			30%			40-100%			
.E..MM	.018	<b>.051</b>	.094	.013	<b>.035</b>	.059	.009	<b>.025</b>	.042	.008	<b>.022</b>	.037	.007	<b>.020</b>	.033	.E..MM
.S..MH	.032	<b>.070</b>	.118	.023	<b>.046</b>	.071	.017	<b>.033</b>	.050	.014	<b>.029</b>	.043	.013	<b>.026</b>	.039	.S..MH

At .100 Axial Depth of Cut (AP1)

Insert Geometry	Recommended Starting Feed per Tooth (Fz) in Relation to % of Radial Engagement (ae)															Insert Geometry
	5%			10%			20%			30%			40-100%			
.E..MM	.015	<b>.043</b>	.076	.011	<b>.029</b>	.050	.008	<b>.022</b>	.036	.007	<b>.019</b>	.031	.006	<b>.017</b>	.028	.E..MM
.S..MH	.027	<b>.058</b>	.093	.019	<b>.039</b>	.059	.014	<b>.028</b>	.042	.012	<b>.024</b>	.036	.011	<b>.022</b>	.033	.S..MH

NOTE: Use "Light Machining" values as starting feed rate.

VXF-16 • Shell Mills • Inch

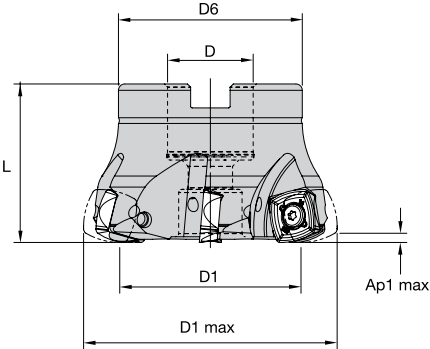

order number	catalog number	D1 max	D1	D	D6	L	Ap1 max	Z	max ramp angle	max RPM	coolant supply	lbs
6597783	VXF200Z04S075XE16	2.000	1.103	.750	1.772	1.772	.138	4	1.4°	24800	Yes	.72
6597784	VXF250Z05S100XE16	2.500	1.602	1.000	1.969	1.575	.138	5	1.0°	21200	Yes	.79
6597785	VXF300Z06S100XE16	3.000	2.102	1.000	2.087	1.969	.138	6	.7°	18900	Yes	1.61
6597788	VXF400Z07S150XE16	4.000	3.100	1.500	3.189	2.480	.138	7	.5°	15800	Yes	4.35
6597789	VXF500Z10S150XE16	5.000	4.099	1.500	3.307	2.480	.138	10	.4°	13900	Yes	6.39

INDEXABLE MILLING

SOLID END MILLING

HOLE/MAKING

TAPPING

TURNING

FOR SPARE PARTS, PLEASE VISIT WIDIA NOVO™ OR WIDIA.COM.  
MOUNTING SCREWS ARE NOT INCLUDED IN STANDARD PACKAGING.

INDEXABLE MILLING

## VXF-16 • XEPT-MM

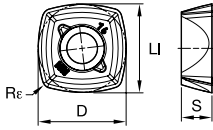

- first choice
- alternate choice

P	●	●
M	●	●
K	○	○
N	○	○
S	●	●
H	○	○

SOLID END MILLING

ISO catalog number	ANSI catalog number	cutting edges	Li		S		D		Re		WP25PM	WS40PM
			mm	in	mm	in	mm	in	mm	in		
XEPT160516ERMM	XEPT160516ERMM	4	16,00	.630	5,56	.219	16,00	.630	1,60	.064	6596823	6596824

HOLEMAKING

TAPPING

TURNING

VXF-16 • Insert Selection Guide

Material Group	Light Machining		General Purpose		Heavy Machining	
	Geometry	Grade	Geometry	Grade	Geometry	Grade
P1-P2	XEPT-MM	WP25PM	XEPT-MM	WS40PM	XEPT-MM	WS40PM
P3-P4	XEPT-MM	WP25PM	XEPT-MM	WS40PM	XEPT-MM	WS40PM
P5-P6	XEPT-MM	WP25PM	XEPT-MM	WS40PM	XEPT-MM	WS40PM
M1-M2	XEPT-MM	WS40PM	XEPT-MM	WS40PM	XEPT-MM	WS40PM
M3	XEPT-MM	WS40PM	XEPT-MM	WS40PM	XEPT-MM	WS40PM
S1-S2	XEPT-MM	WP25PM	XEPT-MM	WS40PM	XEPT-MM	WS40PM
S3	XEPT-MM	WS40PM	XEPT-MM	WS40PM	XEPT-MM	WS40PM
S4	XEPT-MM	WS40PM	XEPT-MM	WS40PM	XEPT-MM	WS40PM

VXF-16 • Recommended Starting Speeds [SFM]

Material Group		WP25PM		WS40PM		
P	1	1295	<b>1115</b>	1065	-	-
	2	1085	<b>950</b>	785	-	-
	3	1000	<b>855</b>	690	-	-
	4	885	<b>720</b>	590	-	-
	5	720	<b>675</b>	590	675	475
	6	655	<b>490</b>	395	590	425
M	1	805	<b>705</b>	655	820	675
	2	720	<b>625</b>	510	705	575
	3	560	<b>475</b>	375	575	425
S	1	165	<b>130</b>	100	165	130
	2	165	<b>130</b>	100	165	130
	3	195	<b>165</b>	100	195	165
	4	280	<b>195</b>	130	230	195

NOTE: FIRST choice starting speeds are in **bold** type.  
 As the average chip thickness increases, the speed should be decreased.  
 \*Material groups P, M, K, and H show recommended starting speeds for dry machining. For wet machining, reduce speed by 20%.  
 \*Material groups N and S show recommended starting speeds for wet machining. Not recommended for dry machining.

VXF-16 • Recommended Starting Feeds [IPT]

Light Machining	General Purpose	Heavy Machining
-----------------	-----------------	-----------------

At .080 Axial Depth of Cut (Ap1)

Insert Geometry	Recommended Starting Feed per Tooth (Fz) in Relation to % of Radial Engagement (ae)														Insert Geometry	
	5%		10%		20%		30%		40-100%							
.E.MM	.016	<b>.051</b>	.086	.011	<b>.036</b>	.061	.009	<b>.027</b>	.045	.007	<b>.024</b>	.039	.007	<b>.022</b>	.036	.E.MM

At .100 Axial Depth of Cut (Ap1)

Insert Geometry	Recommended Starting Feed per Tooth (Fz) in Relation to % of Radial Engagement (ae)														Insert Geometry	
	5%		10%		20%		30%		40-100%							
.E.MM	.014	<b>.046</b>	.077	.010	<b>.033</b>	.055	.008	<b>.024</b>	.041	.007	<b>.021</b>	.036	.006	<b>.019</b>	.032	.E.MM

At .140 Axial Depth of Cut (Ap1)

Insert Geometry	Recommended Starting Feed per Tooth (Fz) in Relation to % of Radial Engagement (ae)														Insert Geometry	
	5%		10%		20%		30%		40-100%							
.E.MM	.012	<b>.039</b>	.066	.009	<b>.028</b>	.047	.007	<b>.021</b>	.035	.006	<b>.018</b>	.030	.005	<b>.017</b>	.028	.E.MM

NOTE: Use "Light Machining" values as starting feed rate.



## Best Practices

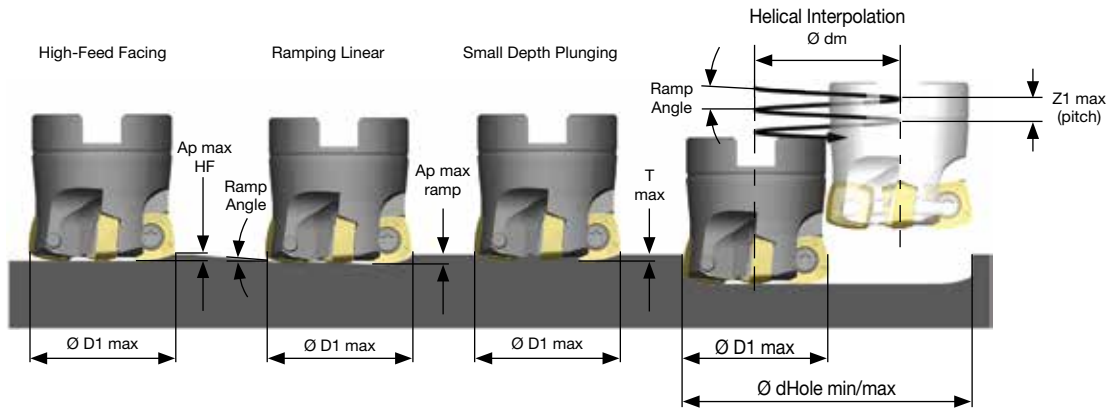

series	D1 max	High-feed Facing	Ramping Linear		Helical Interpolation			Small Depth Plunging	
		Ap max HF	Ramp Angle max	Ap max Ramp	Ramp Angle max	d Hole min	d Hole max	Z1 max Helical	T max
VXF-07	.625	.024	8.2	.024	8.2	.850	1.170	.024	.018
	.750	.024	6.7	.024	6.7	1.100	1.420	.024	.018
	1.000	.024	4.3	.024	4.3	1.600	1.920	.024	.018
	1.250	.024	2.7	.024	2.7	2.100	2.420	.024	.018
	1.500	.024	1.0	.024	1.0	2.550	2.920	.024	.018
	2.000	.024	0.7	.024	0.7	3.400	3.920	.024	.018
VXF-09	1.000	.035	2.7	.039	2.7	1.370	1.920	.039	.025
	1.250	.035	1.5	.039	1.5	1.870	2.420	.039	.025
	1.500	.035	1.1	.039	1.1	2.370	2.920	.039	.025
	2.000	.035	0.7	.039	0.7	3.370	3.920	.039	.025
VXF-12	1.500	.051	1.0	.070	1.0	2.130	2.920	.070	.031
	2.000	.051	0.9	.070	0.9	3.130	3.920	.070	.031
	2.500	.051	0.6	.070	0.6	4.130	4.920	.070	.031
	3.000	.051	0.5	.070	0.5	5.130	5.920	.070	.031
	4.000	.051	0.3	.070	0.3	7.130	7.920	.070	.031
	5.000	.051	0.2	.070	0.2	9.130	9.920	.070	.031
VXF-16	2.000	.080	1.4	.100	1.4	3,000	4,000	.100	.027
	2.500	.080	1.0	.100	1.0	4,000	5,000	.100	.027
	3.000	.080	0.7	.100	0.7	5,000	6,000	.100	.027
	4.000	.080	0.5	.100	0.5	7,000	8,000	.100	.027
	5.000	.080	0.4	.100	0.4	8,820	9,920	.100	.027

$\varnothing dm = \varnothing Hole - \varnothing D1 \text{ max}$

$Z1 = \varnothing dm \times 3,14 \times \tan \text{ramp angle}$ ,  $Z1 \leq Z1 \text{ max}$  and  $\leq \text{ramp angle max}$

$\text{Ramp angle} = \arctan \left( \frac{Z1}{\varnothing dm \times 3,14} \right)$

series	D1 max	X
VXF-07	.625–2.000	.165
VXF-09	1.000–2.000	.268
VXF-12	1.250–5.000	.358
VXF-16	2.000–5.000	.449

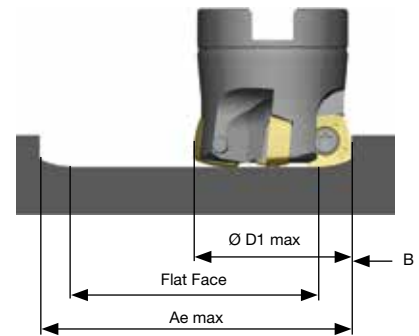

$Ae \text{ max} \leq 2 \times \varnothing D1 \text{ max} - 2 \times B$   
 $\text{Flat Face} = Ae \text{ max} - 2 \times B$

### Z-Axis Plunge Milling

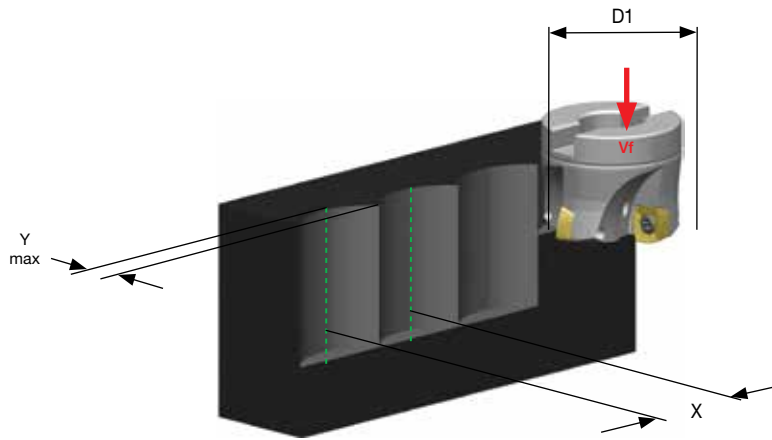

VXF-07			VXF-09			VXF-12			VXF-16		
D1 max	Y max	X	D1 max	Y max	X	D1 max	Y max	X	D1 max	Y max	X
.625	0.118	0.489	1.000	0.236	0.849	1.250	.354	-	2.000	0.512	1.746
.750	0.118	0.546	1.250	0.236	0.978	1.500	.354	1.274	2.500	0.512	2.018
1.000	0.118	0.645	1.500	0.236	1.092	2.000	.354	1.527	3.000	0.512	2.257
1.250	0.118	0.731	2.000	0.236	1.290	2.500	.354	1.743	4.000	0.512	2.673
1.500	0.118	0.808				3.000	.354	1.936	5.000	0.512	3.032
2.000	0.118	0.942				4.000	.354	2.272			
						5.000	.354	2.565			

### Feed Rate Guide • Z-Axis Plunge Milling • fz (IPT)

Light Machining	General Purpose	Heavy Machining
-----------------	-----------------	-----------------

	Insert Geometry	Recommended Starting Feed per Tooth (Fz)			Insert Geometry	Y max
		Light Machining	General Purpose	Heavy Machining		
VXF-07	.E..MM	.002	.006	-	.E..MM	.118
	.S..MH	.004	.008	-	.S..MH	.118
VXF-09	.E..MM	.003	.008	.012	.E..MM	.236
	.S..MH	.004	.009	.014	.S..MH	.236
VXF-12	.E..MM	.003	.008	.012	.E..MM	.354
	.S..MH	.004	.010	.015	.S..MH	.354
VXF-16	.E..MM	.003	.009	.015	.E..MM	.512

### CAM Programming

Programming Data			
insert size	insert radius	R (to be programmed)	t
07	1/32	0.055	0.016
	1	0.059	0.017
09	1/32	0.078	0.028
	3/64	0.091	0.026
12	3/64	0.106	0.038
	1.5	0.110	0.037
16	3/64	0.165	0.057

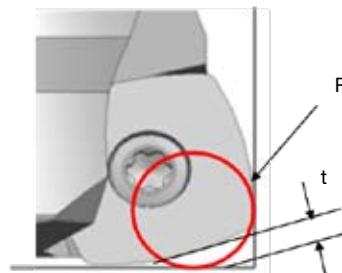

## Cylindrical Shank Extensions for Modular Heads • Inch

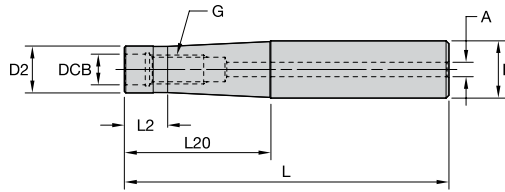

order number	catalog number	DCB	G	D	D2	A	L	L2	L20
5673704	M-13-M8-CA.625-3.543	.335	M8	.625	.512	.158	3.543	—	1.600
5673705	M-13-M8-CA.625-4.331	.335	M8	.625	.512	.158	4.331	—	2.500
5672833	M-13-M8-CA.625-6.693	.335	M8	.625	.512	.158	6.693	—	4.750
5672470	M-18-M10-CA.750-4.331	.413	M10	.750	.709	.158	4.331	—	2.500
5672834	M-18-M10-CA.750-5.118	.413	M10	.750	.709	.158	5.118	—	3.000
5672990	M-18-M10-CA.750-6.693	.413	M10	.750	.709	.158	6.693	—	4.750
5672835	M-21-M12-CA1-5.157	.492	M12	1.000	.827	.157	5.157	.476	3.000
5672991	M-21-M12-CA1-6.142	.492	M12	1.000	.827	.158	6.142	.476	4.000
5673353	M-21-M12-CA1-7.126	.492	M12	1.000	.827	.158	7.126	.476	5.000
5673588	M-21-M12-CA1-8.110	.492	M12	1.000	.827	.158	8.110	.476	6.000
5672471	M-21-M12-CA1-9.094	.492	M12	1.000	.827	.158	9.094	.476	6.992
5672992	M-29-M16-CA1.25-6.3	.669	M16	1.250	1.142	1.969	6.299	.476	4.000
5672836	M-29-M16-CA1.25-8.27	.669	M16	1.250	1.142	.197	8.268	.476	6.000
5672993	M-29-M16-CA1.25-10.2	.669	M16	1.250	1.142	1.969	10.236	.476	8.000
5673706	M-29-M16-CA1.25-12.2	.669	M16	1.250	1.142	.197	12.205	.476	10.000

NOTE: Cylindrical shank extensions can be used with all modular heads found in several product family series.

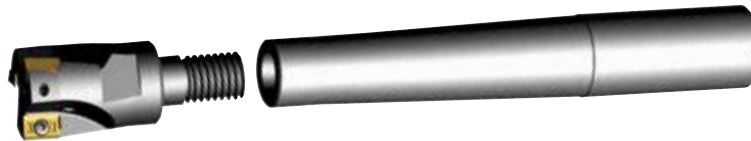

INDEXABLE MILLING

SOLID END MILLING

HOLEMAKING

TAPPING

TURNING

### Solid ER Collets

Threaded solid ER collets turn CNC lathe machines into multitasking machines by providing access of any small diameter screw-on milling cutter to ER driven units.

These new solid ER collets increase machine utilization through modular flexibility.

The short projection from the face of the collet nut provides rigid toolholding and a smaller required machine envelope.

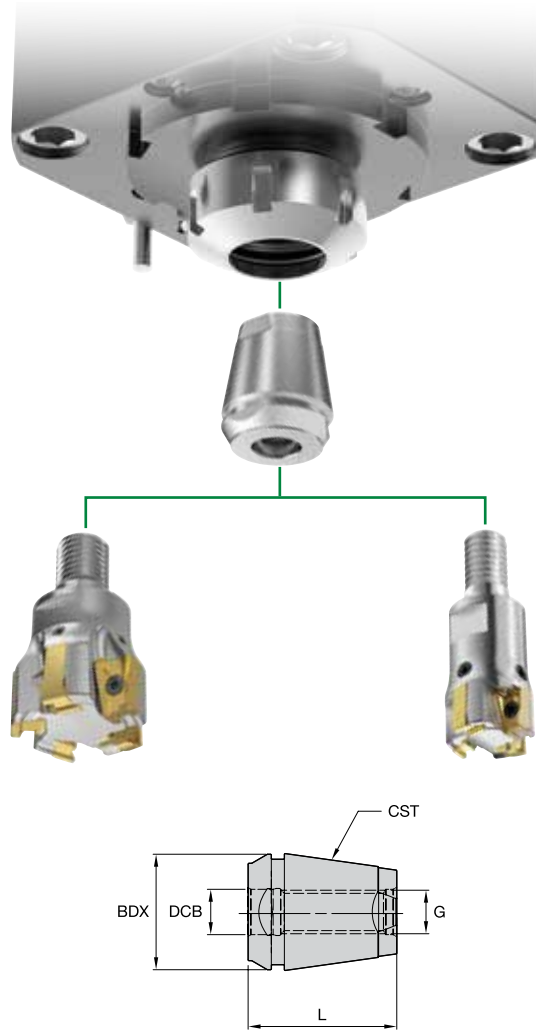

**ERICKSON™**

order number	catalog number	CST	collet capacity min		G	BDX	L
			mm				
6587968	ER25STM08	ER25	9		M8	26	35
6587969	ER25STM10	ER25	11		M10	26	35
6587970	ER25STM12	ER25	13		M12	26	35
6588001	ER32STM08	ER32	9		M8	33	41
6588002	ER32STM10	ER32	11		M10	33	41
6588003	ER32STM12	ER32	13		M12	33	41
6588004	ER32STM16	ER32	17		M16	33	41
6588005	ER40STM08	ER40	9		M8	41	47
6588006	ER40STM10	ER40	11		M10	41	47
6588007	ER40STM12	ER40	13		M12	41	47
6588008	ER40STM16	ER40	17		M16	41	47

INDEXABLE MILLING

SOLID END MILLING

HOLE/MAKING

TAPPING

TURNING

The M370 Series is six-edged high-feed mill designed for high feed rate productivity in steel and cast iron materials.



### IC08 AND IC12 INSERTS OFFERED IN THREE GEOMETRIES

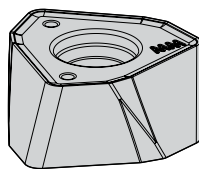

**-MM**



Designed for lower cutting forces. First choice for steel, stainless steel, and high-temp alloys.

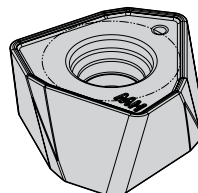

**-MH**



This insert has a strong cutting edge, making it a first choice for hard machining applications up to 48 HRC.



**-MR**



Designed for heavy-duty steel and cast iron applications.

# HIGH-FEED ROUGHING

## PRODUCT

**SERIES**  
M370™

## DIAMETER RANGE

1–3" (25–125mm)

## SHANK TYPES

Screw-On End Mills  
Weldon® End Mills  
Shell Mills

## INDUSTRY



## APPLICATIONS



3D  
PROFILING



SLOTTING:  
SIDE MILLING



SLOTTING:  
SQUARE END



FACE  
MILLING



RAMPING  
BLANK



POCKETING



HELICAL  
MILLING



PLUNGE  
MILLING



THROUGH  
COOLANT:  
RADIAL:  
INDEXABLE  
MILLING



## M370 • Cylindrical End Mills • iC08 • Medium • Inch

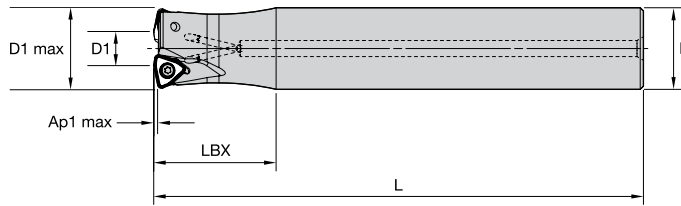

order number	catalog number	D1 max		D1		D		L		LBX		Ap1 max		Z	max ramp angle	max RPM	coolant supply	kg	lbs
		mm	in	mm	in	mm	in	mm	in	mm	in	mm	in						
4047654	M370D100Z02C100WO08L600	25,40	1.000	11,60	.460	25,40	1.000	152,40	6.000	38,10	1.500	1,25	.049	2	2.1	45500	Yes	0,53	1.17
4047655	M370D100Z02C100WO08L800	25,40	1.000	11,60	.460	25,40	1.000	203,20	8.000	38,10	1.500	1,25	.049	2	2.1	45500	Yes	0,73	1.60
4047656	M370D100Z03C100WO08L600	25,40	1.000	11,60	.460	25,40	1.000	152,40	6.000	38,10	1.500	1,25	.049	3	2.1	45500	Yes	0,52	1.16
4047657	M370D125Z03C125WO08L600	31,75	1.250	17,80	.700	31,75	1.250	152,40	6.000	38,10	1.500	1,25	.049	3	1.5	38900	Yes	0,85	1.87
4047658	M370D125Z03C125WO08L800	31,75	1.250	17,80	.700	31,75	1.250	203,20	8.000	38,10	1.500	1,25	.049	3	1.5	38900	Yes	1,16	2.55
4171167	M370D150Z03C125WO08L800	38,10	1.500	24,20	.950	31,70	1.250	195,21	7.686	38,10	1.500	1,25	.049	3	1.5	34500	Yes	2,32	5.11
4171168	M370D150Z04C150WO08L600	38,10	1.500	24,20	.950	38,10	1.500	152,41	6.000	38,10	1.500	1,25	.049	4	1.5	34500	Yes	1,23	2.70

## M370 • Shell Mills • iC08 • Medium • Inch

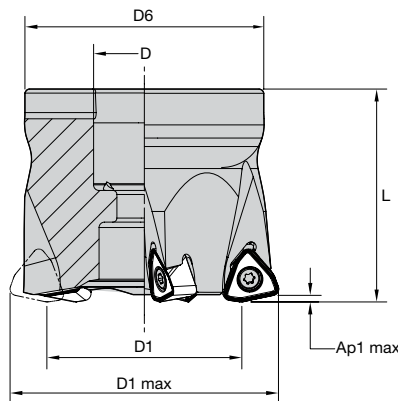

order number	catalog number	D1 max		D1		D		D6		L		Ap1 max		Z	max ramp angle	max RPM	coolant supply	kg	lbs
		mm	in	mm	in	mm	in	mm	in	mm	in	mm	in						
4047660	M370D150Z04S050WO08	38,10	1.500	24,10	.950	12,70	.500	36,00	1.417	40,00	1.575	1,25	.049	4	1.5	34500	Yes	0,19	.41
4047661	M370D200Z05S075WO08	50,80	2.000	36,80	1.450	19,05	.750	44,00	1.732	40,00	1.575	1,25	.049	5	.8	29000	Yes	0,37	.82
4047662	M370D200Z07S075WO08	50,80	2.000	36,80	1.450	19,05	.750	44,00	1.732	40,00	1.575	1,25	.049	7	.8	29000	Yes	0,38	.83
4171169	M370D250Z07S075WO08	63,50	2.500	49,50	1.950	19,05	.750	44,00	1.732	40,00	1.575	1,25	.049	7	.8	29000	Yes	0,64	1.42
4171170	M370D300Z08S100WO08	76,20	3.000	57,70	2.270	25,40	1.000	60,00	2.362	50,00	1.968	1,25	.049	8	.5	22900	Yes	2,19	4.82
6030309	M370D300Z06S100WO08	76,20	3.000	62,20	2.450	25,40	1.000	60,00	2.362	50,00	1.968	1,25	.049	6	.5	22900	Yes	2,23	4.91

NOTE: Socket-head cap screw with coolant groove must be ordered separately.

FOR SPARE PARTS, PLEASE VISIT WIDIA NOVO™ OR WIDIA.COM.

MOUNTING SCREWS ARE NOT INCLUDED IN STANDARD PACKAGING.

M370 • WOEJ-MM • W00804..

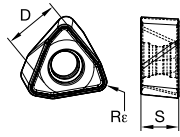
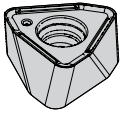

- first choice
- alternate choice

P	●	●	●	●	●	●	●	●	●
M	○	○	○	○	○	○	○	○	○
K	○	○	○	○	○	○	○	○	○
N	○	○	○	○	○	○	○	○	○
S	○	○	○	○	○	○	○	○	○
H	○	○	○	○	○	○	○	○	○

catalog number	cutting edges	D		S		Re		TN6525	TN6540	WK15CM	WP25PM	WP35CM	WP40PM	WS30PM	WS40PM	WU35PM
		mm	in	mm	in	mm	in									
WOEJ080412SRMM	6	7,79	.307	4,70	.185	1,22	.048	4113892	4113915	-	5564597	-	5544753	5520248	6333665	-

M370 • WOEJ-MH • W00804..

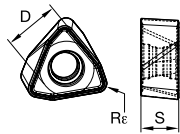
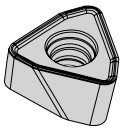

- first choice
- alternate choice

P	●	●	●	●	●	●	●	●	●
M	○	○	○	○	○	○	○	○	○
K	○	○	○	○	○	○	○	○	○
N	○	○	○	○	○	○	○	○	○
S	○	○	○	○	○	○	○	○	○
H	○	○	○	○	○	○	○	○	○

catalog number	cutting edges	D		S		Re		TN6525	TN6540	WK15CM	WP25PM	WP35CM	WP40PM	WS30PM	WS40PM	WU35PM
		mm	in	mm	in	mm	in									
WOEJ080412SRMH	6	7,79	.307	4,75	.187	1,22	.048	4052411	4052410	5427443	5564596	-	5544752	-	6333664	-



## M370 • 08 • Insert Selection Guide

Material Group	Light Machining		General Purpose		Heavy Machining	
	Geometry	Grade	Geometry	Grade	Geometry	Grade
P1-P2	...MM	WP40PM	...MM	WP40PM	...MM	WP40PM
P3-P4	...MM	WP25PM	...MM	WP40PM	...MH	WP40PM
P5-P6	...MM	WP25PM	...MH	WP25PM	...MH	WP40PM
M1-M2	...MM	WP25PM	...MM	WS30PM	...MM	WP40PM
M3	...MM	WP25PM	...MM	WP25PM	...MM	WP40PM
K1-K2	...MH	WK15CM	...MH	WK15CM	...MH	WK15CM
K3	...MH	TN6520	...MH	TN6520	...MH	WK15CM
N1-N2	-	-	-	-	-	-
N3	-	-	-	-	-	-
S1-S2	...MM	WP25PM	...MM	WS30PM	...MM	WP40PM
S3	...MM	WS30PM	...MM	WS30PM	...MM	WP40PM
S4	...MM	WS30PM	...MM	WP40PM	...MM	WP40PM
H1	...MH	WP25PM	-	-	-	-

## M370 • 08 • Recommended Starting Speeds [SFM]

Material Group		TN6525			TN6540			WK15CM			WP25PM			WP35CM			WP40PM			WS30PM			WS40PM			WU35PM		
		1	2	3	1	2	3	1	2	3	1	2	3	1	2	3	1	2	3	1	2	3	1	2	3	1	2	3
P	1	1340	1045	925	1180	925	785	-	-	-	1295	1120	1060	1790	1555	1460	1165	1025	965	-	-	-	-	-	-	850	750	705
	2	1045	830	710	830	630	550	-	-	-	1080	940	785	1105	1000	905	985	845	710	-	-	-	-	-	-	720	620	520
	3	925	710	610	710	550	450	-	-	-	1000	845	690	1000	905	805	905	770	630	-	-	-	-	-	-	655	555	455
	4	770	550	475	590	430	355	-	-	-	890	725	590	750	690	630	805	670	535	-	-	-	-	-	-	590	490	390
	5	1025	770	650	785	590	490	-	-	-	725	670	590	1025	905	830	670	610	535	-	-	-	560	475	395	490	440	390
	6	670	535	430	535	395	335	-	-	-	650	490	395	630	535	430	590	450	355	-	-	-	490	360	260	425	325	260
M	1	630	395	260	430	260	200	-	-	-	805	710	650	805	725	610	770	670	610	890	785	725	690	560	460	555	490	440
	2	395	260	155	260	155	140	-	-	-	725	630	510	725	630	550	690	590	490	805	710	570	590	475	395	505	425	360
	3	415	260	180	275	155	140	-	-	-	550	475	370	570	510	450	510	450	355	610	535	415	475	360	280	375	325	260
K	1	905	805	725	725	670	590	1655	1520	1340	905	805	725	1165	1045	940	-	-	-	-	-	-	-	-	-	-	-	-
	2	710	630	590	570	510	450	1320	1165	1080	710	630	590	925	830	750	-	-	-	-	-	-	-	-	-	-	-	-
	3	590	535	475	510	475	415	1105	985	905	590	535	475	770	690	630	-	-	-	-	-	-	-	-	-	-	-	-
N	1	-	-	-	-	-	-	-	-	-	-	-	-	-	-	-	-	-	-	-	-	-	-	-	-	-	-	-
	2	-	-	-	-	-	-	-	-	-	-	-	-	-	-	-	-	-	-	-	-	-	-	-	-	-	-	-
	3	-	-	-	-	-	-	-	-	-	-	-	-	-	-	-	-	-	-	-	-	-	-	-	-	-	-	-
S	1	-	-	-	155	120	95	-	-	-	155	140	95	-	-	-	155	140	120	180	155	120	130	115	80	110	95	80
	2	-	-	-	80	60	40	-	-	-	155	140	95	-	-	-	155	140	120	180	155	120	130	115	80	110	95	80
	3	-	-	-	235	140	95	-	-	-	200	155	95	-	-	-	200	155	120	215	180	120	165	130	80	145	110	80
	4	-	-	-	200	95	80	-	-	-	275	200	140	260	200	130	260	200	140	335	235	155	195	165	100	195	145	95
H	1	-	-	-	-	-	-	-	-	-	475	355	275	-	-	-	-	-	-	-	-	-	-	-	-	-	-	-
	2	-	-	-	-	-	-	-	-	-	-	-	-	-	-	-	-	-	-	-	-	-	-	-	-	-	-	-
	3	-	-	-	-	-	-	-	-	-	-	-	-	-	-	-	-	-	-	-	-	-	-	-	-	-	-	-

NOTE: FIRST choice starting speeds are in **bold** type.  
As the average chip thickness increases, the speed should be decreased.

## M370 • 08 • Recommended Starting Feeds [IPT]

Light Machining	General Purpose	Heavy Machining
-----------------	-----------------	-----------------

Insert Geometry	Programmed Feed per Tooth (fz) as a % of Radial Depth of Cut (ae)															Insert Geometry
	5%			10%			20%			30%			40-100%			
...MM	.035	<b>.061</b>	.150	.025	<b>.044</b>	.104	.019	<b>.033</b>	.076	.017	<b>.028</b>	.066	.015	<b>.026</b>	.061	...MM
...MH	.035	<b>.092</b>	.197	.025	<b>.065</b>	.134	.019	<b>.048</b>	.098	.017	<b>.042</b>	.085	.015	<b>.038</b>	.078	...MH

NOTE: Use "Light Machining" value as starting feed rate.

M370 • Cylindrical End Mills iC12 • Large • Inch

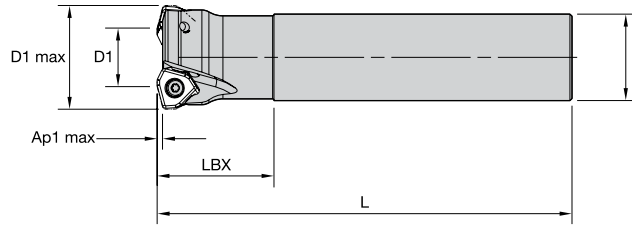

order number	catalog number	D1 max		D1		D		L		LBX		Ap1 max		Z	max		coolant		
		mm	in	mm	in	mm	in	mm	in	mm	in	mm	in		ramp angle	max RPM	supply	kg	lbs
5352394	M370D150Z02C125WO12L600	38,10	1.500	21,27	.837	31,70	1.250	152,40	6.000	42,93	1.690	2,00	.078	2	6.4	22380	Yes	0,87	1.92
5352395	M370D150Z02C150WO12L1000	38,10	1.500	21,27	.837	38,10	1.500	254,00	10.000	63,50	2.500	2,00	.078	2	6.4	22380	Yes	2,04	4.50

M370 • Shell Mills iC12 • Large • Inch

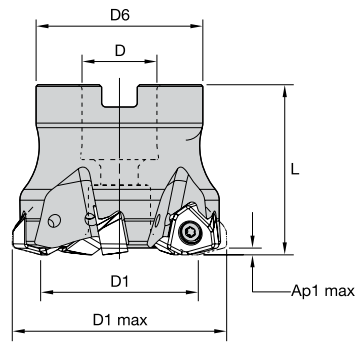

order number	catalog number	D1 max		D1		D		D6		L		Ap1 max		Z	max		coolant		
		mm	in	mm	in	mm	in	mm	in	mm	in	mm	in		ramp angle	max RPM	supply	kg	lbs
5352397	M370D200Z04S075WO12	50,80	2.000	33,91	1.335	19,10	.750	44,45	1.750	40,00	1.575	2,00	.078	4	3.6	19380	Yes	0,31	.69
5698432	M370D200Z04S075WO12L200	50,80	2.000	33,91	1.335	19,10	.750	44,45	1.750	50,79	2.000	2,00	.078	4	3.6	19380	Yes	0,42	.92
5352398	M370D250Z05S075WO12	63,50	2.500	46,59	1.834	19,10	.750	44,45	1.750	44,45	1.750	2,00	.078	5	2.5	17330	Yes	0,48	1.06
5352399	M370D250Z05S100WO12	63,50	2.500	46,59	1.834	25,40	1.000	55,63	2.190	44,45	1.750	2,00	.078	5	2.5	17330	Yes	0,58	1.27
5698433	M370D300Z06S100WO12L197	76,20	3.000	59,14	2.328	25,40	1.000	69,85	2.750	50,04	1.970	2,00	.078	6	1.9	15820	Yes	1,08	2.38
5352420	M370D300Z06S100WO12	76,20	3.000	59,27	2.333	25,40	1.000	69,85	2.750	44,45	1.750	2,00	.078	6	1.9	15820	Yes	0,94	2.08
5352421	M370D300Z05S125WO12	76,20	3.000	59,27	2.333	31,80	1.250	69,85	2.750	50,80	2.000	2,00	.078	5	1.9	15820	Yes	1,05	2.30
5352422	M370D300Z06S125WO12	76,20	3.000	59,27	2.333	31,80	1.250	69,85	2.750	50,80	2.000	2,00	.078	6	1.9	15820	Yes	1,05	2.32
5352423	M370D400Z06S150WO12	101,60	4.000	84,65	3.333	38,10	1.500	92,08	3.625	50,80	2.000	2,00	.078	6	1.3	13700	Yes	1,73	3.81
5352424	M370D400Z08S150WO12	101,60	4.000	84,65	3.333	38,10	1.500	92,08	3.625	50,80	2.000	2,00	.078	8	1.3	13700	Yes	1,75	3.85
5352425	M370D500Z07S150WO12	127,00	5.000	110,05	4.333	38,10	1.500	96,77	3.810	60,33	2.375	2,00	.078	7	1.0	12260	Yes	3,00	6.62
6030307	M370D600Z09S200WO12	152,40	6.000	135,44	5.332	50,80	2.000	127,00	5.000	60,33	2.375	2,00	.078	9	.8	11100	Yes	4,66	10.26

NOTE: Socket-head cap screw with coolant groove and coolant lock screw assembly must be ordered separately.

FOR SPARE PARTS, PLEASE VISIT WIDIA NOVO™ OR WIDIA.COM.

MOUNTING SCREWS ARE NOT INCLUDED IN STANDARD PACKAGING.

## M370 • WOEJ-MM • WO.J1207

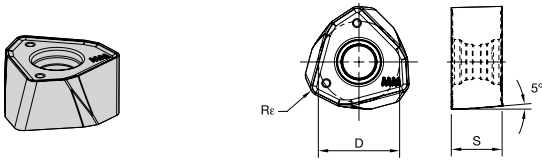

- first choice
- alternate choice

P	●	●	○	○	○	○	○	○	○	○	○
M	○	○	○	○	○	○	○	○	○	○	○
K	○	○	○	○	○	○	○	○	○	○	○
N	○	○	○	○	○	○	○	○	○	○	○
S	○	○	○	○	○	○	○	○	○	○	○
H	○	○	○	○	○	○	○	○	○	○	○

catalog number	cutting edges	D		S		Re		TN6525	TN6540	WK15CM	WP25PM	WP35CM	WP40PM	WS30PM	WS40PM	WU35PM
		mm	in	mm	in	mm	in									
WOEJ120712SRMM	6	12,00	.472	7,30	.287	1,27	.050	●	●	○	○	○	○	○	○	○

## M370 • WOEJ-MH • WO.J1207

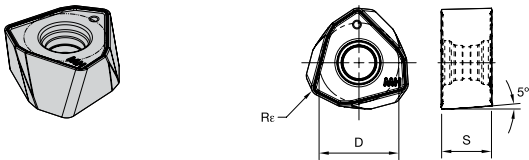

- first choice
- alternate choice

P	●	●	○	○	○	○	○	○	○	○	○
M	○	○	○	○	○	○	○	○	○	○	○
K	○	○	○	○	○	○	○	○	○	○	○
N	○	○	○	○	○	○	○	○	○	○	○
S	○	○	○	○	○	○	○	○	○	○	○
H	○	○	○	○	○	○	○	○	○	○	○

catalog number	cutting edges	D		S		Re		TN6525	TN6540	WK15CM	WP25PM	WP35CM	WP40PM	WS30PM	WS40PM	WU35PM
		mm	in	mm	in	mm	in									
WOEJ120712SRMH	6	12,00	.472	7,30	.287	1,27	.050	●	●	○	○	○	○	○	○	○

## M370 • WOEJ-MR • WO.J1207

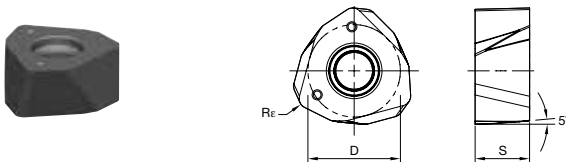

- first choice
- alternate choice

P	●	●	○	○	○	○	○	○	○	○	○
M	○	○	○	○	○	○	○	○	○	○	○
K	○	○	○	○	○	○	○	○	○	○	○
N	○	○	○	○	○	○	○	○	○	○	○
S	○	○	○	○	○	○	○	○	○	○	○
H	○	○	○	○	○	○	○	○	○	○	○

catalog number	cutting edges	D		S		Re		TN6525	TN6540	WK15CM	WP25PM	WP35CM	WP40PM	WS30PM	WS40PM	WU35PM
		mm	in	mm	in	mm	in									
WOEJ120712SRMR	6	12,00	.472	7,100	.280	1,27	.050	●	●	○	○	○	○	○	○	○

M370 • 12 • Insert Selection Guide

Material Group	Light Machining		General Purpose		Heavy Machining	
	Geometry	Grade	Geometry	Grade	Geometry	Grade
P1-P2	...MM	WU35PM	...MM	WP40PM	...MM	WP40PM
P3-P4	...MM	WP25PM	...MM	WP25PM	...MH	WP40PM
P5-P6	...MM	WP25PM	...MM	WP35CM	...MH	WP35CM
M1-M2	...MM	WS30PM	...MM	WU35PM	...MM	WP40PM
M3	...MM	WP25PM	...MM	WP35CM	...MM	WP40PM
K1-K2	...MH	WK15CM	...MH	WK15CM	...MH	WP20CM
K3	...MH	WK15CM	...MH	WK15CM	...MH	WP20CM
N1-N2	-	-	-	-	-	-
N3	-	-	-	-	-	-
S1-S2	...MM	WS30PM	...MM	WU35PM	...MM	WP40PM
S3	...MM	WS30PM	...MM	WU35PM	...MM	WP40PM
S4	...MM	WS30PM	...MM	WU35PM	...MM	WP40PM
H1	...MH	WP35CM	...MR	WP25PM	-	-

M370 • 12 • Recommended Starting Speeds [SFM]

Material Group	TN6525	TN6540	WK15CM	WP25PM	WP35CM	WP40PM	WS30PM	WS40PM	WU35PM
P	1	1340 1045 925	1180 925 785	- - -	1295 1120 1060	1790 1555 1460	1165 1025 965	- - -	850 750 705
	2	1045 830 710	830 630 550	- - -	1080 940 785	1105 1000 905	985 845 710	- - -	720 620 520
	3	925 710 610	710 550 450	- - -	1000 845 690	1000 905 805	905 770 630	- - -	655 555 455
	4	770 550 475	590 430 355	- - -	890 725 590	750 690 630	805 670 535	- - -	590 490 390
	5	1025 770 650	785 590 490	- - -	725 670 590	1025 905 830	670 610 535	- - -	490 440 390
	6	670 535 430	535 395 335	- - -	650 490 395	630 535 430	590 450 355	- - -	425 325 260
M	1	630 395 260	430 260 200	- - -	805 710 650	805 725 610	770 670 610	890 785 725	690 560 460
	2	395 260 155	260 155 140	- - -	725 630 510	725 630 550	690 590 490	805 710 570	590 475 395
	3	415 260 180	275 155 140	- - -	550 475 370	570 510 450	510 450 355	610 535 415	475 360 280
K	1	905 805 725	725 670 590	1655 1520 1340	905 805 725	1165 1045 940	- - -	- - -	- - -
	2	710 630 590	570 510 450	1320 1165 1080	710 630 590	925 830 750	- - -	- - -	- - -
	3	590 535 475	510 475 415	1105 985 905	590 535 475	770 690 630	- - -	- - -	- - -
N	1	- - -	- - -	- - -	- - -	- - -	- - -	- - -	- - -
	2	- - -	- - -	- - -	- - -	- - -	- - -	- - -	- - -
	3	- - -	- - -	- - -	- - -	- - -	- - -	- - -	- - -
S	1	- - -	155 120 95	- - -	155 140 95	- - -	155 140 120	180 155 120	130 115 80
	2	- - -	80 60 40	- - -	155 140 95	- - -	155 140 120	180 155 120	130 115 80
	3	- - -	235 140 95	- - -	200 155 95	- - -	200 155 120	215 180 120	165 130 80
	4	- - -	200 95 80	- - -	275 200 140	260 200 130	260 200 140	335 235 155	195 165 100
H	1	- - -	- - -	- - -	475 355 275	- - -	- - -	- - -	- - -
	2	- - -	- - -	- - -	- - -	- - -	- - -	- - -	- - -
	3	- - -	- - -	- - -	- - -	- - -	- - -	- - -	- - -

NOTE: FIRST choice starting speeds are in bold type.  
As the average chip thickness increases, the speed should be decreased.

M370 • 12 • Recommended Starting Feeds [IPT]

Light Machining	General Purpose	Heavy Machining
-----------------	-----------------	-----------------

Insert Geometry	Programmed Feed per Tooth (fz) as a % of Radial Depth of Cut (ae)															Insert Geometry
	5%			10%			20%			30%			40-100%			
...MM	.035	<b>.073</b>	.143	.026	<b>.052</b>	.099	.019	<b>.039</b>	.073	.017	<b>.034</b>	.063	.015	<b>.031</b>	.058	...MM
...MH	.035	<b>.093</b>	.196	.026	<b>.066</b>	.134	.019	<b>.049</b>	.098	.017	<b>.042</b>	.085	.015	<b>.039</b>	.077	...MH
...MR	.035	<b>.111</b>	.214	.026	<b>.078</b>	.145	.019	<b>.057</b>	.106	.017	<b>.050</b>	.092	.015	<b>.046</b>	.084	...MR

NOTE: Use "Light Machining" value as starting feed rate.

# M100™ Series

M100 IC06, M100 IC10, M100 IC12, M100 IC16, M100 IC18 Copy Mills

The M100 copy mill is a reliable multipurpose solution for copy milling, face milling, helical interpolation, and roughing. The strong and rigid body design paired with the thick inserts ensures consistent results in even the most demanding operations.

Thick inserts paired with the rigid body design provide rigidity and consistency.

Anti-rotation systems in the larger iC inserts provide stability to allow for higher depth of cuts.

Large chip gashes and through tool coolant capabilities provide smooth and increased chip evacuation.



The M100 copy mill is equipped with thick inserts, rigid body design, and anti-rotation systems to stay engaged with the workpiece in high depth of cuts.

## INSERT OFFERING



**08mm iC**  
RD Insert Type  
Ground and PSTS



**10mm iC**  
RD Insert Type  
Ground and PSTS



**12mm iC**  
RD Insert Type  
Anti-Rotation Feature  
Ground and PSTS



**16mm iC**  
RD Insert Type  
Anti-Rotation Feature  
Ground and PSTS



**16mm iC**  
RC Insert Type  
Anti-Rotation Feature  
Ground and PSTS

# CONSISTENCY AND STABILITY WITH M100

## PRODUCT

**SERIES**  
M100™

## DIAMETER RANGE

.75–2" (24–125mm)

## SHANK TYPES

Shell Mills  
Weldon® End Mills  
Screw-On End Mills

## INDUSTRY



## APPLICATIONS



FACE MILLING



HELICAL MILLING/  
POCKET MILLING



3D PROFILING



POCKETING



RAMPING BLANK



SIDE MILLING/  
SHOULDER MILLING: BALL NOSE



SLOTTING: BALL NOSE

## CONSISTENCY

Thick inserts combined with the rigid body provide a strong foundation for consistent results.

## STABILITY

Anti-rotation systems in the larger iC inserts provide a sure fit for stability in high depth of cuts.



INDEXABLE MILLING

SOLID END MILLING

HOLEMAKING

TAPPING

TURNING

M100 • Weldon® End Mills • iC08 • Inch

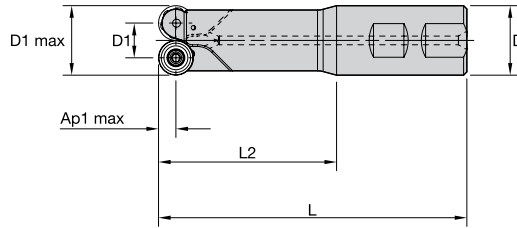

order number	catalog number	D1 max	D1	D	L	L2	Ap1 max	Z	max ramp angle	max RPM	coolant supply	lbs
2646596	M100D075Z02W075RD08L453	.750	.435	.750	4.530	2.500	.158	2	22.0	26000	Yes	.85

NOTE: All spare parts except the insert screws must be ordered separately.

FOR SPARE PARTS, PLEASE VISIT WIDIA NOVO™ OR WIDIA.COM.

MOUNTING SCREWS ARE NOT INCLUDED IN STANDARD PACKAGING.

M100 • RDMT-M0T • RD0802..

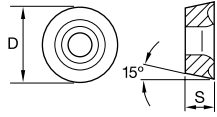
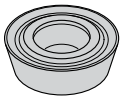

- first choice
- alternate choice

P	●	●	●	●	●	○	●
M	●	○	○	○	○	○	○
K	○	○	○	○	○	○	○
N	○	○	○	○	○	○	○
S	○	○	○	○	○	○	○
H	○	○	○	○	○	○	○

catalog number	D		S		THM	TN6525	TN6540	TTM08	WK15CM	WP35CM	WS30PM	WS40PM
	in	mm	in	mm								
RDMT0802M0T	.315	8,000	.094	2,380	●	○	○	○	○	○	○	○
RDMT1003M0T	.394	10,000	.125	3,180	○	○	○	○	○	○	○	○

M100 • RDMW-M0 / -M0T • RD0802..

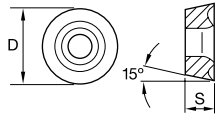
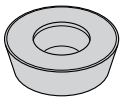

- first choice
- alternate choice

P	●	●	●	●	○	○
M	○	○	○	○	○	○
K	○	○	○	○	○	○
N	○	○	○	○	○	○
S	○	○	○	○	○	○
H	○	○	○	○	○	○

catalog number	D		S		THM	TN6525	TN6540	TTM08	WK15CM	WP35CM	WS30PM	WS40PM
	mm	in	mm	in								
RDMW0802M0	8,00	.315	2,38	.094	○	○	○	○	○	○	○	○
RDMW0802M0T	8,00	.315	2,38	.094	○	○	○	○	○	○	○	○

INDEXABLE MILLING

SOLID END MILLING

HOLEMAKING

TAPPING

TURNING



M100 • RD08 • Insert Selection Guide

Material Group	Light Machining		General Purpose		Heavy Machining	
	Geometry	Grade	Geometry	Grade	Geometry	Grade
P1-P2	RDMT-T	WP35CM	RDMT-T	WP35CM	RDMT-T	WP35CM
P3-P4	RDMT-T	WP35CM	RDMW-T	TN6540	RDMW-T	TN6540
P5-P6	RDMT-T	WP35CM	RDMT-T	WP35CM	RDMT-T	WP35CM
M1-M2	RDHT-T	WP35CM	RDHT-T	WP35CM	RDMT-T	WP35CM
M3	RDHT-T	WP35CM	RDHT-T	WP35CM	RDMT-T	WP35CM
K1-K2	-	-	RDMT-T	WP35CM	RDMT-T	WP35CM
K3	-	-	RDMT-T	WP35CM	RDMT-T	WP35CM
N1-N2	-	-	-	-	-	-
N3	-	-	-	-	-	-
S1-S2	-	-	-	-	-	-
S3	-	-	-	-	-	-
S4	-	-	-	-	-	-
H1	-	-	-	-	-	-

M100 • RD08 • Recommended Starting Speeds [SFM]

Material Group		THM			TN6525			TN6540			WP35CM		
P	1	-	-	-	1340	1045	925	1180	925	785	1790	1555	1460
	2	-	-	-	1045	830	710	830	630	550	1105	1000	905
	3	-	-	-	925	710	610	710	550	450	1000	905	805
	4	-	-	-	770	550	475	590	430	355	750	690	630
	5	-	-	-	1025	770	650	785	590	490	1025	905	830
	6	-	-	-	670	535	430	535	395	335	630	535	430
M	1	-	-	-	630	395	260	430	260	200	805	725	610
	2	-	-	-	395	260	155	260	155	140	725	630	550
	3	-	-	-	415	260	180	275	155	140	570	510	450
K	1	390	295	245	905	805	725	725	670	590	1165	1045	940
	2	410	325	225	710	630	590	570	510	450	925	830	750
	3	425	310	195	590	535	475	510	475	415	770	690	630
N	1	2950	1965	1640	-	-	-	-	-	-	-	-	-
	2	2245	1525	1260	-	-	-	-	-	-	-	-	-
	3	1475	915	655	-	-	-	-	-	-	-	-	-
S	1	-	-	-	-	-	-	155	120	95	-	-	-
	2	-	-	-	-	-	-	80	60	40	-	-	-
	3	-	-	-	-	-	-	235	140	95	-	-	-
	4	-	-	-	-	-	-	200	95	80	260	200	130
H	1	-	-	-	-	-	-	-	-	-	-	-	-
	2	-	-	-	-	-	-	-	-	-	-	-	-
	3	-	-	-	-	-	-	-	-	-	-	-	-

Material Group		TTM08			WK15CM			WS30PM			WS40PM		
P	1	750	655	620	-	-	-	-	-	-	-	-	-
	2	635	555	455	-	-	-	-	-	-	-	-	-
	3	590	490	410	-	-	-	-	-	-	-	-	-
	4	520	425	340	-	-	-	-	-	-	-	-	-
	5	-	-	-	-	-	-	-	-	-	560	475	395
	6	-	-	-	-	-	-	-	-	-	490	360	260
M	1	-	-	-	-	-	-	890	785	725	690	560	460
	2	-	-	-	-	-	-	805	710	570	590	475	395
	3	-	-	-	-	-	-	610	535	415	475	360	280
K	1	-	-	-	1655	1520	1340	-	-	-	-	-	-
	2	-	-	-	1320	1165	1080	-	-	-	-	-	-
	3	-	-	-	1105	985	905	-	-	-	-	-	-
N	1	-	-	-	-	-	-	-	-	-	-	-	-
	2	-	-	-	-	-	-	-	-	-	-	-	-
	3	-	-	-	-	-	-	-	-	-	-	-	-
S	1	-	-	-	-	-	-	180	155	120	130	115	80
	2	-	-	-	-	-	-	180	155	120	130	115	80
	3	-	-	-	-	-	-	215	180	120	165	130	80
	4	-	-	-	-	-	-	335	235	155	195	165	100
H	1	-	-	-	-	-	-	-	-	-	-	-	-
	2	-	-	-	-	-	-	-	-	-	-	-	-
	3	-	-	-	-	-	-	-	-	-	-	-	-

NOTE: FIRST choice starting speeds are in **bold** type.  
As the average chip thickness increases, the speed should be decreased.

M100 • RD08 • Recommended Starting Feeds [IPT]

Light Machining	General Purpose	Heavy Machining
-----------------	-----------------	-----------------

At .157 Axial Depth of Cut (ap)

Insert Geometry	Programmed Feed per Tooth (fz) as a % of Radial Depth of Cut (ae)														Insert Geometry	
	5%			10%			20%			30%		40-100%				
RDMW-	.007	.011	.016	.005	.008	.012	.004	.006	.009	.003	.005	.008	.003	.005	.007	RDMW-
RDHT-T	.009	.012	.024	.007	.009	.018	.005	.007	.013	.004	.006	.011	.004	.005	.011	RDHT-T
RDMT-T	.009	.012	.024	.007	.009	.018	.005	.007	.013	.004	.006	.011	.004	.005	.011	RDMT-T
RDMW-T	.009	.016	.028	.007	.012	.021	.005	.009	.015	.004	.008	.013	.004	.007	.012	RDMW-T

At .079 Axial Depth of Cut (ap)

Insert Geometry	Programmed Feed per Tooth (fz) as a % of Radial Depth of Cut (ae)														Insert Geometry	
	5%			10%			20%			30%		40-100%				
RDMW-	.008	.013	.019	.006	.009	.014	.005	.007	.010	.004	.006	.009	.004	.006	.008	RDMW-
RDHT-T	.010	.014	.028	.008	.010	.020	.006	.008	.015	.005	.007	.013	.005	.006	.012	RDHT-T
RDMT-T	.010	.014	.028	.008	.010	.020	.006	.008	.015	.005	.007	.013	.005	.006	.012	RDMT-T
RDMW-T	.010	.019	.033	.008	.014	.024	.006	.010	.018	.005	.009	.015	.005	.008	.014	RDMW-T

At .039 Axial Depth of Cut (ap)

Insert Geometry	Programmed Feed per Tooth (fz) as a % of Radial Depth of Cut (ae)														Insert Geometry	
	5%			10%			20%			30%		40-100%				
RDMW-	.011	.017	.025	.008	.012	.018	.006	.009	.013	.005	.008	.012	.005	.007	.011	RDMW-
RDHT-T	.014	.018	.037	.010	.013	.027	.007	.010	.020	.006	.009	.017	.006	.008	.016	RDHT-T
RDMT-T	.014	.018	.037	.010	.013	.027	.007	.010	.020	.006	.009	.017	.006	.008	.016	RDMT-T
RDMW-T	.014	.025	.043	.010	.018	.031	.007	.013	.023	.006	.012	.020	.006	.011	.019	RDMW-T

At .020 Axial Depth of Cut (ap)

Insert Geometry	Programmed Feed per Tooth (fz) as a % of Radial Depth of Cut (ae)														Insert Geometry	
	5%			10%			20%			30%		40-100%				
RDMW-	.015	.023	.034	.011	.017	.024	.008	.013	.018	.007	.011	.016	.007	.010	.014	RDMW-
RDHT-T	.019	.025	.051	.014	.018	.037	.010	.014	.027	.009	.012	.024	.008	.011	.022	RDHT-T
RDMT-T	.019	.025	.051	.014	.018	.037	.010	.014	.027	.009	.012	.024	.008	.011	.022	RDMT-T
RDMW-T	.019	.034	.060	.014	.024	.043	.010	.018	.032	.009	.016	.028	.008	.014	.025	RDMW-T

NOTE: Use "Light Machining" value as starting feed rate.

INDEXABLE MILLING

SOLID END MILLING

HOLEMAKING

TAPPING

TURNING

INDEXABLE MILLING

SOLID END MILLING

HOLEMAKING

TAPPING

TURNING

M100 • Weldon® End Mills • iC10 • Inch

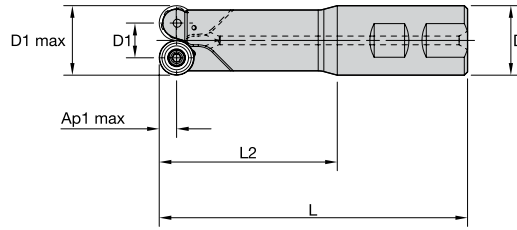

order number	catalog number	D1 max		D1		D		L		L2		Ap1 max		Z	max ramp angle	max RPM	coolant supply	kg	lbs
		mm	in	mm	in	mm	in	mm	in	mm	in	mm	in						
2646602	M100D075Z02W100RD10L628	19,05	.750	9,04	.356	25,40	1.000	159,51	6.280	101,60	4.000	5,00	.197	2	40.0	26000	Yes	0,50	1.10

NOTE: All spare parts except the insert screws must be ordered separately.

FOR SPARE PARTS, PLEASE VISIT WIDIA NOVO™ OR WIDIA.COM.

MOUNTING SCREWS ARE NOT INCLUDED IN STANDARD PACKAGING.

M100 • RDMT-M0T • RD1003..

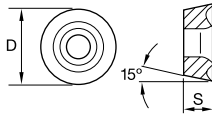
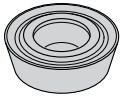

- first choice
- alternate choice

P	■	■	●	●	●	●	○	●
M	■	○	○	○	○	○	○	○
K	■	○	○	○	○	○	○	○
N	■	○	○	○	○	○	○	○
S	■	○	○	○	○	○	○	○
H	■	○	○	○	○	○	○	○

catalog number	D		S		hm		THM	TN6525	TN6540	TTM08	WK15CM	WP35CM	WS30PM	WS40PM
	mm	in	mm	in	mm	in								
RDMT1003M0	10,00	.394	3,18	.125	0,14	.006	2012538	-	-	-	-	-	-	-
RDMT1003M0T	10,00	.394	3,18	.125	0,14	.006	-	2957429	2957428	-	-	-	-	-

M100 • RDMW-M0 / -M0T • RD1003..

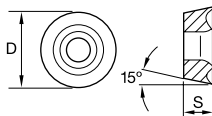
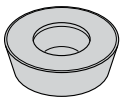

- first choice
- alternate choice

P	■	■	●	●	●	●	○	●
M	■	○	○	○	○	○	○	○
K	■	○	○	○	○	○	○	○
N	■	○	○	○	○	○	○	○
S	■	○	○	○	○	○	○	○
H	■	○	○	○	○	○	○	○

catalog number	D		S		hm		THM	TN6525	TN6540	TTM08	WK15CM	WP35CM	WS30PM	WS40PM
	mm	in	mm	in	mm	in								
RDMW1003M0	10,00	.394	3,18	.125	-	-	-	-	-	-	6724747	-	-	-
RDMW1003M0T	10,00	.394	3,18	.125	0,14	.006	-	3353279	-	-	-	-	-	-

INDEXABLE MILLING

SOLID END MILLING

HOLE/MAKING

TAPPING

TURNING

M100 • RD10 • Insert Selection Guide

Material Group	Light Machining		General Purpose		Heavy Machining	
	Geometry	Grade	Geometry	Grade	Geometry	Grade
P1-P2	RDMT-T	TN6525	RDMT-T	TN6540	RDMW-T	TN6540
P3-P4	RDMT-T	TN6525	RDMW-T	TN6540	RDMW-T	TN6540
P5-P6	RDMT-T	TN6525	RDMW-T	TN6540	RDMW-T	TN6540
M1-M2	RDHT-T	TN6540	RDMT-T	TN6540	RDMT-T	TN6540
M3	RDHT-T	TN6540	RDMT-T	TN6540	RDMT-T	TN6540
K1-K2	RDMW-MH	TN2510	RDMW-MH	TN2510	RDMW	WK15CM
K3	RDMW-MH	TN2510	RDMW-MH	TN2510	RDMW	WK15CM
N1-N2	-	-	-	-	-	-
N3	-	-	-	-	-	-
S1-S2	-	-	RDMT-T	TN6540	-	-
S3	-	-	RDMT-T	TN6540	-	-
S4	-	-	RDMT-T	TN6540	RDMT-T	TN6540
H1	RDMW-MH	TN2510	RDMW-MH	TN2510	-	-

M100 • RD10 • Recommended Starting Speeds [SFM]

Material Group		THM			TN6525			TN6540			WP35CM		
P	1	-	-	-	1340	1045	925	1180	925	785	1790	1555	1460
	2	-	-	-	1045	830	710	830	630	550	1105	1000	905
	3	-	-	-	925	710	610	710	550	450	1000	905	805
	4	-	-	-	770	550	475	590	430	355	750	690	630
	5	-	-	-	1025	770	650	785	590	490	1025	905	830
	6	-	-	-	670	535	430	535	395	335	630	535	430
M	1	-	-	-	630	395	260	430	260	200	805	725	610
	2	-	-	-	395	260	155	260	155	140	725	630	550
	3	-	-	-	415	260	180	275	155	140	570	510	450
K	1	390	295	245	905	805	725	725	670	590	1165	1045	940
	2	410	325	225	710	630	590	570	510	450	925	830	750
	3	425	310	195	590	535	475	510	475	415	770	690	630
N	1	2950	1965	1640	-	-	-	-	-	-	-	-	-
	2	2245	1525	1260	-	-	-	-	-	-	-	-	-
	3	1475	915	655	-	-	-	-	-	-	-	-	-
S	1	-	-	-	-	-	-	155	120	95	-	-	-
	2	-	-	-	-	-	-	80	60	40	-	-	-
	3	-	-	-	-	-	-	235	140	95	-	-	-
	4	-	-	-	-	-	-	200	95	80	260	200	130
H	1	-	-	-	-	-	-	-	-	-	-	-	-
	2	-	-	-	-	-	-	-	-	-	-	-	-
	3	-	-	-	-	-	-	-	-	-	-	-	-

Material Group		TTM08			WK15CM			WS30PM			WS40PM		
P	1	750	655	620	-	-	-	-	-	-	-	-	-
	2	635	555	455	-	-	-	-	-	-	-	-	-
	3	590	490	410	-	-	-	-	-	-	-	-	-
	4	520	425	340	-	-	-	-	-	-	-	-	-
	5	-	-	-	-	-	-	-	-	-	560	475	395
	6	-	-	-	-	-	-	-	-	-	490	360	260
M	1	-	-	-	-	-	-	890	785	725	690	560	460
	2	-	-	-	-	-	-	805	710	570	590	475	395
	3	-	-	-	-	-	-	610	535	415	475	360	280
K	1	-	-	-	1655	1520	1340	-	-	-	-	-	-
	2	-	-	-	1320	1165	1080	-	-	-	-	-	-
	3	-	-	-	1105	985	905	-	-	-	-	-	-
N	1	-	-	-	-	-	-	-	-	-	-	-	-
	2	-	-	-	-	-	-	-	-	-	-	-	-
	3	-	-	-	-	-	-	-	-	-	-	-	-
S	1	-	-	-	-	-	-	180	155	120	130	115	80
	2	-	-	-	-	-	-	180	155	120	130	115	80
	3	-	-	-	-	-	-	215	180	120	165	130	80
	4	-	-	-	-	-	-	335	235	155	195	165	100
H	1	-	-	-	-	-	-	-	-	-	-	-	-
	2	-	-	-	-	-	-	-	-	-	-	-	-
	3	-	-	-	-	-	-	-	-	-	-	-	-

NOTE: FIRST choice starting speeds are in **bold** type.  
As the average chip thickness increases, the speed should be decreased.

M100 • RD10 • Recommended Starting Feeds [IPT]

Light Machining	General Purpose	Heavy Machining
-----------------	-----------------	-----------------

At .197 Axial Depth of Cut (ap)

Insert Geometry	Programmed Feed per Tooth (fz) as a % of Radial Depth of Cut (ae)														Insert Geometry	
	5%			10%			20%			30%			40-100%			
RDHT-T	.009	.015	.026	.007	.011	.018	.005	.008	.014	.004	.007	.012	.004	.007	.011	RDHT-T
RDHW-MH	.009	.017	.035	.007	.012	.025	.005	.009	.019	.004	.008	.016	.004	.007	.015	RDHW-MH
RDMT-T	.009	.015	.026	.007	.011	.018	.005	.008	.014	.004	.007	.012	.004	.007	.011	RDMT-T
RDMW-	.009	.008	.024	.007	.006	.017	.005	.004	.013	.004	.004	.011	.004	.004	.010	RDMW-
RDMW-T	.009	.022	.035	.007	.016	.025	.005	.012	.019	.004	.011	.016	.004	.010	.015	RDMW-T

At .098 Axial Depth of Cut (ap)

Insert Geometry	Programmed Feed per Tooth (fz) as a % of Radial Depth of Cut (ae)														Insert Geometry	
	5%			10%			20%			30%			40-100%			
RDHT-T	.010	.018	.030	.008	.013	.021	.006	.010	.016	.005	.008	.014	.005	.008	.013	RDHT-T
RDHW-MH	.010	.019	.040	.008	.014	.029	.006	.010	.021	.005	.009	.019	.005	.008	.017	RDHW-MH
RDMT-T	.010	.018	.030	.008	.013	.021	.006	.010	.016	.005	.008	.014	.005	.008	.013	RDMT-T
RDMW-	.010	.009	.027	.008	.007	.020	.006	.005	.015	.005	.004	.013	.005	.004	.012	RDMW-
RDMW-T	.010	.026	.040	.008	.019	.029	.006	.014	.021	.005	.012	.019	.005	.011	.017	RDMW-T

At .049 Axial Depth of Cut (ap)

Insert Geometry	Programmed Feed per Tooth (fz) as a % of Radial Depth of Cut (ae)														Insert Geometry	
	5%			10%			20%			30%			40-100%			
RDHT-T	.014	.023	.039	.010	.017	.028	.007	.012	.021	.006	.011	.018	.006	.010	.017	RDHT-T
RDHW-MH	.014	.025	.053	.010	.018	.038	.007	.014	.028	.006	.012	.025	.006	.011	.022	RDHW-MH
RDMT-T	.014	.023	.039	.010	.017	.028	.007	.012	.021	.006	.011	.018	.006	.010	.017	RDMT-T
RDMW-	.014	.012	.036	.010	.009	.026	.007	.007	.019	.006	.006	.017	.006	.005	.015	RDMW-
RDMW-T	.014	.034	.053	.010	.024	.038	.007	.018	.028	.006	.016	.025	.006	.015	.022	RDMW-T

At .025 Axial Depth of Cut (ap)

Insert Geometry	Programmed Feed per Tooth (fz) as a % of Radial Depth of Cut (ae)														Insert Geometry	
	5%			10%			20%			30%			40-100%			
RDHT-T	.019	.032	.053	.014	.023	.038	.010	.017	.028	.009	.015	.025	.008	.014	.023	RDHT-T
RDHW-MH	.019	.034	.073	.014	.025	.052	.010	.019	.039	.009	.016	.034	.008	.015	.031	RDHW-MH
RDMT-T	.019	.032	.053	.014	.023	.038	.010	.017	.028	.009	.015	.025	.008	.014	.023	RDMT-T
RDMW-	.019	.017	.049	.014	.012	.035	.010	.009	.026	.009	.008	.023	.008	.007	.021	RDMW-
RDMW-T	.019	.047	.073	.014	.033	.052	.010	.025	.039	.009	.022	.034	.008	.020	.031	RDMW-T

NOTE: Use "Light Machining" values as starting feed rate.

INDEXABLE MILLING

SOLID END MILLING

HOLEMAKING

TAPPING

TURNING

## M100 • Weldon® End Mills • iC12 • Inch

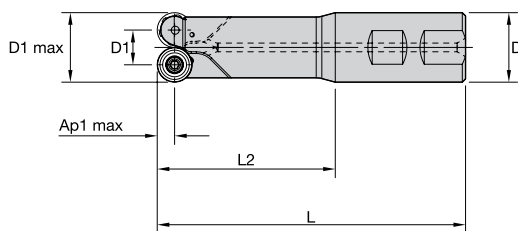

order number	catalog number	D1 max		D1		D		L		L2		Ap1 max		Z	max ramp angle	max RPM	coolant supply	kg	lbs
		mm	in	mm	in	mm	in	mm	in	mm	in	mm	in						
2646611	M100D100Z02W100RD12L553	25,40	1.000	14,78	.528	25,40	1.000	140,46	5.530	82,5500	3.250	6,00	.236	2	50.0	23000	Yes	0,57	1.25
2646617	M100D125Z02W125RD12L615	31,75	1.250	19,78	.778	31,75	1.250	156,21	6.150	98,30	3.870	6,00	.236	2	23.0	19000	Yes	0,73	1.60

NOTE: All spare parts except the insert screws must be ordered separately.

## M100 • Shell Mills • iC12 • Inch

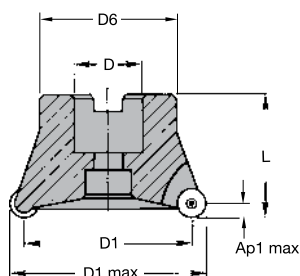

order number	catalog number	D1 max		D1		D		D6		L		Ap1 max		Z	max ramp angle	max RPM	coolant supply	kg	lbs
		mm	in	mm	in	mm	in	mm	in	mm	in	mm	in						
2646725	M100D200Z05S075RD12	50,80	2.000	38,86	1.530	19,05	.750	43,18	1.700	41,40	1.630	6,00	.236	5	10.0	15000	Yes	0,25	.55

NOTE: All spare parts except the insert screws must be ordered separately.

FOR SPARE PARTS, PLEASE VISIT WIDIA NOVO™ OR WIDIA.COM.

MOUNTING SCREWS ARE NOT INCLUDED IN STANDARD PACKAGING.

M100 • RDMT-TX • RD1204..

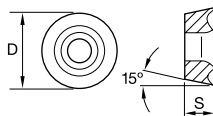

● first choice

○ alternate choice

P	●	●	●	●	●	●	●
M	●	●	●	●	●	●	●
K	○	○	○	●	○	○	○
N	●	○	○	○	○	○	○
S	○	○	○	○	○	○	○
H	○	○	○	○	○	○	○

catalog number	number of indexes	D		S		hm		THM	TN6525	TN6540	TTM08	WK15CM	WP35CM	WS30PM	WS40PM
		mm	in	mm	in	mm	in								
RDMT1204M0TX	6	12,00	.472	4,76	.188	0,15	.006	-	2957430	2957432	2012546	-	-	5520247	-
RDMT1204M0TX	6	12,00	.472	4,76	.188	-	-	-	-	-	-	6724748	6901188	-	-

M100 • RDMW-TX • RD1204..

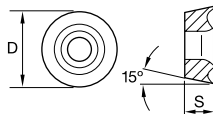
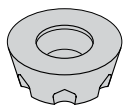

● first choice

○ alternate choice

P	●	●	●	●	●	●	●
M	●	●	●	●	●	●	●
K	○	○	○	●	○	○	○
N	●	○	○	○	○	○	○
S	○	○	○	○	○	○	○
H	○	○	○	○	○	○	○

catalog number	number of indexes	D		S		hm		THM	TN6525	TN6540	TTM08	WK15CM	WP35CM	WS30PM	WS40PM
		mm	in	mm	in	mm	in								
RDMW1204M0TX	6	12,00	.472	4,76	.188	0,15	.006	-	3353281	2012600	5427441	-	-	-	-
RDMW1204M0TX	6	12,00	.472	4,76	.188	-	-	-	-	-	-	6901190	-	-	-



## M100 • RDPT-MMX • RD1204..

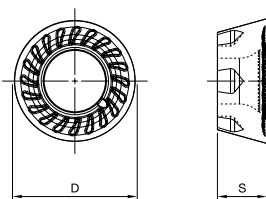

● first choice

○ alternate choice

catalog number	number of indexes	D		S		hm		THM	TN6525	TN6540	TTM08	WK15CM	WP35CM	WS30PM	WS40PM
		mm	in	mm	in	mm	in								
RDPT1204M0SMMX	6	12,00	.472	4,76	.187	0,177	.007	●	○	○	○	○	○	○	○
RDPT1204M0SMMX	6	12,00	.472	4,76	.187	—	—	○	○	○	○	○	○	○	○
RDPT1204M0SMMX4	4	12,00	.472	4,76	.187	—	—	○	○	○	○	○	○	○	○

## M100 • RD12 • Insert Selection Guide

Material Group	Light Machining		General Purpose		Heavy Machining	
	Geometry	Grade	Geometry	Grade	Geometry	Grade
P1-P2	RDMT-TX	WP35CM	RDMT-TX	TN6540	RDMT-TX	TN6540
P3-P4	RDMT-TX	WP35CM	RDMW-TX	TN6540	RDMW-TX	TN6540
P5-P6	RDMT-TX	WP35CM	RDPT-MMX	WP35CM	RDPT-MMX	WP35CM
M1-M2	RDHT-TX	WS30PM	RDMT-TX	TN6540	RDPT-MMX	TN6540
M3	RDHT-TX	WS30PM	RDMT-TX	TN6540	RDPT-MMX	TN6540
K1-K2	RDMW-TX	WK15CM	RDMW-TX	WK15CM	RDMW-TX	WK15CM
K3	RDHW-MH	TN2510	RDMW-TX	WK15CM	RDMW-TX	WK15CM
N1-N2	-	-	-	-	-	-
N3	-	-	-	-	-	-
S1-S2	-	-	RDMT-TX	TN6540	-	-
S3	-	-	RDMT-TX	TN6540	-	-
S4	-	-	RDMT-TX	TN6540	RDPT-MMX	TN6540
H1	RDHW-MH	TN2510	RDHW-MH	TN2510	-	-

## M100 • RD12 • Recommended Starting Speeds [SFM]

Material Group		THM			TN6525			TN6540			WP35CM		
		1	2	3	1	2	3	1	2	3	1	2	3
P	1	-	-	-	1340	1045	925	1180	925	785	1790	1555	1460
	2	-	-	-	1045	830	710	830	630	550	1105	1000	905
	3	-	-	-	925	710	610	710	550	450	1000	905	805
	4	-	-	-	770	550	475	590	430	355	750	690	630
	5	-	-	-	1025	770	650	785	590	490	1025	905	830
	6	-	-	-	670	535	430	535	395	335	630	535	430
M	1	-	-	-	630	395	260	430	260	200	805	725	610
	2	-	-	-	395	260	155	260	155	140	725	630	550
	3	-	-	-	415	260	180	275	155	140	570	510	450
K	1	390	295	245	905	805	725	725	670	590	1165	1045	940
	2	410	325	225	710	630	590	570	510	450	925	830	750
	3	425	310	195	590	535	475	510	475	415	770	690	630
N	1	2950	1965	1640	-	-	-	-	-	-	-	-	-
	2	2245	1525	1260	-	-	-	-	-	-	-	-	-
	3	1475	915	655	-	-	-	-	-	-	-	-	-
S	1	-	-	-	-	-	-	155	120	95	-	-	-
	2	-	-	-	-	-	-	80	60	40	-	-	-
	3	-	-	-	-	-	-	235	140	95	-	-	-
	4	-	-	-	-	-	-	200	95	80	260	200	130
H	1	-	-	-	-	-	-	-	-	-	-	-	-
	2	-	-	-	-	-	-	-	-	-	-	-	-
	3	-	-	-	-	-	-	-	-	-	-	-	-

M100 • RD12 • Recommended Starting Speeds [SFM]

Material Group		TTM08			WK15CM			WS30PM			WS40PM		
<b>P</b>	1	750	<b>655</b>	620	-	-	-	-	-	-	-	-	
	2	635	<b>555</b>	455	-	-	-	-	-	-	-	-	
	3	590	<b>490</b>	410	-	-	-	-	-	-	-	-	
	4	520	<b>425</b>	340	-	-	-	-	-	-	-	-	
	5	-	-	-	-	-	-	-	-	-	560	<b>475</b>	395
	6	-	-	-	-	-	-	-	-	-	490	<b>360</b>	260
<b>M</b>	1	-	-	-	-	-	-	890	<b>785</b>	725	690	<b>560</b>	460
	2	-	-	-	-	-	-	805	<b>710</b>	570	590	<b>475</b>	395
	3	-	-	-	-	-	-	610	<b>535</b>	415	475	<b>360</b>	280
<b>K</b>	1	-	-	-	1655	<b>1520</b>	1340	-	-	-	-	-	-
	2	-	-	-	1320	<b>1165</b>	1080	-	-	-	-	-	-
	3	-	-	-	1105	<b>985</b>	905	-	-	-	-	-	-
<b>N</b>	1	-	-	-	-	-	-	-	-	-	-	-	-
	2	-	-	-	-	-	-	-	-	-	-	-	-
	3	-	-	-	-	-	-	-	-	-	-	-	-
<b>S</b>	1	-	-	-	-	-	-	180	<b>155</b>	120	130	<b>115</b>	80
	2	-	-	-	-	-	-	180	<b>155</b>	120	130	<b>115</b>	80
	3	-	-	-	-	-	-	215	<b>180</b>	120	165	<b>130</b>	80
	4	-	-	-	-	-	-	335	<b>235</b>	155	195	<b>165</b>	100
<b>H</b>	1	-	-	-	-	-	-	-	-	-	-	-	-
	2	-	-	-	-	-	-	-	-	-	-	-	-
	3	-	-	-	-	-	-	-	-	-	-	-	-

NOTE: FIRST choice starting speeds are in **bold** type.  
As the average chip thickness increases, the speed should be decreased.

M100 • RD12 • Recommended Starting Feeds [IPT]

Light Machining	General Purpose	Heavy Machining
-----------------	-----------------	-----------------

At .236 Axial Depth of Cut (ap)

Insert Geometry	Programmed Feed per Tooth (fz) as a % of Radial Depth of Cut (ae)															Insert Geometry
	5%			10%			20%			30%			40-100%			
RDHT-TX	.014	<b>.013</b>	.022	.010	<b>.009</b>	.016	.007	<b>.007</b>	.012	.006	<b>.006</b>	.010	.006	<b>.006</b>	.009	RDHT-TX
RDMT-TX	.014	<b>.016</b>	.027	.010	<b>.012</b>	.020	.007	<b>.009</b>	.015	.006	<b>.008</b>	.013	.006	<b>.007</b>	.012	RDMT-TX
RDPT-MMX	.014	<b>.023</b>	.037	.010	<b>.016</b>	.026	.007	<b>.012</b>	.020	.006	<b>.011</b>	.017	.006	<b>.010</b>	.016	RDPT-MMX
RDHW-MH	.014	<b>.027</b>	.042	.010	<b>.020</b>	.031	.007	<b>.015</b>	.023	.006	<b>.013</b>	.020	.006	<b>.012</b>	.018	RDHW-MH
RDMW-TX	.014	<b>.027</b>	.046	.010	<b>.020</b>	.033	.007	<b>.015</b>	.024	.006	<b>.013</b>	.021	.006	<b>.012</b>	.019	RDMW-TX

At .118 Axial Depth of Cut (ap)

Insert Geometry	Programmed Feed per Tooth (fz) as a % of Radial Depth of Cut (ae)															Insert Geometry
	5%			10%			20%			30%			40-100%			
RDHT-TX	.016	<b>.015</b>	.025	.011	<b>.011</b>	.018	.009	<b>.008</b>	.014	.007	<b>.007</b>	.012	.007	<b>.007</b>	.011	RDHT-TX
RDMT-TX	.016	<b>.019</b>	.032	.011	<b>.014</b>	.023	.009	<b>.010</b>	.017	.007	<b>.009</b>	.015	.007	<b>.008</b>	.014	RDMT-TX
RDPT-MMX	.016	<b>.026</b>	.043	.011	<b>.019</b>	.031	.009	<b>.014</b>	.023	.007	<b>.012</b>	.020	.007	<b>.011</b>	.018	RDPT-MMX
RDHW-MH	.016	<b>.032</b>	.049	.011	<b>.023</b>	.035	.009	<b>.017</b>	.026	.007	<b>.015</b>	.023	.007	<b>.014</b>	.021	RDHW-MH
RDMW-TX	.016	<b>.032</b>	.053	.011	<b>.023</b>	.038	.009	<b>.017</b>	.028	.007	<b>.015</b>	.025	.007	<b>.014</b>	.022	RDMW-TX

At .059 Axial Depth of Cut (ap)

Insert Geometry	Programmed Feed per Tooth (fz) as a % of Radial Depth of Cut (ae)															Insert Geometry
	5%			10%			20%			30%			40-100%			
RDHT-TX	.021	<b>.020</b>	.033	.015	<b>.014</b>	.024	.011	<b>.011</b>	.018	.010	<b>.009</b>	.016	.009	<b>.009</b>	.014	RDHT-TX
RDMT-TX	.021	<b>.025</b>	.042	.015	<b>.018</b>	.030	.011	<b>.013</b>	.022	.010	<b>.012</b>	.019	.009	<b>.011</b>	.018	RDMT-TX
RDPT-MMX	.021	<b>.035</b>	.056	.015	<b>.025</b>	.040	.011	<b>.019</b>	.030	.010	<b>.016</b>	.026	.009	<b>.015</b>	.024	RDPT-MMX
RDHW-MH	.021	<b>.042</b>	.065	.015	<b>.030</b>	.046	.011	<b>.022</b>	.034	.010	<b>.019</b>	.030	.009	<b>.018</b>	.027	RDHW-MH
RDMW-TX	.021	<b>.042</b>	.070	.015	<b>.030</b>	.050	.011	<b>.022</b>	.037	.010	<b>.019</b>	.032	.009	<b>.018</b>	.029	RDMW-TX

At .030 Axial Depth of Cut (ap)

Insert Geometry	Programmed Feed per Tooth (fz) as a % of Radial Depth of Cut (ae)															Insert Geometry
	5%			10%			20%			30%			40-100%			
RDHT-TX	.028	<b>.027</b>	.046	.020	<b>.020</b>	.033	.015	<b>.015</b>	.024	.013	<b>.013</b>	.021	.012	<b>.012</b>	.019	RDHT-TX
RDMT-TX	.028	<b>.034</b>	.057	.020	<b>.025</b>	.041	.015	<b>.018</b>	.031	.013	<b>.016</b>	.027	.012	<b>.015</b>	.024	RDMT-TX
RDPT-MMX	.028	<b>.047</b>	.077	.020	<b>.034</b>	.055	.015	<b>.025</b>	.041	.013	<b>.022</b>	.036	.012	<b>.020</b>	.033	RDPT-MMX
RDHW-MH	.028	<b>.058</b>	.090	.020	<b>.041</b>	.064	.015	<b>.031</b>	.047	.013	<b>.027</b>	.041	.012	<b>.024</b>	.037	RDHW-MH
RDMW-TX	.028	<b>.058</b>	.097	.020	<b>.041</b>	.068	.015	<b>.031</b>	.051	.013	<b>.027</b>	.044	.012	<b>.024</b>	.040	RDMW-TX

NOTE: Use "Light Machining" value as starting feed rate.

INDEXABLE MILLING

SOLID END MILLING

HOLEMAKING

TAPPING

TURNING

## M100 • Shell Mills • iC16 • Inch

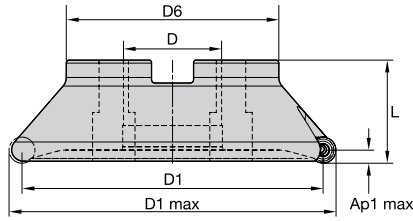

order number	catalog number	D1 max		D1		D		D6		L		Ap1 max		Z	max ramp angle	max RPM	coolant supply	kg	lbs
		mm	in	mm	in	mm	in	mm	in	mm	in	mm	in						
2646723	M100D200Z04S075RC16	50,80	2.000	34,79	1.370	19,05	.750	43,18	1.700	41,40	1.630	8,00	.315	4	12.0	15000	Yes	0,27	.60

NOTE: All spare parts except the insert screws must be ordered separately.

FOR SPARE PARTS, PLEASE VISIT [WIDIA\\_NOVO™](http://WIDIA_NOVO) OR [WIDIA.COM](http://WIDIA.COM).

MOUNTING SCREWS ARE NOT INCLUDED IN STANDARD PACKAGING.

M100 • RDMT-MOTX • RD1605..

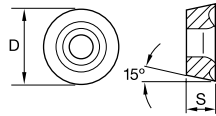

- first choice
- alternate choice

P	■	■	●	●	■	○	●
M	■	■	○	●	■	○	●
K	■	○	○	○	●	○	○
N	■	●	■	■	■	○	○
S	■	■	■	■	■	○	●
H	■	■	■	■	■	○	○

catalog number	number of indexes	D		S		hm		THM	TN6525	TN6540	TTM08	WK15CM	WP35CM	WS30PM	WS40PM
		mm	in	mm	in	mm	in								
RDMT1605M0TX	6	16,000	.630	5,560	.219	—	—	■	■	■	■	■	6901189	■	■

M100 • RDMW-MOTX • RD1605..

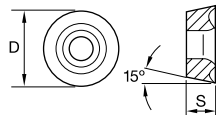
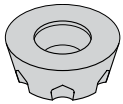

- first choice
- alternate choice

P	■	■	●	●	■	○	●
M	■	■	○	●	■	○	●
K	■	○	○	○	●	○	○
N	■	●	■	■	■	○	○
S	■	■	■	■	■	○	●
H	■	■	■	■	■	○	○

catalog number	number of indexes	D		S		hm		THM	TN6525	TN6540	TTM08	WK15CM	WP35CM	WS30PM	WS40PM
		mm	in	mm	in	mm	in								
RDMW1605M0TX	6	16,00	.630	5,56	.219	0,15	.006	■	■	3523083	2012608	■	■	■	■
RDMW1605M0TX	6	16,00	.630	5,56	.219	—	—	■	■	■	■	6901191	■	■	

INDEXABLE MILLING

SOLID END MILLING

HOLE/MAKING

TAPPING

TURNING

M100 • RCMT-MOTX • RC1606..

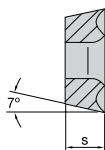
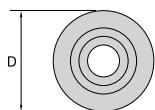

● first choice

○ alternate choice

P	●	●	●	●	○	○	○
M	○	○	○	○	○	○	○
K	○	○	○	○	○	○	○
N	○	○	○	○	○	○	○
S	○	○	○	○	○	○	○
H	○	○	○	○	○	○	○

catalog number	number of indexes	D		S		hm		THM	TN6525	TN6540	TTM08	WK15CM	WP35CM	WS30PM	WS40PM
		mm	in	mm	in	mm	in								
RCMT1606MOTX	6	16,00	.630	6,35	.250	0,24	.009	-	2957535	2957427	-	5427442	-	-	-
RCMT1606MOTX	6	16,00	.630	6,35	.250	-	-	-	-	-	-	6924077	-	-	-

M100 • RD1605 • Insert Selection Guide

Material Group	Light Machining		General Purpose		Heavy Machining	
	Geometry	Grade	Geometry	Grade	Geometry	Grade
P1-P2	RDMT-TX	TN6525	RDMT-TX	TN6540	RDMT-TX	TN6540
P3-P4	RDMT-TX	TN6525	RDMW-TX	TN6540	RDMW-TX	TN6540
P5-P6	RDMT-TX	WP35CM	RDMT-TX	WP35CM	RDMT-TX	WP35CM
M1-M2	RDMT-TX	TN6525	RDMT-TX	TN6540	RDMT-TX	TN6540
M3	RDMT-TX	TN6525	RDMT-TX	TN6540	RDMT-TX	TN6540
K1-K2	RDMW-TX	TN2510	RDMW-TX	WP35CM	RDMW-TX	WP35CM
K3	RDMW-TX	TN2510	RDMW-TX	WP35CM	RDMW-TX	WP35CM
N1-N2	-	-	-	-	-	-
N3	-	-	-	-	-	-
S1-S2	-	-	RDMT-TX	TN6540	-	-
S3	-	-	RDMT-TX	TN6540	-	-
S4	-	-	RDMT-TX	TN6540	RDMT-TX	TN6540
H1	RDMW-TX	TN2510	RDMW-TX	TN2510	-	-

M100 • RD1605 • Recommended Starting Speeds [SFM]

Material Group		THM			TN6525			TN6540			WP35CM		
		1	2	3	1	2	3	1	2	3	1	2	3
P	1	-	-	-	1340	1045	925	1180	925	785	1790	1555	1460
	2	-	-	-	1045	830	710	830	630	550	1105	1000	905
	3	-	-	-	925	710	610	710	550	450	1000	905	805
	4	-	-	-	770	550	475	590	430	355	750	690	630
	5	-	-	-	1025	770	650	785	590	490	1025	905	830
	6	-	-	-	670	535	430	535	395	335	630	535	430
M	1	-	-	-	630	395	260	430	260	200	805	725	610
	2	-	-	-	395	260	155	260	155	140	725	630	550
	3	-	-	-	415	260	180	275	155	140	570	510	450
K	1	390	295	245	905	805	725	725	670	590	1165	1045	940
	2	410	325	225	710	630	590	570	510	450	925	830	750
	3	425	310	195	590	535	475	510	475	415	770	690	630
N	1	2950	1965	1640	-	-	-	-	-	-	-	-	-
	2	2245	1525	1260	-	-	-	-	-	-	-	-	-
	3	1475	915	655	-	-	-	-	-	-	-	-	-
S	1	-	-	-	-	-	-	155	120	95	-	-	-
	2	-	-	-	-	-	-	80	60	40	-	-	-
	3	-	-	-	-	-	-	235	140	95	-	-	-
	4	-	-	-	-	-	-	200	95	80	260	200	130
H	1	-	-	-	-	-	-	-	-	-	-	-	-
	2	-	-	-	-	-	-	-	-	-	-	-	-
	3	-	-	-	-	-	-	-	-	-	-	-	-

M100 • RD1605 • Recommended Starting Speeds [SFM]

Material Group		TTM08			WK15CM			WS30PM			WS40PM		
P	1	750	<b>655</b>	620	-	-	-	-	-	-	-	-	
	2	635	<b>555</b>	455	-	-	-	-	-	-	-	-	
	3	590	<b>490</b>	410	-	-	-	-	-	-	-	-	
	4	520	<b>425</b>	340	-	-	-	-	-	-	-	-	
	5	-	-	-	-	-	-	-	-	-	560	<b>475</b>	395
	6	-	-	-	-	-	-	-	-	-	490	<b>360</b>	260
M	1	-	-	-	-	-	-	890	<b>785</b>	725	690	<b>560</b>	460
	2	-	-	-	-	-	-	805	<b>710</b>	570	590	<b>475</b>	395
	3	-	-	-	-	-	-	610	<b>535</b>	415	475	<b>360</b>	280
K	1	-	-	-	1655	<b>1520</b>	1340	-	-	-	-	-	-
	2	-	-	-	1320	<b>1165</b>	1080	-	-	-	-	-	-
	3	-	-	-	1105	<b>985</b>	905	-	-	-	-	-	-
N	1	-	-	-	-	-	-	-	-	-	-	-	-
	2	-	-	-	-	-	-	-	-	-	-	-	-
	3	-	-	-	-	-	-	-	-	-	-	-	-
S	1	-	-	-	-	-	-	180	<b>155</b>	120	130	<b>115</b>	80
	2	-	-	-	-	-	-	180	<b>155</b>	120	130	<b>115</b>	80
	3	-	-	-	-	-	-	215	<b>180</b>	120	165	<b>130</b>	80
	4	-	-	-	-	-	-	335	<b>235</b>	155	195	<b>165</b>	100
H	1	-	-	-	-	-	-	-	-	-	-	-	-
	2	-	-	-	-	-	-	-	-	-	-	-	-
	3	-	-	-	-	-	-	-	-	-	-	-	-

NOTE: FIRST choice starting speeds are in **bold** type.  
As the average chip thickness increases, the speed should be decreased.

M100 • RD1605 • Recommended Starting Feeds [IPT]

Light Machining	General Purpose	Heavy Machining
-----------------	-----------------	-----------------

At .315 Axial Depth of Cut (ap)

Insert Geometry	Programmed Feed per Tooth (fz) as a % of Radial Depth of Cut (ae)														Insert Geometry	
	5%			10%			20%			30%			40-100%			
RDHX-TX	.005	<b>.014</b>	.027	.003	<b>.010</b>	.020	.002	<b>.007</b>	.015	.002	<b>.006</b>	.013	.002	<b>.006</b>	.012	RDHX-TX
RDMT-TX	.009	<b>.016</b>	.033	.007	<b>.012</b>	.024	.005	<b>.009</b>	.018	.004	<b>.008</b>	.016	.004	<b>.007</b>	.014	RDMT-TX
RDMW-TX	.009	<b>.020</b>	.041	.007	<b>.015</b>	.030	.005	<b>.011</b>	.022	.004	<b>.010</b>	.019	.004	<b>.009</b>	.018	RDMW-TX

At .157 Axial Depth of Cut (ap)

Insert Geometry	Programmed Feed per Tooth (fz) as a % of Radial Depth of Cut (ae)														Insert Geometry	
	5%			10%			20%			30%			40-100%			
RDHX-TX	.005	<b>.016</b>	.032	.004	<b>.011</b>	.023	.003	<b>.008</b>	.017	.002	<b>.007</b>	.015	.002	<b>.007</b>	.014	RDHX-TX
RDMT-TX	.010	<b>.019</b>	.038	.008	<b>.014</b>	.028	.006	<b>.010</b>	.021	.005	<b>.009</b>	.018	.005	<b>.008</b>	.016	RDMT-TX
RDMW-TX	.010	<b>.024</b>	.048	.008	<b>.017</b>	.034	.006	<b>.013</b>	.026	.005	<b>.011</b>	.022	.005	<b>.010</b>	.020	RDMW-TX

At .079 Axial Depth of Cut (ap)

Insert Geometry	Programmed Feed per Tooth (fz) as a % of Radial Depth of Cut (ae)														Insert Geometry	
	5%			10%			20%			30%			40-100%			
RDHX-TX	.007	<b>.021</b>	.042	.005	<b>.015</b>	.030	.004	<b>.011</b>	.022	.003	<b>.010</b>	.019	.003	<b>.009</b>	.018	RDHX-TX
RDMT-TX	.014	<b>.025</b>	.050	.010	<b>.018</b>	.036	.007	<b>.013</b>	.027	.006	<b>.012</b>	.023	.006	<b>.011</b>	.021	RDMT-TX
RDMW-TX	.014	<b>.031</b>	.063	.010	<b>.022</b>	.045	.007	<b>.017</b>	.034	.006	<b>.015</b>	.029	.006	<b>.013</b>	.027	RDMW-TX

At .039 Axial Depth of Cut (ap)

Insert Geometry	Programmed Feed per Tooth (fz) as a % of Radial Depth of Cut (ae)														Insert Geometry	
	5%			10%			20%			30%			40-100%			
RDHX-TX	.009	<b>.028</b>	.057	.007	<b>.020</b>	.041	.005	<b>.015</b>	.030	.004	<b>.013</b>	.027	.004	<b>.012</b>	.024	RDHX-TX
RDMT-TX	.019	<b>.034</b>	.070	.014	<b>.025</b>	.050	.010	<b>.018</b>	.037	.009	<b>.016</b>	.032	.008	<b>.015</b>	.029	RDMT-TX
RDMW-TX	.019	<b>.043</b>	.088	.014	<b>.031</b>	.062	.010	<b>.023</b>	.046	.009	<b>.020</b>	.040	.008	<b>.018</b>	.037	RDMW-TX

NOTE: Use "Light Machining" value as starting feed rate.

### M100 • RC1606 • Insert Selection Guide

Material Group	Light Machining		General Purpose		Heavy Machining	
	Geometry	Grade	Geometry	Grade	Geometry	Grade
P1-P2	...TX	TN6525	...43M	TN6540	...43M	TN6540
P3-P4	...TX	TN6525	...TX	TN6540	...43M	TN6540
P5-P6	...TX	TN6525	...TX	WP35CM	...TX	WP35CM
M1-M2	...TX	TN6525	...TX	TN6540	...TX	TN6540
M3	...TX	TN6525	...TX	TN6540	...TX	TN6540
K1-K2	...43	TN2510	...TX	WK15CM	...TX	WK15CM
K3	...TX	TN6525	...TX	WK15CM	...TX	WK15CM
N1-N2	-	-	-	-	-	-
N3	-	-	-	-	-	-
S1-S2	-	-	-	-	-	-
S3	-	-	-	-	-	-
S4	...43M	TN6540	...TX	TN6540	...TX	TN6540
H1	-	-	...TX	TN2510	-	-

### M100 • RC1606 • Recommended Starting Speeds [SFM]

Material Group		THM			TN6525			TN6540			WP35CM		
P	1	-	-	-	1340	1045	925	1180	925	785	1790	1555	1460
	2	-	-	-	1045	830	710	830	630	550	1105	1000	905
	3	-	-	-	925	710	610	710	550	450	1000	905	805
	4	-	-	-	770	550	475	590	430	355	750	690	630
	5	-	-	-	1025	770	650	785	590	490	1025	905	830
	6	-	-	-	670	535	430	535	395	335	630	535	430
M	1	-	-	-	630	395	260	430	260	200	805	725	610
	2	-	-	-	395	260	155	260	155	140	725	630	550
	3	-	-	-	415	260	180	275	155	140	570	510	450
K	1	390	295	245	905	805	725	725	670	590	1165	1045	940
	2	410	325	225	710	630	590	570	510	450	925	830	750
	3	425	310	195	590	535	475	510	475	415	770	690	630
N	1	2950	1965	1640	-	-	-	-	-	-	-	-	-
	2	2245	1525	1260	-	-	-	-	-	-	-	-	-
	3	1475	915	655	-	-	-	-	-	-	-	-	-
S	1	-	-	-	-	-	-	155	120	95	-	-	-
	2	-	-	-	-	-	-	80	60	40	-	-	-
	3	-	-	-	-	-	-	235	140	95	-	-	-
	4	-	-	-	-	-	-	200	95	80	260	200	130
H	1	-	-	-	-	-	-	-	-	-	-	-	-
	2	-	-	-	-	-	-	-	-	-	-	-	-
	3	-	-	-	-	-	-	-	-	-	-	-	-

Material Group		TTM08			WK15CM			WS30PM			WS40PM		
P	1	750	655	620	-	-	-	-	-	-	-	-	-
	2	635	555	455	-	-	-	-	-	-	-	-	-
	3	590	490	410	-	-	-	-	-	-	-	-	-
	4	520	425	340	-	-	-	-	-	-	-	-	-
	5	-	-	-	-	-	-	-	-	-	560	475	395
	6	-	-	-	-	-	-	-	-	-	490	360	260
M	1	-	-	-	-	-	-	890	785	725	690	560	460
	2	-	-	-	-	-	-	805	710	570	590	475	395
	3	-	-	-	-	-	-	610	535	415	475	360	280
K	1	-	-	-	1655	1520	1340	-	-	-	-	-	-
	2	-	-	-	1320	1165	1080	-	-	-	-	-	-
	3	-	-	-	1105	985	905	-	-	-	-	-	-
N	1	-	-	-	-	-	-	-	-	-	-	-	-
	2	-	-	-	-	-	-	-	-	-	-	-	-
	3	-	-	-	-	-	-	-	-	-	-	-	-
S	1	-	-	-	-	-	-	180	155	120	130	115	80
	2	-	-	-	-	-	-	180	155	120	130	115	80
	3	-	-	-	-	-	-	215	180	120	165	130	80
	4	-	-	-	-	-	-	335	235	155	195	165	100
H	1	-	-	-	-	-	-	-	-	-	-	-	-
	2	-	-	-	-	-	-	-	-	-	-	-	-
	3	-	-	-	-	-	-	-	-	-	-	-	-

NOTE: FIRST choice starting speeds are in **bold** type.  
As the average chip thickness increases, the speed should be decreased.

M100 • RC1606 • Recommended Starting Feeds [IPT]

Light Machining	General Purpose	Heavy Machining
-----------------	-----------------	-----------------

At .315 Axial Depth of Cut (ap)

Insert Geometry	Programmed Feed per Tooth (fz) as a % of Radial Depth of Cut (ae)															Insert Geometry
	5%			10%			20%			30%			40-100%			
...43	.018	<b>.024</b>	.037	.013	<b>.017</b>	.027	.010	<b>.013</b>	.020	.009	<b>.011</b>	.017	.008	<b>.010</b>	.016	...43
...TX	.018	<b>.027</b>	.044	.013	<b>.020</b>	.032	.010	<b>.015</b>	.024	.009	<b>.013</b>	.021	.008	<b>.012</b>	.019	...TX

At .157 Axial Depth of Cut (ap)

Insert Geometry	Programmed Feed per Tooth (fz) as a % of Radial Depth of Cut (ae)															Insert Geometry
	5%			10%			20%			30%			40-100%			
...43	.021	<b>.028</b>	.043	.015	<b>.020</b>	.031	.011	<b>.015</b>	.023	.010	<b>.013</b>	.020	.009	<b>.012</b>	.018	...43
...TX	.021	<b>.032</b>	.051	.015	<b>.023</b>	.037	.011	<b>.017</b>	.027	.010	<b>.015</b>	.024	.009	<b>.014</b>	.022	...TX

At .079 Axial Depth of Cut (ap)

Insert Geometry	Programmed Feed per Tooth (fz) as a % of Radial Depth of Cut (ae)															Insert Geometry
	5%			10%			20%			30%			40-100%			
...43	.028	<b>.036</b>	.056	.020	<b>.026</b>	.040	.015	<b>.019</b>	.030	.013	<b>.017</b>	.026	.012	<b>.016</b>	.024	...43
...TX	.028	<b>.042</b>	.067	.020	<b>.030</b>	.048	.015	<b>.022</b>	.036	.013	<b>.019</b>	.031	.012	<b>.018</b>	.028	...TX

At .039 Axial Depth of Cut (ap)

Insert Geometry	Programmed Feed per Tooth (fz) as a % of Radial Depth of Cut (ae)															Insert Geometry
	5%			10%			20%			30%			40-100%			
...43	.038	<b>.050</b>	.078	.027	<b>.036</b>	.055	.020	<b>.027</b>	.041	.018	<b>.023</b>	.036	.016	<b>.021</b>	.033	...43
...TX	.038	<b>.058</b>	.093	.027	<b>.041</b>	.066	.020	<b>.031</b>	.049	.018	<b>.027</b>	.042	.016	<b>.024</b>	.039	...TX

NOTE: Use "Light Machining" value as starting feed rate.

INDEXABLE MILLING

SOLID END MILLING

HOLEMAKING

TAPPING

TURNING



# General Milling and ISO Inserts

## Additional Inserts

Use general milling and ISO inserts in the latest WIDIA™ grades as an economical solution for improved productivity in face milling, shoulder milling, and copy milling applications.

Inserts offered in pressed and sintered to size (PSTS) and ground versions for economical and precise solutions.

Available in the latest Victory™ grades: WK15CM, WP35CM, and WU20PM.

Inserts can be used in existing tool bodies for lower tooling costs.

Materials include all types of steel, stainless steel, cast iron, and nodular iron.

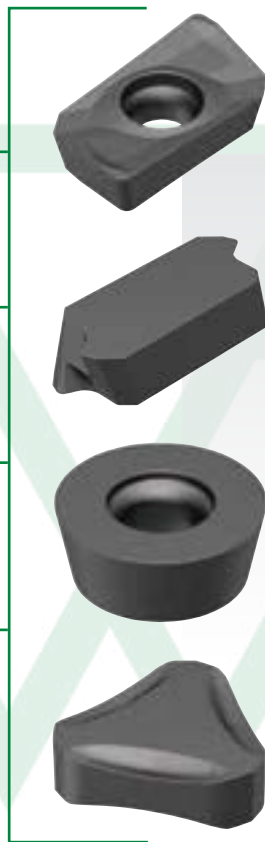

The general milling and ISO inserts provide higher performance for applications in automotive, heavy equipment, railroad components, and general engineering parts while being cost effective.

### WK15CM



WK15CM is a wear-resistant grade with balanced toughness for general milling of cast irons. Best results in dry machining, but can also be used wet.

### WP35CM



WP35CM has a wide range of applications in general and rough milling of steels and cast iron. Performs best in dry, but can also be used under wet conditions.

### WU20PM



WU20PM is a universal grade for machining of steel, stainless steel, and high-temperature alloys. Also suitable for machining of gray and nodular irons. Resists breakage and offers improved wear resistance and increased strength. Can be used for both dry and wet machining.

# HIGHER PERFORMANCE AT LOWER COST

## PRODUCT

**SERIES**  
General Milling/  
ISO Inserts

## INDUSTRY



## APPLICATIONS



FACE  
MILLING



SIDE MILLING/  
SHOULDER  
MILLING

## PERFORMANCE

Using proven WIDIA™ grades, improve productivity in all types of steel, stainless steel, cast iron, and nodular iron workpiece materials.

## COST EFFECTIVE

Inserts can be used in existing cutter bodies reducing tooling costs.



## Indexable Milling • Copy Milling ISO Inserts • RDMX

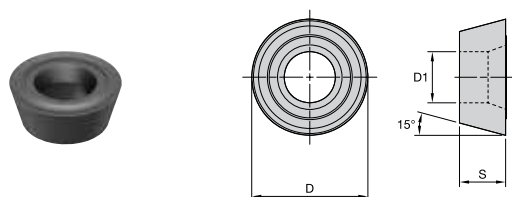

- first choice
- alternate choice

P	●
M	●
K	○
N	○
S	○
H	○

ISO catalog number	ANSI catalog number	cutting edges	D1		D		S		hm		WU20PM
			mm	in	mm	in	mm	in	mm	in	
RDMX10T3M0	RDMX10T3M0	1	4,40	0	10	.394	3,97	.156	0,05	.002	2567081
RDMX1604M0T	RDMX1604M0T	1	5,50	0	16	.630	4,76	.188	0,06	.002	4147744

## Indexable Milling • Copy Milling ISO Inserts • RPMT

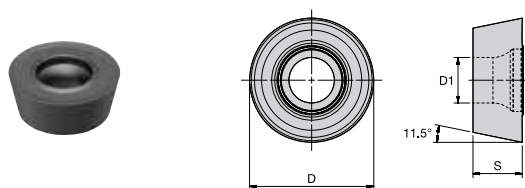

- first choice
- alternate choice

P	●
M	●
K	○
N	○
S	○
H	○

ISO catalog number	ANSI catalog number	cutting edges	D1		D		S		hm		WU20PM
			mm	in	mm	in	mm	in	mm	in	
RPMT1204M0	RPMT1204M0	1	4,40	0	12	.472	4,76	.188	0,05	.002	4144073

## Indexable Milling • Copy Milling ISO Inserts • RPMW

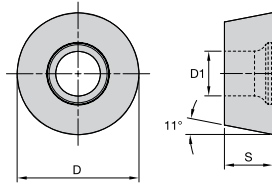

- first choice
- alternate choice

P	<input checked="" type="checkbox"/>
M	<input checked="" type="checkbox"/>
K	<input type="checkbox"/>
N	<input type="checkbox"/>
S	<input type="checkbox"/>
H	<input type="checkbox"/>

ISO catalog number	ANSI catalog number	cutting edges	D1		D		S		hm		WU20PM 336756 3350976
			mm	in	mm	in	mm	in	mm	in	
RPMW1003M0	RPMW1003M0	1	4,60	0	10	.394	3,18	.125	0,05	.002	
RPMW1204M0	RPMW1204M0	1	4,40	0	12	.472	4,76	.188	0,05	.002	

INDEXABLE MILLING

SOLID END MILLING

HOLE/MAKING

TAPPING

TURNING

## Indexable Milling • Face Milling ISO Inserts • LNCX

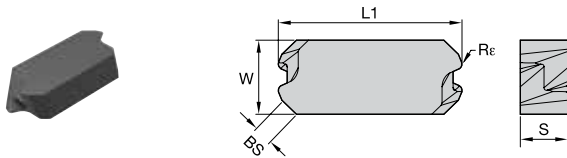

- first choice
- alternate choice

P	●	●
M	●	●
K	○	●
N	○	○
S	○	○
H	○	○

ISO catalog number	ANSI catalog number	cutting edges	W		S		BS		R <sub>e</sub>		hm		WP35CM	WK15CM
			mm	in	mm	in	mm	in	mm	in	mm	in		
LNCX1806AZR11	LNCX1806AZR11	4	10,00	.394	6,40	.252	2,16	.085	0,75	.030	0,05	.002	5943199	
LNCX1806AZR11	LNCX1806AZR11	4	10,00	.394	6,40	.252	2,16	.085	0,75	.030	0,06	.002	6852433	

## Indexable Milling • Face Milling ISO Inserts • SPAN

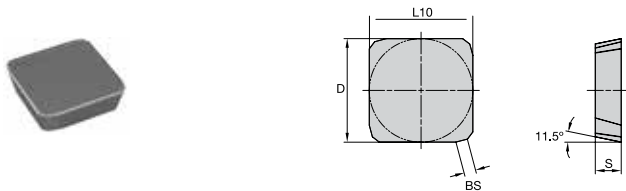

- first choice
- alternate choice

P	●	●
M	●	●
K	○	○
N	○	○
S	○	○
H	○	○

ISO catalog number	ANSI catalog number	cutting edges	D		L10		S		BS		hm		WP35CM	WU20PM
			mm	in	mm	in	mm	in	mm	in	mm	in		
SPAN1203EDL	SPAN1203EDL	4	13	.500	12,70	.500	3,18	.125	1,03	.041	0,05	.002	3997503	
SPAN1203EDR	SPAN1203EDR	4	13	.500	12,70	.500	3,18	.125	1,03	.041	0,05	.002	6877203	
SPAN1203EDR	SPAN1203EDR	4	13	.500	12,70	.500	3,18	.125	1,03	.041	0,06	.002	2557457	

## Indexable Milling • Face Milling ISO Inserts • SPCX

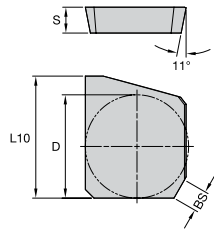

- first choice
- alternate choice

P	■	●
M	■	●
K	■	●
N	■	●
S	■	●
H	■	●

ISO catalog number	ANSI catalog number	cutting edges	D		L10		S		hm		THM-F
			mm	in	mm	in	mm	in	mm	in	
SPCX1203EDL	SPCX1203EDL	1	13	.500	15,00	.591	3,18	.125	0,02	.001	2557024
SPCX1203EDR	SPCX1203EDR	1	13	.500	15,00	.591	3,18	.125	0,02	.001	2557061

## Indexable Milling • Face Milling ISO Inserts • SPKR

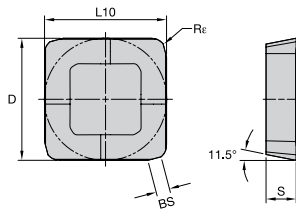

- first choice
- alternate choice

P	■	●
M	■	●
K	■	●
N	■	●
S	■	●
H	■	●

ISO catalog number	ANSI catalog number	cutting edges	D		L10		S		BS		Re		hm		WU20PM
			mm	in	mm	in	mm	in	mm	in	mm	in	mm	in	
SPKR1203EDLMS	SPKR1203EDLMS	4	13	.500	12,70	.500	3,18	.125	1,40	.055	1,60	.063	0,05	.002	25558319
SPKR1203EDRMS	SPKR1203EDRMS	4	13	.500	12,70	.500	3,18	.125	1,40	.055	1,60	.063	0,05	.002	2561005

## Indexable Milling • Face Milling ISO Inserts • TNHF

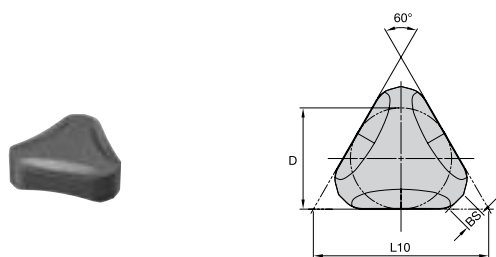

- first choice
- alternate choice

P	■	■
M	■	■
K	■	●
N	■	■
S	■	■
H	■	■

ISO catalog number	ANSI catalog number	cutting edges	D		L10		S		BS		hm		WK15CM
			mm	in	mm	in	mm	in	mm	in	mm	in	
TNHF1204ANCA	TNHF1204ANCA	6	13	.500	22,00	.866	4,76	.188	2,58	.102	0,05	.002	6008686

## Indexable Milling • Face Milling ISO Inserts • TPAN

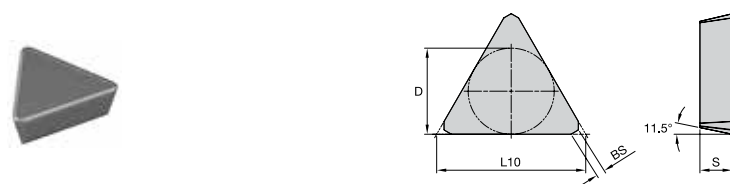

- first choice
- alternate choice

P	■	■	●
M	■	■	●
K	■	■	○
N	■	■	○
S	■	■	○
H	■	■	○

ISO catalog number	ANSI catalog number	cutting edges	D		L10		S		BS		hm		WP35CM	WU20PM
			mm	in	mm	in	mm	in	mm	in	mm	in		
TPAN1103PPN	TPAN1103PPN	3	6	.250	10,96	.432	3,18	.125	0,71	.028	0,04	.002	687241	2557715
TPAN1603PDR	TPAN1603PDR	3	10	.375	16,45	.648	3,18	.125	0,03	.790	0,05	.002	687242	2568655
TPAN1603PPN	TPAN1603PPN	3	10	.375	16,45	.648	3,18	.125	1,17	.046	0,05	.002	687204	2557665
TPAN2204PPN	TPAN2204PPN	3	13	.500	21,96	.865	4,76	.188	1,24	.049	0,06	.002	687210	6869240
TPAN2204PDR	TPAN2204PDR	3	13	.500	21,96	.865	4,76	.188	1,35	.053	0,06	.002	6801236	-
TPAN2204PDR	TPAN2204PDR	3	13	.500	21,96	.865	4,76	.188	1,35	.053	0,07	.003	-	2557789
TPAN22T3AER	TPAN22T3AER	3	13	.512	22,49	.885	3,97	.156	2,11	.083	0,06	.002	687243	-

**Indexable Milling • Shoulder Milling ISO Inserts • APMT**

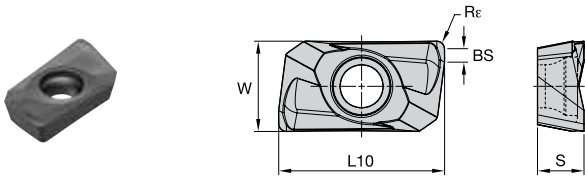

- first choice
- alternate choice

P	●
M	●
K	○
N	○
S	○
H	○

ISO catalog number	ANSI catalog number	cutting edges	L10		W		S		BS		Re		hm		WU20PM
			mm	in	mm	in	mm	in	mm	in	mm	in	mm	in	
APMT1135PDR	APMT1135PDR	2	11,20	.441	5,95	.234	3,50	.138	—	—	0,80	.031	0,05	.002	6196890
APMT1604PDR	APMT1604PDR	2	17,00	.669	9,24	.364	4,76	.188	1,38	.054	0,80	.031	0,05	.002	6196991

**Indexable Milling • Shoulder Milling ISO Inserts • APPT-MM**

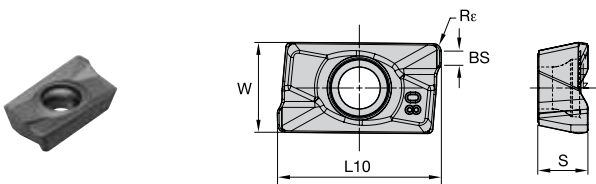

- first choice
- alternate choice

P	●
M	●
K	○
N	○
S	○
H	○

ISO catalog number	ANSI catalog number	cutting edges	L10		W		S		BS		Re		hm		WU20PM
			mm	in	mm	in	mm	in	mm	in	mm	in	mm	in	
APPT100308PDSRMM	APPT100308PDSRMM	2	11,10	.437	6,70	.263	3,56	.140	—	—	0,80	.031	0,07	.003	6620930
APPT160408PDSRMM	APPT160408PDSRMM	2	—	—	9,41	.371	5,26	.207	1,49	.059	0,79	.031	0,06	.002	6443662

























# Solid End Milling

<b>WIDIA Multi-Purpose End Mills</b> .....	<b>B-B91</b>
Selection Guide.....	B4-B20
WCE End Mill • 4 Flute .....	B22-B45
GP End Mills • 2 Flute, 3 Flute, and 4 Flute.....	B46-B91
<b>Burs</b> .....	<b>B92-B115</b>
Single Cut .....	B94-B99
Master Cut .....	B100-B109, B112-B115
Aluminum Cut .....	B109-B112
Burs Sets .....	B115
<b>Hanita High-Performance Solid Carbide End Mills</b> .....	<b>B120-B370</b>
Selection Guide.....	B120-B159
VariMill XTREME .....	B160-B177
VariMill I.....	B178-B200
VariMill II.....	B202-B228
VariMill III ER.....	B230-B239
VariMill Chip Splitter.....	B240-B247
Roughers.....	B248-B266
Finishers.....	B268-B285
ALUFLASH.....	B286-B310
X-Feed .....	B312-B321
Vision Plus.....	B322-B352
HSS End Mills .....	B354-B370

## Multi-Purpose End Mills • Selection Guide • Inch

WIDIA Solid End Milling Portfolio								
	WCE4	WCE4	WCE4	WCE4	WCE4	WCE4	WCE4	
								
UOM	Inch	Inch	Inch	Inch	Inch	Inch	Inch	
Series	W401	W401	W401	W401	W401	W401	W411	
Page	B24	B28	B32	B25	B29	B33	B24	
Flute	4	4	4	4	4	4	4	
Diameter D1	1/8–7/16"	1/8–7/16"	1/8–7/16"	1/2–1"	1/2–1"	1/2–1"	1/8–7/16"	
Shank								
Length of Cut	Regular	Regular	Regular	Regular	Regular	Regular	Long	
Corner Style								
Chamfer Size	–	.010–.020"	–	–	.020"	–	–	
Radius Sizes	–	–	.015–.090"	–	–	.030–.120"	–	
Helix Angle	37° / 39°	37° / 39°	37° / 39°	37° / 39°	37° / 39°	37° / 39°	37° / 39°	
Center Cutting	Yes	Yes	Yes	Yes	Yes	Yes	Yes	
Neck	No	No	No	No	No	No	No	
Materials	<b>P</b> <b>M</b> <b>K</b> <b>S</b> <b>H</b>	<b>P</b> <b>M</b> <b>K</b> <b>S</b> <b>H</b>	<b>P</b> <b>M</b> <b>K</b> <b>S</b> <b>H</b>	<b>P</b> <b>M</b> <b>K</b> <b>S</b> <b>H</b>	<b>P</b> <b>M</b> <b>K</b> <b>S</b> <b>H</b>	<b>P</b> <b>M</b> <b>K</b> <b>S</b> <b>H</b>	<b>P</b> <b>M</b> <b>K</b> <b>S</b> <b>H</b>	<b>P</b> <b>M</b> <b>K</b> <b>S</b> <b>H</b>

INDEXABLE MILLING





















SOLID END MILLING

HOLEMAKING

TAPPING

TURNING

Multi-Purpose End Mills • Selection Guide • Inch

WIDIA Solid End Milling Portfolio							
	WCE4	WCE4	WCE4	WCE4	WCE4	WCE4	WCE4
							
UOM	Inch	Inch	Inch	Inch	Inch	Inch	Inch
Series	W411	W411	W411	W411	W411	W421	W421
Page	B28	B32	B26	B30	B34	B25	B29
Flute	4	4	4	4	4	4	4
Diameter D1	1/8–7/16"	1/8–7/16"	1/2–1"	1/2–1"	1/2–1"	1/4–7/16"	1/4–7/16"
Shank							
Length of Cut	Long	Long	Long	Long	Long	Extended	Extended
Corner Style							
Chamfer Size	.010–.020"	–	–	.020"	–	–	.016–.020"
Radius Sizes	–	.015–.090"	–	–	.015–.090"	–	–
Helix Angle	37° / 39°	37° / 39°	37° / 39°	37° / 39°	37° / 39°	37° / 39°	37° / 39°
Center Cutting	Yes	Yes	Yes	Yes	Yes	Yes	Yes
Neck	No	No	No	No	No	No	No
Materials	<b>P</b> <b>M</b> <b>K</b> <b>S</b> <b>H</b>	<b>P</b> <b>M</b> <b>K</b> <b>S</b> <b>H</b>	<b>P</b> <b>M</b> <b>K</b> <b>S</b> <b>H</b>	<b>P</b> <b>M</b> <b>K</b> <b>S</b> <b>H</b>	<b>P</b> <b>M</b> <b>K</b> <b>S</b> <b>H</b>	<b>P</b> <b>M</b> <b>K</b> <b>S</b> <b>H</b>	<b>P</b> <b>M</b> <b>K</b> <b>S</b> <b>H</b>

INDEXABLE MILLING

SOLID END MILLING

HOLEMAKING

TAPPING

TURNING

## Multi-Purpose End Mills • Selection Guide • Inch





















INDEXABLE MILLING

SOLID END MILLING



















HOLEMAKING

TAPPING

TURNING

WIDIA Solid End Milling Portfolio							
	WCE4	WCE4	WCE4	WCE4	WCE4	WCE4	WCE4
							
UOM	Inch	Inch	Inch	Inch	Inch	Inch	Inch
Series	W421	W421	W421	W421	W431	W431	W431
Page	B33	B26	B30	B34	B27	B31	B35
Flute	4	4	4	4	4	4	4
Diameter D1	1/4–3/8"	1/2–3/4"	1/2–1"	1/2–1"	1/2–1"	1/2–1"	1/2–1"
Shank							
Length of Cut	Extended	Extended	Extended	Extended	X-Long	X-Long	X-Long
Corner Style							
Chamfer Size	–	–	.020"	–	–	.020"	–
Radius Sizes	.015–.090"	–	–	.030–.120"	–	–	.030–.120"
Helix Angle	37° / 39°	37° / 39°	37° / 39°	37° / 39°	37° / 39°	37° / 39°	37° / 39°
Center Cutting	Yes	Yes	Yes	Yes	Yes	Yes	Yes
Neck	No	No	No	No	No	No	No
Materials	<b>P</b> <b>M</b> <b>K</b> <b>S</b> <b>H</b>	<b>P</b> <b>M</b> <b>K</b> <b>S</b> <b>H</b>	<b>P</b> <b>M</b> <b>K</b> <b>S</b> <b>H</b>	<b>P</b> <b>M</b> <b>K</b> <b>S</b> <b>H</b>	<b>P</b> <b>M</b> <b>K</b> <b>S</b> <b>H</b>	<b>P</b> <b>M</b> <b>K</b> <b>S</b> <b>H</b>	<b>P</b> <b>M</b> <b>K</b> <b>S</b> <b>H</b>

Multi-Purpose End Mills • Selection Guide • Inch

WIDIA Solid End Milling Portfolio						
	WCE4	WCE4	WCE4	WCE4	WCE4	WCE4
						
UOM	Inch	Inch	Inch	Inch	Inch	Inch
Series	W441	W441	W441	W40B	W40B	W41B
Page	B27	B31	B35	B36	B36	B37
Flute	4	4	4	4	4	4
Diameter D1	1/2"	1/2"	1/2"	1/8–3/8"	1/2–1"	1/2"
Shank						
Length of Cut	X-Long	X-Long	X-Long	Regular	Regular	Long
Corner Style						
Chamfer Size	–	.020"	–	–	–	–
Radius Sizes	–	–	.030–.120"	–	–	–
Helix Angle	37° / 39°	37° / 39°	37° / 39°	38°	38°	38°
Center Cutting	Yes	Yes	Yes	Yes	Yes	Yes
Neck	No	No	No	No	No	No
Materials	<b>P</b> <b>M</b> <b>K</b> <b>S</b> <b>H</b>	<b>P</b> <b>M</b> <b>K</b> <b>S</b> <b>H</b>	<b>P</b> <b>M</b> <b>K</b> <b>S</b> <b>H</b>	<b>P</b> <b>M</b> <b>K</b> <b>S</b> <b>H</b>	<b>P</b> <b>M</b> <b>K</b> <b>S</b> <b>H</b>	<b>P</b> <b>M</b> <b>K</b> <b>S</b> <b>H</b>

INDEXABLE MILLING















SOLID END MILLING

HOLEMAKING

TAPPING

TURNING

## Multi-Purpose End Mills • Selection Guide • Inch

WIDIA Solid End Milling Portfolio					
	GP	GP	GP	GP	GP
					
UOM	Inch	Inch	Inch	Inch	Inch
Series	I2S	I2R	I2B	I3S	I3S
Page	B48-B49	B50	B51	B52	B52
Flute	2	2	2	3	3
Diameter D1	1/64–1"	1/16–1"	1/32–1"	1/32–1"	1/32–1"
Shank					
Length of Cut	Regular	Regular	Regular	Regular	Regular
Corner Style					
Chamfer Size	–	–	–	–	–
Radius Sizes	–	.010–.125"	–	1/32–1"	1/2–1"
Helix Angle	30°	30°	30°	30°	30°
Center Cutting	Yes	Yes	Yes	Yes	Yes
Neck	No	No	No	No	No
Materials	<b>P M K N</b>	<b>P M K N</b>	<b>P M K N</b>	<b>P M K N</b>	<b>P M K N</b>

INDEXABLE MILLING

















SOLID END MILLING

HOLEMAKING

TAPPING

TURNING

Multi-Purpose End Mills • Selection Guide • Inch

WIDIA Solid End Milling Portfolio				
	GP	GP	GP	GP
				
UOM	Inch	Inch	Inch	Inch
Series	I4S	I4S	I4R	I4B
Page	B53	B53	B55	B56
Flute	4	4	4	4
Diameter D1	1/64–1 1/4"	1/2–1"	1/16–1"	1/32–1"
Shank				
Length of Cut	Regular	Regular	Regular	Regular
Corner Style				
Chamfer Size	–	–	–	–
Radius Sizes	–	–	.010–.125"	–
Helix Angle	30°	30°	30°	30°
Center Cutting	Yes	Yes	Yes	Yes
Neck	No	No	No	No
Materials				

INDEXABLE MILLING

SOLID END MILLING

























HOLE/MAKING

TAPPING

TURNING



## Multi-Purpose End Mills • Selection Guide • Metric

WIDIA Solid End Milling Portfolio						
	WCE4	WCE4	WCE4	WCE4	WCE4	WCE4
						
<b>UOM</b>	Metric	Metric	Metric	Metric	Metric	Metric
<b>Series</b>	W401	W401	W401	W401	W4N1	W411
<b>Page</b>	B37	B38	B38	B39	B39-B40	B40
<b>Flute</b>	4	4	4	4	4	4
<b>Diameter D1</b>	3–20mm	3–20mm	3–20mm	3–20mm	3–20mm	6–20mm
<b>Shank</b>						
<b>Length of Cut</b>	Regular	Regular	Regular	Regular	Regular	Long
<b>Corner Style</b>						
<b>Chamfer Size</b>	–	–	0,40–0,50mm	0,40–0,50mm	–	0,40–0,50mm
<b>Radius Sizes</b>	–	–	–	–	0,2–3mm	–
<b>Helix Angle</b>	37° / 39°	37° / 39°	37° / 39°	37° / 39°	37° / 39°	37° / 39°
<b>Center Cutting</b>	Yes	Yes	Yes	Yes	Yes	Yes
<b>Neck</b>	No	No	No	No	Yes	No
<b>Materials</b>						

INDEXABLE MILLING







SOLID END MILLING

HOLEMAKING

TAPPING

TURNING

Multi-Purpose End Mills • Selection Guide • Metric

WIDIA Solid End Milling Portfolio		
	WCE4	WCE4
		
UOM	Metric	Metric
Series	W4NB	W4NB
Page	B41	B41
Flute	4	4
Diameter D1	5–20mm	5–20mm
Shank		
Length of Cut	Regular	Regular
Corner Style		
Chamfer Size	–	–
Radius Sizes	–	–
Helix Angle	38°	38°
Center Cutting	Yes	Yes
Neck	Yes	Yes
Materials	<b>P</b> <b>M</b> <b>K</b> <b>S</b> <b>H</b>	<b>P</b> <b>M</b> <b>K</b> <b>S</b> <b>H</b>

INDEXABLE MILLING

SOLID END MILLING

HOLE/MAKING

TAPPING

TURNING

## Multi-Purpose End Mills • Selection Guide • Metric



INDEXABLE MILLING

SOLID END MILLING





























HOLEMAKING

TAPPING

TURNING

WIDIA Solid End Milling Portfolio						
	GP	GP	GP	GP	GP	GP
						
UOM	Metric	Metric	Metric	Metric	Metric	Metric
Series	4002	4002	4012	4012	D002	D002
Page	B57-B58	B57-B58	B57-B58	B57-B58	B59	B59
Flute	2	2	2	2	2	2
Diameter D1	1-20mm	1-20mm	1-20mm	1-20mm	2-20mm	2-20mm
Shank						
Length of Cut	Regular	Regular	Long	Long	Regular	Regular
Corner Style						
Chamfer Size	-	0,1-0,3mm	-	0,1-0,3mm	-	0,1-0,3mm
Radius Sizes	-	-	-	-	-	-
Helix Angle	30°	30°	30°	30°	30°	30°
Center Cutting	Yes	Yes	Yes	Yes	Yes	Yes
Neck	No	No	No	No	No	No
Materials						

Multi-Purpose End Mills • Selection Guide • Metric

WIDIA Solid End Milling Portfolio							
	GP	GP	GP	GP	GP	GP	GP
							
UOM	Metric	Metric	Metric	Metric	Metric	Metric	Metric
Series	D002	D002	D002	D002	D002	D002	2819
Page	B59	B59	B59	B59	B59	B59	B60
Flute	2	2	2	2	2	2	2
Diameter D1	12–20mm	12–20mm	2,5–20mm	2,5–20mm	2,5–20mm	2,5–20mm	3–20mm
Shank							
Length of Cut	Regular	Regular	Regular	Regular	Regular	Regular	Regular
Corner Style							
Chamfer Size	–	0,1–0,3mm	–	0,1–0,3mm	–	0,1–0,3mm	–
Radius Sizes	–	–	–	–	–	–	–
Helix Angle	30°	30°	30°	30°	30°	30°	30°
Center Cutting	Yes	Yes	Yes	Yes	Yes	Yes	Yes
Neck	No	No	No	No	No	No	No
Materials							

INDEXABLE MILLING





























SOLID END MILLING

HOLEMAKING

TAPPING

TURNING

## Multi-Purpose End Mills • Selection Guide • Metric

WIDIA Solid End Milling Portfolio							
	GP	GP	GP	GP	GP	GP	GP
							
UOM	Metric	Metric	Metric	Metric	Metric	Metric	Metric
Series	2819	4001	4011	4021	D001	D011	2838
Page	B60	B61	B61	B61	B62	B62	B62
Flute	2	2	2	2	2	2	2
Diameter D1	3–20mm	1–20mm	1–20mm	1–20mm	2–20mm	3–20mm	2–16mm
Shank							
Length of Cut	Regular	Regular	Long	Extended	Regular	Long	Regular
Corner Style							
Chamfer Size	0,1–0,3mm	–	–	–	–	–	–
Radius Sizes	–	–	–	–	–	–	–
Helix Angle	30°	30°	30°	30°	30°	30°	30°
Center Cutting	Yes	Yes	Yes	Yes	Yes	Yes	Yes
Neck	No	No	No	No	No	No	No
Materials							

INDEXABLE MILLING





























SOLID END MILLING

HOLEMAKING

TAPPING

TURNING

Multi-Purpose End Mills • Selection Guide • Metric

WIDIA Solid End Milling Portfolio							
	GP	GP	GP	GP	GP	GP	GP
							
UOM	Metric	Metric	Metric	Metric	Metric	Metric	Metric
Series	4003..S	4003..S	4013..S	4013..S	4003	4003	4013
Page	B63	B63	B63	B63	B64	B64	B64
Flute	3	3	3	3	3	3	3
Diameter D1	1–20mm	6–16mm	3–20mm	3–20mm	4–16mm	6–16mm	4–20mm
Shank							
Length of Cut	Reguar	Regular	Regular	Regular	Regular	Regular	Long
Corner Style							
Chamfer Size	–	–	–	–	–	–	–
Radius Sizes	–	–	–	–	–	–	–
Helix Angle	30°	30°	30°	30°	30°	30°	30°
Center Cutting	Yes	Yes	Yes	Yes	Yes	Yes	Yes
Neck	No	No	No	No	No	No	No
Materials							

INDEXABLE MILLING





























SOLID END MILLING

HOLEMAKING

TAPPING

TURNING

## Multi-Purpose End Mills • Selection Guide • Metric

WIDIA Solid End Milling Portfolio							
	GP	GP	GP	GP	GP	GP	GP
							
UOM	Metric	Metric	Metric	Metric	Metric	Metric	Metric
Series	4013	D003..S	D003..S	D013..S	D013..S	D003	D003
Page	B64	B65	B65	B65	B65	B66	B66
Flute	3	3	3	3	3	3	3
Diameter D1	5–20mm	2–20mm	2–20mm	2–20mm	2–20mm	4–20mm	4–20mm
Shank							
Length of Cut	Long	Regular	Regular	Long	Long	Regular	Regular
Corner Style							
Chamfer Size	–	–	–	–	–	0,1–0,3mm	0,1–0,3mm
Radius Sizes	–	–	–	–	–	–	–
Helix Angle	30°	30°	30°	30°	30°	30°	30°
Center Cutting	Yes	Yes	Yes	Yes	Yes	Yes	Yes
Neck	No	No	No	No	No	No	No
Materials							

INDEXABLE MILLING





























SOLID END MILLING

HOLEMAKING

TAPPING

TURNING

Multi-Purpose End Mills • Selection Guide • Metric

WIDIA Solid End Milling Portfolio							
	GP	GP	GP	GP	GP	GP	GP
							
UOM	Metric	Metric	Metric	Metric	Metric	Metric	Metric
Series	D013	D013	4004	4004	4004	4014	4014
Page	B66	B66	B67-B68	B67-B68	B69	B67-B68	B67-B68
Flute	3	3	4	4	4	4	4
Diameter D1	4-20mm	4-20mm	1-20mm	1-20mm	2-20mm	3-20mm	3-20mm
Shank							
Length of Cut	Long	Long	Regular	Regular	Regular	Long	Long
Corner Style							
Chamfer Size	0,1-0,3mm	0,1-0,3mm	-	0,1-0,3mm	-	-	0,1-0,3mm
Radius Sizes	-	-	-	-	0,5-1mm	-	-
Helix Angle	30°	30°	30°	30°	30°	30°	30°
Center Cutting	Yes	Yes	Yes	Yes	Yes	Yes	Yes
Neck	No	No	No	No	No	No	No
Materials							

INDEXABLE MILLING

SOLID END MILLING





























HOLEMAKING

TAPPING

TURNING



## Multi-Purpose End Mills • Selection Guide • Metric

WIDIA Solid End Milling Portfolio							
	GP	GP	GP	GP	GP	GP	GP
							
UOM	Metric	Metric	Metric	Metric	Metric	Metric	Metric
Series	4014	4024	4024	4024	D004	D004	D004
Page	B69	B67-B68	B67-B68	B69	B70-B71	B70-B71	B70-B71
Flute	4	4	4	4	4	4	4
Diameter D1	3–20mm	3–20mm	3–20mm	3–20mm	2–20mm	4–20mm	12–20mm
Shank							
Length of Cut	Long	Extended	Extended	Extended	Regular	Regular	Regular
Corner Style							
Chamfer Size	–	–	0,1–0,3mm	–	–	0,1–0,3mm	–
Radius Sizes	0,5–1mm	–	–	0,5–1mm	–	–	–
Helix Angle	30°	30°	30°	30°	30°	30°	30°
Center Cutting	Yes	Yes	Yes	Yes	Yes	Yes	Yes
Neck	No	No	No	No	No	No	No
Materials							

INDEXABLE MILLING





























SOLID END MILLING

HOLEMAKING

TAPPING

TURNING

Multi-Purpose End Mills • Selection Guide • Metric

WIDIA Solid End Milling Portfolio							
	GP	GP	GP	GP	GP	GP	GP
							
UOM	Metric	Metric	Metric	Metric	Metric	Metric	Metric
Series	D004	D014	D014	D014	D014	2528	2528
Page	B70-B71	B70-B71	B70-B71	B70-B71	B70-B71	B72	B72
Flute	4	4	4	4	4	4	4
Diameter D1	12–20mm	2–20mm	4–20mm	12–20mm	12–20mm	4–20mm	4–20mm
Shank							
Length of Cut	Regular	Long	Long	Long	Long	Regular	Regular
Corner Style							
Chamfer Size	0,1–0,3mm	–	0,1–0,3mm	–	0,1–0,3mm	–	0,1–0,3mm
Radius Sizes	–	–	–	–	–	–	–
Helix Angle	30°	30°	30°	30°	30°	30°	30°
Center Cutting	Yes	Yes	Yes	Yes	Yes	Yes	Yes
Neck	No	No	No	No	No	No	No
Materials							

INDEXABLE MILLING

















SOLID END MILLING

HOLEMAKING

TAPPING

TURNING

## Multi-Purpose End Mills • Selection Guide • Metric

WIDIA Solid End Milling Portfolio				
	GP	GP	GP	GP
				
UOM	Metric	Metric	Metric	Metric
Series	4000	4010	D010	2848
Page	B73	B73	B74	B75
Flute	4	4	4	4
Diameter D1	2–20mm	3–20mm	3–20mm	4–20mm
Shank				
Length of Cut	Regular	Long	Regular	Regular
Corner Style				
Chamfer Size	–	–	–	–
Radius Sizes	–	–	–	–
Helix Angle	30°	30°	30°	30°
Center Cutting	Yes	Yes	Yes	Yes
Neck	No	No	No	No
Materials				

INDEXABLE MILLING

SOLID END MILLING

HOLEMAKING

TAPPING

TURNING



# WCE End Mill

Versatile Solid Carbide End Mills • Roughing/Finishing

The WCE solid end milling line features an advanced geometry to enable material versatility for end users seeking a cost-effective solution while machining small batches.



WCE4, 4-flute geometry combines the asymmetrical index and variable helix features at an affordable price while ensuring material and application versatility, including demanding operations like full slots and heavy cuts.

## VERSATILE

Designed for use on multiple materials, including steel, stainless steel, and cast iron.

## RELIABLE

Advanced design, coating, and geometry — including asymmetrical index and variable helix — combined to improve performance and offer consistent tool life.

## AFFORDABLE

Attractively priced for small-to-medium shops that change machine setup often and need to know they can count on the tool without worrying about specific geometries or grades.

# AFFORDABLE PERFORMANCE

## PRODUCT

### GRADE

WU20PD

### FLUTES

4

### DIAMETER RANGE

1/8–1" (3–20mm)

## CORNER CONDITIONS

Sharp Edges  
Chamfered  
Radiused  
Ball Nose

## INDUSTRY



## MATERIALS

### FIRST CHOICE



### SECOND CHOICE



## APPLICATIONS



SIDE/  
SHOULDER  
MILLING  
ROUGHING



SLOTTING  
SQUARE  
END



HELICAL  
MILLING



RAMPING  
BLANK



PLUNGE  
MILLING



3D  
PROFILING

## VARIABLE HELIX

to reduce vibrations and  
increase overall cutting stability.

## ECCENTRIC RELIEF

to provide vibration dampening and  
increase tool life on stainless steels.

## CORE APER

for improved chip evacuation  
and tool stability.

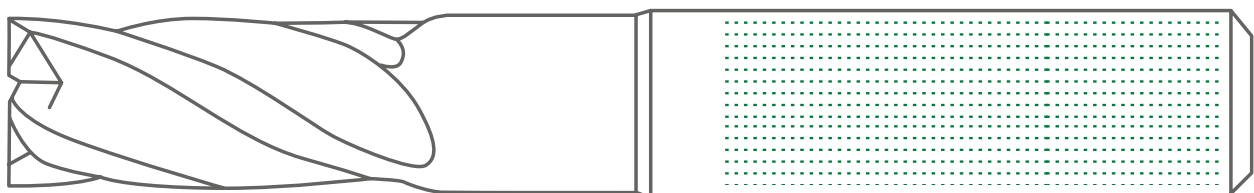

INDEXABLE MILLING

## WCE4 • Series W401 • Sharp Edge • 4 Flute • Cylindrical Shank • Inch

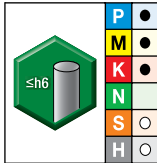
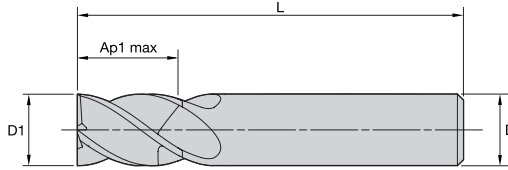

WU20PE

- first choice
- alternate choice

order #	catalog #	D1	D	length of cut Ap1 max	length L	Z U
6945540	W401E03000SZT	1/8	1/8	1/4	1 1/2	4
6945591	W401E05001SZT	3/16	3/16	5/16	2	4
6945592	W401E07003SZT	1/4	1/4	3/8	2	4
6945583	W401E08004SZT	5/16	5/16	1/2	2	4
6945584	W401E10005SZT	3/8	3/8	1/2	2	4
6945696	W401E1100DSZT	7/16	7/16	5/8	2 1/2	4

SOLID END MILLING

HOLEMAKING

## WCE4 • Series W411 • Sharp Edge • 4 Flute • Cylindrical Shank • Inch

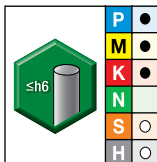
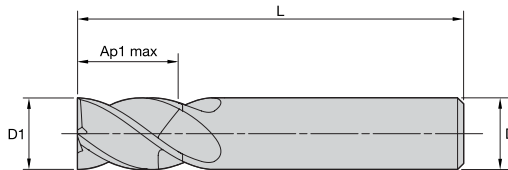

WU20PE

- first choice
- alternate choice

order #	catalog #	D1	D	length of cut Ap1 max	length L	Z U
6945917	W411E03010SZT	1/8	1/8	1/2	2	4
6945593	W411E05011SZT	3/16	3/16	5/8	2 1/4	4
6945595	W411E07013SZT	1/4	1/4	3/4	2 1/2	4
6945585	W411E08014SZT	5/16	5/16	3/4	2 1/2	4
6945586	W411E10015SZT	3/8	3/8	7/8	2 1/2	4
6945711	W411E1101DSZT	7/16	7/16	7/8	2 1/2	4

TAPPING

TURNING

**WCE4 • Series W421 • Sharp Edge • 4 Flute • Cylindrical Shank • Inch**

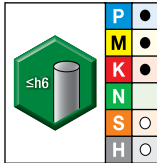
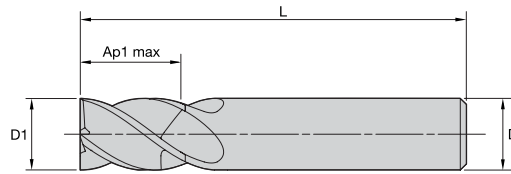

WU20PE

● first choice  
○ alternate choice

order #	catalog #	D1	D	length of cut Ap1 max	length L	Z U
6945918	W421E07023SZT	1/4	1/4	1 1/4	3 1/4	4
6945945	W421E08024SZT	5/16	5/16	1 1/4	3 1/4	4
6945946	W421E10025SZT	3/8	3/8	1 1/2	4	4
6946188	W421E1102DSZT	7/16	7/16	2	4	4

**WCE4 • Series W401 • Sharp Edge • 4 Flute • Weldon® Shank • Inch**

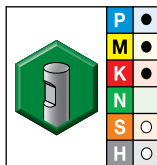
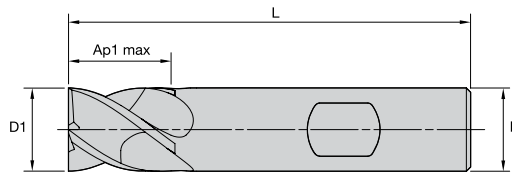

WU20PE

● first choice  
○ alternate choice

order #	catalog #	D1	D	length of cut Ap1 max	length L	Z U
6945697	W401E13006SZW	1/2	1/2	5/8	2 1/2	4
6945698	W401E16008SZW	5/8	5/8	3/4	3	4
6945699	W401E19009SZW	3/4	3/4	7/8	3 1/2	4
6945700	W401E2500ASZW	1	1	1 1/2	4	4

INDEXABLE MILLING

SOLID END MILLING

HOLEMAKING

TAPPING

TURNING



INDEXABLE MILLING

SOLID END MILLING

HOLE MAKING

TAPPING

TURNING

## WCE4 • Series W411 • Sharp Edge • 4 Flute • Weldon® Shank • Inch

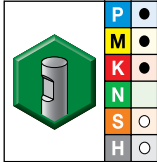
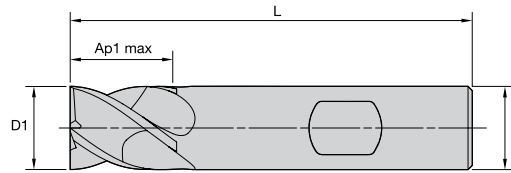

WU20PE

● first choice  
○ alternate choice

order #	catalog #	D1	D	length of cut Ap1 max	length L	Z U
6945712	W411E13016SZW	1/2	1/2	1 1/4	3	4
6945713	W411E16018SZW	5/8	5/8	1 1/4	3 1/2	4
6945714	W411E19019SZW	3/4	3/4	1 1/2	4	4
6945715	W411E2501ASZW	1	1	2	5	4

## WCE4 • Series W421 • Sharp Edge • 4 Flute • Weldon Shank • Inch

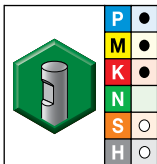
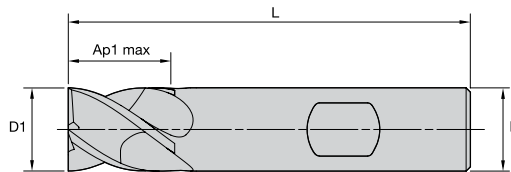

WU20PE

● first choice  
○ alternate choice

order #	catalog #	D1	D	length of cut Ap1 max	length L	Z U
6945716	W421E13026SZW	1/2	1/2	1 1/2	4	4
6945717	W421E16028SZW	5/8	5/8	1 5/8	4 1/8	4
6945718	W421E19029SZW	3/4	3/4	2 1/4	5	4

WCE4 • Series W431 • Sharp Edge • 4 Flute • Weldon® Shank • Inch

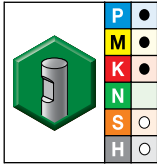
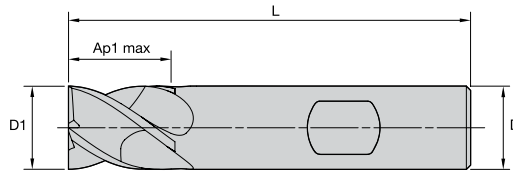

WU20PE

● first choice  
○ alternate choice

order #	catalog #	D1	D	length of cut Ap1 max	length L	Z U
6946189	W431E13036SZW	1/2	1/2	2	4	4
6946190	W431E19039SZW	3/4	3/4	3	6	4
6946291	W431E2503ASZW	1	1	4	7	4

WCE4 • Series W441 • Sharp Edge • 4 Flute • Weldon Shank • Inch

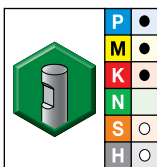
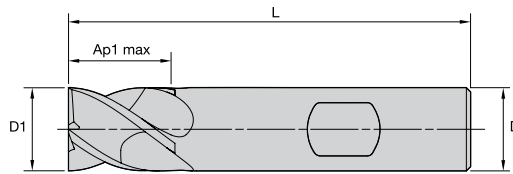

WU20PE

● first choice  
○ alternate choice

order #	catalog #	D1	D	length of cut Ap1 max	length L	Z U
6946292	W441E13046SZW	1/2	1/2	2 1/2	4 1/2	4

INDEXABLE MILLING

SOLID END MILLING

HOLEMAKING

TAPPING

TURNING

## WCE4 • Series W401 • Chamfered • 4 Flute • Cylindrical Shank • Inch

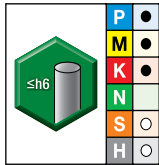
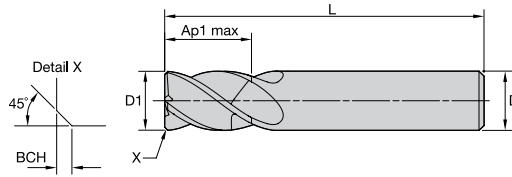

WU20PE

- first choice
- alternate choice

order #	catalog #	D1	D	length of cut Ap1 max	length L	BCH	Z U
6945596	W401E03000CHT	1/8	1/8	1/4	1 1/2	.010	4
6945597	W401E05001CHT	3/16	3/16	5/16	2	.010	4
6945598	W401E07003CYT	1/4	1/4	3/8	2	.016	4
6945587	W401E08004CYT	5/16	5/16	1/2	2	.016	4
6945588	W401E10005CTT	3/8	3/8	1/2	2	.020	4
6945720	W401E1100DCTT	7/16	7/16	5/8	2 1/2	.020	4

## WCE4 • Series W411 • Chamfered • 4 Flute • Cylindrical Shank • Inch

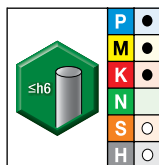
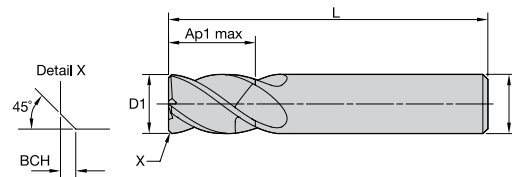

WU20PE

- first choice
- alternate choice

order #	catalog #	D1	D	length of cut Ap1 max	length L	BCH	Z U
6945919	W411E03010CHT	1/8	1/8	1/2	2	.010	4
6945599	W411E05011CHT	3/16	3/16	5/8	2 1/4	.010	4
6945600	W411E07013CYT	1/4	1/4	3/4	2 1/2	.016	4
6945589	W411E08014CYT	5/16	5/16	3/4	2 1/2	.016	4
6945590	W411E10015CTT	3/8	3/8	7/8	2 1/2	.020	4
6945725	W411E1101DCTT	7/16	7/16	7/8	2 1/2	.020	4

**WCE4 • Series W421 • Chamfered • 4 Flute • Cylindrical Shank • Inch**

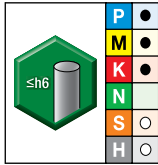
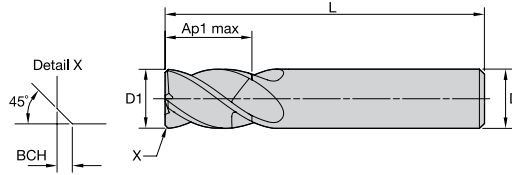

● first choice  
○ alternate choice

WU20PE

order #	catalog #	D1	D	length of cut Ap1 max	length L	BCH	Z U
6945920	W421E07023CYT	1/4	1/4	1 1/4	3 1/4	.016	4
6945947	W421E08024CYT	5/16	5/16	1 1/4	3 1/4	.016	4
6945948	W421E10025CTT	3/8	3/8	1 1/2	4	.020	4
6946293	W421E1102DCTT	7/16	7/16	2	4	.020	4

**WCE4 • Series W401 • Chamfered • 4 Flute • Weldon® Shank • Inch**

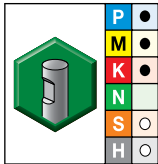
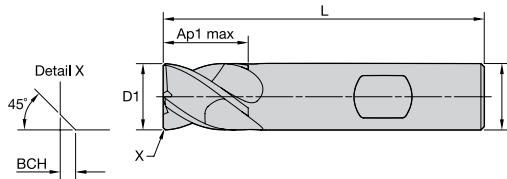

● first choice  
○ alternate choice

WU20PE

order #	catalog #	D1	D	length of cut Ap1 max	length L	BCH	Z U
6945721	W401E13006CTW	1/2	1/2	5/8	2 1/2	.020	4
6945722	W401E16008CTW	5/8	5/8	3/4	3	.020	4
6945723	W401E19009CTW	3/4	3/4	7/8	3 1/2	.020	4
6945724	W401E2500ACTW	1	1	1 1/2	4	.020	4

## WCE4 • Series W411 • Chamfered • 4 Flute • Weldon® Shank • Inch

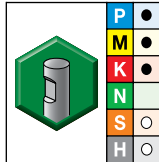
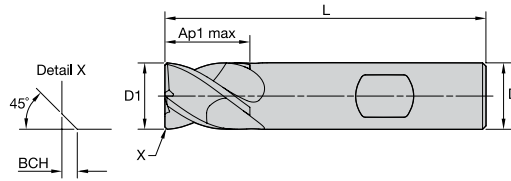

WU20PE

- first choice
- alternate choice

order #	catalog #	D1	D	length of cut Ap1 max	length L	BCH	Z U
6945726	W411E13016CTW	1/2	1/2	1 1/4	3	.020	4
6945727	W411E16018CTW	5/8	5/8	1 1/4	3 1/2	.020	4
6945728	W411E19019CTW	3/4	3/4	1 1/2	4	.020	4
6945729	W411E2501ACTW	1	1	2	5	.020	4

## WCE4 • Series W421 • Chamfered • 4 Flute • Weldon Shank • Inch

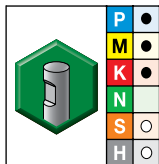
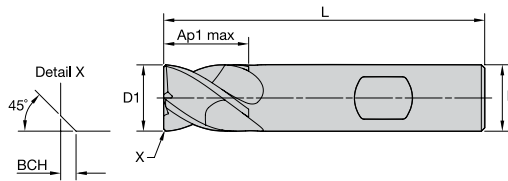

WU20PE

- first choice
- alternate choice

order #	catalog #	D1	D	length of cut Ap1 max	length L	BCH	Z U
6945730	W421E13026CTW	1/2	1/2	1 1/2	4	.020	4
6945731	W421E16028CTW	5/8	5/8	1 5/8	4 1/8	.020	4
6945732	W421E19029CTW	3/4	3/4	2 1/4	5	.020	4
6945733	W421E2502ACTW	1	1	3	6	.020	4

INDEXABLE MILLING

SOLID END MILLING

HOLEMAKING

TAPPING

TURNING

WCE4 • Series W431 • Chamfered • 4 Flute • Weldon® Shank • Inch

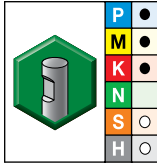
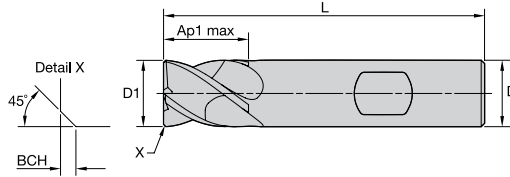

WU20PE

● first choice  
○ alternate choice

order #	catalog #	D1	D	length of cut Ap1 max	length L	BCH	Z U
6946294	W431E13036CTW	1/2	1/2	2	4	.020	4
6946295	W431E19039CTW	3/4	3/4	3	6	.020	4
6946296	W431E2503ACTW	1	1	4	7	.020	4

WCE4 • Series W441 • Chamfered • 4 Flute • Weldon Shank • Inch

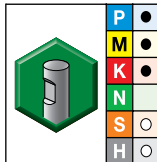
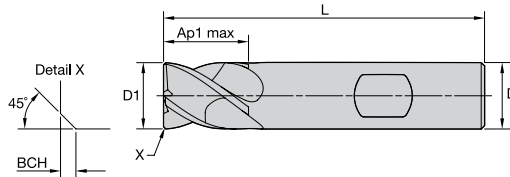

WU20PE

● first choice  
○ alternate choice

order #	catalog #	D1	D	length of cut Ap1 max	length L	BCH	Z U
6946297	W441E13046CTW	1/2	1/2	2 1/2	4 1/2	.020	4

## WCE4 • Series W401 • Radiused • 4 Flute • Cylindrical Shank • Inch

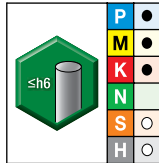
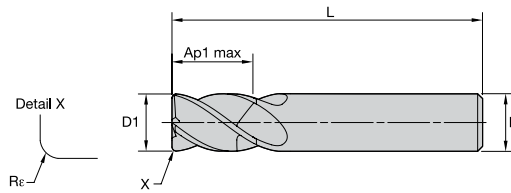

WU20PE

- first choice
- alternate choice

order #	catalog #	D1	D	length of cut Ap1 max	length L	Re	Z U
6945648	W401E03000RAT	1/8	1/8	1/4	1 1/2	.015	4
6945649	W401E05001RAT	3/16	3/16	3/16	2	.015	4
6945650	W401E05001RET	3/16	3/16	5/16	2	.030	4
6945651	W401E07003RAT	1/4	1/4	3/8	2	.015	4
6945652	W401E07003RET	1/4	1/4	3/8	2	.030	4
6945653	W401E07003RGT	1/4	1/4	3/8	2	.060	4
6945659	W401E08004RAT	5/16	5/16	1/2	2	.015	4
6945660	W401E08004RET	5/16	5/16	1/2	2	.030	4
6945671	W401E08004RGT	5/16	5/16	1/2	2	.060	4
6945672	W401E10005RAT	3/8	3/8	1/2	2	.015	4
6945673	W401E10005RET	3/8	3/8	1/2	2	.030	4
6945674	W401E10005RGT	3/8	3/8	1/2	2	.060	4
6945675	W401E10005RJT	3/8	3/8	1/2	2	.090	4

## WCE4 • Series W411 • Radiused • 4 Flute • Cylindrical Shank • Inch

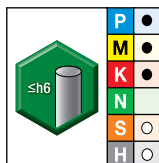
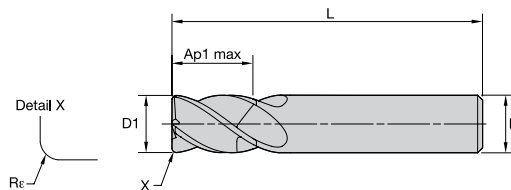

WU20PE

- first choice
- alternate choice

order #	catalog #	D1	D	length of cut Ap1 max	length L	Re	Z U
6945941	W411E03010RAT	1/8	1/8	1/2	2	.015	4
6945654	W411E05011RAT	3/16	3/16	5/8	2 1/4	.015	4
6945655	W411E05011RET	3/16	3/16	5/8	2 1/4	.030	4
6945656	W411E07013RAT	1/4	1/4	3/4	2 1/2	.015	4
6945657	W411E07013RET	1/4	1/4	3/4	2 1/2	.030	4
6945658	W411E07013RGT	1/4	1/4	3/4	2 1/2	.060	4
6945676	W411E08014RAT	5/16	5/16	3/4	2 1/2	.015	4
6945677	W411E08014RET	5/16	5/16	3/4	2 1/2	.030	4
6945678	W411E08014RGT	5/16	5/16	3/4	2 1/2	.060	4
6945679	W411E10015RAT	3/8	3/8	7/8	2 1/2	.015	4
6945680	W411E10015RET	3/8	3/8	7/8	2 1/2	.030	4
6945681	W411E10015RGT	3/8	3/8	7/8	2 1/2	.060	4
6945682	W411E10015RJT	3/8	3/8	7/8	2 1/2	.090	4

## WCE4 • Series W421 • Radiused • 4 Flute • Cylindrical Shank • Inch

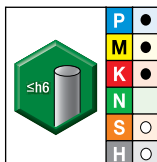
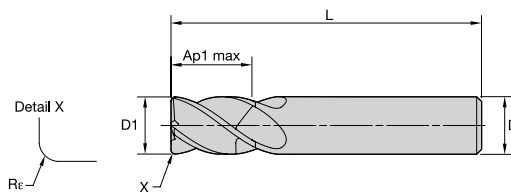

WU20PE

● first choice

○ alternate choice

order #	catalog #	D1	D	length of cut Ap1 max	length L	Re	Z U
6945942	W421E07023RAT	1/4	1/4	1 1/4	3 1/4	.015	4
6945943	W421E07023RET	1/4	1/4	1 1/4	3 1/4	.030	4
6945944	W421E07023RGT	1/4	1/4	1 1/4	3 1/4	.060	4
6945949	W421E08024RAT	5/16	5/16	1 1/4	3 1/4	.015	4
6945950	W421E08024RET	5/16	5/16	1 1/4	3 1/4	.030	4
6945951	W421E08024RGT	5/16	5/16	1 1/4	3 1/4	.060	4
6945952	W421E10025RAT	3/8	3/8	1 1/2	4	.015	4
6945953	W421E10025RET	3/8	3/8	1 1/2	4	.030	4
6945954	W421E10025RGT	3/8	3/8	1 1/2	4	.060	4
6945955	W421E10025RJT	3/8	3/8	1 1/2	4	.090	4

## WCE4 • Series W401 • Radiused • 4 Flute • Weldon® Shank • Inch

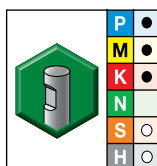
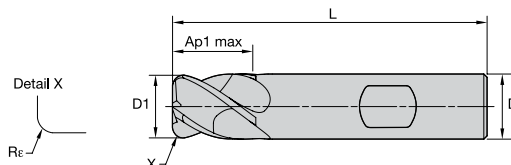

WU20PE

● first choice

○ alternate choice

order #	catalog #	D1	D	length of cut Ap1 max	length L	Re	Z U
6945817	W401E13006REW	1/2	1/2	5/8	2 1/2	.030	4
6945818	W401E13006RGW	1/2	1/2	5/8	2 1/2	.060	4
6945819	W401E13006RJW	1/2	1/2	5/8	2 1/2	.090	4
6945820	W401E13006RKW	1/2	1/2	5/8	2 1/2	.120	4
6945841	W401E16008REW	5/8	5/8	3/4	3	.030	4
6945842	W401E16008RGW	5/8	5/8	3/4	3	.060	4
6945843	W401E16008RKW	5/8	5/8	3/4	3	.120	4
6945844	W401E19009REW	3/4	3/4	7/8	3 1/2	.030	4
6945845	W401E19009RGW	3/4	3/4	7/8	3 1/2	.060	4
6945846	W401E19009RJW	3/4	3/4	7/8	3 1/2	.090	4
6945847	W401E19009RKW	3/4	3/4	7/8	3 1/2	.120	4
6945848	W401E2500AREW	1	1	1 1/2	4	.030	4
6945849	W401E2500ARGW	1	1	1 1/2	4	.060	4
6945850	W401E2500ARJW	1	1	1 1/2	4	.090	4
6945851	W401E2500ARKW	1	1	1 1/2	4	.120	4



## WCE4 • Series W411 • Radiused • 4 Flute • Weldon® Shank • Inch

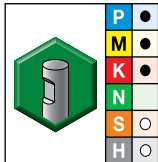
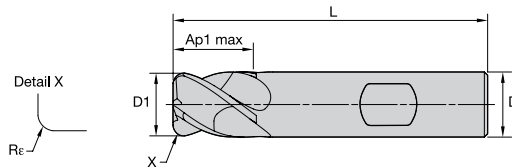

WU20PE

- first choice
- alternate choice

order #	catalog #	D1	D	length of cut Ap1 max	length L	Rε	Z U
6945852	W411E13016REW	1/2	1/2	1 1/4	3	.030	4
6945853	W411E13016RGW	1/2	1/2	1 1/4	3	.060	4
6945854	W411E13016RJW	1/2	1/2	1 1/4	3	.090	4
6945855	W411E13016RKW	1/2	1/2	1 1/4	3	.120	4
6945856	W411E16018REW	5/8	5/8	1 1/4	3 1/2	.030	4
6945857	W411E16018RGW	5/8	5/8	1 1/4	3 1/2	.060	4
6945858	W411E16018RKW	5/8	5/8	1 1/4	3 1/2	.120	4
6945859	W411E19019REW	3/4	3/4	1 1/2	4	.030	4
6945860	W411E19019RGW	3/4	3/4	1 1/2	4	.060	4
6945861	W411E19019RJW	3/4	3/4	1 1/2	4	.090	4
6945862	W411E19019RKW	3/4	3/4	1 1/2	4	.120	4
6945863	W411E2501AREW	1	1	2	5	.030	4
6945864	W411E2501ARGW	1	1	2	5	.060	4
6945865	W411E2501ARJW	1	1	2	5	.090	4
6945866	W411E2501ARKW	1	1	2	5	.120	4

## WCE4 • Series W421 • Radiused • 4 Flute • Weldon Shank • Inch

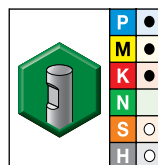
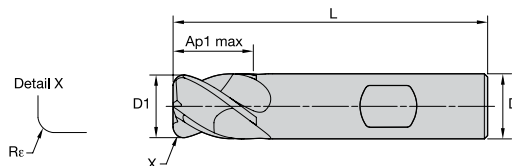

WU20PE

- first choice
- alternate choice

order #	catalog #	D1	D	length of cut Ap1 max	length L	Rε	Z U
6945867	W421E13026REW	1/2	1/2	1 1/2	4	.030	4
6945868	W421E13026RGW	1/2	1/2	1 1/2	4	.060	4
6945869	W421E13026RJW	1/2	1/2	1 1/2	4	.090	4
6945870	W421E13026RKW	1/2	1/2	1 1/2	4	.120	4
6945871	W421E16028REW	5/8	5/8	1 5/8	4 1/8	.030	4
6945872	W421E16028RGW	5/8	5/8	1 5/8	4 1/8	.060	4
6945873	W421E16028RKW	5/8	5/8	1 5/8	4 1/8	.120	4
6945874	W421E19029REW	3/4	3/4	2 1/4	5	.030	4
6945875	W421E19029RGW	3/4	3/4	2 1/4	5	.060	4
6945876	W421E19029RJW	3/4	3/4	2 1/4	5	.090	4
6945877	W421E19029RKW	3/4	3/4	2 1/4	5	.120	4
6945878	W421E2502AREW	1	1	3	6	.030	4
6945879	W421E2502ARGW	1	1	3	6	.060	4
6945880	W421E2502ARJW	1	1	3	6	.090	4
6945881	W421E2502ARKW	1	1	3	6	.120	4

WCE4 • Series W431 • Radiused • 4 Flute • Weldon® Shank • Inch

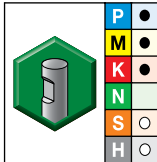
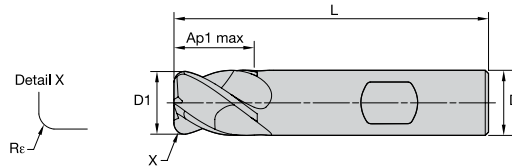

WU20PE

- first choice
- alternate choice

order #	catalog #	D1	D	length of cut Ap1 max	length L	Re	Z U
6946298	W431E13036REW	1/2	1/2	2	4	.030	4
6946299	W431E13036RGW	1/2	1/2	2	4	.060	4
6946300	W431E13036RJW	1/2	1/2	2	4	.090	4
6946301	W431E13036RKW	1/2	1/2	2	4	.120	4
6946302	W431E16038REW	5/8	5/8	2 1/4	5	.030	4
6946303	W431E16038RGW	5/8	5/8	2 1/4	5	.060	4
6946304	W431E16038RKW	5/8	5/8	2 1/4	5	.120	4
6946305	W431E19039REW	3/4	3/4	3	6	.030	4
6946306	W431E19039RGW	3/4	3/4	3	6	.060	4
6946307	W431E19039RJW	3/4	3/4	3	6	.090	4
6946308	W431E19039RKW	3/4	3/4	3	6	.120	4
6946309	W431E2503AREW	1	1	4	7	.030	4
6946310	W431E2503ARGW	1	1	4	7	.060	4
6946321	W431E2503ARJW	1	1	4	7	.090	4
6946322	W431E2503ARKW	1	1	4	7	.120	4

WCE4 • Series W441 • Radiused • 4 Flute • Weldon Shank • Inch

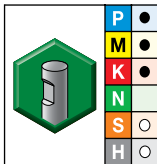
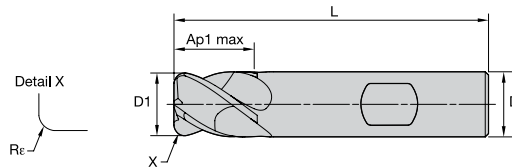

WU20PE

- first choice
- alternate choice

order #	catalog #	D1	D	length of cut Ap1 max	length L	Re	Z U
6946323	W441E13046REW	1/2	1/2	2 1/2	4 1/2	.030	4
6946324	W441E13046RGW	1/2	1/2	2 1/2	4 1/2	.060	4
6946325	W441E13046RJW	1/2	1/2	2 1/2	4 1/2	.090	4
6946326	W441E13046RKW	1/2	1/2	2 1/2	4 1/2	.120	4

INDEXABLE MILLING

SOLID END MILLING

HOLEMAKING

TAPPING

TURNING

INDEXABLE MILLING

SOLID END MILLING

HOLEMAKING

TAPPING

TURNING

## WCE4 • Series W40B • Ball Nose • 4 Flute • Cylindrical Shank • Inch

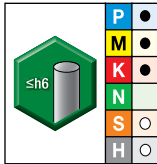
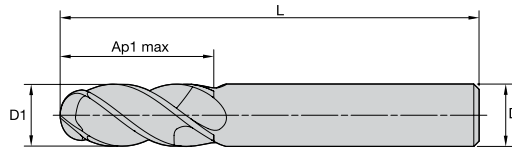

WU20PE

- first choice
- alternate choice

order #	catalog #	D1	D	length of cut Ap1 max	length L	Z U
6945890	W40BE03000RBT	1/8	1/8	1/2	2	4
6945891	W40BE05001RBT	3/16	3/16	5/8	2 1/4	4
6945892	W40BE07003RBT	1/4	1/4	3/4	2 1/2	4
6945893	W40BE08004RBT	5/16	5/16	3/4	2 1/2	4
6945894	W40BE10005RBT	3/8	3/8	7/8	2 1/2	4

## WCE4 • Series W40B • Ball Nose • 4 Flute • Weldon® Shank • Inch

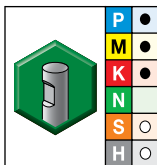
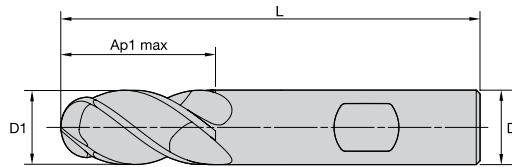

WU20PE

- first choice
- alternate choice

order #	catalog #	D1	D	length of cut Ap1 max	length L	Z U
6945911	W40BE13006RBW	1/2	1/2	1	3	4
6945912	W40BE16008RBW	5/8	5/8	1 1/4	3 1/2	4
6945913	W40BE19009RBW	3/4	3/4	1 1/2	4	4
6945914	W40BE2500ARBW	1	1	1 1/2	4	4

**WCE4 • Series W41B • Ball Nose • 4 Flute • Weldon® Shank • Inch**

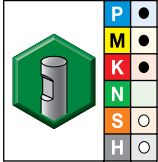
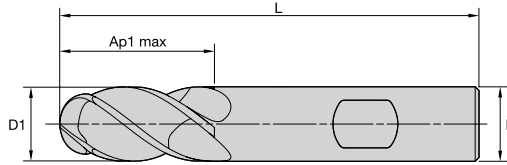

WU20PE

- first choice
- alternate choice

order #	catalog #	D1	D	length of cut Ap1 max	length L	Z U
6945915	W41BE13006RBW	1/2	1/2	1 1/4	3	4

**WCE4 • Series W401 • Sharp Edge • 4 Flute • Cylindrical Shank • Metric**

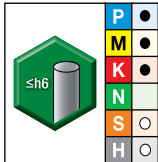
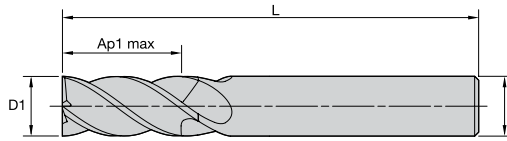

WU20PE

- first choice
- alternate choice

order #	catalog #	D1	D	length of cut Ap1 max	length L	Z U
6945502	W401M03003SZT	3,0	6	8,00	57	4
6945503	W401M04003SZT	4,0	6	11,00	57	4
6945504	W401M05003SZT	5,0	6	13,00	57	4
6945505	W401M06003SZT	6,0	6	13,00	57	4
6945548	W401M08004SZT	8,0	8	19,00	63	4
6945549	W401M10005SZT	10,0	10	22,00	72	4
6945684	W401M12006SZT	12,0	12	26,00	83	4
6945685	W401M16008SZT	16,0	16	32,00	92	4
6945686	W401M20009SZT	20,0	20	38,00	104	4

## WCE4 • Series W401 • Sharp Edge • 4 Flute • Weldon® Shank • Metric

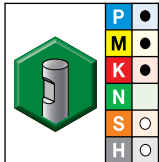
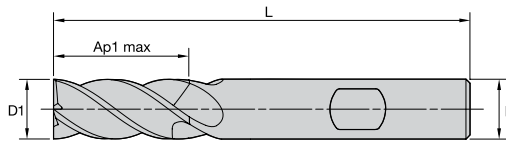

WU20PE

- first choice
- alternate choice

order #	catalog #	D1	D	length of cut Ap1 max	length L	Z U
6945510	W401M03003SZW	3,0	6	8,00	57	4
6945541	W401M04003SZW	4,0	6	11,00	57	4
6945542	W401M05003SZW	5,0	6	13,00	57	4
6945543	W401M06003SZW	6,0	6	13,00	57	4
6945562	W401M08004SZW	8,0	8	19,00	63	4
6945563	W401M10005SZW	10,0	10	22,00	72	4
6945690	W401M12006SZW	12,0	12	26,00	83	4
6945691	W401M16008SZW	16,0	16	32,00	92	4
6945692	W401M20009SZW	20,0	20	38,00	104	4

## WCE4 • Series W401 • Chamfered • 4 Flute • Cylindrical Shank • Metric

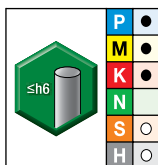
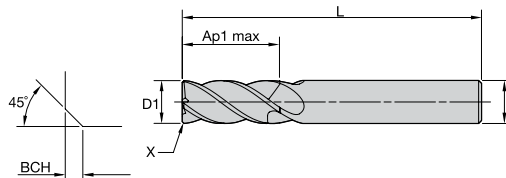

WU20PE

- first choice
- alternate choice

order #	catalog #	D1	D	length of cut Ap1 max	length L	BCH	Z U
6945506	W401M03003CAT	3,0	6	8,00	57	0,20	4
6945507	W401M04003CAT	4,0	6	11,00	57	0,20	4
6945508	W401M05003CAT	5,0	6	13,00	57	0,30	4
6945509	W401M06003CAT	6,0	6	13,00	57	0,40	4
6945550	W401M08004CAT	8,0	8	19,00	63	0,40	4
6945561	W401M10005CET	10,0	10	22,00	72	0,50	4
6945687	W401M12006CET	12,0	12	26,00	83	0,50	4
6945688	W401M16008CET	16,0	16	32,00	92	0,50	4
6945689	W401M20009CET	20,0	20	38,00	104	0,50	4

WCE4 • Series W401 • Chamfered • 4 Flute • Weldon® Shank • Metric

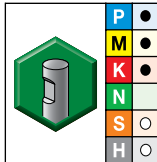
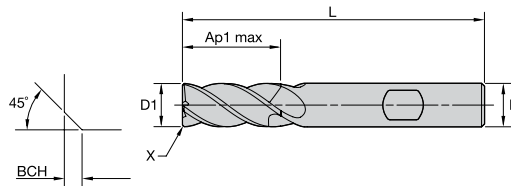

WU20PE

● first choice  
○ alternate choice

order #	catalog #	D1	D	length of cut Ap1 max	length L	BCH	Z U
6945544	W401M03003CAW	3,0	6	8,00	57	0,20	4
6945545	W401M04003CAW	4,0	6	11,00	57	0,20	4
6945546	W401M05003CAW	5,0	6	13,00	57	0,30	4
6945547	W401M06003CAW	6,0	6	13,00	57	0,40	4
6945564	W401M08004CAW	8,0	8	19,00	63	0,40	4
6945565	W401M10005CEW	10,0	10	22,00	72	0,50	4
6945693	W401M12006CEW	12,0	12	26,00	83	0,50	4
6945694	W401M16008CEW	16,0	16	32,00	92	0,50	4
6945695	W401M20009CEW	20,0	20	38,00	104	0,50	4

WCE4 • Series W4N1 • Radiused • 4 Flute • Necked • Cylindrical Shank • Metric

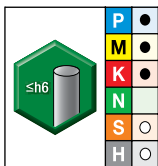
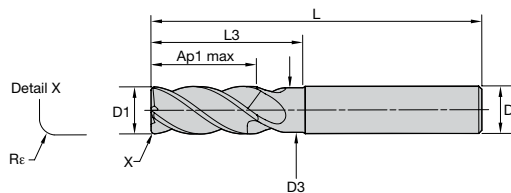

WU20PE

● first choice  
○ alternate choice

order #	catalog #	D1	D	D3	length of cut Ap1 max	length L	L3	Re	Z U
6945620	W4N1M03003RAT	3,0	6	2,82	8,00	57	15,00	0,20	4
6945631	W4N1M04003RAT	4,0	6	3,76	11,00	57	16,00	0,20	4
6945632	W4N1M04003RET	4,0	6	3,76	11,00	57	16,00	0,50	4
6945633	W4N1M05003RAT	5,0	6	4,70	13,00	57	18,00	0,20	4
6945634	W4N1M05003RET	5,0	6	4,70	13,00	57	18,00	0,50	4
6945635	W4N1M05003RJT	5,0	6	4,70	13,00	57	18,00	1,00	4
6945636	W4N1M06003RET	6,0	6	5,64	13,00	57	21,00	0,50	4
6945638	W4N1M06003RHT	6,0	6	5,64	13,00	57	21,00	1,50	4
6945637	W4N1M06003RJT	6,0	6	5,64	13,00	57	21,00	1,00	4
6945640	W4N1M08004RET	8,0	8	7,52	19,00	63	27,00	0,50	4
6945642	W4N1M08004RHT	8,0	8	7,52	19,00	63	27,00	1,50	4
6945641	W4N1M08004RJT	8,0	8	7,52	19,00	63	27,00	1,00	4
6945643	W4N1M08004RKT	8,0	8	7,52	19,00	63	27,00	2,00	4
6945644	W4N1M10005RET	10,0	10	9,40	22,00	72	32,00	0,50	4
6945646	W4N1M10005RHT	10,0	10	9,40	22,00	72	32,00	1,50	4
6945645	W4N1M10005RJT	10,0	10	9,40	22,00	72	32,00	1,00	4

## WCE4 • Series W4N1 • Radiused • 4 Flute • Necked • Cylindrical Shank • Metric

(continued)

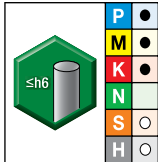
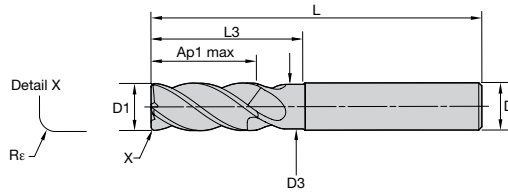

- first choice
- alternate choice

WU20PE

order #	catalog #	D1	D	D3	length of cut Ap1 max	length L	L3	Re	Z U
6945647	W4N1M10005RKT	10,0	10	9,40	22,00	72	32,00	2,00	4
6945128	W4N1M12006RET	12,0	12	11,28	26,00	83	38,00	0,50	4
6945130	W4N1M12006RHT	12,0	12	11,28	26,00	83	38,00	1,50	4
6945129	W4N1M12006RJT	12,0	12	11,28	26,00	83	38,00	1,00	4
6945481	W4N1M12006RKT	12,0	12	11,28	26,00	83	38,00	2,00	4
6945482	W4N1M12006RQT	12,0	12	11,28	26,00	83	38,00	4,00	4
6945483	W4N1M16008RJT	16,0	16	15,04	32,00	92	44,00	1,00	4
6945484	W4N1M16008RKT	16,0	16	15,04	32,00	92	44,00	2,00	4
6945485	W4N1M16008RPT	16,0	16	15,04	32,00	92	44,00	3,00	4
6945486	W4N1M16008RQT	16,0	16	15,04	32,00	92	44,00	4,00	4
6945487	W4N1M20009RJT	20,0	20	18,80	38,00	104	53,00	1,00	4
6945488	W4N1M20009RKT	20,0	20	18,80	38,00	104	53,00	2,00	4
6945489	W4N1M20009RPT	20,0	20	18,80	38,00	104	53,00	3,00	4
6945490	W4N1M20009RQT	20,0	20	18,80	38,00	104	53,00	4,00	4

## WCE4 • Series W411 • Chamfered • 4 Flute • Long Length • Cylindrical Shank • Metric

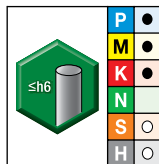
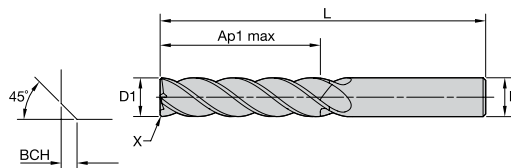

- first choice
- alternate choice

WU20PE

order #	catalog #	D1	D	length of cut Ap1 max	length L	BCH	Z U
6946013	W411M06013CAT	6,0	6	32,00	76	0,40	4
6946014	W411M08014CAT	8,0	8	32,00	87	0,40	4
6946015	W411M10015CET	10,0	10	38,00	89	0,50	4
6946046	W411M12016CET	12,0	12	51,00	100	0,50	4
6946047	W411M16018CET	16,0	16	57,00	125	0,50	4
6946048	W411M20019CET	20,0	20	57,00	125	0,50	4

## WCE4 • Series W4NB • Ball Nose • 4 Flute • Cylindrical Shank • Metric

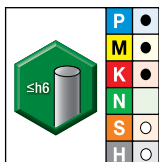
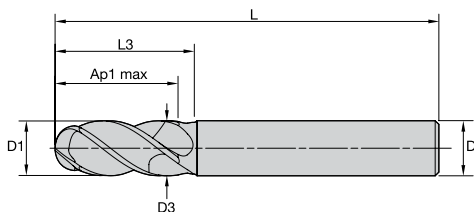

- first choice
- alternate choice

WU20PE

order #	catalog #	D1	D	D3	length of cut Ap1 max	length L	L3	Z U
6945882	W4NBM05003RBT	5,0	6	4,70	13,00	57	18,00	4
6945883	W4NBM06003RBT	6,0	6	5,64	13,00	57	21,00	4
6945886	W4NBM08004RBT	8,0	8	7,52	19,00	63	27,00	4
6945887	W4NBM10005RBT	10,0	10	9,40	22,00	72	32,00	4
6945895	W4NBM12006RBT	12,0	12	11,28	26,00	83	30,00	4
6945896	W4NBM16008RBT	16,0	16	15,04	32,00	92	38,00	4
6945897	W4NBM20009RBT	20,0	20	18,80	38,00	104	50,00	4

## WCE4 • Series W4NB • Ball Nose • 4 Flute • Weldon® Shank • Metric

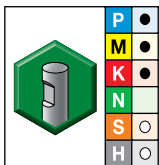
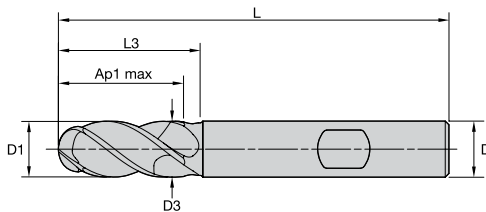



- first choice
- alternate choice

WU20PE



order #	catalog #	D1	D	D3	length of cut Ap1 max	length L	L3	Z U
6945884	W4NBM05003RBW	5,0	6	4,70	13,00	57	18,00	4
6945885	W4NBM06003RBW	6,0	6	5,64	13,00	57	21,00	4
6945888	W4NBM08004RBW	8,0	8	7,52	19,00	63	27,00	4
6945889	W4NBM10005RBW	10,0	10	9,40	22,00	72	32,00	4
6945898	W4NBM12006RBW	12,0	12	11,28	26,00	83	30,00	4
6945899	W4NBM16008RBW	16,0	16	15,04	32,00	92	38,00	4
6945900	W4NBM20009RBW	20,0	20	18,80	38,00	104	50,00	4



## Application Data • WCE Side Milling • Slotting • Inch

Material Group																		
	Side Milling		Slotting		WU20PE				Recommended feed per tooth (IPT = inch/th) for side milling (A). For slotting (B), reduce IPT by 20%.									
					Cutting Speed – Vc (SFM)				D1 – Diameter									
	ap	ae	ap	min	Start	max	fraction	1/8	3/16	1/4	5/16	3/8	7/16	1/2	5/8	3/4	1	
P	0	ap1max	0.4 x D1	1.0 x D1	490	580	660	IPT	.0009	.0013	.0018	.0023	.0027	.0031	.0034	.0039	.0044	.0049
	1	ap1max	0.4 x D1	1.0 x D1	490	580	660	IPT	.0009	.0013	.0018	.0023	.0027	.0031	.0034	.0039	.0044	.0049
	2	ap1max	0.4 x D1	1.0 x D1	460	540	620	IPT	.0009	.0013	.0018	.0023	.0027	.0031	.0034	.0039	.0044	.0049
	3	ap1max	0.4 x D1	1.0 x D1	390	450	520	IPT	.0007	.0011	.0015	.0020	.0023	.0026	.0029	.0034	.0039	.0045
	4	ap1max	0.4 x D1	0.75 x D1	300	400	490	IPT	.0007	.0010	.0014	.0017	.0020	.0023	.0026	.0030	.0034	.0039
	5	ap1max	0.4 x D1	1.0 x D1	200	260	330	IPT	.0006	.0009	.0012	.0017	.0018	.0021	.0023	.0027	.0031	.0036
M	1	ap1max	0.4 x D1	1.0 x D1	300	340	380	IPT	.0007	.0011	.0015	.0020	.0023	.0026	.0029	.0034	.0039	.0045
	2	ap1max	0.4 x D1	1.0 x D1	200	230	260	IPT	.0006	.0009	.0012	.0016	.0018	.0021	.0023	.0027	.0031	.0036
	3	ap1max	0.4 x D1	1.0 x D1	200	210	230	IPT	.0005	.00008	.0010	.0013	.0015	.0017	.0019	.0022	.0025	.0028
K	1	ap1max	0.4 x D1	1.0 x D1	390	440	490	IPT	.0009	.0013	.0018	.0023	.0027	.0031	.0034	.0039	.0044	.0049
	2	ap1max	0.4 x D1	1.0 x D1	360	410	460	IPT	.0007	.0011	.0015	.0020	.0023	.0026	.0029	.0034	.0039	.0045
	3	ap1max	0.4 x D1	1.0 x D1	360	390	430	IPT	.0006	.0009	.0012	.0016	.0018	.0021	.0023	.0027	.0031	.0036
S	1	ap1max	0.4 x D1	0.3 x D1	160	230	300	IPT	.0007	.0011	.0015	.0020	.0023	.0026	.0029	.0034	.0039	.0045
	2	ap1max	0.4 x D1	0.3 x D1	80	105	130	IPT	.0004	.0006	.0008	.0010	.0012	.0014	.0015	.0018	.0021	.0024
	3	ap1max	0.4 x D1	1.0 x D1	80	105	130	IPT	.0004	.0006	.0008	.0010	.0012	.0014	.0015	.0018	.0021	.0024
	4	ap1max	0.4 x D1	1.0 x D1	160	180	200	IPT	.0005	.0008	.0011	.0014	.0017	.0019	.0021	.0025	.0028	.0033
H	1	ap1max	0.4 x D1	0.75 x D1	260	360	460	IPT	.0007	.0010	.0014	.0017	.0020	.0023	.0026	.0030	.0034	.0039
	2	ap1max	0.4 x D1	0.5 x D1	230	310	390	IPT	.0005	.0008	.0010	.0013	.0015	.0017	.0019	.0022	.0025	.0028

## Application Data • WCE Side Milling • Slotting BN • Inch

Material Group																		
	Side Milling		Slotting		WU20PE				Recommended feed per tooth (Fz = IPT) for side milling (A). For slotting (B), reduce Fz by 20%.									
					Cutting Speed – Vc (SFM)				D1 – Diameter									
	ap	ae	ap	min	Start	max	fraction	1/8	3/16	1/4	5/16	3/8	7/16	1/2	5/8	3/4	1	
P	0	ap1max	0.4 x D1	1.0 x D1	490	580	660	IPT	.0009	.0013	.0018	.0023	.0027	.0031	.0034	.0039	.0044	.0049
	1	ap1max	0.4 x D1	1.0 x D1	490	580	660	IPT	.0009	.0013	.0018	.0023	.0027	.0031	.0034	.0039	.0044	.0049
	2	ap1max	0.4 x D1	1.0 x D1	460	540	620	IPT	.0009	.0013	.0018	.0023	.0027	.0031	.0034	.0039	.0044	.0049
	3	ap1max	0.4 x D1	1.0 x D1	390	450	520	IPT	.0007	.0011	.0015	.0020	.0023	.0026	.0029	.0034	.0039	.0045
	4	ap1max	0.4 x D1	0.75 x D1	300	400	490	IPT	.0007	.0010	.0014	.0017	.0020	.0023	.0026	.0030	.0034	.0039
	5	ap1max	0.4 x D1	1.0 x D1	200	260	330	IPT	.0006	.0009	.0012	.0017	.0018	.0021	.0023	.0027	.0031	.0036
M	1	ap1max	0.4 x D1	1.0 x D1	300	340	380	IPT	.0007	.0011	.0015	.0020	.0023	.0026	.0029	.0034	.0039	.0045
	2	ap1max	0.4 x D1	1.0 x D1	200	230	260	IPT	.0006	.0009	.0012	.0016	.0018	.0021	.0023	.0027	.0031	.0036
	3	ap1max	0.4 x D1	1.0 x D1	200	210	230	IPT	.0005	.00008	.0010	.0013	.0015	.0017	.0019	.0022	.0025	.0028
K	1	ap1max	0.4 x D1	1.0 x D1	390	440	490	IPT	.0009	.0013	.0018	.0023	.0027	.0031	.0034	.0039	.0044	.0049
	2	ap1max	0.4 x D1	1.0 x D1	360	410	460	IPT	.0007	.0011	.0015	.0020	.0023	.0026	.0029	.0034	.0039	.0045
	3	ap1max	0.4 x D1	1.0 x D1	360	390	430	IPT	.0006	.0009	.0012	.0016	.0018	.0021	.0023	.0027	.0031	.0036
S	1	ap1max	0.4 x D1	0.3 x D1	160	230	300	IPT	.0007	.0011	.0015	.0020	.0023	.0026	.0029	.0034	.0039	.0045
	2	ap1max	0.4 x D1	0.3 x D1	80	105	130	IPT	.0004	.0006	.0008	.0010	.0012	.0014	.0015	.0018	.0021	.0024
	3	ap1max	0.4 x D1	1.0 x D1	80	105	130	IPT	.0004	.0006	.0008	.0010	.0012	.0014	.0015	.0018	.0021	.0024
	4	ap1max	0.4 x D1	1.0 x D1	160	180	200	IPT	.0005	.0008	.0011	.0014	.0017	.0019	.0021	.0025	.0028	.0033
H	1	ap1max	0.4 x D1	0.75 x D1	260	360	460	IPT	.0007	.0010	.0014	.0017	.0020	.0023	.0026	.0030	.0034	.0039
	2	ap1max	0.4 x D1	0.5 x D1	230	310	390	IPT	.0005	.0008	.0010	.0013	.0015	.0017	.0019	.0022	.0025	.0028



Application Data • WCE Side Milling • Long • Inch

Material Group	Side Milling		WU20PE			Recommended feed per tooth (fz = IPT) for side milling. No slotting operations recommended.										
			Cutting Speed – Vc (SFM)			D1 – Diameter										
	ap	ae	min	Start	max	fraction	1/8	3/16	1/4	5/16	3/8	7/16	1/2	5/8	3/4	1
	0	ap1max	0.2xD1	490	580	660	IPT	.0009	.0013	.0018	.0023	.0027	.0031	.0034	.0039	.0044
1	ap1max	0.2xD1	490	580	660	IPT	.0009	.0013	.0018	.0023	.0027	.0031	.0034	.0039	.0044	.0049
2	ap1max	0.2xD1	460	540	620	IPT	.0009	.0013	.0018	.0023	.0027	.0031	.0034	.0039	.0044	.0049
3	ap1max	0.2xD1	390	450	520	IPT	.0007	.0011	.0015	.0020	.0023	.0026	.0029	.0034	.0039	.0045
4	ap1max	0.2xD1	300	400	490	IPT	.0007	.0010	.0014	.0017	.0020	.0023	.0026	.0030	.0034	.0039
5	ap1max	0.2xD1	200	260	330	IPT	.0006	.0009	.0012	.0017	.0018	.0021	.0023	.0027	.0031	.0036
6	ap1max	0.15xD1	160	200	250	IPT	.0005	.0008	.0010	.0013	.0015	.0017	.0019	.0022	.0025	.0028
1	ap1max	0.2xD1	300	340	380	IPT	.0007	.0011	.0015	.0020	.0023	.0026	.0029	.0034	.0039	.0045
2	ap1max	0.2xD1	200	230	260	IPT	.0006	.0009	.0012	.0016	.0018	.0021	.0023	.0027	.0031	.0036
3	ap1max	0.2xD1	200	210	230	IPT	.0005	.00008	.0010	.0013	.0015	.0017	.0019	.0022	.0025	.0028
1	ap1max	0.2xD1	390	440	490	IPT	.0009	.0013	.0018	.0023	.0027	.0031	.0034	.0039	.0044	.0049
2	ap1max	0.2xD1	360	410	460	IPT	.0007	.0011	.0015	.0020	.0023	.0026	.0029	.0034	.0039	.0045
3	ap1max	0.2xD1	360	390	430	IPT	.0006	.0009	.0012	.0016	.0018	.0021	.0023	.0027	.0031	.0036
1	ap1max	0.1xD1	160	230	300	IPT	.0007	.0011	.0015	.0020	.0023	.0026	.0029	.0034	.0039	.0045
2	ap1max	0.1xD1	80	105	130	IPT	.0004	.0006	.0008	.0010	.0012	.0014	.0015	.0018	.0021	.0024
3	ap1max	0.15xD1	80	105	130	IPT	.0004	.0006	.0008	.0010	.0012	.0014	.0015	.0018	.0021	.0024
4	ap1max	0.15xD1	160	180	200	IPT	.0005	.0008	.0011	.0014	.0017	.0019	.0021	.0025	.0028	.0033
1	ap1max	0.15xD1	260	360	460	IPT	.0007	.0010	.0014	.0017	.0020	.0023	.0026	.0030	.0034	.0039
2	ap1max	0.15xD1	230	310	390	IPT	.0005	.0008	.0010	.0013	.0015	.0017	.0019	.0022	.0025	.0028



Application Data • WCE Side Milling • Slotting • Metric

Material Group	Side Milling		Slotting	WU20PE			Recommended feed per tooth (fz = mm/th) for side milling (A). For slotting (B), reduce fz by 20%.													
				Cutting Speed – Vc m/min			D1 – Diameter													
	ap	ae	ap	min	Start	max	mm	3,0	4,0	5,0	6,0	8,0	10,0	12,0	14,0	16,0	18,0	20,0	25,0	
	0	ap1max	0,4 x D1	1,0 x D1	150	175	200	fz	0,021	0,028	0,036	0,044	0,060	0,072	0,083	0,092	0,101	0,108	0,114	0,124
1	ap1max	0,4 x D1	1,0 x D1	150	175	200	fz	0,021	0,028	0,036	0,044	0,060	0,072	0,083	0,092	0,101	0,108	0,114	0,124	
2	ap1max	0,4 x D1	1,0 x D1	140	165	190	fz	0,021	0,028	0,036	0,044	0,060	0,072	0,083	0,092	0,101	0,108	0,114	0,124	
3	ap1max	0,4 x D1	1,0 x D1	120	140	160	fz	0,017	0,023	0,030	0,036	0,050	0,061	0,070	0,079	0,087	0,095	0,101	0,114	
4	ap1max	0,4 x D1	0,75 x D1	90	120	150	fz	0,016	0,021	0,027	0,033	0,045	0,054	0,062	0,070	0,077	0,083	0,088	0,098	
5	ap1max	0,4 x D1	1,0 x D1	60	80	100	fz	0,014	0,019	0,024	0,029	0,040	0,048	0,056	0,063	0,070	0,076	0,081	0,091	
6	ap1max	0,4 x D1	0,75 x D1	50	65	75	fz	0,012	0,016	0,020	0,025	0,034	0,040	0,047	0,052	0,057	0,061	0,065	0,071	
1	ap1max	0,4 x D1	1,0 x D1	90	100	115	fz	0,017	0,023	0,030	0,036	0,050	0,061	0,070	0,079	0,087	0,095	0,101	0,114	
2	ap1max	0,4 x D1	1,0 x D1	60	70	80	fz	0,014	0,019	0,024	0,029	0,040	0,048	0,056	0,063	0,070	0,076	0,081	0,091	
3	ap1max	0,4 x D1	1,0 x D1	60	65	70	fz	0,012	0,016	0,020	0,025	0,034	0,040	0,047	0,052	0,057	0,061	0,065	0,071	
1	ap1max	0,4 x D1	1,0 x D1	120	135	150	fz	0,021	0,028	0,036	0,044	0,060	0,072	0,083	0,092	0,101	0,108	0,114	0,124	
2	ap1max	0,4 x D1	1,0 x D1	110	125	140	fz	0,017	0,023	0,030	0,036	0,050	0,061	0,070	0,079	0,087	0,095	0,101	0,114	
3	ap1max	0,4 x D1	1,0 x D1	110	120	130	fz	0,014	0,019	0,024	0,029	0,040	0,048	0,056	0,063	0,070	0,076	0,081	0,091	
1	ap1max	0,4 x D1	0,3 x D1	50	70	90	fz	0,017	0,023	0,030	0,036	0,050	0,061	0,070	0,079	0,087	0,095	0,101	0,114	
2	ap1max	0,4 x D1	0,3 x D1	25	30	40	fz	0,009	0,013	0,016	0,019	0,026	0,032	0,037	0,042	0,046	0,050	0,054	0,061	
3	ap1max	0,4 x D1	1,0 x D1	25	30	40	fz	0,009	0,013	0,016	0,019	0,026	0,032	0,037	0,042	0,046	0,050	0,054	0,061	
4	ap1max	0,4 x D1	1,0 x D1	50	55	60	fz	0,011	0,016	0,021	0,026	0,037	0,045	0,052	0,058	0,064	0,069	0,074	0,084	
1	ap1max	0,4 x D1	0,75 x D1	80	110	140	fz	0,016	0,021	0,027	0,033	0,045	0,054	0,062	0,070	0,077	0,083	0,088	0,098	
2	ap1max	0,4 x D1	0,5 x D1	70	90	120	fz	0,012	0,016	0,020	0,025	0,034	0,040	0,047	0,052	0,057	0,061	0,065	0,071	

## Application Data • WCE Side Milling • Slotting BN • Metric

Material Group																					
	Side Milling		Slotting		WU20PE		Recommended feed per tooth (fz = mm/th) for side milling (A). For slotting (B), reduce fz by 20%.														
					Cutting Speed – Vc m/min			D1 – Diameter													
	ap	ae	ap	min	Start	max	mm	3,0	4,0	5,0	6,0	8,0	10,0	12,0	14,0	16,0	18,0	20,0	25,0		
P	0	ap1max	0,4 x D1	1,0 x D1	150	175	200	fz	0,021	0,028	0,036	0,044	0,060	0,072	0,083	0,092	0,101	0,108	0,114	0,124	
	1	ap1max	0,4 x D1	1,0 x D1	150	175	200	fz	0,021	0,028	0,036	0,044	0,060	0,072	0,083	0,092	0,101	0,108	0,114	0,124	
	2	ap1max	0,4 x D1	1,0 x D1	140	165	190	fz	0,021	0,028	0,036	0,044	0,060	0,072	0,083	0,092	0,101	0,108	0,114	0,124	
	3	ap1max	0,4 x D1	1,0 x D1	120	140	160	fz	0,017	0,023	0,030	0,036	0,050	0,061	0,070	0,079	0,087	0,095	0,101	0,114	
	4	ap1max	0,4 x D1	0,75 x D1	90	120	150	fz	0,016	0,021	0,027	0,033	0,045	0,054	0,062	0,070	0,077	0,083	0,088	0,098	
	5	ap1max	0,4 x D1	1,0 x D1	60	80	100	fz	0,014	0,019	0,024	0,029	0,040	0,048	0,056	0,063	0,070	0,076	0,081	0,091	
6	ap1max	0,4 x D1	0,75 x D1	50	65	75	fz	0,012	0,016	0,020	0,025	0,034	0,040	0,047	0,052	0,057	0,061	0,065	0,071		
M	1	ap1max	0,4 x D1	1,0 x D1	90	100	115	fz	0,017	0,023	0,030	0,036	0,050	0,061	0,070	0,079	0,087	0,095	0,101	0,114	
	2	ap1max	0,4 x D1	1,0 x D1	60	70	80	fz	0,014	0,019	0,024	0,029	0,040	0,048	0,056	0,063	0,070	0,076	0,081	0,091	
	3	ap1max	0,4 x D1	1,0 x D1	60	65	70	fz	0,012	0,016	0,020	0,025	0,034	0,040	0,047	0,052	0,057	0,061	0,065	0,071	
K	1	ap1max	0,4 x D1	1,0 x D1	120	135	150	fz	0,021	0,028	0,036	0,044	0,060	0,072	0,083	0,092	0,101	0,108	0,114	0,124	
	2	ap1max	0,4 x D1	1,0 x D1	110	125	140	fz	0,017	0,023	0,030	0,036	0,050	0,061	0,070	0,079	0,087	0,095	0,101	0,114	
	3	ap1max	0,4 x D1	1,0 x D1	110	120	130	fz	0,014	0,019	0,024	0,029	0,040	0,048	0,056	0,063	0,070	0,076	0,081	0,091	
S	1	ap1max	0,4 x D1	0,3 x D1	50	70	90	fz	0,017	0,023	0,030	0,036	0,050	0,061	0,070	0,079	0,087	0,095	0,101	0,114	
	2	ap1max	0,4 x D1	0,3 x D1	25	30	40	fz	0,009	0,013	0,016	0,019	0,026	0,032	0,037	0,042	0,046	0,050	0,054	0,061	
	3	ap1max	0,4 x D1	1,0 x D1	25	30	40	fz	0,009	0,013	0,016	0,019	0,026	0,032	0,037	0,042	0,046	0,050	0,054	0,061	
	4	ap1max	0,4 x D1	1,0 x D1	50	55	60	fz	0,011	0,016	0,021	0,026	0,037	0,045	0,052	0,058	0,064	0,069	0,074	0,084	
H	1	ap1max	0,4 x D1	0,75 x D1	80	110	140	fz	0,016	0,021	0,027	0,033	0,045	0,054	0,062	0,070	0,077	0,083	0,088	0,098	
	2	ap1max	0,4 x D1	0,5 x D1	70	90	120	fz	0,012	0,016	0,020	0,025	0,034	0,040	0,047	0,052	0,057	0,061	0,065	0,071	

## Application Data • WCE Side Milling • Long • Metric

Material Group																			
	Side Milling		WU20PE		Recommended feed per tooth (fz = mm/z) for side milling. No slotting operations recommended.														
			Cutting Speed – Vc m/min			D1 – Diameter													
	ap	ae	min	Start	max	mm	3,0	4,0	5,0	6,0	8,0	10,0	12,0	14,0	16,0	18,0	20,0	25,0	
P	0	ap1max	0,2xD1	150	175	200	fz	0,021	0,028	0,036	0,044	0,060	0,072	0,083	0,092	0,101	0,108	0,114	0,124
	1	ap1max	0,2xD1	150	175	200	fz	0,021	0,028	0,036	0,044	0,060	0,072	0,083	0,092	0,101	0,108	0,114	0,124
	2	ap1max	0,2xD1	140	165	190	fz	0,021	0,028	0,036	0,044	0,060	0,072	0,083	0,092	0,101	0,108	0,114	0,124
	3	ap1max	0,2xD1	120	140	160	fz	0,017	0,023	0,030	0,036	0,050	0,061	0,070	0,079	0,087	0,095	0,101	0,114
	4	ap1max	0,2xD1	90	120	150	fz	0,016	0,021	0,027	0,033	0,045	0,054	0,062	0,070	0,077	0,083	0,088	0,098
	5	ap1max	0,2xD1	60	80	100	fz	0,014	0,019	0,024	0,029	0,040	0,048	0,056	0,063	0,070	0,076	0,081	0,091
6	ap1max	0,15xD1	50	65	75	fz	0,012	0,016	0,020	0,025	0,034	0,040	0,047	0,052	0,057	0,061	0,065	0,071	
M	1	ap1max	0,2xD1	90	100	115	fz	0,017	0,023	0,030	0,036	0,050	0,061	0,070	0,079	0,087	0,095	0,101	0,114
	2	ap1max	0,2xD1	60	70	80	fz	0,014	0,019	0,024	0,029	0,040	0,048	0,056	0,063	0,070	0,076	0,081	0,091
	3	ap1max	0,2xD1	60	65	70	fz	0,012	0,016	0,020	0,025	0,034	0,040	0,047	0,052	0,057	0,061	0,065	0,071
K	1	ap1max	0,2xD1	120	135	150	fz	0,021	0,028	0,036	0,044	0,060	0,072	0,083	0,092	0,101	0,108	0,114	0,124
	2	ap1max	0,2xD1	110	125	140	fz	0,017	0,023	0,030	0,036	0,050	0,061	0,070	0,079	0,087	0,095	0,101	0,114
	3	ap1max	0,2xD1	110	120	130	fz	0,014	0,019	0,024	0,029	0,040	0,048	0,056	0,063	0,070	0,076	0,081	0,091
S	1	ap1max	0,1xD1	50	70	90	fz	0,017	0,023	0,030	0,036	0,050	0,061	0,070	0,079	0,087	0,095	0,101	0,114
	2	ap1max	0,1xD1	25	30	40	fz	0,009	0,013	0,016	0,019	0,026	0,032	0,037	0,042	0,046	0,050	0,054	0,061
	3	ap1max	0,15xD1	25	30	40	fz	0,009	0,013	0,016	0,019	0,026	0,032	0,037	0,042	0,046	0,050	0,054	0,061
	4	ap1max	0,15xD1	50	55	60	fz	0,011	0,016	0,021	0,026	0,037	0,045	0,052	0,058	0,064	0,069	0,074	0,084
H	1	ap1max	0,15xD1	80	110	140	fz	0,016	0,021	0,027	0,033	0,045	0,054	0,062	0,070	0,077	0,083	0,088	0,098
	2	ap1max	0,15xD1	70	90	120	fz	0,012	0,016	0,020	0,025	0,034	0,040	0,047	0,052	0,057	0,061	0,065	0,071

**WCE • Adjustment Factor Table for Feed Calculation**

To calculate application-specific cutting data, please use Kv coefficient table to the right for adaptation of cutting speed and KFz for feed, respectively.

$Vc_{new} = Vc \cdot Kv$   
 $Fz_{new} = IPT \cdot KFz$

Calculation example:  
 Application: D = 20mm; M2 material group;  
 Ae = 2mm  
 Cutting data recommendation: Vc = 80 m/min;  
 Fz = 0,089 mm/th  
 Adjustment coefficients: Ae = 2mm equals 10,0%;  
 Kv = 1,35; KFz = 1,7

Final cutting data recommendation:  
 $Vc_{new} = 80 \cdot 1,35 = 108 \text{ m/min}$   
 $Fz_{new} = 0,089 \cdot 1,7 = 0,15 \text{ mm/min}$

**Inch**

	Ae/D	2%	4%	5%	8%	10%	20%	30%	40%	50%
Speed factor	Kv	2	1.5	1.45	1.4	1.35	1.25	1.2	1	1
Feed factor	KFz	2.4	2.3	2.2	2	1.7	1.25	1.02	1	1

**Metric**

	Ae/D	2%	4%	5%	8%	10%	20%	30%	40%	50%
Speed factor	Kv	2	1.5	1.45	1.4	1.35	1.25	1.2	1	1
Feed factor	KFz	2,4	2,3	2,2	2	1,7	1,25	1,02	1	1

INDEXABLE MILLING

SOLID END MILLING

HOLE/MAKING

TAPPING

TURNING

# GP End Mills

## General-Purpose Solid Carbide End Mills

The GP solid end milling line is a group of highly versatile end mills created for small shop customers to manage inventory effectively by reducing the initial tooling investment and increasing the value to recondition.

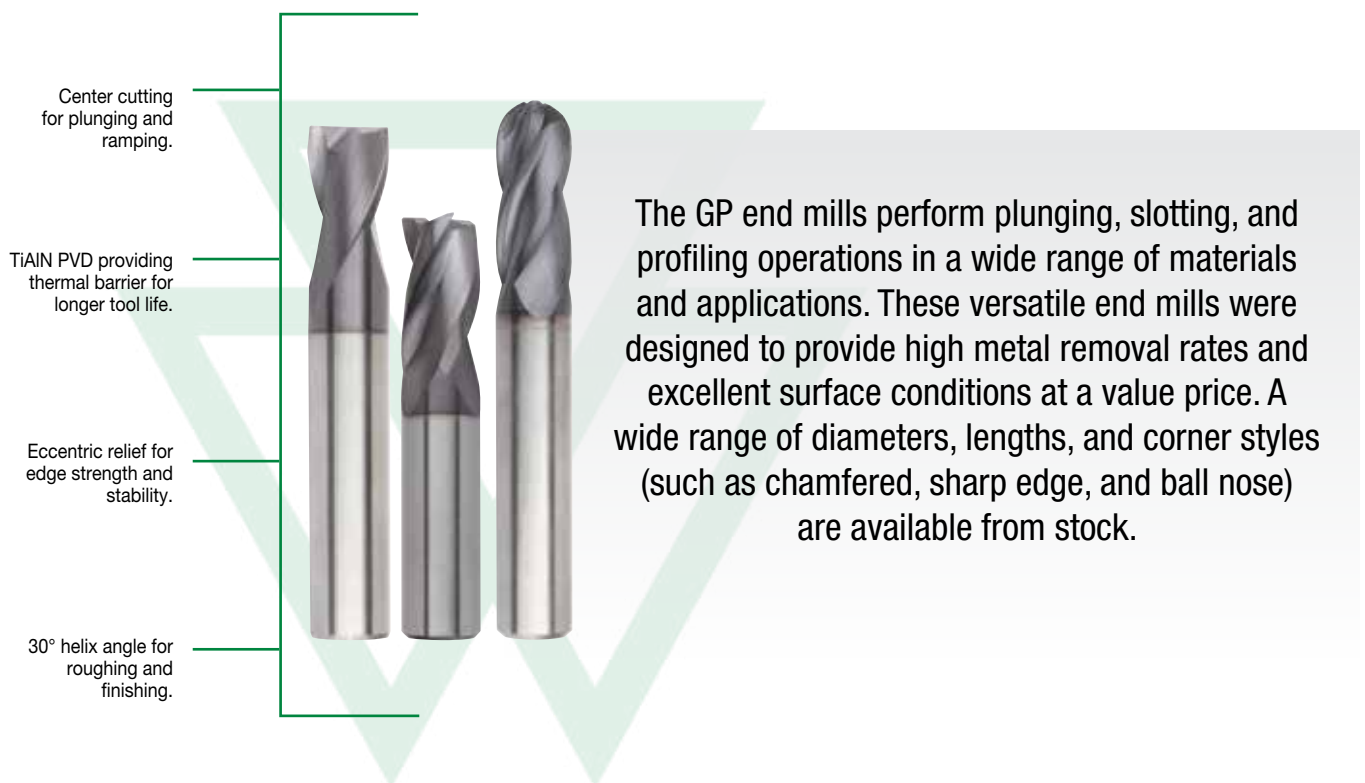

### VERSATILE

One design and grade to machine a wide range of materials.

### RELIABLE

Mid-level performance and productivity in all machine conditions, including unstable setups.

### VALUABLE

Low initial investment with simple regrind capability.

# VALUABLE VERSATILITY

## PRODUCT

### GRADE

TiAIN, UNCOATED

### FLUTES

2-4

### DIAMETER RANGE

1/32-1" (1-20mm)

## CORNER CONDITIONS

Sharp Edges  
Chamfered  
Radiused  
Ball Nose

## INDUSTRY



## MATERIALS

### FIRST CHOICE



## APPLICATIONS



SIDE/  
SHOULDER  
MILLING  
ROUGHING



SLOTING  
SQUARE  
END



HELICAL  
MILLING



RAMPING  
BLANK



3D  
PROFILING

## ECCENTRIC RELIEF

for edge strength and stability.

## 30° HELIX ANGLE

for high versatility.

## CYLINDRICAL AND WELDON® SHANK

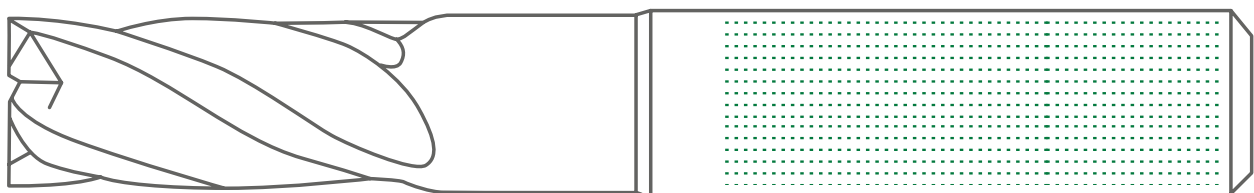

# General-Purpose Solid Carbide End Mills

## GP End Mills • Series I2S • Sharp Edge • 2 Flute • Inch

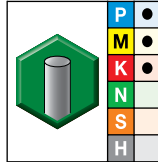
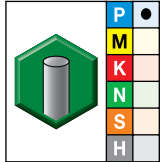
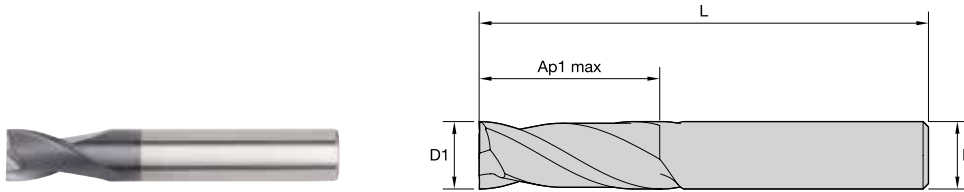

- first choice
- alternate choice

UNCOATED		TiAlN				length of cut	length	Z	U
order #	catalog #	order #	catalog #	D1	D	Ap1 max	L		
5873649	I2S0031T007R	5872793	I2S0016T003R	1/64	1/8	1/32	1 1/2		2
5873661	I2S0062T012R	5872794	I2S0031T007R	1/32	1/8	5/64	1 1/2		2
5873650	I2S0062T018L	5872796	I2S0062T012R	1/16	1/8	1/8	1 1/2		2
5873662	I2S0062T050X	5872795	I2S0062T018L	1/16	1/8	3/16	1 1/2		2
5873663	I2S0078T018R	5872797	I2S0062T050X	1/16	1/8	1/2	2		2
5873664	I2S0094T018S	5872798	I2S0078T018R	5/64	1/8	3/16	1 1/2		2
5873665	I2S0094T037R	5872799	I2S0094T018S	3/32	1/8	3/16	1 1/2		2
5873666	I2S0094T062L	5872800	I2S0094T037R	3/32	1/8	3/8	1 1/2		2
5873667	I2S0125T025S	5872841	I2S0094T062L	3/32	1/8	5/8	2		2
5873669	I2S0125T050R	5872843	I2S0109T037R	7/64	1/8	3/8	1 1/2		2
5873670	I2S0125T075L	5872844	I2S0125T025S	1/8	1/8	1/4	1 1/2		2
5873671	I2S0125T075X	5872845	I2S0125T050R	1/8	1/8	1/2	1 1/2		2
5873674	I2S0156T056L	5872846	I2S0125T075L	1/8	1/8	3/4	2 1/4		2
5873676	I2S0188T062R	5872847	I2S0125T075X	1/8	1/8	3/4	3		2
5873677	I2S0188T075L	5872848	I2S0141T056R	9/64	3/16	9/16	2		2
5873678	I2S0188T112X	5872849	I2S0156T031R	5/32	3/16	5/16	2		2
5873681	I2S0250T050S	5872850	I2S0156T056L	5/32	3/16	9/16	2		2
5873682	I2S0250T075R	5872851	I2S0172T062R	11/64	3/16	5/8	2		2
5873683	I2S0250T112R	5872852	I2S0188T031S	3/16	3/16	5/16	1 1/2		2
5873684	I2S0250T125L	5872853	I2S0188T062R	3/16	3/16	5/8	2		2
5873685	I2S0250T150X	5872854	I2S0188T075L	3/16	3/16	3/4	2 1/2		2
5873687	I2S0312T081R	5872855	I2S0188T112X	3/16	3/16	1 1/8	3		2
5873689	I2S0312T162X	5872856	I2S0219T043R	7/32	1/4	7/16	2		2
5873690	I2S0344T100R	5872857	I2S0219T062L	7/32	1/4	5/8	2 1/2		2
5873691	I2S0375T062S	5872858	I2S0250T050S	1/4	1/4	1/2	2		2
5873692	I2S0375T100R	5872859	I2S0250T075R	1/4	1/4	3/4	2 1/2		2
5873693	I2S0375T112R	5872860	I2S0250T112R	1/4	1/4	1 1/8	3		2
5873694	I2S0375T175L	5872861	I2S0250T150X	1/4	1/4	1 1/4	3 1/2		2
5873698	I2S0437T100R	5872862	I2S0250T150X	1/4	1/4	1 1/2	4		2
5873711	I2S0469T100R	5872862	I2S0281T075R	9/32	5/16	3/4	2 1/2		2
5873712	I2S0500T062S	5872941	I2S0312T050S	5/16	5/16	1/2	2		2
5873713	I2S0500T100R	5872863	I2S0312T081R	5/16	5/16	13/16	2 1/2		2
5873714	I2S0500T200L	5872864	I2S0312T112L	5/16	5/16	1 1/8	3		2
5873720	I2S0625T125R	5872865	I2S0312T162X	5/16	5/16	1 5/8	4		2
		5872866	I2S0344T100R	11/32	3/8	1	2 1/2		2
		5872867	I2S0375T062S	3/8	3/8	5/8	2		2
		5872868	I2S0375T100R	3/8	3/8	1	2 1/2		2
		5872869	I2S0375T112R	3/8	3/8	1 1/8	3		2
		5872870	I2S0375T175L	3/8	3/8	1 3/4	4		2
		5872881	I2S0375T300X	3/8	3/8	3	6		2
		5872882	I2S0406T100R	13/32	7/16	1	2 3/4		2
		5872883	I2S0437T062S	7/16	7/16	5/8	2 1/2		2
		5872884	I2S0437T100R	7/16	7/16	1	2 1/2		2
		5872885	I2S0437T200L	7/16	7/16	2	4		2
		5872886	I2S0437T300X	7/16	7/16	3	6		2
		5872887	I2S0469T100R	15/32	1/2	1	3		2
		5872888	I2S0500T062S	1/2	1/2	5/8	2 1/2		2
		5872889	I2S0500T100R	1/2	1/2	1	3		2
		5872890	I2S0500T200L	1/2	1/2	2	4		2
		5872891	I2S0500T300X	1/2	1/2	3	6		2
		5872892	I2S0562T075R	9/16	9/16	3/4	3		2
		5872893	I2S0562T125L	9/16	9/16	1 1/4	3 1/2		2
		5872894	I2S0562T225X	9/16	9/16	2 1/4	5		2
		5872895	I2S0625T075S	5/8	5/8	3/4	3		2
		5872896	I2S0625T125R	5/8	5/8	1 1/4	3 1/2		2
		5872897	I2S0625T225R	5/8	5/8	2 1/4	5		2

## GP End Mills • Series I2S • Sharp Edge • 2 Flute • Inch

(continued)

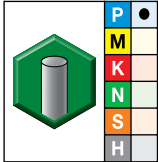
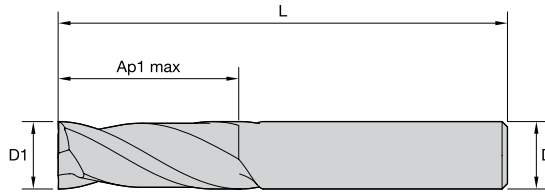

UNCOATED

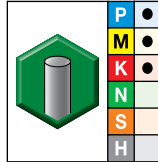

TiAlN

- first choice
- alternate choice

UNCOATED		TiAlN				length of cut	length	Z	U
order #	catalog #	order #	catalog #	D1	D	Ap1 max	L		
—	—	5872898	I2S0625T300L	5/8	5/8	3	6		2
—	—	5872899	I2S0625T400X	5/8	5/8	4	7		2
—	—	5872900	I2S0687T137R	11/16	3/4	1 3/8	4		2
—	—	5872901	I2S0750T100S	3/4	3/4	1	3		2
5873726	I2S0750T150R	5872902	I2S0750T150R	3/4	3/4	1 1/2	4		2
—	—	5872903	I2S0750T225R	3/4	3/4	2 1/4	5		2
—	—	5872904	I2S0750T300L	3/4	3/4	3	6		2
—	—	5872905	I2S0750T400X	3/4	3/4	4	7		2
—	—	5872906	I2S0875T150R	7/8	7/8	1 1/2	4		2
—	—	5872907	I2S0875T225L	7/8	7/8	2 1/4	5		2
—	—	5872908	I2S1000T150S	1	1	1 1/2	4		2
—	—	5872909	I2S1000T225R	1	1	2 1/4	5		2
—	—	5872910	I2S1000T300L	1	1	3	6		2
—	—	5872921	I2S1000T400X	1	1	4	7		2

INDEXABLE MILLING

SOLID END MILLING

HOLEMAKING

TAPPING

TURNING



# General-Purpose Solid Carbide End Mills

## GP End Mills • Series I2R • Radiused • 2 Flute • Inch

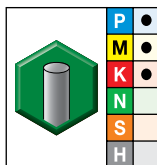
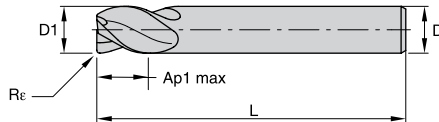

- first choice
- alternate choice

TiAlN

order #	catalog #	D1	D	length of cut Ap1 max	length L	Re	Z U
6286059	I2R0062T012R010	1/16	1/8	1/8	1 1/2	.010	2
6286060	I2R0062T012R015	1/16	1/8	1/8	1 1/2	.015	2
6286101	I2R0094T037R010	3/32	1/8	3/8	1 1/2	.010	2
6286102	I2R0094T037R015	3/32	1/8	3/8	1 1/2	.015	2
6286103	I2R0125T050R010	1/8	1/8	1/2	1 1/2	.010	2
6286104	I2R0125T050R015	1/8	1/8	1/2	1 1/2	.015	2
6286105	I2R0125T050R020	1/8	1/8	1/2	1 1/2	.020	2
6286106	I2R0125T050R030	1/8	1/8	1/2	1 1/2	.030	2
6286107	I2R0188T062R010	3/16	3/16	5/8	2	.010	2
6286108	I2R0188T062R015	3/16	3/16	5/8	2	.015	2
6286109	I2R0188T062R020	3/16	3/16	5/8	2	.020	2
6286110	I2R0188T062R030	3/16	3/16	5/8	2	.030	2
6286131	I2R0250T075R015	1/4	1/4	3/4	2 1/2	.015	2
6286132	I2R0250T075R020	1/4	1/4	3/4	2 1/2	.020	2
6286133	I2R0250T075R030	1/4	1/4	3/4	2 1/2	.030	2
6286134	I2R0250T075R045	1/4	1/4	3/4	2 1/2	.045	2
6286135	I2R0250T075R060	1/4	1/4	3/4	2 1/2	.060	2
6286136	I2R0312T081R015	5/16	5/16	13/16	2 1/2	.015	2
6286137	I2R0312T081R020	5/16	5/16	13/16	2 1/2	.020	2
6286138	I2R0312T081R030	5/16	5/16	13/16	2 1/2	.030	2
6286139	I2R0312T081R045	5/16	5/16	13/16	2 1/2	.045	2
6286140	I2R0312T081R060	5/16	5/16	13/16	2 1/2	.060	2
6286151	I2R0375T100R015	3/8	3/8	1	2 1/2	.015	2
6286152	I2R0375T100R020	3/8	3/8	1	2 1/2	.020	2
6286153	I2R0375T100R030	3/8	3/8	1	2 1/2	.030	2
6286154	I2R0375T100R045	3/8	3/8	1	2 1/2	.045	2
6286155	I2R0375T100R060	3/8	3/8	1	2 1/2	.060	2
6286763	I2R0500T100R015	1/2	1/2	1	3	.015	2
6286764	I2R0500T100R020	1/2	1/2	1	3	.020	2
6286765	I2R0500T100R030	1/2	1/2	1	3	.030	2
6286766	I2R0500T100R045	1/2	1/2	1	3	.045	2
6286767	I2R0500T100R060	1/2	1/2	1	3	.060	2
6286768	I2R0625T125R015	5/8	5/8	1 1/4	3 1/2	.015	2
6286769	I2R0625T125R020	5/8	5/8	1 1/4	3 1/2	.020	2
6286770	I2R0625T125R030	5/8	5/8	1 1/4	3 1/2	.030	2
6286811	I2R0625T125R045	5/8	5/8	1 1/4	3 1/2	.045	2
6286812	I2R0625T125R060	5/8	5/8	1 1/4	3 1/2	.060	2
6286813	I2R0625T125R090	5/8	5/8	1 1/4	3 1/2	.090	2
6286814	I2R0625T125R125	5/8	5/8	1 1/4	3 1/2	.125	2
6286815	I2R0750T150R015	3/4	3/4	1 1/2	4	.015	2
6286816	I2R0750T150R020	3/4	3/4	1 1/2	4	.020	2
6286817	I2R0750T150R030	3/4	3/4	1 1/2	4	.030	2
6286818	I2R0750T150R045	3/4	3/4	1 1/2	4	.045	2
6286819	I2R0750T150R060	3/4	3/4	1 1/2	4	.060	2
6286820	I2R0750T150R090	3/4	3/4	1 1/2	4	.090	2
6286821	I2R0750T150R125	3/4	3/4	1 1/2	4	.125	2
6286822	I2R0875T150R015	7/8	7/8	1 1/2	4	.015	2
6286823	I2R0875T150R020	7/8	7/8	1 1/2	4	.020	2
6286824	I2R0875T150R030	7/8	7/8	1 1/2	4	.030	2
6286825	I2R0875T150R045	7/8	7/8	1 1/2	4	.045	2
6286826	I2R0875T150R060	7/8	7/8	1 1/2	4	.060	2
6286827	I2R0875T150R090	7/8	7/8	1 1/2	4	.090	2
6286828	I2R0875T150R125	7/8	7/8	1 1/2	4	.125	2
6286829	I2R1000T150R015	1	1	1 1/2	4	.015	2
6286830	I2R1000T150R020	1	1	1 1/2	4	.020	2
6286851	I2R1000T150R030	1	1	1 1/2	4	.030	2
6286852	I2R1000T150R045	1	1	1 1/2	4	.045	2
6286853	I2R1000T150R060	1	1	1 1/2	4	.060	2
6286854	I2R1000T150R090	1	1	1 1/2	4	.090	2
6286855	I2R1000T150R125	1	1	1 1/2	4	.125	2

INDEXABLE MILLING

SOLID END MILLING

HOLEMAKING

TAPPING

TURNING

## GP End Mills • Series I2B • Ball Nose • 2 Flute • Inch

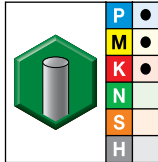
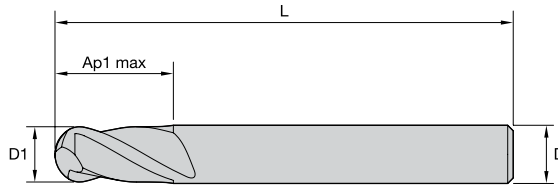

- first choice
- alternate choice

TiAIN

order #	catalog #	D1	D	length of cut Ap1 max	length L	Z	U
5878172	I2B0031T007R	1/32	1/8	5/64	1 1/2	2	2
5878174	I2B0046T018R	3/64	1/8	3/16	1 1/2	2	2
5878173	I2B0062T018R	1/16	1/8	3/16	1 1/2	2	2
5878175	I2B0078T018R	5/64	1/8	3/16	1 1/2	2	2
5878176	I2B0093T018R	3/32	1/8	3/16	1 1/2	2	2
5878177	I2B0093T037L	3/32	1/8	3/8	1 1/2	2	2
5878178	I2B0109T037R	7/64	1/8	3/8	1 1/2	2	2
5878179	I2B0125T025S	1/8	1/8	1/4	1 1/2	2	2
5878180	I2B0125T050R	1/8	1/8	1/2	1 1/2	2	2
5878181	I2B0125T075L	1/8	1/8	3/4	2 1/4	2	2
5878182	I2B0125T075X	1/8	1/8	3/4	3	2	2
5878183	I2B0156T031R	5/32	3/16	5/16	2	2	2
5878184	I2B0156T056L	5/32	3/16	9/16	2	2	2
5878185	I2B0187T031S	3/16	3/16	5/16	1 1/2	2	2
5878186	I2B0187T062R	3/16	3/16	5/8	2	2	2
5878187	I2B0187T075L	3/16	3/16	3/4	2 1/2	2	2
5878188	I2B0187T100X	3/16	3/16	1	4	2	2
5878189	I2B0218T062R	7/32	1/4	5/8	2 1/2	2	2
5878190	I2B0250T050S	1/4	1/4	1/2	2	2	2
5878191	I2B0250T075R	1/4	1/4	3/4	2 1/2	2	2
5878192	I2B0250T112R	1/4	1/4	1 1/8	3	2	2
5878193	I2B0250T150L	1/4	1/4	1 1/2	4	2	2
5878194	I2B0250T150X	1/4	1/4	1 1/2	6	2	2
5878195	I2B0312T050S	5/16	5/16	1/2	2	2	2
5878196	I2B0312T081R	5/16	5/16	13/16	2 1/2	2	2
5878197	I2B0312T112L	5/16	5/16	1 1/8	3	2	2
5878199	I2B0375T062S	3/8	3/8	5/8	2	2	2
5878200	I2B0375T087R	3/8	3/8	7/8	2 1/2	2	2
5878201	I2B0375T112R	3/8	3/8	1 1/8	3	2	2
5878202	I2B0375T175L	3/8	3/8	1 3/4	4	2	2
5878203	I2B0375T300X	3/8	3/8	3	6	2	2
5878204	I2B0406T100R	13/32	7/16	1	2 1/2	2	2
5878205	I2B0437T100R	7/16	7/16	1	2 1/2	2	2
5878206	I2B0500T062S	1/2	1/2	5/8	2 1/2	2	2
5878207	I2B0500T100R	1/2	1/2	1	3	2	2
5878208	I2B0500T150X	1/2	1/2	1 1/2	6	2	2
5878209	I2B0500T200L	1/2	1/2	2	4	2	2
5878210	I2B0500T300L	1/2	1/2	3	6	2	2
5878211	I2B0625T125R	5/8	5/8	1 1/4	3 1/2	2	2
5878212	I2B0625T225L	5/8	5/8	2 1/4	5	2	2
5878213	I2B0625T300X	5/8	5/8	3	6	2	2
5878214	I2B0750T100S	3/4	3/4	1	3	2	2
5878215	I2B0750T150R	3/4	3/4	1 1/2	4	2	2
5878216	I2B0750T200X	3/4	3/4	2	6	2	2
5878217	I2B0750T225L	3/4	3/4	2 1/4	5	2	2
5878218	I2B0750T300X	3/4	3/4	3	6	2	2
5878219	I2B0875T150R	7/8	7/8	1 1/2	4	2	2
5878220	I2B1000T150R	1	1	1 1/2	4	2	2
5878221	I2B1000T300L	1	1	3	6	2	2

# General-Purpose Solid Carbide End Mills

## GP End Mills • Series I3S • Sharp Edge • 3 Flute • Inch

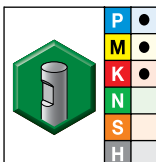
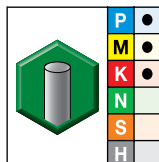
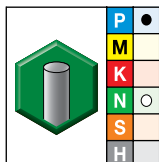
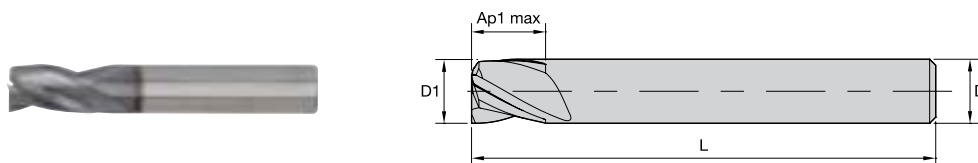

● first choice  
○ alternate choice

UNCOATED		TiAlN		TiAlN		D1	D	length of cut		Z	U
order #	catalog #	order #	catalog #	order #	catalog #			Ap1 max	L		
6144206	I3S0031T007R	6144077	I3S0031T007R	—	—	1/32	1/8	5/64	1 1/2	3	
6144208	I3S0062T019R	6144079	I3S0062T019R	—	—	1/16	1/8	3/16	1 1/2	3	
—	—	6144080	I3S0078T011R	—	—	5/64	1/8	7/64	1 1/2	3	
6144210	I3S0094T037R	6144141	I3S0094T037R	—	—	3/32	1/8	3/8	1 1/2	3	
—	—	6144142	I3S0109T037R	—	—	7/64	1/8	3/8	1 1/2	3	
6144232	I3S0125T025R	—	—	—	—	1/8	1/8	1/4	1 1/2	3	
6144233	I3S0125T050L	6144144	I3S0125T050L	—	—	1/8	1/8	1/2	2 1/2	3	
6144234	I3S0125T062X	6144145	I3S0125T062X	—	—	1/8	1/8	5/8	3	3	
6144236	I3S0156T056R	6144147	I3S0156T056R	—	—	5/32	3/16	9/16	2	3	
6144237	I3S0188T031S	6144148	I3S0188T031S	—	—	3/16	3/16	5/16	2	3	
6144238	I3S0188T056R	6144149	I3S0188T056R	—	—	3/16	3/16	9/16	2	3	
6144239	I3S0188T062L	6144150	I3S0188T062L	—	—	3/16	3/16	5/8	3	3	
—	—	6144151	I3S0188T100X	—	—	3/16	3/16	1	4	3	
—	—	6144153	I3S0219T062R	—	—	7/32	1/4	5/8	2 1/2	3	
—	—	6144154	I3S0219T075L	—	—	7/32	1/4	3/4	2 1/2	3	
6144244	I3S0250T050S	6144155	I3S0250T050S	—	—	1/4	1/4	1/2	2	3	
6144245	I3S0250T075R	6144156	I3S0250T075R	—	—	1/4	1/4	3/4	2 1/2	3	
6144246	I3S0250T100L	6144157	I3S0250T100L	—	—	1/4	1/4	1	3	3	
—	—	6144158	I3S0250T150X	—	—	1/4	1/4	1 1/2	4	3	
—	—	6144161	I3S0281T081L	—	—	9/32	5/16	13/16	2 1/2	3	
—	—	6144159	I3S0281T075R	—	—	9/32	5/16	3/4	2 1/2	3	
6144262	I3S0312T050R	6144163	I3S0312T050R	—	—	5/16	5/16	1/2	2	3	
—	—	6144165	I3S0312T081L	—	—	5/16	5/16	13/16	2 1/2	3	
6144272	I3S0375T050S	6144183	I3S0375T050S	—	—	3/8	3/8	1/2	2	3	
6144275	I3S0375T088R	6144185	I3S0375T088R	—	—	3/8	3/8	7/8	2 1/2	3	
6144277	I3S0375T100L	6144187	I3S0375T100L	—	—	3/8	3/8	1	2 1/2	3	
6144279	I3S0375T112X	6144189	I3S0375T112X	—	—	3/8	3/8	1 1/8	3	3	
—	—	6144192	I3S0437T062R	—	—	7/16	7/16	5/8	2 1/2	3	
—	—	6144193	I3S0437T088L	—	—	7/16	7/16	7/8	2 1/2	3	
—	—	6144194	I3S0437T100X	—	—	7/16	7/16	1	2 1/2	3	
6144284	I3S0500T100R	6144195	I3S0500T100R	—	—	1/2	1/2	1	3	3	
—	—	6144196	I3S0500T200L	6144162	I3S0500W200L	1/2	1/2	2	4	3	
—	—	6144198	I3S0563T112R	6144166	I3S0563W112R	9/16	5/8	1 1/8	3 1/2	3	
—	—	6144199	I3S0625T075R	6144168	I3S0625W075R	5/8	5/8	3/4	3	3	
—	—	6144200	I3S0625T125L	6144170	I3S0625W125L	5/8	5/8	1 1/4	3 1/2	3	
—	—	6144201	I3S0750T100R	—	—	3/4	3/4	1	3	3	
—	—	6144202	I3S0750T150L	6144184	I3S0750W150L	3/4	3/4	1 1/2	4	3	
—	—	6144203	I3S0750T225X	6144186	I3S0750W225X	3/4	3/4	2 1/4	5	3	
—	—	6144204	I3S1000T150R	—	—	1	1	1 1/2	4	3	
—	—	6144205	I3S1000T225X	6144190	I3S1000W225X	1	1	2 1/4	5	3	

INDEXABLE MILLING

SOLID END MILLING

HOLEMAKING

TAPPING

TURNING

## GP End Mills • Series I4S • Sharp Edge • 4 Flute • Inch

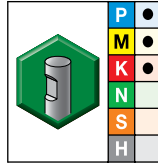
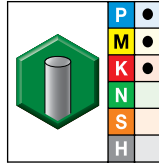
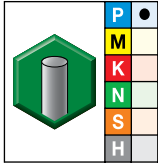
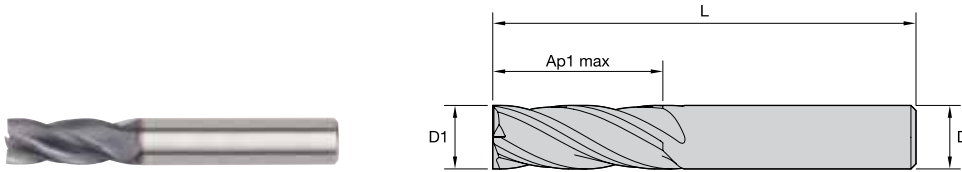

● first choice  
○ alternate choice

UNCOATED		TiAlN		TiAlN		length of cut		length		Z U
order #	catalog #	order #	catalog #	order #	catalog #	D1	D	Ap1 max	L	
—	—	5879053	I4S0016T003R	—	—	1/64	1/8	1/32	1 1/2	4
—	—	5879054	I4S0031T008R	—	—	1/32	1/8	5/64	1 1/2	4
5879198	I4S0062T010R	5879055	I4S0062T011R	—	—	1/16	1/8	7/64	1 1/2	4
5879199	I4S0078T019R	—	—	—	—	5/64	1/8	3/16	1 1/2	4
—	—	5879056	I4S0078T018R	—	—	5/64	1/8	3/16	1 1/2	4
5879200	I4S0094T037R	5879057	I4S0093T037R	—	—	3/32	1/8	3/8	1 1/2	4
—	—	5879058	I4S0093T062L	—	—	3/32	1/8	5/8	2	4
—	—	5879059	I4S0109T037R	—	—	7/64	1/8	3/8	1 1/2	4
—	—	5879060	I4S0125T025S	—	—	1/8	1/8	1/4	1 1/2	4
5879201	I4S0125T050R	5879131	I4S0125T050R	—	—	1/8	1/8	1/2	1 1/2	4
—	—	5879132	I4S0125T075L	—	—	1/8	1/8	3/4	2 1/4	4
5879202	I4S0125T100X	5879133	I4S0125T100X	—	—	1/8	1/8	1	3	4
—	—	5879134	I4S0140T056R	—	—	9/64	3/16	9/16	2	4
—	—	5879135	I4S0156T056R	—	—	5/32	3/16	9/16	2	4
5879203	I4S0187T062R	5879136	I4S0187T062R	—	—	3/16	3/16	5/8	2	4
—	—	5879137	I4S0187T075S	—	—	3/16	3/16	3/4	1 1/2	4
—	—	5879138	I4S0187T075L	—	—	3/16	3/16	3/4	2 1/2	4
5879204	I4S0187T112L	5879139	I4S0187T112L	—	—	3/16	3/16	1 1/8	3	4
—	—	5879140	I4S0187T112X	—	—	3/16	3/16	1 1/8	3 1/4	4
—	—	5879141	I4S0203T062R	—	—	13/64	1/4	5/8	2 1/2	4
—	—	5879142	I4S0218T043R	—	—	7/32	1/4	7/16	2	4
—	—	5879143	I4S0218T062L	—	—	7/32	1/4	5/8	2 1/2	4
—	—	5879144	I4S0234T075R	—	—	15/64	1/4	3/4	2 1/2	4
5879205	I4S0250T050S	5879145	I4S0250T050S	—	—	1/4	1/4	1/2	2	4
5879206	I4S0250T075R	5879146	I4S0250T075R	—	—	1/4	1/4	3/4	2 1/2	4
5879207	I4S0250T112L	5879147	I4S0250T112L	—	—	1/4	1/4	1 1/8	3	4
5879208	I4S0250T150X	5879148	I4S0250T150X	—	—	1/4	1/4	1 1/2	4	4
—	—	5879149	I4S0265T075R	—	—	17/64	5/16	3/4	2 1/2	4
—	—	5879150	I4S0281T075R	—	—	9/32	5/16	3/4	2 1/2	4
—	—	5879151	I4S0296T081R	—	—	19/64	5/16	13/16	2 1/2	4
5879209	I4S0312T050S	5879152	I4S0312T050S	—	—	5/16	5/16	1/2	2	4
5879210	I4S0312T081R	5879153	I4S0312T081R	—	—	5/16	5/16	13/16	2 1/2	4
5879211	I4S0312T112L	5879154	I4S0312T112L	—	—	5/16	5/16	1 1/8	3	4
5879212	I4S0312T162X	5879155	I4S0312T162X	—	—	5/16	5/16	1 5/8	4	4
—	—	5879156	I4S0328T100R	—	—	21/64	3/8	1	2 1/2	4
—	—	5879157	I4S0343T100R	—	—	11/32	3/8	1	2 1/2	4
—	—	5879158	I4S0359T100R	—	—	23/64	3/8	1	2 1/2	4
5879213	I4S0375T062S	5879159	I4S0375T062S	—	—	3/8	3/8	5/8	2	4
5879214	I4S0375T100R	5879160	I4S0375T100R	—	—	3/8	3/8	1	2 1/2	4
5879215	I4S0375T112L	5879161	I4S0375T112L	—	—	3/8	3/8	1 1/8	3	4
5879216	I4S0375T175X	5879162	I4S0375T175X	—	—	3/8	3/8	1 3/4	4	4
—	—	5879163	I4S0390T100R	—	—	25/64	7/16	1	2 3/4	4
—	—	5879164	I4S0406T100R	—	—	13/32	7/16	1	2 3/4	4
—	—	5879165	I4S0421T100R	—	—	27/64	7/16	1	2 3/4	4
5879217	I4S0437T100S	5879166	I4S0437T100S	—	—	7/16	7/16	1	2 1/2	4
—	—	5879167	I4S0437T100R	—	—	7/16	7/16	1	2 3/4	4
5879218	I4S0437T200L	5879168	I4S0437T200L	—	—	7/16	7/16	2	4	4
5879219	I4S0437T300X	5879169	I4S0437T300X	—	—	7/16	7/16	3	6	4
—	—	5879170	I4S0453T100R	—	—	29/64	1/2	1	3	4
—	—	5879171	I4S0468T100R	—	—	15/32	1/2	1	3	4
—	—	5879172	I4S0484T100R	—	—	31/64	1/2	1	3	4
5879220	I4S0500T062S	5879173	I4S0500T062S	—	—	1/2	1/2	5/8	2 1/2	4
5879221	I4S0500T100R	5879174	I4S0500T100R	5879527	I4S0500W100R	1/2	1/2	1	3	4
5879222	I4S0500T200L	5879175	I4S0500T200L	5879528	I4S0500W200L	1/2	1/2	2	4	4
5879223	I4S0500T300X	5879176	I4S0500T300X	5879529	I4S0500W300X	1/2	1/2	3	6	4
5879224	I4S0562T075R	5879177	I4S0562T075R	5879530	I4S0562W075R	9/16	9/16	3/4	3	4

## GP End Mills • Series I4S • Sharp Edge • 4 Flute • Inch

(continued)

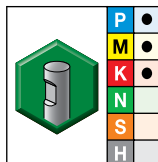
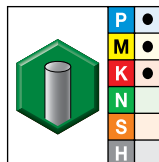
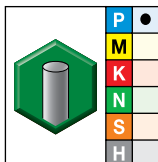
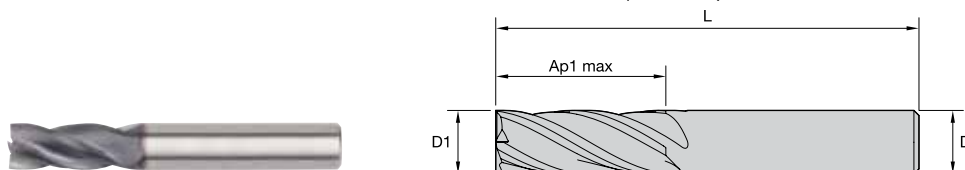

● first choice  
○ alternate choice

UNCOATED		TiAlN		TiAlN		D1	D	length of cut Ap1 max	length L	Z U
order #	catalog #	order #	catalog #	order #	catalog #					
5879225	I4S0562T125L	5879178	I4S0562T125L	5879551	I4S0562W125L	9/16	9/16	1 1/4	3 1/2	4
—	—	5879179	I4S0562T225X	5879552	I4S0562W225X	9/16	9/16	2 1/4	5	4
5879227	I4S0625T075S	5879180	I4S0625T075S	5879553	I4S0625W075S	5/8	5/8	3/4	3	4
5879228	I4S0625T125R	5879181	I4S0625T125R	5879554	I4S0625W125R	5/8	5/8	1 1/4	3 1/2	4
5879229	I4S0625T225L	5879182	I4S0625T225L	5879555	I4S0625W225L	5/8	5/8	2 1/4	5	4
5879230	I4S0625T400X	5879183	I4S0625T400X	5879556	I4S0625W400X	5/8	5/8	4	7	4
—	—	5879184	I4S0687T137R	—	—	11/16	3/4	1 3/8	4	4
5879241	I4S0750T100S	5879185	I4S0750T100S	—	—	3/4	3/4	1	3	4
5879242	I4S0750T150R	5879186	I4S0750T150R	5879558	I4S0750W150R	3/4	3/4	1 1/2	4	4
5879243	I4S0750T225R	5879187	I4S0750T225R	5879559	I4S0750W225R	3/4	3/4	2 1/4	5	4
5879244	I4S0750T300L	5879188	I4S0750T300L	5879560	I4S0750W300L	3/4	3/4	3	6	4
5879245	I4S0750T400X	5879189	I4S0750T400X	5879561	I4S0750W400X	3/4	3/4	4	7	4
—	—	5879190	I4S0812T150R	—	—	13/16	7/8	1 1/2	4	4
5879246	I4S0875T150R	5879191	I4S0875T150R	5879562	I4S0875W150R	7/8	7/8	1 1/2	4	4
5879247	I4S0875T225L	5879192	I4S0875T225L	5879563	I4S0875W225L	7/8	7/8	2 1/4	5	4
5879248	I4S1000T150S	5879193	I4S1000T150S	—	—	1	1	1 1/2	4	4
5879249	I4S1000T225R	5879194	I4S1000T225R	5879565	I4S1000W225R	1	1	2 1/4	5	4
5879250	I4S1000T300L	5879195	I4S1000T300L	5879566	I4S1000W300L	1	1	3	6	4
5879261	I4S1000T400X	5879196	I4S1000T400X	5879567	I4S1000W400X	1	1	4	7	4
5879262	I4S1250T200R	5879197	I4S1250T200R	—	—	1 1/4	1 1/4	2	4 1/2	4

INDEXABLE MILLING

SOLID END MILLING

HOLEMAKING

TAPPING

TURNING

## GP End Mills • Series I4R • Radiused • 4 Flute • Inch

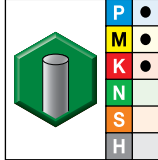
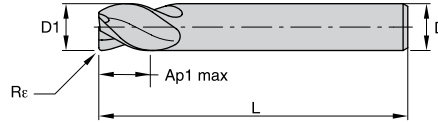

- first choice
- alternate choice

TiAlN

order #	catalog #	D1	D	length of cut A <sub>p1</sub> max	length L	R <sub>e</sub>	Z U
6282423	I4R0062T011R010	1/16	1/8	1/8	1 1/2	.010	4
6282424	I4R0062T011R015	1/16	1/8	1/8	1 1/2	.015	4
6282426	I4R0094T037R010	3/32	1/8	3/8	1 1/2	.010	4
6282427	I4R0094T037R015	3/32	1/8	3/8	1 1/2	.015	4
6282428	I4R0125T050R010	1/8	1/8	1/2	1 1/2	.010	4
6282429	I4R0125T050R015	1/8	1/8	1/2	1 1/2	.015	4
6282430	I4R0125T050R020	1/8	1/8	1/2	1 1/2	.020	4
6282441	I4R0125T050R030	1/8	1/8	1/2	1 1/2	.030	4
6282442	I4R0187T062R010	3/16	3/16	5/8	2	.010	4
6282443	I4R0187T062R015	3/16	3/16	5/8	2	.015	4
6282444	I4R0187T062R020	3/16	3/16	5/8	2	.020	4
6282446	I4R0187T062R030	3/16	3/16	5/8	2	.030	4
6282447	I4R0250T075R015	1/4	1/4	3/4	2 1/2	.015	4
6282448	I4R0250T075R020	1/4	1/4	3/4	2 1/2	.020	4
6282449	I4R0250T075R030	1/4	1/4	3/4	2 1/2	.030	4
6282450	I4R0250T075R045	1/4	1/4	3/4	2 1/2	.045	4
6282461	I4R0250T075R060	1/4	1/4	3/4	2 1/2	.060	4
6282462	I4R0312T081R015	5/16	5/16	13/16	2 1/2	.015	4
6282463	I4R0312T081R020	5/16	5/16	13/16	2 1/2	.020	4
6282464	I4R0312T081R030	5/16	5/16	13/16	2 1/2	.030	4
6282465	I4R0312T081R045	5/16	5/16	13/16	2 1/2	.045	4
6282467	I4R0312T081R060	5/16	5/16	13/16	2 1/2	.060	4
6285506	I4R0375T100R015	3/8	3/8	1	2 1/2	.015	4
6282468	I4R0375T100R020	3/8	3/8	1	2 1/2	.020	4
6282469	I4R0375T100R030	3/8	3/8	1	2 1/2	.030	4
6282470	I4R0375T100R045	3/8	3/8	1	2 1/2	.045	4
6282501	I4R0375T100R060	3/8	3/8	1	2 1/2	.060	4
6282503	I4R0500T100R015	1/2	1/2	1	3	.015	4
6282504	I4R0500T100R020	1/2	1/2	1	3	.020	4
6282505	I4R0500T100R030	1/2	1/2	1	3	.030	4
6282506	I4R0500T100R045	1/2	1/2	1	3	.045	4
6282507	I4R0500T100R060	1/2	1/2	1	3	.060	4
6282508	I4R0625T125R015	5/8	5/8	1 1/4	3 1/2	.015	4
6282509	I4R0625T125R020	5/8	5/8	1 1/4	3 1/2	.020	4
6282510	I4R0625T125R030	5/8	5/8	1 1/4	3 1/2	.030	4
6282531	I4R0625T125R045	5/8	5/8	1 1/4	3 1/2	.045	4
6282532	I4R0625T125R060	5/8	5/8	1 1/4	3 1/2	.060	4
6282533	I4R0625T125R090	5/8	5/8	1 1/4	3 1/2	.090	4
6282535	I4R0625T125R125	5/8	5/8	1 1/4	3 1/2	.125	4
6282536	I4R0750T150R015	3/4	3/4	1 1/2	4	.015	4
6282537	I4R0750T150R020	3/4	3/4	1 1/2	4	.020	4
6282538	I4R0750T150R030	3/4	3/4	1 1/2	4	.030	4
6282539	I4R0750T150R045	3/4	3/4	1 1/2	4	.045	4
6282540	I4R0750T150R060	3/4	3/4	1 1/2	4	.060	4
6282561	I4R0750T150R090	3/4	3/4	1 1/2	4	.090	4
6282562	I4R0750T150R125	3/4	3/4	1 1/2	4	.125	4
6282563	I4R0875T150R015	7/8	7/8	1 1/2	4	.015	4
6282564	I4R0875T150R020	7/8	7/8	1 1/2	4	.020	4
6282565	I4R0875T150R030	7/8	7/8	1 1/2	4	.030	4
6282566	I4R0875T150R045	7/8	7/8	1 1/2	4	.045	4
6282567	I4R0875T150R060	7/8	7/8	1 1/2	4	.060	4
6282568	I4R0875T150R090	7/8	7/8	1 1/2	4	.090	4
6282569	I4R0875T150R125	7/8	7/8	1 1/2	4	.125	4
6282570	I4R1000T150R015	1	1	1 1/2	4	.015	4
6282571	I4R1000T150R020	1	1	1 1/2	4	.020	4
6282572	I4R1000T150R030	1	1	1 1/2	4	.030	4
6282573	I4R1000T150R045	1	1	1 1/2	4	.045	4
6282574	I4R1000T150R060	1	1	1 1/2	4	.060	4
6282575	I4R1000T150R090	1	1	1 1/2	4	.090	4
6282576	I4R1000T150R125	1	1	1 1/2	4	.125	4

INDEXABLE MILLING

SOLID END MILLING

HOLEMAKING

TAPPING

TURNING

# General-Purpose Solid Carbide End Mills

## GP End Mills • Series I4B • Ball Nose • 4 Flute • Inch

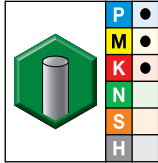
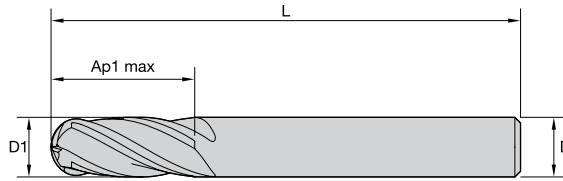

- first choice
- alternate choice

TiAlN

order #	catalog #	D1	D	length of cut Ap1 max	length L	Z U
5825624	I4B0031T008R	1/32	1/8	5/64	1 1/2	4
5825625	I4B0047T012R	3/64	1/8	1/8	1 1/2	4
5825626	I4B0062T019R	1/16	1/8	3/16	1 1/2	4
5825627	I4B0078T019R	5/64	1/8	3/16	1 1/2	4
5825628	I4B0094T019R	3/32	1/8	3/16	1 1/2	4
5825643	I4B0094T037L	3/32	1/8	3/8	1 1/2	4
5825645	I4B0109T037R	7/64	1/8	3/8	1 1/2	4
5825646	I4B0125T025S	1/8	1/8	1/4	1 1/2	4
5825647	I4B0125T050R	1/8	1/8	1/2	1 1/2	4
5825648	I4B0125T075L	1/8	1/8	3/4	2 1/4	4
5825649	I4B0125T075X	1/8	1/8	3/4	3	4
5825650	I4B0141T056R	9/64	3/16	9/16	2	4
5825651	I4B0156T031R	5/32	3/16	5/16	2	4
5825652	I4B0156T056L	5/32	3/16	9/16	2	4
5825653	I4B0172T062R	11/64	3/16	5/8	2	4
5825654	I4B0187T031S	3/16	3/16	5/16	1 1/2	4
5825655	I4B0187T062R	3/16	3/16	5/8	2	4
5825656	I4B0187T075L	3/16	3/16	3/4	2 1/2	4
5825657	I4B0187T100X	3/16	3/16	1	4	4
5825658	I4B0203T062R	13/64	1/4	5/8	2 1/2	4
5825659	I4B0219T062R	7/32	1/4	5/8	2 1/2	4
5825660	I4B0234T075R	15/64	1/4	3/4	2 1/2	4
5825661	I4B0250T050S	1/4	1/4	1/2	2	4
5825663	I4B0250T075R	1/4	1/4	3/4	2 1/2	4
5825664	I4B0250T112R	1/4	1/4	1 1/8	3	4
5825665	I4B0250T150L	1/4	1/4	1 1/2	4	4
5825666	I4B0250T150X	1/4	1/4	1 1/2	6	4
5825667	I4B0266T075R	17/64	5/16	3/4	2 1/2	4
5825668	I4B0281T075R	9/32	5/16	3/4	2 1/2	4
5825669	I4B0312T050S	5/16	5/16	1/2	2	4
5825670	I4B0312T081R	5/16	5/16	13/16	2 1/2	4
5825681	I4B0312T112L	5/16	5/16	1 1/8	3	4
5825682	I4B0312T162X	5/16	5/16	1 5/8	4	4
5825683	I4B0344T100R	11/32	3/8	1	2 1/2	4
5825684	I4B0375T100S	3/8	3/8	1	2 1/2	4
5825685	I4B0375T100L	3/8	3/8	1	4	4
5825686	I4B0375T112R	3/8	3/8	1 1/8	3	4
5825687	I4B0375T150X	3/8	3/8	1 1/2	6	4
5825688	I4B0437T100R	7/16	1/2	1	2 1/2	4
5825689	I4B0500T100S	1/2	1/2	1	3	4
5825690	I4B0500T100R	1/2	1/2	1	4	4
5825691	I4B0500T150X	1/2	1/2	1 1/2	6	4
5825693	I4B0500T200L	1/2	1/2	2	4 1/2	4
5825692	I4B0500T200R	1/2	1/2	2	4	4
5825694	I4B0500T300X	1/2	1/2	3	6	4
5825695	I4B0562T125R	9/16	9/16	1 1/4	3 1/2	4
5825696	I4B0625T075S	5/8	5/8	3/4	3	4
5825697	I4B0625T125R	5/8	5/8	1 1/4	3 1/2	4
5825698	I4B0625T225L	5/8	5/8	2 1/4	5	4
5825699	I4B0625T300X	5/8	5/8	3	6	4
5825700	I4B0750T100R	3/4	3/4	1	3	4
5825711	I4B0750T150L	3/4	3/4	1 1/2	4	4
5825712	I4B0750T300X	3/4	3/4	3	6	4
5825713	I4B0875T150R	7/8	7/8	1 1/2	4	4
5825714	I4B1000T150R	1	1	1 1/2	4	4
5825715	I4B1000T225L	1	1	2 1/4	5	4

INDEXABLE MILLING

SOLID END MILLING

HOLEMAKING

TAPPING

TURNING



## GP End Mills • Series 4002 4012 • Square End • 2 Flute • Metric

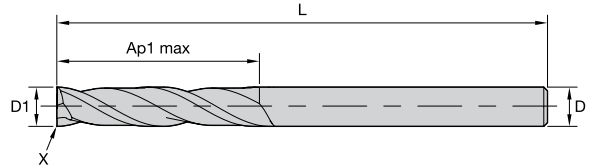
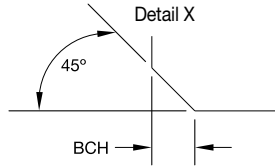
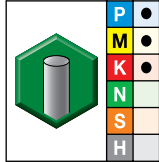

- first choice
- alternate choice

TiAlN

order #	catalog #	D1	D	length of cut Ap1 max	length L	BCH	Z U
5873484	40020100T004	1,0	3	4,00	38	—	2
5873485	40020150T004	1,5	3	4,00	38	—	2
5873486	40020180T004	1,8	3	4,00	38	—	2
5873487	40020200T006	2,0	3	6,30	38	—	2
5873488	40020250T006	2,5	3	6,30	38	—	2
5873489	40020300T009	3,0	3	9,50	38	—	2
5873490	40020300T019	3,0	3	19,00	63	—	2
5873491	40120300T025	3,0	3	25,00	75	—	2
5873492	40020350T012	3,5	4	12,00	54	—	2
5873493	40020400T012	4,0	4	12,00	50	0,10	2
6092621	40020400T012S	4,0	4	12,00	50	—	2
5873494	40020400T019	4,0	4	19,00	63	0,10	2
6092622	40020400T019S	4,0	4	19,00	63	—	2
6092623	40120400T031S	4,0	4	31,00	75	—	2
5873495	40120400T031	4,0	4	31,00	75	0,10	2
6092624	40020450T014S	4,5	6	14,00	50	—	2
5873496	40020450T014	4,5	6	14,00	50	0,10	2
5873498	40020500T014	5,0	5	14,00	50	0,10	2
6092627	40020500T014S	5,0	5	14,00	50	—	2
5873499	40020500T020	5,0	5	20,00	63	0,10	2
6092628	40020500T020S	5,0	5	20,00	63	—	2
6092631	40120500T031S	5,0	5	31,00	100	—	2
5873500	40120500T031	5,0	5	31,00	100	0,10	2
5873501	40020550T014	5,5	6	14,00	50	0,10	2
6092632	40020550T014S	5,5	6	14,00	50	—	2
6092633	40020600T016S	6,0	6	16,00	50	—	2
5873502	40020600T016	6,0	6	16,00	50	0,10	2
5873503	40020600T028	6,0	6	28,00	76	0,10	2
6092634	40020600T028S	6,0	6	28,00	76	—	2
6092636	40120600T038S	6,0	6	38,00	100	—	2
5873504	40120600T038	6,0	6	38,00	100	0,10	2
5873505	40020700T020	7,0	7	20,00	63	0,10	2
6092637	40020700T020S	7,0	7	20,00	63	—	2
5873506	40020800T020	8,0	8	20,00	63	0,20	2
6092638	40020800T020S	8,0	8	20,00	63	—	2
6092639	40020800T028S	8,0	8	28,00	76	—	2
5873507	40020800T028	8,0	8	28,00	76	0,20	2
6092640	40120800T041S	8,0	8	41,00	100	—	2
5873508	40120800T041	8,0	8	41,00	100	0,20	2
5873509	40020900T020	9,0	9	20,00	63	0,20	2
6092641	40020900T020S	9,0	9	20,00	63	—	2
5873510	40021000T022	10,0	10	22,00	72	0,20	2
6092643	40021000T022S	10,0	10	22,00	72	—	2
6092644	40021000T032S	10,0	10	32,00	89	—	2
5873511	40021000T032	10,0	10	32,00	89	0,20	2
6092645	40121000T045S	10,0	10	45,00	100	—	2
5873512	40121000T045	10,0	10	45,00	100	0,20	2
6092646	40021100T025S	11,0	11	25,00	76	—	2
5873513	40021100T025	11,0	11	25,00	76	0,30	2
5873514	40021200T025	12,0	12	25,00	76	0,30	2
6092647	40021200T025S	12,0	12	25,00	76	—	2
5873515	40021200T045	12,0	12	45,00	100	0,30	2
6092648	40021200T045S	12,0	12	45,00	100	—	2
6092650	40121200T075S	12,0	12	75,00	150	—	2
5873516	40121200T075	12,0	12	75,00	150	0,30	2
6092651	40021400T032S	14,0	14	32,00	83	—	2



## GP End Mills • Series 4002 4012 • Square End • 2 Flute • Metric

(continued)

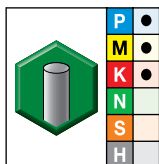
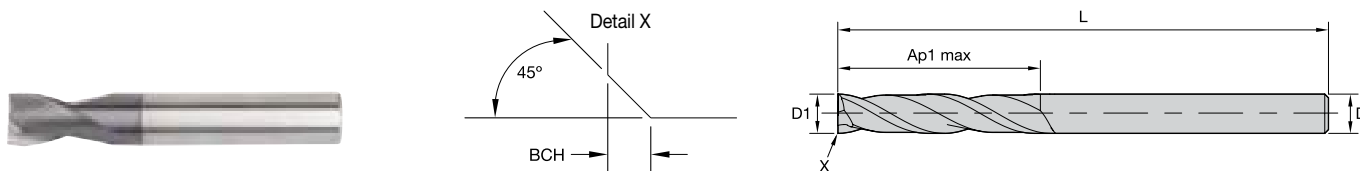

● first choice  
○ alternate choice

TiAlN

order #	catalog #	D1	D	length of cut Ap1 max	length L	BCH	Z U
5873517	40021400T032	14,0	14	32,00	83	0,30	2
6092653	40021400T050S	14,0	14	50,00	100	—	2
5873518	40021400T050	14,0	14	50,00	100	0,30	2
6092654	40121400T075S	14,0	14	75,00	150	—	2
5873519	40121400T075	14,0	14	75,00	150	0,30	2
5873520	40021600T032	16,0	16	32,00	89	0,30	2
6092657	40021600T032S	16,0	16	32,00	89	—	2
6092658	40021600T056S	16,0	16	56,00	110	—	2
5873531	40021600T056	16,0	16	56,00	110	0,30	2
6092659	40121600T075S	16,0	16	75,00	150	—	2
5873532	40121600T075	16,0	16	75,00	150	0,30	2
5873533	40021800T038	18,0	18	38,00	100	0,30	2
6092660	40021800T038S	18,0	18	38,00	100	—	2
5873536	40022000T038	20,0	20	38,00	104	0,30	2
6092683	40022000T038S	20,0	20	38,00	104	—	2
5873537	40022000T056	20,0	20	56,00	125	0,30	2
6092684	40022000T056S	20,0	20	56,00	125	—	2
6092685	40122000T075S	20,0	20	75,00	150	—	2
5873538	40122000T075	20,0	20	75,00	150	0,30	2

INDEXABLE MILLING

SOLID END MILLING

HOLEMAKING

TAPPING

TURNING

## GP End Mills • Series D002 D012 • Square End • 2 Flute • Metric

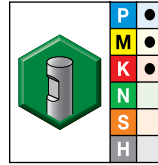
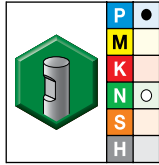
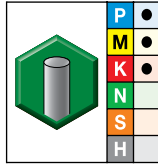
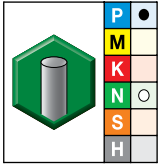
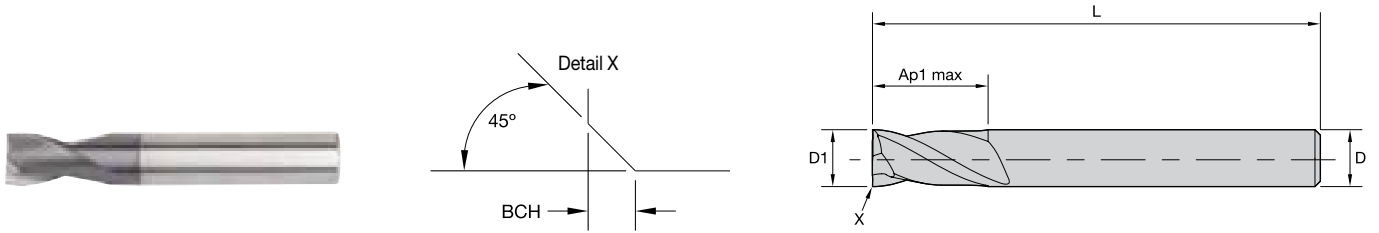

• first choice  
○ alternate choice

UNCOATED		TiAlN		UNCOATED		TiAlN		D1	D	length of cut Ap1 max	length L	BCH	Z U
order #	catalog #	order #	catalog #	order #	catalog #	order #	catalog #						
5877567	D0020200T003	5877330	D0020200T003	—	—	—	—	2,0	6	3,00	50	—	2
—	—	5877501	D0020250T003	—	—	—	—	2,5	6	3,00	50	—	2
5877569	D0120250T007	5877502	D0120250T007	—	—	—	—	2,5	6	7,00	57	—	2
5877571	D0020300T004	5877503	D0020300T004	—	—	—	—	3,0	6	4,00	50	—	2
5877572	D0120300T007	5877504	D0120300T007	—	—	—	—	3,0	6	7,00	57	—	2
5877573	D0020350T004	5877505	D0020350T004	—	—	—	—	3,5	6	4,00	50	—	2
—	—	5877506	D0020400T005	—	—	—	—	4,0	6	5,00	54	0,10	2
—	—	6092298	D0020400T005S	—	—	—	—	4,0	6	5,00	54	—	2
6092392	D0120400T008S	6092299	D0120400T008S	—	—	—	—	4,0	6	8,00	57	—	2
5877575	D0120400T008	5877507	D0120400T008	—	—	—	—	4,0	6	8,00	57	0,10	2
—	—	6092300	D0020450T005S	—	—	—	—	4,5	6	5,00	54	—	2
—	—	5877509	D0020450T005	—	—	—	—	4,5	6	5,00	54	0,10	2
—	—	6092301	D0120450T008S	—	—	—	—	4,5	6	8,00	57	—	2
—	—	5877510	D0120450T008	—	—	—	—	4,5	6	8,00	57	0,10	2
6092397	D0020500T006S	6092302	D0020500T006S	—	—	—	—	5,0	6	6,00	54	—	2
—	—	5877511	D0020500T006	—	—	—	—	5,0	6	6,00	54	0,10	2
6092398	D0120500T010S	6092303	D0120500T010S	—	—	—	—	5,0	6	10,00	57	—	2
5877579	D0120500T010	5877512	D0120500T010	—	—	—	—	5,0	6	10,00	57	0,10	2
6092399	D0020600T007S	6092304	D0020600T007S	—	—	—	—	6,0	6	7,00	54	—	2
5877581	D0020600T007	5877513	D0020600T007	—	—	—	—	6,0	6	7,00	54	0,10	2
6092411	D0120600T010S	6092305	D0120600T010S	—	—	—	—	6,0	6	10,00	57	—	2
5877582	D0120600T010	5877514	D0120600T010	—	—	—	—	6,0	6	10,00	57	0,10	2
6092412	D0020700T008S	6092306	D0020700T008S	—	—	—	—	7,0	8	8,00	58	—	2
—	—	5877515	D0020700T008	—	—	—	—	7,0	8	8,00	58	0,10	2
6092414	D0120700T013S	6092307	D0120700T013S	—	—	—	—	7,0	8	13,00	63	—	2
5877584	D0120700T013	5877516	D0120700T013	—	—	—	—	7,0	8	13,00	63	0,10	2
6092415	D0020800T009S	6092308	D0020800T009S	—	—	—	—	8,0	8	9,00	58	—	2
—	—	5877517	D0020800T009	—	—	—	—	8,0	8	9,00	58	0,20	2
6092416	D0120800T016S	6092309	D0120800T016S	—	—	—	—	8,0	8	16,00	63	—	2
5877586	D0120800T016	5877518	D0120800T016	—	—	—	—	8,0	8	16,00	63	0,20	2
6092418	D0020900T010S	6092310	D0020900T010S	—	—	—	—	9,0	10	10,00	66	—	2
5877588	D0020900T010	—	—	—	—	—	—	9,0	10	10,00	66	0,20	2
—	—	6092321	D0120900T016S	—	—	—	—	9,0	10	16,00	72	—	2
—	—	5877521	D0120900T016	—	—	—	—	9,0	10	16,00	72	0,20	2
6092421	D0021000T011S	6092322	D0021000T011S	—	—	—	—	10,0	10	11,00	66	—	2
5877590	D0021000T011	5877522	D0021000T011	—	—	—	—	10,0	10	11,00	66	0,20	2
6092422	D0121000T019S	6092323	D0121000T019S	—	—	—	—	10,0	10	19,00	72	—	2
—	—	5877523	D0121000T019	—	—	—	—	10,0	10	19,00	72	0,20	2
6092423	D0021200T012S	6092324	D0021200T012S	—	—	6092334	D0021200W012S	12,0	12	12,00	73	—	2
5877592	D0021200T012	5877524	D0021200T012	—	—	5877535	D0021200W012	12,0	12	12,00	73	0,30	2
6092424	D0121200T022S	6092325	D0121200T022S	—	—	6092335	D0121200W022S	12,0	12	22,00	83	—	2
—	—	5877525	D0121200T022	—	—	5877537	D0121200W022	12,0	12	22,00	83	0,30	2
6092426	D0021400T014S	6092326	D0021400T014S	—	—	6092336	D0021400W014S	14,0	14	14,00	75	—	2
—	—	5877526	D0021400T014	—	—	5877538	D0021400W014	14,0	14	14,00	75	0,30	2
—	—	6092327	D0121400T022S	—	—	6092337	D0121400W022S	14,0	14	22,00	83	—	2
5877595	D0121400T022	5877527	D0121400T022	—	—	5877539	D0121400W022	14,0	14	22,00	83	0,30	2
—	—	6092328	D0021600T016S	—	—	6092338	D0021600W016S	16,0	16	16,00	82	—	2
—	—	5877529	D0021600T016	—	—	5877540	D0021600W016	16,0	16	16,00	82	0,30	2
—	—	6092329	D0121600T026S	6092350	D0121600W026S	6092339	D0121600W026S	16,0	16	26,00	92	—	2
—	—	5877530	D0121600T026	—	—	5877551	D0121600W026	16,0	16	26,00	92	0,30	2
—	—	6092330	D0021800T018S	—	—	6092340	D0021800W018S	18,0	18	18,00	84	—	2
—	—	5877531	D0021800T018	—	—	5877552	D0021800W018	18,0	18	18,00	84	0,30	2
—	—	6092331	D0121800T026S	—	—	6092341	D0121800W026S	18,0	18	26,00	92	—	2
—	—	5877532	D0121800T026	—	—	5877553	D0121800W026	18,0	18	26,00	92	0,30	2
—	—	6092332	D0022000T020S	—	—	6092342	D0022000W020S	20,0	20	20,00	92	—	2
—	—	5877533	D0022000T020	—	—	5877554	D0022000W020	20,0	20	20,00	92	0,30	2
—	—	6092333	D0122000T032S	—	—	6092344	D0122000W032S	20,0	20	32,00	104	—	2
5877602	D0122000T032	5877534	D0122000T032	—	—	5877555	D0122000W032	20,0	20	32,00	104	0,30	2

# General-Purpose Solid Carbide End Mills

## GP End Mills • Series 2819 • Square End • 2 Flute • Metric DIN 6528

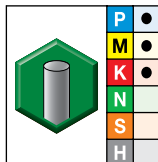
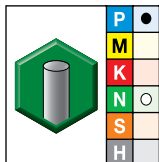
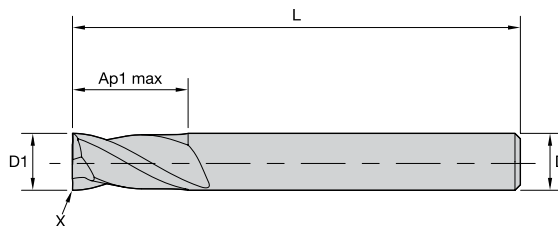
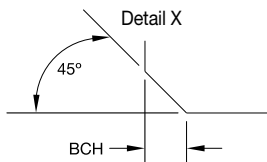
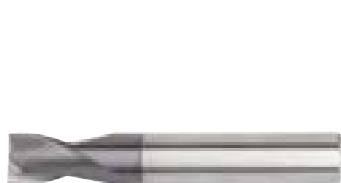

● first choice  
○ alternate choice

UNCOATED		TiAlN		D1	D	length of cut Ap1 max	length L	BCH	Z U
order #	catalog #	order #	catalog #						
6092573	28190400T008S	5877603	28190300T007	3,0	3	8,00	50	—	2
—	—	6092528	28190400T008S	4,0	4	8,00	50	—	2
—	—	5877604	28190400T008	4,0	4	8,00	50	0,10	2
—	—	6092529	28190500T010S	5,0	5	10,00	50	—	2
—	—	5877605	28190500T010	5,0	5	10,00	50	0,10	2
—	—	6092530	28190600T010S	6,0	6	10,00	57	—	2
—	—	5877606	28190600T010	6,0	6	10,00	57	0,10	2
—	—	6092562	28190800T016S	8,0	8	16,00	63	—	2
—	—	5877608	28190800T016	8,0	8	16,00	63	0,20	2
—	—	6092563	28190900T016S	9,0	9	16,00	67	—	2
—	—	5877609	28190900T016	9,0	9	16,00	67	0,20	2
—	—	6092565	28191000T019S	10,0	10	19,00	72	—	2
—	—	5877610	28191000T019	10,0	10	19,00	72	0,20	2
—	—	6092566	28191200T022S	12,0	12	22,00	83	—	2
—	—	5877611	28191200T022	12,0	12	22,00	83	0,30	2
—	—	6092567	28191400T022S	14,0	14	22,00	83	—	2
—	—	5877612	28191400T022	14,0	14	22,00	83	0,30	2
—	—	6092568	28191500T026S	15,0	15	26,00	92	—	2
—	—	5877613	28191500T026	15,0	15	26,00	92	0,30	2
—	—	6092569	28191600T026S	16,0	16	26,00	92	—	2
—	—	5877614	28191600T026	16,0	16	26,00	92	0,30	2
—	—	6092571	28192000T032S	20,0	20	32,00	104	—	2
—	—	5877616	28192000T032	20,0	20	32,00	104	0,30	2

INDEXABLE MILLING

SOLID END MILLING

HOLEMAKING

TAPPING

TURNING

## GP End Mills • Series 4001 4011 4021 • Ball Nose • 2 Flute • Metric

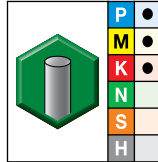
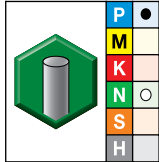
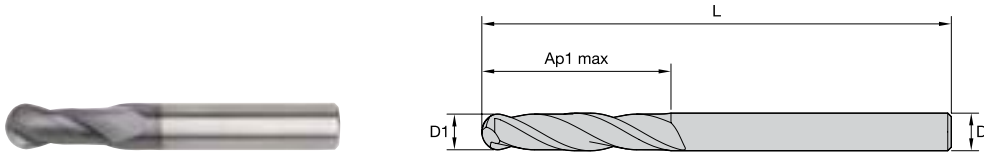

- first choice
- alternate choice

### UNCOATED

### TiAlN

order #	catalog #	order #	catalog #	D1	D	length of cut Ap1 max	length L	Z U
5880425	40010100T004	5880387	40010100T004	1,0	3	4,00	38	2
5880426	40010150T005	5880388	40010150T005	1,5	3	5,00	38	2
5880427	40010200T006	5880389	40010200T006	2,0	3	6,30	38	2
—	—	5880390	40010250T007	2,5	3	7,00	38	2
5880429	40010300T009	5880391	40010300T009	3,0	3	9,50	38	2
—	—	6232631	40110300T019	3,0	3	19,00	63	2
—	—	6232632	40210300T025	3,0	3	25,00	75	2
—	—	5880392	40010350T012	3,5	4	12,00	50	2
5880430	40010400T012	5880393	40010400T012	4,0	4	12,00	50	2
—	—	5880395	40110400T019	4,0	4	19,00	63	2
5880432	40210400T031	5880396	40210400T031	4,0	4	31,00	75	2
5880433	40010500T014	6209446	40010500T014	5,0	5	14,00	50	2
—	—	6209447	40110500T020	5,0	5	20,00	63	2
—	—	5880397	40210500T014	5,0	6	14,00	50	2
5880435	40010600T020	5880398	40010600T020	6,0	6	20,00	63	2
5880436	40110600T028	5880399	40110600T028	6,0	6	28,00	76	2
5880437	40210600T038	5880400	40210600T038	6,0	6	38,00	100	2
5880438	40010800T020	5880401	40010800T020	8,0	8	20,00	63	2
5880439	40110800T028	5880402	40110800T028	8,0	8	28,00	76	2
5880440	40210800T040	5880403	40210800T040	8,0	8	40,00	100	2
5880441	40011000T022	5880404	40011000T022	10,0	10	22,00	76	2
5880442	40111000T032	5880405	40111000T032	10,0	10	32,00	89	2
5880443	40211000T045	5880406	40211000T045	10,0	10	45,00	100	2
5880444	40011200T025	5880407	40011200T025	12,0	12	25,00	75	2
5880445	40111200T045	5880408	40111200T045	12,0	12	45,00	100	2
5880446	40211200T075	5880409	40211200T075	12,0	12	75,00	150	2
—	—	5880410	40011400T032	14,0	14	32,00	89	2
5880448	40011600T032	5880411	40011600T032	16,0	16	32,00	89	2
—	—	6209448	40111600T056	16,0	16	56,00	110	2
—	—	6209449	40211600T075	16,0	16	75,00	150	2
5880449	40012000T038	5880412	40012000T038	20,0	20	38,00	100	2
5880450	40112000T075	5880413	40112000T075	20,0	20	75,00	150	2

INDEXABLE MILLING

SOLID END MILLING

HOLEMAKING

TAPPING

TURNING

# General-Purpose Solid Carbide End Mills

## GP End Mills • Series D001 D011 • Ball Nose • 2 Flute • Metric

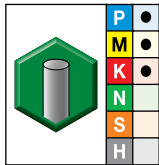
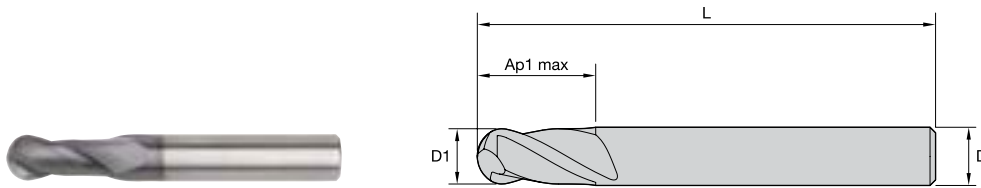

- first choice
- alternate choice

TIAlN

order #	catalog #	D1	D	length of cut Ap1 max	length L	Z U
5880362	D0110200T006	2,0	6	6,00	57	2
5880363	D0010300T004	3,0	6	4,00	50	2
5880364	D0110300T007	3,0	6	7,00	57	2
5880365	D0010400T005	4,0	6	5,00	54	2
5880366	D0110400T008	4,0	6	8,00	57	2
5880367	D0110500T010	5,0	6	10,00	57	2
5880368	D0110600T010	6,0	6	10,00	57	2
5880369	D0110700T013	7,0	8	13,00	63	2
5880370	D0110800T016	8,0	8	16,00	63	2
5880381	D0111000T019	10,0	10	19,00	72	2
5880382	D0111200T022	12,0	12	22,00	83	2
5880383	D0111400T022	14,0	14	22,00	83	2
5880384	D0111600T026	16,0	16	26,00	92	2
5880385	D0012000T020	20,0	20	20,00	92	2
5880386	D0112000T032	20,0	20	32,00	104	2

## GP End Mills • Series 2838 • Ball Nose • 2 Flute • Metric

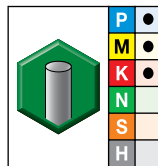
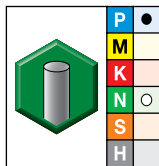
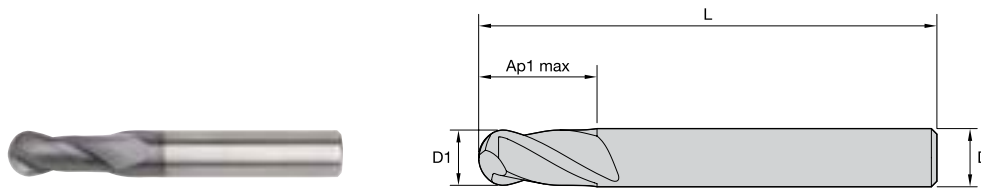

- first choice
- alternate choice

UNCOATED

TIAlN

order #	catalog #	order #	catalog #	D1	D	length of cut Ap1 max	length L	Z U
—	—	5880451	28380200T007	2,0	2	7,00	50	2
—	—	5880452	28380300T007	3,0	3	7,00	50	2
—	—	5880453	28380400T008	4,0	4	8,00	50	2
—	—	5880454	28380500T010	5,0	5	10,00	50	2
5880465	28380600T010	5880455	28380600T010	6,0	6	10,00	57	2
—	—	5880456	28380800T016	8,0	8	16,00	63	2
—	—	5880457	28381000T019	10,0	10	19,00	72	2
—	—	5880458	28381200T022	12,0	12	22,00	83	2
—	—	5880459	28381400T022	14,0	14	22,00	83	2
—	—	5880460	28381600T026	16,0	16	26,00	92	2

## GP End Mills • Series 4003 4013 • Sharp Edge • 3 Flute • Metric

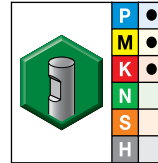
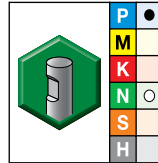
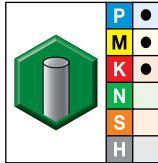
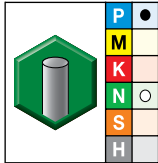
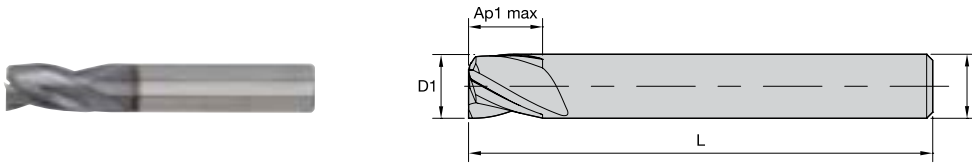

- first choice
- alternate choice

UNCOATED		TiAlN		UNCOATED		TiAlN		D1	D	length of cut Ap1 max	length L	Z U
order #	catalog #	order #	catalog #	order #	catalog #	order #	catalog #					
6144570	40030100T004S	6144056	40030100T004S	—	—	—	—	1,0	3	4,00	38	3
6144651	40030150T004S	6144057	40030150T004S	—	—	—	—	1,5	3	4,00	38	3
6144652	40030200T006S	6144058	40030200T006S	—	—	—	—	2,0	3	6,30	38	3
6144653	40030250T006S	6144059	40030250T006S	—	—	—	—	2,5	3	6,30	38	3
6144654	40030300T009S	6144060	40030300T009S	—	—	—	—	3,0	3	9,50	38	3
6145303	40130300T019S	6145199	40130300T019S	6145319	40130300W019S	6145243	40130300W019S	3,0	6	19,00	63	3
6144655	40030400T012S	6144551	40030400T012S	—	—	—	—	4,0	4	12,00	50	3
6145305	40130400T019S	6145200	40130400T019S	—	—	—	—	4,0	4	19,00	63	3
6144656	40030500T014S	6144552	40030500T014S	—	—	—	—	5,0	6	14,00	50	3
—	—	6145231	40130500T020S	—	—	6145247	40130500W020S	5,0	6	20,00	63	3
6144657	40030600T016S	6144553	40030600T016S	—	—	6144565	40030600W016S	6,0	6	16,00	50	3
6145309	40130600T028S	6145232	40130600T028S	—	—	—	—	6,0	6	28,00	75	3
6144658	40030800T019S	6144554	40030800T019S	—	—	6144566	40030800W019S	8,0	8	19,00	63	3
6145311	40130800T028S	6145233	40130800T028S	—	—	—	—	8,0	8	28,00	75	3
6144659	40031000T022S	6144555	40031000T022S	—	—	6144567	40031000W022S	10,0	10	22,00	76	3
6145313	40131000T032S	6145234	40131000T032S	—	—	—	—	10,0	10	32,00	89	3
6144660	40031200T025S	6144556	40031200T025S	—	—	6144568	40031200W025S	12,0	12	25,00	75	3
6145315	40131200T045S	6145235	40131200T045S	—	—	6145255	40131200W045S	12,0	12	45,00	100	3
6144661	40031600T032S	6144557	40031600T032S	—	—	6144569	40031600W032S	16,0	16	32,00	89	3
6145317	40131600T056S	6145238	40131600T056S	—	—	6145257	40131600W056S	16,0	16	56,00	110	3
6145318	40132000T064S	6145241	40132000T064S	—	—	6145259	40132000W064S	20,0	20	64,00	125	3

INDEXABLE MILLING

SOLID END MILLING

HOLEMAKING

TAPPING

TURNING

# General-Purpose Solid Carbide End Mills

## GP End Mills • Series 4003 4013 • Chamfered • 3 Flute • Metric

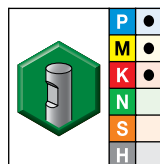
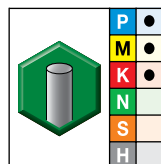
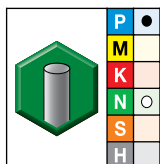
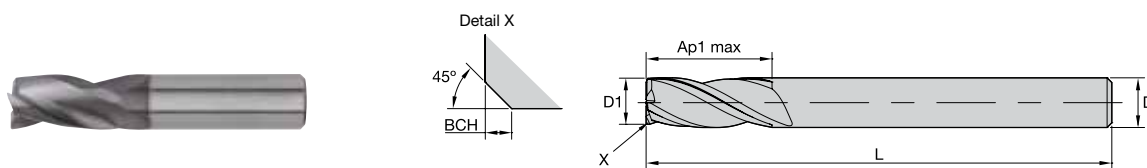

● first choice  
○ alternate choice

UNCOATED		TiAlN		TiAlN		D1	D	length of cut Ap1 max	length L	BCH	Z U
order #	catalog #	order #	catalog #	order #	catalog #						
—	—	6145107	40030400T012	—	—	4,0	4	12,00	50	0,10	3
—	—	6145181	40130400T019	—	—	4,0	4	19,00	63	0,10	3
6145275	40130500T020	6145182	40130500T020	6145190	40130500W020	5,0	6	20,00	63	0,10	3
6145242	40030600T016	6145109	40030600T016	6145176	40030600W016	6,0	6	16,00	50	0,10	3
6145276	40130600T028	6145183	40130600T028	—	—	6,0	6	28,00	75	0,10	3
—	—	6145110	40030800T019	—	—	8,0	8	19,00	63	0,20	3
6145277	40130800T028	6145184	40130800T028	—	—	8,0	8	28,00	75	0,20	3
—	—	6145171	40031000T022	6145178	40031000W022	10,0	10	22,00	76	0,20	3
6145278	40131000T032	6145185	40131000T032	—	—	10,0	10	32,00	89	0,20	3
6145248	40031200T025	6145172	40031200T025	6145179	40031200W025	12,0	12	25,00	75	0,30	3
6145279	40131200T045	6145186	40131200T045	6145194	40131200W045	12,0	12	45,00	100	0,30	3
6145250	40031600T032	6145173	40031600T032	6145180	40031600W032	16,0	16	32,00	89	0,30	3
—	—	6145187	40131600T056	6145195	40131600W056	16,0	16	56,00	110	0,30	3
—	—	6145188	40132000T064	6145196	40132000W064	20,0	20	64,00	125	0,30	3

INDEXABLE MILLING

SOLID END MILLING

HOLEMAKING

TAPPING

TURNING

## GP End Mills • Series D003 D013 • Sharp Edge • 3 Flute • Metric

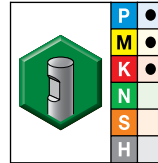
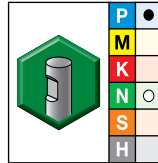
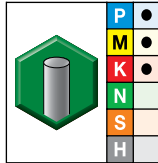
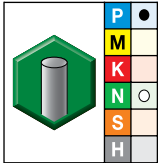
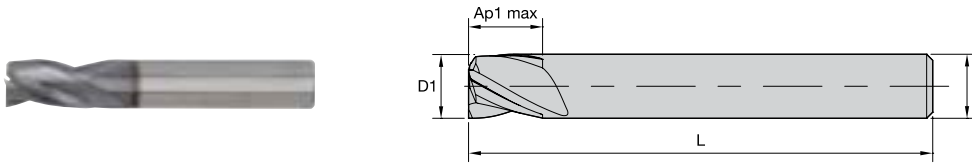

- first choice
- alternate choice

UNCOATED		TiAlN		UNCOATED		TiAlN		D1	D	length of cut Ap1 max	length L	Z U
order #	catalog #	order #	catalog #	order #	catalog #	order #	catalog #					
6144450	D0030200T003S	6144351	D0030200T003S	—	—	6144388	D0030200W003S	2,0	6	3,00	50	3
6143764	D0130200T006S	6144441	D0130200T006S	6143831	D0130200W006S	6144467	D0130200W006S	2,0	6	6,00	57	3
—	—	6144352	D0030250T003S	—	—	6144390	D0030250W003S	2,5	6	3,00	50	3
6143765	D0130250T007S	6144442	D0130250T007S	6143832	D0130250W007S	6144469	D0130250W007S	2,5	6	7,00	57	3
6144454	D0030300T004S	6144353	D0030300T004S	6144488	D0030300W004S	6144392	D0030300W004S	3,0	6	4,00	50	3
6143766	D0130300T007S	6144443	D0130300T007S	6143833	D0130300W007S	6144471	D0130300W007S	3,0	6	7,00	57	3
6144456	D0030350T004S	6144354	D0030350T004S	—	—	6144394	D0030350W004S	3,5	6	4,00	50	3
—	—	6144444	D0130350T007S	6143834	D0130350W007S	6144473	D0130350W007S	3,5	6	7,00	57	3
—	—	6144355	D0030400T005S	6144492	D0030400W005S	6144396	D0030400W005S	4,0	6	5,00	54	3
6143768	D0130400T008S	6144445	D0130400T008S	6143835	D0130400W008S	6144475	D0130400W008S	4,0	6	8,00	57	3
—	—	6144446	D0130450T008S	6143836	D0130450W008S	—	—	4,5	6	8,00	57	3
—	—	6144357	D0030500T006S	—	—	6144400	D0030500W006S	5,0	6	6,00	54	3
6143770	D0130500T010S	6144447	D0130500T010S	6143837	D0130500W010S	—	—	5,0	6	10,00	57	3
—	—	6144358	D0030550T007S	—	—	—	—	5,5	6	7,00	54	3
—	—	6144448	D0130550T010S	—	—	6144481	D0130550W010S	5,5	6	10,00	57	3
—	—	6144360	D0030600T007S	—	—	6144404	D0030600W007S	6,0	6	7,00	54	3
6143822	D0130600T010S	6144449	D0130600T010S	6143839	D0130600W010S	6144483	D0130600W010S	6,0	6	10,00	57	3
6144468	D0030700T008S	6144372	D0030700T008S	—	—	6144406	D0030700W008S	7,0	8	8,00	58	3
—	—	6144451	D0130700T013S	—	—	6144485	D0130700W013S	7,0	8	13,00	63	3
—	—	6144374	D0030800T009S	—	—	6144408	D0030800W009S	8,0	8	9,00	58	3
—	—	6144453	D0130800T016S	—	—	6144487	D0130800W016S	8,0	8	16,00	63	3
—	—	6144376	D0031000T011S	—	—	6144410	D0031000W011S	10,0	10	11,00	66	3
—	—	—	—	6143842	D0131000W019S	6144489	D0131000W019S	10,0	10	19,00	72	3
—	—	6144378	D0031200T012S	—	—	6144412	D0031200W012S	12,0	12	12,00	73	3
—	—	6144457	D0131200T022S	—	—	6144491	D0131200W022S	12,0	12	22,00	83	3
—	—	6144380	D0031400T014S	—	—	6144414	D0031400W014S	14,0	14	14,00	75	3
6143827	D0131400T022S	6144459	D0131400T022S	—	—	6144493	D0131400W022S	14,0	14	22,00	83	3
—	—	6144382	D0031600T016S	—	—	6144416	D0031600W016S	16,0	16	16,00	82	3
—	—	6144461	D0131600T026S	—	—	6144495	D0131600W026S	16,0	16	26,00	92	3
—	—	6144384	D0031800T018S	—	—	6144418	D0031800W018S	18,0	18	18,00	84	3
—	—	6144463	D0131800T026S	—	—	6144497	D0131800W026S	18,0	18	26,00	92	3
6144482	D0032000T020S	6144386	D0032000T020S	—	—	6144420	D0032000W020S	20,0	20	20,00	92	3
—	—	6144465	D0132000T032S	—	—	6144499	D0132000W032S	20,0	20	32,00	104	3

INDEXABLE MILLING

SOLID END MILLING

HOLEMAKING

TAPPING

TURNING



## GP End Mills • Series D003 D013 • Chamfered • 3 Flute • Metric

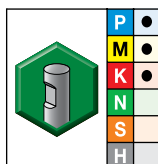
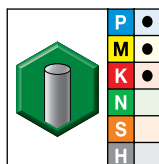
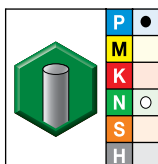
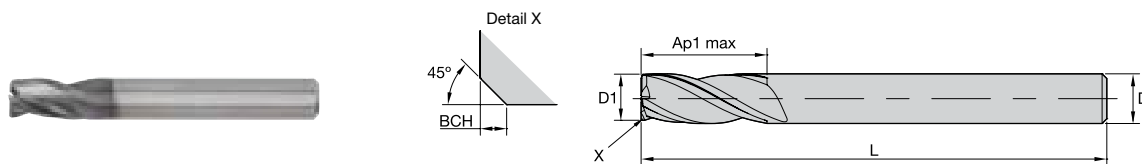

● first choice  
○ alternate choice

UNCOATED		TiAlN		TiAlN		D1	D	length of cut Ap1 max	length L	BCH	Z U
order #	catalog #	order #	catalog #	order #	catalog #						
—	—	6144295	D0030400T005	6144318	D0030400W005	4,0	6	5,00	54	0,10	3
—	—	6144359	D0130400T008	6144395	D0130400W008	4,0	6	8,00	57	0,10	3
—	—	6144296	D0030450T005	6144319	D0030450W005	4,5	6	5,00	54	0,10	3
—	—	6144371	D0130450T008	6144397	D0130450W008	4,5	6	8,00	57	0,10	3
6145044	D0030500T006	6144297	D0030500T006	6144320	D0030500W006	5,0	6	6,00	54	0,10	3
—	—	6144373	D0130500T010	6144399	D0130500W010	5,0	6	10,00	57	0,10	3
—	—	6144298	D0030550T007	6144331	D0030550W007	5,5	6	7,00	54	0,10	3
—	—	6144375	D0130550T010	6144401	D0130550W010	5,5	6	10,00	57	0,10	3
—	—	6144299	D0030600T007	6144332	D0030600W007	6,0	6	7,00	54	0,10	3
—	—	6144377	D0130600T010	6144403	D0130600W010	6,0	6	10,00	57	0,10	3
—	—	6144300	D0030700T008	6144333	D0030700W008	7,0	8	8,00	58	0,10	3
—	—	6144379	D0130700T013	6144405	D0130700W013	7,0	8	13,00	63	0,10	3
—	—	6144311	D0030800T009	6144334	D0030800W009	8,0	8	9,00	58	0,20	3
6145087	D0130800T016	6144381	D0130800T016	6144407	D0130800W016	8,0	8	16,00	63	0,20	3
—	—	6144312	D0031000T011	6144335	D0031000W011	10,0	10	11,00	66	0,20	3
—	—	6144383	D0131000T019	6144409	D0131000W019	10,0	10	19,00	72	0,20	3
—	—	6144313	D0031200T012	6144336	D0031200W012	12,0	12	12,00	73	0,30	3
—	—	6144385	D0131200T022	6144411	D0131200W022	12,0	12	22,00	83	0,30	3
—	—	6144314	D0031400T014	6144337	D0031400W014	14,0	14	14,00	75	0,30	3
—	—	6144387	D0131400T022	6144413	D0131400W022	14,0	14	22,00	83	0,30	3
—	—	6144315	D0031600T016	6144338	D0031600W016	16,0	16	16,00	82	0,30	3
—	—	6144389	D0131600T026	—	—	16,0	16	26,00	92	0,30	3
—	—	6144316	D0031800T018	6144339	D0031800W018	18,0	18	18,00	84	0,30	3
—	—	6144391	D0131800T026	6144417	D0131800W026	18,0	18	26,00	92	0,30	3
—	—	6144317	D0032000T020	—	—	20,0	20	20,00	92	0,30	3
—	—	6144393	D0132000T032	6144419	D0132000W032	20,0	20	32,00	104	0,30	3

INDEXABLE MILLING

SOLID END MILLING

HOLEMAKING

TAPPING

TURNING

## GP End Mills • Series 4004 4014 4024 • Square End • 4 Flute • Metric

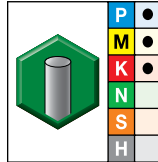
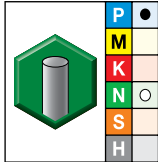
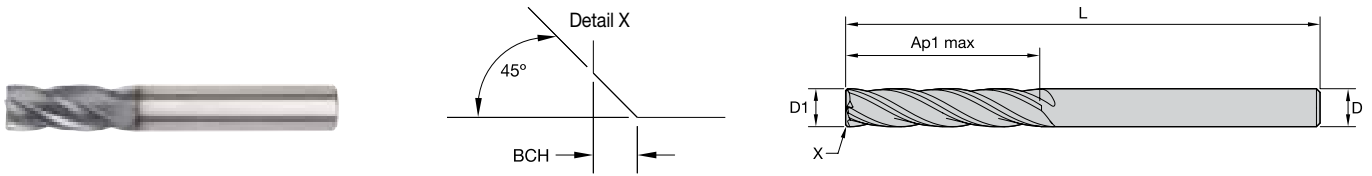

● first choice  
○ alternate choice

UNCOATED		TiAlN		D1	D	length of cut Ap1 max	length L	BCH	Z U
5826085	40040100T004	5826016	40040100T004	1,0	3	4,00	38	—	4
5826086	40040150T004	5826017	40040150T004	1,5	3	4,00	38	—	4
5826087	40040200T006	5826018	40040200T006	2,0	3	6,30	38	—	4
5826088	40040250T006	5826019	40040250T006	2,5	3	6,30	38	—	4
5826089	40040300T009	5826020	40040300T009	3,0	3	9,50	38	—	4
5826090	40140300T019	5826021	40140300T019	3,0	3	19,00	63	—	4
5826101	40240300T025	5826022	40240300T025	3,0	3	25,00	75	—	4
5826102	40040350T012	5826023	40040350T012	3,5	4	12,00	50	—	4
5826103	40040400T011	5826024	40040400T011	4,0	4	11,00	50	0,10	4
6085522	40040400T011S	6085576	40040400T011S	4,0	4	11,00	50	—	4
—	—	6085577	40140400T019S	4,0	4	19,00	63	—	4
—	—	5826025	40140400T019	4,0	4	19,00	63	0,10	4
—	—	6085578	40240400T031S	4,0	4	31,00	75	—	4
—	—	5826026	40240400T031	4,0	4	31,00	75	0,10	4
5826104	40040450T014	6085579	40040450T014S	4,5	5	14,00	50	—	4
—	—	5826027	40040450T014	4,5	5	14,00	50	0,10	4
—	—	6085580	40040500T013S	5,0	5	13,00	50	—	4
—	—	5826028	40040500T013	5,0	5	13,00	50	0,10	4
5826105	40040500T020	6085581	40040500T020S	5,0	5	20,00	63	—	4
—	—	5826029	40040500T020	5,0	5	20,00	63	0,10	4
—	—	6085582	40140500T030S	5,0	5	30,00	75	—	4
—	—	5826030	40140500T030	5,0	5	30,00	75	0,10	4
—	—	6085583	40240500T031S	5,0	5	31,00	100	—	4
—	—	5826031	40240500T031	5,0	5	31,00	100	0,10	4
6085525	40040600T016S	6085584	40040600T016S	6,0	6	16,00	50	—	4
5826106	40040600T016	5826032	40040600T016	6,0	6	16,00	50	0,10	4
6085526	40140600T028S	6085585	40140600T028S	6,0	6	28,00	75	—	4
5826107	40140600T028	5826033	40140600T028	6,0	6	28,00	75	0,10	4
6085527	40240600T038S	6085586	40240600T038S	6,0	6	38,00	100	—	4
5826108	40240600T038	5826034	40240600T038	6,0	6	38,00	100	0,10	4
—	—	6085587	40040700T020S	7,0	8	20,00	63	—	4
—	—	5826035	40040700T020	7,0	8	20,00	63	0,10	4
—	—	6200965	40040800T021S	8,0	8	20,00	63	—	4
6085528	40040800T020S	6085588	40040800T020S	8,0	8	20,00	50	—	4
5826109	40040800T020	5826036	40040800T020	8,0	8	20,00	50	0,20	4
6085529	40140800T028S	6085589	40140800T028S	8,0	8	28,00	75	—	4
5826110	40140800T028	5826037	40140800T028	8,0	8	28,00	75	0,20	4
6085530	40240800T041S	6085590	40240800T041S	8,0	8	41,00	100	—	4
5826111	40240800T041	5826038	40240800T041	8,0	8	41,00	100	0,20	4
—	—	6085591	40040900T020S	9,0	9	20,00	63	—	4
—	—	5826039	40040900T020	9,0	9	20,00	63	0,20	4
5826113	40041000T022	5826040	40041000T022	10,0	10	22,00	72	0,20	4
6085531	40041000T022S	6085592	40041000T022S	10,0	10	22,00	72	—	4
6085532	40141000T032S	6085593	40141000T032S	10,0	10	32,00	89	—	4
5826114	40141000T032	5826041	40141000T032	10,0	10	32,00	89	0,20	4
6085533	40241000T045S	6085594	40241000T045S	10,0	10	45,00	100	—	4
5826115	40241000T045	5826042	40241000T045	10,0	10	45,00	100	0,20	4
5826141	40041200W025	—	—	12,0	12	25,00	75	0,30	4
6085534	40041200T025S	6085610	40041200W025S	12,0	12	25,00	75	—	4
—	—	5826043	40041200T025	12,0	12	25,00	89	0,30	4
—	—	6085595	40041200T025S	12,0	12	25,00	89	—	4
5826116	40041200T025	5826070	40041200W025	12,0	12	25,00	75	0,30	4
6085549	40041200W025S	—	—	12,0	12	25,00	75	—	4
6085535	40141200T045S	6085596	40141200T045S	12,0	12	45,00	100	—	4
5826117	40141200T045	5826044	40141200T045	12,0	12	45,00	100	0,30	4
—	—	6085611	40141200W045S	12,0	12	45,00	100	—	4

# General-Purpose Solid Carbide End Mills

## GP End Mills • Series 4004 4014 4024 • Square End • 4 Flute • Metric

(continued)

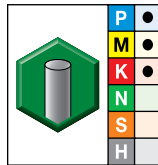
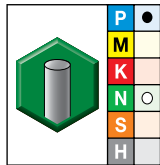
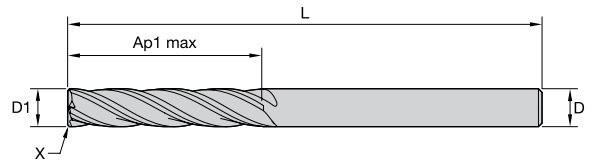
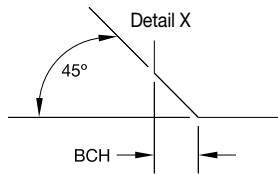
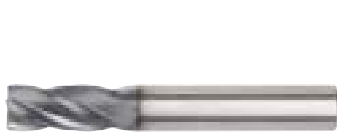

● first choice  
○ alternate choice

UNCOATED		TiAlN		D1	D	length of cut	length	BCH	Z U
order #	catalog #	order #	catalog #			Ap1 max	L		
6085536	40241200T075S	5826071	40141200W045	12,0	12	45,00	100	0,30	4
5826118	40241200T075	6085597	40241200T075S	12,0	12	75,00	150	—	4
—	—	5826045	40241200T075	12,0	12	75,00	150	0,30	4
—	—	6085612	40241200W075S	12,0	12	75,00	150	—	4
—	—	5826072	40241200W075	12,0	12	75,00	150	0,30	4
—	—	6085613	40041400W032S	14,0	14	32,00	83	—	4
6085537	40041400T032S	5826073	40041400W032	14,0	14	32,00	83	0,30	4
5826119	40041400T032	6085598	40041400T032S	14,0	14	32,00	83	—	4
—	—	5826046	40041400T032	14,0	14	32,00	83	0,30	4
—	—	6085599	40141400T050S	14,0	14	50,00	100	—	4
—	—	5826047	40141400T050	14,0	14	50,00	100	0,30	4
—	—	6085614	40141400W050S	14,0	14	50,00	100	—	4
—	—	5826074	40141400W050	14,0	14	50,00	100	0,30	4
—	—	6085600	40241400T075S	14,0	14	75,00	150	—	4
—	—	5826049	40241400T075	14,0	14	75,00	150	0,30	4
—	—	6085615	40241400W075S	14,0	14	75,00	150	—	4
—	—	5826075	40241400W075	14,0	14	75,00	150	0,30	4
—	—	6085616	40041600W032S	16,0	16	32,00	92	—	4
6085540	40041600T032S	5826076	40041600W032	16,0	16	32,00	92	0,30	4
5826122	40041600T032	6085601	40041600T032S	16,0	16	32,00	92	—	4
5826123	40141600T056	5826062	40141600T056	16,0	16	56,00	110	0,30	4
—	—	6102465	40141600W056S	16,0	16	56,00	110	—	4
—	—	5826077	40141600W056	16,0	16	56,00	110	0,30	4
6085541	40141600T056S	6085602	40141600T056S	16,0	16	56,00	110	—	4
6085542	40241600T075S	6085603	40241600T075S	16,0	16	75,00	150	—	4
5826124	40241600T075	5826063	40241600T075	16,0	16	75,00	150	0,30	4
—	—	6085427	40241600W075S	16,0	16	75,00	150	—	4
—	—	5826078	40241600W075	16,0	16	75,00	150	0,30	4
6086533	40041800W038S	6085428	40041800W038S	18,0	18	38,00	100	—	4
6085543	40041800T038S	6085604	40041800T038S	18,0	18	38,00	100	—	4
5826125	40041800T038	5826064	40041800T038	18,0	18	38,00	100	0,30	4
—	—	6085605	40141800T060S	18,0	18	60,00	125	—	4
—	—	5826065	40141800T060	18,0	18	60,00	125	0,30	4
—	—	6085606	40241800T075S	18,0	18	75,00	150	—	4
—	—	5826066	40241800T075	18,0	18	75,00	150	0,30	4
6085546	40042000T038S	6085607	40042000T038S	20,0	20	38,00	104	—	4
—	—	5826082	40042000W038	20,0	20	38,00	104	0,30	4
5826128	40042000T038	5826067	40042000T038	20,0	20	38,00	104	0,30	4
—	—	6085511	40042000W038S	20,0	20	38,00	104	—	4
—	—	5826083	40142000W056	20,0	20	56,00	125	0,30	4
—	—	5826068	40142000T056	20,0	20	56,00	125	0,30	4
6085547	40142000T056S	6085608	40142000T056S	20,0	20	56,00	125	—	4
—	—	6085512	40142000W056S	20,0	20	56,00	125	—	4
6085548	40242000T075S	6085609	40242000T075S	20,0	20	75,00	150	—	4
—	—	5826069	40242000T075	20,0	20	75,00	150	0,30	4
—	—	6085513	40242000W075S	20,0	20	75,00	150	—	4
—	—	5826084	40242000W075	20,0	20	75,00	150	0,30	4

## GP End Mills • Series 4004 4014 4024 • Radiused • 4 Flute • Metric

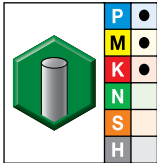
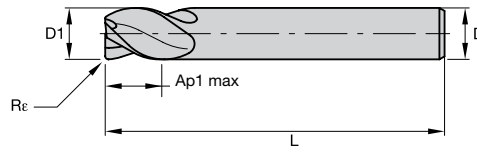
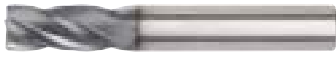

- first choice
- alternate choice

TiAlN

order #	catalog #	D1	D	length of cut Ap1 max	length L	Re	Z U
6337590	40040200T006R050	2,0	3	6,30	38	0,50	4
6337731	40040300T009R050	3,0	3	9,50	38	0,50	4
6337732	40040300T009R100	3,0	3	9,50	38	1,00	4
6337892	40140300T019R050	3,0	3	19,00	63	0,50	4
6338335	40240300T025R050	3,0	3	25,00	75	0,50	4
6337733	40040400T011R050	4,0	4	11,00	50	0,50	4
6337734	40040400T011R100	4,0	4	11,00	50	1,00	4
6337893	40140400T019R050	4,0	4	19,00	63	0,50	4
6337894	40140400T019R100	4,0	4	19,00	63	1,00	4
6338336	40240400T031R050	4,0	4	31,00	75	0,50	4
6338337	40240400T031R100	4,0	4	31,00	75	1,00	4
6337735	40040500T013R050	5,0	5	13,00	50	0,50	4
6337895	40140500T030R050	5,0	5	30,00	75	0,50	4
6337896	40140500T030R100	5,0	5	30,00	75	1,00	4
6337737	40040600T016R100	6,0	6	16,00	50	1,00	4
6337736	40040600T016R050	6,0	6	16,00	50	0,50	4
6337897	40140600T028R050	6,0	6	28,00	75	0,50	4
6337898	40140600T028R100	6,0	6	28,00	75	1,00	4
6338338	40240600T038R050	6,0	6	38,00	100	0,50	4
6338339	40240600T038R100	6,0	6	38,00	100	1,00	4
6337739	40040800T020R100	8,0	8	20,00	50	1,00	4
6337738	40040800T020R050	8,0	8	20,00	50	0,50	4
6337899	40140800T028R050	8,0	8	28,00	75	0,50	4
6337900	40140800T028R100	8,0	8	28,00	75	1,00	4
6338340	40240800T041R050	8,0	8	41,00	100	0,50	4
6338341	40240800T041R100	8,0	8	41,00	100	1,00	4
6337740	40041000T022R050	10,0	10	22,00	72	0,50	4
6337741	40041000T022R100	10,0	10	22,00	72	1,00	4
6337912	40141000T032R100	10,0	10	32,00	89	1,00	4
6337911	40141000T032R050	10,0	10	32,00	89	0,50	4
6338342	40241000T045R050	10,0	10	45,00	100	0,50	4
6338343	40241000T045R100	10,0	10	45,00	100	1,00	4
6337742	40041200T025R050	12,0	12	25,00	89	0,50	4
6337743	40041200T025R100	12,0	12	25,00	89	1,00	4
6337914	40141200T045R100	12,0	12	45,00	100	1,00	4
6337913	40141200T045R050	12,0	12	45,00	100	0,50	4
6338344	40241200T075R050	12,0	12	75,00	150	0,50	4
6338345	40241200T075R100	12,0	12	75,00	150	1,00	4
6337744	40041600T032R050	16,0	16	32,00	92	0,50	4
6337745	40041600T032R100	16,0	16	32,00	92	1,00	4
6337915	40141600T056R050	16,0	16	56,00	110	0,50	4
6338346	40241600T075R050	16,0	16	75,00	150	0,50	4
6338347	40241600T075R100	16,0	16	75,00	150	1,00	4
6338349	40242000T075R050	20,0	20	75,00	150	0,50	4

INDEXABLE MILLING

SOLID END MILLING

HOLEMAKING

TAPPING

TURNING

# General-Purpose Solid Carbide End Mills

## GP End Mills • Series D004 D014 • Square End • 4 Flute • Metric DIN 6527

INDEXABLE MILLING

SOLID END MILLING

HOLEMAKING

TAPPING

TURNING

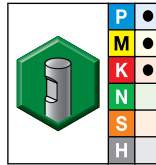
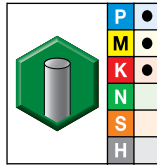
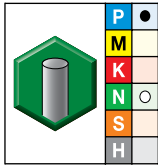
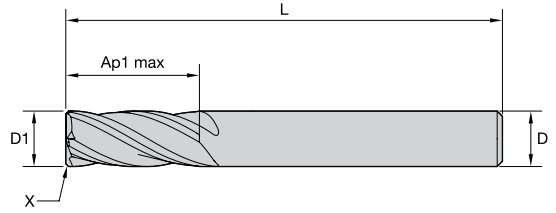
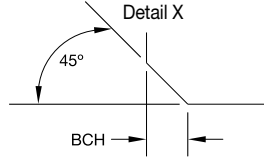

● first choice  
○ alternate choice

TiAlN		UNCOATED		TiAlN		D1	D	length of cut Ap1 max	length L	BCH	Z U
order #	catalog #	order #	catalog #	order #	catalog #						
5825894	D0040200T004	—	—	—	—	2,0	6	4,00	50	—	4
5825895	D0140200T007	—	—	—	—	2,0	6	7,00	57	—	4
5825896	D0140250T008	—	—	—	—	2,5	6	8,00	57	—	4
5825897	D0040300T005	—	—	—	—	3,0	6	5,00	50	—	4
5825898	D0140300T008	—	—	—	—	3,0	6	8,00	57	—	4
5825899	D0140350T010	—	—	—	—	3,5	6	10,00	57	—	4
5825900	D0040400T008	—	—	—	—	4,0	6	8,00	54	0,10	4
6085348	D0040400T008S	—	—	—	—	4,0	6	8,00	54	—	4
6085349	D0140400T011S	—	—	—	—	4,0	6	11,00	57	—	4
5825931	D0140400T011	—	—	—	—	4,0	6	11,00	57	0,10	4
6085350	D0140450T011S	—	—	—	—	4,5	6	11,00	57	—	4
5825932	D0140450T011	—	—	—	—	4,5	6	11,00	57	0,10	4
6085361	D0040500T009S	—	—	—	—	5,0	6	9,00	54	—	4
5825933	D0040500T009	—	—	—	—	5,0	6	9,00	54	0,10	4
6085362	D0140500T013S	—	—	—	—	5,0	6	13,00	57	—	4
5825934	D0140500T013	—	—	—	—	5,0	6	13,00	57	0,10	4
6085363	D0140550T013S	—	—	—	—	5,5	6	13,00	57	—	4
5825935	D0140550T013	—	—	—	—	5,5	6	13,00	57	0,10	4
6085364	D0040600T010S	—	—	—	—	6,0	6	10,00	54	—	4
5825936	D0040600T010	—	—	—	—	6,0	6	10,00	54	0,10	4
6085365	D0140600T013S	—	—	—	—	6,0	6	13,00	57	—	4
5825937	D0140600T013	—	—	—	—	6,0	6	13,00	57	0,10	4
6085366	D0140650T016S	—	—	—	—	6,5	8	16,00	63	—	4
5825938	D0140650T016	—	—	—	—	6,5	8	16,00	63	0,10	4
6085367	D0040700T011S	—	—	—	—	7,0	8	11,00	58	—	4
5825939	D0040700T011	—	—	—	—	7,0	8	11,00	58	0,10	4
6085368	D0140700T016S	—	—	—	—	7,0	8	16,00	63	—	4
5825940	D0140700T016	—	—	—	—	7,0	8	16,00	63	0,10	4
6085369	D0140750T019S	—	—	—	—	7,5	8	19,00	63	—	4
5825941	D0140750T019	—	—	—	—	7,5	8	19,00	63	0,10	4
6085370	D0040800T012S	—	—	—	—	8,0	8	12,00	58	—	4
5825942	D0040800T012	—	—	—	—	8,0	8	12,00	58	0,20	4
6085371	D0140800T019S	—	—	—	—	8,0	8	19,00	63	—	4
5825943	D0140800T019	—	—	—	—	8,0	8	19,00	63	0,20	4
6085372	D0040900T013S	—	—	—	—	9,0	10	13,00	66	—	4
5825944	D0040900T013	—	—	—	—	9,0	10	13,00	66	0,20	4
6085373	D0140900T019S	—	—	—	—	9,0	10	19,00	72	—	4
5825945	D0140900T019	—	—	—	—	9,0	10	19,00	72	0,20	4
6085374	D0041000T014S	—	—	—	—	10,0	10	14,00	66	—	4
5825946	D0041000T014	—	—	—	—	10,0	10	14,00	66	0,20	4
6085375	D0141000T022S	—	—	—	—	10,0	10	22,00	72	—	4
5825947	D0141000T022	—	—	—	—	10,0	10	22,00	72	0,20	4
6085376	D0041200T016S	6085406	D0041200W016S	6085396	D0041200W016S	12,0	12	16,00	73	—	4
5825948	D0041200T016	—	—	5825958	D0041200W016	12,0	12	16,00	73	0,30	4
6085377	D0141200T026S	—	—	6085397	D0141200W026S	12,0	12	26,00	83	—	4
5825949	D0141200T026	5825969	D0141200W026	5825959	D0141200W026	12,0	12	26,00	83	0,30	4
—	—	—	—	6085407	D0141200W026S	12,0	12	26,00	83	—	4
6085378	D0041400T018S	—	—	—	—	14,0	14	18,00	75	—	4
5825950	D0041400T018	5825970	D0041400W018	5825960	D0041400W018	14,0	14	18,00	75	0,30	4
6085379	D0141400T026S	—	—	6085399	D0141400W026S	14,0	14	26,00	83	—	4
5825951	D0141400T026	—	—	5825961	D0141400W026	14,0	14	26,00	83	0,30	4
—	—	—	—	6085409	D0141400W026S	14,0	14	26,00	83	—	4
6085380	D0041600T022S	6085410	D0041600W022S	6085400	D0041600W022S	16,0	16	22,00	82	—	4
5825952	D0041600T022	5825972	D0041600W022	5825962	D0041600W022	16,0	16	22,00	82	0,30	4
6085391	D0141600T032S	6085421	D0141600W032S	6085401	D0141600W032S	16,0	16	32,00	92	—	4
5825953	D0141600T032	5825973	D0141600W032	5825963	D0141600W032	16,0	16	32,00	92	0,30	4

## GP End Mills • Series D004 D014 • Square End • 4 Flute • Metric DIN 6527

(continued)

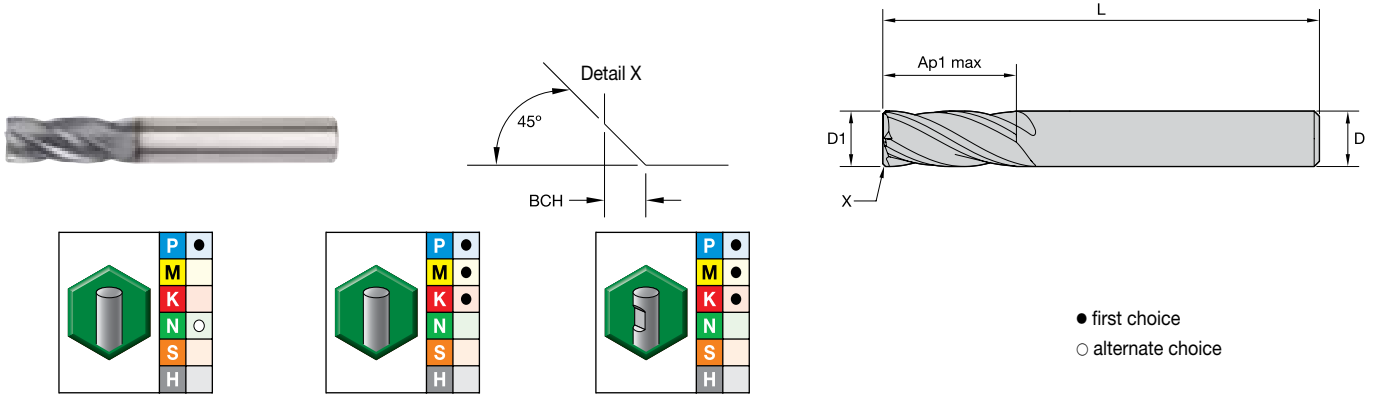

● first choice  
○ alternate choice

TiAlN		UNCOATED		TiAlN		D1	D	length of cut Ap1 max	length L	BCH	Z U
order #	catalog #	order #	catalog #	order #	catalog #						
6085392	D0041800T024S	6086478	D0041800W024S	6085402	D0041800W024S	18,0	18	24,00	84	—	4
5825954	D0041800T024	—	—	5825964	D0041800W024	18,0	18	24,00	84	0,30	4
6085393	D0141800T032S	—	—	6085403	D0141800W032S	18,0	18	32,00	92	—	4
5825955	D0141800T032	—	—	5825965	D0141800W032	18,0	18	32,00	92	0,30	4
6085394	D0042000T026S	—	—	6085404	D0042000W026S	20,0	20	26,00	92	—	4
5825956	D0042000T026	5825976	D0042000W026	5825966	D0042000W026	20,0	20	26,00	92	0,30	4
6085395	D0142000T038S	6086491	D0142000W038S	6085405	D0142000W038S	20,0	20	38,00	104	—	4
5825957	D0142000T038	5825977	D0142000W038	5825967	D0142000W038	20,0	20	38,00	104	0,30	4

# General-Purpose Solid Carbide End Mills

## GP End Mills • Series 2528 • Square End • 4 Flute • Metric DIN 6528

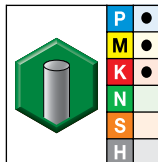
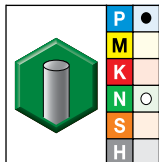
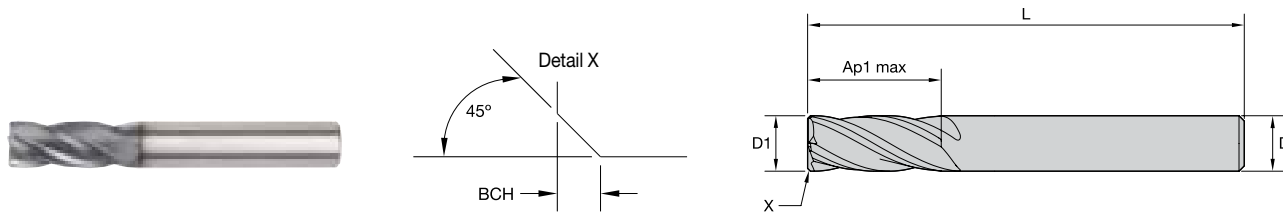

● first choice  
○ alternate choice

UNCOATED		TiAlN		D1	D	length of cut Ap1 max	length L	BCH	Z U
order #	catalog #	order #	catalog #						
—	—	6086492	25280400T011S	4,0	4	11,00	50	—	4
—	—	5825978	25280400T011	4,0	4	11,00	50	0,10	4
—	—	6086493	25280500T013S	5,0	5	13,00	50	—	4
—	—	5825979	25280500T013	5,0	5	13,00	50	0,10	4
6086509	25280600T013S	6086494	25280600T013S	6,0	6	13,00	57	—	4
—	—	5825980	25280600T013	6,0	6	13,00	57	0,10	4
—	—	6086495	25280800T019S	8,0	8	19,00	63	—	4
—	—	5825981	25280800T019	8,0	8	19,00	63	0,20	4
—	—	6086496	25281000T022S	10,0	10	22,00	72	—	4
—	—	5825982	25281000T022	10,0	10	22,00	72	0,20	4
—	—	6086497	25281200T026S	12,0	12	26,00	83	—	4
—	—	5825983	25281200T026	12,0	12	26,00	83	0,30	4
—	—	6086498	25281400T026S	14,0	14	26,00	83	—	4
—	—	5825984	25281400T026	14,0	14	26,00	83	0,30	4
—	—	6086499	25281600T032S	16,0	16	32,00	92	—	4
—	—	5825985	25281600T032	16,0	16	32,00	92	0,30	4
—	—	6086500	25281800T032S	18,0	18	32,00	92	—	4
—	—	5825986	25281800T032	18,0	18	32,00	92	0,30	4
—	—	6086501	25282000T038S	20,0	20	38,00	104	—	4
—	—	5825987	25282000T038	20,0	20	38,00	104	0,30	4

INDEXABLE MILLING

SOLID END MILLING

HOLEMAKING

TAPPING

TURNING

## GP End Mills • Series 4000 4010 • Ball Nose • 4 Flute • Metric

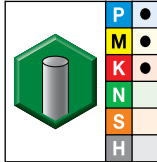
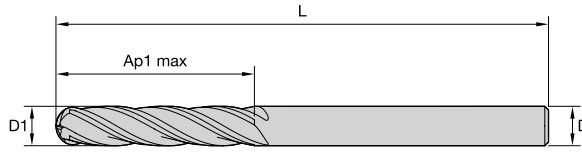

- first choice
- alternate choice

TIAIN

order #	catalog #	D1	D	length of cut Ap1 max	length L	Z U
5825555	40000200T006	2,0	3	6,30	38	4
6231685	40000300T009	3,0	3	9,50	38	4
6232637	40100300T019	3,0	3	19,00	63	4
5825556	40000300T020	3,0	3	20,00	75	4
5825557	40000400T014	4,0	4	14,00	50	4
5825558	40100400T025	4,0	4	25,00	75	4
5825559	40000500T016	5,0	5	16,00	50	4
5825560	40100500T030	5,0	5	30,00	75	4
5825573	40000600T016	6,0	6	16,00	50	4
5825574	40100600T019	6,0	6	19,00	63	4
5825575	40100600T030	6,0	6	30,00	75	4
5825576	40000800T019	8,0	8	19,00	63	4
6232638	40100800T028	8,0	8	28,00	76	4
5825577	40100800T040	8,0	8	40,00	100	4
5825578	40001000T022	10,0	10	22,00	72	4
6232639	40101000T032	10,0	10	32,00	89	4
5825579	40101000T040	10,0	10	40,00	100	4
5825580	40001200T025	12,0	12	25,00	75	4
5825581	40101200T045	12,0	12	45,00	150	4
6232640	40101200T046	12,0	12	46,00	100	4
6232671	40101200T075	12,0	12	75,00	150	4
5825583	40001400T032	14,0	14	32,00	83	4
5825584	40101400T050	14,0	14	50,00	100	4
5825585	40001600T032	16,0	16	32,00	89	4
5825586	40101600T065	16,0	16	65,00	150	4
5825588	40102000T056	20,0	20	56,00	125	4
6232672	40102000T075	20,0	20	75,00	150	4

INDEXABLE MILLING

SOLID END MILLING

HOLEMAKING

TAPPING

TURNING



## GP End Mills • Series D010 • Ball Nose • 4 Flute • Metric DIN 6527

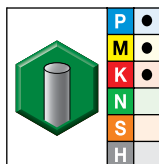
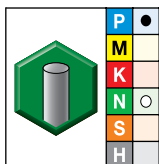
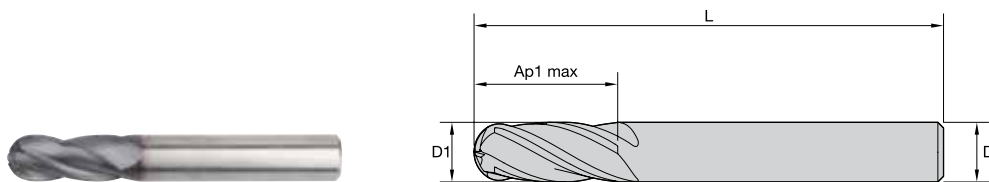

● first choice  
○ alternate choice

UNCOATED		TiAlN		D1	D	length of cut Ap1 max	length L	Z U
5825604	D0100300T008	5825527	D0100300T008	3,0	6	8,00	57	4
5825605	D0100400T011	5825528	D0100400T011	4,0	6	11,00	57	4
	—	5825529	D0100500T013	5,0	6	13,00	57	4
5825607	D0100600T013	5825530	D0100600T013	6,0	6	13,00	57	4
5825608	D0100800T019	5825531	D0100800T019	8,0	8	19,00	63	4
5825609	D0101000T022	5825532	D0101000T022	10,0	10	22,00	72	4
5825610	D0101200T026	5825533	D0101200T026	12,0	12	26,00	83	4
5825589	D0101200W026	5825540	D0101200W026	12,0	12	26,00	83	4
5825611	D0101400T026	5825534	D0101400T026	14,0	14	26,00	83	4
5825590	D0101400W026	5825541	D0101400W026	14,0	14	26,00	83	4
5825612	D0101600T032	5825536	D0101600T032	16,0	16	32,00	92	4
	—	5825542	D0101600W032	16,0	16	32,00	92	4
5825613	D0101800T032	5825538	D0101800T032	18,0	18	32,00	92	4
	—	5825543	D0101800W032	18,0	18	32,00	92	4
5825614	D0102000T038	5825539	D0102000T038	20,0	20	38,00	104	4
5825593	D0102000W038	5825544	D0102000W038	20,0	20	38,00	104	4

INDEXABLE MILLING

SOLID END MILLING

HOLEMAKING

TAPPING

TURNING

## GP End Mills • Series 2848 • Ball Nose • 4 Flute • Metric DIN 6528

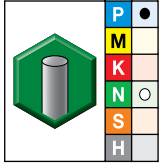
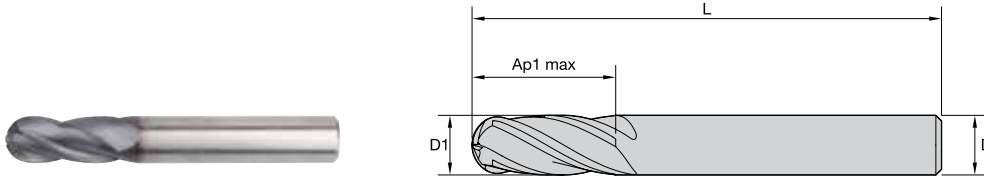

UNCOATED

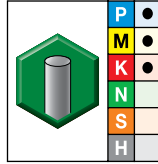

TiAlN

- first choice
- alternate choice

UNCOATED		TiAlN		D1	D	length of cut	length	Z	U
order #	catalog #	order #	catalog #			Ap1 max	L		
—	—	5825545	28480400T011	4,0	4	11,00	50	4	4
—	—	5825546	28480500T013	5,0	5	13,00	50	4	4
—	—	5825547	28480600T013	6,0	6	13,00	57	4	4
5825597	28480800T019	5825548	28480800T019	8,0	8	19,00	63	4	4
—	—	5825549	28481000T022	10,0	10	22,00	72	4	4
—	—	5825550	28481200T026	12,0	12	26,00	83	4	4
—	—	5825551	28481400T026	14,0	14	26,00	83	4	4
—	—	5825552	28481600T032	16,0	16	32,00	92	4	4
—	—	5825553	28481800T032	18,0	18	32,00	92	4	4
—	—	5825554	28482000T038	20,0	20	38,00	104	4	4

# General-Purpose Solid Carbide End Mills

INDEXABLE MILLING



SOLID END MILLING

HOLEMAKING

TAPPING



TURNING

## GP End Mills • Series I2S..L I2S..X • Application Data • Uncoated • Inch

																					
		Side Milling (A)		Uncoated				Recommended feed per tooth (IPT = inch/th) for side milling (A).													
		A		Cutting Speed – vc				D1 – Diameter													
				SFM				frac.													
								1/16 5/64 3/32 1/8 3/16 1/4 5/16 3/8 1/2 5/8 3/4 1													
		ap ae		min max				dec. .0625 .0781 .0938 .1250 .1875 .2500 .3125 .3750 .5000 .6250 .7500 1.0000													
Material Group	0	Ap1 max	0.1 x D	390	–	520	IPT	.0004	.0005	.0007	.0009	.0013	.0018	.0023	.0027	.0034	.0039	.0044	.0049		
	1	Ap1 max	0.1 x D	390	–	520	IPT	.0004	.0005	.0007	.0009	.0013	.0018	.0023	.0027	.0034	.0039	.0044	.0049		
	2	Ap1 max	0.1 x D	370	–	500	IPT	.0004	.0005	.0007	.0009	.0013	.0018	.0023	.0027	.0034	.0039	.0044	.0049		



NOTE: Lower value of cutting speed is used for high stock removal applications or for higher hardness (machinability) within group.  
Higher value of cutting speed is used for finishing applications or for lower hardness (machinability) within group.  
Above parameters are based on ideal conditions. For smaller taper machining centers, please adjust parameters accordingly on >1/2" diameter.

## GP End Mills • Series I2S..S I2S..R • Application Data • Uncoated • Inch

																						
		Side Milling (A) and Slotting (B)		Uncoated				Recommended feed per tooth (IPT = inch/th) for side milling (A). For slotting (B), reduce IPT by 20%.														
		A B		Cutting Speed – vc				D1 – Diameter														
				SFM				frac.														
								1/64 1/32 1/16 5/64 3/32 1/8 3/16 1/4 5/16 3/8 1/2 5/8 3/4 1														
		ap ae ap		min max				dec. .0156 .0313 .0625 .0781 .0938 .1250 .1875 .2500 .3125 .3750 .5000 .6250 .7500 1.0000														
Material Group	0	Ap1 max	0.1 x D	0.5 x D	390	–	520	IPT	.0001	.0002	.0004	.0005	.0007	.0009	.0013	.0018	.0023	.0027	.0034	.0039	.0044	.0049
	1	Ap1 max	0.1 x D	0.5 x D	390	–	520	IPT	.0001	.0002	.0004	.0005	.0007	.0009	.0013	.0018	.0023	.0027	.0034	.0039	.0044	.0049
	2	Ap1 max	0.1 x D	0.5 x D	370	–	500	IPT	.0001	.0002	.0004	.0005	.0007	.0009	.0013	.0018	.0023	.0027	.0034	.0039	.0044	.0049

NOTE: Lower value of cutting speed is used for high stock removal applications or for higher hardness (machinability) within group.  
Higher value of cutting speed is used for finishing applications or for lower hardness (machinability) within group.  
Above parameters are based on ideal conditions. For smaller taper machining centers, please adjust parameters accordingly on >1/2" diameter.

## GP End Mills • Series I2B..L I2B..X • Application Data • Uncoated • Inch

																					
		Side Milling (A)		Uncoated				Recommended feed per tooth (IPT = inch/th) for side milling (A).													
		A		Cutting Speed – vc				D1 – Diameter													
				SFM				frac.													
								3/32 1/8 3/16 1/4 5/16 3/8 1/2 5/8 3/4 1													
		ap ae		min max				dec. .0938 .1250 .1875 .2500 .3125 .3750 .5000 .6250 .7500 1.0000													
Material Group	0	Ap1 max	0.1 x D	390	–	520	IPT	.0007	.0009	.0013	.0018	.0023	.0027	.0034	.0039	.0044	.0049				
	1	1.25 x D	0.1 x D	390	–	520	IPT	.0007	.0009	.0013	.0018	.0023	.0027	.0034	.0039	.0044	.0049				
	2	1.25 x D	0.1 x D	370	–	500	IPT	.0007	.0009	.0013	.0018	.0023	.0027	.0034	.0039	.0044	.0049				

NOTE: Lower value of cutting speed is used for high stock removal applications or for higher hardness (machinability) within group.  
Higher value of cutting speed is used for finishing applications or for lower hardness (machinability) within group.  
Above parameters are based on ideal conditions. For smaller taper machining centers, please adjust parameters accordingly on >1/2" diameter.

## GP End Mills • Series I2B..S I2B..R • Application Data • Uncoated • Inch

Material Group	Side Milling (A) and Slotting (B)		Uncoated		Recommended feed per tooth (IPT = inch/th) for side milling (A). For slotting (B), reduce IPT by 20%.																	
	A		B		Cutting Speed – vc		D1 – Diameter															
	ap	ae	ap		min	max	frac.	1/64	1/32	1/16	5/64	3/32	1/8	3/16	1/4	5/16	3/8	1/2	5/8	3/4	1	
	ap	ae	ap		min	max	dec.	.0156	.0313	.0625	.0781	.0938	.1250	.1875	.2500	.3125	.3750	.5000	.6250	.7500	1.0000	
P	0	Ap1 max	0.1 x D	0.5 x D	390	–	520	IPT	.0001	.0002	.0004	.0005	.0007	.0009	.0013	.0018	.0023	.0027	.0034	.0039	.0044	.0049
	1	1.25 x D	0.1 x D	0.5 x D	390	–	520	IPT	.0001	.0002	.0004	.0005	.0007	.0009	.0013	.0018	.0023	.0027	.0034	.0039	.0044	.0049
	2	1.25 x D	0.1 x D	0.5 x D	370	–	500	IPT	.0001	.0002	.0004	.0005	.0007	.0009	.0013	.0018	.0023	.0027	.0034	.0039	.0044	.0049

NOTE: Lower value of cutting speed is used for high stock removal applications or for higher hardness (machinability) within group.  
Higher value of cutting speed is used for finishing applications or for lower hardness (machinability) within group.  
Above parameters are based on ideal conditions. For smaller taper machining centers, please adjust parameters accordingly on >1/2" diameter.

## GP End Mills • Series I2S..L I2S..X • Application Data • TiAlN • Inch

Material Group	Side Milling (A)		TiAlN		Recommended feed per tooth (IPT = inch/th) for side milling (A).														
	A		Cutting Speed – vc		D1 – Diameter														
	ap	ae	min	max	frac.	1/16	5/64	3/32	1/8	3/16	1/4	5/16	3/8	1/2	5/8	3/4	1		
	ap	ae	min	max	dec.	.0625	.0781	.0938	.1250	.1875	.2500	.3125	.3750	.5000	.6250	.7500	1.0000		
P	0	Ap1 max	0.1 x D	490	–	660	IPT	.0004	.0005	.0007	.0009	.0013	.0018	.0023	.0027	.0034	.0039	.0044	.0049
	1	Ap1 max	0.1 x D	490	–	660	IPT	.0004	.0005	.0007	.0009	.0013	.0018	.0023	.0027	.0034	.0039	.0044	.0049
	2	Ap1 max	0.1 x D	460	–	620	IPT	.0004	.0005	.0007	.0009	.0013	.0018	.0023	.0027	.0034	.0039	.0044	.0049
	3	Ap1 max	0.1 x D	390	–	520	IPT	.0004	.0004	.0005	.0007	.0011	.0015	.0020	.0023	.0029	.0034	.0039	.0045
	4	Ap1 max	0.1 x D	300	–	490	IPT	.0003	.0004	.0005	.0007	.0010	.0014	.0017	.0020	.0026	.0030	.0034	.0039
M	1	Ap1 max	0.1 x D	300	–	380	IPT	.0004	.0004	.0005	.0007	.0011	.0015	.0020	.0023	.0029	.0034	.0039	.0045
	2	Ap1 max	0.1 x D	200	–	260	IPT	.0003	.0004	.0004	.0006	.0009	.0012	.0016	.0018	.0023	.0027	.0031	.0036
K	1	Ap1 max	0.1 x D	390	–	490	IPT	.0004	.0005	.0007	.0009	.0013	.0018	.0023	.0027	.0034	.0039	.0044	.0049
	2	Ap1 max	0.1 x D	360	–	460	IPT	.0004	.0004	.0005	.0007	.0011	.0015	.0020	.0023	.0029	.0034	.0039	.0045

NOTE: Lower value of cutting speed is used for high stock removal applications or for higher hardness (machinability) within group.  
Higher value of cutting speed is used for finishing applications or for lower hardness (machinability) within group.  
Above parameters are based on ideal conditions. For smaller taper machining centers, please adjust parameters accordingly on >1/2" diameter.

# General-Purpose Solid Carbide End Mills

INDEXABLE MILLING

SOLID END MILLING

HOLEMAKING

TAPPING

TURNING

## GP End Mills • Series I2S..S I2S..R I2R... • Application Data • TiAlN • Inch

Material Group	Side Milling (A) and Slotting (B)		TiAlN		Recommended feed per tooth (IPT = inch/th) for side milling (A). For slotting (B), reduce IPT by 20%.																		
	A		B		Cutting Speed – vc SFM		frac. dec.	D1 – Diameter															
	ap	ae	ap		min	max		1/64	1/32	1/16	5/64	3/32	1/8	3/16	1/4	5/16	3/8	1/2	5/8	3/4	1		
								.0156	.0313	.0625	.0781	.0938	.1250	.1875	.2500	.3125	.3750	.5000	.6250	.7500	1.0000		
P	0	Ap1 max	0.1 x D	0.5 x D	490	–	660	IPT	.0001	.0002	.0004	.0005	.0007	.0009	.0013	.0018	.0023	.0027	.0034	.0039	.0044	.0049	
	1	Ap1 max	0.1 x D	0.5 x D	490	–	660	IPT	.0001	.0002	.0004	.0005	.0007	.0009	.0013	.0018	.0023	.0027	.0034	.0039	.0044	.0049	
	2	Ap1 max	0.1 x D	0.5 x D	460	–	620	IPT	.0001	.0002	.0004	.0005	.0007	.0009	.0013	.0018	.0023	.0027	.0034	.0039	.0044	.0049	
	3	Ap1 max	0.1 x D	0.5 x D	390	–	520	IPT	.0001	.0002	.0004	.0004	.0005	.0007	.0011	.0015	.0020	.0023	.0029	.0034	.0039	.0045	
M	4	Ap1 max	0.1 x D	0.5 x D	300	–	490	IPT	.0001	.0002	.0003	.0004	.0005	.0007	.0010	.0014	.0017	.0020	.0026	.0030	.0034	.0039	
	1	Ap1 max	0.1 x D	0.5 x D	300	–	380	IPT	.0001	.0002	.0004	.0004	.0005	.0007	.0011	.0015	.0020	.0023	.0029	.0034	.0039	.0045	
	2	Ap1 max	0.1 x D	0.5 x D	200	–	260	IPT	.0001	.0001	.0003	.0004	.0004	.0006	.0009	.0012	.0016	.0018	.0023	.0027	.0031	.0036	
	1	Ap1 max	0.1 x D	0.5 x D	390	–	490	IPT	.0001	.0002	.0004	.0005	.0007	.0009	.0013	.0018	.0023	.0027	.0034	.0039	.0044	.0049	
K	2	Ap1 max	0.1 x D	0.5 x D	360	–	460	IPT	.0001	.0002	.0004	.0004	.0005	.0007	.0011	.0015	.0020	.0023	.0029	.0034	.0039	.0045	

NOTE: Lower value of cutting speed is used for high stock removal applications or for higher hardness (machinability) within group.  
Higher value of cutting speed is used for finishing applications or for lower hardness (machinability) within group.  
Above parameters are based on ideal conditions. For smaller taper machining centers, please adjust parameters accordingly on >1/2" diameter.

## GP End Mills • Series I2B..L I2B..X • Application Data • TiAlN • Inch

Material Group	Side Milling (A)		TiAlN		Recommended feed per tooth (IPT = inch/th) for side milling (A).												
	A		Cutting Speed – vc SFM		frac. dec.	D1 – Diameter											
	ap	ae	min	max		3/32	1/8	3/16	1/4	5/16	3/8	1/2	5/8	3/4	1		
						.0938	.1250	.1875	.2500	.3125	.3750	.5000	.6250	.7500	1.0000		
P	0	Ap1 max	0.1 x D	490	–	660	IPT	.0007	.0009	.0013	.0018	.0023	.0027	.0034	.0039	.0044	.0049
	1	Ap1 max	0.1 x D	490	–	660	IPT	.0007	.0009	.0013	.0018	.0023	.0027	.0034	.0039	.0044	.0049
	2	Ap1 max	0.1 x D	460	–	620	IPT	.0007	.0009	.0013	.0018	.0023	.0027	.0034	.0039	.0044	.0049
	3	Ap1 max	0.1 x D	390	–	520	IPT	.0005	.0007	.0011	.0015	.0020	.0023	.0029	.0034	.0039	.0045
M	4	Ap1 max	0.1 x D	300	–	490	IPT	.0005	.0007	.0010	.0014	.0017	.0020	.0026	.0030	.0034	.0039
	1	Ap1 max	0.1 x D	300	–	380	IPT	.0005	.0007	.0011	.0015	.0020	.0023	.0029	.0034	.0039	.0045
	2	Ap1 max	0.1 x D	200	–	260	IPT	.0004	.0006	.0009	.0012	.0016	.0018	.0023	.0027	.0031	.0036
	1	Ap1 max	0.1 x D	390	–	490	IPT	.0007	.0009	.0013	.0018	.0023	.0027	.0034	.0039	.0044	.0049
K	2	Ap1 max	0.1 x D	360	–	460	IPT	.0005	.0007	.0011	.0015	.0020	.0023	.0029	.0034	.0039	.0045

NOTE: Lower value of cutting speed is used for high stock removal applications or for higher hardness (machinability) within group.  
Higher value of cutting speed is used for finishing applications or for lower hardness (machinability) within group.  
Above parameters are based on ideal conditions. For smaller taper machining centers, please adjust parameters accordingly on >1/2" diameter.

## GP End Mills • Series I2B..S I2B..R • Application Data • TiAlN • Inch

Material Group	Side Milling (A) and Slotting (B)		TiAlN		Recommended feed per tooth (IPT = inch/th) for side milling (A). For slotting (B), reduce IPT by 20%.																	
	A		B		Cutting Speed – vc		D1 – Diameter															
	ap	ae	ap		min	max	frac.	1/64	1/32	1/16	5/64	3/32	1/8	3/16	1/4	5/16	3/8	1/2	5/8	3/4	1	
	ap	ae	ap		min	max	dec.	.0156	.0313	.0625	.0781	.0938	.1250	.1875	.2500	.3125	.3750	.5000	.6250	.7500	1.0000	
P	0	Ap1 max	0.1 x D	0.5 x D	490	–	660	IPT	.0001	.0002	.0004	.0005	.0007	.0009	.0013	.0018	.0023	.0027	.0034	.0039	.0044	.0049
	1	Ap1 max	0.1 x D	0.5 x D	490	–	660	IPT	.0001	.0002	.0004	.0005	.0007	.0009	.0013	.0018	.0023	.0027	.0034	.0039	.0044	.0049
	2	Ap1 max	0.1 x D	0.5 x D	460	–	620	IPT	.0001	.0002	.0004	.0005	.0007	.0009	.0013	.0018	.0023	.0027	.0034	.0039	.0044	.0049
	3	Ap1 max	0.1 x D	0.5 x D	390	–	520	IPT	.0001	.0002	.0004	.0004	.0005	.0007	.0011	.0015	.0020	.0023	.0029	.0034	.0039	.0045
4	Ap1 max	0.1 x D	0.5 x D	300	–	490	IPT	.0001	.0002	.0003	.0004	.0005	.0007	.0010	.0014	.0017	.0020	.0026	.0030	.0034	.0039	
M	1	Ap1 max	0.1 x D	0.5 x D	300	–	380	IPT	.0001	.0002	.0004	.0004	.0005	.0007	.0011	.0015	.0020	.0023	.0029	.0034	.0039	.0045
	2	Ap1 max	0.1 x D	0.5 x D	200	–	260	IPT	.0001	.0001	.0003	.0004	.0004	.0006	.0009	.0012	.0016	.0018	.0023	.0027	.0031	.0036
K	1	Ap1 max	0.1 x D	0.5 x D	390	–	490	IPT	.0001	.0002	.0004	.0005	.0007	.0009	.0013	.0018	.0023	.0027	.0034	.0039	.0044	.0049
	2	Ap1 max	0.1 x D	0.5 x D	360	–	460	IPT	.0001	.0002	.0004	.0004	.0005	.0007	.0011	.0015	.0020	.0023	.0029	.0034	.0039	.0045

NOTE: Lower value of cutting speed is used for high stock removal applications or for higher hardness (machinability) within group.  
Higher value of cutting speed is used for finishing applications or for lower hardness (machinability) within group.  
Above parameters are based on ideal conditions. For smaller taper machining centers, please adjust parameters accordingly on >1/2" diameter.

## GP End Mills • Series I3S..L I3S..X • Application Data • Uncoated • Inch

Material Group	Side Milling (A)		Uncoated		Recommended feed per tooth (IPT = inch/th) for side milling (A).											
	A		Cutting Speed – vc		D1 – Diameter											
	ap	ae	min	max	frac.	1/8	3/16	1/4	5/16	3/8	1/2	5/8	3/4	1		
	ap	ae	min	max	dec.	.1250	.1875	.2500	.3125	.3750	.5000	.6250	.7500	1.0000		
P	0	2.0 x D	0.1 x D	490	–	660	IPT	.0009	.0013	.0018	.0023	.0027	.0034	.0039	.0044	.0049
	1	2.0 x D	0.1 x D	490	–	660	IPT	.0009	.0013	.0018	.0023	.0027	.0034	.0039	.0044	.0049
	2	2.0 x D	0.1 x D	460	–	620	IPT	.0009	.0013	.0018	.0023	.0027	.0034	.0039	.0044	.0049
N	1	Ap1 max	0.1 x D	650	–	2600	IPT	.0013	.0019	.0025	.0031	.0038	.0050	.0063	.0075	.0100
	2	Ap1 max	0.1 x D	650	–	2000	IPT	.0010	.0015	.0020	.0025	.0030	.0040	.0050	.0060	.0080
	5	Ap1 max	0.1 x D	650	–	2000	IPT	.0011	.0017	.0023	.0028	.0034	.0045	.0056	.0068	.0090

NOTE: Lower value of cutting speed is used for high stock removal applications or for higher hardness (machinability) within group.  
Higher value of cutting speed is used for finishing applications or for lower hardness (machinability) within group.  
Above parameters are based on ideal conditions. For smaller taper machining centers, please adjust parameters accordingly on diameters >1/2".

## GP End Mills • Series I3S..S I3S..R • Application Data • Uncoated • Inch

Material Group	Side Milling (A) and Slotting (B)		Uncoated		Recommended feed per tooth (IPT = inch/th) for side milling (A). For slotting (B), reduce IPT by 20%.												
	A		B		Cutting Speed – vc		D1 – Diameter										
	ap	ae	ap	ae	min	max	frac.	1/8	3/16	1/4	5/16	3/8	1/2	5/8	3/4	1	
	ap	ae	ap	ae	min	max	dec.	.1250	.1875	.2500	.3125	.3750	.5000	.6250	.7500	1.0000	
P	0	2.0 x D	0.1 x D	0.5 x D	490	–	660	IPT	.0009	.0013	.0018	.0023	.0027	.0034	.0039	.0044	.0049
	1	2.0 x D	0.1 x D	0.5 x D	490	–	660	IPT	.0009	.0013	.0018	.0023	.0027	.0034	.0039	.0044	.0049
	2	2.0 x D	0.1 x D	0.5 x D	460	–	620	IPT	.0009	.0013	.0018	.0023	.0027	.0034	.0039	.0044	.0049
N	1	Ap1 max	0.1 x D	0.5 x D	650	–	2600	IPT	.0013	.0019	.0025	.0031	.0038	.0050	.0063	.0075	.0100
	2	Ap1 max	0.1 x D	0.5 x D	650	–	2000	IPT	.0010	.0015	.0020	.0025	.0030	.0040	.0050	.0060	.0080
	5	Ap1 max	0.1 x D	0.5 x D	650	–	2000	IPT	.0011	.0017	.0023	.0028	.0034	.0045	.0056	.0068	.0090

NOTE: Lower value of cutting speed is used for high stock removal applications or for higher hardness (machinability) within group.  
Higher value of cutting speed is used for finishing applications or for lower hardness (machinability) within group.  
Above parameters are based on ideal conditions. For smaller taper machining centers, please adjust parameters accordingly on diameters >1/2".

## GP End Mills • Series I3S..L I3S..X • Application Data • TiAlN • Inch

Material Group	Side Milling (A)		TiAlN		Recommended feed per tooth (IPT = inch/th) for side milling (A).											
	A		Cutting Speed – vc		D1 – Diameter											
	ap	ae	min	max	frac.	1/8	3/16	1/4	5/16	3/8	1/2	5/8	3/4	1		
	ap	ae	min	max	dec.	.1250	.1875	.2500	.3125	.3750	.5000	.6250	.7500	1.0000		
P	0	2.0 x D	0.1 x D	490	–	660	IPT	.0009	.0013	.0018	.0023	.0027	.0034	.0039	.0044	.0049
	1	2.0 x D	0.1 x D	490	–	660	IPT	.0009	.0013	.0018	.0023	.0027	.0034	.0039	.0044	.0049
	2	2.0 x D	0.1 x D	460	–	620	IPT	.0009	.0013	.0018	.0023	.0027	.0034	.0039	.0044	.0049
	3	2.0 x D	0.1 x D	390	–	520	IPT	.0007	.0011	.0015	.0020	.0023	.0029	.0034	.0039	.0045
	4	2.0 x D	0.1 x D	300	–	490	IPT	.0007	.0010	.0014	.0017	.0020	.0026	.0030	.0034	.0039
M	1	2.0 x D	0.1 x D	300	–	380	IPT	.0007	.0011	.0015	.0020	.0023	.0029	.0034	.0039	.0045
	2	2.0 x D	0.1 x D	200	–	260	IPT	.0006	.0009	.0012	.0016	.0018	.0023	.0027	.0031	.0036
K	1	2.0 x D	0.1 x D	390	–	490	IPT	.0009	.0013	.0018	.0023	.0027	.0034	.0039	.0044	.0049
	2	2.0 x D	0.1 x D	360	–	460	IPT	.0007	.0011	.0015	.0020	.0023	.0029	.0034	.0039	.0045

NOTE: Lower value of cutting speed is used for high stock removal applications or for higher hardness (machinability) within group.  
Higher value of cutting speed is used for finishing applications or for lower hardness (machinability) within group.  
Above parameters are based on ideal conditions. For smaller taper machining centers, please adjust parameters accordingly on diameters >1/2".

## GP End Mills • Series I3S..S I3S..R • Application Data • TiAlN • Inch

Material Group	Side Milling (A) and Slotting (B)		TiAlN		Recommended feed per tooth (IPT = inch/th) for side milling (A). For slotting (B), reduce IPT by 20%.												
	A		B		Cutting Speed – vc			D1 – Diameter									
	ap	ae	ap	ae	min	max	frac.	1/8	3/16	1/4	5/16	3/8	1/2	5/8	3/4	1	
	ap	ae	ap	ae	min	max	dec.	.1250	.1875	.2500	.3125	.3750	.5000	.6250	.7500	1.0000	
P	0	2.0 x D	0.1 x D	0.5 x D	490	–	660	IPT	.0009	.0013	.0018	.0023	.0027	.0034	.0039	.0044	.0049
	1	2.0 x D	0.1 x D	0.5 x D	490	–	660	IPT	.0009	.0013	.0018	.0023	.0027	.0034	.0039	.0044	.0049
	2	2.0 x D	0.1 x D	0.5 x D	460	–	620	IPT	.0009	.0013	.0018	.0023	.0027	.0034	.0039	.0044	.0049
	3	2.0 x D	0.1 x D	0.5 x D	390	–	520	IPT	.0007	.0011	.0015	.0020	.0023	.0029	.0034	.0039	.0045
M	1	2.0 x D	0.1 x D	0.5 x D	300	–	490	IPT	.0007	.0010	.0014	.0017	.0020	.0026	.0030	.0034	.0039
	2	2.0 x D	0.1 x D	0.5 x D	200	–	260	IPT	.0006	.0009	.0012	.0016	.0018	.0023	.0027	.0031	.0036
K	1	2.0 x D	0.1 x D	0.5 x D	390	–	490	IPT	.0009	.0013	.0018	.0023	.0027	.0034	.0039	.0044	.0049
	2	2.0 x D	0.1 x D	0.5 x D	360	–	460	IPT	.0007	.0011	.0015	.0020	.0023	.0029	.0034	.0039	.0045

NOTE: Lower value of cutting speed is used for high stock removal applications or for higher hardness (machinability) within group.  
Higher value of cutting speed is used for finishing applications or for lower hardness (machinability) within group.  
Above parameters are based on ideal conditions. For smaller taper machining centers, please adjust parameters accordingly on diameters >1/2".

## GP End Mills • Series I4S..L I4S..X • Application Data • Uncoated • Inch

Material Group	Side Milling (A)		Uncoated		Recommended feed per tooth (IPT = inch/th) for side milling (A).												
	A		Cutting Speed – vc		D1 – Diameter												
	ap	ae	min	max	frac.	3/32	1/8	3/16	1/4	5/16	3/8	1/2	5/8	3/4	1		
	ap	ae	min	max	dec.	.0938	.1250	.1875	.2500	.3125	.3750	.5000	.6250	.7500	1.0000		
P	0	Ap1 max	0.1 x D	390	–	520	IPT	.0007	.0009	.0013	.0018	.0023	.0027	.0034	.0039	.0044	.0049
	1	Ap1 max	0.1 x D	390	–	520	IPT	.0007	.0009	.0013	.0018	.0023	.0027	.0034	.0039	.0044	.0049
	2	Ap1 max	0.1 x D	370	–	500	IPT	.0007	.0009	.0013	.0018	.0023	.0027	.0034	.0039	.0044	.0049

NOTE: Lower value of cutting speed is used for high stock removal applications or for higher hardness (machinability) within group.  
Higher value of cutting speed is used for finishing applications or for lower hardness (machinability) within group.  
Above parameters are based on ideal conditions. For smaller taper machining centers, please adjust parameters accordingly on >1/2" diameter.

## GP End Mills • Series I4S..S I4S..R • Application Data • Uncoated • Inch

Material Group	Side Milling (A) and Slotting (B)		Uncoated		Recommended feed per tooth (IPT = inch/th) for side milling (A). For slotting (B), reduce IPT by 20%.															
	A		B		Cutting Speed – vc			D1 – Diameter												
	ap	ae	ap	ae	min	max	frac.	1/16	5/64	3/32	1/8	3/16	1/4	5/16	3/8	1/2	5/8	3/4	1	
	ap	ae	ap	ae	min	max	dec.	.0625	.0781	.0938	.1250	.1875	.2500	.3125	.3750	.5000	.6250	.7500	1.0000	
P	0	Ap1 max	0.1 x D	0.5 x D	390	–	520	IPT	.0004	.0005	.0007	.0009	.0013	.0018	.0023	.0027	.0034	.0039	.0044	.0049
	1	1.25 x D	0.1 x D	0.5 x D	390	–	520	IPT	.0004	.0005	.0007	.0009	.0013	.0018	.0023	.0027	.0034	.0039	.0044	.0049
	2	1.25 x D	0.1 x D	0.5 x D	370	–	500	IPT	.0004	.0005	.0007	.0009	.0013	.0018	.0023	.0027	.0034	.0039	.0044	.0049

NOTE: Lower value of cutting speed is used for high stock removal applications or for higher hardness (machinability) within group.  
Higher value of cutting speed is used for finishing applications or for lower hardness (machinability) within group.  
Above parameters are based on ideal conditions. For smaller taper machining centers, please adjust parameters accordingly on >1/2" diameter.



# General-Purpose Solid Carbide End Mills

INDEXABLE MILLING

SOLID END MILLING

HOLEMAKING

TAPPING

TURNING

## GP End Mills • Series I4R..S I4S..S I4R..R I4S..R • Application Data • TiAlN • Inch

Material Group	Side Milling (A) and Slotting (B)		TiAlN		Recommended feed per tooth (IPT = inch/th) for side milling (A). For slotting (B), reduce IPT by 20%.																	
	A		B		Cutting Speed – vc		D1 – Diameter															
	ap	ae	ap		min	max	frac.	1/64	1/32	1/16	5/64	3/32	1/8	3/16	1/4	5/16	3/8	1/2	5/8	3/4	1	
	ap	ae	ap		min	max	dec.	.0156	.0313	.0625	.0781	.0938	.1250	.1875	.2500	.3125	.3750	.5000	.6250	.7500	1.0000	
P	0	Ap1 max	0.1 x D	0.5 x D	490	–	660	IPT	.0001	.0002	.0004	.0005	.0007	.0009	.0013	.0018	.0023	.0027	.0034	.0039	.0044	.0049
	1	Ap1 max	0.1 x D	0.5 x D	490	–	660	IPT	.0001	.0002	.0004	.0005	.0007	.0009	.0013	.0018	.0023	.0027	.0034	.0039	.0044	.0049
	2	Ap1 max	0.1 x D	0.5 x D	460	–	620	IPT	.0001	.0002	.0004	.0005	.0007	.0009	.0013	.0018	.0023	.0027	.0034	.0039	.0044	.0049
	3	Ap1 max	0.1 x D	0.5 x D	390	–	520	IPT	.0001	.0002	.0004	.0004	.0005	.0007	.0011	.0015	.0020	.0023	.0029	.0034	.0039	.0045
M	1	Ap1 max	0.1 x D	0.5 x D	300	–	490	IPT	.0001	.0002	.0003	.0004	.0005	.0007	.0010	.0014	.0017	.0020	.0026	.0030	.0034	.0039
	2	Ap1 max	0.1 x D	0.5 x D	200	–	260	IPT	.0001	.0001	.0003	.0004	.0004	.0006	.0009	.0012	.0016	.0018	.0023	.0027	.0031	.0036
K	1	Ap1 max	0.1 x D	0.5 x D	390	–	490	IPT	.0001	.0002	.0004	.0005	.0007	.0009	.0013	.0018	.0023	.0027	.0034	.0039	.0044	.0049
	2	Ap1 max	0.1 x D	0.5 x D	360	–	460	IPT	.0001	.0002	.0004	.0004	.0005	.0007	.0011	.0015	.0020	.0023	.0029	.0034	.0039	.0045

NOTE: Lower value of cutting speed is used for high stock removal applications or for higher hardness (machinability) within group.  
Higher value of cutting speed is used for finishing applications or for lower hardness (machinability) within group.  
Above parameters are based on ideal conditions. For smaller taper machining centers, please adjust parameters accordingly on >1/2" diameter.

## GP End Mills • Series I4S..L I4S..X • Application Data • TiAlN • Inch

Material Group	Side Milling (A)		TiAlN		Recommended feed per tooth (IPT = inch/th) for side milling (A).												
	A		Cutting Speed – vc		D1 – Diameter												
	ap	ae	min	max	frac.	3/32	1/8	3/16	1/4	5/16	3/8	1/2	5/8	3/4	1		
	ap	ae	min	max	dec.	.0938	.1250	.1875	.2500	.3125	.3750	.5000	.6250	.7500	1.0000		
P	0	Ap1 max	0.1 x D	490	–	660	IPT	.0007	.0009	.0013	.0018	.0023	.0027	.0034	.0039	.0044	.0049
	1	Ap1 max	0.1 x D	490	–	660	IPT	.0007	.0009	.0013	.0018	.0023	.0027	.0034	.0039	.0044	.0049
	2	Ap1 max	0.1 x D	460	–	620	IPT	.0007	.0009	.0013	.0018	.0023	.0027	.0034	.0039	.0044	.0049
	3	Ap1 max	0.1 x D	390	–	520	IPT	.0005	.0007	.0011	.0015	.0020	.0023	.0029	.0034	.0039	.0045
M	1	Ap1 max	0.1 x D	300	–	490	IPT	.0005	.0007	.0010	.0014	.0017	.0020	.0026	.0030	.0034	.0039
	2	Ap1 max	0.1 x D	200	–	260	IPT	.0004	.0006	.0009	.0012	.0016	.0018	.0023	.0027	.0031	.0036
K	1	Ap1 max	0.1 x D	390	–	490	IPT	.0007	.0009	.0013	.0018	.0023	.0027	.0034	.0039	.0044	.0049
	2	Ap1 max	0.1 x D	360	–	460	IPT	.0005	.0007	.0011	.0015	.0020	.0023	.0029	.0034	.0039	.0045

NOTE: Lower value of cutting speed is used for high stock removal applications or for higher hardness (machinability) within group.  
Higher value of cutting speed is used for finishing applications or for lower hardness (machinability) within group.  
Above parameters are based on ideal conditions. For smaller taper machining centers, please adjust parameters accordingly on >1/2" diameter.

## GP End Mills • Series I4B..L I4B..X • Application Data • TiAlN • Inch

Material Group	Side Milling (A)		TiAlN		Recommended feed per tooth (IPT = inch/th) for side milling (A).												
	A		Cutting Speed – vc		D1 – Diameter												
	ap	ae	min	max	frac.	3/32	1/8	3/16	1/4	5/16	3/8	1/2	5/8	3/4	1		
	ap	ae	min	max	dec.	.0938	.1250	.1875	.2500	.3125	.3750	.5000	.6250	.7500	1.0000		
P	0	Ap1 max	0.1 x D	490	–	660	IPT	.0007	.0009	.0013	.0018	.0023	.0027	.0034	.0039	.0044	.0049
	1	Ap1 max	0.1 x D	490	–	660	IPT	.0007	.0009	.0013	.0018	.0023	.0027	.0034	.0039	.0044	.0049
	2	Ap1 max	0.1 x D	460	–	620	IPT	.0007	.0009	.0013	.0018	.0023	.0027	.0034	.0039	.0044	.0049
	3	Ap1 max	0.1 x D	390	–	520	IPT	.0005	.0007	.0011	.0015	.0020	.0023	.0029	.0034	.0039	.0045
M	1	Ap1 max	0.1 x D	300	–	490	IPT	.0005	.0007	.0010	.0014	.0017	.0020	.0026	.0030	.0034	.0039
	2	Ap1 max	0.1 x D	300	–	380	IPT	.0005	.0007	.0011	.0015	.0020	.0023	.0029	.0034	.0039	.0045
K	1	Ap1 max	0.1 x D	200	–	260	IPT	.0004	.0006	.0009	.0012	.0016	.0018	.0023	.0027	.0031	.0036
	2	Ap1 max	0.1 x D	390	–	490	IPT	.0007	.0009	.0013	.0018	.0023	.0027	.0034	.0039	.0044	.0049
K	1	Ap1 max	0.1 x D	390	–	490	IPT	.0007	.0009	.0013	.0018	.0023	.0027	.0034	.0039	.0044	.0049
	2	Ap1 max	0.1 x D	360	–	460	IPT	.0005	.0007	.0011	.0015	.0020	.0023	.0029	.0034	.0039	.0045

NOTE: Lower value of cutting speed is used for high stock removal applications or for higher hardness (machinability) within group.  
 Higher value of cutting speed is used for finishing applications or for lower hardness (machinability) within group.  
 Above parameters are based on ideal conditions. For smaller taper machining centers, please adjust parameters accordingly on >1/2" diameter.

## GP End Mills • Series I4B..S I4B..R • Application Data • TiAlN • Inch

Material Group	Side Milling (A) and Slotting (B)		TiAlN		Recommended feed per tooth (IPT = inch/th) for side milling (A). For slotting (B), reduce IPT by 20%.																	
	A		B	Cutting Speed – vc		D1 – Diameter																
	ap	ae	ap	min	max	frac.	1/64	1/32	1/16	5/64	3/32	1/8	3/16	1/4	5/16	3/8	1/2	5/8	3/4	1		
	ap	ae	ap	min	max	dec.	.0156	.0313	.0625	.0781	.0938	.1250	.1875	.2500	.3125	.3750	.5000	.6250	.7500	1.0000		
P	0	Ap1 max	0.1 x D	0.5 x D	490	–	660	IPT	.0001	.0002	.0004	.0005	.0007	.0009	.0013	.0018	.0023	.0027	.0034	.0039	.0044	.0049
	1	Ap1 max	0.1 x D	0.5 x D	490	–	660	IPT	.0001	.0002	.0004	.0005	.0007	.0009	.0013	.0018	.0023	.0027	.0034	.0039	.0044	.0049
	2	Ap1 max	0.1 x D	0.5 x D	460	–	620	IPT	.0001	.0002	.0004	.0005	.0007	.0009	.0013	.0018	.0023	.0027	.0034	.0039	.0044	.0049
	3	Ap1 max	0.1 x D	0.5 x D	390	–	520	IPT	.0001	.0002	.0004	.0004	.0005	.0007	.0011	.0015	.0020	.0023	.0029	.0034	.0039	.0045
M	1	Ap1 max	0.1 x D	0.5 x D	300	–	490	IPT	.0001	.0002	.0003	.0004	.0005	.0007	.0010	.0014	.0017	.0020	.0026	.0030	.0034	.0039
	2	Ap1 max	0.1 x D	0.5 x D	300	–	380	IPT	.0001	.0002	.0004	.0004	.0005	.0007	.0011	.0015	.0020	.0023	.0029	.0034	.0039	.0045
K	1	Ap1 max	0.1 x D	0.5 x D	200	–	260	IPT	.0001	.0001	.0003	.0004	.0004	.0006	.0009	.0012	.0016	.0018	.0023	.0027	.0031	.0036
	2	Ap1 max	0.1 x D	0.5 x D	390	–	490	IPT	.0001	.0002	.0004	.0005	.0007	.0009	.0013	.0018	.0023	.0027	.0034	.0039	.0044	.0049
K	1	Ap1 max	0.1 x D	0.5 x D	390	–	490	IPT	.0001	.0002	.0004	.0005	.0007	.0009	.0013	.0018	.0023	.0027	.0034	.0039	.0044	.0049
	2	Ap1 max	0.1 x D	0.5 x D	360	–	460	IPT	.0001	.0002	.0004	.0004	.0005	.0007	.0011	.0015	.0020	.0023	.0029	.0034	.0039	.0045

NOTE: Lower value of cutting speed is used for high stock removal applications or for higher hardness (machinability) within group.  
 Higher value of cutting speed is used for finishing applications or for lower hardness (machinability) within group.  
 Above parameters are based on ideal conditions. For smaller taper machining centers, please adjust parameters accordingly on >1/2" diameter.

## GP End Mills • Series D002 4002 • Application Data • Uncoated • Metric

Material Group	Side Milling (A) and Slotting (B)		Uncoated		Recommended feed per tooth (fz = mm/th) for side milling (A). For slotting (B), reduce fz by 20%.															
	A		B		Cutting Speed – vc m/min			D1 – Diameter												
	ap	ae	ap		min	max	mm	2,0	3,0	4,0	6,0	8,0	10,0	12,0	16,0	20,0				
								fz												
P	0	0,1 x D	0,1 x D	0,5 x D	120	–	160	fz	0,014	0,021	0,028	0,044	0,060	0,072	0,083	0,101	0,114			
	1	0,1 x D	0,1 x D	0,5 x D	120	–	160	fz	0,014	0,021	0,028	0,044	0,060	0,072	0,083	0,101	0,114			
	2	0,1 x D	0,1 x D	0,5 x D	112	–	152	fz	0,014	0,021	0,028	0,044	0,060	0,072	0,083	0,101	0,114			
N	1	Ap1 max	0,1 x D	0,5 x D	400	–	1600	fz	0,020	0,030	0,040	0,060	0,080	0,100	0,120	0,160	0,200			
	2	Ap1 max	0,1 x D	0,5 x D	400	–	1200	fz	0,016	0,024	0,032	0,048	0,064	0,080	0,096	0,128	0,160			
	4	Ap1 max	0,1 x D	0,5 x D	320	–	600	fz	0,014	0,021	0,028	0,042	0,056	0,070	0,084	0,112	0,140			

NOTE: Lower value of cutting speed is used for high stock removal applications or for higher hardness (machinability) within group.  
Higher value of cutting speed is used for finishing applications or for lower hardness (machinability) within group.  
Above parameters are based on ideal conditions. For smaller taper machining centers, please adjust parameters accordingly on >12mm diameters.

## GP End Mills • Series 4011 4021 • Application Data • Uncoated • Metric

Material Group	Side Milling (A)		Uncoated		Recommended feed per tooth (fz = mm/th) for side milling (A).											
	A		Cutting Speed – vc m/min			D1 – Diameter										
	ap	ae	min	max	mm	3,0	4,0	6,0	8,0	10,0	12,0	16,0	20,0			
						fz										
P	0	Ap1 max	0,1 x D	120	–	160	fz	0,021	0,028	0,044	0,060	0,072	0,083	0,101	0,114	
	1	Ap1 max	0,1 x D	120	–	160	fz	0,021	0,028	0,044	0,060	0,072	0,083	0,101	0,114	
	2	Ap1 max	0,1 x D	112	–	152	fz	0,021	0,028	0,044	0,060	0,072	0,083	0,101	0,114	
N	1	Ap1 max	0,1 x D	400	–	1600	fz	0,030	0,040	0,060	0,080	0,100	0,120	0,160	0,200	
	2	Ap1 max	0,1 x D	400	–	1200	fz	0,024	0,032	0,048	0,064	0,080	0,096	0,128	0,160	
	4	Ap1 max	0,1 x D	320	–	600	fz	0,021	0,028	0,042	0,056	0,070	0,084	0,112	0,140	



NOTE: Lower value of cutting speed is used for high stock removal applications or for higher hardness (machinability) within group.  
Higher value of cutting speed is used for finishing applications or for lower hardness (machinability) within group.  
Above parameters are based on ideal conditions.  
For smaller taper machining centers, please adjust parameters accordingly on >12mm diameters.

## GP End Mills • Series D012 2819 4012 4022 • Application Data • Uncoated • Metric

Material Group	Side Milling (A)		Uncoated		Recommended feed per tooth (fz = mm/th) for side milling (A).											
	A		Cutting Speed – vc m/min			D1 – Diameter										
	ap	ae	min	max	mm	3,0	4,0	6,0	8,0	10,0	12,0	16,0	20,0			
						fz										
P	0	Ap1 max	0,1 x D	120	–	160	fz	0,021	0,028	0,044	0,060	0,072	0,083	0,101	0,114	
	1	Ap1 max	0,1 x D	120	–	160	fz	0,021	0,028	0,044	0,060	0,072	0,083	0,101	0,114	
	2	Ap1 max	0,1 x D	112	–	152	fz	0,021	0,028	0,044	0,060	0,072	0,083	0,101	0,114	
N	1	Ap1 max	0,1 x D	400	–	1600	fz	0,030	0,040	0,060	0,080	0,100	0,120	0,160	0,200	
	2	Ap1 max	0,1 x D	400	–	1200	fz	0,024	0,032	0,048	0,064	0,080	0,096	0,128	0,160	
	4	Ap1 max	0,1 x D	320	–	600	fz	0,021	0,028	0,042	0,056	0,070	0,084	0,112	0,140	

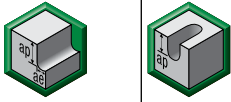

NOTE: Lower value of cutting speed is used for high stock removal applications or for higher hardness (machinability) within group.  
Higher value of cutting speed is used for finishing applications or for lower hardness (machinability) within group.  
Above parameters are based on ideal conditions. For smaller taper machining centers, please adjust parameters accordingly on >12mm diameters.

## GP End Mills • Series D001 4001 • Application Data • Uncoated • Metric

Material Group																			
	Side Milling (A) and Slotting (B)			Uncoated			Recommended feed per tooth (fz = mm/th) for side milling (A). For slotting (B), reduce fz by 20%.												
	A		B	Cutting Speed – vc m/min			D1 – Diameter												
	ap	ae	ap	min	max	mm	1,0	2,0	3,0	4,0	6,0	8,0	10,0	12,0	16,0	20,0			
P	0	Ap1 max	0,1 x D	0,5 x D	120	–	160	fz	0,007	0,014	0,021	0,028	0,044	0,060	0,072	0,083	0,101	0,114	
	1	Ap1 max	0,1 x D	0,5 x D	120	–	160	fz	0,007	0,014	0,021	0,028	0,044	0,060	0,072	0,083	0,101	0,114	
	2	Ap1 max	0,1 x D	0,5 x D	112	–	152	fz	0,007	0,014	0,021	0,028	0,044	0,060	0,072	0,083	0,101	0,114	
N	1	Ap1 max	0,1 x D	0,5 x D	400	–	1600	fz	0,010	0,020	0,030	0,040	0,060	0,080	0,100	0,120	0,160	0,200	
	2	Ap1 max	0,1 x D	0,5 x D	400	–	1200	fz	0,008	0,016	0,024	0,032	0,048	0,064	0,080	0,096	0,128	0,160	
	4	Ap1 max	0,1 x D	0,5 x D	320	–	600	fz	0,007	0,014	0,021	0,028	0,042	0,056	0,070	0,084	0,112	0,140	

NOTE: Lower value of cutting speed is used for high stock removal applications or for higher hardness (machinability) within group.  
Higher value of cutting speed is used for finishing applications or for lower hardness (machinability) within group.  
Above parameters are based on ideal conditions.  
For smaller taper machining centers, please adjust parameters accordingly on >12mm diameters.

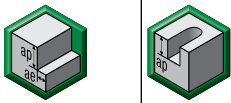
## GP End Mills • Series D002 4002 • Application Data • TiAlN • Metric

Material Group																					
	Side Milling (A) and Slotting (B)			TiAlN			Recommended feed per tooth (fz = mm/th) for side milling (A). For slotting (B), reduce fz by 20%.														
	A		B	Cutting Speed – vc m/min			D1 – Diameter														
	ap	ae	ap	min	max	mm	1,0	2,0	3,0	4,0	5,0	6,0	8,0	10,0	12,0	14,0	16,0	18,0	20,0		
P	0	Ap1 max	0,1 x D	0,5 x D	150	–	200	fz	0,007	0,014	0,021	0,028	0,036	0,044	0,060	0,072	0,083	0,092	0,101	0,108	0,114
	1	Ap1 max	0,1 x D	0,5 x D	150	–	200	fz	0,007	0,014	0,021	0,028	0,036	0,044	0,060	0,072	0,083	0,092	0,101	0,108	0,114
	2	Ap1 max	0,1 x D	0,5 x D	140	–	190	fz	0,007	0,014	0,021	0,028	0,036	0,044	0,060	0,072	0,083	0,092	0,101	0,108	0,114
	3	Ap1 max	0,1 x D	0,5 x D	120	–	160	fz	0,006	0,011	0,017	0,023	0,030	0,036	0,050	0,061	0,070	0,079	0,087	0,095	0,101
	4	Ap1 max	0,1 x D	0,5 x D	90	–	150	fz	0,005	0,010	0,016	0,021	0,027	0,033	0,045	0,054	0,062	0,070	0,077	0,083	0,088
M	1	Ap1 max	0,1 x D	0,5 x D	90	–	115	fz	0,006	0,011	0,017	0,023	0,030	0,036	0,050	0,061	0,070	0,079	0,087	0,095	0,101
	2	Ap1 max	0,1 x D	0,5 x D	60	–	80	fz	0,005	0,009	0,014	0,019	0,024	0,029	0,040	0,048	0,056	0,063	0,070	0,076	0,081
K	1	Ap1 max	0,1 x D	0,5 x D	120	–	150	fz	0,007	0,014	0,021	0,028	0,036	0,044	0,060	0,072	0,083	0,092	0,101	0,108	0,114
	2	Ap1 max	0,1 x D	0,5 x D	110	–	140	fz	0,006	0,011	0,017	0,023	0,030	0,036	0,050	0,061	0,070	0,079	0,087	0,095	0,101

NOTE: Lower value of cutting speed is used for high stock removal applications or for higher hardness (machinability) within group.  
Higher value of cutting speed is used for finishing applications or for lower hardness (machinability) within group.  
Above parameters are based on ideal conditions. For smaller taper machining centers, please adjust parameters accordingly on >12mm diameters.

## GP End Mills • Series 4011 4021 • Application Data • TiAlN • Metric

Material Group	Side Milling (A)		TiAlN		Recommended feed per tooth (fz = mm/th) for side milling (A).																
	A		Cutting Speed – vc m/min			mm	D1 – Diameter														
	ap	ae	min	max	2,0		3,0	4,0	5,0	6,0	8,0	10,0	12,0	14,0	16,0	18,0	20,0				
	ap1 max	0,1 x D	–	–	fz	0,014	0,021	0,028	0,036	0,044	0,060	0,072	0,083	0,092	0,101	0,108	0,114				
P	0	Ap1 max	0,1 x D	150	–	200	fz	0,014	0,021	0,028	0,036	0,044	0,060	0,072	0,083	0,092	0,101	0,108	0,114		
	1	Ap1 max	0,1 x D	150	–	200	fz	0,014	0,021	0,028	0,036	0,044	0,060	0,072	0,083	0,092	0,101	0,108	0,114		
	2	Ap1 max	0,1 x D	140	–	190	fz	0,014	0,021	0,028	0,036	0,044	0,060	0,072	0,083	0,092	0,101	0,108	0,114		
	3	Ap1 max	0,1 x D	120	–	160	fz	0,011	0,017	0,023	0,030	0,036	0,050	0,061	0,070	0,079	0,087	0,095	0,101		
M	4	Ap1 max	0,1 x D	90	–	150	fz	0,010	0,016	0,021	0,027	0,033	0,045	0,054	0,062	0,070	0,077	0,083	0,088		
	1	Ap1 max	0,1 x D	90	–	115	fz	0,011	0,017	0,023	0,030	0,036	0,050	0,061	0,070	0,079	0,087	0,095	0,101		
K	2	Ap1 max	0,1 x D	60	–	80	fz	0,009	0,014	0,019	0,024	0,029	0,040	0,048	0,056	0,063	0,070	0,076	0,081		
	1	Ap1 max	0,1 x D	120	–	150	fz	0,014	0,021	0,028	0,036	0,044	0,060	0,072	0,083	0,092	0,101	0,108	0,114		
K	2	Ap1 max	0,1 x D	110	–	140	fz	0,011	0,017	0,023	0,030	0,036	0,050	0,061	0,070	0,079	0,087	0,095	0,101		

NOTE: Lower value of cutting speed is used for high stock removal applications or for higher hardness (machinability) within group.

Higher value of cutting speed is used for finishing applications or for lower hardness (machinability) within group.

Above parameters are based on ideal conditions.

For smaller taper machining centers, please adjust parameters accordingly on >12mm diameters.

## GP End Mills • Series D012 4012 • Application Data • TiAlN • Metric

Material Group	Side Milling (A)		TiAlN		Recommended feed per tooth (fz = mm/th) for side milling (A).																
	A		Cutting Speed – vc m/min			mm	D1 – Diameter														
	ap	ae	min	max	2,0		3,0	4,0	5,0	6,0	8,0	10,0	12,0	14,0	16,0	18,0	20,0				
	ap1 max	0,1 x D	–	–	fz	0,014	0,021	0,028	0,036	0,044	0,060	0,072	0,083	0,092	0,101	0,108	0,114				
P	0	Ap1 max	0,1 x D	150	–	200	fz	0,014	0,021	0,028	0,036	0,044	0,060	0,072	0,083	0,092	0,101	0,108	0,114		
	1	Ap1 max	0,1 x D	150	–	200	fz	0,014	0,021	0,028	0,036	0,044	0,060	0,072	0,083	0,092	0,101	0,108	0,114		
	2	Ap1 max	0,1 x D	140	–	190	fz	0,014	0,021	0,028	0,036	0,044	0,060	0,072	0,083	0,092	0,101	0,108	0,114		
	3	Ap1 max	0,1 x D	120	–	160	fz	0,011	0,017	0,023	0,030	0,036	0,050	0,061	0,070	0,079	0,087	0,095	0,101		
M	4	Ap1 max	0,1 x D	90	–	150	fz	0,010	0,016	0,021	0,027	0,033	0,045	0,054	0,062	0,070	0,077	0,083	0,088		
	1	Ap1 max	0,1 x D	90	–	115	fz	0,011	0,017	0,023	0,030	0,036	0,050	0,061	0,070	0,079	0,087	0,095	0,101		
K	2	Ap1 max	0,1 x D	60	–	80	fz	0,009	0,014	0,019	0,024	0,029	0,040	0,048	0,056	0,063	0,070	0,076	0,081		
	1	Ap1 max	0,1 x D	120	–	150	fz	0,014	0,021	0,028	0,036	0,044	0,060	0,072	0,083	0,092	0,101	0,108	0,114		
K	2	Ap1 max	0,1 x D	110	–	140	fz	0,011	0,017	0,023	0,030	0,036	0,050	0,061	0,070	0,079	0,087	0,095	0,101		

NOTE: Lower value of cutting speed is used for high stock removal applications or for higher hardness (machinability) within group.

Higher value of cutting speed is used for finishing applications or for lower hardness (machinability) within group.

Above parameters are based on ideal conditions. For smaller taper machining centers, please adjust parameters accordingly on >12mm diameters.

## GP End Mills • Series D001 D011 2838 4001 • Application Data • TiAlN • Metric

Material Group	Side Milling (A) and Slotting (B)		TiAlN		Recommended feed per tooth (fz = mm/th) for side milling (A). For slotting (B), reduce fz by 20%.																	
	A		B	Cutting Speed – vc m/min		mm	D1 – Diameter															
	ap	ae	ap	min	max		1,0	2,0	3,0	4,0	5,0	6,0	8,0	10,0	12,0	14,0	16,0	18,0	20,0			
	0	1 x D	0,5 x D	150	–	200	fz	0,007	0,014	0,021	0,028	0,036	0,044	0,060	0,072	0,083	0,092	0,101	0,108	0,114		
P	1	Ap1 max	0,1 x D	0,5 x D	150	–	200	fz	0,007	0,014	0,021	0,028	0,036	0,044	0,060	0,072	0,083	0,092	0,101	0,108	0,114	
	2	Ap1 max	0,1 x D	0,5 x D	140	–	190	fz	0,007	0,014	0,021	0,028	0,036	0,044	0,060	0,072	0,083	0,092	0,101	0,108	0,114	
	3	Ap1 max	0,1 x D	0,5 x D	120	–	160	fz	0,006	0,011	0,017	0,023	0,030	0,036	0,050	0,061	0,070	0,079	0,087	0,095	0,101	
	4	Ap1 max	0,1 x D	0,5 x D	90	–	150	fz	0,005	0,010	0,016	0,021	0,027	0,033	0,045	0,054	0,062	0,070	0,077	0,083	0,088	
M	1	Ap1 max	0,1 x D	0,5 x D	90	–	115	fz	0,006	0,011	0,017	0,023	0,030	0,036	0,050	0,061	0,070	0,079	0,087	0,095	0,101	
	2	Ap1 max	0,1 x D	0,5 x D	60	–	80	fz	0,005	0,009	0,014	0,019	0,024	0,029	0,040	0,048	0,056	0,063	0,070	0,076	0,081	
K	1	Ap1 max	0,1 x D	0,5 x D	120	–	150	fz	0,007	0,014	0,021	0,028	0,036	0,044	0,060	0,072	0,083	0,092	0,101	0,108	0,114	
	2	Ap1 max	0,1 x D	0,5 x D	110	–	140	fz	0,006	0,011	0,017	0,023	0,030	0,036	0,050	0,061	0,070	0,079	0,087	0,095	0,101	

NOTE: Lower value of cutting speed is used for high stock removal applications or for higher hardness (machinability) within group.  
Higher value of cutting speed is used for finishing applications or for lower hardness (machinability) within group.  
Above parameters are based on ideal conditions.  
For smaller taper machining centers, please adjust parameters accordingly on >12mm diameters.

## GP End Mills • Series 4013..S 4013 • Application Data • Uncoated • Metric

Material Group	Side Milling (A)		Uncoated		Recommended feed per tooth (fz = mm/th) for side milling (A).										
	A		Cutting Speed – vc m/min		mm	D1 – Diameter									
	ap	ae	min	max		3,0	4,0	6,0	8,0	10,0	12,0	16,0	20,0		
	0	1 x D	120	–	160	fz	0,021	0,028	0,044	0,060	0,072	0,083	0,101	0,114	
P	1	Ap1 max	0,1 x D	120	–	160	fz	0,021	0,028	0,044	0,060	0,072	0,083	0,101	0,114
	2	Ap1 max	0,1 x D	112	–	152	fz	0,021	0,028	0,044	0,060	0,072	0,083	0,101	0,114
	1	Ap1 max	0,1 x D	400	–	1600	fz	0,030	0,040	0,060	0,080	0,100	0,120	0,160	0,200
N	2	Ap1 max	0,1 x D	400	–	1200	fz	0,024	0,032	0,048	0,064	0,080	0,096	0,128	0,160
	4	Ap1 max	0,1 x D	320	–	600	fz	0,021	0,028	0,042	0,056	0,070	0,084	0,112	0,140



NOTE: Lower value of cutting speed is used for high stock removal applications or for higher hardness (machinability) within group.  
Higher value of cutting speed is used for finishing applications or for lower hardness (machinability) within group.  
Above parameters are based on ideal conditions. For smaller taper machining centers, please adjust parameters accordingly on diameters >12mm.

# General-Purpose Solid Carbide End Mills

## GP End Mills • Series D003..S D013..S D003 D013 4003..S 4003 • Application Data • Uncoated • Metric

INDEXABLE MILLING

SOLID END MILLING



																			
		Side Milling (A)	Uncoated			Recommended feed per tooth (fz = mm/th) for side milling (A).													
Material Group	A	Cutting Speed – vc m/min			mm	D1 – Diameter													
		ap	ae	min		max	3,0	4,0	6,0	8,0	10,0	12,0	16,0	20,0					
P	0	Ap1 max	0,1 x D	120	–	160	fz	0,021	0,028	0,044	0,060	0,072	0,083	0,101	0,114				
	1	Ap1 max	0,1 x D	120	–	160	fz	0,021	0,028	0,044	0,060	0,072	0,083	0,101	0,114				
	2	Ap1 max	0,1 x D	112	–	152	fz	0,021	0,028	0,044	0,060	0,072	0,083	0,101	0,114				
N	1	Ap1 max	0,1 x D	400	–	1600	fz	0,030	0,040	0,060	0,080	0,100	0,120	0,160	0,200				
	2	Ap1 max	0,1 x D	400	–	1200	fz	0,024	0,032	0,048	0,064	0,080	0,096	0,128	0,160				
	4	Ap1 max	0,1 x D	320	–	600	fz	0,021	0,028	0,042	0,056	0,070	0,084	0,112	0,140				

NOTE: Lower value of cutting speed is used for high stock removal applications or for higher hardness (machinability) within group.  
Higher value of cutting speed is used for finishing applications or for lower hardness (machinability) within group.  
Above parameters are based on ideal conditions. For smaller taper machining centers, please adjust parameters accordingly on diameters >12mm.

HOLEMAKING

## GP End Mills • Series 4013..S 4013 • Application Data • TiAlN • Metric

TAPPING

																				
		Side Milling (A)	TiAlN			Recommended feed per tooth (fz = mm/th) for side milling (A).														
Material Group	A	Cutting Speed – vc m/min			mm	D1 – Diameter														
		ap	ae	min		max	1,0	2,0	3,0	4,0	5,0	6,0	8,0	10,0	12,0	14,0	16,0	18,0	20,0	
P	0	Ap1 max	0,1 x D	150	–	200	fz	0,007	0,014	0,021	0,028	0,036	0,044	0,060	0,072	0,083	0,092	0,101	0,108	0,114
	1	Ap1 max	0,1 x D	150	–	200	fz	0,007	0,014	0,021	0,028	0,036	0,044	0,060	0,072	0,083	0,092	0,101	0,108	0,114
	2	Ap1 max	0,1 x D	140	–	190	fz	0,007	0,014	0,021	0,028	0,036	0,044	0,060	0,072	0,083	0,092	0,101	0,108	0,114
	3	Ap1 max	0,1 x D	120	–	160	fz	0,006	0,011	0,017	0,023	0,030	0,036	0,050	0,061	0,070	0,079	0,087	0,095	0,101
	4	Ap1 max	0,1 x D	90	–	150	fz	0,005	0,010	0,016	0,021	0,027	0,033	0,045	0,054	0,062	0,070	0,077	0,083	0,088
M	1	Ap1 max	0,1 x D	90	–	115	fz	0,006	0,011	0,017	0,023	0,030	0,036	0,050	0,061	0,070	0,079	0,087	0,095	0,101
	2	Ap1 max	0,1 x D	60	–	80	fz	0,005	0,009	0,014	0,019	0,024	0,029	0,040	0,048	0,056	0,063	0,070	0,076	0,081
K	1	Ap1 max	0,1 x D	120	–	150	fz	0,007	0,014	0,021	0,028	0,036	0,044	0,060	0,072	0,083	0,092	0,101	0,108	0,114
	2	Ap1 max	0,1 x D	110	–	140	fz	0,006	0,011	0,017	0,023	0,030	0,036	0,050	0,061	0,070	0,079	0,087	0,095	0,101

NOTE: Lower value of cutting speed is used for high stock removal applications or for higher hardness (machinability) within group.  
Higher value of cutting speed is used for finishing applications or for lower hardness (machinability) within group.  
Above parameters are based on ideal conditions. For smaller taper machining centers, please adjust parameters accordingly on diameters >12mm.

TURNING



GP End Mills • Series D003..S D013..S D003 D013 4003..S 4003 • Application Data • TiAlN • Metric

Material Group	Side Milling (A) and Slotting (B)		TiAlN		Recommended feed per tooth (fz = mm/th) for side milling (A). For slotting (B), reduce fz by 20%.															
	A		B	Cutting Speed – vc m/min			D1 – Diameter													
	ap	ae	ap	min	max	mm	1,0	2,0	3,0	4,0	5,0	6,0	8,0	10,0	12,0	14,0	16,0	18,0	20,0	
	P	0	Ap1 max 0,1 x D	0,5 x D	150	–	200	fz	0,007	0,014	0,021	0,028	0,036	0,044	0,060	0,072	0,083	0,092	0,101	0,108
	1	Ap1 max 0,1 x D	0,5 x D	150	–	200	fz	0,007	0,014	0,021	0,028	0,036	0,044	0,060	0,072	0,083	0,092	0,101	0,108	0,114
	2	Ap1 max 0,1 x D	0,5 x D	140	–	190	fz	0,007	0,014	0,021	0,028	0,036	0,044	0,060	0,072	0,083	0,092	0,101	0,108	0,114
	3	Ap1 max 0,1 x D	0,5 x D	120	–	160	fz	0,006	0,011	0,017	0,023	0,030	0,036	0,050	0,061	0,070	0,079	0,087	0,095	0,101
	4	Ap1 max 0,1 x D	0,5 x D	90	–	150	fz	0,005	0,010	0,016	0,021	0,027	0,033	0,045	0,054	0,062	0,070	0,077	0,083	0,088
M	1	Ap1 max 0,1 x D	0,5 x D	90	–	115	fz	0,006	0,011	0,017	0,023	0,030	0,036	0,050	0,061	0,070	0,079	0,087	0,095	0,101
	2	Ap1 max 0,1 x D	0,5 x D	60	–	80	fz	0,005	0,009	0,014	0,019	0,024	0,029	0,040	0,048	0,056	0,063	0,070	0,076	0,081
K	1	Ap1 max 0,1 x D	0,5 x D	120	–	150	fz	0,007	0,014	0,021	0,028	0,036	0,044	0,060	0,072	0,083	0,092	0,101	0,108	0,114
	2	Ap1 max 0,1 x D	0,5 x D	110	–	140	fz	0,006	0,011	0,017	0,023	0,030	0,036	0,050	0,061	0,070	0,079	0,087	0,095	0,101

NOTE: Lower value of cutting speed is used for high stock removal applications or for higher hardness (machinability) within group.  
Higher value of cutting speed is used for finishing applications or for lower hardness (machinability) within group.  
Above parameters are based on ideal conditions. For smaller taper machining centers, please adjust parameters accordingly on diameters >12mm.

GP End Mills • Series 4004 4014 4024 • Application Data • Uncoated • Metric

Material Group	Side Milling (A) and Slotting (B)		Uncoated		Recommended feed per tooth (fz = mm/th) for side milling (A). For slotting (B), reduce fz by 20%.															
	A		B	Cutting Speed – vc m/min			D1 – Diameter													
	ap	ae	ap	min	max	mm	1,0	2,0	3,0	4,0	6,0	8,0	10,0	12,0	16,0	20,0				
	P	0	Ap1 max 0,1 x D	0,5 x D	120	–	160	fz	0,007	0,014	0,021	0,028	0,044	0,060	0,072	0,083	0,101	0,114		
	1	Ap1 max 0,1 x D	0,5 x D	120	–	160	fz	0,007	0,014	0,021	0,028	0,044	0,060	0,072	0,083	0,101	0,114			
	2	Ap1 max 0,1 x D	0,5 x D	112	–	152	fz	0,007	0,014	0,021	0,028	0,044	0,060	0,072	0,083	0,101	0,114			
N	1	Ap1 max 0,1 x D	0,5 x D	400	–	1600	fz	0,010	0,020	0,030	0,040	0,060	0,080	0,100	0,120	0,160	0,200			
	2	Ap1 max 0,1 x D	0,5 x D	400	–	1200	fz	0,008	0,016	0,024	0,032	0,048	0,064	0,080	0,096	0,128	0,160			
	4	Ap1 max 0,1 x D	0,5 x D	320	–	600	fz	0,007	0,014	0,021	0,028	0,042	0,056	0,070	0,084	0,112	0,140			

NOTE: Lower value of cutting speed is used for high stock removal applications or for higher hardness (machinability) within group.  
Higher value of cutting speed is used for finishing applications or for lower hardness (machinability) within group.  
Above parameters are based on ideal conditions. For smaller taper machining centers, please adjust parameters accordingly on >12mm diameters.

GP End Mills • Series D014 2528 4014 4024 • Application Data • Uncoated • Metric

Material Group	Side Milling (A)		Uncoated		Recommended feed per tooth (fz = mm/th) for side milling (A).										
	A		Cutting Speed – vc m/min			D1 – Diameter									
	ap	ae	min	max	mm	3,0	4,0	6,0	8,0	10,0	12,0	16,0	20,0		
	P	0	Ap1 max 0,1 x D	120	–	160	fz	0,021	0,028	0,044	0,060	0,072	0,083	0,101	0,114
	1	Ap1 max 0,1 x D	120	–	160	fz	0,021	0,028	0,044	0,060	0,072	0,083	0,101	0,114	
	2	Ap1 max 0,1 x D	112	–	152	fz	0,021	0,028	0,044	0,060	0,072	0,083	0,101	0,114	
N	1	Ap1 max 0,1 x D	400	–	1600	fz	0,030	0,040	0,060	0,080	0,100	0,120	0,160	0,200	
	2	Ap1 max 0,1 x D	400	–	1200	fz	0,024	0,032	0,048	0,064	0,080	0,096	0,128	0,160	
	4	Ap1 max 0,1 x D	320	–	600	fz	0,021	0,028	0,042	0,056	0,070	0,084	0,112	0,140	

NOTE: Lower value of cutting speed is used for high stock removal applications or for higher hardness (machinability) within group.  
Higher value of cutting speed is used for finishing applications or for lower hardness (machinability) within group.  
Above parameters are based on ideal conditions. For smaller taper machining centers, please adjust parameters accordingly on >12mm diameters.



# General-Purpose Solid Carbide End Mills

INDEXABLE MILLING

SOLID END MILLING

## GP End Mills • Series D010 2848 4010 • Application Data • Uncoated • Metric

Material Group	Side Milling (A) and Slotting (B)		Uncoated			Recommended feed per tooth (fz = mm/th) for side milling (A). For slotting (B), reduce fz by 20%.												
	A		B	Cutting Speed – vc m/min			D1 – Diameter											
	ap	ae	ap	min	max	mm	1,0	2,0	3,0	4,0	6,0	8,0	10,0	12,0	16,0	20,0		
	ap1 max	0,1 x D	0,5 x D			fz												
P	0	Ap1 max	0,1 x D	0,5 x D	120	–	160	fz	0,007	0,014	0,021	0,028	0,044	0,060	0,072	0,083	0,101	0,114
	1	Ap1 max	0,1 x D	0,5 x D	120	–	160	fz	0,007	0,014	0,021	0,028	0,044	0,060	0,072	0,083	0,101	0,114
N	2	Ap1 max	0,1 x D	0,5 x D	112	–	152	fz	0,007	0,014	0,021	0,028	0,044	0,060	0,072	0,083	0,101	0,114
	1	Ap1 max	0,1 x D	0,5 x D	400	–	1600	fz	0,010	0,020	0,030	0,040	0,060	0,080	0,100	0,120	0,160	0,200
N	2	Ap1 max	0,1 x D	0,5 x D	400	–	1200	fz	0,008	0,016	0,024	0,032	0,048	0,064	0,080	0,096	0,128	0,160
	4	Ap1 max	0,1 x D	0,5 x D	320	–	600	fz	0,007	0,014	0,021	0,028	0,042	0,056	0,070	0,084	0,112	0,140

NOTE: Lower value of cutting speed is used for high stock removal applications or for higher hardness (machinability) within group.  
Higher value of cutting speed is used for finishing applications or for lower hardness (machinability) within group.  
Above parameters are based on ideal conditions. For smaller taper machining centers, please adjust parameters accordingly on >12mm diameters.

HOLE/MAKING



## GP End Mills • Series 4004 4014 4024 • Application Data • TiAlN • Metric

Material Group	Side Milling (A) and Slotting (B)		TiAlN			Recommended feed per tooth (fz = mm/th) for side milling (A). For slotting (B), reduce fz by 20%.															
	A		B	Cutting Speed – Vc m/min			D1 – Diameter														
	ap	ae	ap	min	max	mm	1,0	2,0	3,0	4,0	5,0	6,0	8,0	10,0	12,0	14,0	16,0	18,0	20,0		
	ap1 max	0,1 x D	0,5 x D			fz															
P	0	Ap1 max	0,1 x D	0,5 x D	150	–	200	fz	0,007	0,014	0,021	0,028	0,036	0,044	0,060	0,072	0,083	0,092	0,101	0,108	0,114
	1	Ap1 max	0,1 x D	0,5 x D	150	–	200	fz	0,007	0,014	0,021	0,028	0,036	0,044	0,060	0,072	0,083	0,092	0,101	0,108	0,114
	2	Ap1 max	0,1 x D	0,5 x D	140	–	190	fz	0,007	0,014	0,021	0,028	0,036	0,044	0,060	0,072	0,083	0,092	0,101	0,108	0,114
	3	Ap1 max	0,1 x D	0,5 x D	120	–	160	fz	0,006	0,011	0,017	0,023	0,030	0,036	0,050	0,061	0,070	0,079	0,087	0,095	0,101
	4	Ap1 max	0,1 x D	0,5 x D	90	–	150	fz	0,005	0,010	0,016	0,021	0,027	0,033	0,045	0,054	0,062	0,070	0,077	0,083	0,088
M	1	Ap1 max	0,1 x D	0,5 x D	90	–	115	fz	0,006	0,011	0,017	0,023	0,030	0,036	0,050	0,061	0,070	0,079	0,087	0,095	0,101
	2	Ap1 max	0,1 x D	0,5 x D	60	–	80	fz	0,005	0,009	0,014	0,019	0,024	0,029	0,040	0,048	0,056	0,063	0,070	0,076	0,081
K	1	Ap1 max	0,1 x D	0,5 x D	120	–	150	fz	0,007	0,014	0,021	0,028	0,036	0,044	0,060	0,072	0,083	0,092	0,101	0,108	0,114
	2	Ap1 max	0,1 x D	0,5 x D	110	–	140	fz	0,006	0,011	0,017	0,023	0,030	0,036	0,050	0,061	0,070	0,079	0,087	0,095	0,101

NOTE: Lower value of cutting speed is used for high stock removal applications or for higher hardness (machinability) within group.  
Higher value of cutting speed is used for finishing applications or for lower hardness (machinability) within group.  
Above parameters are based on ideal conditions. For smaller taper machining centers, please adjust parameters accordingly on greater than 12mm diameters.



TURNING

## GP End Mills • Series 4000 4010 • Application Data • TiAlN • Metric

Material Group																				
	Side Milling (A) and Slotting (B)			TiAlN			Recommended feed per tooth (fz = mm/th) for side milling (A). For slotting (B), reduce fz by 20%.													
	A		B	Cutting Speed – vc m/min			D1 – Diameter													
	ap	ae	ap	min	max	mm	3,0	4,0	5,0	6,0	8,0	10,0	12,0	14,0	16,0	18,0	20,0			
P	0	Ap1 max	0,1 x D	0,5 x D	150	–	200	fz	0,021	0,028	0,036	0,044	0,060	0,072	0,083	0,092	0,101	0,108	0,114	
	1	Ap1 max	0,1 x D	0,5 x D	150	–	200	fz	0,021	0,028	0,036	0,044	0,060	0,072	0,083	0,092	0,101	0,108	0,114	
	2	Ap1 max	0,1 x D	0,5 x D	140	–	190	fz	0,021	0,028	0,036	0,044	0,060	0,072	0,083	0,092	0,101	0,108	0,114	
	3	Ap1 max	0,1 x D	0,5 x D	120	–	160	fz	0,017	0,023	0,030	0,036	0,050	0,061	0,070	0,079	0,087	0,095	0,101	
M	4	Ap1 max	0,1 x D	0,5 x D	90	–	150	fz	0,016	0,021	0,027	0,033	0,045	0,054	0,062	0,070	0,077	0,083	0,088	
	1	Ap1 max	0,1 x D	0,5 x D	90	–	115	fz	0,017	0,023	0,030	0,036	0,050	0,061	0,070	0,079	0,087	0,095	0,101	
K	2	Ap1 max	0,1 x D	0,5 x D	60	–	80	fz	0,014	0,019	0,024	0,029	0,040	0,048	0,056	0,063	0,070	0,076	0,081	
	1	Ap1 max	0,1 x D	0,5 x D	120	–	150	fz	0,021	0,028	0,036	0,044	0,060	0,072	0,083	0,092	0,101	0,108	0,114	
	2	Ap1 max	0,1 x D	0,5 x D	110	–	140	fz	0,017	0,023	0,030	0,036	0,050	0,061	0,070	0,079	0,087	0,095	0,101	

NOTE: Lower value of cutting speed is used for high stock removal applications or for higher hardness (machinability) within group.  
Higher value of cutting speed is used for finishing applications or for lower hardness (machinability) within group.  
Above parameters are based on ideal conditions. For smaller taper machining centers, please adjust parameters accordingly on >12mm diameters.  
Refer to NOVO for slotting application information.

## GP End Mills • Series D014 2528 4014 4024 • Application Data • TiAlN • Metric

Material Group																				
	Side Milling (A)			TiAlN			Recommended feed per tooth (fz = mm/th) for side milling (A).													
	A			Cutting Speed – vc m/min			D1 – Diameter													
	ap	ae		min	max	mm	2,0	3,0	4,0	5,0	6,0	8,0	10,0	12,0	14,0	16,0	18,0	20,0		
P	0	Ap1 max	0,1 x D	150	–	200	fz	0,014	0,021	0,028	0,036	0,044	0,060	0,072	0,083	0,092	0,101	0,108	0,114	
	1	Ap1 max	0,1 x D	150	–	200	fz	0,014	0,021	0,028	0,036	0,044	0,060	0,072	0,083	0,092	0,101	0,108	0,114	
	2	Ap1 max	0,1 x D	140	–	190	fz	0,014	0,021	0,028	0,036	0,044	0,060	0,072	0,083	0,092	0,101	0,108	0,114	
	3	Ap1 max	0,1 x D	120	–	160	fz	0,011	0,017	0,023	0,030	0,036	0,050	0,061	0,070	0,079	0,087	0,095	0,101	
M	4	Ap1 max	0,1 x D	90	–	150	fz	0,010	0,016	0,021	0,027	0,033	0,045	0,054	0,062	0,070	0,077	0,083	0,088	
	1	Ap1 max	0,1 x D	90	–	115	fz	0,011	0,017	0,023	0,030	0,036	0,050	0,061	0,070	0,079	0,087	0,095	0,101	
K	2	Ap1 max	0,1 x D	60	–	80	fz	0,009	0,014	0,019	0,024	0,029	0,040	0,048	0,056	0,063	0,070	0,076	0,081	
	1	Ap1 max	0,1 x D	120	–	150	fz	0,014	0,021	0,028	0,036	0,044	0,060	0,072	0,083	0,092	0,101	0,108	0,114	
	2	Ap1 max	0,1 x D	110	–	140	fz	0,011	0,017	0,023	0,030	0,036	0,050	0,061	0,070	0,079	0,087	0,095	0,101	

NOTE: Lower value of cutting speed is used for high stock removal applications or for higher hardness (machinability) within group.  
Higher value of cutting speed is used for finishing applications or for lower hardness (machinability) within group.  
Above parameters are based on ideal conditions. For smaller taper machining centers, please adjust parameters accordingly on >12mm diameters.

# Burs

## Carbide Burs

WIDIA™ carbide burs are manufactured in compliance with USCTI standards and are the highest quality in the industry, delivering excellent performance and safety. Our unique manufacturing process ensures exceptional tool life with the reliability to operate safely at high speeds. WIDIA burs offer a comprehensive portfolio of sizes and shapes for all applications and workpiece materials.

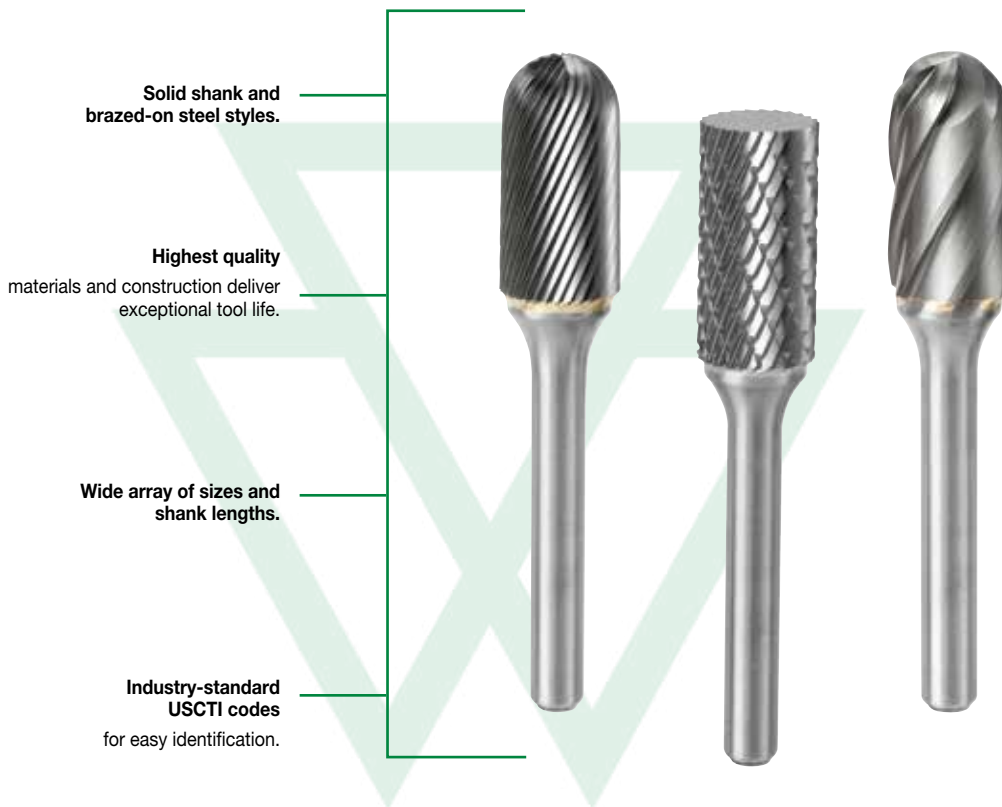

## Standard Cut Styles



P M K N

### Standard Cut (Right-Hand Spiral)

The WIDIA standard (right-hand spiral) cut produces a smooth finish for general-purpose use on steel, cast iron, and other ferrous and non-ferrous materials.

Most WIDIA carbide burs are available in the right-hand spiral design.



P M K S

### Master Cut (Double Cut)

The WIDIA exclusive master cut, with its chisel-type cutting edge, is a machine-ground tool built to exacting tolerances of concentricity, size, and shape. This accuracy, when combined with precision grinders, results in smooth-running, fast metal removal, and fine finishes. The right- and left-hand helical flutes combine to produce a chisel-type cutting tooth. This results in faster penetration and stock removal with minimal bounce or chatter.

The master cut design also produces an easy-to-handle granular-type chip in most metals, as opposed to the conventional sliver-type chips.

Throughout its life, the master cut gives faster stock removal and less operator fatigue, and maintains a good finish on the widest possible variety of workpiece materials.



N

### Aluminum Cut

The WIDIA aluminum cut burs are outstanding on soft or non-ferrous type materials. Use the aluminum cut design on aluminum, magnesium, brass, lead, and most plastics.

COARSE-CUT AND FINE-CUT RHS AVAILABLE AS SPECIALS.

# HOW TO SELECT A BUR

APPLICATIONS	MATERIAL	CUT	
<b>Efficient stock removal</b> – deburring, finishing, and cleaning.	Ferrous metals Non-ferrous metals	Double Master Cut	
<b>Heavy stock removal</b> – deburring, milling, cleaning, and machining.	Non-ferrous metal: aluminum alloys  Plastics	Aluminum Cut	
<b>Medium stock removal</b> – deburring, milling, cleaning, and finishing.	Non-ferrous metal: aluminum alloys  Plastics  Hard rubber	Coarse Cut Special Cut Style	
<b>Medium stock removal</b> – deburring, milling, cleaning, and finishing.	Non-hardened steel >45 HRC  Hardened steel >45 HRC: stainless steel  High-temperature resistant metals: nickel, cobalt, titanium  Non-ferrous light metals: brass, copper, and zinc  Hardened >45 HRC: cast iron	Single Cut	
<b>Light stock removal</b> – fine deburring and fine finishing.	Hardened steel >45 HRC	Fine Cut Special Cut Style	

## Series SA Cylindrical • Single-Cut Burs • Inch

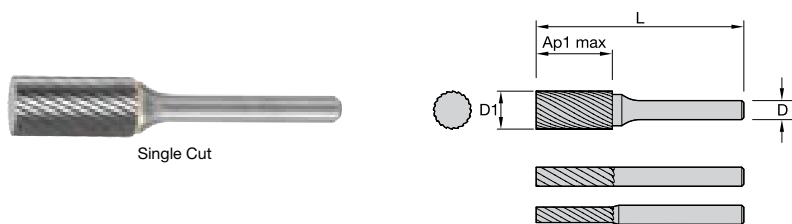

USCTI Number	Single Cut		D1	D	Ap1 max	length	shank style
	order #	catalog #				L	
SA-42	2736622	M40201	3/32	1/8	7/16	1 1/2	A
SA-43	2736616	M40202	1/8	1/8	9/16	1 1/2	A
SA-1	2736574	M40211	1/4	1/4	5/8	2	C
SA-3	1293725	M40214	3/8	1/4	3/4	2 1/2	C
SA-5	2736544	M40217	1/2	1/4	1	2 3/4	C
SA-6	2736534	M40219	5/8	1/4	1	2 3/4	C

## Series SB Cylindrical with End Cut • Single-Cut Burs • Inch

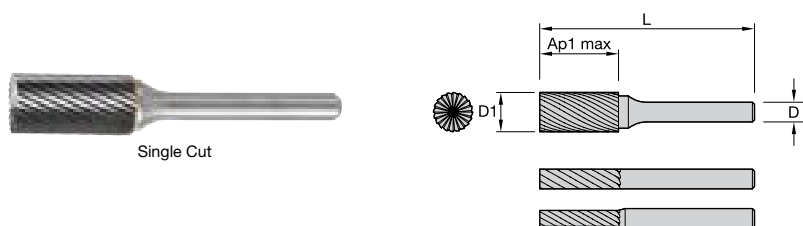

USCTI Number	Single Cut		D1	D	Ap1 max	length	shank style
	order #	catalog #				L	
SB-41	2736483	M40247	1/16	1/8	1/4	1 1/2	A
SB-3	2736441	M40256	3/8	1/4	3/4	2 1/2	C
SB-5	2736436	M40258	1/2	1/4	1	2 3/4	C

## Series SC Cylindrical Ball Nose • Single-Cut Burs • Inch

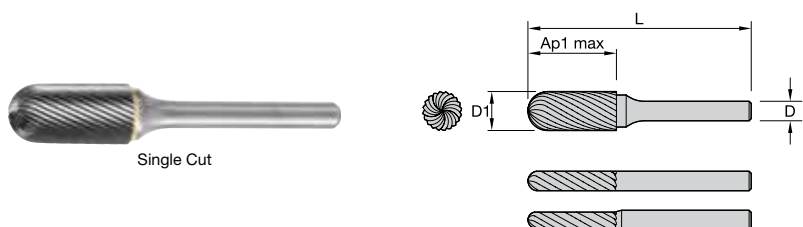

USCTI Number	Single Cut		D1	D	Ap1 max	length	shank style
	order #	catalog #				L	
SC-42	2736406	M40285	1/8	1/8	9/16	1 1/2	A
SC-1	2736369	M40293	1/4	1/4	5/8	2	C
SC-1L6	3043496	M40294	1/4	1/4	5/8	6 5/8	C
SC-2	2736358	M40295	5/16	1/4	3/4	2 1/2	C
SC-3	2736353	M40296	3/8	1/4	3/4	2 1/2	C
SC-5	2736339	M40299	1/2	1/4	1	2 3/4	C

Series SD Ball • Single-Cut Burs • Inch

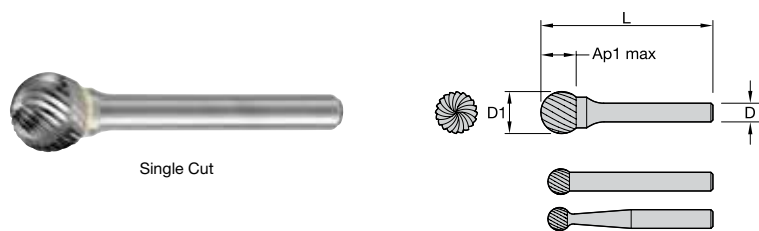

USCTI Number	Single Cut		D1	D	Ap1 max	length		shank style
	order #	catalog #				L		
SD40	2730676	M40322	1/16	1/8	1/16	1 1/2	A	
SD-41	2730671	M40323	3/32	1/8	3/32	1 1/2	A	
SD-42L2	3044078	M40325	1/8	1/8	1/8	2	A	
SD-11	3043497	M40327	1/8	1/4	1/8	2	C	
SD-53	2730649	M40328	3/16	1/8	3/16	1 1/2	D	
SD-51	2730639	M40330	1/4	1/8	1/4	1 3/4	B	
SD-1	2730634	M40331	1/4	1/4	1/4	2	C	
SD-1L6	2730629	M40332	1/4	1/4	1/4	6 1/4	C	
SD-3	2730619	M40334	3/8	1/4	3/8	2 5/64	C	
SD-3L6	2730614	M40335	3/8	1/4	3/8	6 3/8	C	
SD-5	2730603	M40337	1/2	1/4	1/2	2 13/64	C	
SD-5L6	2730598	M40338	1/2	1/4	1/2	6 1/2	C	
SD-6	2730593	M40339	5/8	1/4	5/8	2 5/16	C	
SD-7	2730588	M40340	3/4	1/4	3/4	2 7/16	C	

Series SF Round Nose Tree • Single-Cut Burs • Inch

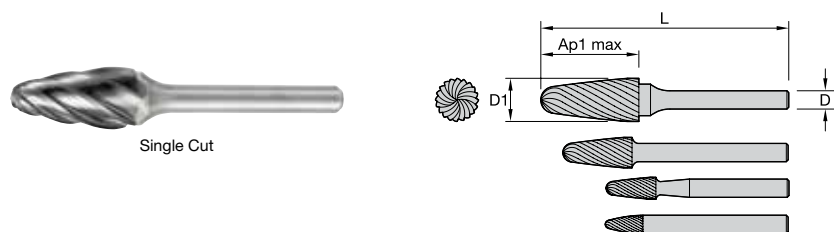

USCTI Number	Single Cut		D1	D	Ap1 max	length		shank style
	order #	catalog #				L		
SF-41	2730511	M40379	1/8	1/8	1/4	1 1/2	A	
SF-42	2730506	M40380	1/8	1/8	1/2	1 1/2	A	
SF-51	2730495	M40382	1/4	1/8	1/2	1 3/4	B	
SF-3	2730481	M40385	3/8	1/4	3/4	2 1/2	C	

Series SG Pointed Tree • Single-Cut Burs • Inch

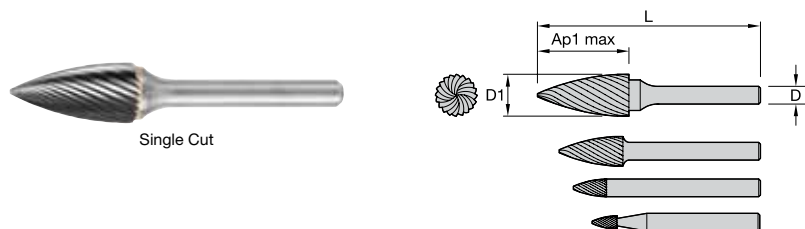

USCTI Number	Single Cut		D1	D	Ap1 max	length		shank style
	order #	catalog #				L		
SG-43	3054754	M40416	1/8	1/8	3/8	1 1/2	A	
SG-44	2730385	M40417	1/8	1/8	1/2	1 1/2	A	
SG-53	2730380	M40418	3/16	1/8	1/2	1 1/2	D	
SG-1	2730371	M40420	1/4	1/4	5/8	2	C	

## Series SH Flame • Single-Cut Burs • Inch

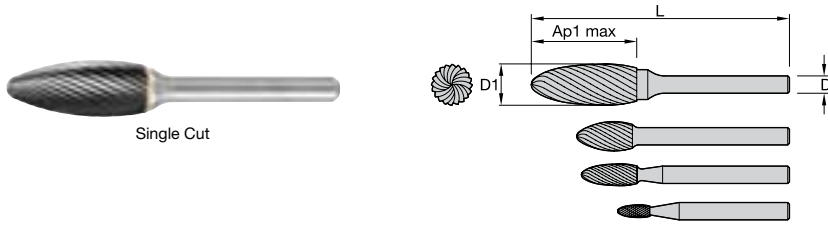

USCTI Number	Single Cut		D1	D	Ap1 max	length	shank style
	order #	catalog #				L	
SH-41	2730325	M40446	1/8	1/8	1/4	1 1/2	A
SH-53	2730320	M40447	3/16	1/8	3/8	1 1/2	D
SH-2	2730315	M40448	5/16	1/4	3/4	2 1/2	C
SH-5	2730310	M40449	1/2	1/4	1 1/4	3	C
SH-6	2730305	M40450	5/8	1/4	1 7/16	3 3/16	C

## Series SL Included Angle • Single-Cut Burs • Inch

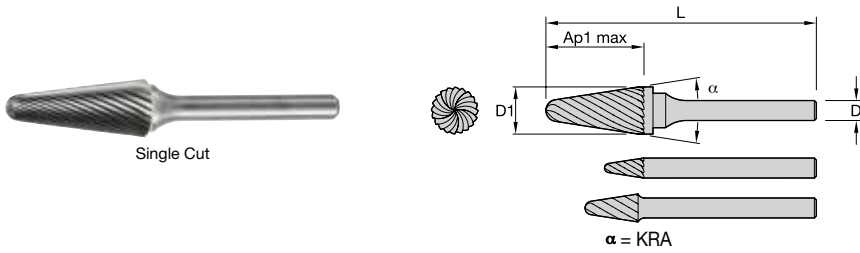

USCTI Number	Single Cut		D1	D	Ap1 max	length	shank style	KRA
	order #	catalog #				L		
SL-42	2730290	M40462	1/8	1/8	1/2	1 1/2	A	8
SL-53	2730285	M40463	3/16	1/8	1/2	1 1/2	D	14

## Series SM Pointed Cone • Single-Cut Burs • Inch

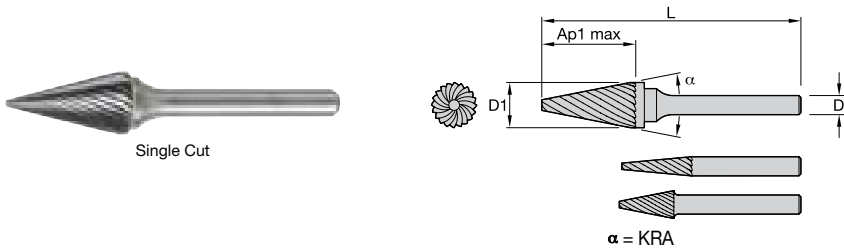

USCTI Number	Single Cut		D1	D	Ap1 max	length	shank style	KRA
	order #	catalog #				L		
SM-42	2730202	M40486	1/8	1/8	7/16	1 1/2	A	14
SM-43	2730196	M40487	1/8	1/8	5/8	1 1/2	A	7
SM-2	2730174	M40491	1/4	1/4	3/4	2	C	14
SM-5	2730159	M40494	1/2	1/4	7/8	2 3/4	C	28

**Series SA-M Cylindrical • Single-Cut Burs • Metric**

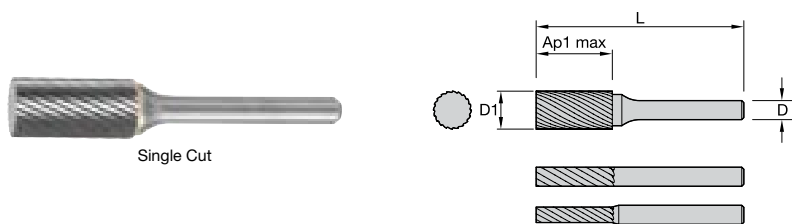

Single Cut			D1	D	Ap1 max	length L	shank style
USCTI Number	order #	catalog #					
SA-43M	2736521	M40224	3,0	3,0	14,3	38,1	A

**Series SB-M Cylindrical with End Cut • Single-Cut Burs • Metric**

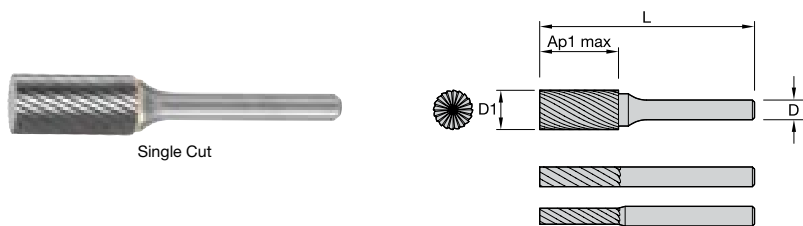

Single Cut			D1	D	Ap1 max	length L	shank style
USCTI Number	order #	catalog #					
SB-1M	2986664	M40268	6,0	6,0	15,9	50,8	C

**Series SC-M Cylindrical Ball Nose • Single-Cut Burs • Metric**

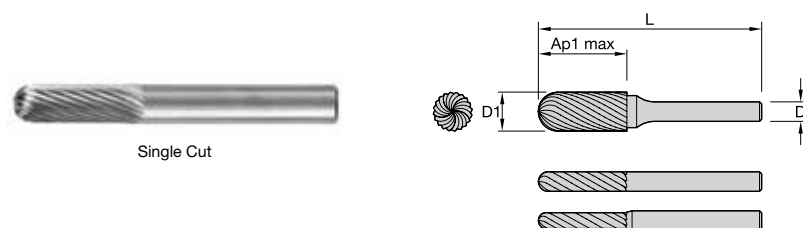

Single Cut			D1	D	Ap1 max	length L	shank style
USCTI Number	order #	catalog #					
SC-42M	2736319	M40304	3,0	3,0	14,3	38,1	A

INDEXABLE MILLING

SOLID END MILLING

HOLE/MAKING

TAPPING

TURNING



## Series SD-M Ball • Single-Cut Burs • Metric

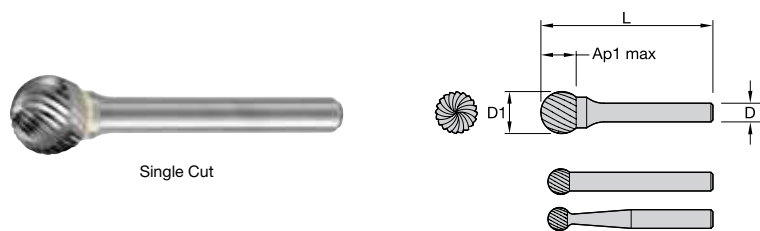

Single Cut

USCTI Number	Single Cut		D1	D	Ap1 max	length	shank style
	order #	catalog #				L	
SD-40M	1293470	M40342	1,6	3,0	1,6	38,1	A
SD-42M	2730572	M40344	3,0	3,0	3,0	38,1	A
SD-1M	2730567	M40347	6,0	6,0	6,0	50,8	C

## Series SE-M Egg • Master-Cut Burs • Metric

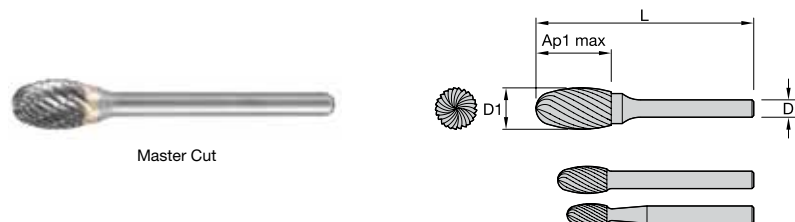

Master Cut

USCTI Number	Master Cut		D1	D	Ap1 max	length	shank style
	order #	catalog #				L	
SE-51M	2987333	M41370	6,4	3,0	9,5	41,3	B

## Series SG-M Pointed Tree • Single-Cut Burs • Metric

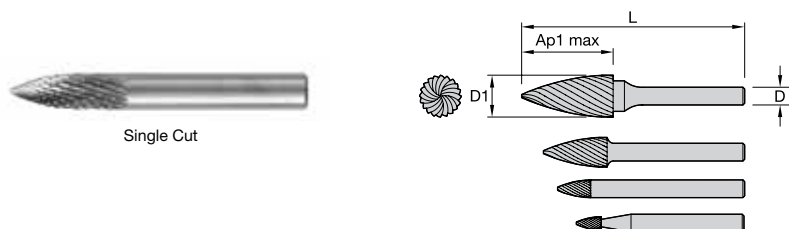

Single Cut

USCTI Number	Single Cut		D1	D	Ap1 max	length	shank style
	order #	catalog #				L	
SG-43M	2730335	M40430	3,0	3,0	9,5	38,1	A
SG-3M	2981799	M40436	9,5	6,0	19,1	63,5	C

**Series SL-M Included Angle • Single-Cut Burs • Metric**

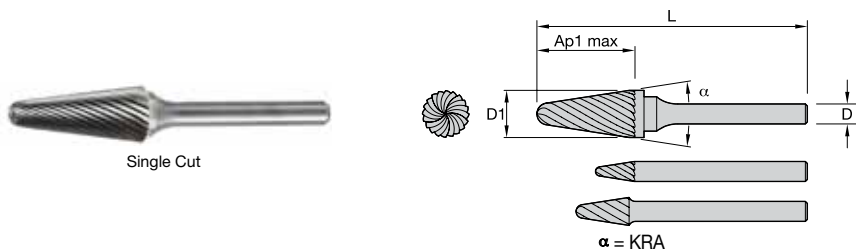

Single Cut					length			
USCTI Number	order #	catalog #	D1	D	Ap1 max	L	shank style	KRA
SL-42M	2730232	M40474	3,0	3,0	12,7	38,1	A	8
SL-4M	2730217	M40479	12,7	6,0	31,8	76,2	C	14

**Series SM-M Pointed Cone • Single-Cut Burs • Metric**

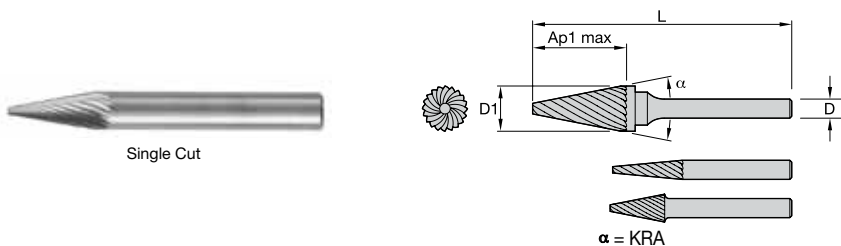

Single Cut					length			
USCTI Number	order #	catalog #	D1	D	Ap1 max	L	shank style	KRA
SM-42M	2987352	M40497	3,0	3,0	11,1	38,1	A	14
SM-43M	2990413	M40498	3,0	3,0	15,9	38,1	A	7

INDEXABLE MILLING

SOLID END MILLING

HOLE/MAKING

TAPPING

TURNING

## Series SA Cylindrical • Master-Cut Burs • Inch

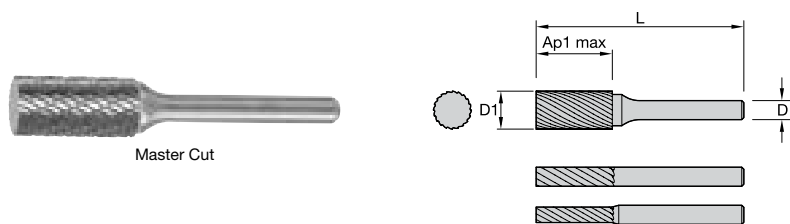

USCTI Number	Master Cut		D1	D	Ap1 max	length		shank style
	order #	catalog #				L		
SA-41	2735826	M41200	1/16	1/8	1/4	1 1/2	A	
SA-42	2735821	M41201	3/32	1/8	7/16	1 1/2	A	
SA-43	2735816	M41202	1/8	1/8	9/16	1 1/2	A	
SA-43L2	2735811	M41203	1/8	1/8	9/16	2	A	
SA-43L3	2735806	M41204	1/8	1/8	9/16	3	A	
SA-11	2735801	M41205	1/8	1/4	1/2	2	C	
SA-14	2735787	M41208	3/16	1/4	5/8	2	C	
SA-51	2735782	M41209	1/4	1/8	3/16	1 7/16	B	
SA-51-2	2735777	M41210	1/4	1/8	1/2	1 3/4	B	
SA-1	2735772	M41211	1/4	1/4	5/8	2	C	
SA-2	2735763	M41213	5/16	1/4	3/4	2 1/2	C	
SA-3	3063092	M41214	3/8	1/4	3/4	2 1/2	C	
SA-5	2735742	M41217	1/2	1/4	1	2 3/4	C	
SA-6	2735732	M41219	5/8	1/4	1	2 3/4	C	
SA-7	2735727	M41220	3/4	1/4	1	2 3/4	C	
SA-9	2735722	M41221	1	1/4	1	2 3/4	C	

## Series SB Cylindrical with End Cut • Master-Cut Burs • Inch

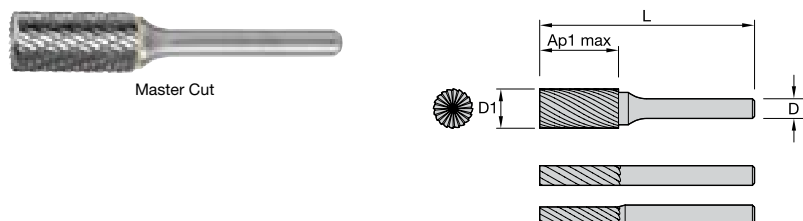

USCTI Number	Master Cut		D1	D	Ap1 max	length		shank style
	order #	catalog #				L		
SB-51	2735666	M41252	1/4	1/8	3/16	1 7/16	B	
SB-51-2	2735662	M41253	1/4	1/8	1/2	1 3/4	B	
SB-1	2735657	M41254	1/4	1/4	5/8	2	C	
SB-2	3055771	M41255	5/16	1/4	3/4	2 1/2	C	
SB-3	2735646	M41256	3/8	1/4	3/4	2 1/2	C	
SB-5	2735636	M41258	1/2	1/4	1	2 3/4	C	
SB-6	2735631	M41259	5/8	1/4	1	2 3/4	C	
SB-7	2735626	M41260	3/4	1/4	1	2 3/4	C	

Series SC Cylindrical Ball Nose • Master-Cut Burs • Inch

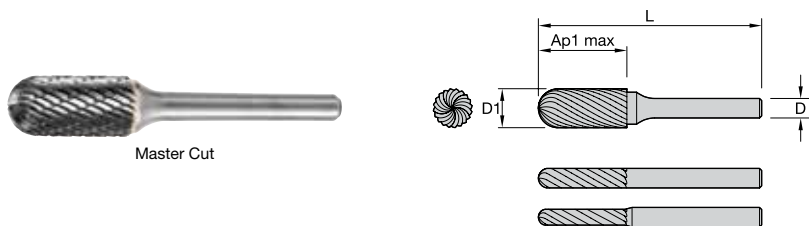

USCTI Number	Master Cut		D1	D	Ap1 max	length		shank style
	order #	catalog #				L		
SC-41	2735611	M41284	3/32	1/8	7/16	1 1/2		A
SC-42	2735606	M41285	1/8	1/8	9/16	1 1/2		A
SC-42L3	2735596	M41287	1/8	1/8	9/16	3		A
SC-11	2735591	M41288	1/8	1/4	1/2	2		A
SC-53	2735581	M41290	3/16	1/8	1/2	1 1/2		D
SC-51	2735571	M41292	1/4	1/8	1/2	1 3/4		B
SC-1	2735566	M41293	1/4	1/4	5/8	2		C
SC-1L6	2735561	M41294	1/4	1/4	5/8	6 5/8		C
SC-2	2735556	M41295	5/16	1/4	3/4	2 1/2		C
SC-3	2735551	M41296	3/8	1/4	3/4	2 1/2		C
SC-3L6	2735546	M41297	3/8	1/4	3/4	6 3/4		C
SC-4	3050641	M41298	7/16	1/4	1	2 3/4		C
SC-5	2735531	M41299	1/2	1/4	1	2 3/4		C
SC-5L6	2735526	M41300	1/2	1/4	1	7		C
SC-6	2735521	M41301	5/8	1/4	1	2 3/4		C
SC-7	2735516	M41302	3/4	1/4	1	2 3/4		C

Series SD Ball • Master-Cut Burs • Inch

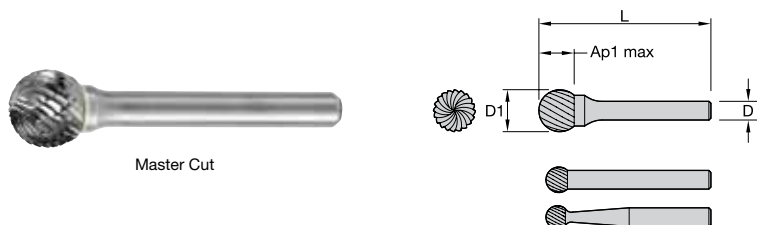

USCTI Number	Master Cut		D1	D	Ap1 max	length		shank style
	order #	catalog #				L		
SD-41	2729967	M41323	3/32	1/8	3/32	1 1/2		A
SD-42	2729963	M41324	1/8	1/8	1/8	1 1/2		A
SD-42L3	2729951	M41326	1/8	1/8	1/8	3		A
SD-11	2729946	M41327	1/8	1/4	1/8	2		C
SD-53	2729942	M41328	3/16	1/8	3/16	1 1/2		D
SD-14	2729936	M41329	3/16	1/4	3/16	2		C
SD-51	2729930	M41330	1/4	1/8	1/4	1 3/4		B
SD-1	2729926	M41331	1/4	1/4	1/4	2		C
SD-1L6	2729920	M41332	1/4	1/4	1/4	6 1/4		C
SD-2	2729914	M41333	5/16	1/4	5/16	2 1/32		C
SD-3	2729910	M41334	3/8	1/4	3/8	2 5/64		C
SD-3L6	2729906	M41335	3/8	1/4	3/8	6 3/8		C
SD-4	2729901	M41336	7/16	1/4	7/16	2 9/64		C
SD-5	2729895	M41337	1/2	1/4	1/2	2 13/64		C
SD-5L6	3046344	M41338	1/2	1/4	1/2	6 1/2		C
SD-7	2729880	M41340	3/4	1/4	3/4	2 7/16		C
SD-9	2729873	M41341	1	1/4	1	2 11/16		C

## Series SE Egg • Master-Cut Burs • Inch

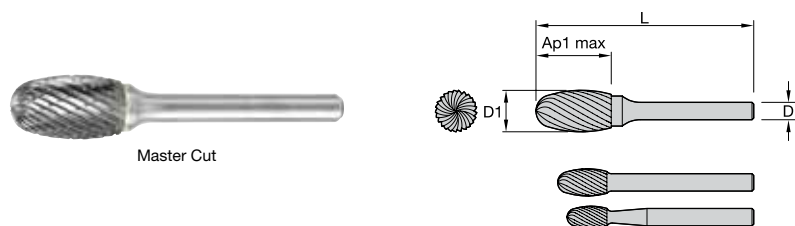

USCTI Number	Master Cut		D1	D	Ap1 max	length	shank style
	order #	catalog #				L	
SE-41	2729835	M41360	1/8	1/8	7/32	1 1/2	A
SE-53	2729830	M41361	3/16	1/8	9/32	1 1/2	D
SE-51	2729825	M41362	1/4	1/8	3/8	1 5/8	B
SE-1	2729820	M41363	1/4	1/4	3/8	2	C
SE-3	2729814	M41364	3/8	1/4	5/8	2 3/8	C
SE-5	2729808	M41365	1/2	1/4	7/8	2 5/8	C
SE-6	2729803	M41366	5/8	1/4	1	2 3/4	C

## Series SF Round Nose Tree • Master-Cut Burs • Inch

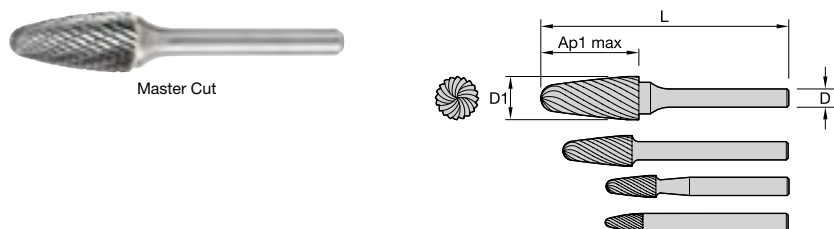

USCTI Number	Master Cut		D1	D	Ap1 max	length	shank style
	order #	catalog #				L	
SF-41	2729782	M41379	1/8	1/8	1/4	1 1/2	A
SF-42	2729778	M41380	1/8	1/8	1/2	1 1/2	A
SF-51	2729768	M41382	1/4	1/8	1/2	1 3/4	B
SF-1	1750297	M41383	1/4	1/4	5/8	2	C
SF-3	2729751	M41385	3/8	1/4	3/4	2 1/2	C
SF-3L6	2729746	M41386	3/8	1/4	3/4	6 3/4	C
SF-13	2729736	M41388	1/2	1/4	3/4	2 1/2	C
SF-5	2729731	M41389	1/2	1/4	1	2 3/4	C
SF-5L6	2729726	M41390	1/2	1/4	1	7	C
SF-6	2729721	M41391	5/8	1/4	1	2 3/4	C
SF-7	2729716	M41392	3/4	1/4	1	2 3/4	C
SF-15	2729711	M41393	3/4	1/4	1 1/2	3 1/4	C
SF-14	2729706	M41394	3/4	1/4	1 1/4	3	C

Series SG Pointed Tree • Master-Cut Burs • Inch

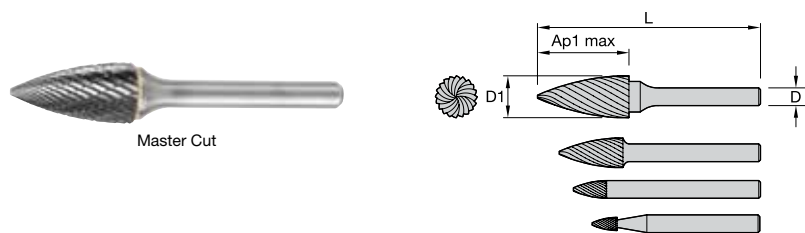

USCTI Number	Master Cut		D1	D	Ap1 max	length L	shank style
	order #	catalog #					
SG-41	2729675	M41414	1/8	1/8	1/4	1 1/2	A
SG-42	2729669	M41415	1/8	1/8	5/16	1 1/2	A
SG-44	2729660	M41417	1/8	1/8	1/2	1 1/2	A
SG-51	2729651	M41419	1/4	1/8	1/2	1 3/4	B
SG-1	2729646	M41420	1/4	1/4	5/8	2	C
SG-3	2729636	M41422	3/8	1/4	3/4	2 1/2	C
SG-5	2729626	M41424	1/2	1/4	1	2 3/4	C

Series SH Flame • Master-Cut Burs • Inch

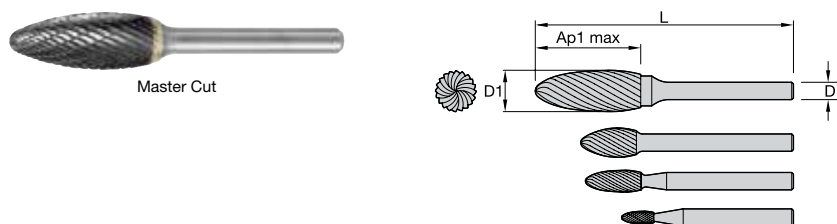

USCTI Number	Master Cut		D1	D	Ap1 max	length L	shank style
	order #	catalog #					
SH-41	2729586	M41446	1/8	1/8	1/4	1 1/2	A
SH-2	2729575	M41448	5/16	1/4	3/4	2 1/2	C
SH-5	2729570	M41449	1/2	1/4	1 1/4	3	C
SH-7	2729559	M41451	3/4	1/4	1 5/8	3 3/8	C

## Series SL Included Angle • Master-Cut Burs • Inch



Master Cut

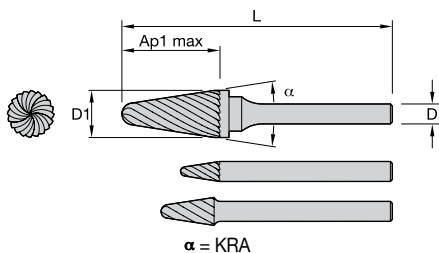

USCTI Number	Master Cut		D1	D	Ap1 max	length L	shank style	KRA
	order #	catalog #						
SL-41	3046345	M41461	1/8	1/8	3/8	1 1/2	A	8
SL-42	2729539	M41462	1/8	1/8	1/2	1 1/2	A	8
SL-1	2729529	M41464	1/4	1/4	5/8	2	C	14
SL-1L6	2729523	M41465	1/4	1/4	5/8	6 5/8	C	14
SL-2	1752788	M41466	5/16	1/4	7/8	2 3/4	C	14
SL-3	2729513	M41467	3/8	1/4	1 1/16	2 15/16	C	14
SL-4	2729503	M41469	1/2	1/4	1 1/8	3	C	14
SL-6	2729493	M41471	5/8	1/4	1 5/16	3 3/16	C	14

## Series SM Pointed Cone • Master-Cut Burs • Inch



Master Cut

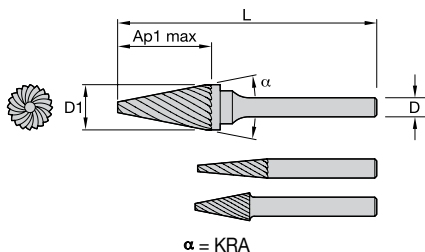

USCTI Number	Master Cut		D1	D	Ap1 max	length L	shank style	KRA
	order #	catalog #						
SM-41	2729447	M41485	1/8	1/8	3/8	1 1/2	A	12
SM-42	2729443	M41486	1/8	1/8	7/16	1 1/2	A	14
SM-43	2729438	M41487	1/8	1/8	5/8	1 1/2	A	7
SM-53	2729433	M41488	3/16	1/8	1/2	1 1/2	D	16
SM-51	3050060	M41489	1/4	1/8	1/2	1 7/8	B	22
SM-1	2729423	M41490	1/4	1/4	1/2	2	C	22
SM-2	2729418	M41491	1/4	1/4	3/4	2	C	14
SM-3	2729413	M41492	1/4	1/4	1	2	C	10
SM-4	2729407	M41493	3/8	1/4	5/8	2 1/2	C	28
SM-5	2729402	M41494	1/2	1/4	7/8	2 3/4	C	28
SM-6	2729397	M41495	5/8	1/4	1	2 7/8	C	31

Series SN Inverted Taper • Master-Cut Burs • Inch



Master Cut

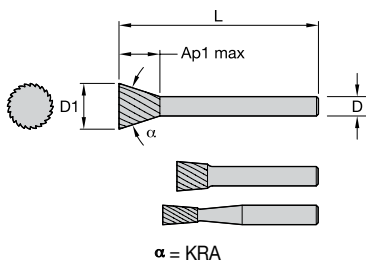

USCTI Number	Master Cut		D1	D	Ap1 max	length L	shank style	KRA
	order #	catalog #						
SN-51	3051758	M41512	1/4	1/8	1/4	1 1/2	B	10
SN-3	2729351	M41514	1/2	1/4	1/2	2 1/4	C	16

Series SA-M Cylindrical • Master-Cut Burs • Metric



Master Cut

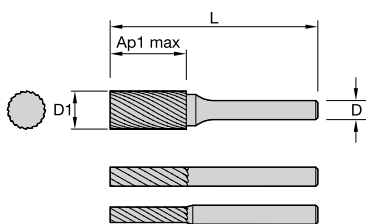

USCTI Number	Master Cut		D1	D	Ap1 max	length L	shank style
	order #	catalog #					
SA-41M	1598896	M41222	1,6	3,0	4,8	38,1	A
SA-42M	1293458	M41223	2,4	3,0	11,1	38,1	A
SA-43M	2270852	M41224	3,0	3,0	14,3	38,1	A
SA-1M	1977519	M41229	6,0	6,0	15,9	50,8	C
SA-51M-2	1977415	M41231	6,4	3,0	12,7	44,5	B
SA-2M	2735696	M41232	7,9	6,0	19,1	63,5	C
SA-3M	1293733	M41233	9,5	6,0	19,1	63,5	C
SA-5M	2219983	M41237	12,7	6,0	25,4	69,9	C



## Series SB-M Cylindrical with End Cut • Master-Cut Burs • Metric

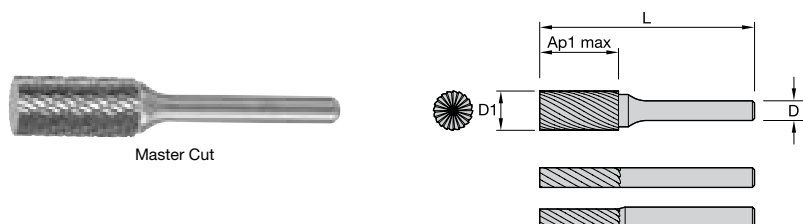

USCTI Number	Master Cut		D1	D	Ap1 max	length		shank style
	order #	catalog #				L		
SB-42M	2991812	M41262	2,4	3,0	11,1	38,1		A
SB-43M	2220466	M41263	3,0	3,0	14,3	38,1		A
SB-1M	2987342	M41268	6,0	6,0	15,9	50,8		C
SB-51M-2	2987340	M41270	6,4	3,0	6,4	44,5		B
SB-2M	2987339	M41271	7,9	6,0	19,1	63,5		C
SB-3M	2987338	M41272	9,5	6,0	19,1	63,5		C
SB-5M	2987337	M41274	12,7	6,0	25,4	69,9		C

## Series SC-M Cylindrical Ball Nose • Master-Cut Burs • Metric

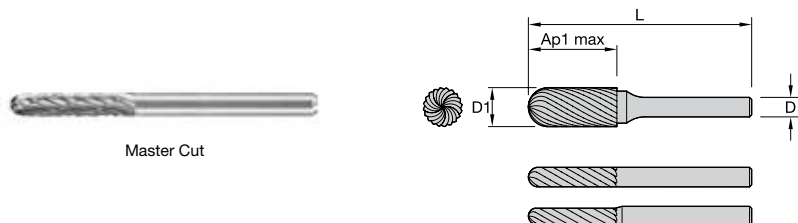

USCTI Number	Master Cut		D1	D	Ap1 max	length		shank style
	order #	catalog #				L		
SC-41M	2990415	M41303	2,4	3,0	11,1	38,1		A
SC-42M	1977373	M41304	3,0	3,0	14,3	38,1		A
SC-52M	2735503	M41306	4,0	3,0	12,7	38,1		D
SC-53M	2894604	M41307	4,8	3,0	12,7	38,1		D
SC-14M	2991273	M41308	4,8	6,0	15,9	50,8		C
SC-1M	1977546	M41309	6,0	6,0	15,9	50,8		C
SC-51M	2894603	M41310	6,4	3,0	12,7	44,5		B
SC-2M	2729973	M41311	7,9	6,0	19,1	63,5		C
SC-3M	1977548	M41312	9,5	6,0	19,1	63,5		C
SC-4M	2987336	M41314	11,1	6,0	25,4	69,9		C
SC-5M	1977549	M41316	12,7	6,0	25,4	69,9		C
SC-6M	2991274	M41318	15,9	6,0	25,4	69,9		C

**Series SD-M Ball • Master-Cut Burs • Metric**

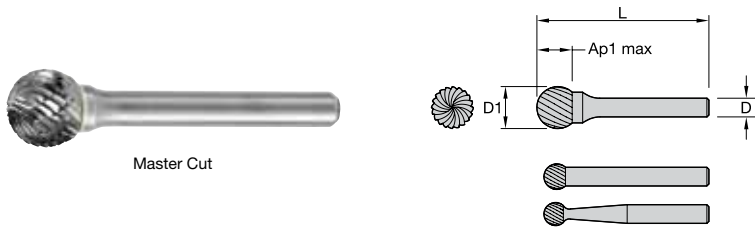

USCTI Number	Master Cut		D1	D	Ap1 max	length		shank style
	order #	catalog #				L		
SD-41M	2729868	M41343	2,4	3,0	2,4	38,1		A
SD-42M	2729863	M41344	3,0	3,0	3,0	38,1		A
SD-53M	2973335	M41345	4,8	3,0	4,8	38,1		D
SD-14M	2987335	M41346	4,8	6,0	4,8	50,8		C
SD-1M	2729860	M41347	6,0	6,0	6,0	50,8		C
SD-51M	2729855	M41348	6,4	3,0	6,4	38,1		B
SD-2M	2987334	M41349	7,9	6,0	7,9	51,6		C
SD-3M	2991276	M41350	9,5	6,0	9,5	52,8		C
SD-5M	2729850	M41352	12,7	6,0	12,7	56,0		C

**Series SE-M Egg • Master-Cut Burs • Metric**

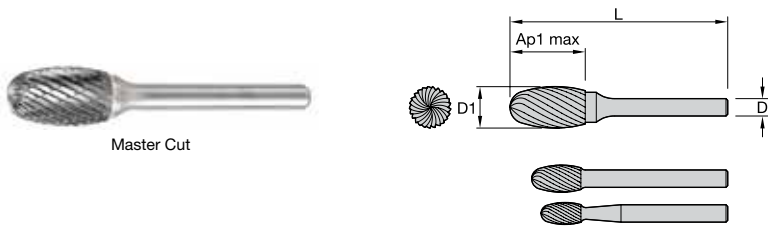

USCTI Number	Master Cut		D1	D	Ap1 max	length		shank style
	order #	catalog #				L		
SE-3M	2991277	M41371	9,5	6,0	15,9	60,3		C
SE-5M	1977570	M41373	12,7	6,0	22,2	66,7		C
SE-5M-2	3324697	M41374	12,7	8,0	22,2	73,0		C
SE-7M	2991816	M41377	19,1	6,0	25,4	69,9		C

**Series SF-M Round Nose Tree • Master-Cut Burs • Metric**

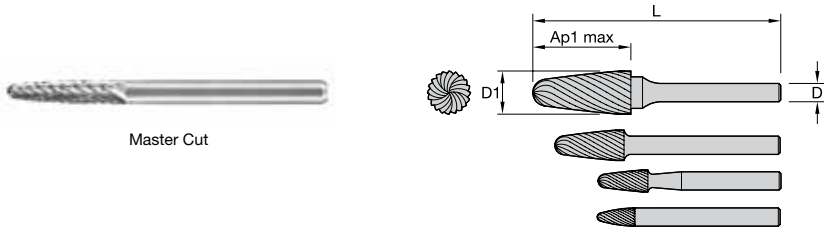

USCTI Number	Master Cut		D1	D	Ap1 max	length L	shank style
	order #	catalog #					
SF-42M	1977374	M41396	3,0	3,0	12,7	38,1	A
SF-53M	2729701	M41397	4,8	3,0	12,7	38,1	D
SF-51M	1977417	M41399	6,4	3,0	12,7	44,5	B
SF-3M	3526093	M41400	9,5	6,0	19,1	63,5	C
SF-4M	1977555	M41401	11,1	6,0	25,4	69,9	C
SF-5M	1977556	M41403	12,7	6,0	25,4	69,9	C

**Series SG-M Pointed Tree • Master-Cut Burs • Metric**

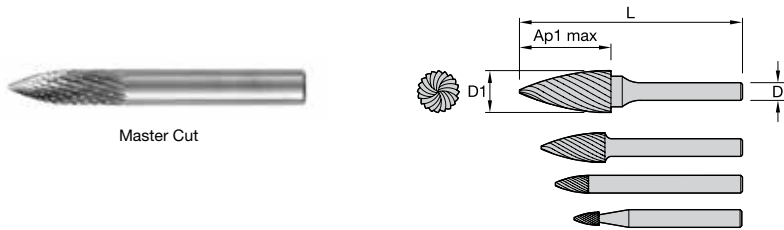

USCTI Number	Master Cut		D1	D	Ap1 max	length L	shank style
	order #	catalog #					
SG-41M-2	1293463	M41428	3,0	3,0	6,4	38,1	A
SG-44M	1534016	M41431	3,0	3,0	12,7	38,1	A
SG-53M	2894601	M41432	4,8	3,0	12,7	38,1	D
SG-1M	2987329	M41433	6,0	6,0	15,9	50,8	C
SG-51M	1293476	M41434	6,4	3,0	12,7	44,5	B
SG-2M	2987327	M41435	7,9	6,0	19,1	63,5	C
SG-3M	2987326	M41436	9,5	6,0	19,1	63,5	C
SG-5M	2729591	M41439	12,7	6,0	25,4	69,9	C

**Series SH-M Flame • Master-Cut Burs • Metric**

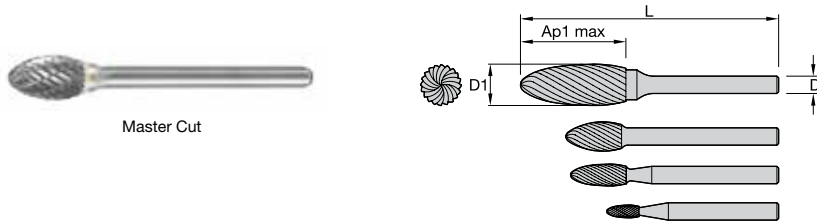

USCTI Number	Master Cut		D1	D	Ap1 max	length L	shank style
	order #	catalog #					
SH-53M	1977429	M41453	4,8	3,0	9,5	38,1	D
SH-2M	2991284	M41454	7,9	6,0	19,1	63,5	C
SH-5M	2987323	M41455	12,7	6,0	31,8	76,2	C
SH-6M	2987322	M41457	15,9	6,0	36,5	81,0	C

Series SM-M Pointed Cone • Master-Cut Burs • Metric

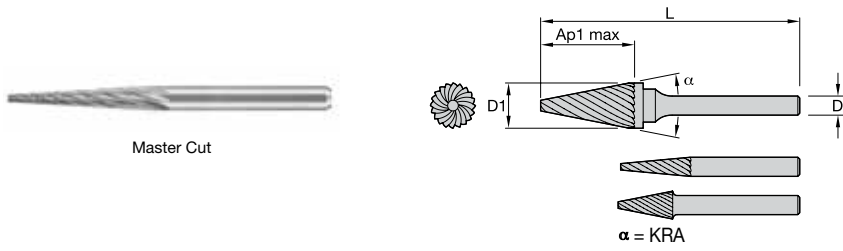

USCTI Number	Master Cut		D1	D	Ap1 max	length L	shank style	KRA
	order #	catalog #						
SM-42M	1977382	M41497	3,0	3,0	11,1	38,1	A	14
SM-43M	1293468	M41498	3,0	3,0	15,9	38,1	A	7
SM-2M	1977564	M41501	6,0	6,0	19,1	50,8	C	14
SM-5M	1977567	M41505	12,7	6,0	22,2	69,9	C	28

Series SB Cylindrical with End Cut • Aluminum-Cut Burs • Inch

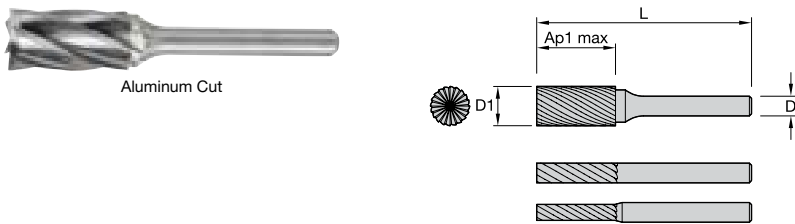

USCTI Number	Aluminum Cut		D1	D	Ap1 max	length L	shank style
	order #	catalog #					
SB-1	2736311	M40527	1/4	1/4	5/8	2	C
SB-3	2736307	M40528	3/8	1/4	3/4	2 1/2	C
SB-5	2736300	M40529	1/2	1/4	1	2 3/4	C

Series SC Cylindrical Ball Nose • Aluminum-Cut Burs • Inch

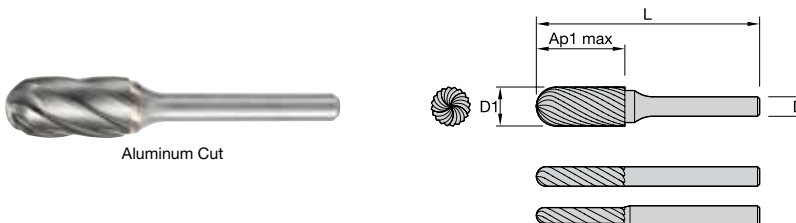

USCTI Number	Aluminum Cut		D1	D	Ap1 max	length L	shank style
	order #	catalog #					
SC-5	2736276	M40534	1/2	1/4	1	2 3/4	C

INDEXABLE MILLING

SOLID END MILLING

HOLE/MAKING

TAPPING

TURNING

## Series SD Ball • Aluminum-Cut Burs • Inch

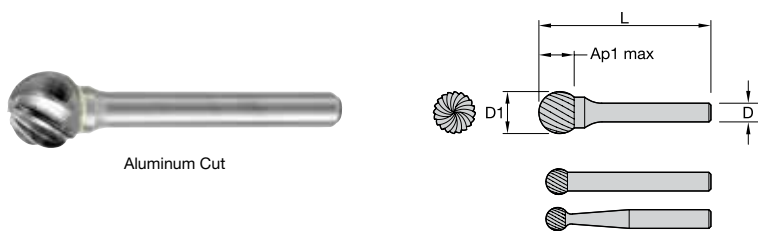

Aluminum Cut

USCTI Number	Aluminum Cut		D1	D	Ap1 max	length	shank style
	order #	catalog #				L	
SD-3	2730072	M40538	3/8	1/4	3/8	2 5/64	C
SD-5	2730067	M40539	1/2	1/4	1/2	2 13/64	C

## Series SE Egg • Aluminum-Cut Burs • Inch

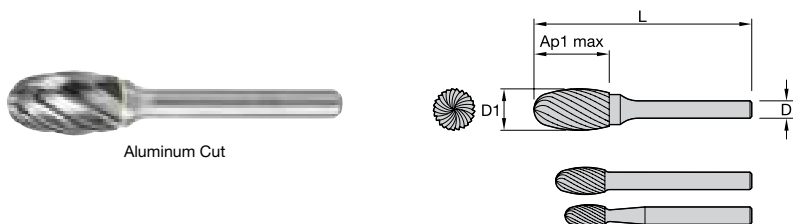

Aluminum Cut

USCTI Number	Aluminum Cut		D1	D	Ap1 max	length	shank style
	order #	catalog #				L	
SE-5	2730053	M40542	1/2	1/4	7/8	2 5/8	C

## Series SF Round Nose Tree • Aluminum-Cut Burs • Inch

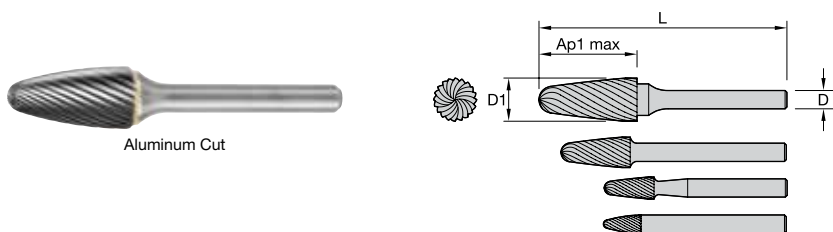

Aluminum Cut

USCTI Number	Aluminum Cut		D1	D	Ap1 max	length	shank style
	order #	catalog #				L	
SF-3	2730037	M40545	3/8	1/4	3/4	2 1/2	C
SF-5	2730032	M40546	1/2	1/4	1	2 3/4	C
SF-6	2730027	M40547	5/8	1/4	1	2 3/4	C

Series SL Included Angle • Aluminum-Cut Burs • Inch

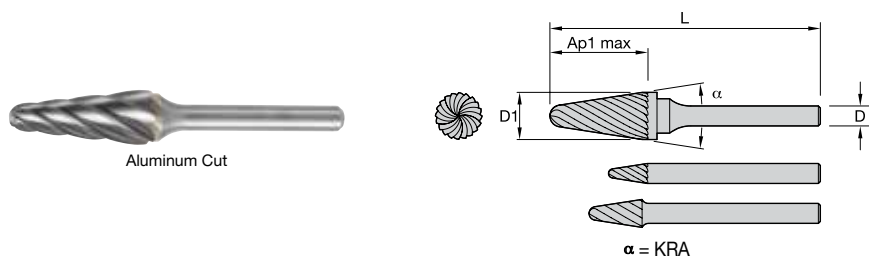

USCTI Number	Aluminum Cut		D1	D	Ap1 max	length		shank style	KRA
	order #	catalog #				L			
SL-3	2730022	M40548	3/8	1/4	1 1/16	2 15/16		C	14
SL-4	2730017	M40549	1/2	1/4	1 1/8	3		C	14

Series SC-M Cylindrical Ball Nose • Aluminum-Cut Burs • Metric

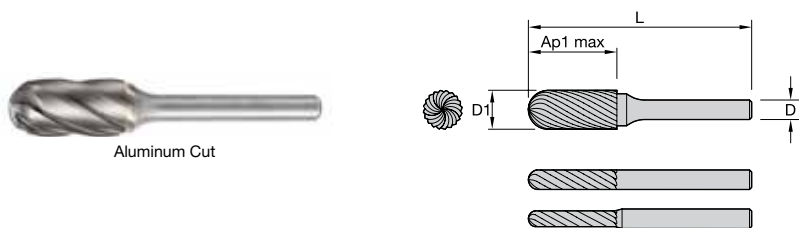

USCTI Number	Aluminum Cut		D1	D	Ap1 max	length		shank style
	order #	catalog #				L		
SC-5M	2987349	M40561	12,7	6,0	25,4	69,9		C

Series SF-M Round Nose Tree • Aluminum-Cut Burs • Metric

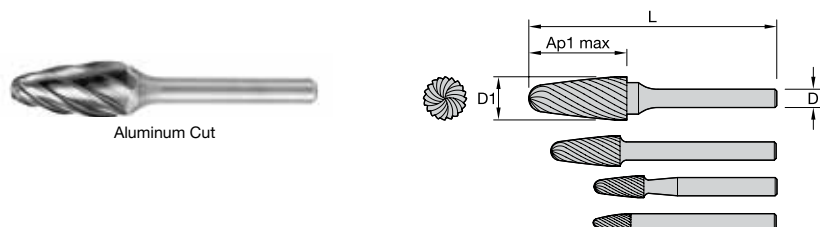

USCTI Number	Aluminum Cut		D1	D	Ap1 max	length		shank style
	order #	catalog #				L		
SF-5M	1977630	M40578	12,7	6,0	25,4	69,9		C

## Series SL-M Included Angle • Master-Cut Burs • Metric

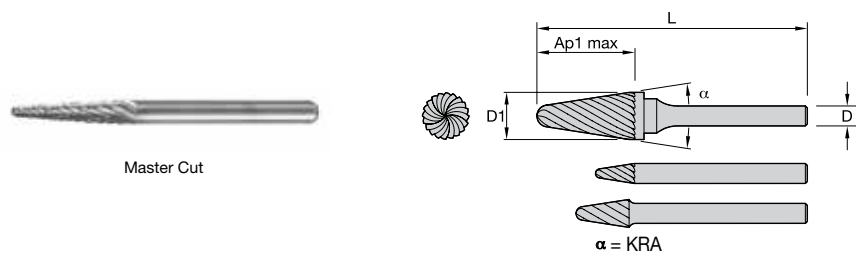

USCTI Number	Master Cut		D1	D	Ap1 max	length L	shank style	KRA
	order #	catalog #						
SL-42M	1977385	M41474	3,0	3,0	12,7	38,1	A	8
SL-3M	1977573	M41478	9,5	6,0	27,0	74,6	C	14
SL-4M	1293770	M41479	12,7	6,0	31,8	76,2	C	14

## Series SL-M Included Angle • Aluminum-Cut Burs • Metric

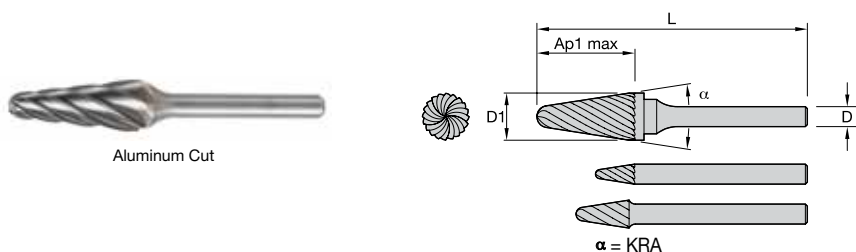

USCTI Number	Aluminum Cut		D1	D	Ap1 max	length L	shank style	KRA
	order #	catalog #						
SL-3M	2978948	M40582	9,5	6,0	27,0	74,6	C	14
SL-4M	2729982	M40584	12,7	6,0	31,8	76,2	C	14

## Series IGT Internal Grinding Tool • Burs • Metric

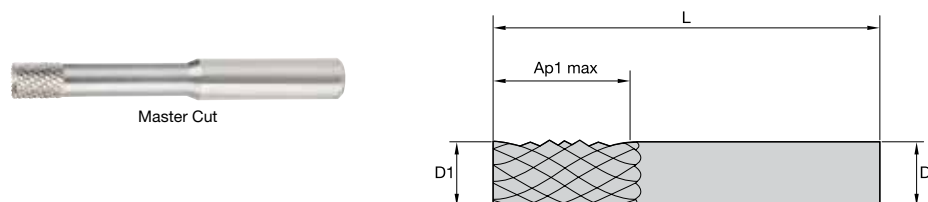

order #	catalog #	D1	D	Ap1 max	length L
					L
2735459	M42008	2,4	3,2	4,0	38,1
2735454	M42009	2,8	3,2	4,8	38,1
2735396	M42022	4,8	4,8	6,4	50,8
2735432	M42014	6,4	6,4	7,9	50,8

Series IGT-EC Internal Grinding Tool • Burs • Metric



Master Cut

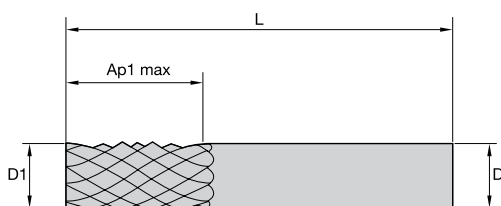

Master Cut		D1	D	Ap1 max	length L
2735391	M42023	1,6	3,2	3,2	38,1
2735381	M42025	2,4	3,2	4,0	38,1
2735371	M42027	3,2	3,2	4,8	38,1
2735320	M42037	4,0	4,8	5,6	50,8
2735310	M42039	4,8	4,8	6,4	50,8
2735361	M42029	5,6	6,4	7,1	50,8
2735352	M42031	6,4	6,4	7,9	50,8
2735346	M42032	7,1	6,4	8,7	63,5
2735341	M42033	7,9	6,4	8,7	63,5
2735331	M42035	9,5	6,4	9,5	63,5

Series CRTF-BE • Burs • Inch



Master Cut

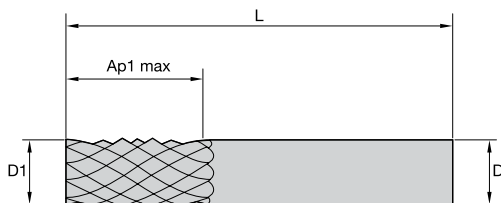

Master Cut		D1	D	Ap1 max	length L
2737535	M34831	1/4	1/4	3/4	2
2737530	M34832	1/4	1/4	3/4	2 1/2
2737521	M34841	3/8	3/8	1	2 1/2
3045679	M34842	1/2	1/2	1	3



## Series CRTF-CC • Burs • Inch

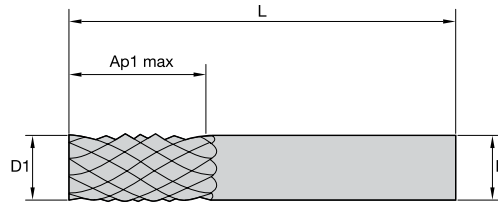
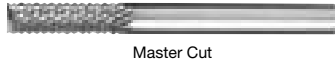

Master Cut		D1	D	Ap1 max	length
order #	catalog #				L
2737583	M34800	1/8	1/8	1/2	1 1/2
2737564	M34810	5/16	5/16	1	2 1/2

## Series CRTF-DP • Burs • Inch

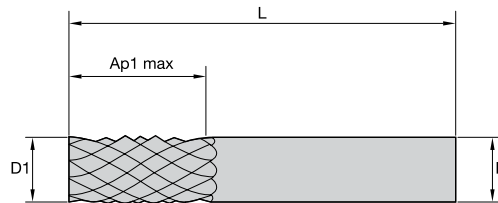

Master Cut		D1	D	Ap1 max	length
order #	catalog #				L
2737511	M34850	1/16	1/8	3/16	1 1/2
2737497	M34860	1/4	1/4	3/4	2
2737492	M34861	1/4	1/4	1	3

Series CRTF-NE • Burs • Inch

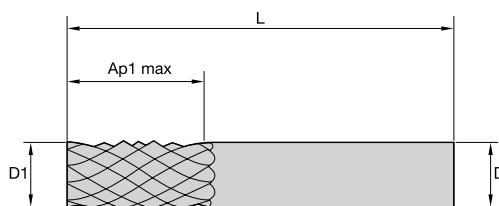

Master Cut		D1	D	Ap1 max	length L
order #	catalog #				
2737449	M34890	1/4	1/4	1	3

Series Bur Sets



order number	catalog number	D1	D	quantity	shank style	cut style	includes
2736246	M40588	1/8	1/8	9	A	Master	SA-42, SA-43, SC-41, SC-42, SD-42, SE-41, SF-42, SG-42, SM-43
2736236	M40591	1/4	1/8	9	B	Master	SA-51, SB-51, SC-51, SD-51, SE-51, SF-51, SG-51, SM-51, SN-51
2736227	M40593	1/4	1/4	8	C	Master	SA-1, SC-1, SD-1, SE-1, SF-1, SG-1, SL-1, SM-2
2736221	M40594	1/2	1/4	8	C	Master	SA-5, SC-5, SD-5, SE-5, SF-5, SG-5, SL-4, SM-5



**HANITA**™



## PRODUCTIVITY

---

Solid end mills in the Hanita™ portfolio achieve exceptional levels of productivity in complex operations at increased cutting parameters.



## DURABILITY

---

End mills in the Hanita portfolio feature optimized geometries capable of peak performance in high-demand machining strategies.



## INNOVATION

---

Hanita is a brand for innovation enthusiasts who are searching for precision-engineered solid carbide end mill solutions.

Hanita **high-performance solid carbide end mill solutions** are developed for customers who have a passion for performance.

Offering a comprehensive range of standard and custom end mills spanning a broad range of diameters and lengths, all boasting **unparalleled metal removal rates** through **innovative geometries**, Hanita delivers not only the tool for the job but **the experience** to develop a solution for the customer.

Hanita solutions are available through WIDIA™ channel partners.



# Solid End Milling

<b>Hanita High-Performance Solid Carbide End Mills .....</b>	<b>B120–B370</b>
SEM Selection Table.....	B120–B159
VariMill XTREME .....	B160–B177
VariMill I.....	B178–B200
VariMill II.....	B202–B228
VariMill III ER.....	B230–B239
VariMill Chip Splitter.....	B240–B248
Roughers.....	B249–B266
Finishers.....	B268–B285
ALUFLASH.....	B286–B310
X-Feed .....	B312–B321
Vision Plus.....	B322–B352
HSS End Mills .....	B354–B370

# SEM Selection Table

## Hanita™ High-Performance Solid Carbide End Mills • Selection Guide • Inch

INDEXABLE MILLING





















SOLID END MILLING

HOLEMAKING

TAPPING





















TURNING

- first choice
- alternate choice

		Hanita Solid End Milling Portfolio						
		VariMill™ XTREME™	VariMill XTREME	VariMill XTREME	VariMill XTREME	VariMill XTREME	VariMill XTREME	VariMill XTREME
								
UOM		Inch	Inch	Inch	Inch	Inch	Inch	Inch
Series		4X0E	4X0E	4X0E	4X0E	4X1E	4X1E	4X1E
Page		B162	B162	B163	B163	B164	B164	B164
Flute		4	4	4	4	4	4	4
Diameter D1		1/8–3/8"	1/2–1"	1/8–3/8"	1/2–1"	5/16"	1/2–1"	5/16"
Shank								
Length of Cut		Regular	Regular	Regular	Regular	Long	Long	Long
Corner Style								
Chamfer Size		–	–	–	–	–	–	–
Radius Sizes		–	–	.015–.030"	.015–.030"	–	–	.015–.030"
Helix Angle		37° / 39°	37° / 39°	37° / 39°	37° / 39°	37° / 39°	37° / 39°	37° / 39°
Center Cutting		Yes	Yes	Yes	Yes	Yes	Yes	Yes
Neck		No	No	No	No	No	No	No
Materials								
P	0	●	●	●	●	●	●	●
	1	●	●	●	●	●	●	●
	2	●	●	●	●	●	●	●
	3	●	●	●	●	●	●	●
	4	●	●	●	●	●	●	●
	5	●	●	●	●	●	●	●
M	1	●	●	●	●	●	●	●
	2	●	●	●	●	●	●	●
	3	●	●	●	●	●	●	●
K	1	●	●	●	●	●	●	●
	2	●	●	●	●	●	●	●
	3	●	●	●	●	●	●	●
N	1							
	2							
	3							
	4							
	5							
S	1	○	○	○	○	○	○	○
	2	○	○	○	○	○	○	○
	3	○	○	○	○	○	○	○
	4	○	○	○	○	○	○	○
H	1	○	○	○	○	○	○	○
	2	○	○	○	○	○	○	○
	3							
	4							

## Hanita™ High-Performance Solid Carbide End Mills • Selection Guide • Inch

- first choice
- alternate choice

		Hanita Solid End Milling Portfolio						
		VariMill™ XTREME™	VariMill XTREME	VariMill XTREME	VariMill XTREME	VariMill XTREME	VariMill XTREME	VariMill I™
								
UOM		Inch	Inch	Inch	Inch	Inch	Inch	Inch
Series		4X1E	4X4E	4X4E	4X4E	4X6E	4X6E	4V05
Page		B165	B165	B165	B166	B167	B167	B180-B182
Flute		4	4	4	4	4	4	4
Diameter D1		1/2–1"	1/8–3/8"	1/8–3/8"	1/2"	3/4–1"	3/4"	1/8–1"
Shank								
Length of Cut		Long	Extended	Extended	Extended	X-Long	X-Long	Regular
Corner Style								
Chamfer Size		–	–	–	–	–	–	–
Radius Sizes		.015–.030"	–	.015"	.015–.030"	–	.015"	–
Helix Angle		37° / 39°	37° / 39°	37° / 39°	37° / 39°	37° / 39°	37° / 39°	38°
Center Cutting		Yes	Yes	Yes	Yes	Yes	Yes	Yes
Neck		No	No	No	No	No	No	No
Materials								
P	0	●	●	●	●	●	●	●
	1	●	●	●	●	●	●	●
	2	●	●	●	●	●	●	●
	3	●	●	●	●	●	●	●
	4	●	●	●	●	●	●	●
	5	●	●	●	●	●	●	●
M	1	●	●	●	●	●	●	●
	2	●	●	●	●	●	●	●
	3	●	●	●	●	●	●	●
K	1	●	●	●	●	●	●	●
	2	●	●	●	●	●	●	●
	3	●	●	●	●	●	●	●
N	1							
	2							
	3							
	4							
	5							
S	1	○	○	○	○	○	○	○
	2	○	○	○	○	○	○	○
	3	○	○	○	○	○	○	○
	4	○	○	○	○	○	○	○
H	1	○	○	○	○	○	○	○
	2	○	○	○	○	○	○	○
	3							
	4							

INDEXABLE MILLING

SOLID END MILLING

HOLEMAKING

TAPPING

TURNING



# SEM Selection Table

## Hanita™ High-Performance Solid Carbide End Mills • Selection Guide • Inch

INDEXABLE MILLING





















SOLID END MILLING

HOLEMAKING

TAPPING

TURNING





















- first choice
- alternate choice

		Hanita Solid End Milling Portfolio						
		VariMill I™	VariMill I	VariMill I	VariMill I	VariMill I	VariMill I	VariMill I
								
UOM		Inch	Inch	Inch	Inch	Inch	Inch	Inch
Series		4V05	4V05	4V05	4V05	4V05	4V15	4V15
Page		B180	B180-B182	B180-B182	B180-B181	B181-B182	B180-B182	B180-B182
Flute		4	4	4	4	4	4	4
Diameter D1		1/8–7/16"	1/8–1"	1/2–1 1/4"	1/2–1 1/4"	1/2–1 1/4"	1/4–3/4"	1/4–3/4"
Shank								
Length of Cut		Regular	Regular	Regular	Regular	Regular	Long	Long
Corner Style								
Chamfer Size		.010–.020"	–	–	.020"	–	–	–
Radius Sizes		–	.015–.090"	–	–	.015–.250"	–	.015–.120"
Helix Angle		38°	38°	38°	38°	38°	38°	38°
Center Cutting		Yes	Yes	Yes	Yes	Yes	Yes	Yes
Neck		No	No	No	No	No	No	No
Materials								
P	0	●	●	●	●	●	●	●
	1	●	●	●	●	●	●	●
	2	●	●	●	●	●	●	●
	3	●	●	●	●	●	●	●
	4	●	●	●	●	●	●	●
	5	●	●	●	●	●	●	●
M	1	●	●	●	●	●	●	●
	2	●	●	●	●	●	●	●
	3	●	●	●	●	●	●	●
K	1	●	●	●	●	●	●	●
	2	●	●	●	●	●	●	●
	3	●	●	●	●	●	●	●
N	1							
	2							
	3							
	4							
	5							
S	1	○	○	○	○	○	○	○
	2	○	○	○	○	○	○	○
	3	○	○	○	○	○	○	○
	4	○	○	○	○	○	○	○
H	1	○	○	○	○	○	○	○
	2	○	○	○	○	○	○	○
	3							
	4							



## Hanita™ High-Performance Solid Carbide End Mills • Selection Guide • Inch

- first choice
- alternate choice

		Hanita Solid End Milling Portfolio						
		VariMill I™	VariMill I	VariMill I	VariMill I	VariMill I	VariMill I	VariMill I
								
UOM		Inch	Inch	Inch	Inch	Inch	Inch	Inch
Series		4V15	4V15	4V15	4V45	4V45	4V45	4V45
Page		B181-B182	B181-B182	B181-B182	B180-B181	B180	B180-B181	B180-B182
Flute		4	4	4	4	4	4	4
Diameter D1		1/2-1"	5/8-1"	1/2-1"	1/8-1/2"	1/8-7/16"	3/16-1/2"	1/2-3/4"
Shank								
Length of Cut		Long	Long	Long	Short	Short	Short	Short
Corner Style								
Chamfer Size		-	.010-.020"	-	-	.010-.020"	-	-
Radius Sizes		-	-	.030-.060"	-	-	.015-.030"	-
Helix Angle		38°	38°	38°	38°	38°	38°	38°
Center Cutting		Yes	Yes	Yes	Yes	Yes	Yes	Yes
Neck		No	No	No	No	No	No	No
Materials								
P	0	●	●	●	●	●	●	●
	1	●	●	●	●	●	●	●
	2	●	●	●	●	●	●	●
	3	●	●	●	●	●	●	●
	4	●	●	●	●	●	●	●
	5	●	●	●	●	●	●	●
M	1	●	●	●	●	●	●	●
	2	●	●	●	●	●	●	●
	3	●	●	●	●	●	●	●
K	1	●	●	●	●	●	●	●
	2	●	●	●	●	●	●	●
	3	●	●	●	●	●	●	●
N	1							
	2							
	3							
	4							
	5							
S	1	○	○	○	○	○	○	○
	2	○	○	○	○	○	○	○
	3	○	○	○	○	○	○	○
	4	○	○	○	○	○	○	○
H	1	○	○	○	○	○	○	○
	2	○	○	○	○	○	○	○
	3							
	4							

INDEXABLE MILLING

SOLID END MILLING

HOLEMAKING

TAPPING

TURNING

## Hanita™ High-Performance Solid Carbide End Mills • Selection Guide • Inch

INDEXABLE MILLING





















SOLID END MILLING

HOLEMAKING

TAPPING

TURNING

- first choice
- alternate choice

		Hanita Solid End Milling Portfolio						
		VariMill I™	VariMill I	VariMill I	VariMill I	VariMill I	VariMill I	VariMill I
								
UOM		Inch	Inch	Inch	Inch	Inch	Inch	Inch
Series		4V45	4V45	4V65	4V65	4V65	4V65	4V65
Page		B180-B182	B180-B182	B181-B182	B181-B182	B181-B182	B181-B182	B181-B182
Flute		4	4	4	4	4	4	4
Diameter D1		1/2-3/4"	1/2-3/4"	5/8-3/4"	5/8-3/4"	1/2-1"	1/2-1"	1/2-1"
Shank								
Length of Cut		Short	Short	Extended	Extended	Extended	Extended	Extended
Corner Style								
Chamfer Size		.010-.020"	—	—	—	—	.010-.020"	—
Radius Sizes		—	.030-.120"	—	.030-.120"	—	—	.030-.060"
Helix Angle		38°	38°	38°	38°	38°	38°	38°
Center Cutting		Yes	Yes	Yes	Yes	Yes	Yes	Yes
Neck		No	No	No	No	No	No	No
Materials								
P	0	●	●	●	●	●	●	●
	1	●	●	●	●	●	●	●
	2	●	●	●	●	●	●	●
	3	●	●	●	●	●	●	●
	4	●	●	●	●	●	●	●
	5	●	●	●	●	●	●	●
M	1	●	●	●	●	●	●	●
	2	●	●	●	●	●	●	●
	3	●	●	●	●	●	●	●
K	1	●	●	●	●	●	●	●
	2	●	●	●	●	●	●	●
	3	●	●	●	●	●	●	●
N	1							
	2							
	3							
	4							
	5							
S	1	○	○	○	○	○	○	○
	2	○	○	○	○	○	○	○
	3	○	○	○	○	○	○	○
	4	○	○	○	○	○	○	○
H	1	○	○	○	○	○	○	○
	2	○	○	○	○	○	○	○
	3							
	4							

Hanita™ High-Performance Solid Carbide End Mills • Selection Guide • Inch

INDEXABLE MILLING





















SOLID END MILLING

HOLEMAKING

TAPPING

TURNING

- first choice
- alternate choice

		Hanita Solid End Milling Portfolio						
		VariMill I™	VariMill I	VariMill I	VariMill I	VariMill I	VariMill I	VariMill I
								
UOM		Inch	Inch	Inch	Inch	Inch	Inch	Inch
Series		4V0T	4V0T	4VP5	4VP5	4VPT	4VPT	4VN5
Page		B183	B183	B183	B183	B184	B184	B185
Flute		4	4	4	4	4	4	4
Diameter D1		1/2"	1/2–3/4"	1/4–1"	1/4–1"	1/2–3/4"	1/2–3/4"	1/4–3/8"
Shank								
Length of Cut		Regular	Regular	Regular	Regular	Regular	Regular	Regular
Corner Style								
Chamfer Size		—	.020"	—	.016–.020"	—	.020"	.016–.020"
Radius Sizes		—	—	—	—	—	—	—
Helix Angle		38°	38°	38°	38°	38°	38°	38°
Center Cutting		Yes	Yes	Yes	Yes	Yes	Yes	Yes
Neck		No	No	No	No	No	No	Yes
Materials								
P	0	○	○	●	●	○	○	●
	1	○	○	●	●	○	○	●
	2	○	○	●	●	○	○	●
	3	○	○	●	●	○	○	●
	4	○	○	●	●	○	○	●
	5	●	●	●	●	●	●	●
M	1	●	●	●	●	●	●	●
	2	●	●	●	●	●	●	●
	3	●	●	●	●	●	●	●
K	1	○	○	●	●	○	○	●
	2	○	○	●	●	○	○	●
	3	○	○	●	●	○	○	●
N	1							
	2							
	3							
	4							
	5							
S	1	●	●	○	○	●	●	○
	2	●	●	○	○	●	●	○
	3	●	●	○	○	●	●	○
	4	●	●	○	○	●	●	○
H	1	○	○	○	○	○	○	○
	2	○	○	○	○	○	○	○
	3							
	4							

# SEM Selection Table

## Hanita™ High-Performance Solid Carbide End Mills • Selection Guide • Inch

INDEXABLE MILLING





















SOLID END MILLING

HOLEMAKING

TAPPING

TURNING

- first choice
- alternate choice

		Hanita Solid End Milling Portfolio						
		VariMill I™	VariMill I	VariMill I	VariMill I	VariMill II™	VariMill II	VariMill II
								
UOM		Inch	Inch	Inch	Inch	Inch	Inch	Inch
Series		4VN5	4V00	4V00	4VP0	5V0C	5V0C	5V0C
Page		B185	B186	B186	B186	B204-B205	B204-B205	B204-B205
Flute		4	4	4	4	5	5	5
Diameter D1		1/4-1"	1/8-7/16"	1/2-1 1/4"	1/4-1"	3/16-1"	3/16-1"	1/2-1"
Shank								
Length of Cut		Regular	Regular	Regular	Regular	Regular	Regular	Regular
Corner Style								
Chamfer Size		-	-	-	-	-	-	-
Radius Sizes		.015-.120"	-	-	-	-	.015-.120"	-
Helix Angle		38°	38°	38°	38°	38°	38°	38°
Center Cutting		Yes	Yes	Yes	Yes	Yes	Yes	Yes
Neck		Yes	No	No	No	No	No	No
Materials								
P	0	●	●	●	●	●	●	●
	1	●	●	●	●	●	●	●
	2	●	●	●	●	●	●	●
	3	●	●	●	●	●	●	●
	4	●	●	●	●	●	●	●
	5	●	●	●	●	●	●	●
M	1	●	●	●	●	○	○	○
	2	●	●	●	●	○	○	○
	3	●	●	●	●	○	○	○
K	1	●	●	●	●	●	●	●
	2	●	●	●	●	●	●	●
	3	●	●	●	●	●	●	●
N	1							
	2							
	3							
	4							
	5							
S	1	○	○	○	○	○	○	○
	2	○	○	○	○	○	○	○
	3	○	○	○	○	○	○	○
	4	○	○	○	○	○	○	○
H	1	○	○	○	○	○	○	○
	2	○	○	○	○	○	○	○
	3							
	4							



Hanita™ High-Performance Solid Carbide End Mills • Selection Guide • Inch

INDEXABLE MILLING





















SOLID END MILLING

HOLEMAKING

TAPPING

TURNING

- first choice
- alternate choice

		Hanita Solid End Milling Portfolio						
		VariMill II™	VariMill II	VariMill II	VariMill II	VariMill II	VariMill II	VariMill II
								
UOM		Inch	Inch	Inch	Inch	Inch	Inch	Inch
Series		5V0C	5VNC	5VNC	5V0S	5V0S	5V0S	5VNS
Page		B204-B205	B206	B206	B207	B207	B207	B208
Flute		5	5	5	5	5	5	5
Diameter D1		1/2–1"	1/4–1"	1/2–1"	3/16–3/4"	3/16–1"	1/2–3/4"	3/8–1"
Shank								
Length of Cut		Regular	Regular	Regular	Regular	Regular	Regular	Regular
Corner Style								
Chamfer Size								
Radius Sizes		.015–.120"	.015–.030"	.030	—	.015–.120"	.030–.120"	.015–.030"
Helix Angle		38°	38°	38°	38°	38°	38°	38°
Center Cutting		Yes	Yes	Yes	Yes	Yes	Yes	Yes
Neck		No	Yes	Yes	No	No	No	No
Materials								
P	0	●	●	●	●	●	●	●
	1	●	●	●	●	●	●	●
	2	●	●	●	●	●	●	●
	3	●	●	●	●	●	●	●
	4	●	●	●	●	●	●	●
	5	●	●	●	●	●	●	●
M	1	○	○	○	○	○	○	○
	2	○	○	○	○	○	○	○
	3	○	○	○	○	○	○	○
K	1	●	●	●	●	●	●	●
	2	●	●	●	●	●	●	●
	3	●	●	●	●	●	●	●
N	1							
	2							
	3							
	4							
	5							
S	1	○	○	○	○	○	○	○
	2	○	○	○	○	○	○	○
	3	○	○	○	○	○	○	○
	4	○	○	○	○	○	○	○
H	1	○	○	○	○	○	○	○
	2	○	○	○	○	○	○	○
	3							
	4							

# SEM Selection Table

## Hanita™ High-Performance Solid Carbide End Mills • Selection Guide • Inch

INDEXABLE MILLING





















SOLID END MILLING

HOLEMAKING

TAPPING

TURNING





















- first choice
- alternate choice

		Hanita Solid End Milling Portfolio						
		VariMill II™	VariMill II	VariMill II	VariMill II	VariMill II	VariMill II	VariMill II
								
UOM		Inch	Inch	Inch	Inch	Inch	Inch	Inch
Series		5V0E	5V0E	5V0E	5V0E	5V0E	5V0E	5VNE
Page		B209-B211	B209-B210	B209-B211	B209-B211	B209-B210	B209-B210	B212-B213
Flute		5	5	5	5	5	5	5
Diameter D1		3/16-1"	3/16-1"	1/2-1 1/4"	1/2-1 1/4"	1/2-1"	1/2-1"	3/8-1 1/4"
Shank								
Length of Cut		Regular	Regular	Regular	Regular	Regular	Regular	Regular
Corner Style								
Chamfer Size		-	-	-	-	-	-	-
Radius Sizes		-	.015-.120"	-	.015-.120"	-	.015-.120"	-
Helix Angle		38°	38°	38°	38°	38°	38°	38°
Center Cutting		Yes	Yes	Yes	Yes	Yes	Yes	Yes
Neck		No	No	No	No	No	No	Yes
Materials								
P	0							
	1							
	2							
	3							
	4							
	5	●	●	●	●	●	●	●
M	6	●	●	●	●	●	●	●
	1	●	●	●	●	●	●	●
	2	●	●	●	●	●	●	●
K	3	●	●	●	●	●	●	●
	1							
	2							
N	3							
	1							
	2							
	3							
	4							
S	5							
	1	●	●	●	●	●	●	●
	2	●	●	●	●	●	●	●
	3	●	●	●	●	●	●	●
H	4	●	●	●	●	●	●	●
	1							
	2							
	3							
	4							



Hanita™ High-Performance Solid Carbide End Mills • Selection Guide • Inch

● first choice  
○ alternate choice

		Hanita Solid End Milling Portfolio						
		VariMill II™	VariMill II	VariMill II	VariMill II	VariMill II	VariMill II	VariMill III™
								
UOM		Inch	Inch	Inch	Inch	Inch	Inch	Inch
Series		5VNE	5VNE	5VNE	5VNE	5W1S	5W1S	7V0E
Page		B212-B213	B212-B213	B212-B213	B212-B213	B214	B214	B232
Flute		5	5	5	5	5	5	7
Diameter D1		1/4-1"	1/2-1"	1/2-1"	1/2-1"	1/4-1"	1/4-1"	3/8-3/4"
Shank								
Length of Cut		Regular	Regular	Regular	Regular	X-Long	X-Long	Regular
Corner Style								
Chamfer Size		-	-	-	-	-	-	-
Radius Sizes		.015-.120"	.030"	-	.015-.120"	-	.015-.120"	-
Helix Angle		38°	38°	38°	38°	38°	43°	38°
Center Cutting		Yes	Yes	Yes	Yes	Yes	Yes	Yes
Neck		Yes	Yes	Yes	Yes	No	No	No
Materials								
P	0					●	●	
	1					●	●	
	2					●	●	
	3					●	●	
	4					●	●	
	5	●	●	●	●	●	●	●
M	1	●	●	●	●	●	●	●
	2	●	●	●	●	●	●	●
	3	●	●	●	●	●	●	●
K	1					●	●	
	2					●	●	
	3					●	●	
N	1							
	2							
	3							
	4							
	5							
S	1	●	●	●	●	●	●	●
	2	●	●	●	●	●	●	●
	3	●	●	●	●	●	●	●
	4	●	●	●	●	●	●	●
H	1					●	●	
	2					●	●	
	3					●	●	
	4					●	●	

INDEXABLE MILLING

SOLID END MILLING

HOLEMAKING

TAPPING

TURNING



# SEM Selection Table

## Hanita™ High-Performance Solid Carbide End Mills • Selection Guide • Inch

INDEXABLE MILLING





















SOLID END MILLING

HOLEMAKING

TAPPING

TURNING

- first choice
- alternate choice

		Hanita Solid End Milling Portfolio						
		VariMill III™	VariMill III	VariMill III	VariMill III	VariMill III	VariMill III	VariMill III
								
UOM		Inch	Inch	Inch	Inch	Inch	Inch	Inch
Series		7V0E	7V1E	7V1E	7V1E	7V2E	7V2E	7VNX
Page		B232	B232	B232	B232	B232	B232	B233
Flute		7	7	7	7	7	7	7
Diameter D1		3/8–3/4"	3/8–3/4"	3/8–1"	3/4–1"	3/8"	1/2–1"	3/8–1"
Shank								
Length of Cut		Regular	Long	Long	Long	Extended	Extended	Regular
Corner Style								
Chamfer Size		–	–	–	–	–	–	–
Radius Sizes		.015–.060"	–	.015–.120"	.030–.0120"	.015–.030"	.030–.120"	.015–.120"
Helix Angle		38°	38°	38°	38°	38°	38°	38°
Center Cutting		Yes	Yes	Yes	Yes	Yes	Yes	No
Neck		No	No	No	No	No	No	Yes
Materials								
P	0							
	1							
	2							
	3							
	4							
	5	●	●	●	●	●	●	●
M	1	●	●	●	●	●	●	●
	2	●	●	●	●	●	●	●
	3	●	●	●	●	●	●	●
K	1							
	2							
	3							
N	1							
	2							
	3							
	4							
	5							
S	1	●	●	●	●	●	●	●
	2	●	●	●	●	●	●	●
	3	●	●	●	●	●	●	●
	4	●	●	●	●	●	●	●
H	1							
	2							
	3							
	4							



Hanita™ High-Performance Solid Carbide End Mills • Selection Guide • Inch

INDEXABLE MILLING





















SOLID END MILLING

HOLEMAKING

TAPPING

TURNING

- first choice
- alternate choice

		Hanita Solid End Milling Portfolio						
		VariMill III™	VariMill II™	VariMill II	VariMill II	VariMill III	VariMill III	VariMill III
								
UOM		Inch	Inch	Inch	Inch	Inch	Inch	Inch
Series		7VNX	570T	571T	572T	770T	771T	772T
Page		B233	B242	B242	B242	B243	B243	B244
Flute		7	5	5	5	7	7	7
Diameter D1		3/4–1"	1/2–1"	1/2–1"	1/2–1"	1/2–1"	1/2–1"	1/2–1"
Shank								
Length of Cut		Regular	Regular	Long	Extended	Regular	Long	Extended
Corner Style								
Chamfer Size		–	–	–	–	–	–	–
Radius Sizes		.030–.120"	.030"	.030"	.030"	.030–.120"	.030–.120"	.030–.120"
Helix Angle		38°	38°	38°	38°	38°	38°	38°
Center Cutting		No	Yes	Yes	Yes	Yes	Yes	Yes
Neck		Yes	No	No	No	No	No	No
Materials								
P	0		●	●	●	○	○	○
	1		●	●	●	○	○	○
	2		●	●	●	○	○	○
	3		●	●	●	○	○	○
	4		●	●	●	○	○	○
	5	●	●	●	●	●	●	●
M	1	●	●	●	●	●	●	●
	2	●	●	●	●	●	●	●
	3	●	●	●	●	●	●	●
K	1							
	2							
	3							
N	1							
	2							
	3							
	4							
	5							
S	1	●	○	○	○	●	●	●
	2	●	○	○	○	●	●	●
	3	●	○	○	○	●	●	●
	4	●	○	○	○	●	●	●
H	1							
	2							
	3							
	4							

# SEM Selection Table

## Hanita™ High-Performance Solid Carbide End Mills • Selection Guide • Inch

INDEXABLE MILLING





















SOLID END MILLING

HOLEMAKING

TAPPING

TURNING





















- first choice
- alternate choice

		Hanita Solid End Milling Portfolio						
		VariMill III™	Roughers	Roughers	Roughers	Roughers	Roughers	Roughers
								
UOM		Inch	Inch	Inch	Inch	Inch	Inch	Inch
Series		773T	4S0R	4S0R	4M4R	4M4R	4M0R	4M0R
Page		B244	B250	B250	B250	B250	B250	B250
Flute		7	3 - 4	3 - 4 - 5	3 - 4	4 - 6	4	4 - 6
Diameter D1		1/2–1"	1/4–5/16"	1/4–1"	1/4–3/8"	1/2–1"	1/4–3/8"	1/2–1"
Shank								
Length of Cut		X-Long	Regular	Regular	Regular	Regular	Regular	Regular
Corner Style								
Chamfer Size		–	.012"	.012–.020"	–	–	–	–
Radius Sizes		.030–.120"	–	–	.030"	.050"	.030"	.050"
Helix Angle		38°	20°	20°	40°	40°	40°	40°
Center Cutting		Yes	Yes	Yes	Yes	Yes	Yes	Yes
Neck		No	No	No	No	No	No	No
Materials								
P	0	○	●	●	●	●	●	●
	1	○	●	●	●	●	●	●
	2	○	●	●	●	●	●	●
	3	○	●	●	●	●	●	●
	4	○	●	●	●	●	●	●
	5	●	●	●	●	●	●	●
M	1	●	○	○	○	○	○	○
	2	●	○	○	○	○	○	○
	3	●	○	○	○	○	○	○
K	1		●	●	●	●	●	●
	2		●	●	●	●	●	●
	3		●	●	●	●	●	●
N	1							
	2							
	3							
	4							
	5							
S	1	●	○	○	○	○	○	○
	2	●	○	○	○	○	○	○
	3	●	○	○	○	○	○	○
	4	●	○	○	○	○	○	○
H	1		○	○	○	○	○	○
	2		○	○	○	○	○	○
	3							
	4							



Hanita™ High-Performance Solid Carbide End Mills • Selection Guide • Inch

● first choice  
○ alternate choice

		Hanita Solid End Milling Portfolio						
		Roughers	Roughers	Roughers	Roughers	Roughers	Roughers	Roughers
								
UOM		Inch	Inch	Inch	Inch	Inch	Inch	Inch
Series		4QN3	4Q43	4Q43	4Q05	4Q03	4Q03	4U50
Page		B251	B251	B251	B251	B251	B251	B252
Flute		3	3	3	3	3	3	4 - 6
Diameter D1		1/2–1"	3/16"	3/8–3/4"	1"	3/16"	1/4–1"	1/4–1"
Shank								
Length of Cut		Regular	Regular	Regular	Regular	Regular	Regular	Short
Corner Style								
Chamfer Size		–	–	–	–	–	–	–
Radius Sizes		.020–.030"	.010"	.020–.030"	.030"	.010"	.020–.030"	.030–.050"
Helix Angle		35°	35°	35°	35°	35°	35°	45°
Center Cutting		Yes	Yes	Yes	Yes	Yes	Yes	Yes
Neck		Yes	No	No	No	No	No	No
Materials								
P	0	●	●	●	●	●	●	
	1	●	●	●	●	●	●	
	2	●	●	●	●	●	●	
	3	●	●	●	●	●	●	
	4	●	●	●	●	●	●	
	5	●	●	●	●	●	●	●
M	1	○	○	○	○	○	○	●
	2	○	○	○	○	○	○	●
	3	○	○	○	○	○	○	●
K	1	●	●	●	●	●	●	
	2	●	●	●	●	●	●	
	3	●	●	●	●	●	●	
N	1							
	2							
	3							
	4							
	5							
S	1	○	○	○	○	○	○	●
	2	○	○	○	○	○	○	●
	3	○	○	○	○	○	○	●
	4	○	○	○	○	○	○	●
H	1	○	○	○	○	○	○	
	2	○	○	○	○	○	○	
	3							
	4							

INDEXABLE MILLING

SOLID END MILLING

HOLEMAKING

TAPPING

TURNING

# SEM Selection Table

## Hanita™ High-Performance Solid Carbide End Mills • Selection Guide • Inch

INDEXABLE MILLING

SOLID END MILLING

HOLEMAKING

TAPPING

TURNING

- first choice
- alternate choice

		Hanita Solid End Milling Portfolio						
		Roughers	Roughers	Finishers	Finishers	Finishers	Finishers	Finishers
UOM		Inch	Inch	Inch	Inch	Inch	Inch	Inch
Series		4U80	4U80	4S07	4S67	4S47	4S27	4S17
Page		B252	B252	B270	—	—	—	—
Flute		4 - 6	4 - 6	6	6	6	6	6
Diameter D1		1/4–1"	1/2–1"	1/4–1"	1"	1/4–3/4"	3/4–1"	1/4–1"
Shank								
Length of Cut		Regular	Regular	Regular	Regular	Regular	Regular	Regular
Corner Style								
Chamfer Size								
Radius Sizes		.030–.050"	.030–.050"	—	—	—	—	—
Helix Angle		45°	45°	45°	45°	45°	45°	45°
Center Cutting		Yes	Yes	Yes	Yes	Yes	Yes	Yes
Neck		No	No	No	No	No	No	No
Materials								
P	0			●	●	●	●	●
	1			●	●	●	●	●
	2			●	●	●	●	●
	3			●	●	●	●	●
	4			●	●	●	●	●
	5	●	●	●	●	●	●	●
M	1	●	●	●	●	●	●	●
	2	●	●	●	●	●	●	●
	3	●	●	●	●	●	●	●
K	1			●	●	●	●	●
	2			●	●	●	●	●
	3			●	●	●	●	●
N	1							
	2							
	3							
	4							
	5							
S	1	●	●	●	●	●	●	●
	2	●	●	●	●	●	●	●
	3	●	●	●	●	●	●	●
	4	●	●	●	●	●	●	●
H	1			●	●	●	●	●
	2			●	●	●	●	●
	3			●	●	●	●	●
	4			●	●	●	●	●

Hanita™ High-Performance Solid Carbide End Mills • Selection Guide • Inch

INDEXABLE MILLING





















SOLID END MILLING

HOLEMAKING

TAPPING

TURNING

- first choice
- alternate choice

		Hanita Solid End Milling Portfolio						
		Finishers	Finishers	Finishers	Finishers	Finishers	Finishers	Finishers
								
UOM		Inch	Inch	Inch	Inch	Inch	Inch	Inch
Series		4S07	4C43	4C03	4C45	4C15	4C05	4S0F
Page		B270	B271	B271	—	B271	B271	B272
Flute		6	3	3	5	5	5	8
Diameter D1		1/4–3/4"	3/16–1/4"	1/8–1/2"	1/4–1/2"	1/4–1"	1/8–3/4"	3/4"
Shank								
Length of Cut		Regular	Regular	Regular	Regular	Regular	Regular	Regular
Corner Style								
Chamfer Size		—	—	—	—	—	—	—
Radius Sizes		—	.010–.030"	.010–.030"	—	—	—	—
Helix Angle		45°	45°	45°	45°	45°	45°	45°
Center Cutting		Yes	Yes	Yes	Yes	Yes	Yes	Yes
Neck		No	No	No	No	No	No	No
Materials								
P	0	●	●	●	●	●	●	●
	1	●	●	●	●	●	●	●
	2	●	●	●	●	●	●	●
	3	●	●	●	●	●	●	●
	4	●	●	●	●	●	●	●
	5	●	●	●	●	●	●	●
M	1	●	●	●	●	●	●	●
	2	●	●	●	●	●	●	●
	3	●	●	●	●	●	●	●
K	1	●	●	●	●	●	●	●
	2	●	●	●	●	●	●	●
	3	●	●	●	●	●	●	●
N	1							
	2							
	3							
	4							
	5							
S	1	●	●	●	●	●	●	●
	2	●	●	●	●	●	●	●
	3	●	●	●	●	●	●	●
	4	●	●	●	●	●	●	●
H	1	●	●	●	●	●	●	●
	2	●	●	●	●	●	●	●
	3	●	●	●	●	●	●	●
	4	●	●	●	●	●	●	●

## Hanita™ High-Performance Solid Carbide End Mills • Selection Guide • Inch

INDEXABLE MILLING





















SOLID END MILLING

HOLEMAKING

TAPPING





















TURNING

- first choice
- alternate choice

		Hanita Solid End Milling Portfolio						
		ALUFLASH™	ALUFLASH	ALUFLASH	ALUFLASH	ALUFLASH	ALUFLASH	ALUFLASH
								
<b>UOM</b>		Inch	Inch	Inch	Inch	Inch	Inch	Inch
<b>Series</b>		2A09	2A09	2A19	2A19	2AN9	2AN9	2AL9
<b>Page</b>		B288	B288	B289	B289	B290	B290	B293
<b>Flute</b>		2	2	2	2	2	2	2
<b>Diameter D1</b>		1/8–1"	1/8–1"	1/8–1/2"	1/8–1/2"	1/8–1"	1/8–1"	1/4–1"
<b>Shank</b>								
<b>Length of Cut</b>		Regular	Regular	Long	Long	Regular	Regular	Long
<b>Corner Style</b>								
<b>Chamfer Size</b>		–	–	–	–	–	–	–
<b>Radius Sizes</b>		–	.015–.020"	–	.015–.030"	–	.015–.060"	–
<b>Helix Angle</b>		33°	33°	33°	33°	33°	33°	33°
<b>Center Cutting</b>		Yes	Yes	Yes	Yes	Yes	Yes	Yes
<b>Neck</b>		No	No	No	No	Yes	Yes	Yes
<b>Materials</b>								
<b>P</b>	0							
	1							
	2							
	3							
	4							
	5							
<b>M</b>	1							
	2							
	3							
<b>K</b>	1							
	2							
	3							
<b>N</b>	1	●	●	●	●	●	●	●
	2	●	●	●	●	●	●	●
	3	●	●	●	●	●	●	●
	4	●	●	●	●	●	●	●
	5	●	●	●	●	●	●	●
<b>S</b>	1							
	2							
	3							
	4							
<b>H</b>	1							
	2							
	3							
	4							

## Hanita™ High-Performance Solid Carbide End Mills • Selection Guide • Inch

- first choice
- alternate choice

		Hanita Solid End Milling Portfolio						
		ALUFLASH™	ALUFLASH	ALUFLASH	ALUFLASH	ALUFLASH	ALUFLASH	ALUFLASH
								
UOM		Inch	Inch	Inch	Inch	Inch	Inch	Inch
Series		2AL9	2AF9	2AF9	3A09	3A09	3A19	3A19
Page		B293	B292	B292	B293	B293	B294	B294
Flute		2	2	2	3	3	3	3
Diameter D1		3/16–1"	1/8–1"	1/8–1"	3/16–1"	3/16–1"	3/16–1"	3/16–1"
Shank								
Length of Cut		Long	Extended	Extended	Regular	Regular	Long	Long
Corner Style								
Chamfer Size		–	–	–	–	–	–	–
Radius Sizes		.015–.060"	–	.015–.060"	–	.015–.250"	–	.015–.250"
Helix Angle		33°	33°	33°	37° / 39°	37° / 39°	37° / 39°	37° / 39°
Center Cutting		Yes	Yes	Yes	Yes	Yes	Yes	Yes
Neck		Yes	Yes	Yes	No	No	No	No
Materials								
P	0							
	1							
	2							
	3							
	4							
	5							
M	1							
	2							
	3							
K	1							
	2							
	3							
N	1	●	●	●	●	●	●	●
	2	●	●	●	●	●	●	●
	3	●	●	●	●	●	●	●
	4	●	●	●	●	●	●	●
	5	●	●	●	●	●	●	●
S	1							
	2							
	3							
	4							
H	1							
	2							
	3							
	4							

INDEXABLE MILLING

SOLID END MILLING

HOLEMAKING

TAPPING

TURNING



## Hanita™ High-Performance Solid Carbide End Mills • Selection Guide • Inch





















INDEXABLE MILLING

SOLID END MILLING

HOLEMAKING





















TAPPING

TURNING

		Hanita Solid End Milling Portfolio						
		ALUFLASH™	ALUFLASH	ALUFLASH	ALUFLASH	ALUFLASH	ALUFLASH	ALUFLASH
								
● first choice ○ alternate choice								
UOM		Inch	Inch	Inch	Inch	Inch	Inch	Inch
Series		3A29	3A29	3AN9	3AN9	3AF9	3AF9	3AL9
Page		B295	B295	B296	B296	B297	B297	B298
Flute		3	3	3	3	3	3	3
Diameter D1		1/4–1"	1/4–1"	3/16–1"	3/16–1"	3/16–1"	3/16–1"	3/16–1"
Shank								
Length of Cut		Extended	Extended	Regular	Regular	Long	Long	Extended
Corner Style								
Chamfer Size		–	–	–	–	–	–	–
Radius Sizes		–	.015–.120"	–	.015–.060"	–	.015–.060"	–
Helix Angle		37° / 39°	37° / 39°	37° / 39°	37° / 39°	37° / 39°	37° / 39°	37° / 39°
Center Cutting		Yes	Yes	Yes	Yes	Yes	Yes	Yes
Neck		No	No	Yes	Yes	Yes	Yes	Yes
Materials								
P	0							
	1							
	2							
	3							
	4							
	5							
M	1							
	2							
	3							
K	1							
	2							
	3							
N	1	●	●	●	●	●	●	●
	2	●	●	●	●	●	●	●
	3	●	●	●	●	●	●	●
	4	●	●	●	●	●	●	●
	5	●	●	●	●	●	●	●
S	1							
	2							
	3							
	4							
H	1							
	2							
	3							
	4							

## Hanita™ High-Performance Solid Carbide End Mills • Selection Guide • Inch

- first choice
- alternate choice

		Hanita Solid End Milling Portfolio						
		ALUFLASH™	X-Feed™	X-Feed	X-Feed	Vision Plus™	Vision Plus	Vision Plus
								
UOM		Inch	Inch	Inch	Inch	Inch	Inch	Inch
Series		3AL9	7FN6	7FNS	7FN7	7S05	7S15	7S25
Page		B298	B314	B314	B316	B324	B324	B324
Flute		3	6	6	6	4	4 - 5 - 6	4 - 5 - 6
Diameter D1		3/16–1"	1/4–3/4"	1/4–1"	3/8–3/4"	1/4–1/2"	1/4–3/4"	5/16–1"
Shank								
Length of Cut		Extended	Regular	Regular	Regular	Regular	Long	Extended
Corner Style								
Chamfer Size		–	–	–	–	–	–	–
Radius Sizes		.015–.060"	–	–	–	–	–	–
Helix Angle		37° / 39°	20°	20°	20°	50°	50°	50°
Center Cutting		Yes	Yes	Yes	Yes	Yes	Yes	Yes
Neck		Yes	Yes	Yes	Yes	No	No	No
Materials								
P	0		●					
	1		●					
	2		●					
	3		●					
	4		●					
	5		●					
M	1			●				
	2			●				
	3			●				
K	1							
	2							
	3							
N	1	●						
	2	●						
	3	●						
	4	●						
	5	●						
S	1			●				
	2			●				
	3			●				
	4			●				
H	1		●		●	●	●	●
	2		●		●	●	●	●
	3				●	●	●	●
	4				●	●	●	●

INDEXABLE MILLING

SOLID END MILLING

HOLEMAKING

TAPPING

TURNING

# SEM Selection Table

## Hanita™ High-Performance Solid Carbide End Mills • Selection Guide • Inch

INDEXABLE MILLING





















SOLID END MILLING

HOLEMAKING

TAPPING





















TURNING

- first choice
- alternate choice

		Hanita Solid End Milling Portfolio						
		Vision Plus™	Vision Plus	HSS Roughers	HSS Roughers	HSS Roughers	HSS Roughers	HSS Roughers
								
UOM		Inch	Inch	Inch	Inch	Inch	Inch	Inch
Series		7S7R	7S5F	6A0R	6T0R	6T1R	6T3R	6ANR
Page		B325	B325	B356	B356	B356	B356	B357
Flute		4 - 6	4	3	4 - 5 - 6	4 - 5 - 6	4 - 5 - 6	3
Diameter D1		3/8–3/4"	1/8–1/2"	1/2–1 1/4"	1/2–1 1/2"	1/2–1 1/4"	3/4–1 1/2"	1/2–1"
Shank								
Length of Cut		Regular	Regular	Regular	Regular	Long	Extended	Regular
Corner Style								
Chamfer Size				.014–.020"	.035–.060"	.035–.060"	.050–.060"	.015–.020"
Radius Sizes		.030–.050"						
Helix Angle		45°	15°	35°	35°	35°	35°	35°
Center Cutting		Yes	Yes	Yes	Yes	Yes	Yes	Yes
Neck		No	No	No	No	No	No	Yes
Materials								
P	0							
	1							
	2							
	3							
	4							
	5							
M	1							
	2							
	3							
K	1							
	2							
	3							
N	1			•				•
	2			•				•
	3			•				•
	4			•				•
	5			•				•
S	1				•	•	•	
	2				•	•	•	
	3				•	•	•	
	4				•	•	•	
H	1	•	•					
	2	•	•					
	3	•	•					
	4	•	•					

Hanita™ High-Performance Solid Carbide End Mills • Selection Guide • Inch

- first choice
- alternate choice

		Hanita Solid End Milling Portfolio						
		HSS Roughers	HSS ER Rougher	WavCut I™	WavCut I	WavCut I	WavCut I	WavCut I
								
UOM		Inch	Inch	Inch	Inch	Inch	Inch	Inch
Series		6TNR	620E	620W	621W	622W	623W	625W
Page		B357	B358	B359	B359	B359	B359	B359
Flute		4 - 5 - 6	6	4 - 6	4	6	4 - 6	6
Diameter D1		5/8–1 1/4"	1 1/4–2"	3/4–1 1/4"	1–1 1/2"	1 1/4"	1–1 1/4"	2"
Shank								
Length of Cut		Regular	Regular	Regular	Extended	Regular	Long	Regular
Corner Style								
Chamfer Size		.050–.060"		.040"	.040"	.040"	.040"	.040"
Radius Sizes			.060–.120"					
Helix Angle		35°	38°	35°	35°	35°	35°	35°
Center Cutting		Yes	Yes	Yes	Yes	Yes	Yes	Yes
Neck		Yes	No	No	No	No	No	No
Materials								
P	0							
	1							
	2							
	3							
	4							
	5							
	6							
M	1		●	●	●	●	●	●
	2		●	●	●	●	●	●
	3		●	●	●	●	●	●
K	1							
	2							
	3							
N	1							
	2							
	3							
	4							
	5							
S	1	●	●	●	●	●	●	●
	2	●	●	●	●	●	●	●
	3	●	●	●	●	●	●	●
	4	●	●	●	●	●	●	●
H	1							
	2							
	3							
	4							

INDEXABLE MILLING

SOLID END MILLING

HOLEMAKING

TAPPING

TURNING

# SEM Selection Table

## Hanita™ High-Performance Solid Carbide End Mills • Selection Guide • Inch

INDEXABLE MILLING





















SOLID END MILLING

HOLE/REAMING

TAPPING

TURNING

- first choice
- alternate choice

		Hanita Solid End Milling Portfolio						
		WavCut II™	WavCut II	WavCut II	WavCut II	WavCut II	WavCut II	WavCut II
								
UOM		Inch	Inch	Inch	Inch	Inch	Inch	Inch
Series		620V	621V	622V	623V	620V	621V	622V
Page		B360	B360	B360	B360	B360	B360	B360
Flute		4 - 6		6	4 - 6	6	6	6
Diameter D1		3/4–1 1/4"	1 1/4–1 1/2"	1 1/4"	1 1/4"	1"	1–1 1/2"	1 1/4–1 1/2"
Shank								
Length of Cut		Regular	Long	Extended	Short	Regular	Long	Extended
Corner Style								
Chamfer Size		.040"	.040"	.040"	.040"			
Radius Sizes						.060"	.060"	.060"
Helix Angle		35°	35°	35°	35°	35°	35°	35°
Center Cutting		Yes	Yes	Yes	Yes	Yes	Yes	Yes
Neck		No	No	No	No	No	No	No
Materials								
P	0							
	1							
	2							
	3							
	4							
	5							
M	1	●	●	●	●	●	●	●
	2	●	●	●	●	●	●	●
	3	●	●	●	●	●	●	●
K	1							
	2							
	3							
N	1							
	2							
	3							
	4							
	5							
S	1	●	●	●	●	●	●	●
	2	●	●	●	●	●	●	●
	3	●	●	●	●	●	●	●
	4	●	●	●	●	●	●	●
H	1							
	2							
	3							
	4							



Hanita™ High-Performance Solid Carbide End Mills • Selection Guide • Inch

INDEXABLE MILLING



















SOLID END MILLING

HOLEMAKING

TAPPING

TURNING

- first choice
- alternate choice

		Hanita Solid End Milling Portfolio					
		WavCut II™	HSS Finishers	HSS Finishers	HSS Finishers	HSS Finishers	HSS Finishers
							
UOM		Inch	Inch	Inch	Inch	Inch	Inch
Series		625V	3415	3417	3427	3437	3457
Page		B360	B363	B363	B363	B363	B363
Flute		6	4	6	6	6	6
Diameter D1		2"	1/2–1"	1–1 1/4"	1–1 1/2"	1–1 1/4"	2"
Shank							
Length of Cut		Short	Regular	Long	Regular	Long	Regular
Corner Style							
Chamfer Size		–	–	–	–	–	–
Radius Sizes		.060"	–	–	–	–	–
Helix Angle		35°	35°	35°	35°	35°	35°
Center Cutting		Yes	Yes	Yes	Yes	Yes	Yes
Neck		No	No	No	No	No	No
Materials							
P	0						
	1						
	2						
	3						
	4						
	5						
	6						
M	1	●					
	2	●					
	3	●					
K	1						
	2						
	3						
N	1						
	2						
	3						
	4						
	5						
S	1	●	●	●	●	●	●
	2	●	●	●	●	●	●
	3	●	●	●	●	●	●
	4	●	●	●	●	●	●
H	1						
	2						
	3						
	4						

# SEM Selection Table

## Hanita™ High-Performance Solid Carbide End Mills • Selection Guide • Metric

INDEXABLE MILLING





















SOLID END MILLING

HOLEMAKING

TAPPING

TURNING





















- first choice
- alternate choice

		Hanita Solid End Milling Portfolio						
		VariMill™ XTREME™	VariMill XTREME	VariMill XTREME	VariMill XTREME	VariMill XTREME	VariMill XTREME	VariMill XTREME
								
<b>UOM</b>		Metric	Metric	Metric	Metric	Metric	Metric	Metric
<b>Series</b>		4X0E	4X0E	4X0E	4XNE	4XNE	4XNE	4XNE
<b>Page</b>		B167	B168	B168	B169	B168	B170	B171
<b>Flute</b>		4	4	4	4	4	4	4
<b>Diameter D1</b>		3–25mm	4–12mm	25mm	4–20mm	16mm	4–20mm	16mm
<b>Shank</b>								
<b>Length of Cut</b>		Regular	Regular	Regular	Regular	Regular	Regular	Regular
<b>Corner Style</b>								
<b>Chamfer Size</b>		–	0,10–0,30mm	–	–	0,30mm	0,10–0,30mm	–
<b>Radius Sizes</b>		0,20–3,00mm	–	1,00mm	–	–	–	0,20–5,00mm
<b>Helix Angle</b>		37° / 39°	37° / 39°	37° / 39°	37° / 39°	37° / 39°	37° / 39°	37° / 39°
<b>Center Cutting</b>		Yes	Yes	Yes	Yes	Yes	Yes	Yes
<b>Neck</b>		No	No	No	Yes	Yes	Yes	Yes
<b>Materials</b>								
<b>P</b>	0	●	●	●	●	●	●	●
	1	●	●	●	●	●	●	●
	2	●	●	●	●	●	●	●
	3	●	●	●	●	●	●	●
	4	●	●	●	●	●	●	●
	5	●	●	●	●	●	●	●
<b>M</b>	1	●	●	●	●	●	●	●
	2	●	●	●	●	●	●	●
	3	●	●	●	●	●	●	●
<b>K</b>	1	●	●	●	●	●	●	●
	2	●	●	●	●	●	●	●
	3	●	●	●	●	●	●	●
<b>N</b>	1							
	2							
	3							
	4							
	5							
<b>S</b>	1	○	○	○	○	○	○	○
	2	○	○	○	○	○	○	○
	3	○	○	○	○	○	○	○
	4	○	○	○	○	○	○	○
<b>H</b>	1	○	○	○	○	○	○	○
	2	○	○	○	○	○	○	○
	3							
	4							



Hanita™ High-Performance Solid Carbide End Mills • Selection Guide • Metric

● first choice  
○ alternate choice

		Hanita Solid End Milling Portfolio						
		VariMill™ XTREME™	VariMill I™	VariMill I	VariMill I	VariMill I	VariMill I	VariMill I
								
UOM		Metric	Metric	Metric	Metric	Metric	Metric	Metric
Series		4XNE	4777	4777	4777	4777	4717	4727
Page		B171	B187-B188	B187-B188	B187-B188	B187-B188	B189	B189
Flute		4	4	4	4	4	4	4
Diameter D1		12–20mm	4–20mm	4–25mm	4–25mm	4–25mm	6–20mm	12–20mm
Shank								
Length of Cut		Regular	Regular	Regular	Regular	Regular	Long	Extended
Corner Style								
Chamfer Size		–	–	0,40–0,50mm	–	0,40–0,50mm	0,40–0,50mm	0,50mm
Radius Sizes		1,00mm	–	–	0,20–5,00mm	–	–	–
Helix Angle		37° / 39°	38°	38°	38°	38°	38°	38°
Center Cutting		Yes	Yes	Yes	Yes	Yes	Yes	Yes
Neck		Yes	No	No	No	No	No	No
Materials								
P	0	●	●	●	●	●	●	●
	1	●	●	●	●	●	●	●
	2	●	●	●	●	●	●	●
	3	●	●	●	●	●	●	●
	4	●	●	●	●	●	●	●
	5	●	●	●	●	●	●	●
M	1	●	○	○	○	○	○	○
	2	●	○	○	○	○	○	○
	3	●	○	○	○	○	○	○
K	1	●	●	●	●	●	●	●
	2	●	●	●	●	●	●	●
	3	●	●	●	●	●	●	●
N	1							
	2							
	3							
	4							
	5							
S	1	○	○	○	○	○	○	○
	2	○	○	○	○	○	○	○
	3	○	○	○	○	○	○	○
	4	○	○	○	○	○	○	○
H	1	○	○	○	○	○	○	○
	2	○	○	○	○	○	○	○
	3							
	4							

INDEXABLE MILLING

SOLID END MILLING

HOLEMAKING

TAPPING

TURNING



# SEM Selection Table

## Hanita™ High-Performance Solid Carbide End Mills • Selection Guide • Metric

INDEXABLE MILLING





















SOLID END MILLING

HOLEMAKING

TAPPING





















TURNING

- first choice
- alternate choice

		Hanita Solid End Milling Portfolio						
		VariMill I™	VariMill I	VariMill I	VariMill I	VariMill I	VariMill II™	VariMill II
								
UOM		Metric	Metric	Metric	Metric	Metric	Metric	Metric
Series		4778	47N7	47N7	47N6	47N0	5777	5777
Page		B190	B191	B191	B192	B192	B215	B215
Flute		4	4	4	4	4	5	5
Diameter D1		4–25mm	4–20mm	6–20mm	6–20mm	5–20mm	4–20mm	4–25mm
Shank								
Length of Cut		Regular	Regular	Regular	Extended	Regular	Regular	Regular
Corner Style								
Chamfer Size		–	–	0,40–0,50mm	0,40–0,50mm	–	–	–
Radius Sizes		0,20–0,30mm	0,40–5,00mm	–	–	–	–	0,25–5,00mm
Helix Angle		38°	38°	38°	38°	38°	38°	38°
Center Cutting		Yes	Yes	Yes	Yes	Yes	No	No
Neck		No	Yes	Yes	Yes	Yes	No	No
Materials								
P	0	○	●	●	●	●	●	●
	1	○	●	●	●	●	●	●
	2	○	●	●	●	●	●	●
	3	○	●	●	●	●	●	●
	4	○	●	●	●	●	●	●
	5	○	●	●	●	●	●	●
M	1	●	○	○	○	○	○	○
	2	●	○	○	○	○	○	○
	3	●	○	○	○	○	○	○
K	1		●	●	●	●	●	●
	2		●	●	●	●	●	●
	3		●	●	●	●	●	●
N	1							
	2							
	3							
	4							
	5							
S	1	●	○	○	○	○	○	○
	2	●	○	○	○	○	○	○
	3	●	○	○	○	○	○	○
	4	●	○	○	○	○	○	○
H	1		○	○	○	○	○	○
	2		○	○	○	○	○	○
	3							
	4							

## Hanita™ High-Performance Solid Carbide End Mills • Selection Guide • Metric

- first choice
- alternate choice

		Hanita Solid End Milling Portfolio						
		VariMill II™	VariMill II	VariMill II	VariMill II	VariMill II	VariMill II	VariMill II
								
UOM		Metric	Metric	Metric	Metric	Metric	Metric	Metric
Series		5777	577C	577C	577C	57N8	57N8	57N8
Page		B215	B216	B216	B216	B217	B217	B217
Flute		5	5	5	5	5	5	5
Diameter D1		16,00mm	4–20mm	4–25mm	4–25mm	6–16mm	6–25mm	16–20mm
Shank								
Length of Cut		Regular	Regular	Regular	Regular	Regular	Regular	Regular
Corner Style								
Chamfer Size		–	–	–	–	–	–	–
Radius Sizes		0,75mm	–	0,25–5,00mm	0,25–0,75mm	–	0,5–5,00mm	0,5–3,00mm
Helix Angle		38°	38°	38°	38°	38°	38°	38°
Center Cutting		No	Yes	Yes	Yes	No	No	No
Neck		No	No	No	No	Yes	Yes	Yes
Materials								
P	0	●	●	●	●	○	○	○
	1	●	●	●	●	○	○	○
	2	●	●	●	●	○	○	○
	3	●	●	●	●	○	○	○
	4	●	●	●	●	○	○	○
	5	●	●	●	●	○	○	○
M	1	○	○	○	○	●	●	●
	2	○	○	○	○	●	●	●
	3	○	○	○	○	●	●	●
K	1	●	●	●	●			
	2	●	●	●	●			
	3	●	●	●	●			
N	1							
	2							
	3							
	4							
	5							
S	1	○	○	○	○	●	●	●
	2	○	○	○	○	●	●	●
	3	○	○	○	○	●	●	●
	4	○	○	○	○	●	●	●
H	1	○	○	○	○			
	2	○	○	○	○			
	3							
	4							

INDEXABLE MILLING

SOLID END MILLING

HOLEMAKING

TAPPING

TURNING

# SEM Selection Table

## Hanita™ High-Performance Solid Carbide End Mills • Selection Guide • Metric

INDEXABLE MILLING





















SOLID END MILLING

HOLEMAKING

TAPPING





















TURNING

- first choice
- alternate choice

		Hanita Solid End Milling Portfolio						
		VariMill II™	VariMill II	VariMill II	VariMill II	VariMill II	VariMill II	VariMill II
								
<b>UOM</b>		Metric	Metric	Metric	Metric	Metric	Metric	Metric
<b>Series</b>		57NC	57NC	57NC	577E	577E	577E	577E
<b>Page</b>		B218	B218	B218	B219	B219	B219	B219
<b>Flute</b>		5	5	5	5	5	5	5
<b>Diameter D1</b>		6–25mm	6–25mm	6–25mm	10mm	12–20mm	16–20mm	16–25mm
<b>Shank</b>								
<b>Length of Cut</b>		Regular	Regular	Regular	Regular	Regular	Regular	Regular
<b>Corner Style</b>								
<b>Chamfer Size</b>		–	–	–	–	–	–	–
<b>Radius Sizes</b>		–	0,25–4,00mm	0,50–3,00mm	–	0,75mm	–	0,75mm
<b>Helix Angle</b>		38°	38°	38°	38°	38°	38°	38°
<b>Center Cutting</b>		Yes	Yes	Yes	Yes	Yes	Yes	Yes
<b>Neck</b>		Yes	Yes	Yes	No	No	No	No
<b>Materials</b>								
<b>P</b>	0	○	○	○				
	1	○	○	○				
	2	○	○	○				
	3	○	○	○				
	4	○	○	○				
	5	○	○	○	●	●	●	●
<b>M</b>	6	○	○	○	●	●	●	●
	1	●	●	●	●	●	●	●
	2	●	●	●	●	●	●	●
<b>K</b>	3	●	●	●	●	●	●	●
	1							
	2							
<b>N</b>	3							
	1							
	2							
	3							
	4							
<b>S</b>	5							
	1	●	●	●	●	●	●	●
	2	●	●	●	●	●	●	●
	3	●	●	●	●	●	●	●
<b>H</b>	4	●	●	●	●	●	●	●
	1							
	2							
	3							
	4							

Hanita™ High-Performance Solid Carbide End Mills • Selection Guide • Metric

● first choice  
○ alternate choice

		Hanita Solid End Milling Portfolio						
		VariMill II™	VariMill II	VariMill II	VariMill II	VariMill II	VariMill II	VariMill II
								
UOM		Metric	Metric	Metric	Metric	Metric	Metric	Metric
Series		57NE	57NE	57NE	57NE	57NE	5718	5718
Page		B220	B220	B220	B220	B220	B221	B221
Flute		5	5	5	5	5	5	5
Diameter D1		10mm	10mm	10–20mm	12–25mm	12–25mm	6–25mm	6–25mm
Shank								
Length of Cut		Regular	Regular	Regular	Regular	Regular	X-Long	X-Long
Corner Style								
Chamfer Size		–	–	–	–	–	–	–
Radius Sizes		–	0,50–2,00mm	0,50–4,00mm	–	0,50–4,00mm	–	0,5–4,00mm
Helix Angle		38°	38°	38°	38°	38°	43°	43°
Center Cutting		Yes	Yes	Yes	Yes	Yes	No	No
Neck		Yes	Yes	Yes	Yes	Yes	No	No
Materials								
P	0						●	●
	1						●	●
	2						●	●
	3						●	●
	4						●	●
	5	●	●	●	●	●	●	●
M	1	●	●	●	●	●	●	●
	2	●	●	●	●	●	●	●
	3	●	●	●	●	●	●	●
K	1						●	●
	2						●	●
	3						●	●
N	1							
	2							
	3							
	4							
	5							
S	1	●	●	●	●	●	●	●
	2	●	●	●	●	●	●	●
	3	●	●	●	●	●	●	●
	4	●	●	●	●	●	●	●
H	1						●	●
	2						●	●
	3						●	●
	4						●	●

INDEXABLE MILLING

SOLID END MILLING

HOLEMAKING

TAPPING

TURNING

## Hanita™ High-Performance Solid Carbide End Mills • Selection Guide • Metric

INDEXABLE MILLING





















SOLID END MILLING

HOLE/REAMING

TAPPING





















TURNING

- first choice
- alternate choice

		Hanita Solid End Milling Portfolio						
		VariMill III™	VariMill III	VariMill III	VariMill III	VariMill III	VariMill III	VariMill III
								
<b>UOM</b>		Metric	Metric	Metric	Metric	Metric	Metric	Metric
<b>Series</b>		771E	771E	772E	772E	772E	772E	77NE
<b>Page</b>		B233	B233	B233	B233	B233	B233	B234
<b>Flute</b>		7	7	7	7	7	7	7
<b>Diameter D1</b>		10–20mm	10–20mm	10–20mm	10–20mm	12–20mm	12–20mm	10–20mm
<b>Shank</b>								
<b>Length of Cut</b>		Regular	Regular	X-Long	X-Long	X-Long	X-Long	Regular
<b>Corner Style</b>								
<b>Chamfer Size</b>		0,5mm	–	0,5mm	–	0,5mm	–	0,5mm
<b>Radius Sizes</b>		–	0,5mm	–	0,5mm	–	0,5mm	–
<b>Helix Angle</b>		38°	38°	38°	38°	38°	38°	38°
<b>Center Cutting</b>		Yes	Yes	Yes	Yes	Yes	Yes	Yes
<b>Neck</b>		No	No	No	No	No	No	Yes
<b>Materials</b>								
<b>P</b>	0							
	1							
	2							
	3							
	4							
	5	●	●	●	●	●	●	●
<b>M</b>	1	●	●	●	●	●	●	●
	2	●	●	●	●	●	●	●
	3	●	●	●	●	●	●	●
<b>K</b>	1							
	2							
	3							
<b>N</b>	1							
	2							
	3							
	4							
	5							
<b>S</b>	1	●	●	●	●	●	●	●
	2	●	●	●	●	●	●	●
	3	●	●	●	●	●	●	●
	4	●	●	●	●	●	●	●
<b>H</b>	1							
	2							
	3							
	4							

## Hanita™ High-Performance Solid Carbide End Mills • Selection Guide • Metric

● first choice  
○ alternate choice

		Hanita Solid End Milling Portfolio						
		VariMill III™	Roughers	Roughers	Roughers	Roughers	Roughers	Roughers
								
UOM		Metric	Metric	Metric	Metric	Metric	Metric	Metric
Series		77NE	4906	4906	4976	49N6	4U50	4U80
Page		B234	B253	B253	B253	B254	B255	B255
Flute		7	3 - 4	3 - 4 - 5	3 - 4	3 - 5	4 - 6	4 - 6
Diameter D1		10–20mm	4–20mm	4–25mm	4–20mm	6–20mm	6–25mm	6–25mm
Shank								
Length of Cut		Regular	Regular	Regular	Regular	Regular	Short	Regular
Corner Style								
Chamfer Size		–	0,30–0,50mm	0,30–0,50mm	0,30–0,50mm	0,30–0,50mm	–	–
Radius Sizes		0,5mm	–	–	–	–	0,30–1,00mm	0,30–1,00mm
Helix Angle		38°	30°	30°	30°	30°	45°	45°
Center Cutting		Yes	Yes	Yes	Yes	Yes	Yes	Yes
Neck		Yes	No	No	No	Yes	Yes	No
Materials								
P	0		●	●	●	●		
	1		●	●	●	●		
	2		●	●	●	●		
	3		●	●	●	●		
	4		●	●	●	●		
	5	●	●	●	●	●	●	●
M	1	●	○	○	○	○	●	●
	2	●	○	○	○	○	●	●
	3	●	○	○	○	○	●	●
K	1		●	●	●	●		
	2		●	●	●	●		
	3		●	●	●	●		
N	1							
	2							
	3							
	4							
	5							
S	1	●	○	○	○	○	●	●
	2	●	○	○	○	○	●	●
	3	●	○	○	○	○	●	●
	4	●	○	○	○	○	●	●
H	1		○	○	○	○		
	2		○	○	○	○		
	3							
	4							

INDEXABLE MILLING

SOLID END MILLING

HOLEMAKING

TAPPING

TURNING

# SEM Selection Table

## Hanita™ High-Performance Solid Carbide End Mills • Selection Guide • Metric

INDEXABLE MILLING





















SOLID END MILLING

HOLEMAKING

TAPPING





















TURNING

- first choice
- alternate choice

		Hanita Solid End Milling Portfolio						
		Roughers	Roughers	Roughers	Roughers	Roughers	Roughers	Roughers
								
UOM		Metric	Metric	Metric	Metric	Metric	Metric	Metric
Series		4U80	4U40	4U70	4U70	DQ13	DQ13	49H6
Page		B255	B256	B256	B256	B257	B257	B257
Flute		4 - 6	4	4 - 6	4 - 6	3	3	4
Diameter D1		6–16mm	8mm	6–20mm	6–16mm	3–4mm	3–18mm	10–16mm
Shank								
Length of Cut		Regular	Short	Regular	Regular	Regular	Regular	Regular
Corner Style								
Chamfer Size		–	–	0,50–1,00mm	0,30–0,60mm	–	–	–
Radius Sizes		0,30–0,50mm	0,75mm	–	–	0,25mm	0,25–0,45mm	0,50mm
Helix Angle		45°	45°	45°	45°	30°	30°	30°
Center Cutting		Yes	Yes	Yes	Yes	Yes	Yes	Yes
Neck		No	Yes	No	No	No	No	No
Materials								
P	0					●	●	●
	1					●	●	●
	2					●	●	●
	3					●	●	●
	4					●	●	●
	5	●	●	●	●	●	●	●
M	1	●	●	●	●	○	○	○
	2	●	●	●	●	○	○	○
	3	●	●	●	●	○	○	○
K	1					●	●	●
	2					●	●	●
	3					●	●	●
N	1							
	2							
	3							
	4							
	5							
S	1	●	●	●	●	○	○	○
	2	●	●	●	●	○	○	○
	3	●	●	●	●	○	○	○
	4	●	●	●	●	○	○	○
H	1					○	○	○
	2					○	○	○
	3							
	4							

## Hanita™ High-Performance Solid Carbide End Mills • Selection Guide • Metric

● first choice  
○ alternate choice

		Hanita Solid End Milling Portfolio						
		Roughers	Finishers	Finisher	Finisher	Finisher	Finisher	Finisher
								
UOM		Metric	Metric	Metric	Metric	Metric	Metric	Metric
Series		4940	DC03	4603	D503	D513	D507	D517
Page		B258	B272	B273	B274	B274	B275	B274
Flute		4 - 6	3	3	3	3	6	6
Diameter D1		6–16mm	3–12mm	3–16mm	2–12mm	3–10mm	6–20mm	6–20mm
Shank								
Length of Cut		Short	Regular	Regular	Regular	Regular	Regular	Regular
Corner Style								
Chamfer Size		–	–	–	–	–	–	–
Radius Sizes		0,75–1,00mm	0,25–0,45mm	–	–	–	–	–
Helix Angle		45°	35°	60°	45°	45°	45°	45°
Center Cutting		Yes	Yes	Yes	Yes	Yes	Yes	Yes
Neck		No	No	No	No	No	No	No
Materials								
P	0	●	●	●	●	●	●	●
	1	●	●	●	●	●	●	●
	2	●	●	●	●	●	●	●
	3	●	●	●	●	●	●	●
	4	●	●	●	●	●	●	●
	5	●	●	●	●	●	●	●
M	1	○	●	●	●	●	●	●
	2	○	●	●	●	●	●	●
	3	○	●	●	●	●	●	●
K	1	●	●	●	●	●	●	●
	2	●	●	●	●	●	●	●
	3	●	●	●	●	●	●	●
N	1							
	2							
	3							
	4							
	5							
S	1	○	●	●	●	●	●	●
	2	○	●	●	●	●	●	●
	3	○	●	●	●	●	●	●
	4	○	●	●	●	●	●	●
H	1	○	●	●	●	●	●	●
	2	○	●	●	●	●	●	●
	3		●	●	●	●	●	●
	4		●	●	●	●	●	●

INDEXABLE MILLING

SOLID END MILLING

HOLEMAKING

TAPPING

TURNING



## Hanita™ High-Performance Solid Carbide End Mills • Selection Guide • Metric

INDEXABLE MILLING





















SOLID END MILLING

HOLEMAKING

TAPPING





















TURNING

- first choice
- alternate choice

		Hanita Solid End Milling Portfolio						
		Finisher	Finisher	ALUFLASH™	ALUFLASH	ALUFLASH	ALUFLASH	ALUFLASH
								
<b>UOM</b>		Metric	Metric	Metric	Metric	Metric	Metric	Metric
<b>Series</b>		4503 JJ	4001 JJ	2A09	2A09	3A09	3A09	3AN9
<b>Page</b>		B276	B277	B299	B299	B300	B300	B300
<b>Flute</b>		3	2	2	2	3	3	3
<b>Diameter D1</b>		1–20mm	1–16mm	1–20mm	1–20mm	3mm	3–4mm	4–20mm
<b>Shank</b>								
<b>Length of Cut</b>		Regular	Regular	Regular	Regular	Regular	Regular	Regular
<b>Corner Style</b>								
<b>Chamfer Size</b>		–	–	–	–	–	–	–
<b>Radius Sizes</b>		–	–	–	0,20–1,00mm	–	0,20–0,50mm	–
<b>Helix Angle</b>		45°	30°	37° / 39°	37° / 39°	37° / 39°	37° / 39°	37° / 39°
<b>Center Cutting</b>		Yes	Yes	Yes	Yes	Yes	Yes	Yes
<b>Neck</b>		No	Yes	No	No	No	No	Yes
<b>Materials</b>								
<b>P</b>	0	●	●					
	1	●	●					
	2	●	●					
	3	●	●					
	4	●	●					
	5	●	●					
<b>M</b>	1	●	●					
	2	●	●					
	3	●	●					
<b>K</b>	1	●	●					
	2	●	●					
	3	●	●					
<b>N</b>	1			●	●	●	●	●
	2			●	●	●	●	●
	3			●	●	●	●	●
	4			●	●	●	●	●
	5			●	●	●	●	●
<b>S</b>	1	●	●					
	2	●	●					
	3	●	●					
	4	●	●					
<b>H</b>	1	●	●					
	2	●	●					
	3	●	●					
	4	●	●					

## Hanita™ High-Performance Solid Carbide End Mills • Selection Guide • Metric

- first choice
- alternate choice

		Hanita Solid End Milling Portfolio						
		ALUFLASH™	ALUFLASH	ALUFLASH	X-Feed™	X-Feed	X-Feed	X-Feed
								
UOM		Metric	Metric	Metric	Metric	Metric	Metric	Metric
Series		3AN9	3AP9	3AP9	70N6	71N6	70NS	70N7
Page		B301	B302	B302	B316	B316	B317	B317
Flute		3	3	3	6	6	6	6
Diameter D1		4–20mm	12mm	4–20mm	6–12mm	6–20mm	6–25mm	6–20mm
Shank								
Length of Cut		Regular	Long	Long	Long	Regular	Regular	Regular
Corner Style								
Chamfer Size		–	–	–	–	–	–	–
Radius Sizes		0,20–5,00mm	–	0,20–4,00mm	–	–	–	–
Helix Angle		37° / 39°	37° / 39°	37° / 39°	20°	20°	20°	20°
Center Cutting		Yes	Yes	Yes	Yes	Yes	Yes	Yes
Neck		Yes	Yes	Yes	Yes	Yes	Yes	Yes
Materials								
P	0				●	●		
	1				●	●		
	2				●	●		
	3				●	●		
	4				●	●		
	5						●	
M	1						●	
	2						●	
	3						●	
K	1							
	2							
	3							
N	1	●	●	●				
	2	●	●	●				
	3	●	●	●				
	4	●	●	●				
	5	●	●	●				
S	1						●	
	2						●	
	3				●	●	●	
	4				●	●	●	
H	1							●
	2							●
	3							●
	4							●

INDEXABLE MILLING

SOLID END MILLING

HOLEMAKING

TAPPING

TURNING

## Hanita™ High-Performance Solid Carbide End Mills • Selection Guide • Metric





















INDEXABLE MILLING

SOLID END MILLING

HOLEMAKING





















TAPPING

TURNING

		Hanita Solid End Milling Portfolio						
		Vision Plus™	Vision Plus	Vision Plus	Vision Plus	Vision Plus	Vision Plus	Vision Plus
								
		● first choice ○ alternate choice						
UOM		Metric	Metric	Metric	Metric	Metric	Metric	Metric
Series		7505	7515	7525	7545	7585	7595	75N2
Page		B326	B326	B326	B326	B327	B327	B328
Flute		4	4 - 6	4 - 5 - 6	4	4	4	3
Diameter D1		3–12mm	6–25mm	6–25mm	3–16mm	6–16mm	3–20mm	3–6mm
Shank								
Length of Cut		Regular	Long	Extended	Short	Short	Long	Regular
Corner Style								
Chamfer Size		–	–	–	–	–	–	–
Radius Sizes		–	–	–	–	0,25–1,00mm	0,25–2,00mm	0,30–1,00mm
Helix Angle		50°	50°	50°	50°	50°	50°	30°
Center Cutting		Yes	Yes	Yes	Yes	Yes	Yes	Yes
Neck		No	No	No	No	No	No	Yes
Materials								
P	0							
	1							
	2							
	3							
	4							
	5							
M	1							
	2							
	3							
K	1							
	2							
	3							
N	1							
	2							
	3							
	4							
	5							
S	1							
	2							
	3							
	4							
H	1	•	•	•	•	•	•	•
	2	•	•	•	•	•	•	•
	3	•	•	•	•	•	•	•
	4	•	•	•	•	•	•	•

Hanita™ High-Performance Solid Carbide End Mills • Selection Guide • Metric

- first choice
- alternate choice

		Hanita Solid End Milling Portfolio						
		Vision Plus™	Vision Plus	Vision Plus	Vision Plus	Vision Plus	Vision Plus	Vision Plus
								
UOM		Metric	Metric	Metric	Metric	Metric	Metric	Metric
Series		75N5	7670	D518	D618	7050	7060	7061
Page		B328	B329	B329	B330	B330	B330	B331
Flute		4	6	4 - 6 - 8	4 - 6	4	4	2
Diameter D1		3–20mm	16mm	4–25mm	3–20mm	2–16mm	6–10mm	1–8mm
Shank								
Length of Cut		Regular	Short	Regular	Long	Regular	Regular	Regular
Corner Style								
Chamfer Size		–	–	–	–	–	–	–
Radius Sizes		0,25–2,00mm	1mm	–	–	–	–	–
Helix Angle		50°	45°	50°	50°	15°	15°	15°
Center Cutting		Yes	Yes	Yes	Yes	Yes	Yes	Yes
Neck		Yes	Yes	No	No	No	No	No
Materials								
P	0							
	1							
	2							
	3							
	4							
	5							
M	1							
	2							
	3							
K	1							
	2							
	3							
N	1							
	2							
	3							
	4							
	5							
S	1							
	2							
	3							
	4							
H	1	●	●	●	●	●	●	●
	2	●	●	●	●	●	●	●
	3	●	●	●	●	●	●	●
	4	●	●	●	●	●	●	●

INDEXABLE MILLING

SOLID END MILLING

HOLEMAKING

TAPPING

TURNING

# SEM Selection Table

## Hanita™ High-Performance Solid Carbide End Mills • Selection Guide • Metric

INDEXABLE MILLING





















SOLID END MILLING

HOLEMAKING

TAPPING

TURNING



















- first choice
- alternate choice

		Hanita Solid End Milling Portfolio						
		Vision Plus™	Vision Plus	Vision Plus	Vision Plus Micro	Vision Plus Micro	Vision Plus Micro	Vision Plus Micro
								
UOM		Metric	Metric	Metric	Metric	Metric	Metric	Metric
Series		7150	7151	70N1	7N02	7N12	7N22	7N01
Page		B331	B332	B332	B333	B333	B333	B335
Flute		4	2	2	2	2	2	2
Diameter D1		3–12mm	1–12mm	1–12mm	0,3–2mm	1–4mm	0,4–3,05mm	0,3–6mm
Shank								
Length of Cut		Regular	Regular	–	Regular	Long	Extended	Regular
Corner Style								
Chamfer Size		–	–	–	–	–	–	–
Radius Sizes		–	–	–	–	–	–	–
Helix Angle		15°	15°	30°	30°	30°	30°	30°
Center Cutting		Yes	Yes	Yes	Yes	Yes	Yes	Yes
Neck		No	No	Yes	Yes	Yes	Yes	Yes
Materials								
P	0							
	1							
	2							
	3							
	4							
	5							
M	1							
	2							
	3							
K	1							
	2							
	3							
N	1							
	2							
	3							
	4							
	5							
S	1							
	2							
	3							
	4							
H	1	●	●	●	●	●	●	●
	2	●	●	●	●	●	●	●
	3	●	●	●	●	●	●	●
	4	●	●	●	●	●	●	●



## Hanita™ High-Performance Solid Carbide End Mills • Selection Guide • Metric

- first choice
- alternate choice

		Hanita Solid End Milling Portfolio					
		Vision Plus™ Micro	HSS Roughers	HSS Roughers	WavCut I™	WavCut I	WavCut I
							
UOM		Metric	Metric	Metric	Metric	Metric	Metric
Series		7N21	60N6	6LN6	660W	661W	664W
Page		B333	—	B333	B362	B362	B362
Flute		2	4-5	4-5	5-6	6-8	5-6
Diameter D1		0,5–3mm	6–30mm	12–25mm	25–50mm	25–50mm	25–50mm
Shank							
Length of Cut		Regular	Regular	Regular	Regular	Long	Short
Corner Style							
Chamfer Size		—	0,25–0,50mm	0,35–0,5mm	1mm	1mm	1mm
Radius Sizes		—	—	—	—	—	—
Helix Angle		30°	30°	30°	35°	35°	35°
Center Cutting		Yes	Yes	Yes	Yes	Yes	Yes
Neck		Yes	No	Yes	No	No	No
Materials							
P	0		●	●			
	1		●	●			
	2		●	●			
	3		●	●			
	4		●	●			
	5		●	●			
M	1		●	●	●	●	●
	2		●	●	●	●	●
	3		●	●	●	●	●
K	1		●	●			
	2		●	●			
	3		●	●			
N	1						
	2						
	3						
	4						
	5						
S	1		●	●	●	●	●
	2		●	●	●	●	●
	3		●	●	●	●	●
	4		●	●	●	●	●
H	1	●					
	2	●					
	3	●					
	4	●					

INDEXABLE MILLING

SOLID END MILLING

HOLE/MAKING

TAPPING

TURNING

# VariMill™ XTREME™

## High-Performance Solid End Milling

VariMill XTREME is for CNC machining companies seeking a versatile solution capable of machining a broad range of materials while ensuring a high productivity output to reduce manufacturing costs through aggressive machining conditions.

### Built-in features to enable aggressive versatility.

**Twisted End Face** to improve edge stability, which enables aggressive ramping angles and helical capability.

**Non-Linear Chip Gashes** for improved chip evacuation, enabling the ramping function and z-axis machining.

**Asymmetrical Divided Flute and Variable Helix Angle** for reduced vibrations.

**Parabolic Core** for increased tool stability and reduced deflection and risk of breakage.



VariMill XTREME will dominate the shop floor through productive output due to its versatile offering and ability to machine a broad range of materials in aggressive cutting conditions.

## **AGGRESSIVE**

Exceeds expectations in aggressive cutting parameters.

## **PRODUCTIVE**

Improved chip evacuation and increased edge/corner strength to reduce any risk of breakage while pushing the cutting parameters to the limit.

## **VERSATILE**

Capable of machining a broad range of materials (steel, stainless steel, cast iron, super alloys), provides high-performance and tool life in a variety of operations including ramping, slotting, plunging, drilling, helical interpolation, and dynamic milling.

# AGGRESSIVE VERSATILITY

## PRODUCT

SOLID CARBIDE END MILL

GRADE

WS15PE

FLUTE

4

DIAMETER RANGE

INCH

1/8"–1"

METRIC

3–25mm

## INDUSTRY



GENERAL  
ENGINEERING



ENERGY



AEROSPACE

## APPLICATIONS

MATERIALS



SIDE MILLING



SLOTTING



HELICAL  
INTERPOLATION



RAMPING



DYNAMIC  
MILLING



PLUNGING



DRILLING



INDEXABLE MILLING

## VariMill XTREME • Series 4X0E • Square End • 4 Flute • Cylindrical Shank • Inch

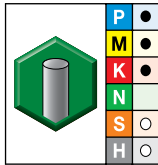
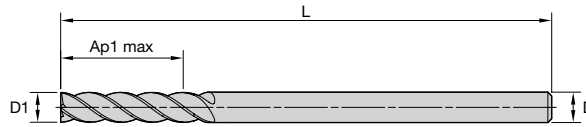

- first choice
- alternate choice

WS15PE

order #	catalog #	D1	D	length of cut Ap1 max	length L	ZU
6827746	4X0EE03001SZT	1/8	1/8	1/2	2	4
6827750	4X0EE05000SZT	3/16	3/16	5/8	2 1/4	4
6828405	4X0EE07002SZT	1/4	1/4	3/4	2 1/2	4
6828410	4X0EE08003SZT	5/16	5/16	3/4	2 1/2	4
6828609	4X0EE10004SZT	3/8	3/8	7/8	2 1/2	4

HOLEMAKING

## VariMill XTREME • Series 4X0E • Square End • 4 Flute • Weldon® Shank • Inch

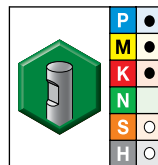
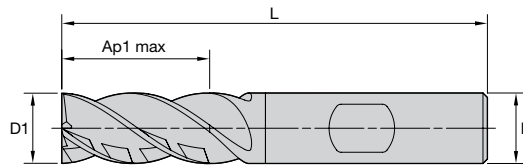

- first choice
- alternate choice

WS15PE

order #	catalog #	D1	D	length of cut Ap1 max	length L	ZU
6828775	4X0EE13005SZW	1/2	1/2	1	3	4
6828777	4X0EE13015SZW	1/2	1/2	1 1/4	3 1/4	4
6828974	4X0EE16006SZW	5/8	5/8	1 1/4	3 1/2	4
6828977	4X0EE19007SZW	3/4	3/4	1 1/2	4	4
6829167	4X0EE25008SZW	1	1	1 1/2	4 1/2	4

TURNING

VariMill XTREME • Series 4XOE • Radiused • 4 Flute • Cylindrical Shank • Inch

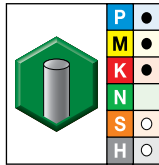
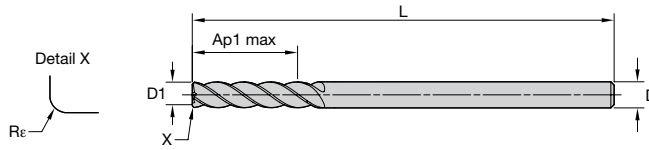

● first choice  
○ alternate choice

WS15PE

order #	catalog #	D1	D	length of cut Ap1 max	length L	Re	ZU
6827747	4X0EE03001RAT	1/8	1/8	1/2	2	.015	4
6828401	4X0EE05000RAT	3/16	3/16	5/8	2 1/4	.015	4
6828402	4X0EE05000RBT	3/16	3/16	5/8	2 1/4	.030	4
6828406	4X0EE07002RAT	1/4	1/4	3/4	2 1/2	.015	4
6828407	4X0EE07002RBT	1/4	1/4	3/4	2 1/2	.030	4
6828601	4X0EE08003RAT	5/16	5/16	3/4	2 1/2	.015	4
6828603	4X0EE08003RBT	5/16	5/16	3/4	2 1/2	.030	4
6828610	4X0EE10004RAT	3/8	3/8	7/8	2 1/2	.015	4
6828771	4X0EE10004RBT	3/8	3/8	7/8	2 1/2	.030	4

VariMill XTREME • Series 4XOE • Radiused • 4 Flute • Weldon® Shank • Inch

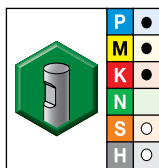
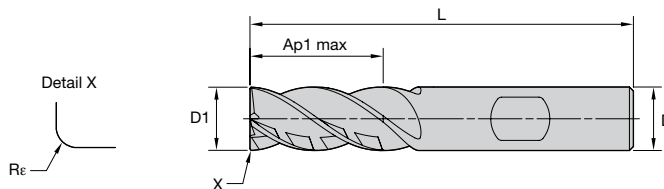

● first choice  
○ alternate choice

WS15PE

order #	catalog #	D1	D	length of cut Ap1 max	length L	Re	ZU
6828776	4X0EE13005RAW	1/2	1/2	1	3	.015	4
6828778	4X0EE13015RAW	1/2	1/2	1 1/4	3 1/4	.015	4
6828779	4X0EE13015RBW	1/2	1/2	1 1/4	3 1/4	.030	4
6828780	4X0EE13015RCW	1/2	1/2	1 1/4	3 1/4	.060	4
6828971	4X0EE13015REW	1/2	1/2	1 1/4	3 1/4	.120	4
6828975	4X0EE16006RAW	5/8	5/8	1 1/4	3 1/2	.015	4
6828978	4X0EE19007RAW	3/4	3/4	1 1/2	4	.015	4
6828979	4X0EE19007RBW	3/4	3/4	1 1/2	4	.030	4
6829168	4X0EE25008RAW	1	1	1 1/2	4 1/2	.015	4
6829169	4X0EE25008RBW	1	1	1 1/2	4 1/2	.030	4

INDEXABLE MILLING

## VariMill XTREME • Series 4X1E • Square End • 4 Flute • Weldon® Shank • Inch

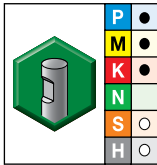
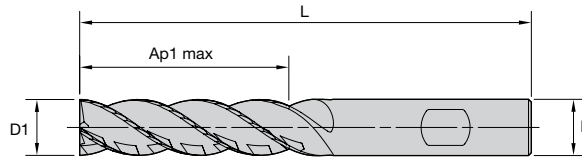

● first choice  
○ alternate choice

WS15PE

order #	catalog #	D1	D	length of cut Ap1 max	length L	ZU
6828972	4X1EE13005SZW	1/2	1/2	2	4	4
6828976	4X1EE16006SZW	5/8	5/8	2 1/4	5	4
6828980	4X1EE19007SZW	3/4	3/4	2 1/4	5	4
6829311	4X1EE25008SZW	1	1	2 1/4	5	4

SOLID END MILLING

HOLEMAKING

## VariMill XTREME • Series 4X1E • Square End • 4 Flute • Cylindrical Shank • Inch

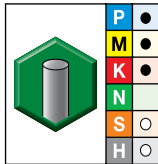
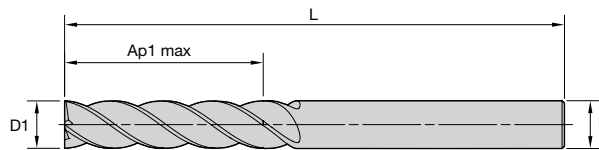

● first choice  
○ alternate choice

WS15PE

order #	catalog #	D1	D	length of cut Ap1 max	length L	ZU
6828604	4X1EE08003SZT	5/16	5/16	1.25	3 1/4	4

TAPPING

TURNING

## VariMill XTREME • Series 4X1E • Radiused • 4 Flute • Cylindrical Shank • Inch

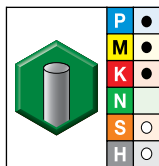
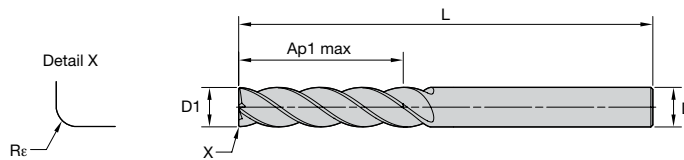

● first choice  
○ alternate choice

WS15PE

order #	catalog #	D1	D	length of cut Ap1 max	length L	Re	ZU
6828605	4X1EE08003RAT	5/16	5/16	1.25	3 1/4	.015	4
6828606	4X1EE08003RBT	5/16	5/16	1.25	3 1/4	.030	4

VariMill XTREME • Series 4X1E • Radiused • 4 Flute • Weldon® Shank • Inch

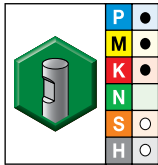
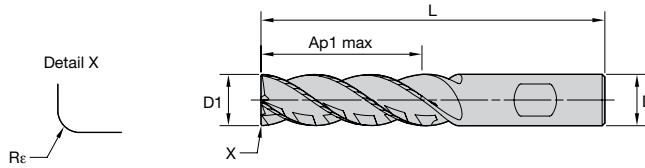

● first choice  
○ alternate choice

WS15PE

order #	catalog #	D1	D	length of cut Ap1 max	length L	Re	ZU
6828973	4X1EE13005RBW	1/2	1/2	2	4	.030	4
6829161	4X1EE19007RAW	3/4	3/4	2 1/4	5	.015	4
6829164	4X1EE19007RBW	3/4	3/4	2 1/4	5	.030	4
6829312	4X1EE25008RAW	1	1	2 1/4	5	.015	4
6829313	4X1EE25008RBW	1	1	2 1/4	5	.030	4

VariMill XTREME • Series 4X4E • Square End • 4 Flute • Cylindrical Shank • Inch

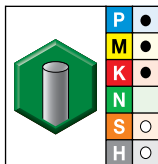
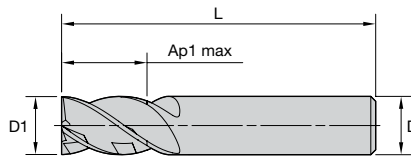

● first choice  
○ alternate choice

WS15PE

order #	catalog #	D1	D	length of cut Ap1 max	length L	ZU
6827744	4X4EE03001SZT	1/8	1/8	1/4	1 1/2	4
6827748	4X4EE05000SZT	3/16	3/16	5/16	1 1/2	4
6828403	4X4EE07002SZT	1/4	1/4	3/8	2	4
6828408	4X4EE08003SZT	5/16	5/16	1/2	2	4
6828607	4X4EE10004SZT	3/8	3/8	1/2	2	4

INDEXABLE MILLING

VariMill XTREME • Series 4X4E • Radiused • 4 Flute • Cylindrical Shank • Inch

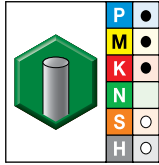
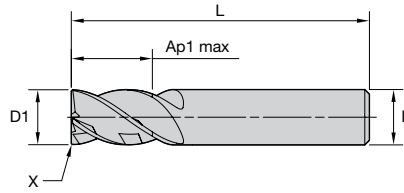
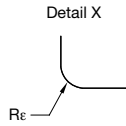

● first choice  
○ alternate choice

WS15PE

order #	catalog #	D1	D	length of cut Ap1 max	length L	Re	ZU
6827745	4X4EE03001RAT	1/8	1/8	1/4	1 1/2	.015	4
6827749	4X4EE05000RAT	3/16	3/16	5/16	1 1/2	.015	4
6828404	4X4EE07002RAT	1/4	1/4	3/8	2	.015	4
6828409	4X4EE08003RAT	5/16	5/16	1/2	2	.015	4
6828608	4X4EE10004RAT	3/8	3/8	1/2	2	.015	4

HOLEMAKING

VariMill XTREME • Series 4X4E • Radiused • 4 Flute • Weldon® Shank • Inch

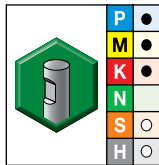
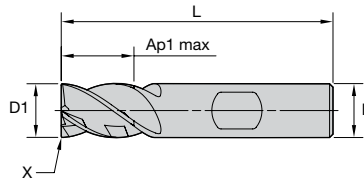
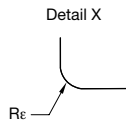

● first choice  
○ alternate choice

WS15PE

order #	catalog #	D1	D	length of cut Ap1 max	length L	Re	ZU
6828773	4X4EE13005RAW	1/2	1/2	5/8	2 1/2	.015	4
6828774	4X4EE13005RBW	1/2	1/2	5/8	2 1/2	.030	4
6828772	4X4EE13005SZW	1/2	1/2	5/8	2 1/2	—	4

TURNING

VariMill XTREME • Series 4X6E • Square End • 4 Flute • Weldon® Shank • Inch

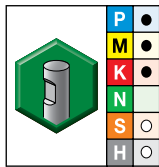
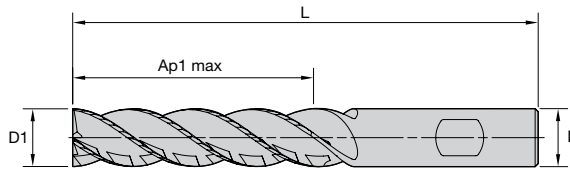

● first choice  
○ alternate choice

WS15PE

order #	catalog #	D1	D	length of cut Ap1 max	length L	ZU
6829165	4X6EE19007SZW	3/4	3/4	3	6	4
6829170	4X6EE25018SZW	1	1	2	5	4

VariMill XTREME • Series 4X6E • Radiused • 4 Flute • Weldon Shank • Inch

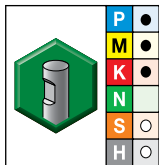
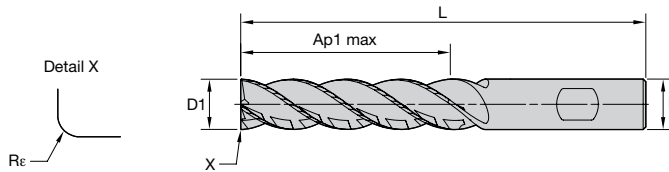

● first choice  
○ alternate choice

WS15PE

order #	catalog #	D1	D	length of cut Ap1 max	length L	Re	ZU
6829166	4X6EE19007RAW	3/4	3/4	3	6	.015	4

VariMill XTREME • Series 4X0E • Radiused • 4 Flute • Cylindrical Shank • Metric

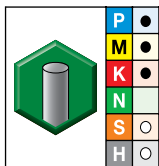
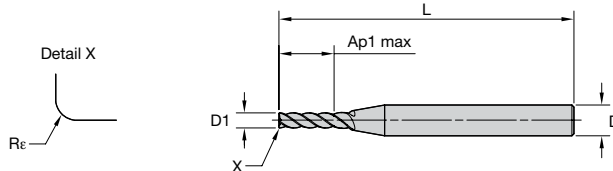

● first choice  
○ alternate choice

WS15PE

order #	catalog #	D1	D	length of cut Ap1 max	length L	Re	ZU
6829314	4X0EM03002RAT	3,0	6	9,50	57	0,20	4
6830480	4X0EM25008RKT	25,0	25	50,00	121	1,50	4
6830671	4X0EM25008RPT	25,0	25	50,00	121	3,00	4

INDEXABLE MILLING

VariMill XTREME • Series 4X0E • Chamfered • 4 Flute • Cylindrical Shank • Metric

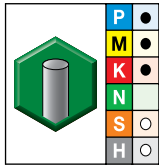
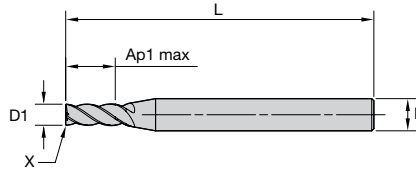
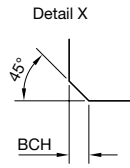

● first choice  
○ alternate choice

WS15PE

order #	catalog #	D1	D	length of cut Ap1 max	length L	BCH	ZU
6829315	4X0EM04002CST	4,0	6	8,00	57	0,10	4
6829320	4X0EM05002CST	5,0	6	10,00	57	0,10	4
6829695	4X0EM06002CST	6,0	6	12,00	57	0,10	4
6829881	4X0EM08003CAT	8,0	8	16,00	63	0,20	4
6829888	4X0EM10004CAT	10,0	10	20,00	72	0,20	4
6830075	4X0EM12005CCT	12,0	12	24,00	83	0,30	4

HOLEMAKING

VariMill XTREME • Series 4X0E • Radiused • 4 Flute • Safe-Lock™ Shank • Metric

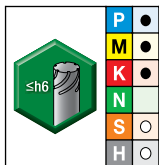
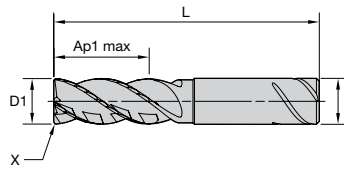
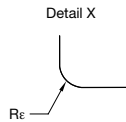

● first choice  
○ alternate choice

WS15PE

order #	catalog #	D1	D	length of cut Ap1 max	length L	Re	ZU
6830479	4X0EM25018RJV	25,0	25	50,00	135	1,00	4

TURNING

VariMill XTREME • Series 4XNE • Square End • 4 Flute • Necked • Cylindrical Shank • Metric

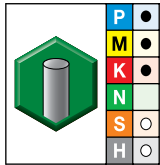

WS15PE

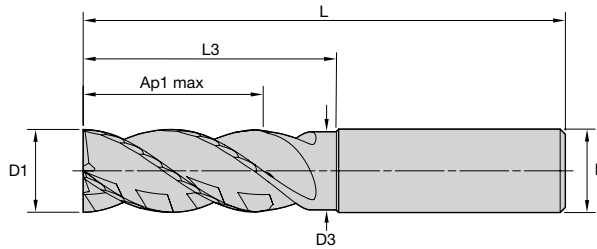

● first choice  
○ alternate choice

order #	catalog #	D1	D	D3	length of cut Ap1 max	L3	length L	ZU
6829316	4XNEM04002SZT	4,0	6	3,76	8,00	12,00	57	4
6829691	4XNEM05002SZT	5,0	6	4,70	10,00	15,00	57	4
6829696	4XNEM06002SZT	6,0	6	5,64	12,00	18,00	57	4
6829882	4XNEM08003SZT	8,0	8	7,52	16,00	24,00	63	4
6829889	4XNEM10004SZT	10,0	10	9,40	20,00	30,00	72	4
6830076	4XNEM12005SZT	12,0	12	11,28	24,00	36,00	83	4
6830284	4XNEM16006SZT	16,0	16	15,04	32,00	48,00	92	4
6830472	4XNEM20007SZT	20,0	20	18,80	40,00	60,00	115	4

VariMill XTREME • Series 4XNE • Chamfered • 4 Flute • Cylindrical Shank • Metric

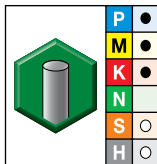

WS15PE

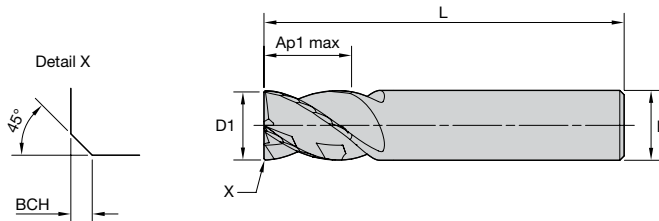

● first choice  
○ alternate choice

order #	catalog #	D1	D	length of cut Ap1 max	length L	BCH	ZU
6830283	4X0EM16006CCT	16,0	16	18,00	82	0,30	4

INDEXABLE MILLING

SOLID END MILLING

HOLEMAKING

TAPPING

TURNING



## VariMill XTREME • Series 4XNE • Chamfered • 4 Flute • Necked • Weldon® Shank • Metric

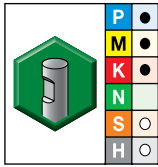

WS15PE

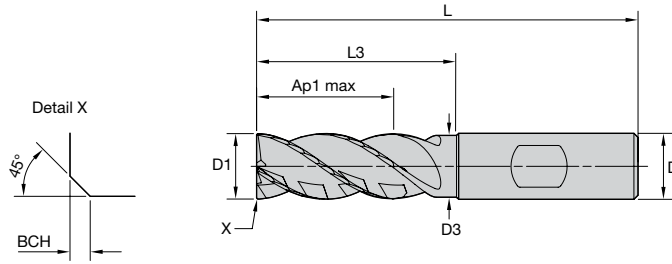

● first choice  
○ alternate choice

order #	catalog #	D1	D	D3	length of cut Ap1 max	L3	length L	BCH	ZU
6829319	4XNEM04002CSW	4,0	6	3,76	12,00	16,00	57	0,10	4
6829694	4XNEM05002CSW	5,0	6	4,70	13,00	18,00	57	0,10	4
6829700	4XNEM06002CSW	6,0	6	5,64	13,00	21,00	57	0,10	4
6829887	4XNEM08003CAW	8,0	8	7,52	16,00	27,00	63	0,20	4
6830074	4XNEM10004CAW	10,0	10	9,40	22,00	32,00	72	0,20	4
6830282	4XNEM12005CCW	12,0	12	11,28	26,00	36,00	83	0,30	4
6830285	4XNEM16006CCW	16,0	16	15,04	32,00	48,00	92	0,30	4
6830473	4XNEM20007CCW	20,0	20	18,80	40,00	60,00	115	0,30	4

INDEXABLE MILLING

SOLID END MILLING

HOLEMAKING

TAPPING

TURNING

VariMill XTREME • Series 4XNE • Radiused • 4 Flute • Necked • Cylindrical Shank • Metric

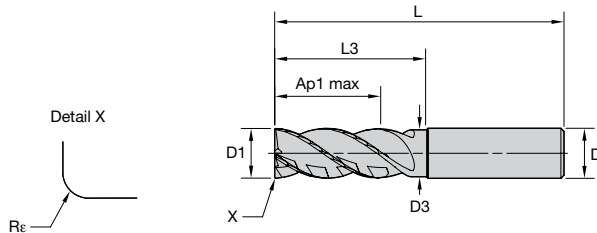
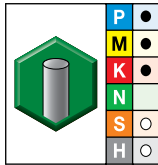

● first choice  
○ alternate choice

WS15PE

order #	catalog #	D1	D	D3	length of cut Ap1 max	L3	length L	Re	ZU
6829317	4XNEM04002RAT	4,0	6	3,76	8,00	12,00	57	0,20	4
6829318	4XNEM04002RET	4,0	6	3,76	8,00	12,00	57	0,50	4
6829692	4XNEM05002RAT	5,0	6	4,70	10,00	15,00	57	0,20	4
6829693	4XNEM05002RET	5,0	6	4,70	10,00	15,00	57	0,50	4
6829697	4XNEM06002RAT	6,0	6	5,64	12,00	18,00	57	0,20	4
6829698	4XNEM06002RET	6,0	6	5,64	12,00	18,00	57	0,50	4
6829699	4XNEM06002RJT	6,0	6	5,64	12,00	18,00	57	1,00	4
6829883	4XNEM08003RAT	8,0	8	7,52	16,00	24,00	63	0,20	4
6829884	4XNEM08003RET	8,0	8	7,52	16,00	24,00	63	0,50	4
6829885	4XNEM08003RJT	8,0	8	7,52	16,00	24,00	63	1,00	4
6829886	4XNEM08003RKT	8,0	8	7,52	16,00	24,00	63	1,50	4
6829890	4XNEM10004RCT	10,0	10	9,40	20,00	30,00	72	0,30	4
6830071	4XNEM10004RET	10,0	10	9,40	20,00	30,00	72	0,50	4
6830072	4XNEM10004RJT	10,0	10	9,40	20,00	30,00	72	1,00	4
6830073	4XNEM10004RKT	10,0	10	9,40	20,00	30,00	72	1,50	4
6830077	4XNEM12005RET	12,0	12	11,28	24,00	36,00	83	0,50	4
6830079	4XNEM12005RKT	12,0	12	11,28	24,00	36,00	83	1,50	4
6830080	4XNEM12005RMT	12,0	12	11,28	24,00	36,00	83	2,00	4
6830281	4XNEM12005RPT	12,0	12	11,28	24,00	36,00	83	3,00	4
6830286	4XNEM16006RET	16,0	16	15,04	32,00	48,00	92	0,50	4
6830288	4XNEM16006RKT	16,0	16	15,04	32,00	48,00	92	1,50	4
6830289	4XNEM16006RPT	16,0	16	15,04	32,00	48,00	92	3,00	4
6830471	4XNEM16006RQT	16,0	16	15,04	32,00	48,00	92	4,00	4
6830474	4XNEM20007RET	20,0	20	18,80	40,00	60,00	115	0,50	4
6830476	4XNEM20007RKT	20,0	20	18,80	40,00	60,00	115	1,50	4
6830477	4XNEM20007RPT	20,0	20	18,80	40,00	60,00	115	3,00	4
6830478	4XNEM20007RRT	20,0	20	18,80	40,00	60,00	115	5,00	4

INDEXABLE MILLING

SOLID END MILLING

HOLEMAKING

TAPPING

TURNING

VariMill XTREME • Series 4XNE • Radiused • 4 Flute • Necked • Safe-Lock™ Shank • Metric

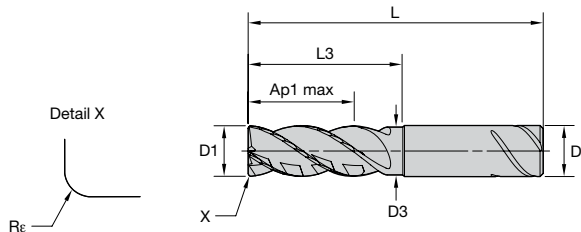
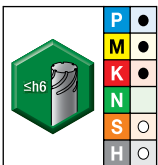

● first choice  
○ alternate choice

WS15PE

order #	catalog #	D1	D	D3	length of cut Ap1 max	L3	length L	Re	ZU
6830078	4XNEM12005RJV	12,0	12	11,28	24,00	36,00	83	1,00	4
6830287	4XNEM16006RJV	16,0	16	15,04	32,00	48,00	92	1,00	4
6830475	4XNEM20007RJV	20,0	20	18,80	40,00	60,00	115	1,00	4

VariMill XTREME • Side Milling and Slotting • Application Data • WS15PE • Inch

Material Group	Side Milling (A) and Slotting (B)			Recommended feed per tooth (fz = mm/th) for side milling (A). For slotting (B), reduce fz by 20%.																
	A		B	WS15PE Cutting Speed – vc m/min			D1 – Diameter													
	ap	ae	ap	min	Start	max	in	1/8	5/32	3/16	1/4	9/32	5/16	3/8	1/2	5/8	3/4	1		
P	0	1.5 x D1	0.5 x D1	1.25 x D1	490	580	660	IPT	.0009	.0012	.0016	.0019	.0022	.0026	.0031	.0036	.0044	.0049	.0054	
	1	1.5 x D1	0.5 x D1	1.25 x D1	490	580	660	IPT	.0009	.0012	.0016	.0019	.0022	.0026	.0031	.0036	.0044	.0049	.0054	
	2	1.5 x D1	0.5 x D1	1.25 x D1	460	540	620	IPT	.0009	.0012	.0016	.0019	.0022	.0026	.0031	.0036	.0044	.0049	.0054	
	3	1.5 x D1	0.5 x D1	1.25 x D1	390	450	520	IPT	.0007	.0010	.0013	.0016	.0019	.0022	.0026	.0030	.0038	.0044	.0049	
	4	1.5 x D1	0.5 x D1	1.25 x D1	300	400	490	IPT	.0007	.0009	.0012	.0014	.0017	.0019	.0023	.0027	.0033	.0038	.0042	
	5	1.5 x D1	0.5 x D1	1.25 x D1	200	260	330	IPT	.0006	.0008	.0011	.0013	.0015	.0017	.0021	.0024	.0030	.0035	.0039	
M	1	1.5 x D1	0.5 x D1	1.25 x D1	300	340	380	IPT	.0007	.0010	.0013	.0016	.0019	.0022	.0026	.0030	.0038	.0044	.0049	
	2	1.5 x D1	0.5 x D1	1.25 x D1	200	230	260	IPT	.0006	.0008	.0011	.0013	.0015	.0017	.0021	.0024	.0030	.0035	.0039	
	3	1.5 x D1	0.5 x D1	1.0 x D1	200	210	230	IPT	.0005	.0007	.0009	.0011	.0013	.0015	.0017	.0020	.0025	.0028	.0031	
K	1	1.5 x D1	0.5 x D1	1.0 x D1	390	440	490	IPT	.0009	.0012	.0016	.0019	.0022	.0026	.0031	.0036	.0044	.0049	.0054	
	2	1.5 x D1	0.5 x D1	1.0 x D1	360	410	460	IPT	.0007	.0010	.0013	.0016	.0019	.0022	.0026	.0030	.0038	.0044	.0049	
	3	1.5 x D1	0.5 x D1	1.0 x D1	360	390	430	IPT	.0006	.0008	.0011	.0013	.0015	.0017	.0021	.0024	.0030	.0035	.0039	
S	1	1.5 x D1	0.5 x D1	0.75 x D1	160	230	300	IPT	.0007	.0011	.0015	.0020	.0023	.0026	.0029	.0034	.0039	.0045	.0048	
	2	1.5 x D1	0.5 x D1	0.75 x D1	80	105	130	IPT	.0004	.0006	.0008	.0010	.0012	.0014	.0015	.0018	.0021	.0024	.0026	
	3	1.5 x D1	0.5 x D1	0.5 x D1	80	105	130	IPT	.0004	.0006	.0008	.0010	.0012	.0014	.0015	.0018	.0021	.0024	.0026	
	4	1.5 x D1	0.5 x D1	1.25 x D1	160	180	200	IPT	.0005	.0008	.0011	.0014	.0017	.0019	.0021	.0025	.0028	.0033	.0036	
H	1	1.5 x D1	0.5 x D1	1.0 x D1	260	360	460	IPT	.0007	.0009	.0012	.0014	.0017	.0019	.0023	.0027	.0033	.0038	.0042	
	2	1.5 x D1	0.5 x D1	1.0 x D1	230	310	390	IPT	.0005	.0007	.0009	.0011	.0013	.0015	.0017	.0020	.0025	.0028	.0031	

NOTE: See page B177 for more information on VARIMILL™ XTREME™ adjustment factors for feed calculations.

VariMill XTREME • Ramping • Application Data • WS15PE • Inch

Material Group	Max Depth	Helical Interpolation/Ramping 0°-15°			Recommended feed per tooth (fz = ipt) for helical interpolation and ramping – fz x 2																
		WS15PE Cutting Speed – vc m/min			Diameter – D1 [Ømin – Ømax]																
		min	Start	max	mm min-max	1/8	5/32	3/16	1/4	9/32	5/16	3/8	1/2	5/8	3/4	1					
						.144-.238	.180-.297	.216-.356	.288-.475	.323-.534	.359-.594	.431-.713	.575-.950	.719-1.188	.863-1.425	1.150-1.900					
P	0	1.25 x D1	490	580	660	IPT	.0009	.0012	.0016	.0019	.0023	.0026	.0031	.0036	.0044	.0049	.0054				
	1	1.25 x D1	490	580	660	IPT	.0009	.0012	.0016	.0019	.0023	.0026	.0031	.0036	.0044	.0049	.0054				
	2	1.25 x D1	460	540	620	IPT	.0009	.0012	.0016	.0019	.0023	.0026	.0031	.0036	.0044	.0049	.0054				
	3	1.25 x D1	390	450	520	IPT	.0007	.0010	.0013	.0016	.0019	.0022	.0026	.0030	.0038	.0044	.0049				
	4	1.25 x D1	300	400	490	IPT	.0007	.0009	.0012	.0014	.0017	.0019	.0023	.0027	.0033	.0038	.0042				
	5	1.25 x D1	200	260	330	IPT	.0006	.0008	.0011	.0013	.0015	.0017	.0021	.0024	.0030	.0035	.0039				
M	1	1.25 x D1	300	340	380	IPT	.0007	.0010	.0013	.0016	.0019	.0022	.0026	.0030	.0038	.0044	.0049				
	2	1.25 x D1	200	230	260	IPT	.0006	.0008	.0011	.0013	.0015	.0017	.0021	.0024	.0030	.0035	.0039				
	3	1.0 x D1	200	210	230	IPT	.0005	.0007	.0009	.0011	.0013	.0015	.0017	.0020	.0025	.0028	.0031				
K	1	1.0 x D1	390	440	490	IPT	.0009	.0012	.0016	.0019	.0023	.0026	.0031	.0036	.0044	.0049	.0054				
	2	1.0 x D1	360	410	460	IPT	.0007	.0010	.0013	.0016	.0019	.0022	.0026	.0030	.0038	.0044	.0049				
	3	1.0 x D1	360	390	430	IPT	.0006	.0008	.0011	.0013	.0015	.0017	.0021	.0024	.0030	.0035	.0039				
S	1	0.75 x D1	160	230	300	IPT	.0007	.0011	.0015	.0020	.0023	.0026	.0029	.0034	.0039	.0045	.0048				
	2	0.75 x D1	80	105	130	IPT	.0004	.0006	.0008	.0010	.0012	.0014	.0015	.0018	.0021	.0024	.0026				
	3	0.5 x D1	80	105	130	IPT	.0004	.0006	.0008	.0010	.0012	.0014	.0015	.0018	.0021	.0024	.0026				
	4	1.25 x D1	160	180	200	IPT	.0005	.0008	.0011	.0014	.0017	.0019	.0021	.0025	.0028	.0033	.0036				
H	1	1.0 x D1	260	360	460	IPT	.0007	.0009	.0012	.0014	.0017	.0019	.0023	.0027	.0033	.0038	.0042				
	2	1.0 x D1	230	310	390	IPT	.0005	.0007	.0009	.0011	.0013	.0015	.0017	.0020	.0025	.0028	.0031				

INDEXABLE MILLING

SOLID END MILLING

HOLEMAKING

TAPPING



TURNING

VariMill XTREME • Ramping • Application Data • WS15PE • Inch

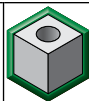

Material Group	Max Depth	Helical Interpolation/Ramping 15°-30°			Recommended feed per tooth (fz = ipt) for helical interpolation and ramping – fz x 2												
		Cutting Speed – vc m/min			Diameter – D1 [Ømin – Ømax]												
		min	Start	max	mm min-max	1/8	5/32	3/16	1/4	9/32	5/16	3/8	1/2	5/8	3/4	1	
						.144-.238	.180-.297	.216-.356	.288-.475	.323-.534	.359-.594	.431-.713	.575-.950	.719-1.188	.863-1.425	1.150-1.900	
P	0	1.25 x D1	490	530	580	IPT	.0007	.0009	.0012	.0014	.0017	.0020	.0023	.0027	.0033	.0037	.0041
	1	1.25 x D1	490	530	580	IPT	.0007	.0009	.0012	.0014	.0017	.0020	.0023	.0027	.0033	.0037	.0041
	2	1.25 x D1	460	500	540	IPT	.0007	.0009	.0012	.0014	.0017	.0020	.0023	.0027	.0033	.0037	.0041
	3	1.25 x D1	390	420	450	IPT	.0005	.0008	.0010	.0012	.0014	.0017	.0020	.0023	.0029	.0033	.0037
	4	1.25 x D1	300	350	400	IPT	.0005	.0007	.0009	.0011	.0013	.0014	.0017	.0020	.0025	.0029	.0032
	5	1.25 x D1	200	235	260	IPT	.0005	.0006	.0008	.0010	.0011	.0013	.0016	.0018	.0023	.0026	.0029
M	6	1.25 x D1	160	180	200	IPT	.0004	.0005	.0007	.0008	.0010	.0011	.0013	.0015	.0019	.0021	.0023
	1	1.25 x D1	300	320	340	IPT	.0005	.0008	.0010	.0012	.0014	.0017	.0020	.0023	.0029	.0033	.0037
	2	1.25 x D1	200	215	230	IPT	.0005	.0006	.0008	.0010	.0011	.0013	.0016	.0018	.0023	.0026	.0029
K	3	1.0 x D1	200	105	210	IPT	.0004	.0005	.0007	.0008	.0010	.0011	.0013	.0015	.0019	.0021	.0023
	1	1.0 x D1	390	415	440	IPT	.0007	.0009	.0012	.0014	.0017	.0020	.0023	.0027	.0033	.0037	.0041
	2	1.0 x D1	360	380	410	IPT	.0005	.0008	.0010	.0012	.0014	.0017	.0020	.0023	.0029	.0033	.0037
S	3	1.0 x D1	360	375	390	IPT	.0005	.0006	.0008	.0010	.0011	.0013	.0016	.0018	.0023	.0026	.0029
	1	0.75 x D1	160	190	230	IPT	.0005	.0008	.0010	.0012	.0014	.0017	.0020	.0023	.0029	.0033	.0037
	2	0.75 x D1	80	90	100	IPT	.0003	.0005	.0005	.0006	.0008	.0008	.0011	.0012	.0015	.0017	.002
	3	0.5 x D1	80	90	100	IPT	.0003	.0005	.0005	.0006	.0008	.0008	.0011	.0012	.0015	.0017	.002
H	4	1.25 x D1	160	170	180	IPT	.0004	.0005	.0007	.0008	.0011	.0012	.0014	.0017	.0021	.0024	.0027
	1	1.0 x D1	260	310	360	IPT	.0005	.0007	.0009	.0011	.0013	.0014	.0017	.0020	.0025	.0029	.0032
	2	1.0 x D1	230	270	310	IPT	.0004	.0005	.0007	.0008	.0010	.0011	.0013	.0015	.0019	.0021	.0023

Material Group	Max Depth	Helical Interpolation/Ramping 30°-45°			Recommended feed per tooth (fz = ipt) for helical interpolation and ramping – fz x 2												
		Cutting Speed – vc m/min			Diameter – D1 [Ømin – Ømax]												
		min	Start	max	mm min-max	1/8	5/32	3/16	1/4	9/32	5/16	3/8	1/2	5/8	3/4	1	
						.144-.238	.180-.297	.216-.356	.288-.475	.323-.534	.359-.594	.431-.713	.575-.950	.719-1.188	.863-1.425	1.150-1.900	
P	0	1.25 x D1	420	450	495	IPT	.0005	.0007	.0010	.0011	.0014	.0016	.0019	.0022	.0026	.0029	.0032
	1	1.25 x D1	420	450	495	IPT	.0005	.0007	.0010	.0011	.0014	.0016	.0019	.0022	.0026	.0029	.0032
	2	1.25 x D1	420	450	495	IPT	.0005	.0007	.0010	.0011	.0014	.0016	.0019	.0022	.0026	.0029	.0032
	3	1.25 x D1	315	345	360	IPT	.0004	.0006	.0008	.0010	.0011	.0013	.0016	.0018	.0023	.0026	.0029
	4	1.25 x D1	270	300	330	IPT	.0004	.0005	.0007	.0008	.0010	.0011	.0014	.0016	.0020	.0023	.0025
	5	1.25 x D1	210	225	240	IPT	.0004	.0005	.0007	.0008	.0009	.0010	.0013	.0014	.0018	.0021	.0023
M	6	1.25 x D1	165	180	195	IPT	.0003	.0004	.0005	.0007	.0008	.0009	.0010	.0012	.0015	.0017	.0019
	1	1.25 x D1	225	255	270	IPT	.0004	.0006	.0008	.0010	.0011	.0013	.0016	.0018	.0023	.0026	.0029
	2	1.25 x D1	150	165	180	IPT	.0004	.0005	.0007	.0008	.0009	.0010	.0013	.0014	.0018	.0021	.0023
K	3	1.0 x D1	135	150	165	IPT	.0003	.0004	.0005	.0007	.0008	.0009	.0010	.0012	.0015	.0017	.0019
	1	1.0 x D1	330	360	390	IPT	.0005	.0007	.0010	.0011	.0014	.0016	.0019	.0022	.0026	.0029	.0032
	2	1.0 x D1	300	330	360	IPT	.0004	.0006	.0008	.0010	.0011	.0013	.0016	.0018	.0023	.0026	.0029
S	3	1.0 x D1	270	300	330	IPT	.0004	.0005	.0007	.0008	.0009	.0010	.0013	.0014	.0018	.0021	.0023
	1	0.75 x D1	240	255	270	IPT	.0004	.0006	.0008	.0010	.0011	.0013	.0016	.0018	.0023	.0026	.0029
	2	0.75 x D1	60	75	84	IPT	.0002	.0004	.0004	.0005	.0006	.0007	.0008	.0010	.0012	.0014	.0016
	3	0.5 x D1	60	75	84	IPT	.0002	.0004	.0004	.0005	.0006	.0007	.0008	.0010	.0012	.0014	.0016
H	4	1.25 x D1	105	120	135	IPT	.0003	.0004	.0005	.0007	.0008	.0010	.0011	.0013	.0017	.0019	.0022
	1	1.0 x D1	225	240	255	IPT	.0004	.0005	.0007	.0008	.0010	.0011	.0014	.0016	.0020	.0023	.0025
	2	1.0 x D1	195	210	225	IPT	.0003	.0004	.0005	.0007	.0008	.0009	.0010	.0012	.0015	.0017	.0019

VariMill XTREME • Plunging/Drilling • Application Data • WS15PE • Inch

Material Group	  			Recommended feed per revolution (fn =mm/rev) for plunging and drilling																		
	Plunging/Drilling			WS15PE			D1 – Diameter															
				Cutting Speed – vc m/min																		
	Max Depth	Applicable	Coolant	min	Start	max	in	1/8	5/32	3/16	1/4	9/32	5/16	3/8	1/2	5/8	3/4	1				
P	0	1.5 x D	●	Preferred	420	450	495	IPR	.0013	.0016	.0450	.0022	.0024	.0026	.0031	.0037	.0047	.0063	.0071			
	1	1.5 x D	●	Required	420	450	495	IPR	.0013	.0016	.0450	.0022	.0024	.0026	.0031	.0037	.0047	.0063	.0071			
	2	1.5 x D	●	Required	420	450	495	IPR	.0013	.0016	.0450	.0022	.0024	.0026	.0031	.0037	.0047	.0063	.0071			
	3	1 x D	●	Required	315	345	360	IPR	.0008	.0011	.0330	.0016	.0018	.0020	.0024	.0028	.0039	.0049	.0059			
	4	1 x D	●	Required	270	300	330	IPR	.0008	.0011	.0330	.0016	.0018	.0020	.0024	.0028	.0039	.0049	.0059			
	5	0.5 x D	●	Required	210	225	240	IPR	.0006	.0007	.0200	.0010	.0012	.0014	.0016	.0020	.0026	.0033	.0039			
M	6	0.5 x D	●	Required	165	180	195	IPR	.0006	.0007	.0200	.0010	.0012	.0014	.0016	.0020	.0026	.0033	.0039			
	1	0.75 x D	●	Required	225	255	270	IPR	.0008	.0011	.0330	.0016	.0018	.0020	.0024	.0028	.0039	.0049	.0059			
	2	0.5 x D	●	Required	150	165	180	IPR	.0006	.0007	.0200	.0010	.0012	.0014	.0016	.0020	.0026	.0033	.0039			
K	3	0.5 x D	●	Required	135	150	165	IPR	.0006	.0007	.0200	.0010	.0012	.0014	.0016	.0020	.0026	.0033	.0039			
	1	1.5 x D	●	Preferred	330	360	390	IPR	.0013	.0016	.0450	.0022	.0024	.0026	.0031	.0037	.0047	.0063	.0071			
	2	1 x D	●	Required	300	330	360	IPR	.0008	.0011	.0330	.0016	.0018	.0020	.0024	.0028	.0039	.0049	.0059			
S	3	1 x D	●	Required	270	300	330	IPR	.0008	.0011	.0330	.0016	.0018	.0020	.0024	.0028	.0039	.0049	.0059			
	1	0.3 x D	○	Required	240	255	270	IPR	.0008	.0011	.0330	.0016	.0018	.0020	.0024	.0028	.0039	.0049	.0059			
	2	0.1 x D	○	Required	60	75	84	IPR	.0004	.0005	.0150	.0007	.0008	.0009	.0011	.0013	.0018	.0024	.0028			
	3	0.1 x D	○	Required	60	75	84	IPR	.0004	.0005	.0150	.0007	.0008	.0009	.0011	.0013	.0018	.0024	.0028			
H	4	0.2 x D	○	Required	105	120	135	IPR	.0006	.0007	.0200	.0010	.0012	.0014	.0016	.0020	.0026	.0033	.0039			
	1	0.3 x D	○	Required	225	240	255	IPR	.0008	.0011	.0330	.0016	.0018	.0020	.0024	.0028	.0039	.0049	.0059			
2	0.2 x D	○	Required	195	210	225	IPR	.0006	.0007	.0200	.0010	.0012	.0014	.0016	.0020	.0026	.0033	.0039				

VariMill XTREME • Side Milling and Slotting • Application Data • WS15PE • Metric

Material Group	  			Recommended feed per tooth (fz = mm/tooth) for side milling (A). For slotting (B), reduce fz by 20%.																		
	Side Milling (A) and Slotting (B)			WS15PE			D1 – Diameter															
				Cutting Speed – vc m/min																		
	ap	ae	ap	min	Start	max	mm	3,0	4,0	5,0	6,0	8,0	10,0	12,0	14,0	16,0	18,0	20,0	25,0			
P	0	1,5 x D1	0,5 x D1	1,25 x D1	150	175	200	fz	0,023	0,031	0,040	0,048	0,066	0,079	0,091	0,102	0,111	0,119	0,125	0,136		
	1	1,5 x D1	0,5 x D1	1,25 x D1	150	175	200	fz	0,023	0,031	0,040	0,048	0,066	0,079	0,091	0,102	0,111	0,119	0,125	0,136		
	2	1,5 x D1	0,5 x D1	1,25 x D1	140	165	190	fz	0,023	0,031	0,040	0,048	0,066	0,079	0,091	0,102	0,111	0,119	0,125	0,136		
	3	1,5 x D1	0,5 x D1	1,25 x D1	120	140	160	fz	0,019	0,026	0,033	0,040	0,055	0,067	0,077	0,087	0,096	0,104	0,111	0,125		
	4	1,5 x D1	0,5 x D1	1,25 x D1	90	120	150	fz	0,018	0,024	0,030	0,036	0,049	0,059	0,069	0,077	0,084	0,091	0,097	0,107		
	5	1,5 x D1	0,5 x D1	1,25 x D1	60	80	100	fz	0,016	0,021	0,027	0,032	0,044	0,053	0,062	0,070	0,077	0,083	0,089	0,100		
M	6	1,5 x D1	0,5 x D1	1,25 x D1	50	65	75	fz	0,013	0,018	0,022	0,027	0,037	0,044	0,051	0,057	0,063	0,067	0,071	0,078		
	1	1,5 x D1	0,5 x D1	1,25 x D1	90	100	115	fz	0,019	0,026	0,033	0,040	0,055	0,067	0,077	0,087	0,096	0,104	0,111	0,125		
	2	1,5 x D1	0,5 x D1	1,25 x D1	60	70	80	fz	0,016	0,021	0,027	0,032	0,044	0,053	0,062	0,070	0,077	0,083	0,089	0,100		
K	3	1,5 x D1	0,5 x D1	1,0 x D1	60	65	70	fz	0,013	0,018	0,022	0,027	0,037	0,044	0,051	0,057	0,063	0,067	0,071	0,078		
	1	1,5 x D1	0,5 x D1	1,0 x D1	120	135	150	fz	0,023	0,031	0,040	0,048	0,066	0,079	0,091	0,102	0,111	0,119	0,125	0,136		
	2	1,5 x D1	0,5 x D1	1,0 x D1	110	125	140	fz	0,019	0,026	0,033	0,040	0,055	0,067	0,077	0,087	0,096	0,104	0,111	0,125		
S	3	1,5 x D1	0,5 x D1	1,0 x D1	110	120	130	fz	0,016	0,021	0,027	0,032	0,044	0,053	0,062	0,070	0,077	0,083	0,089	0,100		
	1	1,5 x D1	0,5 x D1	0,75 x D1	50	70	90	fz	0,017	0,023	0,030	0,036	0,050	0,061	0,070	0,079	0,087	0,095	0,101	0,114		
	2	1,5 x D1	0,5 x D1	0,75 x D1	25	30	40	fz	0,009	0,013	0,016	0,019	0,026	0,032	0,037	0,042	0,046	0,050	0,054	0,061		
	3	1,5 x D1	0,5 x D1	0,5 x D1	25	30	40	fz	0,009	0,013	0,016	0,019	0,026	0,032	0,037	0,042	0,046	0,050	0,054	0,061		
H	4	1,5 x D1	0,5 x D1	1,25 x D1	50	55	60	fz	0,011	0,016	0,021	0,026	0,037	0,045	0,052	0,058	0,064	0,069	0,074	0,084		
	1	1,5 x D1	0,5 x D1	1,0 x D1	80	110	140	fz	0,018	0,024	0,030	0,036	0,049	0,059	0,069	0,077	0,084	0,091	0,097	0,107		
2	1,5 x D1	0,5 x D1	1,0 x D1	70	90	120	fz	0,013	0,018	0,022	0,027	0,037	0,044	0,051	0,057	0,063	0,067	0,071	0,078			

VariMill XTREME • Ramping • Application Data • WS15PE • Metric

Material Group	Helical Interpolation/Ramping		WS15PE		Recommended feed per tooth (fz = mm/z) for helical interpolation and ramping – fz x 2													
	0°-15°		Cutting Speed – vc m/min		Diameter – D1 [Ømin – Ømax]													
	Max Depth	min	Start	max	mm	3,0	4,0	5,0	6,0	8,0	10,0	12,0	14,0	16,0	18,0	20,0	25,0	
					min-max	3,5-5,7	4,6-7,6	5,8-9,5	6,9-11,4	9,2-15,2	11,5-19,0	13,8-22,8	16,1-26,6	18,4-30,4	20,7-34,2	23,0-38,0	28,8-47,5	
P	0	1,25 x D1	150	175	200	fz	0,023	0,031	0,040	0,048	0,066	0,079	0,091	0,102	0,111	0,119	0,125	0,136
	1	1,25 x D1	150	175	200	fz	0,023	0,031	0,040	0,048	0,066	0,079	0,091	0,102	0,111	0,119	0,125	0,136
	2	1,25 x D1	140	165	190	fz	0,023	0,031	0,040	0,048	0,066	0,079	0,091	0,102	0,111	0,119	0,125	0,136
	3	1,25 x D1	120	140	160	fz	0,019	0,026	0,033	0,040	0,055	0,067	0,077	0,087	0,096	0,104	0,111	0,125
	4	1,25 x D1	90	120	150	fz	0,018	0,024	0,030	0,036	0,049	0,059	0,069	0,077	0,084	0,091	0,097	0,107
	5	1,25 x D1	60	80	100	fz	0,016	0,021	0,027	0,032	0,044	0,053	0,062	0,070	0,077	0,083	0,089	0,100
M	1	1,25 x D1	90	100	115	fz	0,019	0,026	0,033	0,040	0,055	0,067	0,077	0,087	0,096	0,104	0,111	0,125
	2	1,25 x D1	60	70	80	fz	0,016	0,021	0,027	0,032	0,044	0,053	0,062	0,070	0,077	0,083	0,089	0,100
	3	1,0 x D1	60	65	70	fz	0,013	0,018	0,022	0,027	0,037	0,044	0,051	0,057	0,063	0,067	0,071	0,078
K	1	1,0 x D1	120	135	150	fz	0,023	0,031	0,040	0,048	0,066	0,079	0,091	0,102	0,111	0,119	0,125	0,136
	2	1,0 x D1	110	125	140	fz	0,019	0,026	0,033	0,040	0,055	0,067	0,077	0,087	0,096	0,104	0,111	0,125
	3	1,0 x D1	110	120	130	fz	0,016	0,021	0,027	0,032	0,044	0,053	0,062	0,070	0,077	0,083	0,089	0,100
S	1	0,75 x D1	50	70	90	fz	0,017	0,023	0,030	0,036	0,050	0,061	0,070	0,079	0,087	0,095	0,101	0,114
	2	0,75 x D1	25	30	40	fz	0,009	0,013	0,016	0,019	0,026	0,032	0,037	0,042	0,046	0,050	0,054	0,061
	3	0,5 x D1	25	30	40	fz	0,009	0,013	0,016	0,019	0,026	0,032	0,037	0,042	0,046	0,050	0,054	0,061
H	1	1,0 x D1	80	110	140	fz	0,018	0,024	0,030	0,036	0,049	0,059	0,069	0,077	0,084	0,091	0,097	0,107
	2	1,0 x D1	70	90	120	fz	0,013	0,018	0,022	0,027	0,037	0,044	0,051	0,057	0,063	0,067	0,071	0,078

Material Group	Helical Interpolation/Ramping		WS15PE		Recommended feed per tooth (fz = mm/z) for helical interpolation and ramping – fz x 2													
	15°-30°		Cutting Speed – vc m/min		Diameter – D1 [Ømin – Ømax]													
	Max Depth	min	Start	max	mm	3,0	4,0	5,0	6,0	8,0	10,0	12,0	14,0	16,0	18,0	20,0	25,0	
					min-max	3,5-5,7	4,6-7,6	5,8-9,5	6,9-11,4	9,2-15,2	11,5-19,0	13,8-22,8	16,1-26,6	18,4-30,4	20,7-34,2	23,0-38,0	28,8-47,5	
P	0	1,25 x D1	150	165	175	fz	0,017	0,023	0,030	0,036	0,050	0,059	0,068	0,076	0,083	0,089	0,094	0,102
	1	1,25 x D1	150	165	175	fz	0,017	0,023	0,030	0,036	0,050	0,059	0,068	0,076	0,083	0,089	0,094	0,102
	2	1,25 x D1	140	155	165	fz	0,017	0,023	0,030	0,036	0,050	0,059	0,068	0,076	0,083	0,089	0,094	0,102
	3	1,25 x D1	120	130	140	fz	0,014	0,019	0,025	0,030	0,041	0,050	0,058	0,065	0,072	0,078	0,083	0,094
	4	1,25 x D1	90	105	120	fz	0,013	0,018	0,022	0,027	0,037	0,045	0,051	0,058	0,063	0,068	0,073	0,080
	5	1,25 x D1	60	70	80	fz	0,012	0,016	0,020	0,024	0,033	0,040	0,046	0,052	0,058	0,062	0,067	0,075
M	1	1,25 x D1	90	95	100	fz	0,014	0,019	0,025	0,030	0,041	0,050	0,058	0,065	0,072	0,078	0,083	0,094
	2	1,25 x D1	60	65	70	fz	0,012	0,016	0,020	0,024	0,033	0,040	0,046	0,052	0,058	0,062	0,067	0,075
	3	1,0 x D1	60	62	65	fz	0,010	0,013	0,017	0,020	0,028	0,033	0,038	0,043	0,047	0,050	0,053	0,059
K	1	1,0 x D1	120	130	135	fz	0,017	0,023	0,030	0,036	0,050	0,059	0,068	0,076	0,083	0,089	0,094	0,102
	2	1,0 x D1	110	120	125	fz	0,014	0,019	0,025	0,030	0,041	0,050	0,058	0,065	0,072	0,078	0,083	0,094
	3	1,0 x D1	110	115	120	fz	0,012	0,016	0,020	0,024	0,033	0,040	0,046	0,052	0,058	0,062	0,067	0,075
S	1	0,75 x D1	50	60	70	fz	0,014	0,019	0,025	0,030	0,041	0,050	0,058	0,065	0,072	0,078	0,083	0,094
	2	0,75 x D1	25	27	30	fz	0,008	0,010	0,013	0,016	0,022	0,026	0,031	0,035	0,038	0,042	0,045	0,051
	3	0,5 x D1	25	27	30	fz	0,008	0,010	0,013	0,016	0,022	0,026	0,031	0,035	0,038	0,042	0,045	0,051
H	1	1,0 x D1	80	95	110	fz	0,013	0,018	0,022	0,027	0,037	0,045	0,051	0,058	0,063	0,068	0,073	0,080
	2	1,0 x D1	70	80	90	fz	0,010	0,013	0,017	0,020	0,028	0,033	0,038	0,043	0,047	0,050	0,053	0,059



VariMill XTREME • Ramping • Application Data • WS15PE • Metric

Material Group	Max Depth	Helical Interpolation/Ramping 30°-45°			Recommended feed per tooth (fz = mm/z) for helical interpolation and ramping – fz x 2														
		WS15PE			Diameter – D1 [Ømin – Ømax]														
		Cutting Speed – vc m/min			mm	3,0	4,0	5,0	6,0	8,0	10,0	12,0	14,0	16,0	18,0	20,0	25,0		
		min	Start	max	min-max	3,5-5,7	4,6-7,6	5,8-9,5	6,9-11,4	9,2-15,2	11,5-19,0	13,8-22,8	16,1-26,6	18,4-30,4	20,7-34,2	23,0-38,0	28,8-47,5		
P	0	1,25 x D1	140	150	165	fz	0,014	0,019	0,024	0,029	0,040	0,048	0,055	0,061	0,067	0,071	0,075	0,082	
	1	1,25 x D1	140	150	165	fz	0,014	0,019	0,024	0,029	0,040	0,048	0,055	0,061	0,067	0,071	0,075	0,082	
	2	1,25 x D1	140	150	165	fz	0,014	0,019	0,024	0,029	0,040	0,048	0,055	0,061	0,067	0,071	0,075	0,082	
	3	1,25 x D1	105	115	120	fz	0,011	0,015	0,020	0,024	0,033	0,040	0,046	0,052	0,058	0,062	0,067	0,075	
	4	1,25 x D1	90	100	110	fz	0,011	0,014	0,018	0,022	0,030	0,036	0,041	0,046	0,051	0,055	0,058	0,064	
	5	1,25 x D1	70	75	80	fz	0,009	0,013	0,016	0,019	0,026	0,032	0,037	0,042	0,046	0,050	0,053	0,060	
M	6	1,25 x D1	55	60	65	fz	0,008	0,011	0,013	0,016	0,022	0,027	0,031	0,034	0,038	0,040	0,043	0,047	
	1	1,25 x D1	75	85	90	fz	0,011	0,015	0,020	0,024	0,033	0,040	0,046	0,052	0,058	0,062	0,067	0,075	
	2	1,25 x D1	50	55	60	fz	0,009	0,013	0,016	0,019	0,026	0,032	0,037	0,042	0,046	0,050	0,053	0,060	
K	3	1,0 x D1	45	50	55	fz	0,008	0,011	0,013	0,016	0,022	0,027	0,031	0,034	0,038	0,040	0,043	0,047	
	1	1,0 x D1	110	120	130	fz	0,014	0,019	0,024	0,029	0,040	0,048	0,055	0,061	0,067	0,071	0,075	0,082	
	2	1,0 x D1	100	110	120	fz	0,011	0,015	0,020	0,024	0,033	0,040	0,046	0,052	0,058	0,062	0,067	0,075	
S	3	1,0 x D1	90	100	110	fz	0,009	0,013	0,016	0,019	0,026	0,032	0,037	0,042	0,046	0,050	0,053	0,060	
	1	0,75 x D1	80	85	90	fz	0,011	0,015	0,020	0,024	0,033	0,040	0,046	0,052	0,058	0,062	0,067	0,075	
	2	0,75 x D1	20	25	28	fz	0,006	0,008	0,011	0,013	0,017	0,021	0,025	0,028	0,031	0,033	0,036	0,040	
	3	0,5 x D1	20	25	28	fz	0,006	0,008	0,011	0,013	0,017	0,021	0,025	0,028	0,031	0,033	0,036	0,040	
H	4	1,25 x D1	35	40	45	fz	0,008	0,010	0,014	0,017	0,024	0,029	0,034	0,038	0,042	0,046	0,049	0,055	
	1	1,0 x D1	75	80	85	fz	0,011	0,014	0,018	0,022	0,030	0,036	0,041	0,046	0,051	0,055	0,058	0,064	
	2	1,0 x D1	65	70	75	fz	0,008	0,011	0,013	0,016	0,022	0,027	0,031	0,034	0,038	0,040	0,043	0,047	

VariMill XTREME • Plunging/Drilling • Application Data • WS15PE • Metric

Material Group	Max Depth	Plunging/Drilling		Recommended feed per revolution (fn = mm/rev) for plunging and drilling																	
		Applicable	Coolant	WS15PE			D1 – Diameter														
				Cutting Speed – vc m/min			mm	3,0	4,0	5,0	6,0	8,0	10,0	12,0	14,0	16,0	18,0	20,0	25,0		
				min	Start	max	mm	3,0	4,0	5,0	6,0	8,0	10,0	12,0	14,0	16,0	18,0	20,0	25,0		
P	0	1,5 x D	●	Preferred	140	150	165	fn	0,033	0,040	0,045	0,055	0,065	0,080	0,095	0,110	0,120	0,140	0,160	0,180	
	1	1,5 x D	●	Required	140	150	165	fn	0,033	0,040	0,045	0,055	0,065	0,080	0,095	0,110	0,120	0,140	0,160	0,180	
	2	1,5 x D	●	Required	140	150	165	fn	0,033	0,040	0,045	0,055	0,065	0,080	0,095	0,110	0,120	0,140	0,160	0,180	
	3	1 x D	●	Required	105	115	120	fn	0,020	0,028	0,033	0,040	0,050	0,060	0,070	0,085	0,100	0,110	0,125	0,150	
	4	1 x D	●	Required	90	100	110	fn	0,020	0,028	0,033	0,040	0,050	0,060	0,070	0,085	0,100	0,110	0,125	0,150	
	5	0,5 x D	●	Required	70	75	80	fn	0,014	0,018	0,020	0,025	0,035	0,040	0,050	0,055	0,065	0,075	0,085	0,100	
M	6	0,5 x D	●	Required	55	60	65	fn	0,014	0,018	0,020	0,025	0,035	0,040	0,050	0,055	0,065	0,075	0,085	0,100	
	1	0,75 x D	●	Required	75	85	90	fn	0,020	0,028	0,033	0,040	0,050	0,060	0,070	0,085	0,100	0,110	0,125	0,150	
	2	0,5 x D	●	Required	50	55	60	fn	0,014	0,018	0,020	0,025	0,035	0,040	0,050	0,055	0,065	0,075	0,085	0,100	
K	3	0,5 x D	●	Required	45	50	55	fn	0,014	0,018	0,020	0,025	0,035	0,040	0,050	0,055	0,065	0,075	0,085	0,100	
	1	1,5 x D	●	Preferred	110	120	130	fn	0,033	0,040	0,045	0,055	0,065	0,080	0,095	0,110	0,120	0,140	0,160	0,180	
	2	1 x D	●	Required	100	110	120	fn	0,020	0,028	0,033	0,040	0,050	0,060	0,070	0,085	0,100	0,110	0,125	0,150	
S	3	1 x D	●	Required	90	100	110	fn	0,020	0,028	0,033	0,040	0,050	0,060	0,070	0,085	0,100	0,110	0,125	0,150	
	1	0,3 x D	○	Required	80	85	90	fn	0,020	0,028	0,033	0,040	0,050	0,060	0,070	0,085	0,100	0,110	0,125	0,150	
	2	0,1 x D	○	Required	20	25	28	fn	0,010	0,012	0,015	0,018	0,022	0,028	0,033	0,040	0,045	0,050	0,060	0,070	
	3	0,1 x D	○	Required	20	25	28	fn	0,010	0,012	0,015	0,018	0,022	0,028	0,033	0,040	0,045	0,050	0,060	0,070	
H	4	0,2 x D	○	Required	35	40	45	fn	0,014	0,018	0,020	0,025	0,035	0,040	0,050	0,055	0,065	0,075	0,085	0,100	
	1	0,3 x D	○	Required	75	80	85	fn	0,020	0,028	0,033	0,040	0,050	0,060	0,070	0,085	0,100	0,110	0,125	0,150	
	2	0,2 x D	○	Required	65	70	75	fn	0,014	0,018	0,020	0,025	0,035	0,040	0,050	0,055	0,065	0,075	0,085	0,100	

INDEXABLE MILLING

SOLID END MILLING

HOLEMAKING

TAPPING

TURNING

VariMill XTREME • Adjustment Factor Table for Feed Calculation

Inch

To calculate application-specific cutting data, please use Kv coefficient table to the right for adaptation of cutting speed and Kfz for feed, respectively.

$Vc_{new} = Vc * Kv$   
 $Fz_{new} = IPT * Kfz$

	Ae/D	2%	4%	5%	8%	10%	20%	30%	40%	50%
Speed factor	Kv	2	1.5	1.45	1.4	1.35	1.25	1.2	1	1
Feed factor	Kfz	2.4	2.3	2.2	2	1.7	1.25	1.02	1	1

Calculation example:  
 Application: D = 20mm; M2 material group;  
 Ae = 2mm  
 Cutting data recommendation: Vc = 80 m/min;  
 Fz = 0,089 mm/th  
 Adjustment coefficients: Ae = 2mm equals 10,0%;  
 Kv = 1,35; Kfz = 1,7

Metric

Final cutting data recommendation:  
 $Vc_{new} = 80 * 1,35 = 108 \text{ m/min}$   
 $Fz_{new} = 0,089 * 1,7 = 0,15 \text{ mm/min}$

	Ae/D	2%	4%	5%	8%	10%	20%	30%	40%	50%
Speed factor	Kv	2	1,5	1,45	1,4	1,35	1,25	1,2	1	1
Feed factor	Kfz	2,4	2,3	2,2	2	1,7	1,25	1,02	1	1

INDEXABLE MILLING

SOLID END MILLING

HOLE/MAKING

TAPPING

TURNING



The VariMill I end mill family is for CNC machine shops looking for an all-around tool with a wide standard product range capable of machining multiple materials, covering configurations from a long length-of-cut through a ball nose profile for 3D machining applications.

### Features and Benefits

**Unequal flute spacing** to cut harmonics and reduce the development of vibrations during cutting.

**Center cutting** for improved ramping capabilities and plunging.

**38° helix angle** to provide the best combination between a roughing and a finishing tool.

**Unique core design** to offer maximum room for chip evacuation while keeping the tool design stable.



VariMill I offers plunging, slotting, and profiling at the highest possible feed rates for a wide range of materials. It is designed to provide maximum metal removal rates (MRR) and to achieve superior surface conditions. A wide range of diameters and corner configurations, such as chamfer, radii, and sharp edges, are available from stock.

## **STABLE**

Unequal flute spacing design to ensure low vibrations and high cutting stability.

## **EASY**

With its advanced geometry, machinist will be able to apply VariMill I with confidence.

## **VERSATILE**

Roughing and finishing operations in one single tool with the capability to work on multiple materials.

# CHATTER-FREE VERSATILITY

## PRODUCT

SOLID CARBIDE END MILL

GRADE

WP15PE  
WS15PE  
TiAlN

FLUTE

4

DIAMETER RANGE

INCH

1/8-1-1/4"

METRIC

4-25mm

## INDUSTRY



GENERAL  
ENGINEERING



AEROSPACE



ENERGY



TRANSPORTATION

## APPLICATIONS

MATERIALS

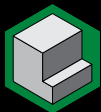

SIDE MILLING

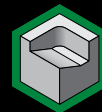

RAMPING



HELICAL  
INTERPOLATION



SLOTING



DYNAMIC  
MILLING



PLUNGING

## VariMill I • Series 4V05 • Square End • 4 Flute • Inch

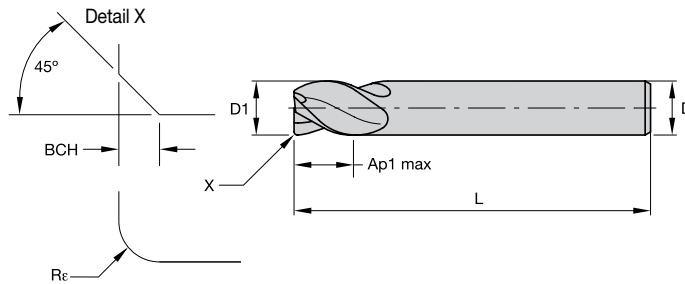
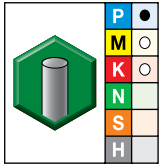

● first choice  
○ alternate choice

WP15PE

order #	catalog #	D1	D	length of cut Ap1 max	length L	Re	BCH	ZU
5576590	4V4503001NT	1/8	1/8	1/4	1 1/2	—	.010	4
5576591	4V4503001ST	1/8	1/8	1/4	1 1/2	—	—	4
5576530	4V0503001AT	1/8	1/8	1/2	2	.015	—	4
5576346	4V0503001ST	1/8	1/8	1/2	2	—	—	4
5576345	4V0503001NT	1/8	1/8	1/2	2	—	.010	4
6571628	4V4505000AT	3/16	3/16	5/16	1 1/2	.015	—	4
5576592	4V4505000NT	3/16	3/16	5/16	1 1/2	—	.010	4
5576593	4V4505000ST	3/16	3/16	5/16	1 1/2	—	—	4
5576531	4V0505000AT	3/16	3/16	5/8	2 1/4	.015	—	4
5576532	4V0505000BT	3/16	3/16	5/8	2 1/4	.030	—	4
5576347	4V0505000NT	3/16	3/16	5/8	2 1/4	—	.010	4
5576348	4V0505000ST	3/16	3/16	5/8	2 1/4	—	—	4
5576610	4V4507002BT	1/4	1/4	3/8	2	.030	—	4
5576595	4V4507002NT	1/4	1/4	3/8	2	—	.016	4
5576596	4V4507002ST	1/4	1/4	3/8	2	—	—	4
5576533	4V0507002AT	1/4	1/4	3/4	2 1/2	.015	—	4
5576534	4V0507002BT	1/4	1/4	3/4	2 1/2	.030	—	4
5576535	4V0507002CT	1/4	1/4	3/4	2 1/2	.060	—	4
5576349	4V0507002NT	1/4	1/4	3/4	2 1/2	—	.016	4
5576510	4V0507002ST	1/4	1/4	3/4	2 1/2	—	—	4
5576577	4V1507002AT	1/4	1/4	1 1/4	3 1/4	.015	—	4
5576579	4V1507002BT	1/4	1/4	1 1/4	3 1/4	.030	—	4
5576566	4V1507002ST	1/4	1/4	1 1/4	3 1/4	—	—	4
5576611	4V4508003BT	5/16	5/16	1/2	2	.030	—	4
5576597	4V4508003NT	5/16	5/16	1/2	2	—	.016	4
5576598	4V4508003ST	5/16	5/16	1/2	2	—	—	4
5576536	4V0508003AT	5/16	5/16	3/4	2 1/2	.015	—	4
5576537	4V0508003BT	5/16	5/16	3/4	2 1/2	.030	—	4
5576538	4V0508003CT	5/16	5/16	3/4	2 1/2	.060	—	4
5576512	4V0508003ST	5/16	5/16	3/4	2 1/2	—	—	4
5576511	4V0508003NT	5/16	5/16	3/4	2 1/2	—	.016	4
5576580	4V1508003BT	5/16	5/16	1 1/4	3 1/4	.030	—	4
5576567	4V1508003ST	5/16	5/16	1 1/4	3 1/4	—	—	4
5576612	4V4510004BT	3/8	3/8	1/2	2	.030	—	4
5576599	4V4510004NT	3/8	3/8	1/2	2	—	.020	4
5576600	4V4510004ST	3/8	3/8	1/2	2	—	—	4
5576539	4V0510004AT	3/8	3/8	7/8	2 1/2	.015	—	4
5576540	4V0510004BT	3/8	3/8	7/8	2 1/2	.030	—	4
5576542	4V0510004CT	3/8	3/8	7/8	2 1/2	.060	—	4
5576543	4V0510004DT	3/8	3/8	7/8	2 1/2	.090	—	4
5576513	4V0510004NT	3/8	3/8	7/8	2 1/2	—	.020	4
5576514	4V0510004ST	3/8	3/8	7/8	2 1/2	—	—	4
5576581	4V1510004BT	3/8	3/8	1 1/2	4	.030	—	4
5576582	4V1510004CT	3/8	3/8	1 1/2	4	.060	—	4
5576568	4V1510004ST	3/8	3/8	1 1/2	4	—	—	4
5576601	4V451101ANT	7/16	7/16	5/8	2 1/2	—	.020	4
5576602	4V451101AST	7/16	7/16	5/8	2 1/2	—	—	4
5576515	4V051101ANT	7/16	7/16	7/8	2 1/2	—	.020	4
5576516	4V051101AST	7/16	7/16	7/8	2 1/2	—	—	4
5576569	4V151100AST	7/16	7/16	2	4	—	—	4
6522632	4V4513005BT	1/2	1/2	5/8	2 1/2	.030	—	4
5576613	4V4513005BW	1/2	1/2	5/8	2 1/2	.030	—	4
5576614	4V4513005CW	1/2	1/2	5/8	2 1/2	.060	—	4
5576604	4V4513005NW	1/2	1/2	5/8	2 1/2	—	.020	4
6522623	4V4513005ST	1/2	1/2	5/8	2 1/2	—	—	4
5576605	4V4513005SW	1/2	1/2	5/8	2 1/2	—	—	4

INDEXABLE MILLING

SOLID END MILLING

HOLEMAKING

TAPPING

TURNING

VariMill I • Series 4V05 • Square End • 4 Flute • Inch

(continued)

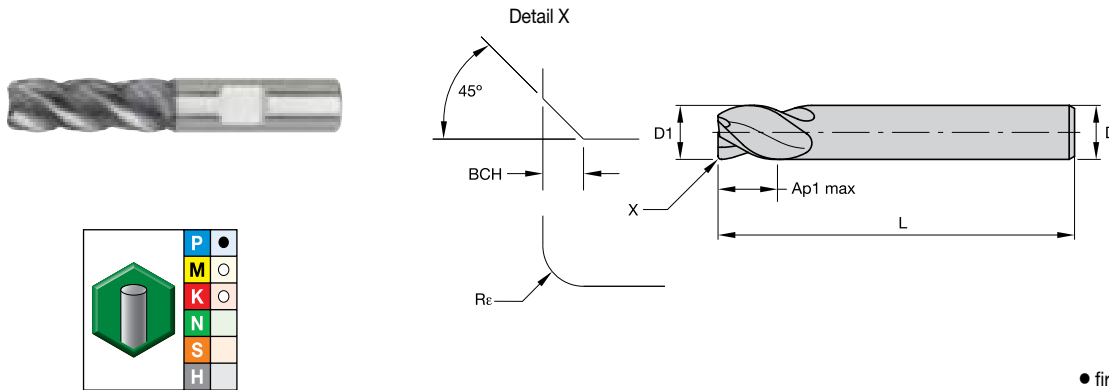

● first choice  
○ alternate choice

WP15PE

order #	catalog #	D1	D	length of cut Ap1 max	length L	Re	BCH	ZU
5576518	4V0513005SW	1/2	1/2	1	3	—	—	4
5576517	4V0513005NW	1/2	1/2	1	3	—	.020	4
5576544	4V0513015AW	1/2	1/2	1 1/4	3	.015	—	4
5576545	4V0513015BW	1/2	1/2	1 1/4	3	.030	—	4
6522633	4V0513015BT	1/2	1/2	1 1/4	3	.030	—	4
5576546	4V0513015CW	1/2	1/2	1 1/4	3	.060	—	4
6522638	4V0513015CT	1/2	1/2	1 1/4	3	.060	—	4
5576547	4V0513015DW	1/2	1/2	1 1/4	3	.090	—	4
6522653	4V0513015ET	1/2	1/2	1 1/4	3	.120	—	4
5576548	4V0513015EW	1/2	1/2	1 1/4	3	.120	—	4
6522624	4V0513015ST	1/2	1/2	1 1/4	3	—	—	4
5576520	4V0513015SW	1/2	1/2	1 1/4	3	—	—	4
5576519	4V0513015NW	1/2	1/2	1 1/4	3	—	.020	4
5576636	4V6513015BW	1/2	1/2	1 1/2	4	.030	—	4
5576637	4V6513015CW	1/2	1/2	1 1/2	4	.060	—	4
5576621	4V6513015NW	1/2	1/2	1 1/2	4	—	.020	4
5576622	4V6513015SW	1/2	1/2	1 1/2	4	—	—	4
5576583	4V1513005BW	1/2	1/2	2	4	.030	—	4
5576584	4V1513005CW	1/2	1/2	2	4	.060	—	4
5576570	4V1513005SW	1/2	1/2	2	4	—	—	4
5576638	4V6513025BW	1/2	1/2	2 1/4	4 1/2	.030	—	4
5576639	4V6513025CW	1/2	1/2	2 1/4	4 1/2	.060	—	4
5576623	4V6513025SW	1/2	1/2	2 1/4	4 1/2	—	—	4
5576615	4V4516006CW	5/8	5/8	3/4	3	.060	—	4
5576617	4V4516006EW	5/8	5/8	3/4	3	.120	—	4
5576606	4V4516006NW	5/8	5/8	3/4	3	—	.020	4
5576607	4V4516006SW	5/8	5/8	3/4	3	—	—	4
5576549	4V0516006BW	5/8	5/8	1 1/4	3 1/2	.030	—	4
5576550	4V0516006CW	5/8	5/8	1 1/4	3 1/2	.060	—	4
5576552	4V0516006EW	5/8	5/8	1 1/4	3 1/2	.120	—	4
6522625	4V0516006ST	5/8	5/8	1 1/4	3 1/2	—	—	4
5576521	4V0516006NW	5/8	5/8	1 1/4	3 1/2	—	.020	4
5576528	4V0516006SW	5/8	5/8	1 1/4	3 1/2	—	—	4
6522634	4V6516016BT	5/8	5/8	1 5/8	4 1/8	.030	—	4
6522639	4V6516016CT	5/8	5/8	1 5/8	4 1/8	.060	—	4
5576650	4V6516016CW	5/8	5/8	1 5/8	4 1/8	.060	—	4
6522654	4V6516016ET	5/8	5/8	1 5/8	4 1/8	.120	—	4
5576624	4V6516016NW	5/8	5/8	1 5/8	4 1/8	—	.020	4
6522626	4V6516016ST	5/8	5/8	1 5/8	4 1/8	—	—	4
5576625	4V6516016SW	5/8	5/8	1 5/8	4 1/8	—	—	4
5576585	4V1516006CW	5/8	5/8	2 1/4	5	.060	—	4
5576571	4V1516006NW	5/8	5/8	2 1/4	5	—	.020	4
5576572	4V1516006SW	5/8	5/8	2 1/4	5	—	—	4
5576618	4V4519007BW	3/4	3/4	7/8	3 1/2	.030	—	4
5576619	4V4519007CW	3/4	3/4	7/8	3 1/2	.060	—	4
5576620	4V4519007EW	3/4	3/4	7/8	3 1/2	.120	—	4
5576608	4V4519007NW	3/4	3/4	7/8	3 1/2	—	.020	4
5576609	4V4519007SW	3/4	3/4	7/8	3 1/2	—	—	4
5576553	4V0519007BW	3/4	3/4	1 1/2	4	.030	—	4
5576554	4V0519007CW	3/4	3/4	1 1/2	4	.060	—	4
5576555	4V0519007DW	3/4	3/4	1 1/2	4	.090	—	4
5576557	4V0519007EW	3/4	3/4	1 1/2	4	.120	—	4
5576522	4V0519007NW	3/4	3/4	1 1/2	4	—	.020	4
5576529	4V0519007SW	3/4	3/4	1 1/2	4	—	—	4
6522635	4V6519017BT	3/4	3/4	1 5/8	4	.030	—	4
6522640	4V6519017CT	3/4	3/4	1 5/8	4	.060	—	4

## VariMill I • Series 4V05 • Square End • 4 Flute • Inch

(continued)

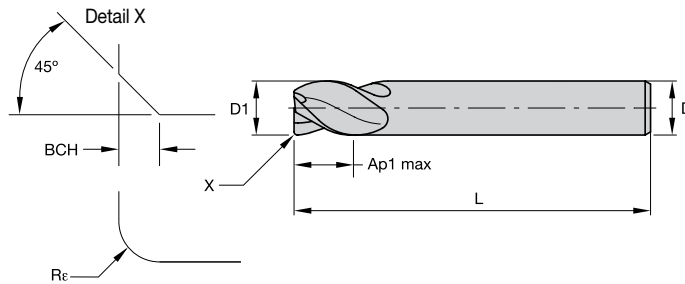
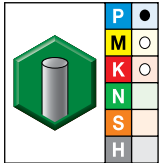

● first choice  
○ alternate choice

WP15PE

order #	catalog #	D1	D	length of cut Ap1 max	length L	Re	BCH	ZU
6522655	4V6519017ET	3/4	3/4	1 5/8	4	.120	—	4
5576630	4V6519017NW	3/4	3/4	1 5/8	4	—	.020	4
6522627	4V6519017ST	3/4	3/4	1 5/8	4	—	—	4
5576631	4V6519017SW	3/4	3/4	1 5/8	4	—	—	4
6522636	4V1519007BT	3/4	3/4	2 1/4	5	.030	—	4
5576586	4V1519007BW	3/4	3/4	2 1/4	5	.030	—	4
6522651	4V1519007CT	3/4	3/4	2 1/4	5	.060	—	4
5576587	4V1519007CW	3/4	3/4	2 1/4	5	.060	—	4
6522656	4V1519007ET	3/4	3/4	2 1/4	5	.120	—	4
6522628	4V1519007ST	3/4	3/4	2 1/4	5	—	—	4
5576574	4V1519007SW	3/4	3/4	2 1/4	5	—	—	4
5576573	4V1519007NW	3/4	3/4	2 1/4	5	—	.020	4
5576651	4V6519007BW	3/4	3/4	3	6	.030	—	4
5576626	4V6519007NW	3/4	3/4	3	6	—	.020	4
6522629	4V6519007ST	3/4	3/4	3	6	—	—	4
5576627	4V6519007SW	3/4	3/4	3	6	—	—	4
6522637	4V0525008BT	1	1	1 1/2	4	.030	—	4
5576558	4V0525008BW	1	1	1 1/2	4	.030	—	4
5576560	4V0525008CW	1	1	1 1/2	4	.060	—	4
6522652	4V0525008CT	1	1	1 1/2	4	.060	—	4
5576561	4V0525008DW	1	1	1 1/2	4	.090	—	4
6522657	4V0525008ET	1	1	1 1/2	4	.120	—	4
5576563	4V0525008FW	1	1	1 1/2	4	.250	—	4
6522630	4V0525008ST	1	1	1 1/2	4	—	—	4
5576525	4V0525008SW	1	1	1 1/2	4	—	—	4
5576523	4V0525008NW	1	1	1 1/2	4	—	.020	4
5576632	4V6525018NW	1	1	2	5	—	.020	4
5576633	4V6525018SW	1	1	2	5	—	—	4
5576588	4V1525008BW	1	1	2 1/4	5	.030	—	4
5576589	4V1525008CW	1	1	2 1/4	5	.060	—	4
5576527	4V0532009SW	1 1/4	1 1/4	2 1/4	5	—	—	4
5576526	4V0532009NW	1 1/4	1 1/4	2 1/4	5	—	.020	4
5576576	4V1525008SW	1	1	2 1/4	5	—	—	4
5576575	4V1525008NW	1	1	2 1/4	5	—	.020	4
6522631	4V2525008ST	1	1	3	6	—	—	4
5576653	4V6525028BW	1	1	4	7	.030	—	4
5576654	4V6525028CW	1	1	4	7	.060	—	4
5576634	4V6525028NW	1	1	4	7	—	.020	4
5576635	4V6525028SW	1	1	4	7	—	—	4

INDEXABLE MILLING

SOLID END MILLING

HOLEMAKING

TAPPING

TURNING

VariMill I • Series 4VOT • Square End • 4 Flute • Inch

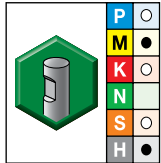
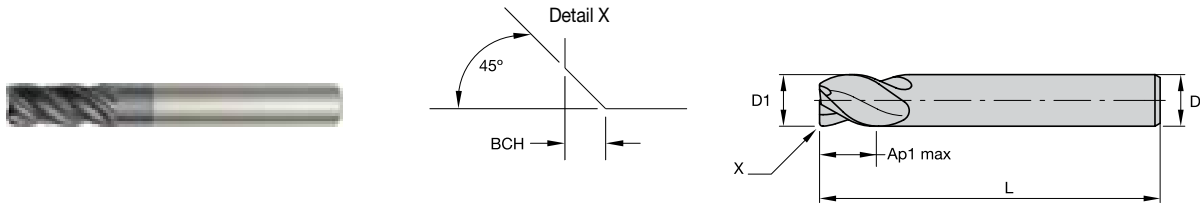

WS15PE

● first choice  
○ alternate choice

order #	catalog #	D1	D	length of cut Ap1 max	length L	BCH	ZU
2831994	TM4VOT13015S	1/2	1/2	1 1/4	3	—	4
2832003	TM4VOT13015	1/2	1/2	1 1/4	3	.020	4
2831974	TM4VOT19007	3/4	3/4	1 1/2	4	.020	4

VariMill I • Series 4VP5 • Square End • Extended Reach • 4 Flute • Inch

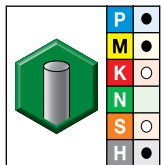
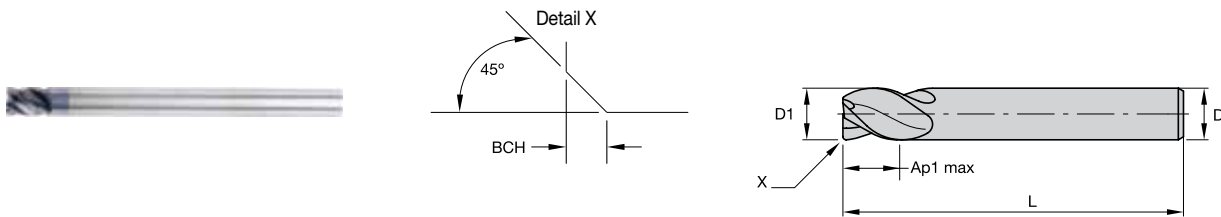

TiAIN-LT

● first choice  
○ alternate choice

order #	catalog #	D1	D	length of cut Ap1 max	length L	BCH	ZU
2837046	TF4VP507012S	1/4	1/4	3/8	4	—	4
2837055	TF4VP507012	1/4	1/4	3/8	4	.016	4
2837032	TF4VP510014S	3/8	3/8	1/2	4	—	4
2837038	TF4VP510014	3/8	3/8	1/2	4	.020	4
2837017	TF4VP513005S	1/2	1/2	5/8	5	—	4
2837025	TF4VP513005	1/2	1/2	5/8	5	.020	4
2837002	TF4VP513015S	1/2	1/2	5/8	6	—	4
2837007	TF4VP513015	1/2	1/2	5/8	6	.020	4
2836992	TF4VP516006	5/8	5/8	3/4	5	.020	4
2836977	TF4VP516016	5/8	5/8	3/4	6	.020	4
2836956	TF4VP516026	5/8	5/8	3/4	7	.020	4
2836936	TF4VP519007S	3/4	3/4	1	5	—	4
2836946	TF4VP519007	3/4	3/4	1	5	.020	4
2836921	TF4VP519017S	3/4	3/4	1	6	—	4
2836930	TF4VP519017	3/4	3/4	1	6	.020	4
2836907	TF4VP519027S	3/4	3/4	1	7	—	4
2836916	TF4VP519027	3/4	3/4	1	7	.020	4
2836887	TF4VP525018	1	1	1 1/8	6	.020	4
2836863	TF4VP525028S	1	1	1 1/8	7	—	4
2836872	TF4VP525028	1	1	1 1/8	7	.020	4

INDEXABLE MILLING

SOLID END MILLING

HOLEMAKING

TAPPING

TURNING

VariMill I • Series 4VPT • Square End • Extended Reach • 4 Flute • Inch

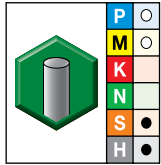
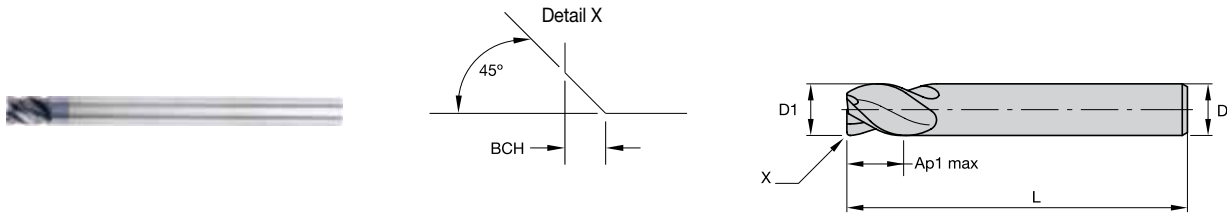

WS15PE

● first choice  
○ alternate choice

order #	catalog #	D1	D	length of cut Ap1 max	length L	BCH	ZU
2831913	TM4VPT13005S	1/2	1/2	5/8	5	—	4
2831918	TM4VPT13005	1/2	1/2	5/8	5	.020	4
2831901	TM4VPT13015S	1/2	1/2	5/8	6	—	4
2831907	TM4VPT13015	1/2	1/2	5/8	6	.020	4
2831865	TM4VPT19017	3/4	3/4	1	6	.020	4
2988603	TM4VPT19027S	3/4	3/4	1	7	—	4

VariMill I • Series 4VN5 • Square End • Extended Reach and Neck • 4 Flute • Inch

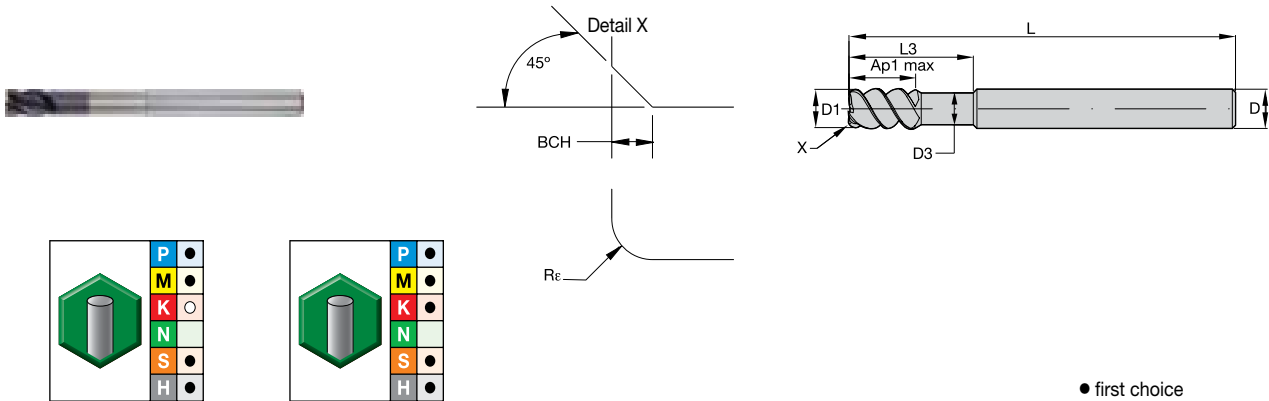

INDEXABLE MILLING  
SOLID END MILLING  
HOLEMAKING  
TAPPING  
TURNING

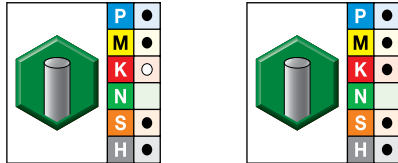

TiAlN-LT		TiAlN-LW		D1	D	D3	length of cut Ap1 max	L3	length L	R <sub>e</sub>	BCH	ZU
3738940	TF4VN507012A	-	-	1/4	1/4	.24	3/8	1 1/4	4	.015	-	4
3738941	TF4VN507012B	-	-	1/4	1/4	.24	3/8	1 1/4	4	.030	-	4
2837188	TF4VN507012	-	-	1/4	1/4	.24	3/8	1 1/4	4	-	.016	4
3738973	TF4VN510014B	-	-	3/8	3/8	.35	1/2	1 7/8	4	.030	-	4
3738974	TF4VN510014C	-	-	3/8	3/8	.35	1/2	1 7/8	4	.060	-	4
2837182	TF4VN510014	-	-	3/8	3/8	.35	1/2	1 7/8	4	-	.020	4
6522611	TF4VN513005BT	3738975	TF4VN513005B	1/2	1/2	.47	5/8	2 1/4	4	.030	-	4
-	-	-	-	1/2	1/2	.47	5/8	2 1/4	4	.030	-	4
6522612	TF4VN513005CT	3738976	TF4VN513005C	1/2	1/2	.47	5/8	2 1/4	4	.060	-	4
-	-	-	-	1/2	1/2	.47	5/8	2 1/4	4	.060	-	4
6522613	TF4VN513005ET	3738977	TF4VN513005E	1/2	1/2	.47	5/8	2 1/4	4	.120	-	4
-	-	-	-	1/2	1/2	.47	5/8	2 1/4	4	.120	-	4
-	-	2837178	TF4VN513005	1/2	1/2	.47	5/8	2 1/4	4	-	.020	4
-	-	3738979	TF4VN516006E	5/8	5/8	.59	3/4	2 1/4	4 1/8	.120	-	4
-	-	2837171	TF4VN516006	5/8	5/8	.59	3/4	2 1/4	4 1/8	-	.020	4
-	-	2837160	TF4VN516016	5/8	5/8	.59	3/4	3 1/8	5	-	.020	4
-	-	2837154	TF4VN519007	3/4	3/4	.71	1	2 1/4	4 1/4	-	.020	4
-	-	3738980	TF4VN519017B	3/4	3/4	.71	1	3 1/4	5 1/4	.030	-	4
6522614	TF4VN519017BT	-	-	3/4	3/4	.71	1	3 1/4	5 1/4	.030	-	4
-	-	3738981	TF4VN519017C	3/4	3/4	.71	1	3 1/4	5 1/4	.060	-	4
6522615	TF4VN519017CT	-	-	3/4	3/4	.71	1	3 1/4	5 1/4	.060	-	4
-	-	3738982	TF4VN519017E	3/4	3/4	.71	1	3 1/4	5 1/4	.120	-	4
6522616	TF4VN519017ET	-	-	3/4	3/4	.71	1	3 1/4	5 1/4	.120	-	4
-	-	2837146	TF4VN519017	3/4	3/4	.71	1	3 1/4	5 1/4	-	.020	4
-	-	2837125	TF4VN525008	1	1	.94	1 1/8	2 1/4	4 1/2	-	.020	4
-	-	3738993	TF4VN525018B	1	1	.94	1 1/8	3 1/4	5 1/2	.030	-	4
6522617	TF4VN525018BT	-	-	1	1	.94	1 1/8	3 1/4	5 1/2	.030	-	4
6522618	TF4VN525018CT	-	-	1	1	.94	1 1/8	3 1/4	5 1/2	.060	-	4
-	-	3738995	TF4VN525018E	1	1	.94	1 1/8	3 1/4	5 1/2	.120	-	4
6522619	TF4VN525018ET	-	-	1	1	.94	1 1/8	3 1/4	5 1/2	.120	-	4
-	-	2837117	TF4VN525018	1	1	.94	1 1/8	3 1/4	5 1/2	-	.020	4
6522620	TF4VN525028BT	-	-	1	1	.94	1 1/8	4 1/4	6 1/2	.030	-	4
-	-	2837110	TF4VN525028	1	1	.94	1 1/8	4 1/4	6 1/2	-	.020	4



## VariMill I • Series 4V00 • Ball Nose • 4 Flute • Inch

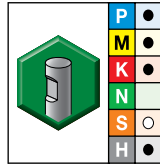
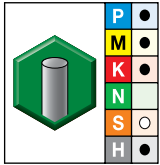
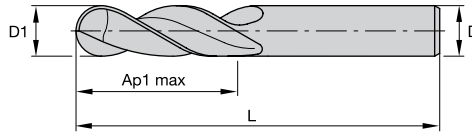

● first choice  
○ alternate choice

WP15PE		WP15PE		D1	D	length of cut Ap1 max	length L	ZU
order #	catalog #	order #	catalog #					
5576655	4V0003001XT	-	-	1/8	1/8	1/2	2	4
5576656	4V0005000XT	-	-	3/16	3/16	5/8	2 1/4	4
5576658	4V0007002XT	-	-	1/4	1/4	3/4	2 1/2	4
5576659	4V0008003XT	-	-	5/16	5/16	3/4	2 1/2	4
5576660	4V0010004XT	-	-	3/8	3/8	7/8	2 1/2	4
5576661	4V001101AXT	-	-	7/16	7/16	7/8	2 1/2	4
-	-	5576662	4V0013005XW	1/2	1/2	1	3	4
-	-	5576663	4V0013015XW	1/2	1/2	1 1/4	3	4
-	-	5576664	4V0016006XW	5/8	5/8	1 1/4	3 1/2	4
-	-	5576665	4V0019007XW	3/4	3/4	1 1/2	4	4
-	-	5576666	4V0025008XW	1	1	1 1/2	4	4
-	-	5576667	4V0032009XW	1 1/4	1 1/4	2 1/4	5	4

## VariMill I • Series 4VPO • Ball Nose • Extended Reach • 4 Flute • Inch

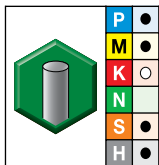
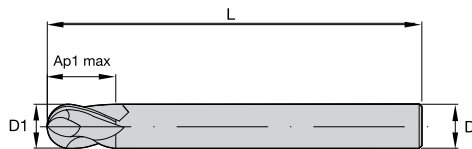

● first choice  
○ alternate choice

TIAIN-LT		D1	D	length of cut Ap1 max	length L	ZU
order #	catalog #					
2837105	TF4VP007012	1/4	1/4	3/8	4	4
3018276	TF4VP010014	3/8	3/8	1/2	4	4
2837088	TF4VP013005	1/2	1/2	5/8	5	4
2837081	TF4VP016016	5/8	5/8	3/4	6	4
2837073	TF4VP019017	3/4	3/4	1	6	4
2837061	TF4VP025018	1	1	1 1/8	6	4

VariMill I • Series 4777 • Square End • 4 Flute • Metric

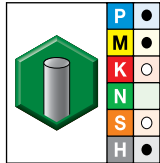
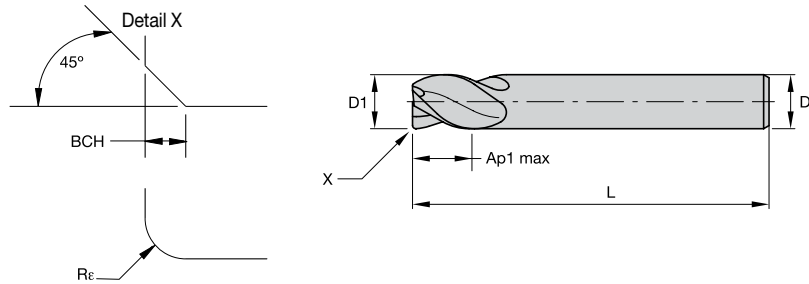

● first choice  
○ alternate choice

WP15PE

order #	catalog #	D1	D	length of cut Ap1 max	length L	Rε	BCH	ZU
5576753	477704001T	4,0	6	12,00	55	0,20	—	4
5576751	477704002T	4,0	6	12,00	55	—	0,40	4
5576754	477704022T	4,0	6	12,00	55	—	—	4
5576755	477705002T	5,0	6	13,00	57	—	0,40	4
5576757	477705012T	5,0	6	13,00	57	0,20	—	4
5576758	477705022T	5,0	6	13,00	57	—	—	4
5576759	477706002T	6,0	6	13,00	57	—	0,40	4
5576760	477706002W	6,0	6	13,00	57	—	0,40	4
5576761	477706012T	6,0	6	13,00	57	0,20	—	4
6471861	4777060R2TE	6,0	6	13,00	57	0,50	—	4
6471862	4777060R2TJ	6,0	6	13,00	57	1,00	—	4
5576762	477706022T	6,0	6	13,00	57	—	—	4
5576763	477707003T	7,0	8	16,00	63	—	0,40	4
5576765	477707013T	7,0	8	16,00	63	0,20	—	4
5576766	477707023T	7,0	8	16,00	63	—	—	4
5576767	477708003T	8,0	8	16,00	63	—	0,40	4
5576768	477708003W	8,0	8	16,00	63	—	0,40	4
5576769	477708013T	8,0	8	16,00	63	0,20	—	4
6471863	4777080R3TE	8,0	8	16,00	63	0,50	—	4
6471864	4777080R3TJ	8,0	8	16,00	63	1,00	—	4
6471865	4777080R3TK	8,0	8	16,00	63	1,50	—	4
6471866	4777080R3TM	8,0	8	16,00	63	2,00	—	4
5576770	477708023T	8,0	8	16,00	63	—	—	4
5576771	477709004T	9,0	10	19,00	72	—	0,50	4
5576773	477709014T	9,0	10	19,00	72	0,20	—	4
5576774	477709024T	9,0	10	19,00	72	—	—	4
5576775	477710004T	10,0	10	22,00	72	—	0,50	4
5576776	477710004W	10,0	10	22,00	72	—	0,50	4
5576777	477710024T	10,0	10	22,00	72	0,30	—	4
6471867	4777100R4TE	10,0	10	22,00	72	0,50	—	4
6471868	4777100R4TJ	10,0	10	22,00	72	1,00	—	4
6471869	4777100R4TK	10,0	10	22,00	72	1,50	—	4
6471870	4777100R4TM	10,0	10	22,00	72	2,00	—	4
6471871	4777100R4TN	10,0	10	22,00	72	2,50	—	4
5576778	477710024T	10,0	10	22,00	72	—	—	4
5576779	4777110Z5T	11,0	12	26,00	83	—	—	4
5576790	477712005T	12,0	12	26,00	83	—	0,50	4
5576791	477712005W	12,0	12	26,00	83	—	0,50	4
5576792	477712025T	12,0	12	26,00	83	0,30	—	4
6471872	4777120R5TE	12,0	12	26,00	83	0,50	—	4
6471873	4777120R5TJ	12,0	12	26,00	83	1,00	—	4
6471874	4777120R5TK	12,0	12	26,00	83	1,50	—	4
6471875	4777120R5TM	12,0	12	26,00	83	2,00	—	4
6471876	4777120R5TN	12,0	12	26,00	83	2,50	—	4
6471877	4777120R5TP	12,0	12	26,00	83	3,00	—	4
5576793	4777120Z5T	12,0	12	26,00	83	—	—	4
5576795	477714014W	14,0	14	26,00	83	—	0,50	4
5576794	477714015T	14,0	14	26,00	83	—	0,50	4
5576796	477716006T	16,0	16	32,00	92	—	0,50	4
5576797	477716006W	16,0	16	32,00	92	—	0,50	4
5576798	477716026T	16,0	16	32,00	92	0,30	—	4
6471878	4777160R6TJ	16,0	16	32,00	92	1,00	—	4

INDEXABLE MILLING

SOLID END MILLING

HOLEMAKING

TAPPING

TURNING

VariMill I • Series 4777 • Square End • 4 Flute • Metric

(continued)

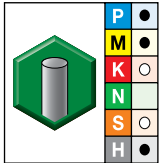
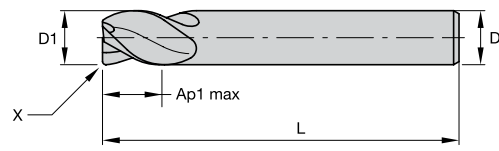
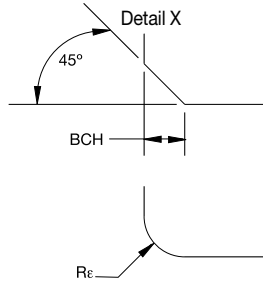

WP15PE

● first choice  
○ alternate choice

order #	catalog #	D1	D	length of cut Ap1 max	length L	Rε	BCH	ZU
6471879	4777160R6TM	16,0	16	32,00	92	2,00	—	4
6471880	4777160R6TP	16,0	16	32,00	92	3,00	—	4
6471891	4777160R6TQ	16,0	16	32,00	92	4,00	—	4
5576799	4777160Z6T	16,0	16	32,00	92	—	—	4
5576810	477718018T	18,0	18	32,00	92	—	0,50	4
5576812	477720007T	20,0	20	38,00	104	—	0,50	4
5576813	477720007W	20,0	20	38,00	104	—	0,50	4
5576814	47772002T	20,0	20	38,00	104	0,30	—	4
6471892	4777200R7TP	20,0	20	38,00	104	3,00	—	4
5576816	477725008T	25,0	25	45,00	121	—	0,50	4
5576817	477725008W	25,0	25	45,00	121	—	0,50	4
6471893	4777250R8TR	25,0	25	45,00	121	5,00	—	4

INDEXABLE MILLING

SOLID END MILLING

HOLEMAKING

TAPPING

TURNING

VariMill I • Series 4717 • Square End • Long Length • 4 Flute • Metric

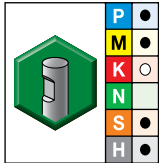
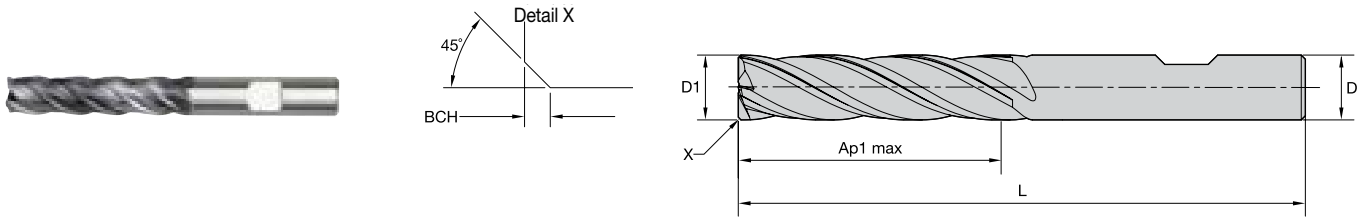

TIAIN-LW

● first choice  
○ alternate choice

order #	catalog #	D1	D	length of cut Ap1 max	length L	BCH	ZU
3641112	471706002LW	6,0	6	32,00	76	0,40	4
3641113	471708003LW	8,0	8	32,00	87	0,40	4
3641114	471710004LW	10,0	10	38,00	89	0,50	4
3641115	471712005LW	12,0	12	51,00	100	0,50	4
3641116	471716006LW	16,0	16	57,00	125	0,50	4
3641117	471720007LW	20,0	20	57,00	125	0,50	4

VariMill I • Series 4727 • Square End • Extended Length • 4 Flute • Metric

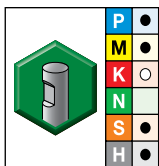
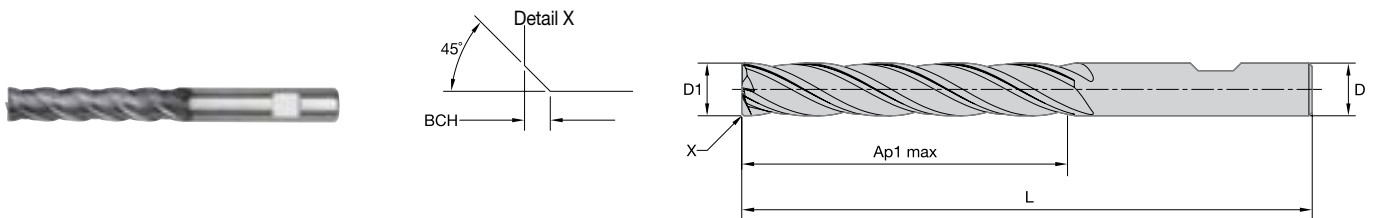

TIAIN-LW

● first choice  
○ alternate choice

order #	catalog #	D1	D	length of cut Ap1 max	length L	BCH	ZU
3641118	472712005LW	12,0	12	76,00	125	0,50	4
3641119	472716006LW	16,0	16	76,00	150	0,50	4
3641120	472720007LW	20,0	20	102,00	175	0,50	4

## VariMill I • Series 4778 • Square End • 4 Flute • Metric

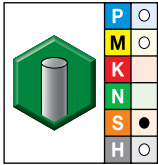
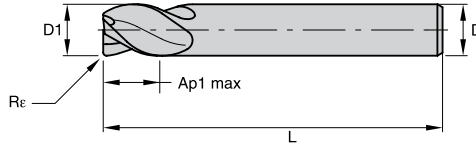

WS15PE

● first choice  
○ alternate choice

order #	catalog #	D1	D	length of cut Ap1 max	length L	Re	ZU
2545563	477804002MT	4,0	6	12,00	55	0,20	4
2545564	477805002MT	5,0	6	13,00	57	0,20	4
2545565	477806002MT	6,0	6	13,00	57	0,20	4
2545570	477807003MT	7,0	8	16,00	63	0,20	4
2545603	477808003MT	8,0	8	16,00	63	0,20	4
2601245	477810004MT	10,0	10	22,00	72	0,30	4
2601246	477812005MT	12,0	12	26,00	83	0,30	4
2601248	477814014MT	14,0	14	26,00	83	0,30	4
2601249	477816006MT	16,0	16	32,00	92	0,30	4
2601251	477820007MT	20,0	20	38,00	104	0,30	4

INDEXABLE MILLING

SOLID END MILLING

HOLEMAKING

TAPPING

TURNING

VariMill I • Series 47N7 • Square End • Neck • 4 Flute • Metric

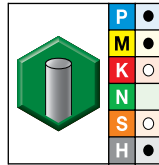
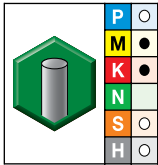
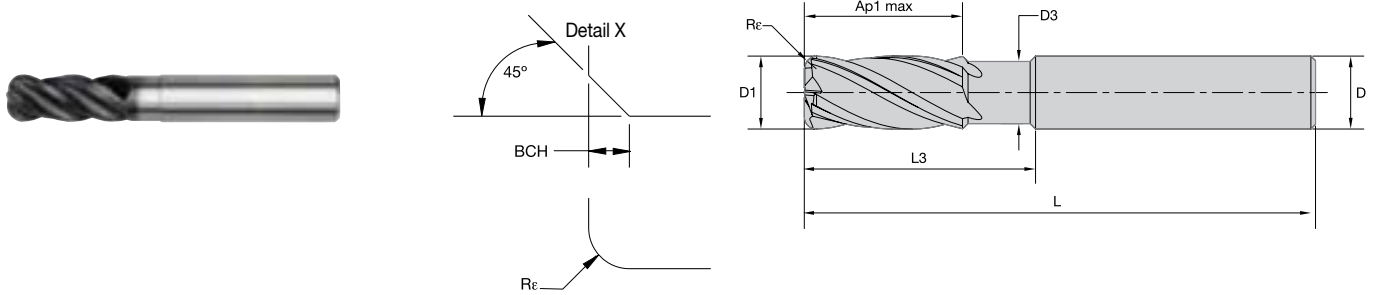

● first choice  
○ alternate choice

WP15PE		TiAlN-LT		D1	D	D3	length of cut Ap1 max	L3	length L	Rε	BCH	ZU
—	—	3462450	47N704002LT	4,0	6	3,60	12,00	16,00	55	0,40	—	4
—	—	3462451	47N704012LT	4,0	6	3,60	12,00	16,00	55	0,50	—	4
—	—	3462453	47N704022LT	4,0	6	3,60	12,00	16,00	55	1,00	—	4
—	—	3462454	47N705002LT	5,0	6	4,60	13,00	18,00	57	0,50	—	4
—	—	3462455	47N705012LT	5,0	6	4,60	13,00	18,00	57	1,00	—	4
—	—	3462457	47N706002LT	6,0	6	5,50	13,00	21,00	57	0,50	—	4
—	—	3462459	47N706012LT	6,0	6	5,50	13,00	21,00	57	1,00	—	4
6522659	47N7060R2TK	3462461	47N706022LT	6,0	6	5,50	13,00	21,00	57	1,50	—	4
6522658	47N7060C2W	—	—	6,0	6	5,50	13,00	21,00	57	—	0,40	4
—	—	3462462	47N708003LT	8,0	8	7,50	16,00	27,00	63	0,50	—	4
—	—	3462464	47N708013LT	8,0	8	7,50	16,00	27,00	63	1,00	—	4
6522681	47N7080R3TK	3462466	47N708023LT	8,0	8	7,50	16,00	27,00	63	1,50	—	4
—	—	3462467	47N708033LT	8,0	8	7,50	16,00	27,00	63	2,00	—	4
6522660	47N7080C3W	—	—	8,0	8	7,50	16,00	27,00	63	—	0,40	4
—	—	3462468	47N710004LT	10,0	10	9,50	22,00	32,00	72	0,50	—	4
—	—	3462470	47N710014LT	10,0	10	9,50	22,00	32,00	72	1,00	—	4
6522683	47N7100R4TK	3462472	47N710024LT	10,0	10	9,50	22,00	32,00	72	1,50	—	4
—	—	3462473	47N710034LT	10,0	10	9,50	22,00	32,00	72	2,00	—	4
6522682	47N7100C4W	—	—	10,0	10	9,50	22,00	32,00	72	—	0,50	4
—	—	3462475	47N712005LT	12,0	12	11,50	26,00	38,00	83	0,50	—	4
—	—	3462477	47N712015LT	12,0	12	11,50	26,00	38,00	83	1,00	—	4
6522685	47N7120R5TK	3462479	47N712025LT	12,0	12	11,50	26,00	38,00	83	1,50	—	4
—	—	3462480	47N712035LT	12,0	12	11,50	26,00	38,00	83	2,00	—	4
—	—	3462482	47N712045LT	12,0	12	11,50	26,00	38,00	83	4,00	—	4
6522684	47N7120C5W	—	—	12,0	12	11,50	26,00	38,00	83	—	0,50	4
6522686	47N7120R5TP	—	—	12,0	12	11,50	26,00	38,00	83	3,00	—	4
—	—	3462484	47N716006LT	16,0	16	15,00	32,00	44,00	92	1,00	—	4
—	—	3462486	47N716016LT	16,0	16	15,00	32,00	44,00	92	2,00	—	4
—	—	3462488	47N716026LT	16,0	16	15,00	32,00	44,00	92	4,00	—	4
6522687	47N7160C6W	—	—	16,0	16	15,00	32,00	44,00	92	—	0,50	4
6522688	47N7160R6TE	—	—	16,0	16	15,00	32,00	44,00	92	0,50	—	4
6522689	47N7160R6TP	—	—	16,0	16	15,00	32,00	44,00	92	3,00	—	4
3462491	47N720007MT	3462490	47N720007LT	20,0	20	19,00	38,00	55,00	104	1,00	—	4
—	—	3462492	47N720017LT	20,0	20	19,00	38,00	55,00	104	2,00	—	4
6522690	47N7200C7W	—	—	20,0	20	19,00	38,00	55,00	104	—	0,50	4
6522701	47N7200R7TE	—	—	20,0	20	19,00	38,00	55,00	104	0,50	—	4
6522702	47N7200R7TP	—	—	20,0	20	19,00	38,00	55,00	104	3,00	—	4
6522703	47N7200R7TR	—	—	20,0	20	19,00	38,00	55,00	104	5,00	—	4

INDEXABLE MILLING

SOLID END MILLING

HOLEMAKING

TAPPING

TURNING

## VariMill I • Series 47N6 • Square End • Long Neck • 4 Flute • Metric

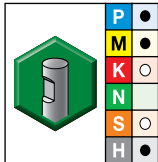
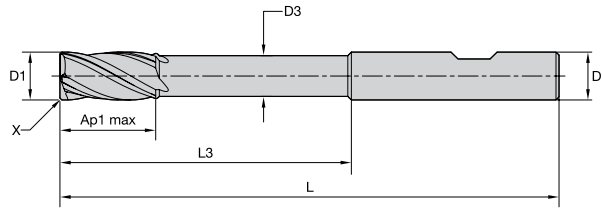
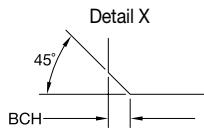

TiAlN-LW

● first choice  
○ alternate choice

order #	catalog #	D1	D	D3	length of cut Ap1 max	L3	length L	BCH	ZU
4067705	47N606002LW	6,0	6	5,50	12,00	42,00	100	0,40	4
4067706	47N608003LW	8,0	8	7,30	16,00	62,00	100	0,40	4
4067707	47N610004LW	10,0	10	9,10	20,00	60,00	100	0,50	4
4067708	47N612005LW	12,0	12	11,00	24,00	73,00	125	0,50	4
4067709	47N616006LW	16,0	16	14,56	32,00	100,00	150	0,50	4
4067710	47N620007LW	20,0	20	18,20	40,00	98,00	175	0,50	4

## VariMill I • Series 47N0 • Ball Nose • Neck • 4 Flute • Metric

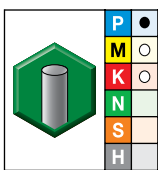
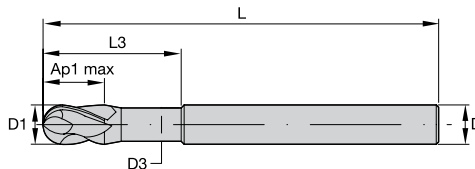

WP15PE

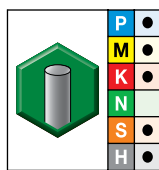

TiAlN-LT

● first choice  
○ alternate choice

order #	catalog #	order #	catalog #	D1	D	D3	length of cut Ap1 max	L3	length L	ZU
5576818	47N005002T	2605589	47N005002LT	5,0	6	4,70	9,00	15,00	57	4
5576819	47N006002T	2605590	47N006002LT	6,0	6	5,64	10,00	15,00	57	4
5576820	47N008003T	2605591	47N008003LT	8,0	8	7,52	12,00	20,00	63	4
5576821	47N010004T	2605592	47N010004LT	10,0	10	9,40	14,00	25,00	72	4
5576822	47N012005T	2605593	47N012005LT	12,0	12	11,28	16,00	30,00	83	4
5576823	47N016006T	—	—	16,0	16	15,04	22,00	38,00	92	4
5576824	47N020007T	—	—	20,0	20	18,80	26,00	50,00	104	4

VariMill I • Series 4V05 4V15 4V45 4V65 • Application Data • WP15PE • Inch

Material Group	Side Milling (A) and Slotting (B)			Cutting Speed – vc SFM		Recommended feed per tooth (IPT = inch/th) for side milling (A). For slotting (B), reduce IPT by 20%.													
	A		B	min	max	frac. dec.	D1 – Diameter												
	ap	ae	ap				1/8	3/16	1/4	5/16	3/8	7/16	1/2	5/8	3/4	1	1 1/4		
	ap	ae	ap				.1250	.1875	.2500	.3125	.3750	.4375	.5000	.6250	.7500	1.0000	1.2500		
P	0	1.5 x D	0.5 x D	1 x D	490	–	660	IPT	.0009	.0013	.0018	.0023	.0027	.0031	.0034	.0039	.0044	.0049	.0049
	1	1.5 x D	0.5 x D	1 x D	490	–	660	IPT	.0009	.0013	.0018	.0023	.0027	.0031	.0034	.0039	.0044	.0049	.0049
	2	1.5 x D	0.5 x D	1 x D	460	–	620	IPT	.0009	.0013	.0018	.0023	.0027	.0031	.0034	.0039	.0044	.0049	.0049
	3	1.5 x D	0.5 x D	1 x D	390	–	520	IPT	.0007	.0011	.0015	.0020	.0023	.0026	.0029	.0034	.0039	.0045	.0048
	4	1.5 x D	0.5 x D	0.75 x D	300	–	490	IPT	.0007	.0010	.0014	.0017	.0020	.0023	.0026	.0030	.0034	.0039	.0040
	5	1.5 x D	0.5 x D	1 x D	200	–	330	IPT	.0006	.0009	.0012	.0016	.0018	.0021	.0023	.0027	.0031	.0036	.0039
M	1	1.5 x D	0.5 x D	1 x D	160	–	250	IPT	.0005	.0008	.0010	.0013	.0015	.0017	.0019	.0022	.0025	.0028	.0029
	2	1.5 x D	0.5 x D	1 x D	200	–	260	IPT	.0006	.0009	.0012	.0016	.0018	.0021	.0023	.0027	.0031	.0036	.0039
	3	1.5 x D	0.5 x D	1 x D	200	–	230	IPT	.0005	.0008	.0010	.0013	.0015	.0017	.0019	.0022	.0025	.0028	.0029
K	1	1.5 x D	0.5 x D	1 x D	390	–	490	IPT	.0009	.0013	.0018	.0023	.0027	.0031	.0034	.0039	.0044	.0049	.0049
	2	1.5 x D	0.5 x D	1 x D	360	–	460	IPT	.0007	.0011	.0015	.0020	.0023	.0026	.0029	.0034	.0039	.0045	.0048
	3	1.5 x D	0.5 x D	1 x D	360	–	430	IPT	.0006	.0009	.0012	.0016	.0018	.0021	.0023	.0027	.0031	.0036	.0039
S	1	1.5 x D	0.3 x D	0.3 x D	160	–	300	IPT	.0007	.0011	.0015	.0020	.0023	.0026	.0029	.0034	.0039	.0045	.0048
	2	1.5 x D	0.3 x D	0.3 x D	80	–	130	IPT	.0004	.0006	.0008	.0010	.0012	.0014	.0015	.0018	.0021	.0024	.0026
	3	1.5 x D	0.5 x D	1 x D	80	–	130	IPT	.0004	.0006	.0008	.0010	.0012	.0014	.0015	.0018	.0021	.0024	.0026
	4	1.5 x D	0.5 x D	1 x D	160	–	200	IPT	.0005	.0008	.0011	.0014	.0017	.0019	.0021	.0025	.0028	.0033	.0036
H	1	1.5 x D	0.5 x D	0.75 x D	260	–	460	IPT	.0007	.0010	.0014	.0017	.0020	.0023	.0026	.0030	.0034	.0039	.0040
	2	1.5 x D	0.2 x D	0.5 x D	230	–	390	IPT	.0005	.0008	.0010	.0013	.0015	.0017	.0019	.0022	.0025	.0028	.0029

NOTE: Lower value of cutting speed is used for high stock removal applications or for higher hardness (machinability) within group.  
Higher value of cutting speed is used for finishing applications or for lower hardness (machinability) within group.  
Above parameters are based on ideal conditions. For smaller taper machining centers, please adjust parameters accordingly on >1/2" diameter.

VariMill I • Series 4V0T • Application Data • WS15PE • Inch

Material Group	Side Milling (A) and Slotting (B)			Cutting Speed – vc SFM		Recommended feed per tooth (IPT = inch/th) for side milling (A). For slotting (B), reduce IPT by 20%.							
	A		B	min	max	frac. dec.	D1 – Diameter						
	ap	ae	ap				1/2	5/8	3/4	1	1-1/4		
	ap	ae	ap				.5000	.6250	.7500	1.0000	1.2500		
P	0	1.5 x D	0.5 x D	1 x D	490	–	660	IPT	.0034	.0039	.0044	.0049	.0049
	1	1.5 x D	0.5 x D	1 x D	490	–	660	IPT	.0034	.0039	.0044	.0049	.0049
	2	1.5 x D	0.5 x D	1 x D	460	–	620	IPT	.0034	.0039	.0044	.0049	.0049
	3	1.5 x D	0.5 x D	1 x D	390	–	520	IPT	.0029	.0034	.0039	.0045	.0048
	4	1.5 x D	0.5 x D	0.75 x D	300	–	490	IPT	.0026	.0030	.0034	.0039	.0040
	5	1.5 x D	0.5 x D	1 x D	200	–	330	IPT	.0023	.0027	.0031	.0036	.0039
M	1	1.5 x D	0.5 x D	1 x D	160	–	250	IPT	.0019	.0022	.0025	.0028	.0029
	2	1.5 x D	0.5 x D	1 x D	200	–	260	IPT	.0023	.0027	.0031	.0036	.0039
	3	1.5 x D	0.5 x D	1 x D	200	–	230	IPT	.0019	.0022	.0025	.0028	.0029
K	1	1.5 x D	0.5 x D	1 x D	390	–	490	IPT	.0034	.0039	.0044	.0049	.0049
	2	1.5 x D	0.5 x D	1 x D	360	–	460	IPT	.0029	.0034	.0039	.0045	.0048
	3	1.5 x D	0.5 x D	1 x D	360	–	430	IPT	.0023	.0027	.0031	.0036	.0039
S	1	1.5 x D	0.3 x D	0.3 x D	160	–	300	IPT	.0029	.0034	.0039	.0045	.0048
	2	1.5 x D	0.3 x D	0.3 x D	80	–	130	IPT	.0015	.0018	.0021	.0024	.0026
	3	1.5 x D	0.5 x D	1 x D	80	–	130	IPT	.0015	.0018	.0021	.0024	.0026
	4	1.5 x D	0.5 x D	1 x D	160	–	200	IPT	.0021	.0025	.0028	.0033	.0036
H	1	1.5 x D	0.5 x D	0.75 x D	260	–	460	IPT	.0026	.0030	.0034	.0039	.0040
	2	1.5 x D	0.2 x D	0.5 x D	230	–	390	IPT	.0019	.0022	.0025	.0028	.0029

NOTE: Lower value of cutting speed is used for high stock removal applications or for higher hardness (machinability) within group.  
Higher value of cutting speed is used for finishing applications or for lower hardness (machinability) within group.  
Above parameters are based on ideal conditions. For smaller taper machining centers, please adjust parameters accordingly on >1/2" diameter.



VariMill I • Series 4VP5 • Application Data • TiAlN-LT • Inch

Material Group	Side Milling (A) and Slotting (B)		TiAlN			Recommended feed per tooth (IPT = inch/th) for side milling (A). For slotting (B), reduce IPT by 20%.								
	A		B		Cutting Speed – vc SFM			D1 – Diameter						
	ap	ae	ap	min	max	frac. dec.	1/4	3/8	1/2	5/8	3/4	1		
	ap	ae	ap	min	max	dec.	.2500	.3750	.5000	.6250	.7500	1.000		
P	0	0.75 x D	0.5 x D	0.75 x D	490	–	660	IPT	.0018	.0027	.0034	.0039	.0044	.0049
	1	0.75 x D	0.5 x D	0.75 x D	490	–	660	IPT	.0018	.0027	.0034	.0039	.0044	.0049
	2	0.75 x D	0.5 x D	0.75 x D	460	–	620	IPT	.0018	.0027	.0034	.0039	.0044	.0049
	3	0.75 x D	0.5 x D	0.75 x D	390	–	520	IPT	.0015	.0023	.0029	.0034	.0039	.0045
	4	0.75 x D	0.5 x D	0.5 x D	300	–	490	IPT	.0014	.0020	.0026	.0030	.0034	.0039
	5	0.75 x D	0.5 x D	0.75 x D	200	–	330	IPT	.0012	.0018	.0023	.0027	.0031	.0036
M	6	0.75 x D	0.5 x D	0.5 x D	160	–	250	IPT	.0010	.0015	.0019	.0022	.0025	.0028
	1	0.75 x D	0.5 x D	0.75 x D	300	–	380	IPT	.0015	.0023	.0029	.0034	.0039	.0045
	2	0.75 x D	0.5 x D	0.75 x D	200	–	260	IPT	.0012	.0018	.0023	.0027	.0031	.0036
K	3	0.75 x D	0.5 x D	0.75 x D	200	–	230	IPT	.0010	.0015	.0019	.0022	.0025	.0028
	1	0.75 x D	0.5 x D	0.75 x D	390	–	490	IPT	.0018	.0027	.0034	.0039	.0044	.0049
	2	0.75 x D	0.5 x D	0.75 x D	360	–	460	IPT	.0015	.0023	.0029	.0034	.0039	.0045
S	3	0.75 x D	0.5 x D	0.75 x D	360	–	430	IPT	.0012	.0018	.0023	.0027	.0031	.0036
	1	0.75 x D	0.3 x D	0.3 x D	160	–	300	IPT	.0015	.0023	.0029	.0034	.0039	.0045
	2	0.75 x D	0.3 x D	0.3 x D	80	–	130	IPT	.0008	.0012	.0015	.0018	.0021	.0024
	3	0.75 x D	0.5 x D	0.75 x D	80	–	130	IPT	.0008	.0012	.0015	.0018	.0021	.0024
H	4	0.75 x D	0.5 x D	0.75 x D	160	–	200	IPT	.0011	.0017	.0021	.0025	.0028	.0033
	1	0.75 x D	0.5 x D	0.5 x D	260	–	460	IPT	.0014	.0020	.0026	.0030	.0034	.0039
	2	0.75 x D	0.2 x D	0.75 x D	230	–	390	IPT	.0010	.0015	.0019	.0022	.0025	.0028

NOTE: Lower value of cutting speed is used for high stock removal applications or for higher hardness (machinability) within group.  
 Higher value of cutting speed is used for finishing applications or for lower hardness (machinability) within group.  
 Above parameters are based on ideal conditions. For smaller taper machining centers, please adjust parameters accordingly on diameters greater than 1/2".  
 Side milling applications – for longest reach (L3) tools, reduce ae by 30%.  
 Slot milling applications – for longest reach (L3) tools, reduce ae by 30%.

VariMill I • Series 4VPT • Application Data • WS15PE • Inch

Material Group	Side Milling (A) and Slotting (B)		WS15PE			Recommended feed per tooth (IPT = inch/th) for side milling (A). For slotting (B), reduce IPT by 20%.							
	A		B		Cutting Speed – vc SFM			D1 – Diameter					
	ap	ae	ap	min	max	frac. dec.	1/2	5/8	3/4	1			
	ap	ae	ap	min	max	dec.	.5000	.6250	.7500	1.000			
P	1	0.75 x D	0.5 x D	0.75 x D	500	–	650	IPT	.0035	.0039	.0043	.0050	
	2	0.75 x D	0.5 x D	0.75 x D	450	–	625	IPT	.0035	.0039	.0043	.0050	
	3	0.75 x D	0.5 x D	0.75 x D	400	–	525	IPT	.0029	.0034	.0038	.0046	
	4	0.75 x D	0.5 x D	0.5 x D	300	–	475	IPT	.0026	.0030	.0033	.0039	
	5	0.75 x D	0.5 x D	0.75 x D	200	–	325	IPT	.0023	.0027	.0030	.0036	
	6	0.75 x D	0.5 x D	0.5 x D	150	–	225	IPT	.0019	.0022	.0024	.0028	
M	1	0.75 x D	0.5 x D	0.75 x D	260	–	330	IPT	.0029	.0034	.0038	.0046	
	2	0.75 x D	0.5 x D	0.75 x D	200	–	260	IPT	.0023	.0027	.0030	.0036	
	3	0.75 x D	0.5 x D	0.75 x D	200	–	260	IPT	.0019	.0022	.0024	.0028	
K	1	0.75 x D	0.5 x D	0.75 x D	390	–	520	IPT	.0035	.0039	.0043	.0050	
	2	0.75 x D	0.5 x D	0.75 x D	360	–	460	IPT	.0029	.0034	.0038	.0046	
	3	0.75 x D	0.5 x D	0.75 x D	330	–	430	IPT	.0023	.0027	.0030	.0036	
S	1	0.75 x D	0.3 x D	0.3 x D	160	–	300	IPT	.0029	.0034	.0039	.0045	
	2	0.75 x D	0.3 x D	0.3 x D	80	–	130	IPT	.0015	.0018	.0021	.0024	
	3	0.75 x D	0.5 x D	0.75 x D	80	–	130	IPT	.0015	.0018	.0021	.0024	
	4	0.75 x D	0.5 x D	0.75 x D	160	–	200	IPT	.0021	.0025	.0028	.0033	
H	1	0.75 x D	0.5 x D	0.5 x D	260	–	450	IPT	.0026	.0030	.0033	.0039	

NOTE: Side milling applications – for longest reach (L3) tools, reduce ae by 30%.  
 Slot milling applications – for longest reach (L3) tools, reduce ap by 30%.  
 Lower value of cutting speed is used for high stock removal applications or for higher hardness (machinability) within group.  
 Higher value of cutting speed is used for finishing applications or for lower hardness (machinability) within group.  
 Above parameters are based on ideal conditions. For smaller taper machining centers, please adjust parameters accordingly on >1/2" diameter.

INDEXABLE MILLING



SOLID END MILLING

HOLEMAKING

TAPPING

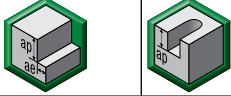

TURNING

VariMill I • Series 4VN5 • Application Data • TiAlN-LT • TiAlN-LW • Inch

Material Group														
	Side Milling (A) and Slotting (B)			TiAlN-LW			Recommended feed per tooth (IPT = inch/th) for side milling (A). For slotting (B), reduce IPT by 20%.							
	A		B	Cutting Speed – vc SFM			D1 – Diameter							
	ap	ae	ap	min	max	frac.	1/4	3/8	1/2	5/8	3/4	1		
P	1	0.75 x D	0.5 x D	0.75 x D	500	–	650	IPT	.0018	.0027	.0035	.0039	.0043	.0050
	2	0.75 x D	0.5 x D	0.75 x D	450	–	625	IPT	.0018	.0027	.0035	.0039	.0043	.0050
	3	0.75 x D	0.5 x D	0.75 x D	400	–	525	IPT	.0015	.0023	.0029	.0034	.0038	.0046
	4	0.75 x D	0.5 x D	0.5 x D	300	–	475	IPT	.0014	.0020	.0026	.0030	.0033	.0039
	5	0.75 x D	0.5 x D	0.75 x D	200	–	325	IPT	.0012	.0018	.0023	.0027	.0030	.0036
	6	0.75 x D	0.5 x D	0.5 x D	150	–	225	IPT	.0010	.0015	.0019	.0022	.0024	.0028
M	1	0.75 x D	0.5 x D	0.75 x D	260	–	330	IPT	.0015	.0023	.0029	.0034	.0038	.0046
	2	0.75 x D	0.5 x D	0.75 x D	200	–	260	IPT	.0012	.0018	.0023	.0027	.0030	.0036
K	1	0.75 x D	0.5 x D	0.75 x D	390	–	520	IPT	.0018	.0027	.0035	.0039	.0043	.0050
	2	0.75 x D	0.5 x D	0.75 x D	360	–	460	IPT	.0015	.0023	.0029	.0034	.0038	.0046
S	3	0.75 x D	0.5 x D	0.75 x D	330	–	430	IPT	.0012	.0018	.0023	.0027	.0030	.0036
	1	0.75 x D	0.3 x D	0.3 x D	160	–	300	IPT	.0015	.0023	.0029	.0034	.0039	.0045
	2	0.75 x D	0.3 x D	0.3 x D	80	–	130	IPT	.0008	.0012	.0015	.0018	.0021	.0024
	3	0.75 x D	0.5 x D	0.75 x D	80	–	130	IPT	.0008	.0012	.0015	.0018	.0021	.0024
H	4	0.75 x D	0.5 x D	0.75 x D	160	–	200	IPT	.0011	.0017	.0021	.0025	.0028	.0033
	1	0.75 x D	0.5 x D	0.5 x D	260	–	450	IPT	.0014	.0020	.0026	.0030	.0033	.0039

NOTE: Side milling applications – for longest reach (L3) tools, reduce ae by 30%.  
 Slot milling applications – for longest reach (L3) tools, reduce ap by 30%.  
 Lower value of cutting speed is used for high stock removal applications or for higher hardness (machinability) within group.  
 Higher value of cutting speed is used for finishing applications or for lower hardness (machinability) within group.  
 Above parameters are based on ideal conditions. For smaller taper machining centers, please adjust parameters accordingly on >1/2" diameter.

VariMill I • Series 4V00 • Application Data • WP15PE • Inch

Material Group																		
	Side Milling (A) and Slotting (B)			WP15PE			Recommended feed per tooth (IPT = inch/th) for side milling (A). For slotting (B), reduce IPT by 20%.											
	A		B	Cutting Speed – vc SFM			D1 – Diameter											
	ap	ae	ap	min	max	frac.	1/8	3/16	1/4	5/16	3/8	7/16	1/2	5/8	3/4	1	1-1/4	
P	0	1.25 x D	0.5 x D	1 x D	490	–	660	IPT	.0009	.0013	.0018	.0023	.0027	.0031	.0034	.0039	.0044	.0049
	1	1.25 x D	0.5 x D	1 x D	490	–	660	IPT	.0009	.0013	.0018	.0023	.0027	.0031	.0034	.0039	.0044	.0049
	2	1.25 x D	0.5 x D	1 x D	460	–	620	IPT	.0009	.0013	.0018	.0023	.0027	.0031	.0034	.0039	.0044	.0049
	3	1.25 x D	0.5 x D	1 x D	390	–	520	IPT	.0007	.0011	.0015	.0020	.0023	.0026	.0029	.0034	.0039	.0045
	4	1.25 x D	0.5 x D	0.75 x D	300	–	490	IPT	.0007	.0010	.0014	.0017	.0020	.0023	.0026	.0030	.0034	.0039
	5	1.25 x D	0.5 x D	1 x D	200	–	330	IPT	.0006	.0009	.0012	.0016	.0018	.0021	.0023	.0027	.0031	.0036
M	6	1.25 x D	0.5 x D	0.75 x D	160	–	250	IPT	.0005	.0008	.0010	.0013	.0015	.0017	.0019	.0022	.0025	.0028
	1	1.25 x D	0.5 x D	1 x D	300	–	380	IPT	.0007	.0011	.0015	.0020	.0023	.0026	.0029	.0034	.0039	.0045
K	2	1.25 x D	0.5 x D	1 x D	200	–	260	IPT	.0006	.0009	.0012	.0016	.0018	.0021	.0023	.0027	.0031	.0036
	3	1.25 x D	0.5 x D	1 x D	200	–	230	IPT	.0005	.0008	.0010	.0013	.0015	.0017	.0019	.0022	.0025	.0028
S	1	1.25 x D	0.5 x D	1 x D	390	–	490	IPT	.0009	.0013	.0018	.0023	.0027	.0031	.0034	.0039	.0044	.0049
	2	1.25 x D	0.5 x D	1 x D	360	–	460	IPT	.0007	.0011	.0015	.0020	.0023	.0026	.0029	.0034	.0039	.0045
	3	1.25 x D	0.5 x D	1 x D	360	–	430	IPT	.0006	.0009	.0012	.0016	.0018	.0021	.0023	.0027	.0031	.0036
	1	1 x D	0.3 x D	0.3 x D	160	–	300	IPT	.0007	.0011	.0015	.0020	.0023	.0026	.0029	.0034	.0039	.0045
H	2	1 x D	0.3 x D	0.3 x D	80	–	130	IPT	.0004	.0006	.0008	.0010	.0012	.0014	.0015	.0018	.0021	.0024
	3	1.25 x D	0.5 x D	1 x D	80	–	130	IPT	.0004	.0006	.0008	.0010	.0012	.0014	.0015	.0018	.0021	.0024
H	4	1.25 x D	0.5 x D	1 x D	160	–	200	IPT	.0005	.0008	.0011	.0014	.0017	.0019	.0021	.0025	.0028	.0033
	1	1.25 x D	0.5 x D	0.75 x D	260	–	460	IPT	.0007	.0010	.0014	.0017	.0020	.0023	.0026	.0030	.0034	.0039
H	2	1.25 x D	0.2 x D	0.5 x D	230	–	390	IPT	.0005	.0008	.0010	.0013	.0015	.0017	.0019	.0022	.0025	.0028

NOTE: Lower value of cutting speed is used for high stock removal applications or for higher hardness (machinability) within group.  
 Higher value of cutting speed is used for finishing applications or for lower hardness (machinability) within group.  
 Above parameters are based on ideal conditions. For smaller taper machining centers, please adjust parameters accordingly on >1/2" diameter.

VariMill I • Series 4VPO • Application Data • TiAlN-LT • Inch

INDEXABLE MILLING

SOLID END MILLING

HOLEMAKING

TAPPING

TURNING

Material Group	Side Milling (A) and Slotting (B)		TiAlN			Recommended feed per tooth (IPT = inch/th) for side milling (A). For slotting (B), reduce IPT by 20%.								
	A		B		Cutting Speed – vc SFM			D1 – Diameter						
	ap	ae	ap	min	max	frac. dec.	1/4	3/8	1/2	5/8	3/4	1		
	ap	ae	ap	min	max	dec.	.2500	.3750	.5000	.6250	.7500	1.000		
P	0	0.75 x D	0.5 x D	0.75 x D	490	–	660	IPT	.0018	.0027	.0034	.0039	.0044	.0049
	1	0.75 x D	0.5 x D	0.75 x D	490	–	660	IPT	.0018	.0027	.0034	.0039	.0044	.0049
	2	0.75 x D	0.5 x D	0.75 x D	460	–	620	IPT	.0018	.0027	.0034	.0039	.0044	.0049
	3	0.75 x D	0.5 x D	0.75 x D	390	–	520	IPT	.0015	.0023	.0029	.0034	.0039	.0045
	4	0.75 x D	0.5 x D	0.5 x D	300	–	490	IPT	.0014	.0020	.0026	.0030	.0034	.0039
	5	0.75 x D	0.5 x D	0.75 x D	200	–	330	IPT	.0012	.0018	.0023	.0027	.0031	.0036
M	1	0.75 x D	0.5 x D	0.75 x D	300	–	380	IPT	.0015	.0023	.0029	.0034	.0039	.0045
	2	0.75 x D	0.5 x D	0.75 x D	200	–	260	IPT	.0012	.0018	.0023	.0027	.0031	.0036
	3	0.75 x D	0.5 x D	0.75 x D	200	–	230	IPT	.0010	.0015	.0019	.0022	.0025	.0028
K	1	0.75 x D	0.5 x D	0.75 x D	390	–	490	IPT	.0018	.0027	.0034	.0039	.0044	.0049
	2	0.75 x D	0.5 x D	0.75 x D	360	–	460	IPT	.0015	.0023	.0029	.0034	.0039	.0045
	3	0.75 x D	0.5 x D	0.75 x D	360	–	430	IPT	.0012	.0018	.0023	.0027	.0031	.0036
S	1	0.75 x D	0.3 x D	0.3 x D	160	–	300	IPT	.0015	.0023	.0029	.0034	.0039	.0045
	2	0.75 x D	0.3 x D	0.3 x D	80	–	130	IPT	.0008	.0012	.0015	.0018	.0021	.0024
	3	0.75 x D	0.5 x D	0.75 x D	80	–	130	IPT	.0008	.0012	.0015	.0018	.0021	.0024
H	4	0.75 x D	0.5 x D	0.75 x D	160	–	200	IPT	.0011	.0017	.0021	.0025	.0028	.0033
	1	0.75 x D	0.5 x D	0.5 x D	260	–	460	IPT	.0014	.0020	.0026	.0030	.0034	.0039

NOTE: Lower value of cutting speed is used for high stock removal applications or for higher hardness (machinability) within group.  
 Higher value of cutting speed is used for finishing applications or for lower hardness (machinability) within group.  
 Above parameters are based on ideal conditions. For smaller taper machining centers, please adjust parameters accordingly on diameters greater than 1/2".  
 Side milling applications – for longest reach (L3) tools, reduce ae by 30%.  
 Slot milling applications – for longest reach (L3) tools, reduce ae by 30%.

VariMill I • Series 4777 • Application Data • WP15PE • Metric

Material Group	Side Milling (A) and Slotting (B)		WP15PE			Recommended feed per tooth (fz = mm/th) for side milling (A). For slotting (B), reduce fz by 20%.														
	A		B		Cutting Speed – vc m/min			D1 – Diameter												
	ap	ae	ap	min	max	mm	4,0	5,0	6,0	8,0	10,0	12,0	14,0	16,0	18,0	20,0	25,0			
	ap	ae	ap	min	max	mm	fz	fz	fz	fz	fz	fz	fz	fz	fz	fz	fz	fz		
P	0	1,5 x D	0,5 x D	1 x D	150	–	200	fz	0,028	0,036	0,044	0,060	0,072	0,083	0,092	0,101	0,108	0,114	0,124	
	1	1,5 x D	0,5 x D	1 x D	150	–	200	fz	0,028	0,036	0,044	0,060	0,072	0,083	0,092	0,101	0,108	0,114	0,124	
	2	1,5 x D	0,5 x D	1 x D	140	–	190	fz	0,028	0,036	0,044	0,060	0,072	0,083	0,092	0,101	0,108	0,114	0,124	
	3	1,5 x D	0,5 x D	1 x D	120	–	160	fz	0,023	0,030	0,036	0,050	0,061	0,070	0,079	0,087	0,095	0,101	0,114	
	4	1,5 x D	0,5 x D	0,75 x D	90	–	150	fz	0,021	0,027	0,033	0,045	0,054	0,062	0,070	0,077	0,083	0,088	0,098	
	5	1,5 x D	0,5 x D	1 x D	60	–	100	fz	0,019	0,024	0,029	0,040	0,048	0,056	0,063	0,070	0,076	0,081	0,091	
M	1	1,5 x D	0,5 x D	1 x D	90	–	115	fz	0,016	0,020	0,025	0,034	0,040	0,047	0,052	0,057	0,061	0,065	0,071	
	2	1,5 x D	0,5 x D	1 x D	60	–	80	fz	0,019	0,024	0,029	0,040	0,048	0,056	0,063	0,070	0,076	0,081	0,091	
	3	1,5 x D	0,5 x D	1 x D	60	–	70	fz	0,016	0,020	0,025	0,034	0,040	0,047	0,052	0,057	0,061	0,065	0,071	
K	1	1,5 x D	0,5 x D	1 x D	120	–	150	fz	0,028	0,036	0,044	0,060	0,072	0,083	0,092	0,101	0,108	0,114	0,124	
	2	1,5 x D	0,5 x D	1 x D	110	–	140	fz	0,023	0,030	0,036	0,050	0,061	0,070	0,079	0,087	0,095	0,101	0,114	
	3	1,5 x D	0,5 x D	1 x D	110	–	130	fz	0,019	0,024	0,029	0,040	0,048	0,056	0,063	0,070	0,076	0,081	0,091	
S	1	1,5 x D	0,3 x D	0,3 x D	50	–	90	fz	0,023	0,030	0,036	0,050	0,061	0,070	0,079	0,087	0,095	0,101	0,114	
	2	1,5 x D	0,3 x D	0,3 x D	25	–	40	fz	0,013	0,016	0,019	0,026	0,032	0,037	0,042	0,046	0,050	0,054	0,061	
	3	1,5 x D	0,5 x D	1 x D	25	–	40	fz	0,013	0,016	0,019	0,026	0,032	0,037	0,042	0,046	0,050	0,054	0,061	
H	1	1,5 x D	0,5 x D	0,75 x D	80	–	140	fz	0,021	0,027	0,033	0,045	0,054	0,062	0,070	0,077	0,083	0,088	0,098	

NOTE: Lower value of cutting speed is used for high stock removal applications or for higher hardness (machinability) within group.  
 Higher value of cutting speed is used for finishing applications or for lower hardness (machinability) within group.  
 Above parameters are based on ideal conditions. For smaller taper machining centers, please adjust parameters accordingly on >12mm diameters.



VariMill I • Series 4717 • Application Data • TiAlN-LW • Metric

		Side Milling (A)										Recommended feed per tooth (fz = mm/th) for side milling (A).						
Material Group		Finishing					Roughing											
		A		TiAlN			A		TiAlN									
		ap	ae	Cutting Speed – vc		A		Cutting Speed – vc										
				m/min				m/min			D1 – Diameter							
											mm							
P	1	Ap1 max	0,05 x D*	300	–	400	Ap1 max	0,2 x D	150	–	200	fz	0,044	0,060	0,072	0,083	0,092	0,114
	2	Ap1 max	0,05 x D*	280	–	380	Ap1 max	0,2 x D	140	–	190	fz	0,044	0,060	0,072	0,083	0,092	0,114
	3	Ap1 max	0,05 x D*	240	–	320	Ap1 max	0,2 x D	120	–	160	fz	0,036	0,050	0,061	0,070	0,079	0,101
	4	Ap1 max	0,05 x D*	180	–	300	Ap1 max	0,2 x D	90	–	150	fz	0,033	0,045	0,054	0,062	0,070	0,088
	5	Ap1 max	0,05 x D*	120	–	200	Ap1 max	0,2 x D	60	–	100	fz	0,029	0,040	0,048	0,056	0,063	0,081
	6	Ap1 max	0,05 x D*	100	–	150	Ap1 max	0,2 x D	50	–	75	fz	0,025	0,034	0,040	0,047	0,052	0,065
M	1	Ap1 max	0,05 x D*	180	–	230	Ap1 max	0,2 x D	90	–	115	fz	0,036	0,050	0,061	0,070	0,079	0,101
	2	Ap1 max	0,05 x D*	120	–	160	Ap1 max	0,2 x D	60	–	80	fz	0,029	0,040	0,048	0,056	0,063	0,081
	3	Ap1 max	0,05 x D*	120	–	140	Ap1 max	0,2 x D	60	–	70	fz	0,025	0,034	0,040	0,047	0,052	0,065
K	1	Ap1 max	0,05 x D*	240	–	300	Ap1 max	0,2 x D	120	–	150	fz	0,044	0,060	0,072	0,083	0,092	0,114
	2	Ap1 max	0,05 x D*	220	–	260	Ap1 max	0,2 x D	110	–	130	fz	0,036	0,050	0,061	0,070	0,079	0,101
	3	Ap1 max	0,05 x D*	200	–	260	Ap1 max	0,2 x D	100	–	130	fz	0,029	0,040	0,048	0,056	0,063	0,081
S	1	Ap1 max	0,05 x D*	50	–	90	Ap1 max	0,2 x D	50	–	90	fz	0,036	0,050	0,061	0,070	0,087	0,101
	2	Ap1 max	0,05 x D*	25	–	40	Ap1 max	0,2 x D	25	–	40	fz	0,019	0,026	0,032	0,037	0,046	0,054
	3	Ap1 max	0,05 x D*	25	–	40	Ap1 max	0,2 x D	25	–	40	fz	0,019	0,026	0,032	0,037	0,046	0,054
H	3	Ap1 max	0,05 x D*	50	–	60	Ap1 max	0,2 x D	50	–	60	fz	0,026	0,037	0,045	0,052	0,064	0,074
	4	Ap1 max	0,05 x D*	160	–	280	Ap1 max	0,2 x D	80	–	140	fz	0,033	0,045	0,054	0,062	0,070	0,088

\*For cutting data above, use ae ≤ 0,8mm.  
 NOTE: Lower value of cutting speed is used for high stock removal applications or for higher hardness (machinability) within group.  
 Higher value of cutting speed is used for finishing applications or for lower hardness (machinability) within group.  
 Above parameters are based on ideal conditions. For smaller taper machining centers, please adjust parameters accordingly on >12mm diameters.  
 For finishing, increase feed per tooth by 20%.

VariMill I • Series 4727 • Application Data • TiAlN-LW • Metric

		Side Milling (A)										Recommended feed per tooth (fz = mm/th) for side milling (A).					
Material Group		Finishing					Roughing										
		A		TiAlN			A		TiAlN								
		ap	ae	Cutting Speed – vc		A		Cutting Speed – vc									
				m/min				m/min			mm	D1 – Diameter					
												12,0	16,0	20,0			
P	1	Ap1 max	0,05 x D*	300	–	400	Ap1 max	0,2 x D	150	–	200	fz	0,083	0,101	0,114		
	2	Ap1 max	0,05 x D*	280	–	380	Ap1 max	0,2 x D	140	–	190	fz	0,083	0,101	0,114		
	3	Ap1 max	0,05 x D*	240	–	320	Ap1 max	0,2 x D	120	–	160	fz	0,070	0,087	0,101		
	4	Ap1 max	0,05 x D*	180	–	300	Ap1 max	0,2 x D	90	–	150	fz	0,062	0,077	0,088		
	5	Ap1 max	0,05 x D*	120	–	200	Ap1 max	0,2 x D	60	–	100	fz	0,056	0,070	0,081		
	6	Ap1 max	0,05 x D*	100	–	150	Ap1 max	0,2 x D	50	–	75	fz	0,047	0,057	0,065		
M	1	Ap1 max	0,05 x D*	180	–	230	Ap1 max	0,2 x D	90	–	115	fz	0,070	0,087	0,101		
	2	Ap1 max	0,05 x D*	120	–	160	Ap1 max	0,2 x D	60	–	80	fz	0,056	0,070	0,081		
	3	Ap1 max	0,05 x D*	120	–	140	Ap1 max	0,2 x D	60	–	70	fz	0,047	0,057	0,065		
K	1	Ap1 max	0,05 x D*	240	–	300	Ap1 max	0,2 x D	120	–	150	fz	0,083	0,101	0,114		
	2	Ap1 max	0,05 x D*	220	–	260	Ap1 max	0,2 x D	110	–	130	fz	0,070	0,087	0,101		
	3	Ap1 max	0,05 x D*	200	–	260	Ap1 max	0,2 x D	100	–	130	fz	0,056	0,070	0,081		
S	1	Ap1 max	0,05 x D*	50	–	90	Ap1 max	0,2 x D	50	–	90	fz	0,070	0,087	0,101		
	2	Ap1 max	0,05 x D*	25	–	40	Ap1 max	0,2 x D	25	–	40	fz	0,037	0,046	0,054		
	3	Ap1 max	0,05 x D*	25	–	40	Ap1 max	0,2 x D	25	–	40	fz	0,037	0,046	0,054		
H	3	Ap1 max	0,05 x D*	50	–	60	Ap1 max	0,2 x D	50	–	60	fz	0,052	0,064	0,074		
	4	Ap1 max	0,05 x D*	160	–	280	Ap1 max	0,2 x D	80	–	140	fz	0,062	0,077	0,088		



\*For cutting data above, use ae ≤ 0,8mm.  
 NOTE: Lower value of cutting speed is used for high stock removal applications or for higher hardness (machinability) within group.  
 Higher value of cutting speed is used for finishing applications or for lower hardness (machinability) within group.  
 Above parameters are based on ideal conditions. For smaller taper machining centers, please adjust parameters accordingly on >12mm diameters.  
 For finishing, increase feed per tooth by 20%.

VariMill I • Series 4778 • Application Data • WS15PE • Metric

INDEXABLE MILLING

SOLID END MILLING

HOLEMAKING



																
		Side Milling (A) and Slotting (B)			WS15PE			Recommended feed per tooth (fz = mm/th) for side milling (A). For slotting (B), reduce fz by 20%.								
Material Group		A		B	Cutting Speed – vc m/min			mm	D1 – Diameter							
		ap	ae	ap	min	–	max		4,0	6,0	8,0	10,0	12,0	16,0	20,0	25,0
P	1	1,5 x D	0,5 x D	1 x D	150	–	200	fz	0,028	0,044	0,060	0,072	0,083	0,101	0,114	0,124
	2	1,5 x D	0,5 x D	1 x D	140	–	190	fz	0,028	0,044	0,060	0,072	0,083	0,101	0,114	0,124
	3	1,5 x D	0,5 x D	1 x D	120	–	160	fz	0,023	0,036	0,050	0,061	0,070	0,087	0,101	0,114
	4	1,5 x D	0,5 x D	0,75 x D	90	–	150	fz	0,021	0,033	0,045	0,054	0,062	0,077	0,088	0,098
	5	1,5 x D	0,5 x D	1 x D	60	–	100	fz	0,019	0,029	0,040	0,048	0,056	0,070	0,081	0,091
	6	1,5 x D	0,5 x D	0,75 x D	50	–	75	fz	0,016	0,025	0,034	0,040	0,047	0,057	0,065	0,071
M	1	1,5 x D	0,5 x D	1 x D	90	–	115	fz	0,023	0,036	0,050	0,061	0,070	0,087	0,101	0,114
	2	1,5 x D	0,5 x D	1 x D	60	–	80	fz	0,019	0,029	0,040	0,048	0,056	0,070	0,081	0,091
	3	1,5 x D	0,5 x D	1 x D	60	–	70	fz	0,016	0,025	0,034	0,040	0,047	0,057	0,065	0,071
K	1	1,5 x D	0,5 x D	1 x D	120	–	150	fz	0,028	0,044	0,060	0,072	0,083	0,101	0,114	0,124
	2	1,5 x D	0,5 x D	1 x D	110	–	130	fz	0,023	0,036	0,050	0,061	0,070	0,087	0,101	0,114
	3	1,5 x D	0,5 x D	1 x D	100	–	130	fz	0,019	0,029	0,040	0,048	0,056	0,070	0,081	0,091
S	1	1,5 x D	0,3 x D	0,3 x D	50	–	90	fz	0,023	0,036	0,050	0,061	0,070	0,087	0,101	0,114
	2	1,5 x D	0,3 x D	0,3 x D	25	–	40	fz	0,013	0,019	0,026	0,032	0,037	0,046	0,054	0,061
	3	1,5 x D	0,5 x D	1 x D	25	–	40	fz	0,013	0,019	0,026	0,032	0,037	0,046	0,054	0,061
	4	1,5 x D	0,5 x D	1 x D	50	–	60	fz	0,016	0,026	0,037	0,045	0,052	0,064	0,074	0,084
H	1	1,5 x D	0,5 x D	0,75 x D	80	–	140	fz	0,021	0,033	0,045	0,054	0,062	0,077	0,088	0,098

NOTE: Lower value of cutting speed is used for high stock removal applications or for higher hardness (machinability) within group.  
Higher value of cutting speed is used for finishing applications or for lower hardness (machinability) within group.  
Above parameters are based on ideal conditions. For smaller taper machining centers, please adjust parameters accordingly on >12mm diameters.

VariMill I • Series 47N7 • Application Data • WP15PE • Metric

TAPPING

TURNING

																
		Side Milling (A) and Slotting (B)			WP15PE			Recommended feed per tooth (fz = mm/th) for side milling (A). For slotting (B), reduce fz by 20%.								
Material Group		A		B	Cutting Speed – vc m/min			mm	D1 – Diameter							
		ap	ae	ap	min	–	max		4,0	6,0	8,0	10,0	12,0	16,0	20,0	
P	1	1,5 x D	0,5 x D	1 x D	150	–	200	fz	0,028	0,044	0,060	0,072	0,083	0,101	0,114	0,124
	2	1,5 x D	0,5 x D	1 x D	140	–	190	fz	0,028	0,044	0,060	0,072	0,083	0,101	0,114	0,124
	3	1,5 x D	0,5 x D	1 x D	120	–	160	fz	0,023	0,036	0,050	0,061	0,070	0,087	0,101	0,114
	4	1,5 x D	0,5 x D	0,75 x D	90	–	150	fz	0,021	0,033	0,045	0,054	0,062	0,077	0,088	0,098
	5	1,5 x D	0,5 x D	1 x D	60	–	100	fz	0,019	0,029	0,040	0,048	0,056	0,070	0,081	0,091
	6	1,5 x D	0,5 x D	0,75 x D	50	–	75	fz	0,016	0,025	0,034	0,040	0,047	0,057	0,065	0,071
M	1	1,5 x D	0,5 x D	1 x D	90	–	115	fz	0,023	0,036	0,050	0,061	0,070	0,087	0,101	0,114
	2	1,5 x D	0,5 x D	1 x D	60	–	80	fz	0,019	0,029	0,040	0,048	0,056	0,070	0,081	0,091
	3	1,5 x D	0,5 x D	1 x D	60	–	70	fz	0,016	0,025	0,034	0,040	0,047	0,057	0,065	0,071
K	1	1,5 x D	0,5 x D	1 x D	120	–	150	fz	0,028	0,044	0,060	0,072	0,083	0,101	0,114	0,124
	2	1,5 x D	0,5 x D	1 x D	110	–	130	fz	0,023	0,036	0,050	0,061	0,070	0,087	0,101	0,114
	3	1,5 x D	0,5 x D	1 x D	100	–	130	fz	0,019	0,029	0,040	0,048	0,056	0,070	0,081	0,091
S	1	1,5 x D	0,3 x D	0,3 x D	50	–	90	fz	0,023	0,036	0,050	0,061	0,070	0,087	0,101	0,114
	2	1,5 x D	0,3 x D	0,3 x D	25	–	40	fz	0,013	0,019	0,026	0,032	0,037	0,046	0,054	0,061
	3	1,5 x D	0,5 x D	1 x D	25	–	40	fz	0,013	0,019	0,026	0,032	0,037	0,046	0,054	0,061
	4	1,5 x D	0,5 x D	1 x D	50	–	60	fz	0,016	0,026	0,037	0,045	0,052	0,064	0,074	0,084
H	1	1,5 x D	0,5 x D	0,75 x D	80	–	140	fz	0,021	0,033	0,045	0,054	0,062	0,077	0,088	0,098

NOTE: Lower value of cutting speed is used for high stock removal applications or for higher hardness (machinability) within group.  
Higher value of cutting speed is used for finishing applications or for lower hardness (machinability) within group.  
Above parameters are based on ideal conditions. For smaller taper machining centers, please adjust parameters accordingly on >12mm diameters.



VariMill I • Series 47N7 • Application Data • TiAlN • Metric

Material Group	Side Milling (A) and Slotting (B)			TiAlN			Recommended feed per tooth (fz = mm/th) for side milling (A). For slotting (B), reduce fz by 20%.								
	A		B	Cutting Speed – vc m/min			mm	D1 – Diameter							
	ap	ae	ap	min	max	4,0		6,0	8,0	10,0	12,0	16,0	20,0		
	ap	ae	ap	min	max	fz	fz	fz	fz	fz	fz	fz	fz		
P	1	1,5 x D	0,5 x D	1 x D	150	–	200	fz	0,028	0,044	0,060	0,072	0,083	0,101	0,114
	2	1,5 x D	0,5 x D	1 x D	140	–	190	fz	0,028	0,044	0,060	0,072	0,083	0,101	0,114
	3	1,5 x D	0,5 x D	1 x D	120	–	160	fz	0,023	0,036	0,050	0,061	0,070	0,087	0,101
	4	1,5 x D	0,5 x D	0,75 x D	90	–	150	fz	0,021	0,033	0,045	0,054	0,062	0,077	0,088
	5	1,5 x D	0,5 x D	1 x D	60	–	100	fz	0,019	0,029	0,040	0,048	0,056	0,070	0,081
	6	1,5 x D	0,5 x D	0,75 x D	50	–	75	fz	0,016	0,025	0,034	0,040	0,047	0,057	0,065
M	1	1,5 x D	0,5 x D	1 x D	90	–	115	fz	0,023	0,036	0,050	0,061	0,070	0,087	0,101
	2	1,5 x D	0,5 x D	1 x D	60	–	80	fz	0,019	0,029	0,040	0,048	0,056	0,070	0,081
	3	1,5 x D	0,5 x D	1 x D	60	–	70	fz	0,016	0,025	0,034	0,040	0,047	0,057	0,065
K	1	1,5 x D	0,5 x D	1 x D	120	–	150	fz	0,028	0,044	0,060	0,072	0,083	0,101	0,114
	2	1,5 x D	0,5 x D	1 x D	110	–	130	fz	0,023	0,036	0,050	0,061	0,070	0,087	0,101
	3	1,5 x D	0,5 x D	1 x D	100	–	130	fz	0,019	0,029	0,040	0,048	0,056	0,070	0,081
S	1	1,5 x D	0,3 x D	0,3 x D	50	–	90	fz	0,023	0,036	0,050	0,061	0,070	0,087	0,101
	2	1,5 x D	0,3 x D	0,3 x D	25	–	40	fz	0,013	0,019	0,026	0,032	0,037	0,046	0,054
	3	1,5 x D	0,5 x D	1 x D	25	–	40	fz	0,013	0,019	0,026	0,032	0,037	0,046	0,054
	4	1,5 x D	0,5 x D	1 x D	50	–	60	fz	0,016	0,026	0,037	0,045	0,052	0,064	0,074
H	1	1,5 x D	0,5 x D	0,75 x D	80	–	140	fz	0,021	0,033	0,045	0,054	0,062	0,077	0,088

NOTE: Lower value of cutting speed is used for high stock removal applications or for higher hardness (machinability) within group.  
Higher value of cutting speed is used for finishing applications or for lower hardness (machinability) within group.  
Above parameters are based on ideal conditions. For smaller taper machining centers, please adjust parameters accordingly on >12mm diameters.

VariMill I • Series 47N6 • Application Data • TiAlN-LW • Metric

Material Group	Side Milling (A) and Slotting (B)			TiAlN			Recommended feed per tooth (fz = mm/th) for side milling (A). For slotting (B), reduce fz by 20%.							
	A		B	Cutting Speed – vc m/min			mm	D1 – Diameter						
	ap	ae	ap	min	max	6,0		8,0	10,0	12,0	16,0	20,0		
	ap	ae	ap	min	max	fz	fz	fz	fz	fz	fz	fz		
P	0	1,5 x D	0,2 x D	0,5 x D	150	–	200	fz	0,044	0,060	0,072	0,083	0,101	0,114
	1	1,5 x D	0,2 x D	0,5 x D	150	–	200	fz	0,044	0,060	0,072	0,083	0,101	0,114
	2	1,5 x D	0,2 x D	0,5 x D	140	–	190	fz	0,044	0,060	0,072	0,083	0,101	0,114
	3	1,5 x D	0,2 x D	0,5 x D	120	–	160	fz	0,036	0,050	0,061	0,070	0,087	0,101
	4	1,5 x D	0,2 x D	0,5 x D	90	–	150	fz	0,033	0,045	0,054	0,062	0,077	0,088
	5	1,5 x D	0,2 x D	0,5 x D	60	–	100	fz	0,029	0,040	0,048	0,056	0,070	0,081
M	1	1,5 x D	0,2 x D	0,5 x D	90	–	115	fz	0,036	0,050	0,061	0,070	0,087	0,101
	2	1,5 x D	0,2 x D	0,5 x D	60	–	80	fz	0,029	0,040	0,048	0,056	0,070	0,081
	3	1,5 x D	0,2 x D	0,5 x D	60	–	70	fz	0,025	0,034	0,040	0,047	0,057	0,065
K	1	1,5 x D	0,2 x D	0,5 x D	120	–	150	fz	0,044	0,060	0,072	0,083	0,101	0,114
	2	1,5 x D	0,2 x D	0,5 x D	110	–	130	fz	0,036	0,050	0,061	0,070	0,087	0,101
	3	1,5 x D	0,2 x D	0,5 x D	110	–	130	fz	0,029	0,040	0,048	0,056	0,070	0,081
S	1	1,5 x D	0,2 x D	0,5 x D	50	–	90	fz	0,036	0,050	0,061	0,070	0,087	0,101
	2	1,5 x D	0,1 x D	0,3 x D	25	–	40	fz	0,019	0,026	0,032	0,037	0,046	0,054
	3	1,5 x D	0,2 x D	0,5 x D	25	–	40	fz	0,019	0,026	0,032	0,037	0,046	0,054
	4	1,5 x D	0,2 x D	0,5 x D	50	–	60	fz	0,026	0,037	0,045	0,052	0,064	0,074
H	1	1,5 x D	0,1 x D	0,3 x D	80	–	140	fz	0,033	0,045	0,054	0,062	0,077	0,088

NOTE: Lower value of cutting speed is used for high stock removal applications or for higher hardness (machinability) within group.  
Higher value of cutting speed is used for finishing applications or for lower hardness (machinability) within group.  
Above parameters are based on ideal conditions. For smaller taper machining centers, please adjust parameters accordingly on >12mm diameters.

## VariMill I™ • Series 47NO • Application Data • WP15PE/TiAlN-LT • Metric

Material Group																			
	Side Milling (A) and Slotting (B)			WP15PE/TiAlN			Recommended feed per tooth (fz = mm/th) for side milling (A). For slotting (B), reduce fz by 20%.												
	A		B	Cutting Speed – vc m/min			mm	D1 – Diameter											
	ap	ae	ap	min	–	max		5,0	6,0	8,0	10,0	12,0	14,0	16,0	18,0	20,0			
P	0	1,25 x D	0,5 x D	1 x D	150	–	200	fz	0,036	0,044	0,060	0,072	0,083	0,092	0,101	0,108	0,114		
	1	1,25 x D	0,5 x D	1 x D	150	–	200	fz	0,036	0,044	0,060	0,072	0,083	0,092	0,101	0,108	0,114		
	2	1,25 x D	0,5 x D	1 x D	140	–	190	fz	0,036	0,044	0,060	0,072	0,083	0,092	0,101	0,108	0,114		
	3	1,25 x D	0,5 x D	1 x D	120	–	160	fz	0,030	0,036	0,050	0,061	0,070	0,079	0,087	0,095	0,101		
	4	1,25 x D	0,5 x D	0,75 x D	90	–	150	fz	0,027	0,033	0,045	0,054	0,062	0,070	0,077	0,083	0,088		
	5	1,25 x D	0,5 x D	1 x D	60	–	100	fz	0,024	0,029	0,040	0,048	0,056	0,063	0,070	0,076	0,081		
M	6	1,25 x D	0,5 x D	0,75 x D	50	–	75	fz	0,020	0,025	0,034	0,040	0,047	0,052	0,057	0,061	0,065		
	1	1,25 x D	0,5 x D	1 x D	90	–	115	fz	0,030	0,036	0,050	0,061	0,070	0,079	0,087	0,095	0,101		
	2	1,25 x D	0,5 x D	1 x D	60	–	80	fz	0,024	0,029	0,040	0,048	0,056	0,063	0,070	0,076	0,081		
K	3	1,25 x D	0,5 x D	1 x D	60	–	70	fz	0,020	0,025	0,034	0,040	0,047	0,052	0,057	0,061	0,065		
	1	1,25 x D	0,5 x D	1 x D	120	–	150	fz	0,036	0,044	0,060	0,072	0,083	0,092	0,101	0,108	0,114		
S	2	1,25 x D	0,5 x D	1 x D	110	–	140	fz	0,030	0,036	0,050	0,061	0,070	0,079	0,087	0,095	0,101		
	3	1,25 x D	0,5 x D	1 x D	110	–	130	fz	0,024	0,029	0,040	0,048	0,056	0,063	0,070	0,076	0,081		
	1	1 x D	0,3 x D	0,3 x D	50	–	90	fz	0,030	0,036	0,050	0,061	0,070	0,079	0,087	0,095	0,101		
	2	1 x D	0,3 x D	0,3 x D	25	–	40	fz	0,016	0,019	0,026	0,032	0,037	0,042	0,046	0,050	0,054		
H	3	1,25 x D	0,5 x D	1 x D	25	–	40	fz	0,016	0,019	0,026	0,032	0,037	0,042	0,046	0,050	0,054		
	4	1,25 x D	0,5 x D	1 x D	50	–	60	fz	0,021	0,026	0,037	0,045	0,052	0,058	0,064	0,069	0,074		
	1	1,25 x D	0,5 x D	0,75 x D	80	–	140	fz	0,027	0,033	0,045	0,054	0,062	0,070	0,077	0,083	0,088		

NOTE: Lower value of cutting speed is used for high stock removal applications or for higher hardness (machinability) within group.  
 Higher value of cutting speed is used for finishing applications or for lower hardness (machinability) within group.  
 Above parameters are based on ideal conditions. For smaller taper machining centers, please adjust parameters accordingly on >12mm diameters.

INDEXABLE MILLING

SOLID END MILLING

HOLEMAKING

TAPPING

TURNING





The VariMill II 5-flute solid carbide end mill family is a proven leader in high-performance milling, achieving supreme surface finishes in multiple materials through various milling operations, including full slotting up to a depth of cut of 1 x D.

### Features and Benefits

**Unequal flute spacing** to cut harmonics and reduce the development of vibrations during cutting.

**Center cutting** for improved ramping capabilities and plunging.

**38° helix angle** to provide the best combination between a roughing and a finishing tool.

**Unique core design** to offer maximum room for chip evacuation while keeping the tool design stable.



VariMill II carbide end mills utilize a proprietary design driven by a unique relief style and unequal flute spacing.

## **STABLE**

Unequal flute spacing design to ensure low vibrations and high cutting stability.

## **PRODUCTIVE**

5 flutes to increase feed-rate per revolution and exceed metal removal expectations.

## **VERSATILE**

Maximum performance in multiple operations and the best choice to remove great volumes of chips in difficult-to-machine materials.

# ADVANCED PRODUCTIVITY

## PRODUCT

SOLID CARBIDE END MILL

GRADE

WP15PE  
WS15PE

FLUTE

5

DIAMETER RANGE

INCH

3/16–1"

METRIC

4–25mm

## INDUSTRY



GENERAL  
ENGINEERING



AEROSPACE



ENERGY



TRANSPORTATION

## APPLICATIONS

MATERIALS

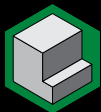

SIDE MILLING

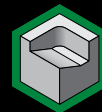

RAMPING



HELICAL  
INTERPOLATION



SLOTTING



DYNAMIC  
MILLING



PLUNGING

VariMill II • Series 5V0C • Square End • 5 Flute • Inch

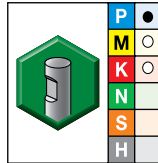
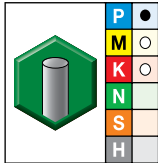
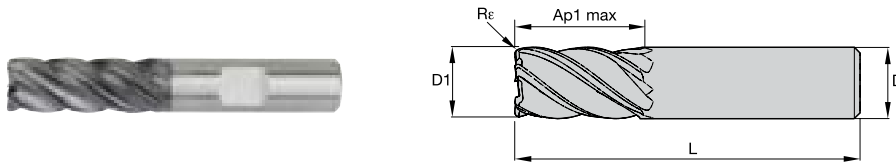

● first choice  
○ alternate choice

WP15PE		WP15PE		D1	D	length of cut Ap1 max	length L	Re	ZU
order #	catalog #	order #	catalog #						
5577051	5V0C05000AT	-	-	3/16	3/16	5/8	2 1/4	.015	5
5577052	5V0C05000BT	-	-	3/16	3/16	5/8	2 1/4	.030	5
5577053	5V0C05000ST	-	-	3/16	3/16	5/8	2 1/4	-	5
6513583	5V1C05020AT	-	-	3/16	3/16	3/4	2 1/2	.015	5
6513582	5V1C05020ST	-	-	3/16	3/16	3/4	2 1/2	-	5
6513585	5V4C07002AT	-	-	1/4	1/4	3/8	2	.015	5
6513586	5V4C07002BT	-	-	1/4	1/4	3/8	2	.030	5
6513584	5V4C07002ST	-	-	1/4	1/4	3/8	2	-	5
5577054	5V0C07002AT	-	-	1/4	1/4	3/4	2 1/2	.015	5
5577055	5V0C07002BT	-	-	1/4	1/4	3/4	2 1/2	.030	5
5577056	5V0C07002CT	-	-	1/4	1/4	3/4	2 1/2	.060	5
5577057	5V0C07002ST	-	-	1/4	1/4	3/4	2 1/2	-	5
6513588	5V1C07002AT	-	-	1/4	1/4	1 1/8	3	.015	5
6513589	5V1C07002BT	-	-	1/4	1/4	1 1/8	3	.030	5
6513587	5V1C07002ST	-	-	1/4	1/4	1 1/8	3	-	5
5577058	5V0C08003AT	-	-	5/16	5/16	3/4	2 1/2	.015	5
5577059	5V0C08003BT	-	-	5/16	5/16	3/4	2 1/2	.030	5
5577100	5V0C08003CT	-	-	5/16	5/16	3/4	2 1/2	.060	5
5577101	5V0C08003ST	-	-	5/16	5/16	3/4	2 1/2	-	5
6513591	5V4C10004AT	-	-	3/8	3/8	1/2	2	.015	5
6513592	5V4C10004BT	-	-	3/8	3/8	1/2	2	.030	5
6513590	5V4C10004ST	-	-	3/8	3/8	1/2	2	-	5
5577102	5V0C10004AT	-	-	3/8	3/8	7/8	2 1/2	.015	5
5577103	5V0C10004BT	-	-	3/8	3/8	7/8	2 1/2	.030	5
5577104	5V0C10004CT	-	-	3/8	3/8	7/8	2 1/2	.060	5
5577105	5V0C10004ST	-	-	3/8	3/8	7/8	2 1/2	-	5
6513594	5V1C10014AT	-	-	3/8	3/8	1 1/4	3	.015	5
6513595	5V1C10014BT	-	-	3/8	3/8	1 1/4	3	.030	5
6513593	5V1C10014ST	-	-	3/8	3/8	1 1/4	3	-	5
6517095	5V4C13015BT	-	-	1/2	1/2	5/8	2 1/2	.030	5
6517096	5V4C13015CT	-	-	1/2	1/2	5/8	2 1/2	.060	5
6517094	5V4C13015ST	-	-	1/2	1/2	5/8	2 1/2	-	5
6517098	5V0C13005BT	-	-	1/2	1/2	1	3	.030	5
6517097	5V0C13005ST	-	-	1/2	1/2	1	3	-	5
5577106	5V0C13015AT	5577107	5V0C13015AW	1/2	1/2	1 1/4	3	.015	5
5577108	5V0C13015BT	5577109	5V0C13015BW	1/2	1/2	1 1/4	3	.030	5
5577110	5V0C13015CT	5577111	5V0C13015CW	1/2	1/2	1 1/4	3	.060	5
5577112	5V0C13015DT	5577113	5V0C13015DW	1/2	1/2	1 1/4	3	.090	5
5577114	5V0C13015ET	5577115	5V0C13015EW	1/2	1/2	1 1/4	3	.120	5
5577116	5V0C13015ST	5577117	5V0C13015SW	1/2	1/2	1 1/4	3	-	5
6517100	5V1C13015AT	-	-	1/2	1/2	1 5/8	4	.015	5
6517111	5V1C13015BT	-	-	1/2	1/2	1 5/8	4	.030	5
6517112	5V1C13015CT	-	-	1/2	1/2	1 5/8	4	.060	5
6517099	5V1C13015ST	-	-	1/2	1/2	1 5/8	4	-	5
6517114	5V1C13025BT	-	-	1/2	1/2	2 1/8	4	.030	5
6517115	5V1C13025CT	-	-	1/2	1/2	2 1/8	4	.060	5
6517116	5V1C13025ET	-	-	1/2	1/2	2 1/8	4	.120	5
6517113	5V1C13025ST	-	-	1/2	1/2	2 1/8	4	-	5
6517118	5V4C16006BT	-	-	5/8	5/8	3/4	3	.030	5
6517117	5V4C16006ST	-	-	5/8	5/8	3/4	3	-	5
5577118	5V0C16006BT	5577119	5V0C16006BW	5/8	5/8	1 1/4	3 1/2	.030	5
5577130	5V0C16006CT	5577131	5V0C16006CW	5/8	5/8	1 1/4	3 1/2	.060	5

INDEXABLE MILLING

SOLID END MILLING

HOLEMAKING

TAPPING

TURNING

VariMill II • Series 5V0C • Square End • 5 Flute • Inch

(continued)

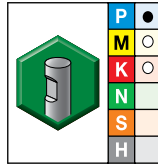
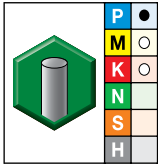
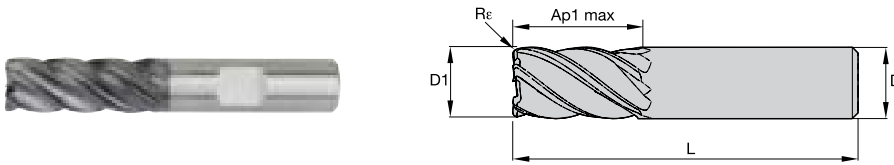

● first choice  
○ alternate choice

WP15PE		WP15PE		D1	D	length of cut Ap1 max	length L	Re	ZU
order #	catalog #	order #	catalog #						
5577132	5V0C16006DT	5577133	5V0C16006DW	5/8	5/8	1 1/4	3 1/2	.090	5
5577134	5V0C16006ST	5577135	5V0C16006SW	5/8	5/8	1 1/4	3 1/2	—	5
6517120	5V1C16006BT	—	—	5/8	5/8	1 5/8	3 1/2	.030	5
6517121	5V1C16006CT	—	—	5/8	5/8	1 5/8	3 1/2	.060	5
6517122	5V1C16006ET	—	—	5/8	5/8	1 5/8	3 1/2	.120	5
6517119	5V1C16006ST	—	—	5/8	5/8	1 5/8	3 1/2	—	5
6517123	5V6C16006ST	—	—	5/8	5/8	2 1/8	4 1/2	—	5
6517125	5V1C16016BT	—	—	5/8	5/8	2 5/8	5	.030	5
6517124	5V1C16016ST	—	—	5/8	5/8	2 5/8	5	—	5
5577136	5V0C19007BT	5577137	5V0C19007BW	3/4	3/4	1 1/2	4	.030	5
5577138	5V0C19007CT	5577139	5V0C19007CW	3/4	3/4	1 1/2	4	.060	5
5577160	5V0C19007DT	5577161	5V0C19007DW	3/4	3/4	1 1/2	4	.090	5
5577162	5V0C19007ET	5577163	5V0C19007EW	3/4	3/4	1 1/2	4	.120	5
5577164	5V0C19007ST	5577165	5V0C19007SW	3/4	3/4	1 1/2	4	—	5
6517141	5V0C19027BT	—	—	3/4	3/4	1 3/4	4	.030	5
6517142	5V0C19027CT	—	—	3/4	3/4	1 3/4	4	.060	5
6517130	5V0C19027ST	—	—	3/4	3/4	1 3/4	4	—	5
6517146	5V1C19007BT	—	—	3/4	3/4	2 1/4	5	.030	5
6517147	5V1C19007CT	—	—	3/4	3/4	2 1/4	5	.060	5
6517148	5V1C19007ET	—	—	3/4	3/4	2 1/4	5	.120	5
6517145	5V1C19007ST	—	—	3/4	3/4	2 1/4	5	—	5
6517150	5V2C19017BT	—	—	3/4	3/4	3 1/4	6	.030	5
6517149	5V2C19017ST	—	—	3/4	3/4	3 1/4	6	—	5
5577166	5V0C25008BT	5577167	5V0C25008BW	1	1	1 3/4	4 1/2	.030	5
5577168	5V0C25008CT	5577169	5V0C25008CW	1	1	1 3/4	4 1/2	.060	5
5577182	5V0C25008ET	5577183	5V0C25008EW	1	1	1 3/4	4 1/2	.120	5
5577184	5V0C25008ST	5577185	5V0C25008SW	1	1	1 3/4	4 1/2	—	5
6517154	5V6C25008BT	—	—	1	1	2 1/4	5	.030	5
6517155	5V6C25008CT	—	—	1	1	2 1/4	5	.060	5
6517153	5V6C25008ST	—	—	1	1	2 1/4	5	—	5
6517159	5V1C25008ET	—	—	1	1	3 1/4	6	.120	5

INDEXABLE MILLING

SOLID END MILLING

HOLEMAKING

TAPPING

TURNING

## VariMill II • Series 5VNC • Square End • Neck • 5 Flute • Inch

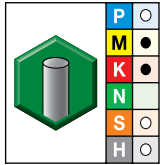
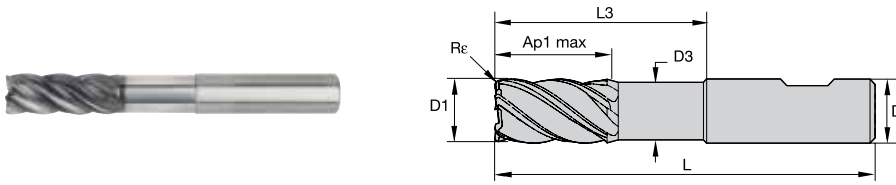

WP15PE

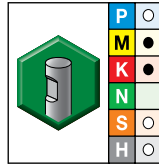

WP15PE

- first choice
- alternate choice

order #	catalog #	order #	catalog #	D1	D	D3	length of cut Ap1 max	L3	length L	Re	ZU
5594727	5VNC07012AT	—	—	1/4	1/4	.24	1/2	1.250	4	.015	5
5594728	5VNC10014AT	—	—	3/8	3/8	.35	7/8	1.875	4	.015	5
5594729	5VNC13005BT	5594850	5VNC13005BW	1/2	1/2	.47	1 1/4	2.250	4	.030	5
5594851	5VNC16006BT	5594852	5VNC16006BW	5/8	5/8	.59	1 1/4	2.250	4	.030	5
5594853	5VNC19017BT	5594854	5VNC19017BW	3/4	3/4	.71	1 1/2	3.250	5 1/2	.030	5
5594855	5VNC25018BT	5594856	5VNC25018BW	1	1	.94	1 3/4	3.250	5 1/2	.030	5

INDEXABLE MILLING

SOLID END MILLING

HOLEMAKING

TAPPING

TURNING

VariMill II • Series 5V0S • Square End • 5 Flute • Inch

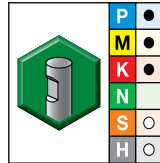
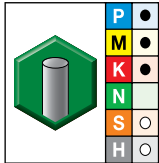
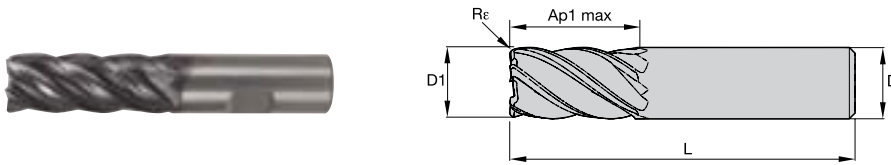

● first choice  
○ alternate choice

WP15PE		WP15PE		D1	D	length of cut Ap1 max	length L	Rε	ZU
order #	catalog #	order #	catalog #						
3552614	TM5V0S05000A	-	-	3/16	3/16	5/8	2 1/4	.015	5
3552615	TM5V0S05000B	-	-	3/16	3/16	5/8	2 1/4	.030	5
3552613	TM5V0S05000S	-	-	3/16	3/16	5/8	2 1/4	-	5
3552617	TM5V0S07002A	-	-	1/4	1/4	3/4	2 1/2	.015	5
3552618	TM5V0S07002B	-	-	1/4	1/4	3/4	2 1/2	.030	5
3660162	TM5V0S07002C	-	-	1/4	1/4	3/4	2 1/2	.060	5
3552616	TM5V0S07002S	-	-	1/4	1/4	3/4	2 1/2	-	5
3552585	TM5V0S08003A	-	-	5/16	5/16	3/4	2 1/2	.015	5
3552587	TM5V0S08003B	-	-	5/16	5/16	3/4	2 1/2	.030	5
3552586	TM5V0S08003S	-	-	5/16	5/16	3/4	2 1/2	-	5
3552589	TM5V0S10004A	-	-	3/8	3/8	7/8	2 1/2	.015	5
3552590	TM5V0S10004B	-	-	3/8	3/8	7/8	2 1/2	.030	5
3660385	TM5V0S10004C	-	-	3/8	3/8	7/8	2 1/2	.060	5
3552588	TM5V0S10004S	-	-	3/8	3/8	7/8	2 1/2	-	5
3552620	TM5V0S13015A	3552580	TM5V0S13015AW	1/2	1/2	1 1/4	3	.015	5
3552621	TM5V0S13015B	3552581	TM5V0S13015BW	1/2	1/2	1 1/4	3	.030	5
3660386	TM5V0S13015C	3660390	TM5V0S13015CW	1/2	1/2	1 1/4	3	.060	5
3552622	TM5V0S13015E	3552582	TM5V0S13015EW	1/2	1/2	1 1/4	3	.120	5
3552619	TM5V0S13015S	3552579	TM5V0S13015SW	1/2	1/2	1 1/4	3	-	5
3552612	TM5V0S16006B	3552578	TM5V0S16006BW	5/8	5/8	1 1/4	3 1/2	.030	5
3552611	TM5V0S16006S	3552577	TM5V0S16006SW	5/8	5/8	1 1/4	3 1/2	-	5
3552592	TM5V0S19007B	3552538	TM5V0S19007BW	3/4	3/4	1 1/2	4	.030	5
3552591	TM5V0S19007S	-	-	3/4	3/4	1 1/2	4	-	5
3552607	TM5V0S25008B	-	-	1	1	1 3/4	4 1/2	.030	5

INDEXABLE MILLING

SOLID END MILLING

HOLEMAKING

TAPPING

TURNING

## VariMill II • Series 5VNS • Square End • Neck • 5 Flute • Inch

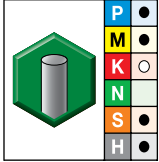
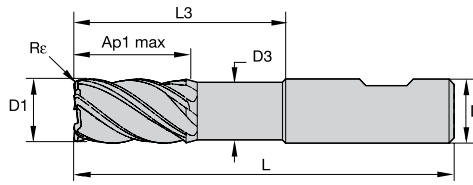

AITiN-MT

- first choice
- alternate choice

order #	catalog #	D1	D	D3	length of cut Ap1 max	L3	length L	Re	ZU
3552489	TM5VNS10014A	3/8	3/8	.35	7/8	1 7/8	4	.015	5
3738996	TM5VNS13005B	1/2	1/2	.47	1 1/4	2 1/4	4	.030	5
3738998	TM5VNS19017B	3/4	3/4	.71	1 1/2	3 1/4	5 1/2	.030	5
3738999	TM5VNS25018B	1	1	.94	1 3/4	3 1/4	5 1/2	.030	5

INDEXABLE MILLING

SOLID END MILLING

HOLEMAKING

TAPPING

TURNING

VariMill II ER • Series 5VOE • Square End • Eccentric Relief • 5 Flute • Inch

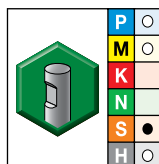
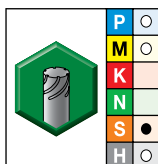
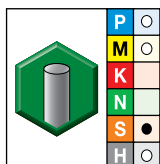
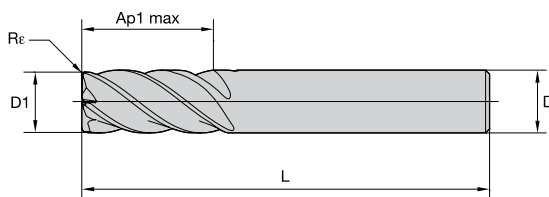

● first choice  
○ alternate choice

WS15PE		WS15PE		WS15PE		length of cut		length	Re	ZU	
order #	catalog #	order #	catalog #	order #	catalog #	D1	D	Ap1 max	L		
6146484	5V4E05000AT	-	-	-	-	3/16	3/16	5/16	2	.015	5
6146485	5V4E05000BT	-	-	-	-	3/16	3/16	5/16	2	.030	5
6146483	5V4E05000ST	-	-	-	-	3/16	3/16	5/16	2	-	5
6146487	5V0E05000AT	-	-	-	-	3/16	3/16	9/16	2	.015	5
6146488	5V0E05000BT	-	-	-	-	3/16	3/16	9/16	2	.030	5
6146486	5V0E05000ST	-	-	-	-	3/16	3/16	9/16	2	-	5
6146490	5V1E05000AT	-	-	-	-	3/16	3/16	3/4	2 1/2	.015	5
6146521	5V1E05000BT	-	-	-	-	3/16	3/16	3/4	2 1/2	.030	5
6146489	5V1E05000ST	-	-	-	-	3/16	3/16	3/4	2 1/2	-	5
6146523	5V4E07002AT	-	-	-	-	1/4	1/4	3/8	2	.015	5
6146524	5V4E07002BT	-	-	-	-	1/4	1/4	3/8	2	.030	5
6146525	5V4E07002CT	-	-	-	-	1/4	1/4	3/8	2	.060	5
6146522	5V4E07002ST	-	-	-	-	1/4	1/4	3/8	2	-	5
6146528	5V0E07002AT	-	-	-	-	1/4	1/4	3/4	2 1/2	.015	5
6146529	5V0E07002BT	-	-	-	-	1/4	1/4	3/4	2 1/2	.030	5
6146530	5V0E07002CT	-	-	-	-	1/4	1/4	3/4	2 1/2	.060	5
6146526	5V0E07002ST	-	-	-	-	1/4	1/4	3/4	2 1/2	-	5
6146532	5V1E07002AT	-	-	-	-	1/4	1/4	1 1/8	3	.015	5
6146533	5V1E07002BT	-	-	-	-	1/4	1/4	1 1/8	3	.030	5
6146534	5V1E07002CT	-	-	-	-	1/4	1/4	1 1/8	3	.060	5
6146531	5V1E07002ST	-	-	-	-	1/4	1/4	1 1/8	3	-	5
6146536	5V0E08003AT	-	-	-	-	5/16	5/16	13/16	2 1/2	.015	5
6146537	5V0E08003BT	-	-	-	-	5/16	5/16	13/16	2 1/2	.030	5
6146538	5V0E08003CT	-	-	-	-	5/16	5/16	13/16	2 1/2	.060	5
6146535	5V0E08003ST	-	-	-	-	5/16	5/16	13/16	2 1/2	-	5
6146540	5V4E10004AT	-	-	-	-	3/8	3/8	1/2	2	.015	5
6146541	5V4E10004BT	-	-	-	-	3/8	3/8	1/2	2	.030	5
6146542	5V4E10004CT	-	-	-	-	3/8	3/8	1/2	2	.060	5
6146543	5V4E10004ET	-	-	-	-	3/8	3/8	1/2	2	.120	5
6146539	5V4E10004ST	-	-	-	-	3/8	3/8	1/2	2	-	5
5594857	5V0E10004AT	-	-	-	-	3/8	3/8	7/8	2 1/2	.015	5
5594858	5V0E10004BT	-	-	-	-	3/8	3/8	7/8	2 1/2	.030	5
5594859	5V0E10004ST	-	-	-	-	3/8	3/8	7/8	2 1/2	-	5
6146545	5V0E10014AT	-	-	-	-	3/8	3/8	1	2 1/2	.015	5
6146546	5V0E10014BT	-	-	-	-	3/8	3/8	1	2 1/2	.030	5
6146547	5V0E10014CT	-	-	-	-	3/8	3/8	1	2 1/2	.060	5
6146548	5V0E10014ET	-	-	-	-	3/8	3/8	1	2 1/2	.120	5
6146544	5V0E10014ST	-	-	-	-	3/8	3/8	1	2 1/2	-	5
6146550	5V1E10004AT	-	-	-	-	3/8	3/8	1	3	.015	5
6146551	5V1E10004BT	-	-	-	-	3/8	3/8	1	3	.030	5
6146549	5V1E10004ST	-	-	-	-	3/8	3/8	1	3	-	5
-	-	6146552	5V4E13015AV	-	-	1/2	1/2	5/8	2 1/2	.015	5
-	-	6146553	5V4E13015BV	-	-	1/2	1/2	5/8	2 1/2	.030	5
-	-	6146554	5V4E13015CV	-	-	1/2	1/2	5/8	2 1/2	.060	5
-	-	6146555	5V4E13015DV	-	-	1/2	1/2	5/8	2 1/2	.090	5
-	-	6146556	5V4E13015EV	-	-	1/2	1/2	5/8	2 1/2	.120	5
-	-	6146557	5V4E13015SV	-	-	1/2	1/2	5/8	2 1/2	-	5
6146558	5V0E13005BT	-	-	-	-	1/2	1/2	1	3	.030	5
6146559	5V0E13005CT	-	-	-	-	1/2	1/2	1	3	.060	5
6146560	5V0E13005ET	-	-	-	-	1/2	1/2	1	3	.120	5
6146561	5V0E13005ST	-	-	-	-	1/2	1/2	1	3	-	5
6146562	5V0E13015AT	5594860	5V0E13015AV	5594861	5V0E13015AW	1/2	1/2	1 1/4	3	.015	5
6146563	5V0E13015BT	5594862	5V0E13015BV	5594863	5V0E13015BW	1/2	1/2	1 1/4	3	.030	5
6146564	5V0E13015CT	5594864	5V0E13015CV	5594865	5V0E13015CW	1/2	1/2	1 1/4	3	.060	5
6146565	5V0E13015DT	5594866	5V0E13015DV	5594867	5V0E13015DW	1/2	1/2	1 1/4	3	.090	5
6146566	5V0E13015ET	5594868	5V0E13015EV	5594869	5V0E13015EW	1/2	1/2	1 1/4	3	.120	5

INDEXABLE MILLING

SOLID END MILLING

HOLEMAKING

TAPPING

TURNING



## VariMill II ER • Series 5VOE • Square End • Eccentric Relief • 5 Flute • Inch

(continued)

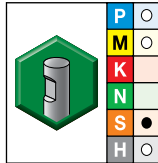
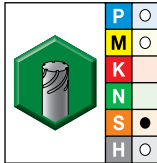
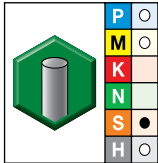
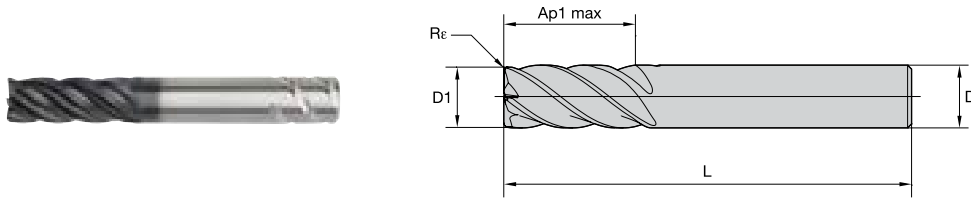

● first choice  
○ alternate choice

WS15PE		WS15PE		WS15PE		D1	D	length of cut Ap1 max	length L	Re	ZU
6146567	5V0E13015ST	5594870	5V0E13015SV	5594871	5V0E13015SW	1/2	1/2	1 1/4	3	—	5
6146568	5V1E13015BT	—	—	—	—	1/2	1/2	1 5/8	4	.030	5
6146569	5V1E13015CT	—	—	—	—	1/2	1/2	1 5/8	4	.060	5
6146570	5V1E13015ET	—	—	—	—	1/2	1/2	1 5/8	4	.120	5
6146571	5V1E13015ST	—	—	—	—	1/2	1/2	1 5/8	4	—	5
6525205	5V6E13015BT	—	—	—	—	1/2	1/2	2 1/8	4	.030	5
6525206	5V6E13015CT	—	—	—	—	1/2	1/2	2 1/8	4	.060	5
6525207	5V6E13015ET	—	—	—	—	1/2	1/2	2 1/8	4	.120	5
6525204	5V6E13015ST	—	—	—	—	1/2	1/2	2 1/8	4	—	5
—	—	6146572	5V4E16006BV	—	—	5/8	5/8	3/4	3	.030	5
—	—	6146573	5V4E16006CV	—	—	5/8	5/8	3/4	3	.060	5
—	—	6146574	5V4E16006EV	—	—	5/8	5/8	3/4	3	.120	5
—	—	6146575	5V4E16006SV	—	—	5/8	5/8	3/4	3	—	5
6146576	5V0E16006BT	5594872	5V0E16006BV	5594873	5V0E16006BW	5/8	5/8	1 1/4	3 1/2	.030	5
6146577	5V0E16006CT	5594874	5V0E16006CV	5594875	5V0E16006CW	5/8	5/8	1 1/4	3 1/2	.060	5
6146578	5V0E16006ET	—	—	—	—	5/8	5/8	1 1/4	3 1/2	.120	5
6146579	5V0E16006ST	5594876	5V0E16006SV	5594877	5V0E16006SW	5/8	5/8	1 1/4	3 1/2	—	5
—	—	6146580	5V1E16006BV	—	—	5/8	5/8	1 5/8	3 1/2	.030	5
—	—	6146581	5V1E16006CV	6146582	5V1E16006CW	5/8	5/8	1 5/8	3 1/2	.060	5
—	—	6146583	5V1E16006DV	—	—	5/8	5/8	1 5/8	3 1/2	.090	5
—	—	6146584	5V1E16006EV	—	—	5/8	5/8	1 5/8	3 1/2	.120	5
—	—	6146585	5V1E16006SV	—	—	5/8	5/8	1 5/8	3 1/2	—	5
6525209	5V6E16006BT	—	—	—	—	5/8	5/8	2 5/8	5	.030	5
6525210	5V6E16006CT	—	—	—	—	5/8	5/8	2 5/8	5	.060	5
6525231	5V6E16006ET	—	—	—	—	5/8	5/8	2 5/8	5	.120	5
6525208	5V6E16006ST	—	—	—	—	5/8	5/8	2 5/8	5	—	5
6146591	5V0E19007BT	5594878	5V0E19007BV	5594879	5V0E19007BW	3/4	3/4	1 1/2	4	.030	5
6146592	5V0E19007CT	5594880	5V0E19007CV	5594881	5V0E19007CW	3/4	3/4	1 1/2	4	.060	5
—	—	5594882	5V0E19007DV	5594883	5V0E19007DW	3/4	3/4	1 1/2	4	.090	5
6146593	5V0E19007ET	5594884	5V0E19007EV	5594885	5V0E19007EW	3/4	3/4	1 1/2	4	.120	5
—	—	—	—	6146590	5V0E19007FW	3/4	3/4	1 1/2	4	.250	5
6146594	5V0E19007ST	5594886	5V0E19007SV	5594887	5V0E19007SW	3/4	3/4	1 1/2	4	—	5
—	—	6146595	5V0E19017BV	—	—	3/4	3/4	1 5/8	4	.030	5
—	—	6146596	5V0E19017CV	—	—	3/4	3/4	1 5/8	4	.060	5
—	—	6146597	5V0E19017EV	—	—	3/4	3/4	1 5/8	4	.120	5
—	—	6146598	5V0E19017SV	—	—	3/4	3/4	1 5/8	4	—	5
6525233	5V0E19027BT	—	—	—	—	3/4	3/4	1 3/4	4	.030	5
6525234	5V0E19027CT	—	—	—	—	3/4	3/4	1 3/4	4	.060	5
6525235	5V0E19027ET	—	—	—	—	3/4	3/4	1 3/4	4	.120	5
6525232	5V0E19027ST	—	—	—	—	3/4	3/4	1 3/4	4	—	5
6525237	5V1E19007BT	—	—	—	—	3/4	3/4	2 1/4	5	.030	5
6525238	5V1E19007CT	6146599	5V1E19007CV	—	—	3/4	3/4	2 1/4	5	.060	5
6525239	5V1E19007ET	6146600	5V1E19007EV	—	—	3/4	3/4	2 1/4	5	.120	5
6525236	5V1E19007ST	6146601	5V1E19007SV	—	—	3/4	3/4	2 1/4	5	—	5
6525261	5V2E19007BT	—	—	—	—	3/4	3/4	3 1/4	6	.030	5
6525240	5V2E19007ST	—	—	—	—	3/4	3/4	3 1/4	6	—	5
—	—	6146607	5V4E25008FV	—	—	1	1	1 1/4	4	.250	5
—	—	6146608	5V4E25008SV	—	—	1	1	1 1/4	4	—	5
6525263	5V0E25008BT	5594888	5V0E25008BV	5594889	5V0E25008BW	1	1	1 3/4	4 1/2	.030	5
6525264	5V0E25008CT	5594890	5V0E25008CV	5594891	5V0E25008CW	1	1	1 3/4	4 1/2	.060	5
6525265	5V0E25008ET	5594892	5V0E25008EV	5594893	5V0E25008EW	1	1	1 3/4	4 1/2	.120	5
—	—	5594894	5V0E25008FV	5594895	5V0E25008FW	1	1	1 3/4	4 1/2	.250	5
6525262	5V0E25008ST	5594896	5V0E25008SV	5594897	5V0E25008SW	1	1	1 3/4	4 1/2	—	5
—	—	—	—	6146609	5V1E25008AW	1	1	3 1/4	6	.015	5
6525267	5V1E25008BT	—	—	6146610	5V1E25008BW	1	1	3 1/4	6	.030	5
6525268	5V1E25008CT	—	—	6146611	5V1E25008CW	1	1	3 1/4	6	.060	5

INDEXABLE MILLING

SOLID END MILLING

HOLEMAKING

TAPPING

TURNING

VariMill II ER • Series 5VOE • Square End • Eccentric Relief • 5 Flute • Inch

(continued)

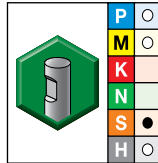
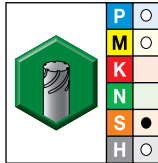
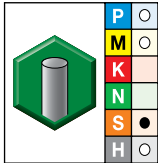
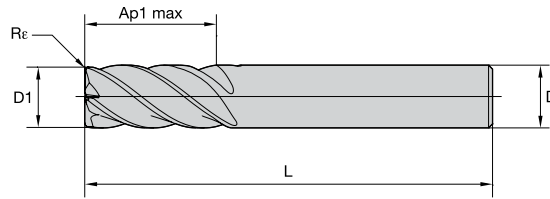

● first choice  
○ alternate choice

WS15PE		WS15PE		WS15PE		D1	D	length of cut Ap1 max	length L	Re	ZU
order #	catalog #	order #	catalog #	order #	catalog #						
-	-	-	-	6146612	5V1E25008DW	1	1	3 1/4	6	.090	5
-	-	-	-	6146613	5V1E25008EW	1	1	3 1/4	6	.120	5
-	-	-	-	6146614	5V1E25008FW	1	1	3 1/4	6	.250	5
6525266	5V1E25008ST	-	-	6146615	5V1E25008SW	1	1	3 1/4	6	-	5
-	-	-	-	6146618	5V0E32009CW	1 1/4	1 1/4	3 1/4	6	.060	5
-	-	-	-	6146619	5V0E32009SW	1 1/4	1 1/4	3 1/4	6	-	5
-	-	-	-	6146620	5V1E32009CW	1 1/4	1 1/4	5	8	.060	5
-	-	-	-	6146621	5V1E32009SW	1 1/4	1 1/4	5	8	-	5

INDEXABLE MILLING

SOLID END MILLING

HOLEMAKING

TAPPING

TURNING

## VariMill II ER • Series 5VNE • Square End • Eccentric Relief • Neck • 5 Flute • Inch

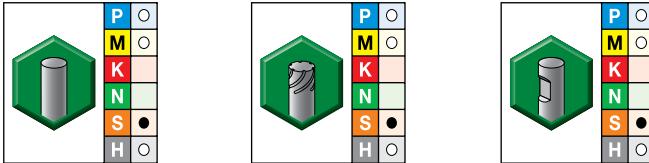
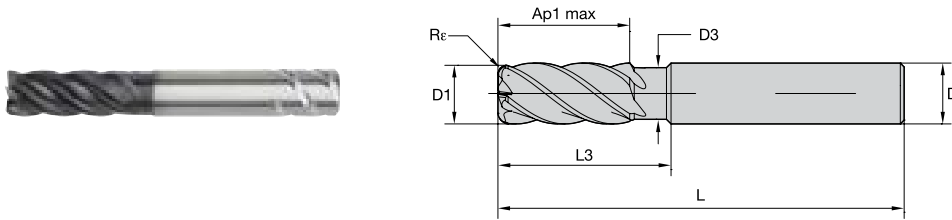

● first choice  
○ alternate choice

WS15PE		WS15PE		WS15PE		D1	D	D3	length of cut Ap1 max	L3	length L	Re	ZU
order #	catalog #	order #	catalog #	order #	catalog #								
6168921	5VNE07002AT	—	—	—	—	1/4	1/4	.24	3/8	1.125	2 1/2	.015	5
6168922	5VNE07002BT	—	—	—	—	1/4	1/4	.24	3/8	1.125	2 1/2	.030	5
6168660	5VNE07002ST	—	—	—	—	1/4	1/4	.24	3/8	1.125	2 1/2	—	5
6168925	5VNE07012AT	—	—	—	—	1/4	1/4	.24	5/8	1.750	4	.015	5
6168926	5VNE07012BT	—	—	—	—	1/4	1/4	.24	5/8	1.750	4	.030	5
6168924	5VNE07012ST	—	—	—	—	1/4	1/4	.24	5/8	1.750	4	—	5
6168929	5VNE10004AT	—	—	—	—	3/8	3/8	.35	1/2	1.375	3	.015	5
6168930	5VNE10004BT	—	—	—	—	3/8	3/8	.35	1/2	1.375	3	.030	5
6168941	5VNE10004CT	—	—	—	—	3/8	3/8	.35	1/2	1.375	3	.060	5
6168928	5VNE10004ST	—	—	—	—	3/8	3/8	.35	1/2	1.375	3	—	5
5594898	5VNE10014AT	—	—	—	—	3/8	3/8	.35	7/8	1.875	4	.015	5
6168943	5VNE10014BT	—	—	—	—	3/8	3/8	.35	7/8	1.875	4	.030	5
6168944	5VNE10014CT	—	—	—	—	3/8	3/8	.35	7/8	1.875	4	.060	5
6168942	5VNE10014ST	—	—	—	—	3/8	3/8	.35	7/8	1.875	4	—	5
6168946	5VNE10024AT	—	—	—	—	3/8	3/8	.35	7/8	2.375	4	.015	5
6168947	5VNE10024BT	—	—	—	—	3/8	3/8	.35	7/8	2.375	4	.030	5
6168948	5VNE10024CT	—	—	—	—	3/8	3/8	.35	7/8	2.375	4	.060	5
6168945	5VNE10024ST	—	—	—	—	3/8	3/8	.35	7/8	2.375	4	—	5
6168954	5VNE13005AT	—	—	—	—	1/2	1/2	.47	1 1/4	2.250	4	.015	5
—	—	5594899	5VNE13005BV	5594900	5VNE13005BW	1/2	1/2	.47	1 1/4	2.250	4	.030	5
6168955	5VNE13005CT	—	—	—	—	1/2	1/2	.47	1 1/4	2.250	4	.060	5
6168956	5VNE13005DT	—	—	—	—	1/2	1/2	.47	1 1/4	2.250	4	.090	5
6168957	5VNE13005ET	—	—	—	—	1/2	1/2	.47	1 1/4	2.250	4	.120	5
—	—	6168959	5VNE13015AV	—	—	1/2	1/2	.47	5/8	.875	5	.015	5
—	—	6168960	5VNE13015BV	—	—	1/2	1/2	.47	5/8	.875	5	.030	5
—	—	6168961	5VNE13015CV	—	—	1/2	1/2	.47	5/8	.875	5	.060	5
—	—	6168962	5VNE13015EV	—	—	1/2	1/2	.47	5/8	.875	5	.120	5
—	—	6168958	5VNE13015SV	—	—	1/2	1/2	.47	5/8	.875	5	—	5
—	—	6168963	5VNE13025SV	—	—	1/2	1/2	.47	5/8	.875	6	—	5
6168950	5VNE130Z5AT	—	—	—	—	1/2	1/2	.47	5/8	1.375	3	.015	5
6168951	5VNE130Z5BT	—	—	—	—	1/2	1/2	.47	5/8	1.375	3	.030	5
6168952	5VNE130Z5CT	—	—	—	—	1/2	1/2	.47	5/8	1.375	3	.060	5
6168953	5VNE13005ST	—	—	—	—	1/2	1/2	.47	5/8	2.250	4	—	5
—	—	6168965	5VNE16016AV	—	—	5/8	5/8	.59	1 1/4	2.250	5	.015	5
—	—	5594901	5VNE16006BV	5594902	5VNE16006BW	5/8	5/8	.59	1 1/4	2.250	4	.030	5
—	—	6168966	5VNE16016BV	—	—	5/8	5/8	.59	1 1/4	2.250	5	.030	5
—	—	6168967	5VNE16016CV	—	—	5/8	5/8	.59	1 1/4	2.250	5	.060	5
—	—	6168968	5VNE16016EV	—	—	5/8	5/8	.59	1 1/4	2.250	5	.120	5
—	—	6168964	5VNE16016SV	—	—	5/8	5/8	.59	1 1/4	2.250	5	—	5
—	—	6168971	5VNE16026BV	—	—	5/8	5/8	.59	3/4	1.000	6	.030	5
—	—	6168972	5VNE16026CV	—	—	5/8	5/8	.59	3/4	1.000	6	.060	5
—	—	6168973	5VNE16026DV	—	—	5/8	5/8	.59	3/4	1.000	6	.090	5
—	—	6168974	5VNE16026EV	—	—	5/8	5/8	.59	3/4	1.000	6	.120	5
—	—	6168969	5VNE16026SV	—	—	5/8	5/8	.59	3/4	1.000	6	—	5
6168976	5VNE19007AT	—	—	—	—	3/4	3/4	.71	1	2.250	4	.015	5
6168977	5VNE19007BT	—	—	—	—	3/4	3/4	.71	1	2.250	4	.030	5
6168978	5VNE19007CT	—	—	—	—	3/4	3/4	.71	1	2.250	4	.060	5
6168979	5VNE19007ET	—	—	—	—	3/4	3/4	.71	1	2.250	4	.120	5
6168975	5VNE19007ST	—	—	—	—	3/4	3/4	.71	1	2.250	4	—	5
—	—	6168981	5VNE19027AV	—	—	3/4	3/4	.71	1 1/2	3.250	6	.015	5
—	—	5594903	5VNE19017BV	5594904	5VNE19017BW	3/4	3/4	.71	1 1/2	3.250	5 1/2	.030	5
—	—	6168982	5VNE19027BV	—	—	3/4	3/4	.71	1 1/2	3.250	6	.030	5

INDEXABLE MILLING

SOLID END MILLING

HOLEMAKING

TAPPING

TURNING

VariMill II ER • Series 5VNE • Square End • Eccentric Relief • Neck • 5 flute • Inch

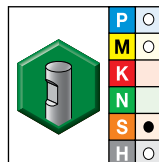
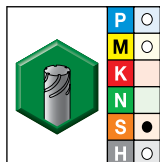
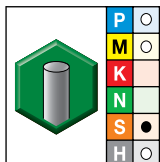
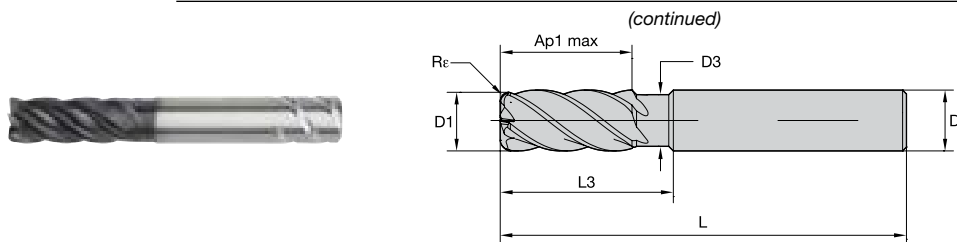

● first choice  
○ alternate choice

WS15PE		WS15PE		WS15PE				length of cut		length			
order #	catalog #	order #	catalog #	order #	catalog #	D1	D	D3	Ap1 max	L3	L	Re	ZU
—	—	6168983	5VNE19027CV	—	—	3/4	3/4	.71	1 1/2	3.250	6	.060	5
—	—	6168984	5VNE19027DV	—	—	3/4	3/4	.71	1 1/2	3.250	6	.090	5
—	—	6168985	5VNE19027EV	—	—	3/4	3/4	.71	1 1/2	3.250	6	.120	5
—	—	6168980	5VNE19027SV	—	—	3/4	3/4	.71	1 1/2	3.250	6	—	5
—	—	6168986	5VNE19037SV	—	—	3/4	3/4	.71	1 1/2	4.250	7	—	5
—	—	6169008	5VNE25048SV	—	—	1	1	.94	1 1/4	1.750	8	—	5
6168988	5VNE25008AT	—	—	—	—	1	1	.94	1 1/4	2.250	4	.015	5
6168989	5VNE25008BT	—	—	—	—	1	1	.94	1 1/4	2.250	4	.030	5
6168990	5VNE25008CT	—	—	—	—	1	1	.94	1 1/4	2.250	4	.060	5
6169001	5VNE25008DT	—	—	—	—	1	1	.94	1 1/4	2.250	4	.090	5
6169002	5VNE25008ET	—	—	—	—	1	1	.94	1 1/4	2.250	4	.120	5
6168987	5VNE25008ST	—	—	—	—	1	1	.94	1 1/4	2.250	4	—	5
—	—	6169004	5VNE25028AV	—	—	1	1	.94	1 1/4	3.250	6	.015	5
—	—	6169005	5VNE25028BV	—	—	1	1	.94	1 1/4	3.250	6	.030	5
—	—	6169006	5VNE25028CV	—	—	1	1	.94	1 1/4	3.250	6	.060	5
—	—	6169007	5VNE25028EV	—	—	1	1	.94	1 1/4	3.250	6	.120	5
—	—	6169003	5VNE25028SV	—	—	1	1	.94	1 1/4	3.250	6	—	5
—	—	5594905	5VNE25018BV	5594906	5VNE25018BW	1	1	.94	1 3/4	3.250	5 1/2	.030	5

INDEXABLE MILLING

SOLID END MILLING

HOLEMAKING

TAPPING

TURNING

## VariMill II Long • Series 5W1S • Square End • Long Length • 5 Flute • Inch

INDEXABLE MILLING

SOLID END MILLING

HOLEMAKING

TAPPING

TURNING

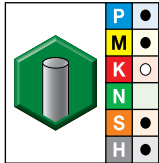
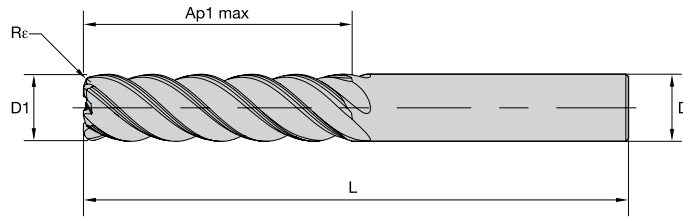

● first choice  
○ alternate choice

AITIN-MT

order #	catalog #	D1	D	length of cut Ap1 max	length L	Re	ZU
5095168	TM5W1S07002A	1/4	1/4	1	3	.015	5
5095169	TM5W1S07002B	1/4	1/4	1	3	.030	5
5095167	TM5W1S07002S	1/4	1/4	1	3	—	5
5095341	TM5W1S08003A	5/16	5/16	1 1/4	3	.015	5
5095342	TM5W1S08003B	5/16	5/16	1 1/4	3	.030	5
5095345	TM5W1S10004A	3/8	3/8	1 1/2	4	.015	5
5095346	TM5W1S10004B	3/8	3/8	1 1/2	4	.030	5
5095347	TM5W1S10004C	3/8	3/8	1 1/2	4	.060	5
5095343	TM5W1S10004S	3/8	3/8	1 1/2	4	—	5
5095420	TM5W1S13005A	1/2	1/2	2	5	.015	5
5095421	TM5W1S13005B	1/2	1/2	2	5	.030	5
5095422	TM5W1S13005C	1/2	1/2	2	5	.060	5
5095348	TM5W1S13005S	1/2	1/2	2	5	—	5
5095425	TM5W1S16006A	5/8	5/8	2 1/2	5 1/4	.015	5
5095426	TM5W1S16006B	5/8	5/8	2 1/2	5 1/4	.030	5
5095427	TM5W1S16006C	5/8	5/8	2 1/2	5 1/4	.060	5
5095533	TM5W1S16006D	5/8	5/8	2 1/2	5 1/4	.090	5
5095428	TM5W1S16006E	5/8	5/8	2 1/2	5 1/4	.120	5
5095423	TM5W1S16006S	5/8	5/8	2 1/2	5 1/4	—	5
5095471	TM5W6S19007A	3/4	3/4	3	6	.015	5
5095472	TM5W1S19007B	3/4	3/4	3	6	.030	5
5095473	TM5W1S19007C	3/4	3/4	3	6	.060	5
5095534	TM5W1S19007D	3/4	3/4	3	6	.090	5
5095474	TM5W1S19007E	3/4	3/4	3	6	.120	5
5095429	TM5W1S19007S	3/4	3/4	3	6	—	5
5095477	TM5W1S25008A	1	1	4	7	.015	5
5095530	TM5W1S25008B	1	1	4	7	.030	5
5095531	TM5W1S25008C	1	1	4	7	.060	5
5095532	TM5W1S25008E	1	1	4	7	.120	5
5095475	TM5W1S25008S	1	1	4	7	—	5

VariMill II • Series 5777 • Square End • Non-Center Cutting • 5 Flute • Metric

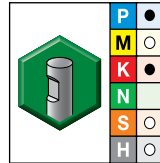
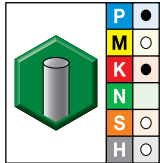
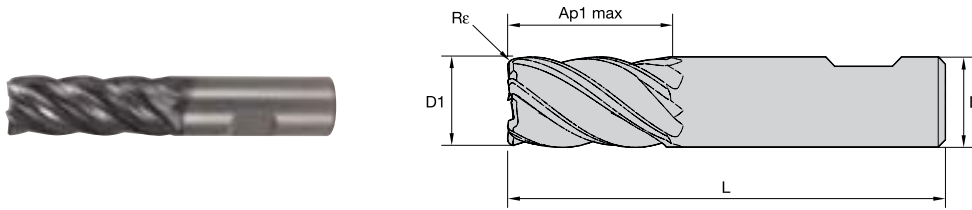

● first choice  
○ alternate choice

WP15PE		WP15PE		D1	D	length of cut Ap1 max	length L	Re	ZU
order #	catalog #	order #	catalog #						
3524587	577704002MT	—	—	4,0	6	11,00	55	0,25	5
3524586	577704012MT	—	—	4,0	6	11,00	55	—	5
3524588	577705002MT	—	—	5,0	6	13,00	57	0,25	5
6525049	577706002ET	—	—	6,0	6	13,00	57	0,50	5
6525050	577706002JT	—	—	6,0	6	13,00	57	1,00	5
3524590	577706002MT	—	—	6,0	6	13,00	57	0,40	5
3524589	577706012MT	—	—	6,0	6	13,00	57	—	5
6525181	577708003JT	—	—	8,0	8	19,00	63	1,00	5
6525182	577708003KT	—	—	8,0	8	19,00	63	1,50	5
3524593	577708003MT	—	—	8,0	8	19,00	63	0,50	5
3524592	577708013MT	—	—	8,0	8	19,00	63	—	5
6525183	577710004JT	—	—	10,0	10	22,00	72	1,00	5
6525184	577710004KT	—	—	10,0	10	22,00	72	1,50	5
3524596	577710004MT	—	—	10,0	10	22,00	72	0,50	5
3524595	577710014MT	—	—	10,0	10	22,00	72	—	5
3524598	577712005MT	—	—	12,0	12	26,00	83	0,75	5
6525185	577712015ET	—	—	12,0	12	26,00	73	0,50	5
6525186	577712015JT	—	—	12,0	12	26,00	73	1,00	5
6525187	577712015KT	—	—	12,0	12	26,00	73	1,50	5
3524597	577712015MT	—	—	12,0	12	26,00	83	—	5
6525188	577712015NT	—	—	12,0	12	26,00	73	2,50	5
6525189	577716006JT	—	—	16,0	16	32,00	92	1,00	5
3524601	577716006MT	3524620	577716006MW	16,0	16	32,00	92	0,75	5
6525190	577716006PT	—	—	16,0	16	32,00	92	3,00	5
6525201	577716006QT	—	—	16,0	16	32,00	92	4,00	5
3524600	577716016MT	—	—	16,0	16	32,00	92	—	5
3524605	577720007MT	—	—	20,0	20	38,00	104	0,75	5
6525202	577720007PT	—	—	20,0	20	38,00	104	3,00	5
3524603	577720017MT	—	—	20,0	20	38,00	104	—	5
3524606	577725008MT	—	—	25,0	25	45,00	121	0,75	5
6525203	577725008RT	—	—	25,0	25	45,00	121	5,00	5

INDEXABLE MILLING

SOLID END MILLING

HOLEMAKING

TAPPING

TURNING

## VariMill II • Series 577C • Square End • Center Cutting • 5 Flute • Metric

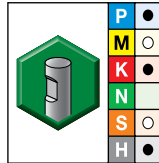
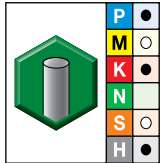
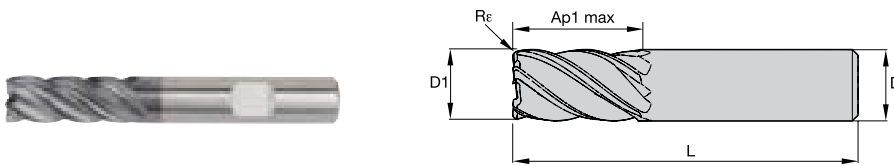

● first choice  
○ alternate choice

WP15PE		WP15PE		D1	D	length of cut Ap1 max	length L	Rε	ZU
5578866	577C04002T	5578867	577C04002W	4,0	6	11,00	55	0,25	5
5578868	577C04012T	—	—	4,0	6	11,00	55	—	5
5578990	577C05002T	5578991	577C05002W	5,0	6	13,00	57	0,25	5
6519448	577C050R2TE	—	—	5,0	6	13,00	57	0,50	5
5578992	577C06002T	5578993	577C06002W	6,0	6	13,00	57	0,40	5
5578994	577C06012T	—	—	6,0	6	13,00	57	—	5
6519449	577C060R2TE	—	—	6,0	6	13,00	57	0,50	5
6519450	577C060R2TJ	—	—	6,0	6	13,00	57	1,00	5
5578995	577C07003T	—	—	7,0	8	16,00	63	0,40	5
5578997	577C08003T	5578998	577C08003W	8,0	8	19,00	63	0,50	5
5578999	577C08013T	—	—	8,0	8	19,00	63	—	5
6519481	577C080R3TJ	—	—	8,0	8	19,00	63	1,00	5
6519482	577C080R3TK	—	—	8,0	8	19,00	63	1,50	5
5579021	577C09004T	—	—	9,0	10	19,00	72	0,50	5
5579023	577C10004T	5579024	577C10004W	10,0	10	22,00	72	0,50	5
5579025	577C10014T	—	—	10,0	10	22,00	72	—	5
6519483	577C100R4TJ	—	—	10,0	10	22,00	72	1,00	5
6519484	577C100R4TK	—	—	10,0	10	22,00	72	1,50	5
6519485	577C100R4TM	—	—	10,0	10	22,00	72	2,00	5
5579026	577C12005T	5579027	577C12005W	12,0	12	26,00	83	0,75	5
5579028	577C12015T	—	—	12,0	12	26,00	83	—	5
6519486	577C120R5TE	—	—	12,0	12	26,00	83	0,50	5
6519487	577C120R5TJ	—	—	12,0	12	26,00	83	1,00	5
6519488	577C120R5TK	—	—	12,0	12	26,00	83	1,50	5
6519489	577C120R5TM	—	—	12,0	12	26,00	83	2,00	5
6519490	577C120R5TN	—	—	12,0	12	26,00	83	2,50	5
6519491	577C120R5TP	—	—	12,0	12	26,00	83	3,00	5
5579029	577C14004T	5579040	577C14004W	14,0	14	26,00	83	0,75	5
5579041	577C14014T	—	—	14,0	14	26,00	83	—	5
5579042	577C16006T	5579043	577C16006W	16,0	16	32,00	92	0,75	5
5579044	577C16016T	—	—	16,0	16	32,00	92	—	5
6519492	577C160R6TE	—	—	16,0	16	32,00	92	0,50	5
6519493	577C160R6TJ	—	—	16,0	16	32,00	92	1,00	5
6519497	577C160R6TM	—	—	16,0	16	32,00	92	2,00	5
6519499	577C160R6TP	—	—	16,0	16	32,00	92	3,00	5
6519500	577C160R6TQ	—	—	16,0	16	32,00	92	4,00	5
5579045	577C18008T	—	—	18,0	18	32,00	92	0,75	5
5579047	577C20007T	5579048	577C20007W	20,0	20	38,00	104	0,75	5
5579049	577C20017T	—	—	20,0	20	38,00	104	—	5
6519501	577C200R7TJ	—	—	20,0	20	38,00	104	1,00	5
6519502	577C200R7TM	—	—	20,0	20	38,00	104	2,00	5
6519503	577C200R7TP	—	—	20,0	20	38,00	104	3,00	5
6519504	577C200R7TQ	—	—	20,0	20	38,00	104	4,00	5
6519505	577C200R7TR	—	—	20,0	20	38,00	104	5,00	5
5579060	577C25008T	5579061	577C25008W	25,0	25	45,00	121	0,75	5
6519506	577C250R8TM	—	—	25,0	25	45,00	121	2,00	5
6519507	577C250R8TP	—	—	25,0	25	45,00	121	3,00	5
6519508	577C250R8TQ	—	—	25,0	25	45,00	121	4,00	5
6519509	577C250R8TR	—	—	25,0	25	45,00	121	5,00	5

INDEXABLE MILLING

SOLID END MILLING

HOLEMAKING

TAPPING

TURNING

VariMill II • Series 57N8 • Square End • Non-Center Cutting • Neck • 5 Flute • Metric

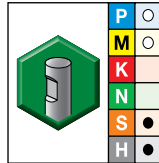
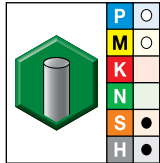
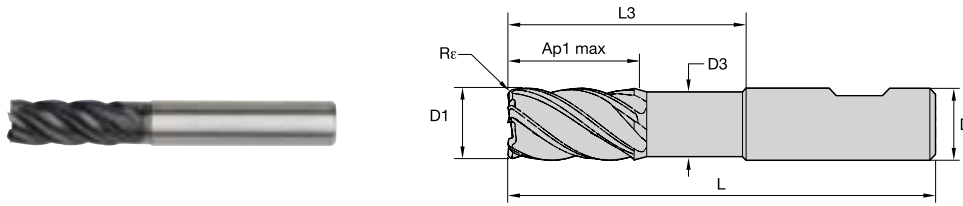

- first choice
- alternate choice

WS15PE		WS15PE		D1	D	D3	length of cut		length		R <sub>e</sub>	ZU
order #	catalog #	order #	catalog #				Ap1 max	L3	L			
3524626	57N806002MT	—	—	6,0	6	5,60	13,00	18,00	63	—	5	
3524627	57N806022MT	—	—	6,0	6	5,60	13,00	18,00	63	0,50	5	
6492821	57N8060R2MTG	—	—	6,0	6	5,64	13,00	18,00	63	0,75	5	
3524629	57N808003MT	—	—	8,0	8	7,50	19,00	24,00	76	—	5	
3524631	57N808023MT	—	—	8,0	8	7,50	19,00	24,00	76	0,50	5	
6492822	57N8080R3MTG	—	—	8,0	8	7,52	19,00	24,00	76	0,75	5	
6492825	57N8080R3MTK	—	—	8,0	8	7,52	19,00	24,00	76	1,50	5	
3524632	57N810004MT	—	—	10,0	10	9,40	22,00	30,00	76	—	5	
3524643	57N810024MT	—	—	10,0	10	9,40	22,00	30,00	76	0,50	5	
3524644	57N810034MT	—	—	10,0	10	9,40	22,00	30,00	76	1,00	5	
3524645	57N810054MT	—	—	10,0	10	9,40	22,00	30,00	76	2,00	5	
6492823	57N8100R4MTG	—	—	10,0	10	9,40	22,00	30,00	76	0,75	5	
6492826	57N8100R4MTK	—	—	10,0	10	9,40	22,00	30,00	76	1,50	5	
3524647	57N812025MT	—	—	12,0	12	11,28	26,00	36,00	83	0,50	5	
3524648	57N812035MT	—	—	12,0	12	11,28	26,00	36,00	83	1,00	5	
3524649	57N812055MT	—	—	12,0	12	11,28	26,00	36,00	83	2,00	5	
6492827	57N8120R5MTK	—	—	12,0	12	11,28	26,00	36,00	83	1,50	5	
6492829	57N8120R5MTN	—	—	12,0	12	11,28	26,00	36,00	83	2,50	5	
6492830	57N8120R5MTP	—	—	12,0	12	11,28	26,00	36,00	83	3,00	5	
3524650	57N816006MT	—	—	16,0	16	15,05	32,00	48,00	100	—	5	
3524651	57N816026MT	3562867	57N816026MW	16,0	16	15,05	32,00	48,00	100	0,50	5	
3524652	57N816036MT	—	—	16,0	16	15,05	32,00	48,00	100	1,00	5	
3524654	57N816076MT	3524692	57N816076MW	16,0	16	15,05	32,00	48,00	100	3,00	5	
6492832	57N8160R6MTQ	—	—	16,0	16	15,04	32,00	48,00	100	4,00	5	
—	—	3524693	57N820027MW	20,0	20	18,80	38,00	60,00	115	0,50	5	
6492824	57N8200R7MTJ	—	—	20,0	20	18,80	38,00	60,00	115	1,00	5	
6492833	57N8200R7MTR	—	—	20,0	20	18,80	38,00	60,00	115	5,00	5	
6492831	57N8250R8MTP	—	—	25,0	25	23,50	45,00	75,00	135	3,00	5	
6492834	57N8250R8MTR	—	—	25,0	25	23,50	45,00	75,00	135	5,00	5	

INDEXABLE MILLING

SOLID END MILLING

HOLEMAKING

TAPPING

TURNING



## VariMill II • Series 57NC • Square End • Center Cutting • Neck • 5 Flute • Metric

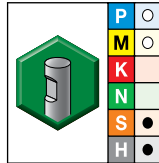
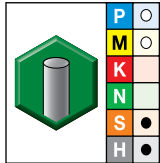
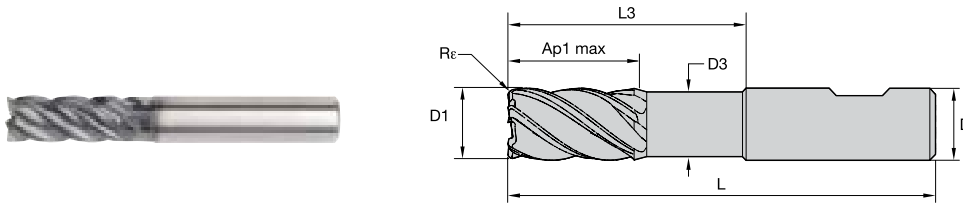

● first choice  
○ alternate choice

WS15PE		WS15PE		D1	D	D3	length of cut Ap1 max	L3	length L	Re	ZU
5598906	57NC06002T	—	—	6,0	6	5,64	13,00	18,00	63	—	5
5598907	57NC06022T	—	—	6,0	6	5,64	13,00	18,00	63	0,50	5
5598909	57NC06032T	—	—	6,0	6	5,64	13,00	18,00	63	1,00	5
—	—	5599071	57NC06042W	6,0	6	5,64	13,00	18,00	63	1,50	5
6569491	57NC060R2TK	—	—	6,0	6	5,64	13,00	17,82	63	1,50	5
5599072	57NC08003T	—	—	8,0	8	7,52	19,00	24,00	76	—	5
5599073	57NC08023T	5599074	57NC08023W	8,0	8	7,52	19,00	24,00	76	0,50	5
5599075	57NC08033T	5599076	57NC08033W	8,0	8	7,52	19,00	24,00	76	1,00	5
6569493	57NC080R3TM	5599077	57NC08053W	8,0	8	7,52	19,00	24,00	76	2,00	5
6569492	57NC080R3TK	—	—	8,0	8	7,52	19,00	24,00	76	1,50	5
5599078	57NC10004T	—	—	10,0	10	9,40	22,00	30,00	76	—	5
5599079	57NC10024T	5599080	57NC10024W	10,0	10	9,40	22,00	30,00	76	0,50	5
5599081	57NC10034T	5599082	57NC10034W	10,0	10	9,40	22,00	30,00	76	1,00	5
5599083	57NC10054T	—	—	10,0	10	9,40	22,00	30,00	76	2,00	5
6569494	57NC100R4TK	—	—	10,0	10	9,40	22,00	30,00	76	1,50	5
5599085	57NC12005T	—	—	12,0	12	11,28	26,00	36,00	83	—	5
5599086	57NC12025T	5599087	57NC12025W	12,0	12	11,28	26,00	36,00	83	0,50	5
5599088	57NC12035T	—	—	12,0	12	11,28	26,00	36,00	83	1,00	5
5599090	57NC12055T	5599091	57NC12055W	12,0	12	11,28	26,00	36,00	83	2,00	5
6569495	57NC120R5TK	—	—	12,0	12	11,28	26,00	36,00	83	1,50	5
6569496	57NC120R5TP	—	—	12,0	12	11,28	26,00	36,00	83	3,00	5
5599092	57NC16006T	—	—	16,0	16	15,04	32,00	48,00	100	—	5
5599093	57NC16026T	5598905	57NC16026W	16,0	16	15,04	32,00	48,00	100	0,50	5
5599094	57NC16036T	5599095	57NC16036W	16,0	16	15,04	32,00	48,00	100	1,00	5
5599096	57NC16056T	—	—	16,0	16	15,04	32,00	48,00	100	2,00	5
5599098	57NC16076T	5599099	57NC16076W	16,0	16	15,04	32,00	48,00	100	3,00	5
6569497	57NC160R6TQ	—	—	16,0	16	15,04	32,00	48,00	100	4,00	5
5599100	57NC20007T	—	—	20,0	20	18,80	38,00	60,00	115	—	5
5599101	57NC20027T	5599102	57NC20027W	20,0	20	18,80	38,00	60,00	115	0,50	5
5599103	57NC20037T	5599104	57NC20037W	20,0	20	18,80	38,00	60,00	115	1,00	5
5599105	57NC20057T	—	—	20,0	20	18,80	38,00	60,00	115	2,00	5
5599107	57NC20077T	5599108	57NC20077W	20,0	20	18,80	38,00	60,00	115	3,00	5
5599109	57NC20087T	—	—	20,0	20	18,80	38,00	60,00	115	4,00	5
6569498	57NC200R7TR	—	—	20,0	20	18,80	38,00	60,00	115	5,00	5
5599111	57NC25008T	—	—	25,0	25	23,50	45,00	75,00	135	—	5
5599112	57NC25028T	—	—	25,0	25	23,50	45,00	75,00	135	0,50	5
5599114	57NC25038T	5599115	57NC25038W	25,0	25	23,50	45,00	75,00	135	1,00	5
5599116	57NC25058T	—	—	25,0	25	23,50	45,00	75,00	135	2,00	5
5599118	57NC25078T	—	—	25,0	25	23,50	45,00	75,00	135	3,00	5
5599120	57NC25088T	—	—	25,0	25	23,50	45,00	75,00	135	4,00	5

INDEXABLE MILLING

SOLID END MILLING

HOLEMAKING

TAPPING

TURNING

VariMill II ER • Series 577E • Square End • Eccentric Relief • 5 Flute • Metric

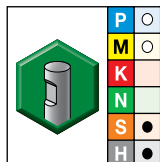
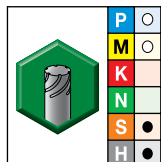
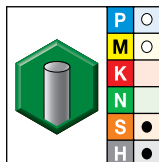
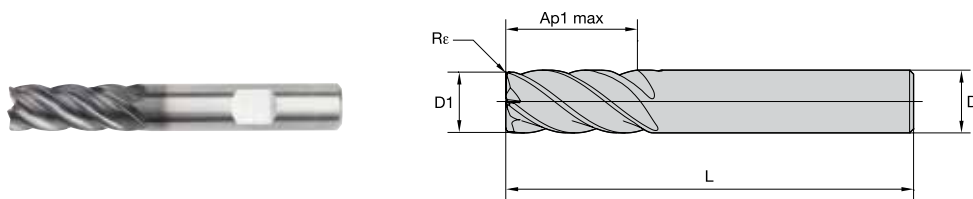

● first choice  
○ alternate choice

WS15PE		WS15PE		WS15PE		D1	D	length of cut Ap1 max	length L	Re	ZU
order #	catalog #	order #	catalog #	order #	catalog #						
5599171	577E10004T	-	-	5599176	577E12015W	10,0	10	22,00	72	-	5
-	-	5599177	577E16006V	-	-	12,0	12	26,00	83	0,75	5
-	-	5599178	577E16016V	5599179	577E16016W	16,0	16	32,00	92	-	5
-	-	5599180	577E20007V	-	-	16,0	16	32,00	92	0,75	5
-	-	5599181	577E20017V	5599182	577E20017W	20,0	20	38,00	104	-	5
-	-	5599183	577E25018V	-	-	20,0	20	38,00	104	0,75	5
-	-	-	-	-	-	25,0	25	45,00	121	0,75	5

INDEXABLE MILLING

SOLID END MILLING

HOLEMAKING

TAPPING

TURNING

## VariMill II ER • Series 57NE • Square End • Eccentric Relief • Neck • 5 Flute • Metric

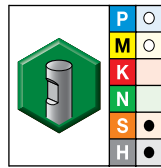
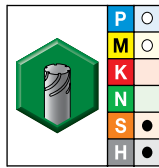
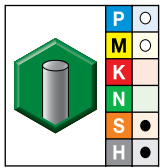
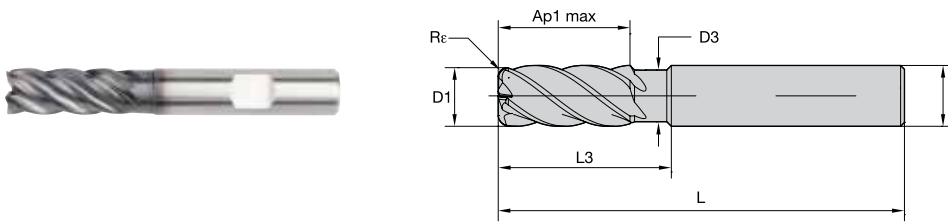

- first choice
- alternate choice

WS15PE		WS15PE		WS15PE		D1	D	D3	length of cut Ap1 max	L3	length L	Re	ZU
order #	catalog #	order #	catalog #	order #	catalog #								
5599122	57NE10004T	—	—	—	—	10,0	10	9,40	22,00	30,00	76	—	5
5599123	57NE10024T	—	—	5599124	57NE10024W	10,0	10	9,40	22,00	30,00	76	0,50	5
5599125	57NE10034T	—	—	5599126	57NE10034W	10,0	10	9,40	22,00	30,00	76	1,00	5
5599127	57NE10054T	—	—	5599128	57NE10054W	10,0	10	9,40	22,00	30,00	76	2,00	5
—	—	5599129	57NE12005V	—	—	12,0	12	11,28	26,00	36,00	83	—	5
—	—	5599130	57NE12025V	5599131	57NE12025W	12,0	12	11,28	26,00	36,00	83	0,50	5
—	—	5599132	57NE12035V	5599133	57NE12035W	12,0	12	11,28	26,00	36,00	83	1,00	5
—	—	5599134	57NE12055V	5599135	57NE12055W	12,0	12	11,28	26,00	36,00	83	2,00	5
—	—	5599136	57NE16006V	—	—	16,0	16	15,04	32,00	48,00	100	—	5
—	—	5599137	57NE16026V	5599138	57NE16026W	16,0	16	15,04	32,00	48,00	100	0,50	5
—	—	5599139	57NE16036V	5599140	57NE16036W	16,0	16	15,04	32,00	48,00	100	1,00	5
—	—	5599141	57NE16056V	5599142	57NE16056W	16,0	16	15,04	32,00	48,00	100	2,00	5
—	—	5599143	57NE20007V	—	—	20,0	20	18,80	38,00	60,00	115	—	5
—	—	5599144	57NE20027V	5599145	57NE20027W	20,0	20	18,80	38,00	60,00	115	0,50	5
—	—	5599146	57NE20037V	5599147	57NE20037W	20,0	20	18,80	38,00	60,00	115	1,00	5
—	—	5599148	57NE20057V	5599149	57NE20057W	20,0	20	18,80	38,00	60,00	115	2,00	5
—	—	5599160	57NE20087V	5599161	57NE20087W	20,0	20	18,80	38,00	60,00	115	4,00	5
—	—	5599162	57NE25008V	—	—	25,0	25	23,50	45,00	75,00	135	—	5
—	—	5599163	57NE25028V	—	—	25,0	25	23,50	45,00	75,00	135	0,50	5
—	—	5599165	57NE25038V	—	—	25,0	25	23,50	45,00	75,00	135	1,00	5
—	—	5599167	57NE25058V	—	—	25,0	25	23,50	45,00	75,00	135	2,00	5
—	—	5599169	57NE25088V	—	—	25,0	25	23,50	45,00	75,00	135	4,00	5

INDEXABLE MILLING

SOLID END MILLING

HOLEMAKING

TAPPING

TURNING

VariMill II Long • Series 5718 • Square End • Long Length • 5 Flute • Metric

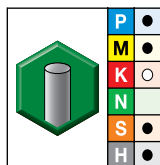
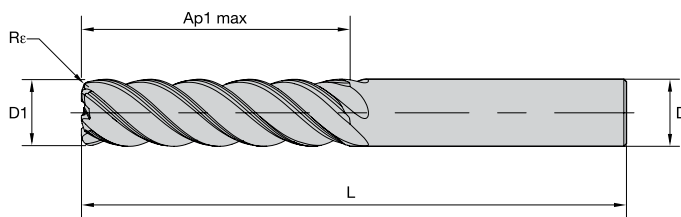

● first choice  
○ alternate choice

AITN-MT

order #	catalog #	D1	D	length of cut Ap1 max	length L	Re	Z U
571806002MT		6,0	6	24,00	76	—	5
571806012MT		6,0	6	24,00	76	0,50	5
571806022MT		6,0	6	24,00	76	1,00	5
571808003MT		8,0	8	32,00	76	—	5
571808013MT		8,0	8	32,00	76	0,50	5
571808023MT		8,0	8	32,00	76	1,00	5
571810004MT		10,0	10	40,00	100	—	5
571810014MT		10,0	10	40,00	100	0,50	5
571810034MT		10,0	10	40,00	100	2,00	5
571810044MT		10,0	10	40,00	100	2,50	5
571812005MT		12,0	12	48,00	125	—	5
571812015MT		12,0	12	48,00	125	0,50	5
571812025MT		12,0	12	48,00	125	1,00	5
571812035MT		12,0	12	48,00	125	2,00	5
571812045MT		12,0	12	48,00	125	2,50	5
571814014MT		14,0	14	56,00	120	—	5
571814024MT		14,0	14	56,00	120	1,00	5
571814054MT		14,0	14	56,00	120	4,00	5
571816006MT		16,0	16	64,00	141	—	5
571816016MT		16,0	16	64,00	141	0,50	5
571816026MT		16,0	16	64,00	141	1,00	5
571816036MT		16,0	16	64,00	141	2,00	5
571816046MT		16,0	16	64,00	141	3,00	5
571816056MT		16,0	16	64,00	141	4,00	5
571818018MT		18,0	18	72,00	150	—	5
571820007MT		20,0	20	80,00	150	—	5
571820017MT		20,0	20	80,00	150	0,50	5
571820027MT		20,0	20	80,00	150	1,00	5
571820037MT		20,0	20	80,00	150	2,00	5
571820047MT		20,0	20	80,00	150	3,00	5
571820057MT		20,0	20	80,00	150	4,00	5
571825008MT		25,0	25	100,00	170	—	5
571825018MT		25,0	25	100,00	170	0,50	5
571825028MT		25,0	25	100,00	170	1,00	5
571825038MT		25,0	25	100,00	170	2,00	5
571825048MT		25,0	25	100,00	170	3,00	5

INDEXABLE MILLING

SOLID END MILLING

HOLEMAKING

TAPPING

TURNING

VariMill II • Series 5V0C • Application Data • WP15PE • Inch

INDEXABLE MILLING

SOLID END MILLING

HOLEMAKING

TAPPING

TURNING

Material Group	Side Milling (A) and Slotting (B)			WP15PE			Recommended feed per tooth (IPT = inch/th) for side milling (A). For slotting (B), reduce IPT by 20%.										
	A		B	Cutting Speed – vc SFM			frac. dec.	D1 – Diameter									
	ap	ae	ap	min	–	max		3/16	1/4	5/16	3/8	1/2	5/8	3/4	1	1 1/4	
								0.1875	0.2500	0.3125	0.3750	0.5000	0.6250	0.7500	1.0000	1.2500	
P	0	1.5 x D	0.5 x D	1 x D	490	–	660	IPT	0.0013	0.0018	0.0023	0.0027	0.0034	0.0039	0.0044	0.0049	0.0049
	1	1.5 x D	0.5 x D	1 x D	490	–	660	IPT	0.0013	0.0018	0.0023	0.0027	0.0034	0.0039	0.0044	0.0049	0.0049
	2	1.5 x D	0.5 x D	1 x D	460	–	620	IPT	0.0013	0.0018	0.0023	0.0027	0.0034	0.0039	0.0044	0.0049	0.0049
	3	1.5 x D	0.5 x D	1 x D	390	–	520	IPT	0.0011	0.0015	0.0020	0.0023	0.0029	0.0034	0.0039	0.0045	0.0048
	4	1.5 x D	0.5 x D	0.75 x D	300	–	490	IPT	0.0010	0.0014	0.0017	0.0020	0.0026	0.0030	0.0034	0.0039	0.0040
	5	1.5 x D	0.5 x D	1 x D	200	–	330	IPT	0.0009	0.0012	0.0016	0.0018	0.0023	0.0027	0.0031	0.0036	0.0039
M	6	1.5 x D	0.5 x D	0.75 x D	160	–	250	IPT	0.0008	0.0010	0.0013	0.0015	0.0019	0.0022	0.0025	0.0028	0.0029
	1	1.5 x D	0.5 x D	1 x D	300	–	380	IPT	0.0011	0.0015	0.0020	0.0023	0.0029	0.0034	0.0039	0.0045	0.0048
	2	1.5 x D	0.5 x D	1 x D	200	–	260	IPT	0.0009	0.0012	0.0016	0.0018	0.0023	0.0027	0.0031	0.0036	0.0039
K	3	1.5 x D	0.5 x D	1 x D	200	–	230	IPT	0.0008	0.0010	0.0013	0.0015	0.0019	0.0022	0.0025	0.0028	0.0029
	1	1.5 x D	0.5 x D	1 x D	390	–	490	IPT	0.0013	0.0018	0.0023	0.0027	0.0034	0.0039	0.0044	0.0049	0.0049
	2	1.5 x D	0.5 x D	1 x D	360	–	460	IPT	0.0011	0.0015	0.0020	0.0023	0.0029	0.0034	0.0039	0.0045	0.0048
S	3	1.5 x D	0.5 x D	1 x D	360	–	430	IPT	0.0009	0.0012	0.0016	0.0018	0.0023	0.0027	0.0031	0.0036	0.0039
	1	1.5 x D	0.3 x D	0.3 x D	160	–	300	IPT	0.0011	0.0015	0.0020	0.0023	0.0029	0.0034	0.0039	0.0045	0.0048
	2	1.5 x D	0.3 x D	0.3 x D	80	–	130	IPT	0.0006	0.0008	0.0010	0.0012	0.0015	0.0018	0.0021	0.0024	0.0026
	3	1.5 x D	0.5 x D	1 x D	80	–	130	IPT	0.0006	0.0008	0.0010	0.0012	0.0015	0.0018	0.0021	0.0024	0.0026
H	4	1.5 x D	0.5 x D	1 x D	160	–	200	IPT	0.0008	0.0011	0.0014	0.0017	0.0021	0.0025	0.0028	0.0033	0.0036
	1	1.5 x D	0.5 x D	0.75 x D	260	–	460	IPT	0.0010	0.0014	0.0017	0.0020	0.0026	0.0030	0.0034	0.0039	0.0040
	2	1.5 x D	0.2 x D	0.5 x D	230	–	390	IPT	0.0008	0.0010	0.0013	0.0015	0.0019	0.0022	0.0025	0.0028	0.0029

NOTE: Lower value of cutting speed is used for high stock removal applications or for higher hardness (machinability) within group.  
 Higher value of cutting speed is used for finishing applications or for lower hardness (machinability) within group.  
 Above parameters are based on ideal conditions. For smaller taper machining centers, please adjust parameters accordingly on >1/2" diameter.

VariMill II • Series 5VNC • Application Data • WP15PE • Inch

Material Group	Side Milling (A) and Slotting (B)			WP15PE			Recommended feed per tooth (IPT = inch/th) for side milling (A). For slotting (B), reduce IPT by 20%.										
	A		B	Cutting Speed – vc SFM			frac. dec.	D1 – Diameter									
	ap	ae	ap	min	–	max		1/4	5/16	3/8	1/2	5/8	3/4	1			
								.2500	.3125	.3750	.5000	.6250	.7500	1.0000			
P	5	1.5 x D	0.5 x D	1 x D	200	–	330	IPT	0.0012	0.0016	0.0018	0.0023	0.0027	0.0031	0.0036		
	6	1.5 x D	0.5 x D	0.75 x D	160	–	250	IPT	0.0010	0.0013	0.0015	0.0019	0.0022	0.0025	0.0028		
M	1	1.5 x D	0.5 x D	1 x D	300	–	380	IPT	0.0015	0.0020	0.0023	0.0029	0.0034	0.0039	0.0045		
	2	1.5 x D	0.5 x D	1 x D	200	–	260	IPT	0.0012	0.0016	0.0018	0.0023	0.0027	0.0031	0.0036		
	3	1.5 x D	0.5 x D	1 x D	200	–	230	IPT	0.0010	0.0013	0.0015	0.0019	0.0022	0.0025	0.0028		
K	1	1.5 x D	0.5 x D	1 x D	390	–	490	IPT	0.0018	0.0023	0.0027	0.0034	0.0039	0.0044	0.0049		
	2	1.5 x D	0.5 x D	1 x D	360	–	460	IPT	0.0015	0.0020	0.0023	0.0029	0.0034	0.0039	0.0045		
	3	1.5 x D	0.5 x D	1 x D	360	–	430	IPT	0.0012	0.0016	0.0018	0.0023	0.0027	0.0031	0.0036		
S	1	1.5 x D	0.3 x D	0.3 x D	160	–	300	IPT	0.0015	0.0020	0.0023	0.0029	0.0034	0.0039	0.0045		
	2	1.5 x D	0.3 x D	0.3 x D	80	–	130	IPT	0.0008	0.0010	0.0012	0.0015	0.0018	0.0021	0.0024		
	3	1.5 x D	0.5 x D	1 x D	80	–	130	IPT	0.0008	0.0010	0.0012	0.0015	0.0018	0.0021	0.0024		
	4	1.5 x D	0.5 x D	1 x D	160	–	200	IPT	0.0011	0.0014	0.0017	0.0021	0.0025	0.0028	0.0033		
H	1	1.5 x D	0.5 x D	0.75 x D	260	–	460	IPT	0.0014	0.0017	0.0020	0.0026	0.0030	0.0034	0.0039		
	2	1.5 x D	0.2 x D	0.5 x D	230	–	390	IPT	0.0010	0.0013	0.0015	0.0019	0.0022	0.0025	0.0028		

NOTE: Lower value of cutting speed is used for high stock removal applications or for higher hardness (machinability) within group.  
 Higher value of cutting speed is used for finishing applications or for lower hardness (machinability) within group.  
 Above parameters are based on ideal conditions. For smaller taper machining centers, please adjust parameters accordingly on >1/2" diameter.

VariMill II • Series 5V0S • Application Data • WP15PE • Inch

Material Group																		
	A		B		WP15PE			Recommended feed per tooth (IPT=inch/th) for side milling (A). For slotting (B), reduce IPT by 20%.										
					Cutting Speed – vc SFM			D1 – Diameter										
	ap	ae	ap	min	max	frac. dec.	3/16	1/4	5/16	3/8	7/16	1/2	5/8	3/4	1			
P	1	1.25 x D	0.5 x D	1 x D	490	–	660	IPT	.0014	.0018	.0023	.0027	.0031	.0035	.0039	.0043	.0050	
	2	1.25 x D	0.5 x D	1 x D	460	–	620	IPT	.0014	.0018	.0023	.0027	.0031	.0035	.0039	.0043	.0050	
	3	1.25 x D	0.5 x D	1 x D	390	–	520	IPT	.0011	.0015	.0020	.0023	.0026	.0029	.0034	.0038	.0046	
	4	1.25 x D	0.5 x D	0.75 x D	300	–	490	IPT	.0010	.0014	.0018	.0020	.0023	.0026	.0030	.0033	.0039	
	5	1.25 x D	0.5 x D	1 x D	200	–	330	IPT	.0009	.0012	.0016	.0018	.0021	.0023	.0027	.0030	.0036	
	6	1.25 x D	0.5 x D	0.75 x D	160	–	250	IPT	.0008	.0010	.0013	.0015	.0017	.0019	.0022	.0024	.0028	
M	1	1.25 x D	0.5 x D	1 x D	260	–	330	IPT	.0011	.0015	.0020	.0023	.0026	.0029	.0034	.0038	.0046	
	2	1.25 x D	0.5 x D	1 x D	200	–	260	IPT	.0009	.0012	.0016	.0018	.0021	.0023	.0027	.0030	.0036	
	3	1.25 x D	0.5 x D	1 x D	200	–	260	IPT	.0008	.0010	.0013	.0015	.0017	.0019	.0022	.0024	.0028	
K	1	1.25 x D	0.5 x D	1 x D	390	–	520	IPT	.0014	.0018	.0023	.0027	.0031	.0035	.0039	.0043	.0050	
	2	1.25 x D	0.5 x D	1 x D	360	–	460	IPT	.0011	.0015	.0020	.0023	.0026	.0029	.0034	.0038	.0046	
	3	1.25 x D	0.5 x D	1 x D	330	–	430	IPT	.0009	.0012	.0016	.0018	.0021	.0023	.0027	.0030	.0036	
S	1	1.0 x D	0.3 x D	0.3 x D	160	–	300	IPT	.0011	.0015	.0020	.0023	.0026	.0029	.0034	.0039	.0045	
	2	1.0 x D	0.3 x D	0.3 x D	80	–	130	IPT	.0006	.0008	.0010	.0012	.0014	.0015	.0018	.0021	.0024	
	3	1.25 x D	0.5 x D	1 x D	80	–	130	IPT	.0006	.0008	.0010	.0012	.0014	.0015	.0018	.0021	.0024	
	4	1.25 x D	0.5 x D	1 x D	160	–	200	IPT	.0008	.0011	.0014	.0017	.0019	.0021	.0025	.0028	.0033	
H	1	1.25 x D	0.5 x D	0.75 x D	260	–	460	IPT	.0010	.0014	.0018	.0020	.0023	.0026	.0030	.0033	.0039	

NOTE: Lower value of cutting speed is used for high-stock removal applications or for higher hardness (machinability) within group.  
Higher value of cutting speed is used for finishing applications or for lower hardness (machinability) within group.  
Above parameters are based on ideal conditions. For smaller taper machining centers, please adjust parameters accordingly on > 1/2" diameter.

VariMill II • Series 5VNS • Application Data • ALTIN-MT • Inch

Material Group																		
	A		B		AITiN			Recommended feed per tooth (IPT=inch/th) for side milling (A). For slotting (B), reduce IPT by 20%.										
					Cutting Speed – vc SFM			D1 – Diameter										
	ap	ae	ap	min	max	frac. dec.	1/4	3/8	1/2	5/8	3/4	1						
P	1	0.75 x D	0.5 x D	0.75 x D	490	–	660	IPT	.0018	.0027	.0035	.0039	.0043	.0050				
	2	0.75 x D	0.5 x D	0.75 x D	460	–	620	IPT	.0018	.0027	.0035	.0039	.0043	.0050				
	3	0.75 x D	0.5 x D	0.75 x D	390	–	520	IPT	0.0015	.0023	.0029	.0034	.0038	.0046				
	4	0.75 x D	0.5 x D	0.5 x D	300	–	490	IPT	0.0014	.0020	.0026	.0030	.0033	.0039				
	5	0.75 x D	0.5 x D	0.75 x D	200	–	330	IPT	.0012	.0018	.0023	.0027	.0030	.0036				
	6	0.75 x D	0.5 x D	0.5 x D	160	–	250	IPT	.0010	.0015	.0019	.0022	.0024	.0028				
M	1	0.75 x D	0.5 x D	0.75 x D	260	–	330	IPT	.0015	.0023	.0029	.0034	.0038	.0046				
	2	0.75 x D	0.5 x D	0.75 x D	200	–	260	IPT	.0012	.0018	.0023	.0027	.0030	.0036				
	3	0.75 x D	0.5 x D	0.75 x D	200	–	260	IPT	.0010	.0015	.0019	.0022	.0024	.0028				
K	1	0.75 x D	0.5 x D	0.75 x D	390	–	520	IPT	.0018	.0027	.0035	.0039	.0043	.0050				
	2	0.75 x D	0.5 x D	0.75 x D	360	–	460	IPT	.0015	.0023	.0029	.0034	.0038	.0046				
	3	0.75 x D	0.5 x D	0.75 x D	330	–	430	IPT	.0012	.0018	.0023	.0027	.0030	.0036				
S	1	0.75 x D	0.3 x D	0.3 x D	160	–	300	IPT	.0015	.0023	.0029	.0034	.0039	.0045				
	2	0.75 x D	0.3 x D	0.3 x D	80	–	130	IPT	.0008	.0012	.0015	.0018	.0021	.0024				
	3	0.75 x D	0.5 x D	0.75 x D	80	–	130	IPT	.0008	.0012	.0015	.0018	.0021	.0024				
	4	0.75 x D	0.5 x D	0.75 x D	160	–	200	IPT	.0011	.0017	.0021	.0025	.0028	.0033				
H	1	0.75 x D	0.5 x D	0.5 x D	260	–	460	IPT	.0014	.0020	.0026	.0030	.0033	.0039				

NOTE: Lower value of cutting speed is used for high-stock removal applications or for higher hardness (machinability) within group.  
Higher value of cutting speed is used for finishing applications or for lower hardness (machinability) within group.  
Above parameters are based on ideal conditions. For smaller taper machining centers, please adjust accordingly on > 1/2" diameter.

VariMill II ER • Series 5VOE • Application Data • WS15PE • Inch

Material Group	Side Milling (A) and Slotting (B)			WS15PE		Recommended feed per tooth (IPT = inch/th) for side milling (A). For slotting (B), reduce IPT by 20%.										
	A		B	Cutting Speed – vc SFM			D1 – Diameter									
	ap	ae	ap	min	max	frac. dec.	3/16	1/4	3/8	1/2	5/8	3/4	1	1 1/4		
							.1875	.2500	.3750	.5000	.6250	.7500	1.0000	1.2500		
P	4	1.5 x D	0.5 x D	0.75 x D	300	–	490	IPT	0.0010	0.0014	0.0020	0.0026	0.0030	0.0034	0.0039	0.0040
	5	1.5 x D	0.5 x D	1 x D	200	–	330	IPT	0.0009	0.0012	0.0018	0.0023	0.0027	0.0031	0.0036	0.0039
	6	1.5 x D	0.5 x D	0.75 x D	160	–	250	IPT	0.0008	0.0010	0.0015	0.0019	0.0022	0.0025	0.0028	0.0029
M	1	1.5 x D	0.5 x D	1 x D	300	–	380	IPT	0.0011	0.0015	0.0023	0.0029	0.0034	0.0039	0.0045	0.0048
	2	1.5 x D	0.5 x D	1 x D	200	–	260	IPT	0.0009	0.0012	0.0018	0.0023	0.0027	0.0031	0.0036	0.0039
	3	1.5 x D	0.5 x D	1 x D	200	–	230	IPT	0.0008	0.0010	0.0015	0.0019	0.0022	0.0025	0.0028	0.0029
S	1	1.5 x D	0.3 x D	0.3 x D	160	–	300	IPT	0.0011	0.0015	0.0023	0.0029	0.0034	0.0039	0.0045	0.0048
	2	1.5 x D	0.3 x D	0.3 x D	80	–	130	IPT	0.0006	0.0008	0.0012	0.0015	0.0018	0.0021	0.0024	0.0026
	3	1.5 x D	0.5 x D	1 x D	80	–	130	IPT	0.0006	0.0008	0.0012	0.0015	0.0018	0.0021	0.0024	0.0026
	4	1.5 x D	0.5 x D	1 x D	160	–	200	IPT	0.0008	0.0011	0.0017	0.0021	0.0025	0.0028	0.0033	0.0036
H	1	1.5 x D	0.5 x D	0.75 x D	260	–	460	IPT	0.0010	0.0014	0.0020	0.0026	0.0030	0.0034	0.0039	0.0040
	2	1.5 x D	0.2 x D	0.5 x D	230	–	390	IPT	0.0008	0.0010	0.0015	0.0019	0.0022	0.0025	0.0028	0.0029

NOTE: Lower value of cutting speed is used for high stock removal applications or for higher hardness (machinability) within group.  
 Higher value of cutting speed is used for finishing applications or for lower hardness (machinability) within group.  
 Above parameters are based on ideal conditions. For smaller taper machining centers, please adjust parameters accordingly on >1/2" diameter.

VariMill II ER • Series 5VNE • Application Data • WS15PE • Inch

Material Group	Side Milling (A) and Slotting (B)			WS15PE		Recommended feed per tooth (IPT = inch/th) for side milling (A). For slotting (B), reduce IPT by 20%.									
	A		B	Cutting Speed – vc SFM			D1 – Diameter								
	ap	ae	ap	min	max	frac. dec.	1/4	3/8	1/2	5/8	3/4	1	1 1/4		
							.2500	.3750	.5000	.6250	.7500	1.0000	1.2500		
P	4	1.5 x D	0.5 x D	0.75 x D	300	–	490	IPT	0.0014	0.0020	0.0026	0.0030	0.0034	0.0039	0.0040
	5	1.5 x D	0.5 x D	1 x D	200	–	330	IPT	0.0012	0.0018	0.0023	0.0027	0.0031	0.0036	0.0039
	6	1.5 x D	0.5 x D	0.75 x D	160	–	250	IPT	0.0010	0.0015	0.0019	0.0022	0.0025	0.0028	0.0029
M	1	1.5 x D	0.5 x D	1 x D	300	–	380	IPT	0.0015	0.0023	0.0029	0.0034	0.0039	0.0045	0.0048
	2	1.5 x D	0.5 x D	1 x D	200	–	260	IPT	0.0012	0.0018	0.0023	0.0027	0.0031	0.0036	0.0039
	3	1.5 x D	0.5 x D	1 x D	200	–	230	IPT	0.0010	0.0015	0.0019	0.0022	0.0025	0.0028	0.0029
S	1	1.5 x D	0.3 x D	0.3 x D	160	–	300	IPT	0.0015	0.0023	0.0029	0.0034	0.0039	0.0045	0.0048
	2	1.5 x D	0.3 x D	0.3 x D	80	–	130	IPT	0.0008	0.0012	0.0015	0.0018	0.0021	0.0024	0.0026
	3	1.5 x D	0.5 x D	1 x D	80	–	130	IPT	0.0008	0.0012	0.0015	0.0018	0.0021	0.0024	0.0026
	4	1.5 x D	0.5 x D	1 x D	160	–	200	IPT	0.0011	0.0017	0.0021	0.0025	0.0028	0.0033	0.0036
H	1	1.5 x D	0.5 x D	0.75 x D	260	–	460	IPT	0.0014	0.0020	0.0026	0.0030	0.0034	0.0039	0.0040
	2	1.5 x D	0.2 x D	0.5 x D	230	–	390	IPT	0.0010	0.0015	0.0019	0.0022	0.0025	0.0028	0.0029

NOTE: Lower value of cutting speed is used for high stock removal applications or for higher hardness (machinability) within group.  
 Higher value of cutting speed is used for finishing applications or for lower hardness (machinability) within group.  
 Above parameters are based on ideal conditions. For smaller taper machining centers, please adjust parameters accordingly on >1/2" diameter.

INDEXABLE MILLING

SOLID END MILLING

HOLEMAKING

TAPPING

TURNING



VariMill II • Series 5W1S • Application Data • ALTIN-MT • Inch

Material Group	Side Milling (A)		AITiN-MT		Recommended feed per tooth (IPT = inch/th) for side milling (A).								
	A		Cutting Speed – vc		frac. dec.	D1 – Diameter							
	ap	ae	min	max		1/4	5/16	3/8	1/2	5/8	3/4	1	
			SFM										
P	0	Ap1 max	0.05 x D	980	1310	IPT	0.0022	0.0028	0.0033	0.0041	0.0047	0.0053	0.0059
	1	Ap1 max	0.05 x D	980	1310	IPT	0.0022	0.0028	0.0033	0.0041	0.0047	0.0053	0.0059
	2	Ap1 max	0.05 x D	920	1250	IPT	0.0022	0.0028	0.0033	0.0041	0.0047	0.0053	0.0059
	3	Ap1 max	0.05 x D	790	1050	IPT	0.0018	0.0023	0.0027	0.0035	0.0041	0.0046	0.0054
	4	Ap1 max	0.05 x D	590	980	IPT	0.0017	0.0021	0.0025	0.0031	0.0036	0.0040	0.0046
	5	Ap1 max	0.05 x D	390	660	IPT	0.0015	0.0019	0.0022	0.0028	0.0033	0.0037	0.0043
M	6	Ap1 max	0.05 x D	330	490	IPT	0.0012	0.0016	0.0018	0.0023	0.0027	0.0030	0.0034
	1	Ap1 max	0.05 x D	590	750	IPT	0.0018	0.0023	0.0027	0.0035	0.0041	0.0046	0.0054
	2	Ap1 max	0.05 x D	390	520	IPT	0.0015	0.0019	0.0022	0.0028	0.0033	0.0037	0.0043
K	3	Ap1 max	0.05 x D	390	460	IPT	0.0012	0.0016	0.0018	0.0023	0.0027	0.0030	0.0034
	1	Ap1 max	0.05 x D	790	980	IPT	0.0022	0.0028	0.0033	0.0041	0.0047	0.0053	0.0059
	2	Ap1 max	0.05 x D	720	920	IPT	0.0018	0.0023	0.0027	0.0035	0.0041	0.0046	0.0054
S	3	Ap1 max	0.05 x D	720	850	IPT	0.0015	0.0019	0.0022	0.0028	0.0033	0.0037	0.0043
	1	Ap1 max	0.05 x D	160	300	IPT	0.0015	0.0020	0.0023	0.0029	0.0034	0.0039	0.0045
	2	Ap1 max	0.05 x D	80	130	IPT	0.0008	0.0010	0.0012	0.0015	0.0018	0.0021	0.0024
	3	Ap1 max	0.05 x D	80	130	IPT	0.0008	0.0010	0.0012	0.0015	0.0018	0.0021	0.0024
H	4	Ap1 max	0.05 x D	160	200	IPT	0.0011	0.0014	0.0017	0.0021	0.0025	0.0028	0.0033
	1	Ap1 max	0.05 x D	520	920	IPT	0.0017	0.0021	0.0025	0.0031	0.0036	0.0040	0.0046
	2	Ap1 max	0.05 x D	460	790	IPT	0.0012	0.0016	0.0018	0.0023	0.0027	0.0030	0.0034

\*For the above cutting data, do not exceed an overall ae of .032".

NOTE: Lower value of cutting speed is used for high stock removal applications or for higher hardness (machinability) within group.

Higher value of cutting speed is used for finishing applications or for lower hardness (machinability) within group.

Above parameters are based on ideal conditions. For smaller taper machining centers, please adjust parameters accordingly on >1/2" diameter.

VariMill II • Series 5777 • Application Data • WP15PE • Metric

Material Group	Side Milling (A) and Slotting (B)		WP15PE		Recommended feed per tooth (fz = mm/th) for side milling (A). For slotting (B), reduce fz by 20%.											
	A		Cutting Speed – vc		mm	D1 – Diameter										
	ap	ae	ap	min		max	4,0	6,0	8,0	10,0	12,0	16,0	20,0	25,0		
			m/min													
P	1	1,5 x D	0,5 x D	1 x D	150	–	200	fz	0,028	0,044	0,060	0,072	0,083	0,101	0,114	0,124
	2	1,5 x D	0,5 x D	1 x D	140	–	190	fz	0,028	0,044	0,060	0,072	0,083	0,101	0,114	0,124
	3	1,5 x D	0,5 x D	1 x D	120	–	160	fz	0,023	0,036	0,050	0,061	0,070	0,087	0,101	0,114
	4	1,5 x D	0,5 x D	0,75 x D	90	–	150	fz	0,021	0,033	0,045	0,054	0,062	0,077	0,088	0,098
	5	1,5 x D	0,5 x D	1 x D	60	–	100	fz	0,019	0,029	0,040	0,048	0,056	0,070	0,081	0,091
	6	1,5 x D	0,5 x D	0,75 x D	50	–	75	fz	0,016	0,025	0,034	0,040	0,047	0,057	0,065	0,071
M	1	1,5 x D	0,5 x D	1 x D	90	–	115	fz	0,023	0,036	0,050	0,061	0,070	0,087	0,101	0,114
	2	1,5 x D	0,5 x D	1 x D	60	–	80	fz	0,019	0,029	0,040	0,048	0,056	0,070	0,081	0,091
	3	1,5 x D	0,5 x D	1 x D	60	–	70	fz	0,016	0,025	0,034	0,040	0,047	0,057	0,065	0,071
K	1	1,5 x D	0,5 x D	1 x D	120	–	150	fz	0,028	0,044	0,060	0,072	0,083	0,101	0,114	0,124
	2	1,5 x D	0,5 x D	1 x D	110	–	130	fz	0,023	0,036	0,050	0,061	0,070	0,087	0,101	0,114
	3	1,5 x D	0,5 x D	1 x D	100	–	130	fz	0,019	0,029	0,040	0,048	0,056	0,070	0,081	0,091
S	1	1,5 x D	0,3 x D	0,3 x D	50	–	90	fz	0,023	0,036	0,050	0,061	0,070	0,087	0,101	0,114
	2	1,5 x D	0,3 x D	0,3 x D	25	–	40	fz	0,013	0,019	0,026	0,032	0,037	0,046	0,054	0,061
	3	1,5 x D	0,5 x D	1 x D	25	–	40	fz	0,013	0,019	0,026	0,032	0,037	0,046	0,054	0,061
	4	1,5 x D	0,5 x D	1 x D	50	–	60	fz	0,016	0,026	0,037	0,045	0,052	0,064	0,074	0,084
H	1	1,5 x D	0,5 x D	0,75 x D	80	–	140	fz	0,021	0,033	0,045	0,054	0,062	0,077	0,088	0,098

NOTE: Lower value of cutting speed is used for high-stock removal applications or for higher hardness (machinability) within group.

Higher value of cutting speed is used for finishing applications or for lower hardness (machinability) within group.

Above parameters are based on ideal conditions. For smaller taper machining centers, please adjust parameters accordingly on > 12mm diameters.



VariMill II • Series 577C • Application Data • WP15PE • Metric

Material Group	Side Milling (A) and Slotting (B)			WP15PE		Recommended feed per tooth (fz = mm/th) for side milling (A). For slotting (B), reduce fz by 20%.													
	A		B	Cutting Speed – vc m/min		mm	D1 – Diameter												
	ap	ae	ap	min	max		4,0	5,0	6,0	8,0	10,0	12,0	14,0	16,0	18,0	20,0	25,0		
	ap	ae	ap	min	max	fz	fz	fz	fz	fz	fz	fz	fz	fz	fz	fz	fz		
P	0	1,5 x D	0,5 x D	1 x D	150	–	200	fz	0,028	0,036	0,044	0,060	0,072	0,083	0,092	0,101	0,108	0,114	0,124
	1	1,5 x D	0,5 x D	1 x D	150	–	200	fz	0,028	0,036	0,044	0,060	0,072	0,083	0,092	0,101	0,108	0,114	0,124
	2	1,5 x D	0,5 x D	1 x D	140	–	190	fz	0,028	0,036	0,044	0,060	0,072	0,083	0,092	0,101	0,108	0,114	0,124
	3	1,5 x D	0,5 x D	1 x D	120	–	160	fz	0,023	0,030	0,036	0,050	0,061	0,070	0,079	0,087	0,095	0,101	0,114
	4	1,5 x D	0,5 x D	0,75 x D	90	–	150	fz	0,021	0,027	0,033	0,045	0,054	0,062	0,070	0,077	0,083	0,088	0,098
	5	1,5 x D	0,5 x D	1 x D	60	–	100	fz	0,019	0,024	0,029	0,040	0,048	0,056	0,063	0,070	0,076	0,081	0,091
M	1	1,5 x D	0,5 x D	1 x D	90	–	115	fz	0,023	0,030	0,036	0,050	0,061	0,070	0,079	0,087	0,095	0,101	0,114
	2	1,5 x D	0,5 x D	1 x D	60	–	80	fz	0,019	0,024	0,029	0,040	0,048	0,056	0,063	0,070	0,076	0,081	0,091
	3	1,5 x D	0,5 x D	1 x D	60	–	70	fz	0,016	0,020	0,025	0,034	0,040	0,047	0,052	0,057	0,061	0,065	0,071
K	1	1,5 x D	0,5 x D	1 x D	120	–	150	fz	0,028	0,036	0,044	0,060	0,072	0,083	0,092	0,101	0,108	0,114	0,124
	2	1,5 x D	0,5 x D	1 x D	110	–	140	fz	0,023	0,030	0,036	0,050	0,061	0,070	0,079	0,087	0,095	0,101	0,114
S	1	1,5 x D	0,3 x D	0,3 x D	50	–	90	fz	0,023	0,030	0,036	0,050	0,061	0,070	0,079	0,087	0,095	0,101	0,114
	2	1,5 x D	0,3 x D	0,3 x D	25	–	40	fz	0,013	0,016	0,019	0,026	0,032	0,037	0,042	0,046	0,050	0,054	0,061
	3	1,5 x D	0,5 x D	1 x D	25	–	40	fz	0,013	0,016	0,019	0,026	0,032	0,037	0,042	0,046	0,050	0,054	0,061
	4	1,5 x D	0,5 x D	1 x D	50	–	60	fz	0,016	0,021	0,026	0,037	0,045	0,052	0,058	0,064	0,069	0,074	0,084
H	1	1,5 x D	0,5 x D	0,75 x D	80	–	140	fz	0,021	0,027	0,033	0,045	0,054	0,062	0,070	0,077	0,083	0,088	0,098
	2	1,5 x D	0,2 x D	0,5 x D	70	–	120	fz	0,016	0,020	0,025	0,034	0,040	0,047	0,052	0,057	0,061	0,065	0,071

NOTE: Lower value of cutting speed is used for high stock removal applications or for higher hardness (machinability) within group.  
Higher value of cutting speed is used for finishing applications or for lower hardness (machinability) within group.  
Above parameters are based on ideal conditions. For smaller taper machining centers, please adjust parameters accordingly on >12mm diameters.

VariMill II • Series 57N8 • Application Data • WS15PE • Metric

Material Group	Side Milling (A) and Slotting (B)			WS15PE		Recommended feed per tooth (fz = mm/th) for side milling (A). For slotting (B), reduce fz by 20%.										
	A		B	Cutting Speed – vc m/min		mm	D1 – Diameter									
	ap	ae	ap	min	max		6,0	8,0	10,0	12,0	16,0	20,0	25,0			
	ap	ae	ap	min	max	fz	fz	fz	fz	fz	fz	fz	fz			
P	1	1,5 x D	0,5 x D	1 x D	150	–	200	fz	0,044	0,060	0,072	0,083	0,101	0,114	0,124	
	2	1,5 x D	0,5 x D	1 x D	140	–	190	fz	0,044	0,060	0,072	0,083	0,101	0,114	0,124	
	3	1,5 x D	0,5 x D	1 x D	120	–	160	fz	0,036	0,050	0,061	0,070	0,087	0,101	0,114	
	4	1,5 x D	0,5 x D	0,75 x D	90	–	150	fz	0,033	0,045	0,054	0,062	0,077	0,088	0,098	
	5	1,5 x D	0,5 x D	1 x D	60	–	100	fz	0,029	0,040	0,048	0,056	0,070	0,081	0,091	
	6	1,5 x D	0,5 x D	0,75 x D	50	–	75	fz	0,025	0,034	0,040	0,047	0,057	0,065	0,071	
M	1	1,5 x D	0,5 x D	1 x D	90	–	115	fz	0,036	0,050	0,061	0,070	0,087	0,101	0,114	
	2	1,5 x D	0,5 x D	1 x D	60	–	80	fz	0,029	0,040	0,048	0,056	0,070	0,081	0,091	
	3	1,5 x D	0,5 x D	1 x D	60	–	70	fz	0,025	0,034	0,040	0,047	0,057	0,065	0,071	
K	1	1,5 x D	0,5 x D	1 x D	120	–	150	fz	0,044	0,060	0,072	0,083	0,101	0,114	0,124	
	2	1,5 x D	0,5 x D	1 x D	110	–	130	fz	0,036	0,050	0,061	0,070	0,087	0,101	0,114	
S	1	1,5 x D	0,3 x D	0,3 x D	100	–	130	fz	0,029	0,040	0,048	0,056	0,070	0,081	0,091	
	1	1,5 x D	0,3 x D	0,3 x D	50	–	90	fz	0,036	0,050	0,061	0,070	0,087	0,101	0,114	
	2	1,5 x D	0,3 x D	0,3 x D	25	–	40	fz	0,019	0,026	0,032	0,037	0,046	0,054	0,061	
	3	1,5 x D	0,5 x D	1 x D	25	–	40	fz	0,019	0,026	0,032	0,037	0,046	0,054	0,061	
H	1	1,5 x D	0,5 x D	1 x D	50	–	60	fz	0,026	0,037	0,045	0,052	0,064	0,074	0,084	
	1	1,5 x D	0,5 x D	0,75 x D	80	–	140	fz	0,033	0,045	0,054	0,062	0,077	0,088	0,098	

NOTE: Lower value of cutting speed is used for high-stock removal applications or for higher hardness (machinability) within group.  
Higher value of cutting speed is used for finishing applications or for lower hardness (machinability) within group.  
Above parameters are based on ideal conditions. For smaller taper machining centers, please adjust parameters accordingly on diameters >12mm diameters.

INDEXABLE MILLING

SOLID END MILLING

HOLEMAKING

TAPPING

TURNING

VariMill II • Series 57NC • Application Data • WS15PE • Metric

Material Group	Side Milling (A) and Slotting (B)			WS15PE			Recommended feed per tooth (fz = mm/th) for side milling (A). For slotting (B), reduce fz by 20%.										
	A		B	Cutting Speed – vc m/min			mm	D1 – Diameter									
	ap	ae	ap	min	max	6,0		8,0	10,0	12,0	14,0	16,0	18,0	20,0	25,0		
	ap	ae	ap	min	max	fz	fz	fz	fz	fz	fz	fz	fz	fz	fz		
P	5	1,5 x D	0,5 x D	1 x D	60	–	100	fz	0,029	0,040	0,048	0,056	0,063	0,070	0,076	0,081	0,091
	6	1,5 x D	0,5 x D	0,75 x D	50	–	75	fz	0,025	0,034	0,040	0,047	0,052	0,057	0,061	0,065	0,071
M	1	1,5 x D	0,5 x D	1 x D	90	–	115	fz	0,036	0,050	0,061	0,070	0,079	0,087	0,095	0,101	0,114
	2	1,5 x D	0,5 x D	1 x D	60	–	80	fz	0,029	0,040	0,048	0,056	0,063	0,070	0,076	0,081	0,091
	3	1,5 x D	0,5 x D	1 x D	60	–	70	fz	0,025	0,034	0,040	0,047	0,052	0,057	0,061	0,065	0,071
K	1	1,5 x D	0,5 x D	1 x D	120	–	150	fz	0,044	0,060	0,072	0,083	0,092	0,101	0,108	0,114	0,124
	2	1,5 x D	0,5 x D	1 x D	110	–	140	fz	0,036	0,050	0,061	0,070	0,079	0,087	0,095	0,101	0,114
	3	1,5 x D	0,5 x D	1 x D	110	–	130	fz	0,029	0,040	0,048	0,056	0,063	0,070	0,076	0,081	0,091
S	1	1,5 x D	0,3 x D	0,3 x D	50	–	90	fz	0,036	0,050	0,061	0,070	0,079	0,087	0,095	0,101	0,114
	2	1,5 x D	0,3 x D	0,3 x D	25	–	40	fz	0,019	0,026	0,032	0,037	0,042	0,046	0,050	0,054	0,061
	3	1,5 x D	0,5 x D	1 x D	25	–	40	fz	0,019	0,026	0,032	0,037	0,042	0,046	0,050	0,054	0,061
	4	1,5 x D	0,5 x D	1 x D	50	–	60	fz	0,026	0,037	0,045	0,052	0,058	0,064	0,069	0,074	0,084
H	1	1,5 x D	0,5 x D	0,75 x D	80	–	140	fz	0,033	0,045	0,054	0,062	0,070	0,077	0,083	0,088	0,098
	2	1,5 x D	0,2 x D	0,5 x D	70	–	120	fz	0,025	0,034	0,040	0,047	0,052	0,057	0,061	0,065	0,071

NOTE: Lower value of cutting speed is used for high stock removal applications or for higher hardness (machinability) within group.  
Higher value of cutting speed is used for finishing applications or for lower hardness (machinability) within group.  
Above parameters are based on ideal conditions. For smaller taper machining centers, please adjust parameters accordingly on >12mm diameters.

VariMill II ER • Series 577E • Application Data • WS15PE • Metric

Material Group	Side Milling (A) and Slotting (B)			WS15PE			Recommended feed per tooth (fz = mm/th) for side milling (A). For slotting (B), reduce fz by 20%.									
	A		B	Cutting Speed – vc m/min			mm	D1 – Diameter								
	ap	ae	ap	min	max	10,0		12,0	14,0	16,0	18,0	20,0	25,0			
	ap	ae	ap	min	max	fz	fz	fz	fz	fz	fz	fz	fz			
P	4	1,5 x D	0,5 x D	0,75 x D	90	–	150	fz	0,054	0,062	0,070	0,077	0,083	0,088	0,098	
	5	1,5 x D	0,5 x D	1 x D	60	–	100	fz	0,048	0,056	0,063	0,070	0,076	0,081	0,091	
M	6	1,5 x D	0,5 x D	0,75 x D	50	–	75	fz	0,040	0,047	0,052	0,057	0,061	0,065	0,071	
	1	1,5 x D	0,5 x D	1 x D	90	–	115	fz	0,061	0,070	0,079	0,087	0,095	0,101	0,114	
	2	1,5 x D	0,5 x D	1 x D	60	–	80	fz	0,048	0,056	0,063	0,070	0,076	0,081	0,091	
S	3	1,5 x D	0,5 x D	1 x D	60	–	70	fz	0,040	0,047	0,052	0,057	0,061	0,065	0,071	
	1	1,5 x D	0,3 x D	0,3 x D	50	–	90	fz	0,061	0,070	0,079	0,087	0,095	0,101	0,114	
	2	1,5 x D	0,3 x D	0,3 x D	25	–	40	fz	0,032	0,037	0,042	0,046	0,050	0,054	0,061	
	3	1,5 x D	0,5 x D	1 x D	25	–	40	fz	0,032	0,037	0,042	0,046	0,050	0,054	0,061	
H	4	1,5 x D	0,5 x D	1 x D	50	–	60	fz	0,045	0,052	0,058	0,064	0,069	0,074	0,084	
	1	1,5 x D	0,5 x D	0,75 x D	80	–	140	fz	0,054	0,062	0,070	0,077	0,083	0,088	0,098	
2	1,5 x D	0,2 x D	0,5 x D	70	–	120	fz	0,040	0,047	0,052	0,057	0,061	0,065	0,071		

NOTE: Lower value of cutting speed is used for high stock removal applications or for higher hardness (machinability) within group.  
Higher value of cutting speed is used for finishing applications or for lower hardness (machinability) within group.  
Above parameters are based on ideal conditions. For smaller taper machining centers, please adjust parameters accordingly on >12mm diameters.

VariMill II ER • Series 57NE • Application Data • WS15PE • Metric

Material Group	Side Milling (A) and Slotting (B)		WS15PE				Recommended feed per tooth (fz = mm/th) for side milling (A). For slotting (B), reduce fz by 20%.								
	A		B		Cutting Speed – vc m/min		mm	D1 – Diameter							
	ap	ae	ap		min	max		10,0	12,0	14,0	16,0	18,0	20,0	25,0	
							fz								
P	4	1,5 x D	0,5 x D	0,75 x D	90	–	150	fz	0,054	0,062	0,070	0,077	0,083	0,088	0,098
	5	1,5 x D	0,5 x D	1 x D	60	–	100	fz	0,048	0,056	0,063	0,070	0,076	0,081	0,091
	6	1,5 x D	0,5 x D	0,75 x D	50	–	75	fz	0,040	0,047	0,052	0,057	0,061	0,065	0,071
M	1	1,5 x D	0,5 x D	1 x D	90	–	115	fz	0,061	0,070	0,079	0,087	0,095	0,101	0,114
	2	1,5 x D	0,5 x D	1 x D	60	–	80	fz	0,048	0,056	0,063	0,070	0,076	0,081	0,091
	3	1,5 x D	0,5 x D	1 x D	60	–	70	fz	0,040	0,047	0,052	0,057	0,061	0,065	0,071
S	1	1,5 x D	0,3 x D	0,3 x D	50	–	90	fz	0,061	0,070	0,079	0,087	0,095	0,101	0,114
	2	1,5 x D	0,3 x D	0,3 x D	25	–	40	fz	0,032	0,037	0,042	0,046	0,050	0,054	0,061
	3	1,5 x D	0,5 x D	1 x D	25	–	40	fz	0,032	0,037	0,042	0,046	0,050	0,054	0,061
	4	1,5 x D	0,5 x D	1 x D	50	–	60	fz	0,045	0,052	0,058	0,064	0,069	0,074	0,084
H	1	1,5 x D	0,5 x D	0,75 x D	80	–	140	fz	0,054	0,062	0,070	0,077	0,083	0,088	0,098
	2	1,5 x D	0,2 x D	0,5 x D	70	–	120	fz	0,040	0,047	0,052	0,057	0,061	0,065	0,071

NOTE: Lower value of cutting speed is used for high stock removal applications or for higher hardness (machinability) within group.  
Higher value of cutting speed is used for finishing applications or for lower hardness (machinability) within group.  
Above parameters are based on ideal conditions. For smaller taper machining centers, please adjust parameters accordingly on >12mm diameters.

VariMill II Long • Series 5718 • Application Data • ALTIN-MT • Metric

Material Group	Side Milling (A)		ALTIN				Recommended feed per tooth (fz = mm/th) for side milling (A).									
	A		Cutting Speed – vc m/min		mm	D1 – Diameter										
	ap	ae	min	max		6,0	8,0	10,0	12,0	14,0	16,0	18,0	20,0	25,0		
					fz											
P	0	Ap1 max	0,05 x D	300	–	400	fz	0,053	0,072	0,086	0,099	0,111	0,121	0,130	0,137	0,149
	1	Ap1 max	0,05 x D	300	–	400	fz	0,053	0,072	0,086	0,099	0,111	0,121	0,130	0,137	0,149
	2	Ap1 max	0,05 x D	280	–	380	fz	0,053	0,072	0,086	0,099	0,111	0,121	0,130	0,137	0,149
	3	Ap1 max	0,05 x D	240	–	320	fz	0,044	0,060	0,073	0,084	0,095	0,105	0,113	0,121	0,137
	4	Ap1 max	0,05 x D	180	–	300	fz	0,039	0,054	0,065	0,075	0,084	0,092	0,099	0,106	0,117
	5	Ap1 max	0,05 x D	120	–	200	fz	0,035	0,048	0,058	0,067	0,076	0,084	0,091	0,097	0,109
M	1	Ap1 max	0,05 x D	180	–	230	fz	0,044	0,060	0,073	0,084	0,095	0,105	0,113	0,121	0,137
	2	Ap1 max	0,05 x D	120	–	160	fz	0,035	0,048	0,058	0,067	0,076	0,084	0,091	0,097	0,109
	3	Ap1 max	0,05 x D	120	–	140	fz	0,030	0,040	0,048	0,056	0,062	0,068	0,073	0,078	0,085
K	1	Ap1 max	0,05 x D	240	–	300	fz	0,053	0,072	0,086	0,099	0,111	0,121	0,130	0,137	0,149
	2	Ap1 max	0,05 x D	220	–	280	fz	0,044	0,060	0,073	0,084	0,095	0,105	0,113	0,121	0,137
	3	Ap1 max	0,05 x D	220	–	260	fz	0,035	0,048	0,058	0,067	0,076	0,084	0,091	0,097	0,109
S	1	Ap1 max	0,05 x D	50	–	90	fz	0,036	0,050	0,061	0,070	0,079	0,087	0,095	0,101	0,114
	2	Ap1 max	0,05 x D	25	–	40	fz	0,019	0,026	0,032	0,037	0,042	0,046	0,050	0,054	0,061
	3	Ap1 max	0,05 x D	25	–	40	fz	0,019	0,026	0,032	0,037	0,042	0,046	0,050	0,054	0,061
	4	Ap1 max	0,05 x D	50	–	60	fz	0,026	0,037	0,045	0,052	0,058	0,064	0,069	0,074	0,084
H	1	Ap1 max	0,05 x D	160	–	280	fz	0,039	0,054	0,065	0,075	0,084	0,092	0,099	0,106	0,117
	2	Ap1 max	0,05 x D	140	–	240	fz	0,030	0,040	0,048	0,056	0,062	0,068	0,073	0,078	0,085

\* For the above cutting data, do not exceed an overall ae of 0,8mm.  
NOTE: Lower value of cutting speed is used for high stock removal applications or for higher hardness (machinability) within group.  
Higher value of cutting speed is used for finishing applications or for lower hardness (machinability) within group.  
Above parameters are based on ideal conditions. For smaller taper machining centers, please adjust parameters accordingly on >0,5mm diameters.

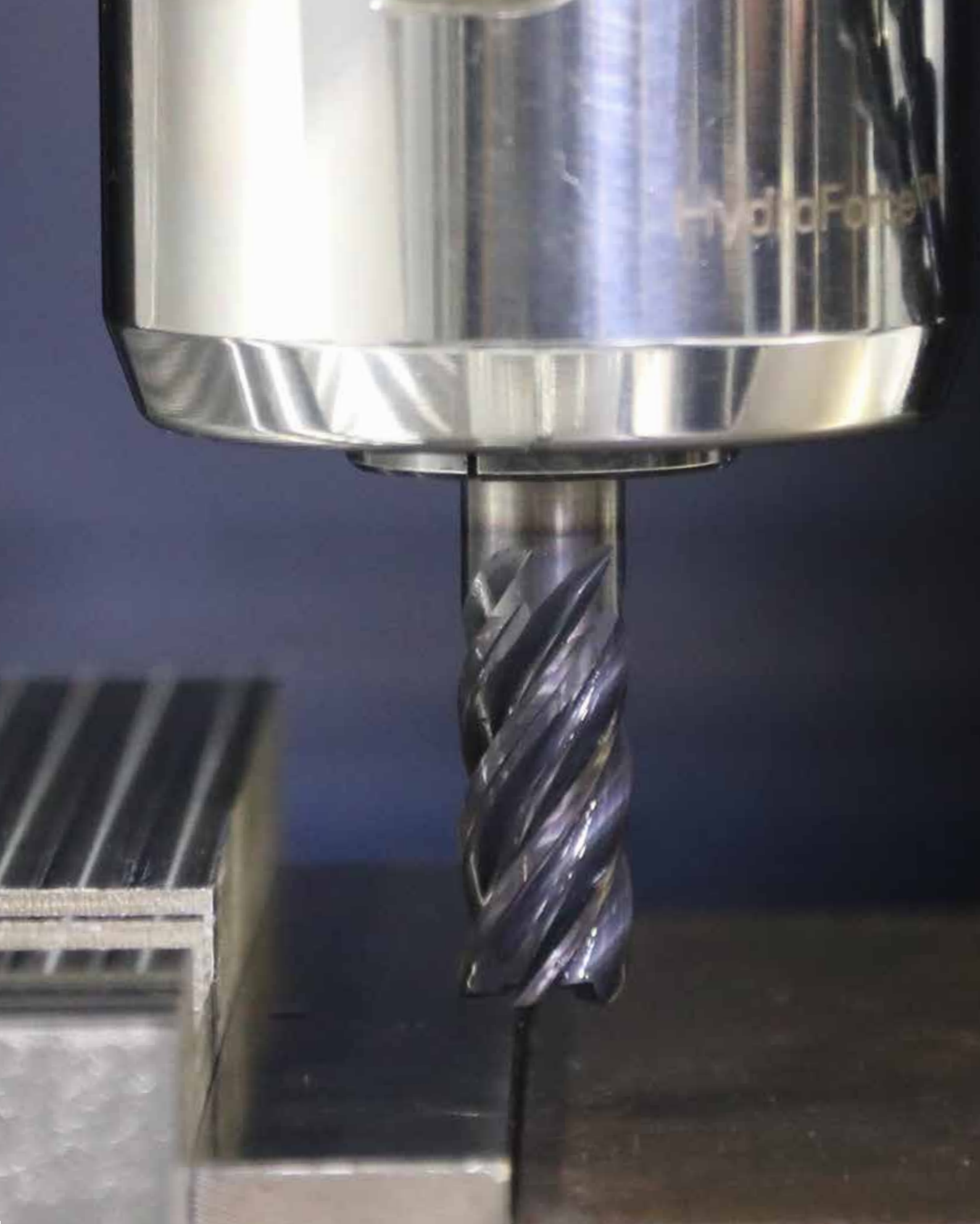

# VariMill III™ ER

## High-Performance Solid End Milling

VariMill III ER is a 7-flute solid carbide end mill engineered to provide the highest metal removal rates in difficult-to-machine workpiece materials, providing extended tool life in semi-finishing, finishing, and dynamic milling operations.

### Features and Benefits



## ***FAST***

The 7-flute geometry ensures the highest feed-rates in side milling operations.

## ***DYNAMIC***

The flute and core design enable high performance and productivity in high-speed and dynamic milling applications.

## ***SPECIFIC***

VariMill III ER is particularly engineered to tackle all milling applications on difficult-to-cut materials such as heat-resistant superalloys and stainless steels.



# DYNAMICALLY PRODUCTIVE

## PRODUCT

SOLID CARBIDE END MILL

GRADE

WS15PE

FLUTE

7

DIAMETER RANGE

INCH

3/8–1"

METRIC

10–20mm

## INDUSTRY



GENERAL  
ENGINEERING



ENERGY



AEROSPACE

## APPLICATIONS

MATERIALS

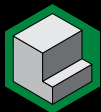

SIDE MILLING

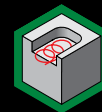

DYNAMIC  
MILLING



HELICAL  
INTERPOLATION



RAMPING

## VariMill III ER • Series 7V1E 7V2E • Square End • 7 Flute • Inch

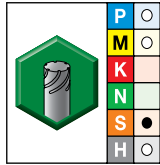
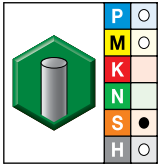
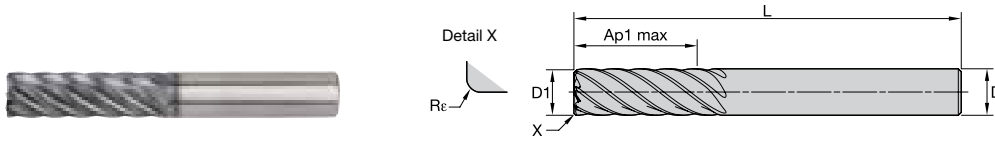

● first choice  
○ alternate choice

WS15PE		WS15PE		D1	D	length of cut Ap1 max	length L	Re	Z U
6566337	7V0E10004AT	-	-	3/8	3/8	7/8	2 1/2	.015	7
6566338	7V0E10004BT	-	-	3/8	3/8	7/8	2 1/2	.030	7
6566336	7V0E10004ST	-	-	3/8	3/8	7/8	2 1/2	-	7
5971350	7V1E10004AT	-	-	3/8	3/8	1 1/8	3	.015	7
5971421	7V1E10004BT	-	-	3/8	3/8	1 1/8	3	.030	7
6566339	7V1E10004ST	-	-	3/8	3/8	1 1/8	3	-	7
5971422	7V2E10004AT	-	-	3/8	3/8	1 7/8	4	.015	7
5971423	7V2E10004BT	-	-	3/8	3/8	1 7/8	4	.030	7
6566411	7V0E13005BT	-	-	1/2	1/2	1 1/4	3	.030	7
6566412	7V0E13005CT	-	-	1/2	1/2	1 1/4	3	.060	7
6566340	7V0E13005ST	-	-	1/2	1/2	1 1/4	3	-	7
5971427	7V1E13005BT	-	-	1/2	1/2	1 1/2	3 1/2	.030	7
5971428	7V1E13005CT	-	-	1/2	1/2	1 1/2	3 1/2	.060	7
5971429	7V1E13005ET	-	-	1/2	1/2	1 1/2	3 1/2	.120	7
-	5971430	7V2E13005BV	-	1/2	1/2	2 1/2	4 1/2	.030	7
-	5971431	7V2E13005CV	-	1/2	1/2	2 1/2	4 1/2	.060	7
-	5971432	7V2E13005EV	-	1/2	1/2	2 1/2	4 1/2	.120	7
6566414	7V0E16006BT	-	-	5/8	5/8	1 1/4	3 1/2	.030	7
6566413	7V0E16006ST	-	-	5/8	5/8	1 1/4	3 1/2	-	7
5971435	7V1E16006BT	-	-	5/8	5/8	1 7/8	4	.030	7
5971436	7V1E16006CT	-	-	5/8	5/8	1 7/8	4	.060	7
-	5971437	7V2E16006BV	-	5/8	5/8	3 1/8	5 1/2	.030	7
-	5971438	7V2E16006CV	-	5/8	5/8	3 1/8	5 1/2	.060	7
6566416	7V0E19007BT	-	-	3/4	3/4	1 3/4	4	.030	7
6566417	7V0E19007CT	-	-	3/4	3/4	1 3/4	4	.060	7
6566418	7V0E19007ET	-	-	3/4	3/4	1 3/4	4	.120	7
6566415	7V0E19007ST	-	-	3/4	3/4	1 3/4	4	-	7
5971445	7V1E19007BT	-	-	3/4	3/4	2 1/4	5	.030	7
-	5971448	7V1E19007BV	-	3/4	3/4	2 1/4	5	.030	7
-	5971449	7V1E19007CV	-	3/4	3/4	2 1/4	5	.060	7
5971446	7V1E19007CT	-	-	3/4	3/4	2 1/4	5	.060	7
-	5971450	7V1E19007EV	-	3/4	3/4	2 1/4	5	.120	7
5971447	7V1E19007ET	-	-	3/4	3/4	2 1/4	5	.120	7
6566421	7V1E19007ST	-	-	3/4	3/4	2 1/4	5	-	7
-	5971451	7V2E19007BV	-	3/4	3/4	3 3/4	6	.030	7
-	5971452	7V2E19007CV	-	3/4	3/4	3 3/4	6	.060	7
-	5971453	7V2E19007EV	-	3/4	3/4	3 3/4	6	.120	7
5971456	7V1E25008CT	-	-	1	1	3	5 1/2	.060	7
-	5971457	7V1E25008CV	-	1	1	3	5 1/2	.060	7
-	5971458	7V2E25008CV	-	1	1	5	7 1/2	.060	7

INDEXABLE MILLING

SOLID END MILLING

HOLEMAKING

TAPPING

TURNING

VariMill III ER • Series 7VNX • Square End • Internal Coolant • 7 Flute • Inch

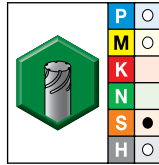
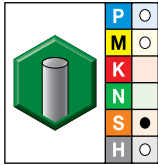
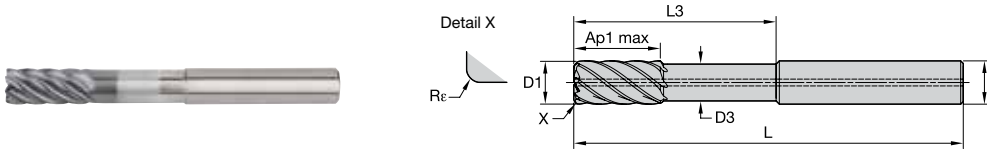

● first choice  
○ alternate choice

WS15PE		WS15PE		D1	D	D3	length of cut Ap1 max	L3	length L	Re	Z U
5971348	7VNX10004AT	—	—	3/8	3/8	.35	3/4	2.125	4	.015	7
5971349	7VNX10004BT	—	—	3/8	3/8	.35	3/4	2.125	4	.030	7
5971424	7VNX13005BT	—	—	1/2	1/2	.47	1	2.375	4 1/2	.030	7
5971425	7VNX13005CT	—	—	1/2	1/2	.47	1	2.375	4 1/2	.060	7
5971426	7VNX13005ET	—	—	1/2	1/2	.47	1	2.375	4 1/2	.120	7
5971433	7VNX16006BT	—	—	5/8	5/8	.59	1 1/4	2.750	5	.030	7
5971434	7VNX16006CT	—	—	5/8	5/8	.59	1 1/4	2.750	5	.060	7
5971439	7VNX19007BT	5971442	7VNX19007BV	3/4	3/4	.71	1 1/2	3.125	5 1/2	.030	7
5971440	7VNX19007CT	5971443	7VNX19007CV	3/4	3/4	.71	1 1/2	3.125	5 1/2	.060	7
5971441	7VNX19007ET	5971444	7VNX19007EV	3/4	3/4	.71	1 1/2	3.125	5 1/2	.120	7
5971454	7VNX25008CT	5971455	7VNX25008CV	1	1	.94	2	3.375	6	.060	7

VariMill III ER • Series 771E 772E • Square End • 7 Flute • Metric

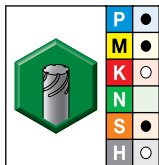
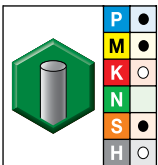
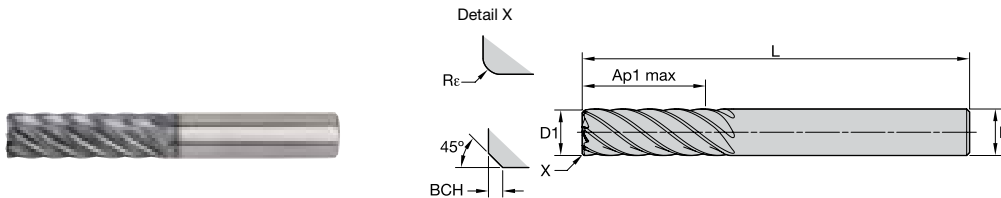

● first choice  
○ alternate choice

WS15PE		WS15PE		D1	D	length of cut Ap1 max	length L	Re	BCH	Z U
5978092	771E10004T	—	—	10,0	10	30,00	76	—	0,50	7
5978093	771E10024T	—	—	10,0	10	30,00	76	0,50	—	7
5978094	772E10004T	—	—	10,0	10	50,00	100	—	0,50	7
5978095	772E10024T	—	—	10,0	10	50,00	100	0,50	—	7
5978098	771E12005T	—	—	12,0	12	36,00	100	—	0,50	7
5978099	771E12025T	—	—	12,0	12	36,00	100	0,50	—	7
5978100	772E12005T	5978102	772E12005V	12,0	12	60,00	125	—	0,50	7
5978101	772E12025T	5978103	772E12025V	12,0	12	60,00	125	0,50	—	7
5978106	771E16006T	—	—	16,0	16	48,00	110	—	0,50	7
5978107	771E16026T	—	—	16,0	16	48,00	110	0,50	—	7
5978108	772E16006T	5978110	772E16006V	16,0	16	80,00	141	—	0,50	7
5978109	772E16026T	5978111	772E16026V	16,0	16	80,00	141	0,50	—	7
5978114	771E20007T	—	—	20,0	20	60,00	125	—	0,50	7
5978115	771E20027T	—	—	20,0	20	60,00	125	0,50	—	7
5978116	772E20007T	5978118	772E20007V	20,0	20	100,00	166	—	0,50	7
5978117	772E20027T	5978119	772E20027V	20,0	20	100,00	166	0,50	—	7





## VariMill III ER • Series 77NE • Square End • Neck • 7 Flute • Metric

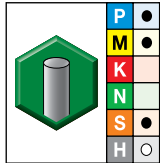
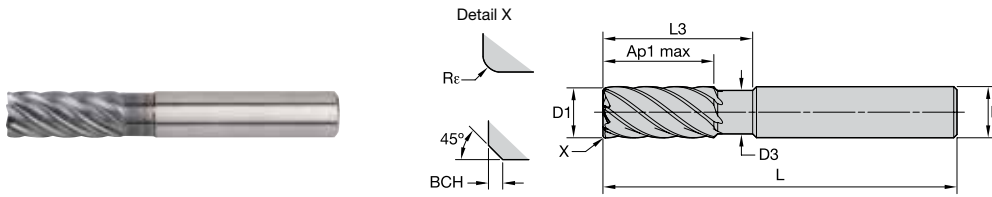

● first choice  
○ alternate choice

WS15PE

order #	catalog #	D1	D	D3	length of cut Ap1 max	L3	length L	Rε	BCH	Z U
5978039	77NE10004T	10,0	10	9,40	22,00	30,00	76	—	0,50	7
5978040	77NE10024T	10,0	10	9,40	22,00	30,00	76	0,50	—	7
5978096	77NE12005T	12,0	12	11,28	26,00	36,00	83	—	0,50	7
5978097	77NE12025T	12,0	12	11,28	26,00	36,00	83	0,50	—	7
5978104	77NE16006T	16,0	16	15,04	32,00	48,00	100	—	0,50	7
5978105	77NE16026T	16,0	16	15,04	32,00	48,00	100	0,50	—	7
5978112	77NE20007T	20,0	20	18,80	38,00	60,00	115	—	0,50	7
5978113	77NE20027T	20,0	20	18,80	38,00	60,00	115	0,50	—	7

INDEXABLE MILLING

SOLID END MILLING

HOLEMAKING

TAPPING

TURNING

VariMill III ER • Series 7V1E • Application Data • WS15PE • Inch

Material Group	Side Milling (A)		WS15PE			Recommended feed per tooth (IPT = inch/th) for side milling (A).						
	A		Cutting Speed – vc SFM			D1 – Diameter						
	ap	ae	min		max	frac. dec.	3/8	1/2	5/8	3/4	1	
	ap1 max	0.1 x D		-								
P	4	Ap1 max	0.1 x D	300	-	490	IPT	0.0020	0.0026	0.0030	0.0034	0.0039
	5	Ap1 max	0.1 x D	200	-	330	IPT	0.0018	0.0023	0.0027	0.0031	0.0036
M	1	Ap1 max	0.1 x D	300	-	380	IPT	0.0023	0.0029	0.0034	0.0039	0.0045
	2	Ap1 max	0.1 x D	200	-	260	IPT	0.0018	0.0023	0.0027	0.0031	0.0036
S	3	Ap1 max	0.1 x D	200	-	230	IPT	0.0015	0.0019	0.0022	0.0025	0.0028
	1	Ap1 max	0.1 x D	160	-	300	IPT	0.0023	0.0029	0.0034	0.0039	0.0045
	2	Ap1 max	0.1 x D	80	-	130	IPT	0.0012	0.0015	0.0018	0.0021	0.0024
	4	Ap1 max	0.1 x D	160	-	200	IPT	0.0017	0.0021	0.0025	0.0028	0.0033
H	1	Ap1 max	0.1 x D	260	-	460	IPT	0.0020	0.0026	0.0030	0.0034	0.0039
	2	Ap1 max	0.1 x D	230	-	390	IPT	0.0015	0.0019	0.0022	0.0025	0.0028

NOTE: Lower value of cutting speed is used for high stock removal applications or for higher hardness (machinability) within group.  
 Higher value of cutting speed is used for finishing applications or for lower hardness (machinability) within group.  
 Above parameters are based on ideal conditions. For smaller taper machining centers, please adjust parameters accordingly on >1/2" diameter.

VariMill III ER • Series 7V1E • Application Data • WS15PE • Inch

Material Group	Side Milling (A)		WS15PE			Recommended feed per tooth (IPT = inch/th) for side milling (A).						
	A		Cutting Speed – vc SFM			D1 – Diameter						
	ap	ae	min		max	frac. dec.	3/8	1/2	5/8	3/4	1	
	ap1 max	0.06 x D		-								
P	4	Ap1 max	0.06 x D	590	-	980	IPT	0.0025	0.0031	0.0036	0.0040	0.0046
	5	Ap1 max	0.06 x D	390	-	660	IPT	0.0022	0.0028	0.0033	0.0037	0.0043
M	1	Ap1 max	0.06 x D	590	-	750	IPT	0.0027	0.0035	0.0041	0.0046	0.0054
	2	Ap1 max	0.06 x D	390	-	520	IPT	0.0022	0.0028	0.0033	0.0037	0.0043
S	3	Ap1 max	0.06 x D	390	-	460	IPT	0.0018	0.0023	0.0027	0.0030	0.0034
	1	Ap1 max	0.06 x D	160	-	300	IPT	0.0023	0.0029	0.0034	0.0039	0.0045
	2	Ap1 max	0.06 x D	80	-	130	IPT	0.0012	0.0015	0.0018	0.0021	0.0024
	4	Ap1 max	0.06 x D	160	-	200	IPT	0.0017	0.0021	0.0025	0.0028	0.0033
H	1	Ap1 max	0.06 x D	520	-	920	IPT	0.0025	0.0031	0.0036	0.0040	0.0046
	2	Ap1 max	0.06 x D	460	-	790	IPT	0.0018	0.0023	0.0027	0.0030	0.0034

NOTE: Lower value of cutting speed is used for high stock removal applications or for higher hardness (machinability) within group.  
 Higher value of cutting speed is used for finishing applications or for lower hardness (machinability) within group.  
 Above parameters are based on ideal conditions. For smaller taper machining centers, please adjust parameters accordingly on >1/2" diameter.

VariMill III ER • Series 7V2E • Application Data • WS15PE • Inch

INDEXABLE MILLING

SOLID END MILLING

HOLEMAKING

TAPPING

TURNING

Material Group	Side Milling (A)		WS15PE			Recommended feed per tooth (IPT = inch/th) for side milling (A).					
	A		Cutting Speed – vc SFM			D1 – Diameter					
	ap	ae	min		max	frac. dec.	3/8	1/2	5/8	3/4	1
	ap	ae	min		max	dec.	.3750	.5000	.6250	.7500	1.0000
P	0	Ap1 max 0.05 x D	980	-	1310	IPT	0.0033	0.0041	0.0047	0.0053	0.0059
	1	Ap1 max 0.05 x D	980	-	1310	IPT	0.0033	0.0041	0.0047	0.0053	0.0059
	2	Ap1 max 0.05 x D	920	-	1250	IPT	0.0033	0.0041	0.0047	0.0053	0.0059
	3	Ap1 max 0.05 x D	790	-	1050	IPT	0.0027	0.0035	0.0041	0.0046	0.0054
	4	Ap1 max 0.05 x D	590	-	980	IPT	0.0025	0.0031	0.0036	0.0040	0.0046
	5	Ap1 max 0.05 x D	390	-	660	IPT	0.0022	0.0028	0.0033	0.0037	0.0043
M	6	Ap1 max 0.05 x D	330	-	490	IPT	0.0018	0.0023	0.0027	0.0030	0.0034
	1	Ap1 max 0.05 x D	590	-	750	IPT	0.0027	0.0035	0.0041	0.0046	0.0054
	2	Ap1 max 0.05 x D	390	-	520	IPT	0.0022	0.0028	0.0033	0.0037	0.0043
K	3	Ap1 max 0.05 x D	390	-	460	IPT	0.0018	0.0023	0.0027	0.0030	0.0034
	1	Ap1 max 0.05 x D	790	-	980	IPT	0.0033	0.0041	0.0047	0.0053	0.0059
S	2	Ap1 max 0.05 x D	720	-	920	IPT	0.0027	0.0035	0.0041	0.0046	0.0054
	3	Ap1 max 0.05 x D	720	-	850	IPT	0.0022	0.0028	0.0033	0.0037	0.0043
	1	Ap1 max 0.05 x D	160	-	300	IPT	0.0023	0.0029	0.0034	0.0039	0.0045
H	2	Ap1 max 0.05 x D	80	-	130	IPT	0.0012	0.0015	0.0018	0.0021	0.0024
	3	Ap1 max 0.05 x D	80	-	130	IPT	0.0012	0.0015	0.0018	0.0021	0.0024
	4	Ap1 max 0.05 x D	160	-	200	IPT	0.0017	0.0021	0.0025	0.0028	0.0033
H	1	Ap1 max 0.05 x D	520	-	920	IPT	0.0025	0.0031	0.0036	0.0040	0.0046
	2	Ap1 max 0.06 x D	460	-	790	IPT	0.0018	0.0023	0.0027	0.0030	0.0034

NOTE: Lower value of cutting speed is used for high stock removal applications or for higher hardness (machinability) within group.  
 Higher value of cutting speed is used for finishing applications or for lower hardness (machinability) within group.  
 Above parameters are based on ideal conditions. For smaller taper machining centers, please adjust parameters accordingly on >1/2" diameter.

VariMill III ER • Series 7VNX • Application Data • WS15PE • Inch

Material Group	Side Milling (A)		WS15PE			Recommended feed per tooth (IPT = inch/th) for side milling (A).					
	A		Cutting Speed – vc SFM			D1 – Diameter					
	ap	ae	min		max	frac. dec.	3/8	1/2	5/8	3/4	1
	ap	ae	min		max	dec.	.3750	.5000	.6250	.7500	1.0000
P	4	1 x D 0.15 x D	300	-	490	IPT	0.0020	0.0026	0.0030	0.0034	0.0039
	5	1 x D 0.15 x D	200	-	330	IPT	0.0018	0.0023	0.0027	0.0031	0.0036
M	1	1 x D 0.15 x D	300	-	380	IPT	0.0023	0.0029	0.0034	0.0039	0.0045
	2	1 x D 0.15 x D	200	-	260	IPT	0.0018	0.0023	0.0027	0.0031	0.0036
	3	1 x D 0.15 x D	200	-	230	IPT	0.0015	0.0019	0.0022	0.0025	0.0028
S	1	1 x D 0.15 x D	160	-	300	IPT	0.0023	0.0029	0.0034	0.0039	0.0045
	2	1 x D 0.15 x D	80	-	130	IPT	0.0012	0.0015	0.0018	0.0021	0.0024
	3	1 x D 0.15 x D	80	-	130	IPT	0.0012	0.0015	0.0018	0.0021	0.0024
	4	1 x D 0.15 x D	160	-	200	IPT	0.0017	0.0021	0.0025	0.0028	0.0033
H	1	1 x D 0.15 x D	260	-	460	IPT	0.0020	0.0026	0.0030	0.0034	0.0039
	2	1 x D 0.15 x D	230	-	390	IPT	0.0015	0.0019	0.0022	0.0025	0.0028

NOTE: Lower value of cutting speed is used for high stock removal applications or for higher hardness (machinability) within group.  
 Higher value of cutting speed is used for finishing applications or for lower hardness (machinability) within group.  
 Above parameters are based on ideal conditions. For smaller taper machining centers, please adjust parameters accordingly on >1/2" diameter.

VariMill III ER • Series 7VNX • Application Data • WS15PE • Inch

Material Group	Side Milling (A)		WS15PE		Recommended feed per tooth (IPT = inch/th) for side milling (A).							
	A		Cutting Speed – vc			D1 – Diameter						
	ap	ae	min	max	frac. dec.	3/8	1/2	5/8	3/4	1		
	ap	ae	min	max	frac. dec.	3/8	1/2	5/8	3/4	1		
P	4	Ap1 max	0.06 x D	590	-	980	IPT	.0025	.0031	.0036	.0040	.0046
	5	Ap1 max	0.06 x D	390	-	660	IPT	.0022	.0028	.0033	.0037	.0043
M	1	Ap1 max	0.06 x D	590	-	750	IPT	.0027	.0035	.0041	.0046	.0054
	2	Ap1 max	0.06 x D	390	-	520	IPT	.0022	.0028	.0033	.0037	.0043
S	3	Ap1 max	0.06 x D	390	-	460	IPT	.0018	.0023	.0027	.0030	.0034
	1	Ap1 max	0.06 x D	160	-	300	IPT	.0023	.0029	.0034	.0039	.0045
	2	Ap1 max	0.06 x D	80	-	130	IPT	.0012	.0015	.0018	.0021	.0024
H	3	Ap1 max	0.06 x D	80	-	130	IPT	.0012	.0015	.0018	.0021	.0024
	4	Ap1 max	0.06 x D	160	-	200	IPT	.0017	.0021	.0025	.0028	.0033
H	1	Ap1 max	0.06 x D	520	-	920	IPT	.0025	.0031	.0036	.0040	.0046
	2	Ap1 max	0.06 x D	460	-	790	IPT	.0018	.0023	.0027	.0030	.0034

NOTE: Lower value of cutting speed is used for high stock removal applications or for higher hardness (machinability) within group.  
 Higher value of cutting speed is used for finishing applications or for lower hardness (machinability) within group.  
 Above parameters are based on ideal conditions. For smaller taper machining centers, please adjust parameters accordingly on >1/2" diameter.

VariMill III ER • Series 771E • Finishing • Application Data • WS15PE • Metric

Material Group	Side Milling (A)		WS15PE		Recommended feed per tooth (fz = mm/th) for side milling (A).									
	A		Cutting Speed – vc			D1 – Diameter								
	ap	ae	min	max	mm	10,0	12,0	14,0	16,0	18,0	20,0	25,0		
	ap	ae	min	max	mm	10,0	12,0	14,0	16,0	18,0	20,0	25,0		
P	4	Ap1 max	0,1 x D	90	-	150	fz	0,054	0,062	0,070	0,077	0,083	0,088	0,098
	5	Ap1 max	0,1 x D	60	-	100	fz	0,048	0,056	0,063	0,070	0,076	0,081	0,091
M	1	Ap1 max	0,1 x D	90	-	115	fz	0,061	0,070	0,079	0,087	0,095	0,101	0,114
	2	Ap1 max	0,1 x D	60	-	80	fz	0,048	0,056	0,063	0,070	0,076	0,081	0,091
S	3	Ap1 max	0,1 x D	60	-	70	fz	0,040	0,047	0,052	0,057	0,061	0,065	0,071
	1	Ap1 max	0,1 x D	50	-	90	fz	0,061	0,070	0,079	0,087	0,095	0,101	0,114
	2	Ap1 max	0,1 x D	25	-	40	fz	0,032	0,037	0,042	0,046	0,050	0,054	0,061
H	3	Ap1 max	0,1 x D	25	-	40	fz	0,032	0,037	0,042	0,046	0,050	0,054	0,061
	4	Ap1 max	0,1 x D	50	-	60	fz	0,045	0,052	0,058	0,064	0,069	0,074	0,084
H	1	Ap1 max	0,1 x D	80	-	140	fz	0,054	0,062	0,070	0,077	0,083	0,088	0,098
	2	Ap1 max	0,1 x D	70	-	120	fz	0,040	0,047	0,052	0,057	0,061	0,065	0,071

NOTE: Lower value of cutting speed is used for high stock removal applications or for higher hardness (machinability) within group.  
 Higher value of cutting speed is used for finishing applications or for lower hardness (machinability) within group.  
 Above parameters are based on ideal conditions. For smaller taper machining centers, please adjust parameters accordingly on >12mm diameters.

VariMill III ER • Series 771E • Semi-Finishing • Application Data • WS15PE • Metric

Material Group	Side Milling (A)		WS15PE			Recommended feed per tooth (fz = mm/th) for side milling (A).							
	A		Cutting Speed – vc			mm	D1 – Diameter						
	ap	ae	min	max	10,0		12,0	14,0	16,0	18,0	20,0	25,0	
	ap	ae	min	max	m/min	fz	fz	fz	fz	fz	fz	fz	
P	4	Ap1 max, 0,06 x D	180	-	300	fz	0,065	0,075	0,084	0,092	0,099	0,106	0,117
	5	Ap1 max, 0,06 x D	120	-	200	fz	0,058	0,067	0,076	0,084	0,091	0,097	0,109
M	1	Ap1 max, 0,06 x D	180	-	230	fz	0,073	0,084	0,095	0,105	0,113	0,121	0,137
	2	Ap1 max, 0,06 x D	120	-	160	fz	0,058	0,067	0,076	0,084	0,091	0,097	0,109
S	3	Ap1 max, 0,06 x D	120	-	140	fz	0,048	0,056	0,062	0,068	0,073	0,078	0,085
	1	Ap1 max, 0,06 x D	50	-	90	fz	0,061	0,070	0,079	0,087	0,095	0,101	0,114
	2	Ap1 max, 0,06 x D	25	-	40	fz	0,032	0,037	0,042	0,046	0,050	0,054	0,061
	4	Ap1 max, 0,06 x D	25	-	40	fz	0,032	0,037	0,042	0,046	0,050	0,054	0,061
H	1	Ap1 max, 0,06 x D	160	-	280	fz	0,065	0,075	0,084	0,092	0,099	0,106	0,117
	2	Ap1 max, 0,06 x D	140	-	240	fz	0,048	0,056	0,062	0,068	0,073	0,078	0,085



NOTE: Lower value of cutting speed is used for high stock removal applications or for higher hardness (machinability) within group.  
 Higher value of cutting speed is used for finishing applications or for lower hardness (machinability) within group.  
 Above parameters are based on ideal conditions. For smaller taper machining centers, please adjust parameters accordingly on >12mm diameters.

VariMill III ER • Series 772E • Application Data • WS15PE • Metric

Material Group	Side Milling (A)		WS15PE			Recommended feed per tooth (fz = mm/th) for side milling (A).							
	A		Cutting Speed – vc			mm	D1 – Diameter						
	ap	ae	min	max	10,0		12,0	14,0	16,0	18,0	20,0		
	ap	ae	min	max	m/min	fz	fz	fz	fz	fz	fz	fz	
P	0	Ap1 max, 0,05 x D	300	-	400	fz	0,086	0,099	0,111	0,121	0,130	0,137	
	1	Ap1 max, 0,05 x D	300	-	400	fz	0,086	0,099	0,111	0,121	0,130	0,137	
	2	Ap1 max, 0,05 x D	280	-	380	fz	0,086	0,099	0,111	0,121	0,130	0,137	
	3	Ap1 max, 0,05 x D	240	-	320	fz	0,073	0,084	0,095	0,105	0,113	0,121	
	4	Ap1 max, 0,05 x D	180	-	300	fz	0,065	0,075	0,084	0,092	0,099	0,106	
	5	Ap1 max, 0,05 x D	120	-	200	fz	0,058	0,067	0,076	0,084	0,091	0,097	
M	6	Ap1 max, 0,05 x D	100	-	150	fz	0,048	0,056	0,062	0,068	0,073	0,078	
	1	Ap1 max, 0,05 x D	180	-	230	fz	0,073	0,084	0,095	0,105	0,113	0,121	
K	2	Ap1 max, 0,05 x D	120	-	160	fz	0,058	0,067	0,076	0,084	0,091	0,097	
	3	Ap1 max, 0,05 x D	120	-	140	fz	0,048	0,056	0,062	0,068	0,073	0,078	
	1	Ap1 max, 0,05 x D	240	-	300	fz	0,086	0,099	0,111	0,121	0,130	0,137	
S	2	Ap1 max, 0,05 x D	220	-	280	fz	0,073	0,084	0,095	0,105	0,113	0,121	
	3	Ap1 max, 0,05 x D	220	-	260	fz	0,058	0,067	0,076	0,084	0,091	0,097	
	1	Ap1 max, 0,05 x D	50	-	90	fz	0,061	0,070	0,079	0,087	0,095	0,101	
	2	Ap1 max, 0,05 x D	25	-	40	fz	0,032	0,037	0,042	0,046	0,050	0,054	
H	3	Ap1 max, 0,05 x D	25	-	40	fz	0,032	0,037	0,042	0,046	0,050	0,054	
	4	Ap1 max, 0,05 x D	50	-	60	fz	0,045	0,052	0,058	0,064	0,069	0,074	
H	1	Ap1 max, 0,05 x D	160	-	280	fz	0,065	0,075	0,084	0,092	0,099	0,106	
	2	Ap1 max, 0,06 x D	140	-	240	fz	0,048	0,056	0,062	0,068	0,073	0,078	

NOTE: Lower value of cutting speed is used for high stock removal applications or for higher hardness (machinability) within group.  
 Higher value of cutting speed is used for finishing applications or for lower hardness (machinability) within group.  
 Above parameters are based on ideal conditions. For smaller taper machining centers, please adjust parameters accordingly on >12mm diameters.

VariMill III ER • Series 77NE • Application Data • WS15PE • Metric

Material Group													
	Side Milling (A)		WS15PE			Recommended feed per tooth (fz = mm/th) for side milling (A).							
	A		Cutting Speed – vc m/min			mm	D1 – Diameter						
	ap	ae	min	-	max		10,0	12,0	14,0	16,0	18,0	20,0	
P	4	1 x D	0,15 x D	90	-	150	fz	0,054	0,062	0,070	0,077	0,083	0,088
	5	1 x D	0,15 x D	60	-	100	fz	0,048	0,056	0,063	0,070	0,076	0,081
M	1	1 x D	0,15 x D	90	-	115	fz	0,061	0,070	0,079	0,087	0,095	0,101
	2	1 x D	0,15 x D	60	-	80	fz	0,048	0,056	0,063	0,070	0,076	0,081
	3	1 x D	0,15 x D	60	-	70	fz	0,040	0,047	0,052	0,057	0,061	0,065
S	1	1 x D	0,15 x D	50	-	90	fz	0,061	0,070	0,079	0,087	0,095	0,101
	2	1 x D	0,15 x D	25	-	40	fz	0,032	0,037	0,042	0,046	0,050	0,054
	3	1 x D	0,15 x D	25	-	40	fz	0,032	0,037	0,042	0,046	0,050	0,054
	4	1 x D	0,15 x D	50	-	60	fz	0,045	0,052	0,058	0,064	0,069	0,074
H	1	1 x D	0,15 x D	80	-	140	fz	0,054	0,062	0,070	0,077	0,083	0,088
	2	1 x D	0,15 x D	70	-	120	fz	0,040	0,047	0,052	0,057	0,061	0,065

NOTE: Lower value of cutting speed is used for high stock removal applications or for higher hardness (machinability) within group.  
 Higher value of cutting speed is used for finishing applications or for lower hardness (machinability) within group.  
 Above parameters are based on ideal conditions. For smaller taper machining centers, please adjust parameters accordingly on >12mm diameters.

INDEXABLE MILLING

SOLID END MILLING

HOLE/MAKING

TAPPING

TURNING

# VariMill™ Chip Splitter

## High-Performance Solid End Milling

VariMill Chip Splitter end mills shear chips to pieces, enabling the tool to efficiently dive into deep cavities while using dynamic milling strategies in stainless steel and superalloy applications.

### Features and Benefits

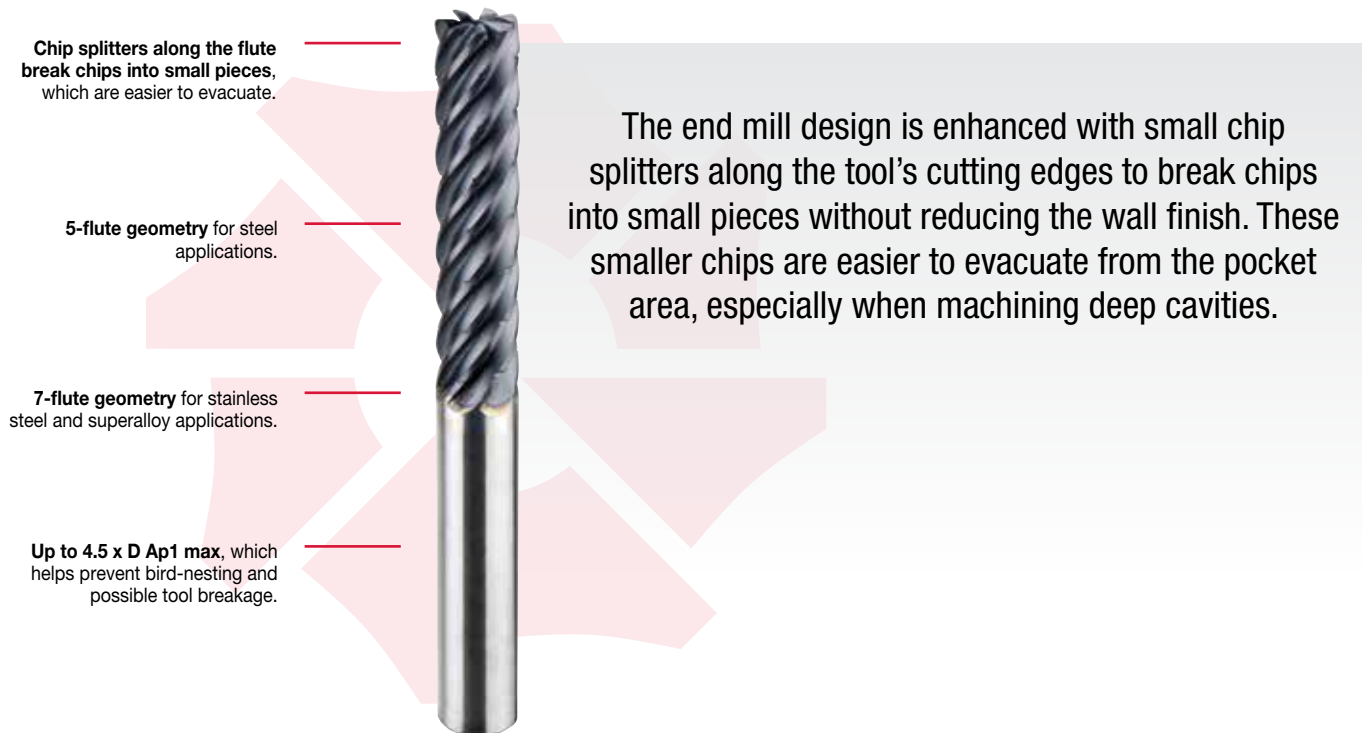

## ***DYNAMIC***

The end mill evacuates chips in dynamic milling operations with complex tool paths.

## ***EFFICIENT***

Operators can utilize the full feed rate, up to the machine's capacity, with the 5- and 7-flute end mill configurations. Dynamic milling processes are typically run using a low value of radial engagement, which generates a thin chip thickness enabling higher feed rate-per-tooth values and subsequently higher MRRs and productivity.

## ***STEADY***

No more machine downtime due to tool breakage and bad chip formation and evacuation. The machine will keep running as long as the tool has material to cut in dynamic and trochoidal milling processes.

# DYNAMIC CHIP FLOW

## PRODUCT

SOLID CARBIDE END MILL

GRADE

WP15PE  
WS15PE

FLUTE

5 & 7

DIAMETER RANGE

INCH

1/2-1"

METRIC

—

## INDUSTRY



GENERAL  
ENGINEERING



ENERGY



AEROSPACE

## APPLICATIONS

MATERIALS

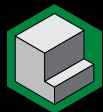

SIDE MILLING

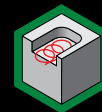

DYNAMIC  
MILLING



HELICAL  
INTERPOLATION



RAMPING



# Solid Carbide End Mills • VariMill™ Chip Splitter

INDEXABLE MILLING

## VariMill Chip Splitter • Series 570T • Radiused • 5 Flute • Cylindrical Shank • Inch

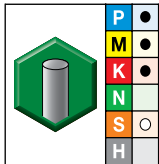
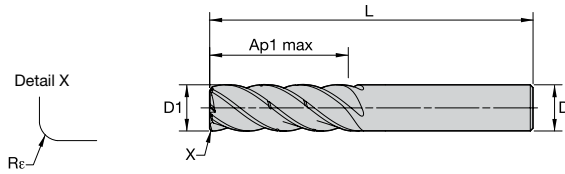

WP15PE

- first choice
- alternate choice

order #	catalog #	D1	D	length of cut Ap1 max	length L	Re	ZU
6853744	570TE13006RET	1/2	1/2	1 1/2	3 1/2	.030	5
6853747	570TE19009RET	3/4	3/4	2 1/4	5	.030	5
6853750	570TE2500ARET	1	1	2 1/4	5	.030	5

SOLID END MILLING

HOLEMAKING

## VariMill Chip Splitter • Series 571T • Radiused • 5 Flute • Cylindrical Shank • Inch

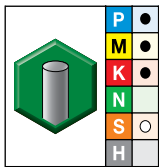
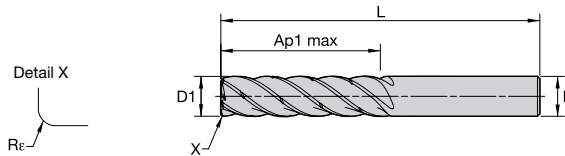

WP15PE

- first choice
- alternate choice

order #	catalog #	D1	D	length of cut Ap1 max	length L	Re	ZU
6853745	571TE13016RET	1/2	1/2	2	4	.030	5
6853748	571TE19019RET	3/4	3/4	3	6	.030	5
6853761	571TE2501ARET	1	1	3 1/2	6 1/2	.030	5

TAPPING

TURNING

## VariMill Chip Splitter • Series 572T • Radiused • 5 Flute • Cylindrical Shank • Inch

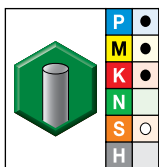
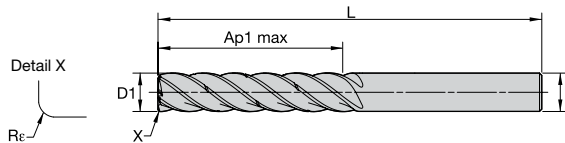

WP15PE

- first choice
- alternate choice

order #	catalog #	D1	D	length of cut Ap1 max	length L	Re	ZU
6853746	572TE13026RET	1/2	1/2	2 1/2	5	.030	5
6853749	572TE19029RET	3/4	3/4	4	7	.030	5
6853762	572TE2502ARET	1	1	4 1/2	7 1/2	.030	5



## VariMill Chip Splitter • Series 770T • Radiused • 7 Flute • Cylindrical Shank • Inch

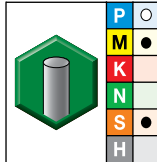
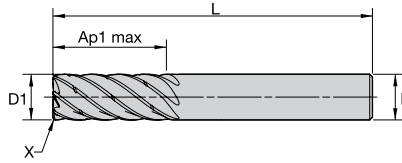
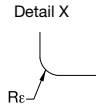

WS15PE

- first choice
- alternate choice

order #	catalog #	D1	D	length of cut Ap1 max	length L	Re	ZU
6853763	770TE13006RET	1/2	1/2	1 1/4	3 1/2	.030	7
6853764	770TE13006RGT	1/2	1/2	1 1/4	3 1/2	.060	7
6853795	770TE2500ARET	1	1	1 3/4	4 1/2	.030	7
6853796	770TE2500ARGT	1	1	1 3/4	4 1/2	.060	7
6853797	770TE2500ARKT	1	1	1 3/4	4 1/2	.120	7

## VariMill Chip Splitter • Series 771T • Radiused • 7 Flute • Cylindrical Shank • Inch

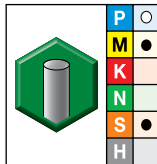
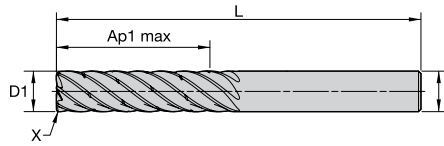
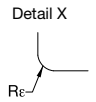

WS15PE

- first choice
- alternate choice

order #	catalog #	D1	D	length of cut Ap1 max	length L	Re	ZU
6853765	771TE13016RET	1/2	1/2	2 1/8	4 1/2	.030	7
6853766	771TE13016RGT	1/2	1/2	2 1/8	4 1/2	.060	7
6853769	771TE19019RET	3/4	3/4	2 1/4	5	.030	7
6853770	771TE19019RGT	3/4	3/4	2 1/4	5	.060	7
6853791	771TE19019RKT	3/4	3/4	2 1/4	5	.120	7
6853798	771TE2501ARET	1	1	2 1/4	5	.030	7
6853799	771TE2501ARGT	1	1	2 1/4	5	.060	7
6853800	771TE2501ARKT	1	1	2 1/4	5	.120	7

# Solid Carbide End Mills • VariMill™ Chip Splitter

INDEXABLE MILLING

## VariMill Chip Splitter • Series 772T • Radiused • 7 Flute • Cylindrical Shank • Inch

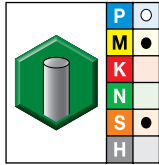
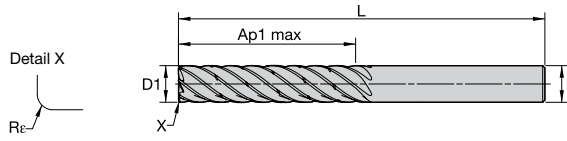

WS15PE

- first choice
- alternate choice

order #	catalog #	D1	D	length of cut Ap1 max	length L	Re	ZU
6853767	772TE13026RET	1/2	1/2	2 1/2	5	.030	7
6853768	772TE13026RGT	1/2	1/2	2 1/2	5	.060	7
6853792	772TE19029RET	3/4	3/4	3 3/4	7	.030	7
6853793	772TE19029RGT	3/4	3/4	3 3/4	7	.060	7
6853794	772TE19029RKT	3/4	3/4	3 3/4	7	.120	7
6853801	772TE2502ARET	1	1	3 1/2	6 1/2	.030	7
6853802	772TE2502ARGT	1	1	3 1/2	6 1/2	.060	7
6853803	772TE2502ARKT	1	1	3 1/2	6 1/2	.120	7

HOLEMAKING

## VariMill Chip Splitter • Series 773T • Radiused • 7 Flute • Cylindrical Shank • Inch

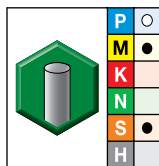
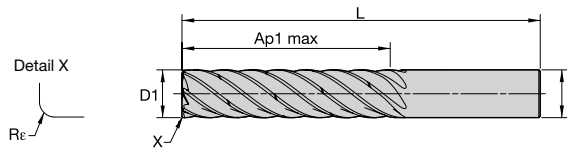

WS15PE

- first choice
- alternate choice

order #	catalog #	D1	D	length of cut Ap1 max	length L	Re	ZU
6853804	773TE2503ARET	1	1	4 1/2	7 1/2	.030	7
6853805	773TE2503ARGT	1	1	4 1/2	7 1/2	.060	7
6853806	773TE2503ARKT	1	1	4 1/2	7 1/2	.120	7

TAPPING

TURNING

VariMill Chip Splitter • Series 570T 571T 572T •  
Application Data • WP15PE • Inch • ae = 10% of D1

Material Group	Side Milling		WP15PE			Recommended feed per tooth (fz=IPT) for side milling at ae = 10% of D1						
	ap	ae	Cutting Speed – Vc (SFM)			D1 – Diameter						
			min	Start	max	fraction	3/8	1/2	5/8	3/4	1	
	P	0	ap max	0.1 x D1	880	1030	1180	IPT	.0034	.0039	.0048	.0054
1		ap max	0.1 x D1	880	1030	1180	IPT	.0034	.0039	.0048	.0054	.0059
2		ap max	0.1 x D1	830	990	1125	IPT	.0034	.0039	.0048	.0054	.0059
3		ap max	0.1 x D1	710	830	954	IPT	.0024	.0033	.0041	.0048	.0054
4		ap max	0.1 x D1	530	705	880	IPT	.0026	.0030	.0036	.0042	.0046
5		ap max	0.1 x D1	350	470	590	IPT	.0023	.0026	.0033	.0038	.0043
M	6	ap max	0.1 x D1	295	370	440	IPT	.0019	.0022	.0027	.0031	.0033
	1	ap max	0.1 x D1	530	600	675	IPT	.0029	.0033	.0041	.0048	.0054
	2	ap max	0.1 x D1	350	405	465	IPT	.0023	.0026	.0033	.0038	.0043
K	3	ap max	0.1 x D1	350	380	410	IPT	.0019	.0022	.0027	.0031	.0033
	1	ap max	0.1 x D1	710	795	880	IPT	.0034	.0039	.0048	.0054	.0059
	2	ap max	0.1 x D1	650	740	820	IPT	.0029	.0033	.0041	.0048	.0054
S	3	ap max	0.1 x D1	650	705	765	IPT	.0023	.0026	.0033	.0038	.0043
	1	ap max	0.1 x D1	295	410	530	IPT	.0029	.0033	.0041	.0048	.0054
	2	ap max	0.1 x D1	145	190	235	IPT	.0015	.0018	.0022	.0026	.0029
	3	ap max	0.1 x D1	145	190	235	IPT	.0015	.0018	.0022	.0026	.0029
H	4	ap max	0.1 x D1	295	320	350	IPT	.0021	.0024	.0030	.0035	.0039
	1	ap max	0.1 x D1	470	640	820	IPT	.0026	.0030	.0036	.0042	.0046
	2	ap max	0.1 x D1	415	560	710	IPT	.0019	.0022	.0027	.0031	.0033

VariMill Chip Splitter • Series 570T 571T 572T •  
Application Data • WP15PE • Inch • ae = 5% of D1

Material Group	Side Milling		WP15PE			Recommended feed per tooth (fz=IPT) for side milling at ae = 5% of D1						
	ap	ae	Cutting Speed – Vc (SFM)			D1 – Diameter						
			min	Start	max	fraction	3/8	1/2	5/8	3/4	1	
	P	0	ap max	0.05 x D1	980	1145	1310	IPT	.0050	.0050	.0060	.0070
1		ap max	0.05 x D1	980	1145	1310	IPT	.0050	.0050	.0060	.0070	.0080
2		ap max	0.05 x D1	920	1100	1250	IPT	.0050	.0050	.0060	.0070	.0080
3		ap max	0.05 x D1	790	920	1050	IPT	.0040	.0040	.0060	.0060	.0070
4		ap max	0.05 x D1	590	785	980	IPT	.0030	.0040	.0050	.0060	.0060
5		ap max	0.05 x D1	390	525	660	IPT	.0030	.0040	.0040	.0050	.0060
M	6	ap max	0.05 x D1	330	410	490	IPT	.0030	.0030	.0040	.0040	.0050
	1	ap max	0.05 x D1	590	670	750	IPT	.0040	.0040	.0060	.0060	.0070
	2	ap max	0.05 x D1	390	455	520	IPT	.0030	.0040	.0040	.0050	.0060
K	3	ap max	0.05 x D1	390	425	460	IPT	.0030	.0030	.0040	.0040	.0050
	1	ap max	0.05 x D1	790	885	980	IPT	.0050	.0050	.0060	.0070	.0080
	2	ap max	0.05 x D1	720	820	920	IPT	.0040	.0040	.0060	.0060	.0070
S	3	ap max	0.05 x D1	720	785	850	IPT	.0030	.0040	.0040	.0050	.0060
	1	ap max	0.05 x D1	330	460	590	IPT	.0040	.0040	.0060	.0060	.0070
	2	ap max	0.05 x D1	160	210	260	IPT	.0020	.0020	.0030	.0030	.0040
	3	ap max	0.05 x D1	160	210	260	IPT	.0020	.0020	.0030	.0030	.0040
H	4	ap max	0.05 x D1	330	360	390	IPT	.0030	.0030	.0040	.0050	.0050
	1	ap max	0.05 x D1	520	720	920	IPT	.0030	.0040	.0050	.0040	.0060
	2	ap max	0.05 x D1	460	625	790	IPT	.0030	.0030	.0040	.0040	.0050

# Solid Carbide End Mills • VariMill™ Chip Splitter

## VariMill Chip Splitter • Series 570T 571T 572T • Application Data • WP15PE • Inch • ae = 2% of D1

INDEXABLE MILLING

SOLID END MILLING

HOLEMAKING

TAPPING

TURNING

Material Group	Side Milling		WP15PE			Recommended feed per tooth (fz=IPT) for side milling at ae = 2% of D1						
	ap	ae	Cutting Speed – Vc (SFM)			D1 – Diameter						
			min	Start	max	fraction	3/8	1/2	5/8	3/4	1	
P	0	ap max	0.02 x D1	1000	1170	1330	IPT	.0070	.0080	.0090	.0011	.0110
	1	ap max	0.02 x D1	1000	1170	1330	IPT	.0070	.0080	.0090	.0011	.0110
	2	ap max	0.02 x D1	340	1120	1275	IPT	.0070	.0080	.0090	.0011	.0110
	3	ap max	0.02 x D1	805	940	1070	IPT	.0060	.0060	.0080	.0090	.0100
	4	ap max	0.02 x D1	600	800	1000	IPT	.0050	.0060	.0070	.0080	.0090
	5	ap max	0.02 x D1	400	535	670	IPT	.0040	.0050	.0060	.0070	.0080
M	6	ap max	0.02 x D1	335	420	500	IPT	.0040	.0040	.0050	.0060	.0070
	1	ap max	0.02 x D1	600	680	765	IPT	.0060	.0060	.0080	.0090	.0100
	2	ap max	0.02 x D1	400	460	530	IPT	.0040	.0050	.0060	.0070	.0080
K	3	ap max	0.02 x D1	400	430	470	IPT	.0040	.0040	.0050	.0060	.0070
	1	ap max	0.02 x D1	805	900	1000	IPT	.0070	.0080	.0090	.0110	.0110
	2	ap max	0.02 x D1	735	830	940	IPT	.0060	.0060	.0080	.0090	.0100
S	3	ap max	0.02 x D1	735	800	860	IPT	.0040	.0050	.0060	.0070	.0080
	1	ap max	0.02 x D1	330	470	600	IPT	.0060	.0060	.0080	.0090	.0100
	2	ap max	0.02 x D1	165	215	265	IPT	.0030	.0030	.0040	.0050	.0060
	3	ap max	0.02 x D1	165	215	265	IPT	.0030	.0030	.0040	.0050	.0060
H	4	ap max	0.02 x D1	330	360	390	IPT	.0040	.0050	.0060	.0070	.0080
	1	ap max	0.02 x D1	530	730	930	IPT	.0050	.0060	.0070	.0080	.0090
	2	ap max	0.02 x D1	470	630	800	IPT	.0040	.0040	.0050	.0060	.0070

## VariMill Chip Splitter • Series 770T 771T 772T 773T • Application Data • WS15PE • Inch • ae = 10% of D1

Material Group	Side Milling		WS15PE			Recommended feed per tooth (fz=IPT) for side milling at ae = 10% of D1						
	ap	ae	Cutting Speed – Vc (SFM)			D1 – Diameter						
			min	Start	max	fraction	3/8	1/2	5/8	3/4	1	
P	4	ap max	0.1 x D1	530	705	880	IPT	.0026	.0030	.0036	.0042	.0046
	5	ap max	0.1 x D1	350	470	590	IPT	.0023	.0026	.0033	.0038	.0043
	6	ap max	0.1 x D1	295	370	440	IPT	.0019	.0022	.0027	.0031	.0033
M	1	ap max	0.1 x D1	530	600	675	IPT	.0029	.0033	.0041	.0048	.0054
	2	ap max	0.1 x D1	350	405	465	IPT	.0023	.0026	.0033	.0038	.0043
	3	ap max	0.1 x D1	350	380	410	IPT	.0019	.0022	.0027	.0031	.0033
S	1	ap max	0.1 x D1	295	410	530	IPT	.0029	.0033	.0041	.0048	.0054
	2	ap max	0.1 x D1	145	190	235	IPT	.0015	.0018	.0022	.0026	.0029
	3	ap max	0.1 x D1	145	190	235	IPT	.0015	.0018	.0022	.0026	.0029
	4	ap max	0.1 x D1	295	320	350	IPT	.0021	.0024	.0030	.0035	.0039
H	1	ap max	0.1 x D1	470	640	820	IPT	.0026	.0030	.0036	.0042	.0046
	2	ap max	0.1 x D1	415	560	710	IPT	.0019	.0022	.0027	.0031	.0033

VariMill Chip Splitter • Series 770T 771T 772T 773T •  
Application Data • WS15PE • Inch • ae = 5% of D1

Material Group	Side Milling		WS15PE			Recommended feed per tooth (fz=IPT) for side milling at ae = 5% of D1						
	ap	ae	Cutting Speed – Vc (SFM)			D1 – Diameter						
			min	Start	max	fraction	3/8	1/2	5/8	3/4	1	
	P	4	ap max	0.05 x D1	590	785	980	IPT	.0030	.0040	.0050	.0060
5		ap max	0.05 x D1	390	525	660	IPT	.0030	.0040	.0040	.0050	.0060
6		ap max	0.05 x D1	330	410	490	IPT	.0030	.0030	.0040	.0040	.0050
M	1	ap max	0.05 x D1	590	670	750	IPT	.0040	.0040	.0060	.0060	.0070
	2	ap max	0.05 x D1	390	455	520	IPT	.0030	.0040	.0040	.0050	.0060
	3	ap max	0.05 x D1	390	425	460	IPT	.0030	.0030	.0040	.0040	.0050
S	1	ap max	0.05 x D1	330	460	590	IPT	.0040	.0040	.0060	.0060	.0070
	2	ap max	0.05 x D1	160	210	260	IPT	.0020	.0020	.0030	.0030	.0040
	3	ap max	0.05 x D1	160	210	260	IPT	.0020	.0020	.0030	.0030	.0040
	4	ap max	0.05 x D1	330	360	390	IPT	.0030	.0030	.0040	.0050	.0050
H	1	ap max	0.05 x D1	520	720	920	IPT	.0030	.0040	.0050	.0040	.0060
	2	ap max	0.05 x D1	460	625	790	IPT	.0030	.0030	.0040	.0040	.0050

VariMill Chip Splitter • Series 770T 771T 772T 773T •  
Application Data • WS15PE • Inch • ae = 2% of D1

Material Group	Side Milling		WS15PE			Recommended feed per tooth (fz=IPT) for side milling at ae = 2% of D1						
	ap	ae	Cutting Speed – Vc (SFM)			D1 – Diameter						
			min	Start	max	fraction	3/8	1/2	5/8	3/4	1	
	P	4	ap max	0.02 x D1	600	800	1000	IPT	.0050	.0060	.0070	.0080
5		ap max	0.02 x D1	400	535	670	IPT	.0040	.0050	.0060	.0070	.0080
6		ap max	0.02 x D1	335	420	500	IPT	.0040	.0040	.0050	.0060	.0070
M	1	ap max	0.02 x D1	600	680	765	IPT	.0060	.0060	.0080	.0090	.0100
	2	ap max	0.02 x D1	400	460	530	IPT	.0040	.0050	.0060	.0070	.0080
	3	ap max	0.02 x D1	400	430	470	IPT	.0040	.0040	.0050	.0060	.0070
S	1	ap max	0.02 x D1	330	470	600	IPT	.0060	.0060	.0080	.0090	.0100
	2	ap max	0.02 x D1	165	215	265	IPT	.0030	.0030	.0040	.0050	.0060
	3	ap max	0.02 x D1	165	215	265	IPT	.0030	.0030	.0040	.0050	.0060
	4	ap max	0.02 x D1	330	360	390	IPT	.0040	.0050	.0060	.0070	.0080
H	1	ap max	0.02 x D1	530	730	930	IPT	.0050	.0060	.0070	.0080	.0090
	2	ap max	0.02 x D1	470	630	800	IPT	.0040	.0040	.0050	.0060	.0070

# Roughers

## High-Performance Solid End Milling

The High-Performance Roughers group of products includes numerous end mills with chip breaker profiles to operate on multiple materials and in multiple end markets, providing effective chip control to reduce the spindle power and efficiently machine components when a high quantity of material needs to be removed. This group is designed with chip breaker profiles to operate on low-power machines or when the cutting conditions are not stable.

### Features and Benefits

**Chipbreaker profiles** to generate small and easy-to-evacuate chips.

**Center cut** for improved plunging and ramping applications.

**Different helix angles** to ensure the best performance and cutting actions on different materials categories.



The chip breaker profile on Rougher end mills helps reduce cutting forces and temperature increases, allowing the tool to perform operations longer. With different available shapes, the roughing profiles ensure the formation of small chips, which are easier to evacuate from the cutting area on different workpiece materials.

## ***SMOOTH***

The chipbreaker profile helps reduce cutting forces and the generation of high temperatures.

## ***EASY***

Small chips are easy to evacuate from the cutting area, increasing productivity and reducing machine downtime.

## ***FIRM***

The Roughers' end mills are the perfect tool when full slotting operations are the daily job.



# ROUGHING BEYOND THE LIMITS

## PRODUCT

SOLID CARBIDE END MILL

GRADE

WP15PE  
WS15PE  
TiAlN

FLUTE

3-6

DIAMETER RANGE

INCH

3/16-1"

METRIC

3-25mm

## INDUSTRY



GENERAL  
ENGINEERING



AEROSPACE



ENERGY



TRANSPORTATION

## APPLICATIONS

MATERIALS



SIDE MILLING

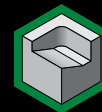

RAMPING



HELICAL  
INTERPOLATION



SLOTTING



DYNAMIC  
MILLING



PLUNGING



## Roughers • Series 4SOR • Chamfer • Inch

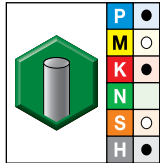
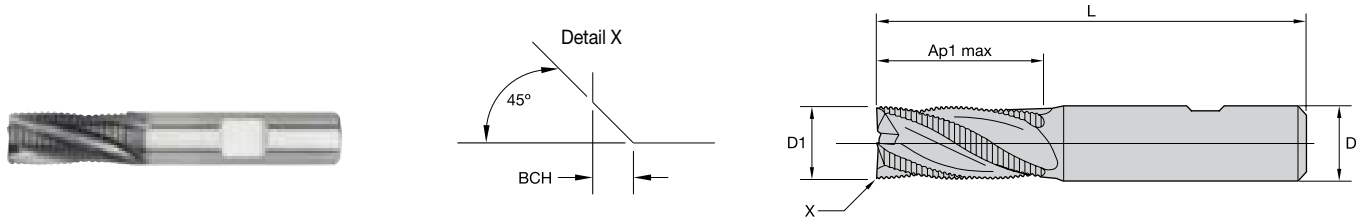

WP15PE

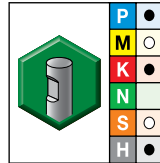

WP15PE

● first choice  
○ alternate choice

order #	catalog #	order #	catalog #	D1	D	length of cut Ap1 max	length L	BCH	ZU
-	-	2831385	TR4S4R07002	1/4	1/4	3/8	2	.012	3
5577389	4SOR07002NT	-	-	1/4	1/4	3/4	2 1/2	.012	3
-	-	1952552	TR4S4R10004	3/8	3/8	1/2	2	.020	4
-	-	5577390	4SOR10004NW	3/8	3/8	7/8	2 1/2	.020	4
-	-	1952593	TR4S4R13005	1/2	1/2	5/8	2 1/2	.020	4
-	-	5577391	4SOR13005NW	1/2	1/2	1	3	.020	4
-	-	2831360	TR4S4R16006	5/8	5/8	3/4	3	.020	4
-	-	5577392	4SOR16006NW	5/8	5/8	1 1/4	3 1/2	.020	4
-	-	2831355	TR4S4R19007	3/4	3/4	7/8	3 1/2	.020	4
-	-	5577393	4SOR19007NW	3/4	3/4	1 1/2	4	.020	4
-	-	5577395	4SOR25018NW	1	1	1 1/2	4	.020	4
-	-	5577394	4SOR25008NW	1	1	1 1/2	4	.020	5

## Roughers • Series 4MOR 4M4R • Radius • Inch

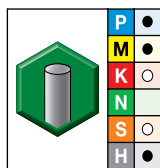
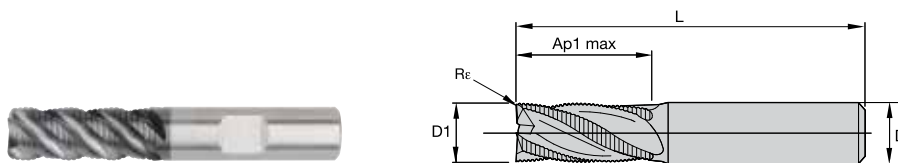

WP15PE

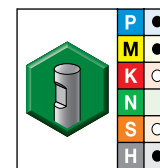

WP15PE

● first choice  
○ alternate choice

order #	catalog #	order #	catalog #	D1	D	length of cut Ap1 max	length L	Re	ZU
5577384	4M4R07002BT	-	-	1/4	1/4	3/8	2	.030	3
5577315	4M0R07002BT	-	-	1/4	1/4	3/4	2 1/2	.030	4
5577385	4M4R10004BT	-	-	3/8	3/8	1/2	2	.030	4
5577316	4M0R10004BT	-	-	3/8	3/8	7/8	2 1/2	.030	4
-	-	5577386	4M4R13005XW	1/2	1/2	5/8	2 1/2	.040	4
-	-	5577317	4M0R13005XW	1/2	1/2	1 1/4	3	.040	4
-	-	5577319	4M0R16016XW	5/8	5/8	1 1/4	3 1/2	.040	6
-	-	5577388	4M4R19009XW	3/4	3/4	7/8	3 1/2	.050	4
-	-	5577381	4M0R19017XW	3/4	3/4	1 1/2	4	.050	6
-	-	5577380	4M0R19007XW	3/4	3/4	1 1/2	4	.050	4
-	-	3321507	TM4M1R19017A	3/4	3/4	2 1/4	5	.050	6
-	-	5577383	4M0R25018XW	1	1	1 1/2	4	.050	6
-	-	5577382	4M0R25008XW	1	1	1 1/2	4	.050	4
-	-	3099533	TM4M1R25018A	1	1	2 1/4	5	.050	6

## Roughers • Series 4QN3 • Radius • Neck • Inch

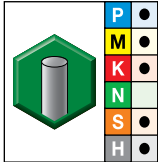
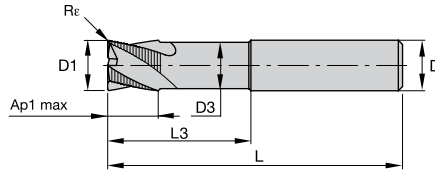

TiAlN-LT

- first choice
- alternate choice

order #	catalog #	D1	D	D3	length of cut Ap1 max	L3	length L	Re	ZU
2837886	TF4QN310014A	3/8	3/8	.35	1/2	2 1/4	4	.020	3
2837870	TF4QN313005A	1/2	1/2	.47	5/8	2 1/4	5	.030	3
2837826	TF4QN319007A	3/4	3/4	.71	1	2 1/4	5	.030	3

## Roughers • Series 4Q03 4Q05 4Q43 • Radius • Inch

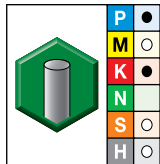
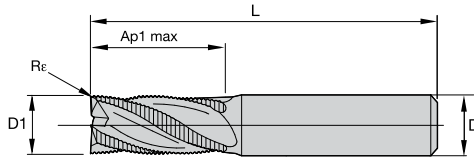

WP15PE

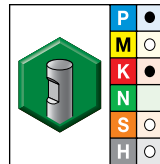

WP15PE

- first choice
- alternate choice

order #	catalog #	order #	catalog #	D1	D	length of cut Ap1 max	length L	Re	ZU
5576674	4Q0305000XT	5576744	4Q4305000XW	3/16	3/16	5/16	2	.010	3
-	-	-	-	3/16	3/16	5/8	2	.010	3
-	-	5576675	4Q0307002XW	1/4	1/4	3/4	2 1/2	.020	3
-	-	5576747	4Q4310014XW	3/8	3/8	1/2	2	.020	3
-	-	5576677	4Q0310014XW	3/8	3/8	1	2 1/2	.020	3
-	-	5576678	4Q0313015BW	1/2	1/2	1 1/4	3	.030	3
-	-	5576679	4Q0316006BW	5/8	5/8	1 5/8	3 1/2	.030	3
-	-	5576750	4Q4319017BW	3/4	3/4	1	3 1/2	.030	3
-	-	5576743	4Q0525008BW	1	1	2	4	.030	4

## Roughers • Series 4U50 • Radius • Inch

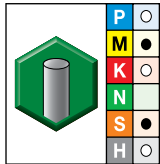
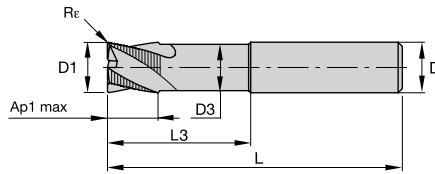

WS15PE

- first choice
- alternate choice

order #	catalog #	D1	D	D3	length of cut Ap1 max	L3	length L	Re	ZU
6441870	4U50E0700R2BT	1/4	1/4	.24	3/8	.75	2 1/2	.030	4
6441871	4U50E1000R4BT	3/8	3/8	.35	1/2	1.13	3	.030	4
6441872	4U50E1300R5BT	1/2	1/2	.47	5/8	1.50	3 1/2	.030	4
6441873	4U50E1601R6BT	5/8	5/8	.59	5/8	1.88	4	.030	6
6441874	4U50E1901R7XT	3/4	3/4	.71	3/4	2.25	4 1/2	.050	6
6441875	4U50E2501R8XT	1	1	.94	1	3.00	5 1/2	.050	6

## Roughers • Series 4U80 • Radius • Inch

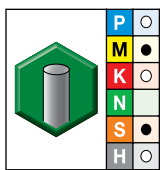
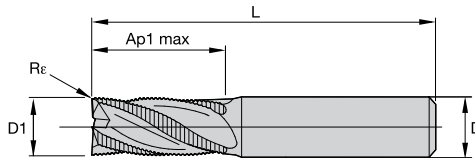

WS15PE

- first choice
- alternate choice

order #	catalog #	D1	D	length of cut Ap1 max	length L	Re	ZU
6441861	4U80E0700R2BT	1/4	1/4	3/4	2 1/2	.030	4
6441862	4U80E0800R3BT	5/16	5/16	13/16	2 1/2	.030	4
6441863	4U80E1000R4BT	3/8	3/8	7/8	2 1/2	.030	4
6441864	4U80E1300R5BT	1/2	1/2	1 1/4	3	.030	4
6441865	4U80E1600R6BT	5/8	5/8	1 7/8	4	.030	6
6441866	4U80E1900R7XT	3/4	3/4	1 1/2	4	.050	4
6441867	4U80E1901R7XT	3/4	3/4	1 1/2	4	.050	6
6441868	4U80E2500R8XT	1	1	1 1/2	4	.050	4
6441869	4U80E2501R8XT	1	1	1 1/2	4	.050	6

Roughers • Series 4906 • Chamfer • Metric

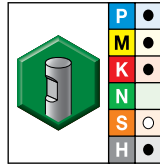
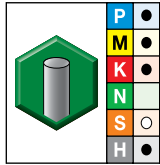
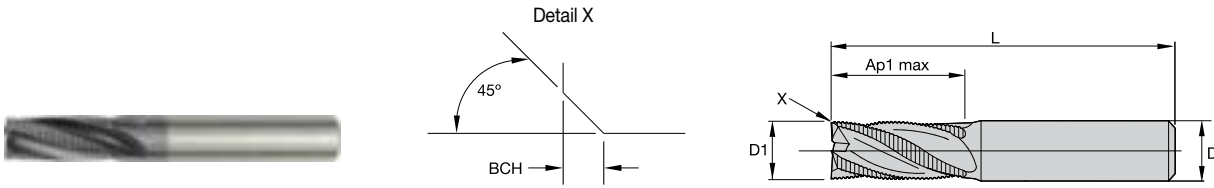

● first choice  
○ alternate choice

WP15PE		WP15PE		D1	D	length of cut Ap1 max	length L	BCH	ZU
order #	catalog #	order #	catalog #						
1657001	490604002RT	1657002	490604002RW	4,0	6	11,00	55	0,30	3
1657009	490605002RT	1657010	490605002RW	5,0	6	13,00	57	0,30	3
1657018	490606002RT	1657019	490606002RW	6,0	6	13,00	57	0,30	3
3133084	490607003RT	1657025	490607003RW	7,0	8	16,00	63	0,30	3
1657033	490608003RT	1657034	490608003RW	8,0	8	16,00	63	0,30	3
1657050	490610004RT	1657051	490610004RW	10,0	10	22,00	72	0,50	4
3133086	490611005RT	—	—	11,0	12	26,00	83	0,50	4
1657063	490612005RT	1657064	490612005RW	12,0	12	26,00	83	0,50	4
—	—	1657085	490614014RW	14,0	14	26,00	83	0,50	4
1657096	490616006RT	1657097	490616006RW	16,0	16	32,00	92	0,50	4
1657112	490620007RT	1657113	490620007RW	20,0	20	38,00	104	0,50	4
—	—	1657121	490625008RW	25,0	25	45,00	121	0,50	5

Roughers • Series 4976 • Chamfer • Metric

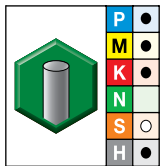
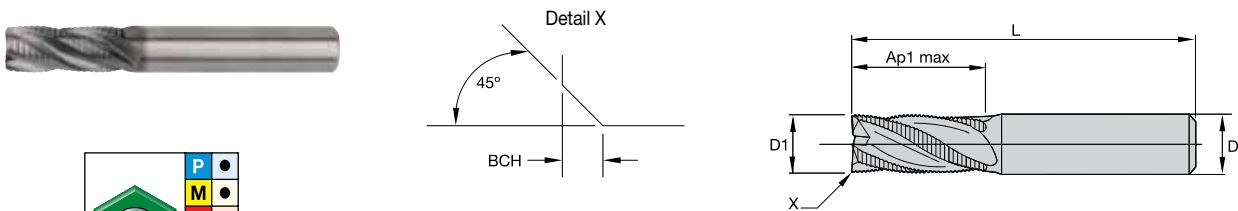

● first choice  
○ alternate choice

WP15PE		D1	D	length of cut Ap1 max	length L	BCH	ZU
order #	catalog #						
5560708	497604002T	4,0	6	8,00	57	0,30	3
5560709	497605002T	5,0	6	13,00	57	0,30	3
5560710	497606002T	6,0	6	13,00	57	0,30	3
5560711	497608003T	8,0	8	16,00	63	0,30	3
5560712	497610004T	10,0	10	22,00	72	0,50	4
5560713	497612005T	12,0	12	26,00	83	0,50	4
5560714	497614014T	14,0	14	26,00	83	0,50	4
5560715	497616006T	16,0	16	32,00	92	0,50	4
5560717	497620007T	20,0	20	38,00	104	0,50	4

## Roughers • Series 49N6 • Chamfer • Neck • Metric

INDEXABLE MILLING

SOLID END MILLING

HOLEMAKING

TAPPING

TURNING

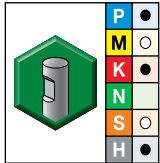
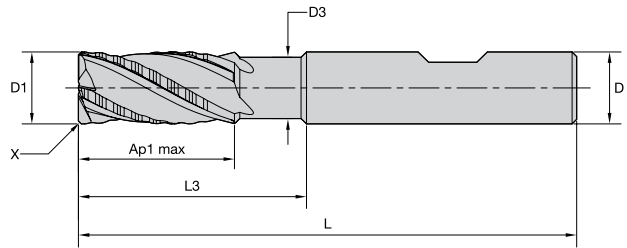
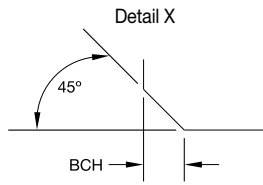

WP15PE

- first choice
- alternate choice

order #	catalog #	D1	D	D3	length of cut			BCH	ZU
					Ap1 max	L3	L		
3474585	49N606002MW	6,0	6	5,50	13,00	21,00	57	0,30	3
3474587	49N608003MW	8,0	8	7,50	16,00	27,00	63	0,30	3
3474589	49N610004MW	10,0	10	9,50	22,00	32,00	72	0,50	4
3474591	49N612005MW	12,0	12	11,00	26,00	38,00	83	0,50	4
3474594	49N616006MW	16,0	16	15,00	32,00	44,00	92	0,50	4
3474597	49N625008MW	25,0	25	24,00	45,00	65,00	121	0,50	5

## Roughers • Series 4U50 • Radius • Metric

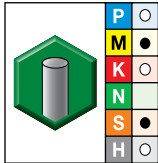
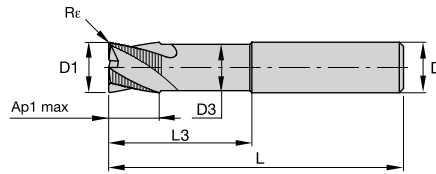

WS15PE

- first choice
- alternate choice

order #	catalog #	D1	D	D3	length of cut		length		Re	ZU
					Ap1 max	L3	L			
6431403	4U50M060R2TC	6,0	6	5,64	6,00	18,00	57	0,30	4	
6431404	4U50M080R3TC	8,0	8	7,52	8,00	24,00	63	0,30	4	
6431405	4U50M100R4TE	10,0	10	9,40	10,00	30,00	72	0,50	4	
6431406	4U50M120R5TE	12,0	12	11,28	12,00	36,00	83	0,50	4	
6431407	4U50M160R6TE	16,0	16	15,04	16,00	48,00	92	0,50	6	
6431408	4U50M200R7TG	20,0	20	18,80	20,00	60,00	104	1,00	6	
6431409	4U50M250R8TG	25,0	25	23,50	25,00	75,00	121	1,00	6	

## Roughers • Series 4U80 • Radius • Metric

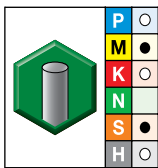
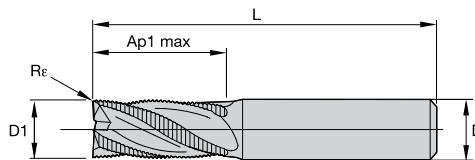

WS15PE

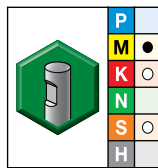

AITIN-MW

- first choice
- alternate choice

order #	catalog #	order #	catalog #	D1	D	length of cut		Re	ZU
						Ap1 max	L		
6431246	4U80M060R2TC	6652714	4U80M060R2WC	6,0	6	13,00	57	0,30	4
6431247	4U80M080R3TC	6652715	4U80M080R3WC	8,0	8	16,00	63	0,30	4
6431248	4U80M100R4TE	6652716	4U80M100R4WE	10,0	10	22,00	72	0,50	4
6431249	4U80M120R5TE	6652717	4U80M120R5WE	12,0	12	26,00	83	0,50	4
6431250	4U80M160R6TE	6652718	4U80M160R6WE	16,0	16	32,00	92	0,50	6
6431401	4U80M200R7TG	—	—	20,0	20	38,00	104	1,00	6
6431402	4U80M250R8TG	—	—	25,0	25	45,00	121	1,00	6

## Roughers • Series 4U40 • Radius • Metric

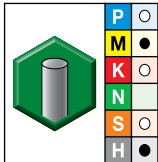
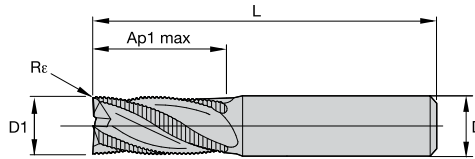

WP15PE

● first choice  
○ alternate choice

order #	catalog #	D1	D	length of cut Ap1 max	length L	R $\epsilon$	ZU
5583420	4U4008003T	8,0	8	8,00	63	0,75	4

## Roughers • Series 4U70 • Radius • Metric

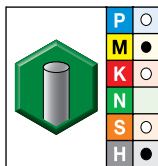
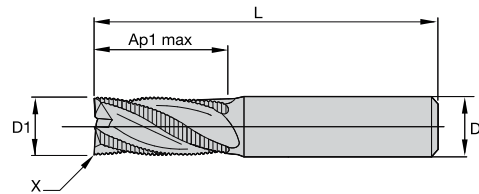
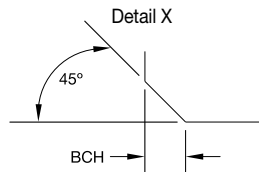
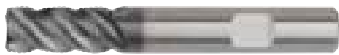

WP15PE

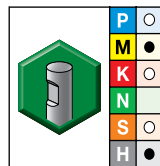

WP15PE

● first choice  
○ alternate choice

order #	catalog #	order #	catalog #	D1	D	length of cut Ap1 max	length L	BCH	ZU
—	—	5583436	4U7006002W	6,0	6	13,00	57	0,30	4
—	—	5583437	4U7008003W	8,0	8	16,00	63	0,40	4
—	—	5583439	4U7012005W	12,0	12	26,00	83	0,60	4
—	—	5583440	4U7016006W	16,0	16	32,00	92	0,60	6
5583431	4U7016046T	—	—	16,0	16	32,00	92	0,60	4
5583433	4U7020047T	—	—	20,0	20	38,00	104	1,00	4

## Roughers • Series DQ13 • Radius • Metric

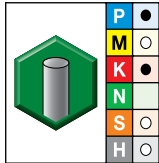
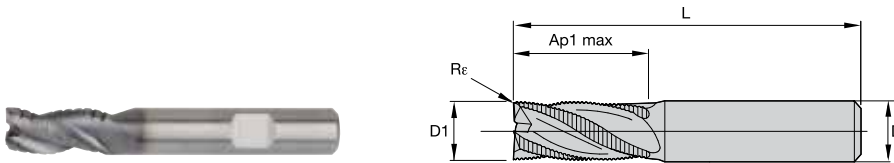

WP15PE

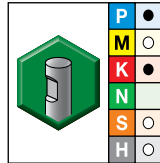

WP15PE

● first choice  
○ alternate choice

order #	catalog #	order #	catalog #	D1	D	length of cut Ap1 max	length L	R <sub>ε</sub>	ZU
5560534	DQ1303002T	5560536	DQ1303002W	3,0	6	7,00	54	0,25	3
5560535	DQ1304002T	-	-	4,0	6	8,00	57	0,25	3
-	-	5560538	DQ1305002W	5,0	6	10,00	57	0,25	3
-	-	5560539	DQ1306002W	6,0	6	10,00	57	0,45	3
-	-	5560701	DQ1308003W	8,0	8	16,00	63	0,45	3
-	-	5560702	DQ1310004W	10,0	10	19,00	72	0,45	3
-	-	5560703	DQ1312005W	12,0	12	22,00	83	0,45	3
-	-	5560704	DQ1314014W	14,0	14	22,00	83	0,45	3
-	-	5560705	DQ1316006W	16,0	16	32,00	92	0,45	3
-	-	5560706	DQ1318018W	18,0	18	32,00	92	0,45	3

## Roughers • Series 49H6 • Chamfer • Internal Coolant • Metric

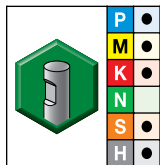
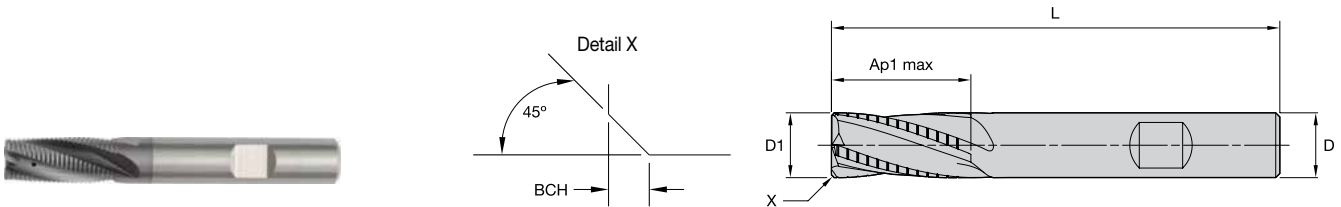

TiAlN-LW

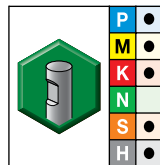

WP15PE

● first choice  
○ alternate choice

order #	catalog #	order #	catalog #	D1	D	length of cut Ap1 max	length L	BCH	ZU
-	-	1657264	49H610004RW	10,0	10	22,00	72	0,50	4
-	-	1657268	49H612005RW	12,0	12	26,00	83	0,50	4
1968206	49H614014LW	-	-	14,0	14	26,00	83	0,50	4
-	-	1657274	49H616006RW	16,0	16	32,00	92	0,50	4



## Roughers • Series 4940 • Radius • Metric

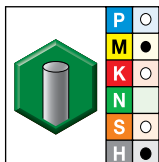
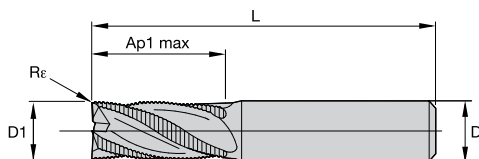

TIAIN-LT

- first choice
- alternate choice

order #	catalog #	D1	D	length of cut Ap1 max	length L	Re	ZU
1846543	494006002LT	6,0	6	6,00	57	0,75	4
1846544	494008003LT	8,0	8	8,00	63	0,75	4
1846545	494010004LT	10,0	10	10,00	72	0,75	4
1846546	494012005LT	12,0	12	12,00	83	1,00	4
1846547	494016006LT	16,0	16	16,00	92	1,00	6

Roughers • Series 4S0R • Application Data • WP15PE • Inch

Material Group	Side Milling (A) and Slotting (B)		WP15PE				Recommended feed per tooth (IPT = inch/th) for side milling (A). For slotting (B), reduce IPT by 20%.							
	A		B		Cutting Speed – vc SFM			D1 – Diameter						
	ap	ae	ap	min	max	frac. dec.	1/4	3/8	1/2	5/8	3/4	1		
	1 x D	0.5 x D	0.5 x D											
P	0	1 x D	0.5 x D	0.5 x D	490	-	660	IPT	.0015	.0022	.0027	.0032	.0035	.0039
	1	1 x D	0.5 x D	0.5 x D	490	-	660	IPT	.0015	.0022	.0027	.0032	.0035	.0039
	2	1 x D	0.5 x D	0.5 x D	460	-	620	IPT	.0015	.0022	.0027	.0032	.0035	.0039
	3	1 x D	0.4 x D	0.5 x D	390	-	520	IPT	.0012	.0018	.0023	.0027	.0031	.0036
	4	1 x D	0.3 x D	0.4 x D	300	-	490	IPT	.0011	.0016	.0021	.0024	.0027	.0031
M	1	1 x D	0.4 x D	0.5 x D	200	-	330	IPT	.0010	.0015	.0019	.0022	.0025	.0029
	2	1 x D	0.4 x D	0.5 x D	200	-	230	IPT	.0008	.0012	.0015	.0018	.0020	.0023
	3	1 x D	0.5 x D	0.3 x D	390	-	490	IPT	.0015	.0022	.0027	.0032	.0035	.0039
K	1	1 x D	0.4 x D	0.5 x D	360	-	460	IPT	.0012	.0018	.0023	.0027	.0031	.0036
	2	1 x D	0.4 x D	0.5 x D	360	-	430	IPT	.0010	.0015	.0019	.0022	.0025	.0029
S	1	1 x D	0.5 x D	0.3 x D	160	-	300	IPT	.0015	.0023	.0029	.0034	.0039	.0045
	3	1 x D	0.5 x D	0.4 x D	80	-	130	IPT	.0008	.0012	.0015	.0018	.0021	.0024
H	1	1 x D	0.3 x D	0.3 x D	260	-	460	IPT	.0011	.0016	.0021	.0024	.0027	.0031

NOTE: Lower value of cutting speed is used for high stock removal applications or for higher hardness (machinability) within group.  
Higher value of cutting speed is used for finishing applications or for lower hardness (machinability) within group.  
Above parameters are based on ideal conditions. For smaller taper machining centers, please adjust parameters accordingly on >1/2" diameter.

Roughers • Series 4M0R 4M4R • Application Data • WP15PE • Inch

Material Group	Side Milling (A) and Slotting (B)		WP15PE				Recommended feed per tooth (IPT = inch/th) for side milling (A). For slotting (B), reduce IPT by 20%.							
	A		B		Cutting Speed – vc SFM			D1 – Diameter						
	ap	ae	ap	min	max	frac. dec.	1/4	3/8	1/2	5/8	3/4	1		
	1 x D	0.5 x D	0.75 x D											
P	3	1 x D	0.5 x D	0.75 x D	390	-	520	IPT	.0015	.0023	.0029	.0034	.0039	.0045
	4	1 x D	0.3 x D	0.75 x D	300	-	490	IPT	.0014	.0020	.0026	.0030	.0034	.0039
	5	1 x D	0.5 x D	0.75 x D	200	-	330	IPT	.0012	.0018	.0023	.0027	.0031	.0036
	6	1 x D	0.3 x D	0.3 x D	160	-	250	IPT	.0010	.0015	.0019	.0022	.0025	.0028
M	1	1 x D	0.5 x D	0.75 x D	300	-	380	IPT	.0015	.0023	.0029	.0034	.0039	.0045
	2	1 x D	0.5 x D	0.75 x D	200	-	260	IPT	.0012	.0018	.0023	.0027	.0031	.0036
	3	1 x D	0.5 x D	0.75 x D	200	-	230	IPT	.0010	.0015	.0019	.0022	.0025	.0028
K	1	1 x D	0.5 x D	1 x D	390	-	490	IPT	.0018	.0027	.0034	.0040	.0044	.0049
	2	1 x D	0.5 x D	1 x D	360	-	460	IPT	.0015	.0023	.0029	.0034	.0039	.0045
	3	1 x D	0.5 x D	1 x D	360	-	430	IPT	.0012	.0018	.0023	.0027	.0031	.0036
S	1	1 x D	0.3 x D	0.75 x D	160	-	300	IPT	.0015	.0023	.0029	.0034	.0039	.0045
	2	1 x D	0.3 x D	0.3 x D	80	-	130	IPT	.0008	.0012	.0015	.0018	.0021	.0024
	3	1 x D	0.4 x D	0.75 x D	80	-	130	IPT	.0008	.0012	.0015	.0018	.0021	.0024
	4	1 x D	0.4 x D	0.75 x D	160	-	200	IPT	.0011	.0017	.0021	.0025	.0028	.0033
H	1	1 x D	0.3 x D	0.3 x D	260	-	460	IPT	.0014	.0020	.0026	.0030	.0034	.0039
	2	1 x D	0.2 x D	0.2 x D	230	-	390	IPT	.0010	.0015	.0019	.0022	.0025	.0028
	3	1 x D	0.2 x D	0.2 x D	200	-	300	IPT	.0008	.0012	.0015	.0018	.0021	.0024

NOTE: Lower value of cutting speed is used for high stock removal applications or for higher hardness (machinability) within group.  
Higher value of cutting speed is used for finishing applications or for lower hardness (machinability) within group.  
Above parameters are based on ideal conditions. For smaller taper machining centers, please adjust parameters accordingly on >1/2" diameter.

## Roughers • Series 4QN3 • Application Data • TiAlN-LT • Inch

Material Group	Side Milling (A) and Slotting (B)			TiAlN			Recommended feed per tooth (IPT = inch/th) for side milling (A). For slotting (B), reduce IPT by 20%.						
	A		B	Cutting Speed – vc SFM			D1 – Diameter						
	ap	ae	ap	min	–	max	frac. dec.	1/4	3/8	1/2	5/8	3/4	
	1 x D	0.3 x D	0.5 x D				IPT	.2500	.3750	.5000	.6250	.7500	
P	1	1 x D	0.3 x D	0.5 x D	500	–	650	IPT	.0018	.0027	.0035	.0039	.0043
	2	1 x D	0.3 x D	0.5 x D	450	–	625	IPT	.0018	.0027	.0035	.0039	.0043
	3	1 x D	0.3 x D	0.5 x D	400	–	525	IPT	.0015	.0023	.0029	.0034	.0038
	4	1 x D	0.25 x D	0.25 x D	350	–	475	IPT	.0014	.0020	.0026	.0030	.0033
	5	1 x D	0.3 x D	0.5 x D	200	–	325	IPT	.0012	.0018	.0023	.0027	.0030
	6	1 x D	0.25 x D	0.25 x D	150	–	225	IPT	.0010	.0015	.0019	.0022	.0024
M	1	1 x D	0.3 x D	0.5 x D	250	–	325	IPT	.0015	.0023	.0029	.0034	.0038
	2	1 x D	0.3 x D	0.5 x D	190	–	260	IPT	.0012	.0018	.0023	.0027	.0030
	3	1 x D	0.3 x D	0.5 x D	200	–	260	IPT	.0010	.0015	.0019	.0022	.0024
K	1	1 x D	0.3 x D	0.5 x D	400	–	525	IPT	.0018	.0027	.0035	.0039	.0043
	2	1 x D	0.3 x D	0.5 x D	360	–	460	IPT	.0015	.0023	.0029	.0034	.0038
	3	1 x D	0.3 x D	0.5 x D	330	–	430	IPT	.0012	.0018	.0023	.0027	.0030
S	1	1 x D	0.25 x D	0.25 x D	160	–	300	IPT	.0015	.0023	.0029	.0034	.0039
	2	1 x D	0.25 x D	0.25 x D	80	–	130	IPT	.0008	.0012	.0015	.0018	.0021
	3	1 x D	0.3 x D	0.5 x D	80	–	130	IPT	.0008	.0012	.0015	.0018	.0021
	4	1 x D	0.3 x D	0.5 x D	160	–	200	IPT	.0011	.0017	.0021	.0025	.0028
H	1	1 x D	0.25 x D	0.25 x D	300	–	450	IPT	.0014	.0020	.0026	.0030	.0033

NOTE: Side milling applications – For longest reach (L3) tools, reduce ae by 30%.  
 Lower value of cutting speed is used for high stock removal applications or for higher hardness (machinability) within group.  
 Higher value of cutting speed is used for finishing applications or for lower hardness (machinability) within group.

## Roughers • Series 4Q03 4Q05 4Q43 • Application Data • WP15PE • Inch

Material Group	Side Milling (A) and Slotting (B)			WP15PE			Recommended feed per tooth (IPT = inch/th) for side milling (A). For slotting (B), reduce IPT by 20%.									
	A		B	Cutting Speed – vc SFM			D1 – Diameter									
	ap	ae	ap	min	–	max	frac. dec.	3/16	1/4	5/16	3/8	1/2	5/8	3/4	1	
	1 x D	0.5 x D	0.75 x D				IPT	.1875	.2500	.3125	.3750	.5000	.6250	.7500	1.0000	
P	0	1 x D	0.5 x D	0.75 x D	490	–	660	IPT	.0014	.0018	.0023	.0027	.0034	.0040	.0044	.0049
	1	1 x D	0.5 x D	0.75 x D	490	–	660	IPT	.0014	.0018	.0023	.0027	.0034	.0040	.0044	.0049
	2	1 x D	0.5 x D	0.75 x D	460	–	620	IPT	.0014	.0018	.0023	.0027	.0034	.0040	.0044	.0049
	3	1 x D	0.5 x D	0.75 x D	390	–	520	IPT	.0011	.0015	.0020	.0023	.0029	.0034	.0039	.0045
	4	1 x D	0.4 x D	0.5 x D	300	–	490	IPT	.0010	.0014	.0018	.0020	.0026	.0030	.0034	.0039
	5	1 x D	0.5 x D	0.75 x D	200	–	330	IPT	.0009	.0012	.0016	.0018	.0023	.0027	.0031	.0036
M	1	1 x D	0.4 x D	0.5 x D	160	–	250	IPT	.0008	.0010	.0013	.0015	.0019	.0022	.0025	.0028
	1	1 x D	0.5 x D	0.75 x D	300	–	380	IPT	.0011	.0015	.0020	.0023	.0029	.0034	.0039	.0045
	2	1 x D	0.4 x D	0.75 x D	200	–	260	IPT	.0009	.0012	.0016	.0018	.0023	.0027	.0031	.0036
K	1	1 x D	0.4 x D	0.75 x D	200	–	230	IPT	.0008	.0010	.0013	.0015	.0019	.0022	.0025	.0028
	1	1 x D	0.5 x D	0.75 x D	390	–	490	IPT	.0014	.0018	.0023	.0027	.0034	.0040	.0044	.0049
	2	1 x D	0.5 x D	0.75 x D	360	–	460	IPT	.0011	.0015	.0020	.0023	.0029	.0034	.0039	.0045
S	1	1 x D	0.4 x D	0.75 x D	360	–	430	IPT	.0009	.0012	.0016	.0018	.0023	.0027	.0031	.0036
	1	1 x D	0.3 x D	0.4 x D	160	–	300	IPT	.0011	.0015	.0020	.0023	.0029	.0034	.0039	.0045
	2	1 x D	0.3 x D	0.3 x D	80	–	130	IPT	.0006	.0008	.0010	.0012	.0015	.0018	.0021	.0024
H	3	1 x D	0.4 x D	0.75 x D	80	–	130	IPT	.0006	.0008	.0010	.0012	.0015	.0018	.0021	.0024
	4	1 x D	0.4 x D	0.75 x D	160	–	200	IPT	.0008	.0011	.0014	.0017	.0021	.0025	.0028	.0033
H	1	1 x D	0.2 x D	0.3 x D	260	–	460	IPT	.0010	.0014	.0018	.0020	.0026	.0030	.0034	.0039

NOTE: Lower value of cutting speed is used for high stock removal applications or for higher hardness (machinability) within group.  
 Higher value of cutting speed is used for finishing applications or for lower hardness (machinability) within group.  
 Above parameters are based on ideal conditions. For smaller taper machining centers, please adjust parameters accordingly on >1/2" diameter.

Roughers • Series 4U50 • Application Data • WS15PE • Inch

Material Group	Side Milling (A) and Slotting (B)		WS15PE				Recommended feed per tooth (IPT = inch/th) for side milling (A). For slotting (B), reduce IPT by 20%.								
	A		B		Cutting Speed – Vc SFM			D1 – Diameter							
	ap	ae	ap	min	max	frac. dec.	1/4	5/16	3/8	1/2	5/8	3/4	1		
	<b>M</b>	1	1 x D	0.5 x D	0.75 x D	297	–	379.5	IPT	.0015	.0020	.0023	.0029	.0034	.0038
	2	1 x D	0.5 x D	0.75 x D	198	–	264	IPT	.0012	.0016	.0018	.0023	.0027	.0030	.0036
	3	1 x D	0.5 x D	0.75 x D	198	–	231	IPT	.0010	.0013	.0015	.0019	.0022	.0024	.0028
<b>S</b>	1	1 x D	0.3 x D	0.75 x D	160	–	300	IPT	.0015	.0020	.0023	.0029	.0034	.0039	.0045
	2	1 x D	0.3 x D	0.3 x D	80	–	130	IPT	.0008	.0010	.0012	.0015	.0018	.0021	.0026
	3	1 x D	0.4 x D	0.75 x D	80	–	130	IPT	.0008	.0010	.0012	.0015	.0018	.0021	.0026
	4	1 x D	0.4 x D	0.75 x D	160	–	200	IPT	.0011	.0014	.0017	.0021	.0025	.0028	.0033

NOTE: Lower value of cutting speed is used for high-stock removal applications or for higher hardness (machinability) within group.  
 Higher value of cutting speed is used for finishing applications or for lower hardness (machinability) within group.  
 Above parameters are based on ideal conditions. For smaller taper machining centers, please adjust parameters accordingly on diameters greater than 1/2".

Roughers • Series 4U80 • Application Data • WS15PE • Inch

Material Group	Side Milling (A) and Slotting (B)		WS15PE				Recommended feed per tooth (IPT = inch/th) for side milling (A). For slotting (B), reduce IPT by 20%.								
	A		B		Cutting Speed – Vc SFM			D1 – Diameter							
	ap	ae	ap	min	max	frac. dec.	1/4	5/16	3/8	1/2	5/8	3/4	1		
	<b>M</b>	1	1 x D	0.5 x D	0.75 x D	290	–	380	IPT	.0015	.0020	.0023	.0029	.0034	.0038
	2	1 x D	0.5 x D	0.75 x D	200	–	265	IPT	.0012	.0016	.0018	.0023	.0027	.0030	.0036
	3	1 x D	0.5 x D	0.75 x D	200	–	230	IPT	.0010	.0013	.0015	.0019	.0022	.0024	.0028
<b>S</b>	1	1 x D	0.3 x D	0.75 x D	160	–	300	IPT	.0015	.0020	.0023	.0029	.0034	.0039	.0045
	2	1 x D	0.3 x D	0.3 x D	80	–	130	IPT	.0008	.0010	.0012	.0015	.0018	.0021	.0024
	3	1 x D	0.4 x D	0.75 x D	80	–	130	IPT	.0008	.0010	.0012	.0015	.0018	.0021	.0024
	4	1 x D	0.4 x D	0.75 x D	160	–	200	IPT	.0011	.0014	.0017	.0021	.0025	.0028	.0033

NOTE: Lower value of cutting speed is used for high-stock removal applications or for higher hardness (machinability) within group.  
 Higher value of cutting speed is used for finishing applications or for lower hardness (machinability) within group.  
 Above parameters are based on ideal conditions. For smaller taper machining centers, please adjust parameters accordingly on diameters greater than 1/2".

## Roughers • Series 4906 • Application Data • WP15PE • Metric

Material Group	Side Milling (A) and Slotting (B)			WP15PE		Recommended feed per tooth (fz = mm/th) for side milling (A). For slotting (B), reduce fz by 20%.															
	A		B	Cutting Speed – vc m/min			mm	D1 – Diameter													
	ap	ae	ap	min	max	4,0		5,0	6,0	8,0	10,0	12,0	14,0	16,0	18,0	20,0	25,0				
	ap	ae	ap	min	max	mm	4,0	5,0	6,0	8,0	10,0	12,0	14,0	16,0	18,0	20,0	25,0				
P	0	1,5 x D	0,5 x D	1 x D	150	–	200	fz	0,024	0,031	0,037	0,051	0,061	0,070	0,079	0,086	0,092	0,097	0,105		
	1	1,5 x D	0,5 x D	1 x D	150	–	200	fz	0,024	0,031	0,037	0,051	0,061	0,070	0,079	0,086	0,092	0,097	0,105		
	2	1,5 x D	0,5 x D	1 x D	140	–	190	fz	0,024	0,031	0,037	0,051	0,061	0,070	0,079	0,086	0,092	0,097	0,105		
	3	1,5 x D	0,4 x D	0,75 x D	120	–	160	fz	0,020	0,025	0,031	0,043	0,051	0,060	0,067	0,074	0,080	0,086	0,097		
	4	1,5 x D	0,3 x D	0,3 x D	90	–	150	fz	0,018	0,023	0,028	0,038	0,046	0,053	0,060	0,065	0,070	0,075	0,083		
M	1	1,5 x D	0,4 x D	0,75 x D	60	–	100	fz	0,016	0,021	0,025	0,034	0,041	0,048	0,054	0,059	0,064	0,069	0,077		
	2	1,5 x D	0,4 x D	0,75 x D	90	–	115	fz	0,020	0,025	0,031	0,043	0,051	0,060	0,067	0,074	0,080	0,086	0,097		
	3	1,5 x D	0,4 x D	0,75 x D	60	–	80	fz	0,016	0,021	0,025	0,034	0,041	0,048	0,054	0,059	0,064	0,069	0,077		
K	1	1,5 x D	0,4 x D	0,75 x D	60	–	70	fz	0,014	0,017	0,021	0,029	0,034	0,040	0,044	0,048	0,052	0,055	0,060		
	2	1,5 x D	0,5 x D	1 x D	120	–	150	fz	0,024	0,031	0,037	0,051	0,061	0,070	0,079	0,086	0,092	0,097	0,105		
	3	1,5 x D	0,4 x D	1 x D	110	–	140	fz	0,020	0,025	0,031	0,043	0,051	0,060	0,067	0,074	0,080	0,086	0,097		
S	1	1,5 x D	0,4 x D	1 x D	110	–	130	fz	0,016	0,021	0,025	0,034	0,041	0,048	0,054	0,059	0,064	0,069	0,077		
	2	1,5 x D	0,4 x D	0,75 x D	50	–	90	fz	0,023	0,030	0,036	0,050	0,061	0,070	0,079	0,087	0,095	0,101	0,114		
	3	1,5 x D	0,3 x D	0,3 x D	25	–	40	fz	0,013	0,016	0,019	0,026	0,032	0,037	0,042	0,046	0,050	0,054	0,061		
H	1	1,5 x D	0,3 x D	0,3 x D	80	–	140	fz	0,018	0,023	0,028	0,038	0,046	0,053	0,060	0,065	0,070	0,075	0,083		

NOTE: Lower value of cutting speed is used for high stock removal applications or for higher hardness (machinability) within group.  
Higher value of cutting speed is used for finishing applications or for lower hardness (machinability) within group.  
Above parameters are based on ideal conditions. For smaller taper machining centers, please adjust parameters accordingly on >12mm diameters.

## Roughers • Series 4976 • Application Data • WP15PE • Metric

Material Group	Side Milling (A) and Slotting (B)			WP15PE		Recommended feed per tooth (fz = mm/th) for side milling (A). For slotting (B), reduce fz by 20%.															
	A		B	Cutting Speed – vc m/min			mm	D1 – Diameter													
	ap	ae	ap	min	max	4,0		5,0	6,0	8,0	10,0	12,0	14,0	16,0	18,0	20,0	25,0				
	ap	ae	ap	min	max	mm	4,0	5,0	6,0	8,0	10,0	12,0	14,0	16,0	18,0	20,0	25,0				
P	0	1,5 x D	0,5 x D	1 x D	150	–	200	fz	0,028	0,036	0,044	0,060	0,072	0,083	0,092	0,101	0,108	0,114	0,124		
	1	1,5 x D	0,5 x D	1 x D	150	–	200	fz	0,028	0,036	0,044	0,060	0,072	0,083	0,092	0,101	0,108	0,114	0,124		
	2	1,5 x D	0,5 x D	1 x D	140	–	190	fz	0,028	0,036	0,044	0,060	0,072	0,083	0,092	0,101	0,108	0,114	0,124		
	3	1,5 x D	0,4 x D	0,75 x D	120	–	160	fz	0,023	0,030	0,036	0,050	0,061	0,070	0,079	0,087	0,095	0,101	0,114		
	4	1,5 x D	0,4 x D	0,75 x D	90	–	150	fz	0,021	0,027	0,033	0,045	0,054	0,062	0,070	0,077	0,083	0,088	0,098		
M	1	1,5 x D	0,4 x D	0,75 x D	60	–	100	fz	0,019	0,024	0,029	0,040	0,048	0,056	0,063	0,070	0,076	0,081	0,091		
	2	1,5 x D	0,4 x D	0,75 x D	90	–	115	fz	0,023	0,030	0,036	0,050	0,061	0,070	0,079	0,087	0,095	0,101	0,114		
	3	1,5 x D	0,4 x D	0,75 x D	60	–	80	fz	0,019	0,024	0,029	0,040	0,048	0,056	0,063	0,070	0,076	0,081	0,091		
K	1	1,5 x D	0,4 x D	0,75 x D	60	–	70	fz	0,016	0,020	0,025	0,034	0,040	0,047	0,052	0,057	0,061	0,065	0,071		
	2	1,5 x D	0,5 x D	1 x D	120	–	150	fz	0,028	0,036	0,044	0,060	0,072	0,083	0,092	0,101	0,108	0,114	0,124		
	3	1,5 x D	0,4 x D	1 x D	110	–	140	fz	0,023	0,030	0,036	0,050	0,061	0,070	0,079	0,087	0,095	0,101	0,114		
S	1	1,5 x D	0,4 x D	1 x D	110	–	130	fz	0,019	0,024	0,029	0,040	0,048	0,056	0,063	0,070	0,076	0,081	0,091		
	2	1,5 x D	0,3 x D	0,75 x D	50	–	90	fz	0,023	0,030	0,036	0,050	0,061	0,070	0,079	0,087	0,095	0,101	0,114		
	3	1,5 x D	0,3 x D	0,3 x D	25	–	40	fz	0,013	0,016	0,019	0,026	0,032	0,037	0,042	0,046	0,050	0,054	0,061		
H	1	1,5 x D	0,4 x D	0,75 x D	50	–	60	fz	0,016	0,021	0,026	0,037	0,045	0,052	0,058	0,064	0,069	0,074	0,084		
	2	1,5 x D	0,3 x D	0,3 x D	80	–	140	fz	0,021	0,027	0,033	0,045	0,054	0,062	0,070	0,077	0,083	0,088	0,098		
	3	1,5 x D	0,4 x D	0,75 x D	25	–	40	fz	0,013	0,016	0,019	0,026	0,032	0,037	0,042	0,046	0,050	0,054	0,061		

NOTE: Lower value of cutting speed is used for high stock removal applications or for higher hardness (machinability) within group.  
Higher value of cutting speed is used for finishing applications or for lower hardness (machinability) within group.  
Above parameters are based on ideal conditions. For smaller taper machining centers, please adjust parameters accordingly on >12mm diameters.

Roughers • Series 49N6 • Application Data • WP15PE • Metric

Material Group	Side Milling (A) and Slotting (B)			WP15PE		Recommended feed per tooth (fz = mm/th) for side milling (A). For slotting (B), reduce fz by 20%.															
	A		B	Cutting Speed – vc m/min		mm	D1 – Diameter														
	ap	ae	ap	min	max		4,0	5,0	6,0	8,0	10,0	12,0	14,0	16,0	18,0	20,0	25,0				
	1,5 x D	0,5 x D	1 x D			fz															
P	0	1,5 x D	0,5 x D	1 x D	150	–	200	fz	0,024	0,031	0,037	0,051	0,061	0,070	0,079	0,086	0,092	0,097	0,105		
	1	1,5 x D	0,5 x D	1 x D	150	–	200	fz	0,024	0,031	0,037	0,051	0,061	0,070	0,079	0,086	0,092	0,097	0,105		
	2	1,5 x D	0,5 x D	1 x D	140	–	190	fz	0,024	0,031	0,037	0,051	0,061	0,070	0,079	0,086	0,092	0,097	0,105		
	3	1,5 x D	0,4 x D	0,75 x D	120	–	160	fz	0,020	0,025	0,031	0,043	0,051	0,060	0,067	0,074	0,080	0,086	0,097		
	4	1,5 x D	0,3 x D	0,5 x D	90	–	150	fz	0,018	0,023	0,028	0,038	0,046	0,053	0,060	0,065	0,070	0,075	0,083		
M	5	1,5 x D	0,4 x D	0,75 x D	60	–	100	fz	0,016	0,021	0,025	0,034	0,041	0,048	0,054	0,059	0,064	0,069	0,077		
	1	1,5 x D	0,4 x D	0,75 x D	80	–	100	fz	0,020	0,025	0,031	0,043	0,051	0,060	0,067	0,074	0,080	0,086	0,097		
K	2	1,5 x D	0,4 x D	0,75 x D	60	–	80	fz	0,016	0,021	0,025	0,034	0,041	0,048	0,054	0,059	0,064	0,069	0,077		
	3	1,5 x D	0,4 x D	0,75 x D	60	–	80	fz	0,014	0,017	0,021	0,029	0,034	0,040	0,044	0,048	0,052	0,055	0,060		
S	1	1,5 x D	0,5 x D	1 x D	120	–	160	fz	0,024	0,031	0,037	0,051	0,061	0,070	0,079	0,086	0,092	0,097	0,105		
	2	1,5 x D	0,4 x D	1 x D	110	–	140	fz	0,020	0,025	0,031	0,043	0,051	0,060	0,067	0,074	0,080	0,086	0,097		
H	3	1,5 x D	0,4 x D	1 x D	100	–	130	fz	0,016	0,021	0,025	0,034	0,041	0,048	0,054	0,059	0,064	0,069	0,077		
	1	1,5 x D	0,4 x D	0,75 x D	50	–	90	fz	0,023	0,030	0,036	0,050	0,061	0,070	0,079	0,087	0,095	0,101	0,114		
	3	1,5 x D	0,4 x D	0,75 x D	25	–	40	fz	0,013	0,016	0,019	0,026	0,032	0,037	0,042	0,046	0,050	0,054	0,061		
	1	1,5 x D	0,3 x D	0,3 x D	80	–	140	fz	0,018	0,023	0,028	0,038	0,046	0,053	0,060	0,065	0,070	0,075	0,083		

NOTE: Lower value of cutting speed is used for high stock removal applications or for higher hardness (machinability) within group.  
 Higher value of cutting speed is used for finishing applications or for lower hardness (machinability) within group.  
 Above parameters are based on ideal conditions. For smaller taper machining centers, please adjust parameters accordingly on >12mm diameters.

Roughers • Series 4U50 • Application Data • WS15PE • Metric

Material Group	Side Milling (A) and Slotting (B)			WS15PE		Recommended feed per tooth (fz = mm/th) for side milling (A). For slotting (B), reduce fz by 20%.															
	A		B	Cutting Speed – Vc m/min		mm	D1 – Diameter														
	ap	ae	ap	min	max		6,0	8,0	10,0	12,0	14,0	16,0	18,0	20,0	25,0						
	0,8 x D	0,5 x D	0,75 x D			fz															
M	1	0,8 x D	0,5 x D	0,75 x D	90	–	115	fz	0,036	0,050	0,061	0,070	0,079	0,087	0,095	0,101	0,114				
	2	0,8 x D	0,4 x D	0,75 x D	60	–	80	fz	0,029	0,040	0,048	0,056	0,063	0,070	0,076	0,081	0,091				
	3	0,8 x D	0,4 x D	0,75 x D	60	–	70	fz	0,025	0,034	0,040	0,047	0,052	0,057	0,061	0,065	0,071				
S	1	0,8 x D	0,4 x D	0,75 x D	50	–	90	fz	0,036	0,050	0,061	0,070	0,079	0,087	0,095	0,101	0,114				
	2	0,8 x D	0,25 x D	0,3 x D	25	–	40	fz	0,019	0,026	0,032	0,037	0,042	0,046	0,050	0,054	0,061				
	3	0,8 x D	0,4 x D	0,75 x D	25	–	40	fz	0,019	0,026	0,032	0,037	0,042	0,046	0,050	0,054	0,061				
	4	0,8 x D	0,3 x D	0,3 x D	50	–	60	fz	0,026	0,037	0,045	0,052	0,058	0,064	0,069	0,074	0,084				

NOTE: Lower value of cutting speed is used for high stock removal applications or for higher hardness (machinability) within group.  
 Higher value of cutting speed is used for finishing applications or for lower hardness (machinability) within group.  
 Above parameters are based on ideal conditions. For smaller taper machining centers, please adjust parameters accordingly on diameters greater than 12mm.

## Roughers • Series 4U80 • Application Data • WS15PE • Metric

Material Group	Side Milling (A) and Slotting (B)		WS15PE/AlTiN-MW			Recommended feed per tooth (fz = mm/th) for side milling (A). For slotting (B), reduce fz by 20%.												
	A		B		Cutting Speed – Vc m/min			D1 – Diameter										
	ap	ae	ap	min	max	mm	6,0	8,0	10,0	12,0	14,0	16,0	18,0	20,0	25,0			
	1 x D	0,5 x D	0,75 x D	90	115	fz	0,036	0,050	0,061	0,070	0,079	0,087	0,095	0,101	0,114			
M	1	1 x D	0,5 x D	0,75 x D	90	115	fz	0,036	0,050	0,061	0,070	0,079	0,087	0,095	0,101	0,114		
	2	1 x D	0,5 x D	0,75 x D	60	80	fz	0,029	0,040	0,048	0,056	0,063	0,070	0,076	0,081	0,091		
	3	1 x D	0,5 x D	0,75 x D	60	70	fz	0,025	0,034	0,040	0,047	0,052	0,057	0,061	0,065	0,071		
S	1	1 x D	0,3 x D	0,75 x D	50	90	fz	0,036	0,050	0,061	0,070	0,079	0,087	0,095	0,101	0,114		
	2	1 x D	0,3 x D	0,3 x D	25	40	fz	0,019	0,026	0,032	0,037	0,042	0,046	0,050	0,054	0,061		
	3	1 x D	0,4 x D	0,75 x D	25	40	fz	0,019	0,026	0,032	0,037	0,042	0,046	0,050	0,054	0,061		
	4	1 x D	0,4 x D	0,75 x D	50	60	fz	0,026	0,037	0,045	0,052	0,058	0,064	0,069	0,074	0,084		

NOTE: Lower value of cutting speed is used for high stock removal applications or for higher hardness (machinability) within group.  
Higher value of cutting speed is used for finishing applications or for lower hardness (machinability) within group.  
Above parameters are based on ideal conditions. For smaller taper machining centers, please adjust parameters accordingly on diameters greater than 12mm.

## Roughers • Series 4U40 • Application Data • WP15PE • Metric

Material Group	Side Milling (A) and Slotting (B)		WP15PE			Recommended feed per tooth (fz = mm/th) for side milling (A). For slotting (B), reduce fz by 20%.												
	A		B		Cutting Speed – vc m/min			D1 – Diameter										
	ap	ae	ap	min	max	mm	6,0	8,0	10,0	12,0	16,0	20,0	25,0					
	0,8 x D	0,5 x D	0,75 x D	120	160	fz	0,036	0,050	0,061	0,070	0,087	0,101	0,114					
P	3	0,8 x D	0,5 x D	0,75 x D	120	160	fz	0,036	0,050	0,061	0,070	0,087	0,101	0,114				
	4	0,8 x D	0,4 x D	0,5 x D	90	150	fz	0,033	0,045	0,054	0,062	0,077	0,088	0,098				
	5	0,8 x D	0,5 x D	0,75 x D	60	100	fz	0,029	0,040	0,048	0,056	0,070	0,081	0,091				
M	1	0,8 x D	0,5 x D	0,75 x D	90	115	fz	0,036	0,050	0,061	0,070	0,087	0,101	0,114				
	2	0,8 x D	0,4 x D	0,75 x D	60	80	fz	0,029	0,040	0,048	0,056	0,070	0,081	0,091				
	3	0,8 x D	0,4 x D	0,75 x D	60	70	fz	0,025	0,034	0,040	0,047	0,057	0,065	0,071				
K	1	0,8 x D	0,5 x D	0,75 x D	120	150	fz	0,044	0,060	0,072	0,083	0,101	0,114	0,124				
	2	0,8 x D	0,5 x D	0,75 x D	110	140	fz	0,036	0,050	0,061	0,070	0,087	0,101	0,114				
	3	0,8 x D	0,4 x D	0,75 x D	110	130	fz	0,029	0,040	0,048	0,056	0,070	0,081	0,091				
S	1	0,8 x D	0,4 x D	0,75 x D	50	90	fz	0,036	0,050	0,061	0,070	0,087	0,101	0,114				
	2	0,8 x D	0,25 x D	0,3 x D	25	40	fz	0,019	0,026	0,032	0,037	0,046	0,054	0,061				
	3	0,8 x D	0,4 x D	0,75 x D	25	40	fz	0,019	0,026	0,032	0,037	0,046	0,054	0,061				
	4	0,8 x D	0,3 x D	0,5 x D	50	60	fz	0,026	0,037	0,045	0,052	0,058	0,064	0,074				
H	1	0,8 x D	0,5 x D	0,5 x D	80	140	fz	0,033	0,045	0,054	0,062	0,077	0,088	0,098				
	2	0,8 x D	0,2 x D	0,3 x D	70	120	fz	0,025	0,034	0,040	0,047	0,057	0,065	0,071				
	3	0,8 x D	0,15 x D	0,2 x D	60	90	fz	0,019	0,026	0,032	0,037	0,046	0,054	0,061				

NOTE: Lower value of cutting speed is used for high stock removal applications or for higher hardness (machinability) within group.  
Higher value of cutting speed is used for finishing applications or for lower hardness (machinability) within group.  
For rougher tool with 6 flutes, use ap in slotting 60% of table value.  
Above parameters are based on ideal conditions. For smaller taper machining centers, please adjust parameters accordingly on >12mm diameters.



Roughers • Series 4U70 • Application Data • WP15PE • Metric

Material Group	Side Milling (A) and Slotting (B)		WP15PE				Recommended feed per tooth (fz = mm/th) for side milling (A). For slotting (B), reduce fz by 20%.									
	A		B	Cutting Speed – vc m/min			mm	D1 – Diameter								
	ap	ae	ap	min	max	6,0		8,0	10,0	12,0	16,0	20,0	25,0			
	1 x D	0,5 x D	0,75 x D			fz										
P	3	1 x D	0,5 x D	0,75 x D	120	–	160	fz	0,036	0,050	0,061	0,070	0,087	0,101	0,114	
	4	1 x D	0,3 x D	0,75 x D	90	–	150	fz	0,033	0,045	0,054	0,062	0,077	0,088	0,098	
	5	1 x D	0,5 x D	0,75 x D	60	–	100	fz	0,029	0,040	0,048	0,056	0,070	0,081	0,091	
M	6	1 x D	0,3 x D	0,3 x D	50	–	75	fz	0,025	0,034	0,040	0,047	0,057	0,065	0,071	
	1	1 x D	0,5 x D	0,75 x D	90	–	115	fz	0,036	0,050	0,061	0,070	0,087	0,101	0,114	
	2	1 x D	0,5 x D	0,75 x D	60	–	80	fz	0,029	0,040	0,048	0,056	0,070	0,081	0,091	
K	3	1 x D	0,5 x D	0,75 x D	60	–	70	fz	0,025	0,034	0,040	0,047	0,057	0,065	0,071	
	1	1 x D	0,5 x D	1 x D	120	–	150	fz	0,044	0,060	0,072	0,083	0,101	0,114	0,124	
	2	1 x D	0,5 x D	1 x D	110	–	140	fz	0,036	0,050	0,061	0,070	0,087	0,101	0,114	
S	3	1 x D	0,5 x D	1 x D	110	–	130	fz	0,029	0,040	0,048	0,056	0,070	0,081	0,091	
	1	1 x D	0,3 x D	0,75 x D	50	–	90	fz	0,036	0,050	0,061	0,070	0,087	0,101	0,114	
	2	1 x D	0,3 x D	0,3 x D	25	–	40	fz	0,019	0,026	0,032	0,037	0,046	0,054	0,061	
	3	1 x D	0,4 x D	0,75 x D	25	–	40	fz	0,019	0,026	0,032	0,037	0,046	0,054	0,061	
H	4	1 x D	0,4 x D	0,75 x D	50	–	60	fz	0,026	0,037	0,045	0,052	0,064	0,074	0,084	
	1	1 x D	0,3 x D	0,3 x D	80	–	140	fz	0,033	0,045	0,054	0,062	0,077	0,088	0,098	
	2	1 x D	0,2 x D	0,2 x D	70	–	120	fz	0,025	0,034	0,040	0,047	0,057	0,065	0,071	
	3	1 x D	0,2 x D	0,2 x D	60	–	90	fz	0,019	0,026	0,032	0,037	0,046	0,054	0,061	

NOTE: Lower value of cutting speed is used for high stock removal applications or for higher hardness (machinability) within group.  
 Higher value of cutting speed is used for finishing applications or for lower hardness (machinability) within group.  
 For rougher tool with 6 flutes, use ap in slotting 60% of table value.  
 Above parameters are based on ideal conditions. For smaller taper machining centers, please adjust parameters accordingly on >12mm diameters.



Roughers • Series DQ13 • Application Data • WP15PE • Metric

Material Group	Side Milling (A) and Slotting (B)		WP15PE				Recommended feed per tooth (fz = mm/th) for side milling (A). For slotting (B), reduce fz by 20%.												
	A		B	Cutting Speed – vc m/min			mm	D1 – Diameter											
	ap	ae	ap	min	max	3,0		4,0	5,0	6,0	8,0	10,0	12,0	14,0	16,0	18,0	20,0		
	1 x D	0,5 x D	0,75 x D			fz													
P	0	1 x D	0,5 x D	0,75 x D	150	–	200	fz	0,021	0,028	0,036	0,044	0,060	0,072	0,083	0,092	0,101	0,108	0,114
	1	1 x D	0,5 x D	0,75 x D	150	–	200	fz	0,021	0,028	0,036	0,044	0,060	0,072	0,083	0,092	0,101	0,108	0,114
	2	1 x D	0,5 x D	0,75 x D	140	–	190	fz	0,021	0,028	0,036	0,044	0,060	0,072	0,083	0,092	0,101	0,108	0,114
	3	1 x D	0,5 x D	0,75 x D	120	–	160	fz	0,017	0,023	0,030	0,036	0,050	0,061	0,070	0,079	0,087	0,095	0,101
	4	1 x D	0,5 x D	0,5 x D	90	–	150	fz	0,016	0,021	0,027	0,033	0,045	0,054	0,062	0,070	0,077	0,083	0,088
	5	1 x D	0,5 x D	0,75 x D	60	–	100	fz	0,014	0,019	0,024	0,029	0,040	0,048	0,056	0,063	0,070	0,076	0,081
M	6	1 x D	0,4 x D	0,5 x D	50	–	75	fz	0,012	0,016	0,020	0,025	0,034	0,040	0,047	0,052	0,057	0,061	0,065
	1	1 x D	0,5 x D	0,75 x D	90	–	115	fz	0,017	0,023	0,030	0,036	0,050	0,061	0,070	0,079	0,087	0,095	0,101
	2	1 x D	0,4 x D	0,75 x D	60	–	80	fz	0,014	0,019	0,024	0,029	0,040	0,048	0,056	0,063	0,070	0,076	0,081
K	3	1 x D	0,4 x D	0,75 x D	60	–	70	fz	0,012	0,016	0,020	0,025	0,034	0,040	0,047	0,052	0,057	0,061	0,065
	1	1 x D	0,5 x D	0,75 x D	120	–	150	fz	0,021	0,028	0,036	0,044	0,060	0,072	0,083	0,092	0,101	0,108	0,114
	2	1 x D	0,5 x D	0,75 x D	110	–	140	fz	0,017	0,023	0,030	0,036	0,050	0,061	0,070	0,079	0,087	0,095	0,101
S	3	1 x D	0,4 x D	0,75 x D	110	–	130	fz	0,014	0,019	0,024	0,029	0,040	0,048	0,056	0,063	0,070	0,076	0,081
	1	1 x D	0,3 x D	0,4 x D	50	–	90	fz	0,009	0,013	0,016	0,019	0,026	0,032	0,037	0,042	0,046	0,050	0,054
	2	1 x D	0,3 x D	0,3 x D	25	–	40	fz	0,009	0,013	0,016	0,019	0,026	0,032	0,037	0,042	0,046	0,050	0,054
	3	1 x D	0,4 x D	0,75 x D	25	–	40	fz	0,009	0,013	0,016	0,019	0,026	0,032	0,037	0,042	0,046	0,050	0,054
H	4	1 x D	0,4 x D	0,75 x D	50	–	60	fz	0,011	0,016	0,021	0,026	0,037	0,045	0,052	0,058	0,064	0,069	0,074
	1	1 x D	0,2 x D	0,3 x D	80	–	140	fz	0,016	0,021	0,027	0,033	0,045	0,054	0,062	0,070	0,077	0,083	0,088

NOTE: Lower value of cutting speed is used for high stock removal applications or for higher hardness (machinability) within group.  
 Higher value of cutting speed is used for finishing applications or for lower hardness (machinability) within group.  
 Above parameters are based on ideal conditions. For smaller taper machining centers, please adjust parameters accordingly on >12mm diameters.





## Roughers • Series 49H6 • Application Data • WP15PE/TiAlN-LW • Metric

Material Group	 														
	Side Milling (A) and Slotting (B)			WP15PE/TiAlN			Recommended feed per tooth (fz = mm/th) for side milling (A). For slotting (B), reduce fz by 20%.								
	A		B	Cutting Speed – vc m/min			D1 – Diameter								
	ap	ae	ap	min	max	mm	8,0	10,0	12,0	14,0	16,0	18,0	20,0		
P	0	1,5 x D	0,5 x D	1 x D	150	–	200	fz	0,048	0,058	0,066	0,074	0,081	0,086	0,091
	1	1,5 x D	0,5 x D	1 x D	150	–	200	fz	0,048	0,058	0,066	0,074	0,081	0,086	0,091
	2	1,5 x D	0,5 x D	1 x D	140	–	190	fz	0,048	0,058	0,066	0,074	0,081	0,086	0,091
	3	1,0 x D	0,4 x D	0,75 x D	120	–	160	fz	0,040	0,048	0,056	0,063	0,070	0,076	0,081
	4	1,0 x D	0,3 x D	0,5 x D	90	–	150	fz	0,036	0,043	0,050	0,056	0,061	0,066	0,070
M	1	1,0 x D	0,4 x D	0,75 x D	60	–	100	fz	0,032	0,039	0,045	0,051	0,056	0,060	0,065
	2	1,0 x D	0,4 x D	0,75 x D	90	–	115	fz	0,040	0,048	0,056	0,063	0,070	0,076	0,081
	3	1,0 x D	0,4 x D	0,75 x D	60	–	80	fz	0,032	0,039	0,045	0,051	0,056	0,060	0,065
K	1	1,5 x D	0,5 x D	1 x D	60	–	70	fz	0,027	0,032	0,037	0,042	0,046	0,049	0,052
	2	1,5 x D	0,5 x D	1 x D	120	–	150	fz	0,048	0,058	0,066	0,074	0,081	0,086	0,091
	3	1,5 x D	0,4 x D	1 x D	110	–	140	fz	0,040	0,048	0,056	0,063	0,070	0,076	0,081
S	1	1,5 x D	0,4 x D	1 x D	110	–	130	fz	0,032	0,039	0,045	0,051	0,056	0,060	0,065
	2	1,5 x D	0,5 x D	0,75 x D	50	–	90	fz	0,050	0,061	0,070	0,079	0,087	0,095	0,101
	3	1,5 x D	0,5 x D	0,75 x D	25	–	40	fz	0,026	0,032	0,037	0,042	0,046	0,050	0,054
H	1	1,0 x D	0,3 x D	0,5 x D	80	–	140	fz	0,036	0,043	0,050	0,056	0,061	0,066	0,070

NOTE: Lower value of cutting speed is used for high-stock removal applications or for higher hardness (machinability) within group.  
Higher value of cutting speed is used for finishing applications or for lower hardness (machinability) within group.  
Above parameters are based on ideal conditions. For smaller taper machining centers, please adjust parameters accordingly on >12mm diameters.

## Roughers • Series 4940 • Application Data • TiAlN-LT • Metric

Material Group	 														
	A			TiAlN			Recommended feed per tooth (fz = mm/th) for side milling (A). For slotting (B), reduce fz by 20%.								
	A		B	Cutting Speed – vc m/min			D1 – Diameter								
	ap	ae	ap	min	max	mm	6,0	8,0	10,0	12,0	16,0	20,0	25,0		
P	3	0,8 x D	0,5 x D	0,75 x D	120	–	160	Fz	0,031	0,043	0,051	0,063	0,078	0,101	0,114
	4	0,8 x D	0,4 x D	0,5 x D	90	–	150	Fz	0,028	0,038	0,046	0,056	0,069	0,088	0,098
	5	0,8 x D	0,5 x D	0,75 x D	60	–	100	Fz	0,025	0,034	0,041	0,051	0,063	0,081	0,091
	6	0,8 x D	0,4 x D	0,5 x D	50	–	75	Fz	0,021	0,029	0,034	0,042	0,051	0,065	0,071
M	1	0,8 x D	0,5 x D	0,75 x D	80	–	100	Fz	0,031	0,043	0,051	0,063	0,078	0,101	0,114
	2	0,8 x D	0,4 x D	0,75 x D	60	–	80	Fz	0,025	0,034	0,041	0,051	0,063	0,081	0,091
	3	0,8 x D	0,4 x D	0,75 x D	60	–	80	Fz	0,021	0,029	0,034	0,042	0,051	0,065	0,071
K	1	0,8 x D	0,5 x D	0,75 x D	120	–	160	Fz	0,037	0,051	0,061	0,075	0,091	0,114	0,124
	2	0,8 x D	0,5 x D	0,75 x D	110	–	140	Fz	0,031	0,043	0,051	0,063	0,078	0,101	0,114
	3	0,8 x D	0,4 x D	0,75 x D	100	–	130	Fz	0,025	0,034	0,041	0,051	0,063	0,081	0,091
S	1	0,8 x D	0,4 x D	0,75 x D	50	–	90	Fz	0,036	0,050	0,061	0,070	0,087	0,101	0,114
	2	0,8 x D	0,25 x D	0,3 x D	25	–	40	Fz	0,019	0,026	0,032	0,037	0,046	0,054	0,061
	3	0,8 x D	0,4 x D	0,75 x D	25	–	40	Fz	0,019	0,026	0,032	0,037	0,046	0,054	0,061
	4	0,8 x D	0,3 x D	0,5 x D	50	–	60	Fz	0,026	0,037	0,045	0,052	0,064	0,074	0,084
H	1	0,8 x D	0,5 x D	0,5 x D	80	–	140	Fz	0,028	0,038	0,046	0,056	0,069	0,088	0,098
	2	0,8 x D	0,2 x D	0,3 x D	70	–	120	Fz	0,021	0,029	0,034	0,042	0,051	0,065	0,071
	3	0,8 x D	0,2 x D	0,2 x D	60	–	90	Fz	0,017	0,023	0,027	0,034	0,041	0,052	0,057

NOTE: Lower value of cutting speed is used for high-stock removal applications or for higher hardness (machinability) within group.  
Higher value of cutting speed is used for finishing applications or for lower hardness (machinability) within group.  
For rougher tool with 6 flutes, use ap in slotting 60% of table value.  
Above parameters are based on ideal conditions. For smaller taper machining centers, please adjust parameters accordingly on diameters greater than 12mm.



# Finishers

## High-Performance Solid End Milling

Use the Finishers end mill range to perform precise finishes (in both surface quality and dimension) to the final stages of component machining.

### Features and Benefits

**Center cutting** for improved floor finishing.

**Designed profiles with multiple flutes and higher helix** for super finishing applications.

**Unique geometries** designed to be material specific.



The Finishers end mill range was designed using carbide substrates with market-leading geometries and advanced surface technologies, delivering precise movements and smooth floor finishes to a range of components.

## ***PRECISE***

The Finishers end mill line will help CNC companies achieve optimal finishes in both surface quality and dimensions.

## ***COMPLETE***

From steel to cast iron and stainless steels, the Finishers offer material-specific end mills to complete component jobs.

## ***READY***

The Finishers end mill range is ready to make the final pass on critical finishing operations using specialized designs with a higher number of flutes and increased helix angles for super finishing applications.

# MIRROR FINISH

## PRODUCT

SOLID CARBIDE END MILL

GRADE

WP15PE  
TiAlN

FLUTE

2-8

DIAMETER RANGE

INCH

1/8-1"

METRIC

1-25mm

## INDUSTRY



GENERAL  
ENGINEERING



AEROSPACE



ENERGY



TRANSPORTATION

## APPLICATIONS

MATERIALS

P M K S H



SIDE MILLING



3D PROFILING

INDEXABLE MILLING

## Finishers • Series 4S07 • Sharp Edge • Inch

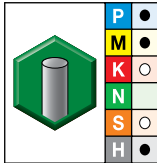
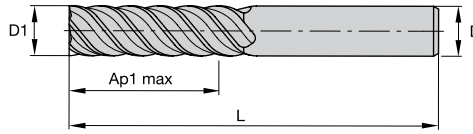

WP15PE

- first choice
- alternate choice

order #	catalog #	D1	D	length of cut Ap1 max	length L	ZU
5577255	4S0707002ST	1/4	1/4	3/4	2 1/2	6
5577256	4S0708003ST	5/16	5/16	13/16	2 1/2	6
5577254	4S0710004ST	3/8	3/8	7/8	2 1/2	6
5577258	4S0713005ST	1/2	1/2	1	3	6
5577259	4S0716006ST	5/8	5/8	1 1/4	3 1/2	6
5577260	4S0719007ST	3/4	3/4	1 1/2	4	6
5577261	4S0725008ST	1	1	1 1/2	4	6

SOLID END MILLING

HOLEMAKING

TAPPING

TURNING

## Finishers • Series 4S05 4S07 • Sharp Edge • Inch

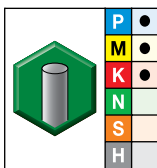
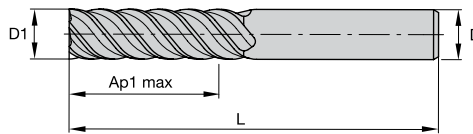

TICN-CT

- first choice
- alternate choice

order #	catalog #	D1	D	length of cut Ap1 max	length L	ZU
2841622	TC4S0707002	1/4	1/4	3/4	2 1/2	6
2841587	TC4S0719007	3/4	3/4	1 1/2	4	6

Finishers • Series 4C03 4C43 • Radius • Inch

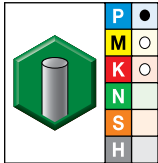
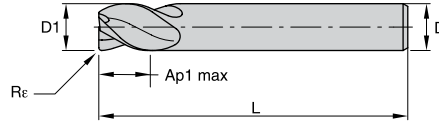

TiCN-CT

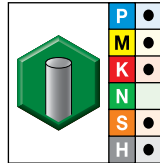

TiAlN

● first choice  
○ alternate choice

order #	catalog #	order #	catalog #	D1	D	length of cut Ap1 max	length L	Re	ZU
2842506	TC4C0303001A	-	-	1/8	1/8	1/2	1 1/2	.010	3
2842502	TC4C0305000A	-	-	3/16	3/16	5/8	2	.010	3
-	-	2831637	TR4C4307002A	1/4	1/4	1/2	2	.018	3
2842358	TC4C4308003A	-	-	5/16	5/16	7/16	2	.018	3
-	-	2831761	TR4C0319007A	3/4	3/4	1 1/2	4	.030	3

Finishers • Series 4C05 4C15 • Sharp Edge • Inch

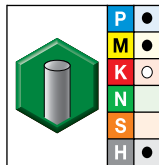
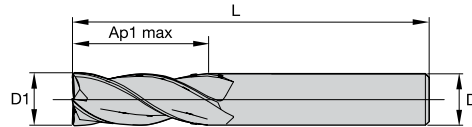
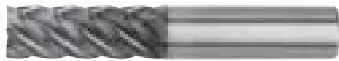

WP15PE

● first choice  
○ alternate choice

order #	catalog #	D1	D	length of cut Ap1 max	length L	ZU
5577187	4C0503001ST	1/8	1/8	1/2	1 1/2	5
5577188	4C0505000ST	3/16	3/16	5/8	2	5
5577189	4C0507002ST	1/4	1/4	3/4	2 1/2	5
5577247	4C1507002ST	1/4	1/4	1 1/4	4	5
5577241	4C0510004ST	3/8	3/8	7/8	2 1/2	5
5577249	4C1510004ST	3/8	3/8	1 1/2	4	5
5577242	4C0513005ST	1/2	1/2	1	3	5
5577243	4C0513015ST	1/2	1/2	1 1/4	3	5
5577250	4C1513005ST	1/2	1/2	2	4 1/2	5
5577244	4C0516006ST	5/8	5/8	1 1/4	3 1/2	5
5577245	4C0519007ST	3/4	3/4	1 1/2	4	5
5577252	4C1519007ST	3/4	3/4	2 1/4	5	5
5577253	4C1525008ST	1	1	2 1/4	5	5



INDEXABLE MILLING

## Finishers • Series 4SOF • Sharp Edge • Inch

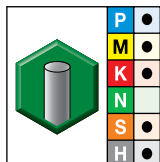
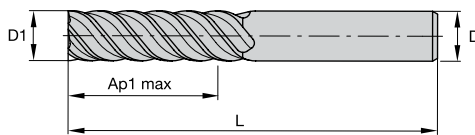

TiAIN-RT

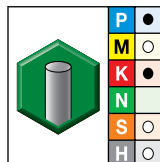

WP15PE

- first choice
- alternate choice

order #	catalog #	order #	catalog #	D1	D	length of cut Ap1 max	length L	Z U
-	-	3321647	TR4SOF19007	3/4	3/4	1 1/2	4	8

HOLEMAKING

## Finishers • Series DC03 • Radius • Metric

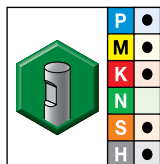
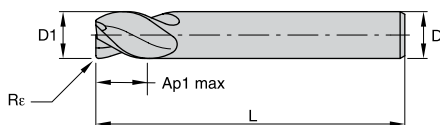

TiAIN-LW

- first choice
- alternate choice

order #	catalog #	D1	D	length of cut Ap1 max	length L	Re	ZU
1661856	DC0303002LW	3,0	6	4,00	50	0,25	3
1661858	DC0304002LW	4,0	6	5,00	54	0,25	3
1661862	DC0306002LW	6,0	6	7,00	54	0,45	3
1661866	DC0308003LW	8,0	8	9,00	58	0,45	3
1661868	DC0310004LW	10,0	10	11,00	66	0,45	3
1661870	DC0312005LW	12,0	12	12,00	73	0,45	3

TAPPING

TURNING

Finishers • Series 4603 • Sharp Edge • Metric

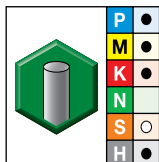
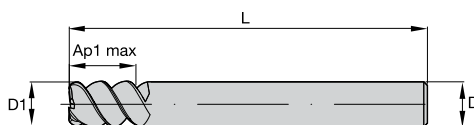

● first choice  
○ alternate choice

WP15PE

order #	catalog #	D1	D	length of cut Ap1 max	length L	Z U
1656750	460303002RT	3,0	6	8,00	57	3
1656758	460304002RT	4,0	6	11,00	57	3
1656773	460306002RT	6,0	6	13,00	57	3
1656781	460308003RT	8,0	8	19,00	63	3
1656791	460310004RT	10,0	10	22,00	72	3
1656799	460312005RT	12,0	12	26,00	83	3
1656807	460316006RT	16,0	16	32,00	92	3

INDEXABLE MILLING

SOLID END MILLING

HOLEMAKING

TAPPING

TURNING



## Finishers • Series D503 D513 • Square End • Metric

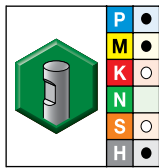
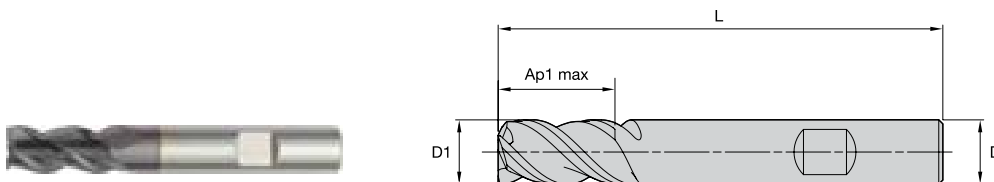

- first choice
- alternate choice

TIAlN

order #	catalog #	D1	D	length of cut Ap1 max	length L	Z U
1661574	D50302002RW	2,0	6	3,00	50	3
6613012	D503025C2W	2,5	6	3,00	50	3
6613013	D503030C2W	3,0	6	4,00	50	3
1661578	D50303002RW	3,0	6	4,00	50	3
1661680	D51303002RW	3,0	6	7,00	57	3
6613014	D513035C2W	3,5	6	7,00	57	3
6613015	D503040C2W	4,0	6	5,00	54	3
1661583	D50304002RW	4,0	6	5,00	54	3
1661684	D51304002RW	4,0	6	8,00	57	3
1661588	D50305002RW	5,0	6	6,00	54	3
1661688	D51305002RW	5,0	6	10,00	57	3
6613016	D503060C2W	6,0	6	7,00	54	3
1661593	D50306002RW	6,0	6	7,00	54	3
1661692	D51306002RW	6,0	6	10,00	57	3
1661603	D50308003RW	8,0	8	9,00	58	3
6613017	D503080C3W	8,0	8	9,00	58	3
1661701	D51308003RW	8,0	8	16,00	63	3
6613018	D503100C4W	10,0	10	11,00	66	3
1661710	D51310004RW	10,0	10	19,00	72	3
6613019	D503120C5W	12,0	12	12,00	73	3
1661715	D51312005RW	12,0	12	22,00	83	3
1661720	D51314014RW	14,0	14	22,00	83	3
1661725	D51316006RW	16,0	16	26,00	92	3

INDEXABLE MILLING

SOLID END MILLING

HOLEMAKING

TAPPING

TURNING

Finishers • Series D507 D517 • Sharp Edge • Metric

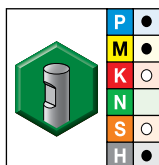
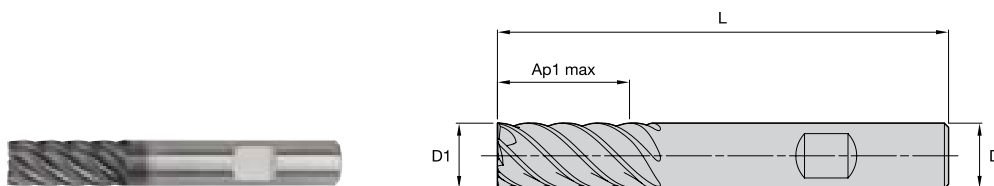

● first choice  
○ alternate choice

WP15PE

order #	catalog #	D1	D	length of cut Ap1 max	length L	ZU
5559100	D50706002W	6,0	6	10,00	54	6
5559108	D51706002W	6,0	6	13,00	57	6
5559101	D50708003W	8,0	8	12,00	58	6
5559109	D51708003W	8,0	8	19,00	63	6
5559102	D50710004W	10,0	10	14,00	66	6
5559110	D51710004W	10,0	10	22,00	72	6
5559103	D50712005W	12,0	12	16,00	73	6
5559111	D51712005W	12,0	12	26,00	83	6
5559112	D51714014W	14,0	14	26,00	83	6
5559105	D50716006W	16,0	16	22,00	82	6
5559113	D51716006W	16,0	16	32,00	92	6
5559114	D51718018W	18,0	18	32,00	92	6
5559107	D50720007W	20,0	20	26,00	92	6
5559115	D51720007W	20,0	20	38,00	104	6

INDEXABLE MILLING

SOLID END MILLING

HOLEMAKING

TAPPING

TURNING

## Finishers • Series 4503 JJ • Sharp Edge • JIS

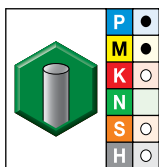
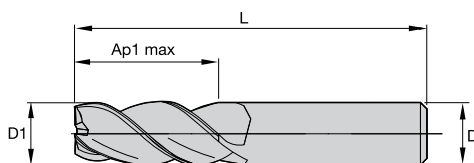

- first choice
- alternate choice

WP15PE

order #	catalog #	D1	D	length of cut Ap1 max	length L	ZU
5559170	450301001T	1,0	4	3,00	50	3
5559171	450301501T	1,5	4	3,00	50	3
5559172	450302001T	2,0	4	3,00	50	3
5559173	450302501T	2,5	4	4,00	50	3
5559174	450302511T	2,5	4	5,00	50	3
5559175	450303002T	3,0	6	8,00	50	3
5559176	450303502T	3,5	6	12,00	50	3
5559177	450304002T	4,0	6	12,00	50	3
5559178	450304502T	4,5	6	14,00	50	3
5559179	450305002T	5,0	6	14,00	50	3
5559180	450306002T	6,0	6	16,00	50	3
5559181	450308003T	8,0	8	20,00	63	3
5559182	450310004T	10,0	10	22,00	76	3
5559183	450312005T	12,0	12	25,00	76	3
5559184	450316006T	16,0	16	32,00	89	3
5559185	450320007T	20,0	20	38,00	104	3

INDEXABLE MILLING

SOLID END MILLING

HOLEMAKING

TAPPING

TURNING

Finishers • Series 4001 JJ • Ball Nose • JIS

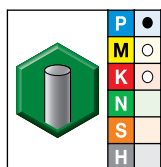
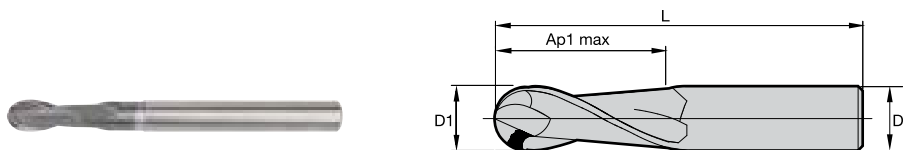

- first choice
- alternate choice

WP15PE

order #	catalog #	D1	D	length of cut Ap1 max	length L	Z U
5559146	400101001T	1,0	4	3,00	50	2
5559147	400101501T	1,5	4	3,00	50	2
5559148	400102001T	2,0	4	3,00	50	2
5559149	400103002T	3,0	6	9,50	58	2
5559160	400104002T	4,0	6	12,00	76	2
5559161	400105002T	5,0	6	14,00	76	2
5559162	400106002T	6,0	6	16,00	100	2
5559163	400108003T	8,0	8	20,00	100	2
5559164	400110004T	10,0	10	22,00	100	2
5559165	400112005T	12,0	12	25,00	125	2
5559167	400116006T	16,0	16	32,00	150	2

INDEXABLE MILLING

SOLID END MILLING

HOLEMAKING

TAPPING

TURNING

## Finishers • Series 4S07 • Application Data • WP15PE • Inch

INDEXABLE MILLING

SOLID END MILLING

HOLEMAKING

TAPPING

TURNING

Material Group	Side Milling (A)		WP15PE		Recommended feed per tooth (IPT = inch/th) for side milling (A).												
	A		Cutting Speed – vc			frac.	D1 – Diameter										
	ap	ae	min	max	SFM		1/8	3/16	1/4	5/16	3/8	7/16	1/2	5/8	3/4	1	
						dec.	.1250	.1875	.2500	.3125	.3750	.4375	.5000	.6250	.7500	1.0000	
P	0	1 x D	0.2 x D	490	-	660	IPT	.0009	.0013	.0018	.0023	.0027	.0031	.0034	.0039	.0044	.0049
	1	1 x D	0.2 x D	490	-	660	IPT	.0009	.0013	.0018	.0023	.0027	.0031	.0034	.0039	.0044	.0049
	2	1 x D	0.2 x D	460	-	620	IPT	.0009	.0013	.0018	.0023	.0027	.0031	.0034	.0039	.0044	.0049
	3	1 x D	0.1 x D	390	-	520	IPT	.0007	.0011	.0015	.0020	.0023	.0026	.0029	.0034	.0039	.0045
	4	1 x D	0.1 x D	300	-	490	IPT	.0007	.0010	.0014	.0017	.0020	.0023	.0026	.0030	.0034	.0039
	5	1 x D	0.1 x D	200	-	330	IPT	.0006	.0009	.0012	.0016	.0018	.0021	.0023	.0027	.0031	.0036
M	6	1 x D	0.1 x D	160	-	250	IPT	.0005	.0008	.0010	.0013	.0015	.0017	.0019	.0022	.0025	.0028
	1	1 x D	0.1 x D	300	-	380	IPT	.0007	.0011	.0015	.0020	.0023	.0026	.0029	.0034	.0039	.0045
	2	1 x D	0.1 x D	200	-	260	IPT	.0006	.0009	.0012	.0016	.0018	.0021	.0023	.0027	.0031	.0036
K	3	1 x D	0.1 x D	200	-	230	IPT	.0005	.0008	.0010	.0013	.0015	.0017	.0019	.0022	.0025	.0028
	1	1 x D	0.1 x D	390	-	490	IPT	.0009	.0013	.0018	.0023	.0027	.0031	.0034	.0039	.0044	.0049
S	2	1 x D	0.1 x D	360	-	460	IPT	.0007	.0011	.0015	.0020	.0023	.0026	.0029	.0034	.0039	.0045
	3	1 x D	0.1 x D	360	-	430	IPT	.0006	.0009	.0012	.0016	.0018	.0021	.0023	.0027	.0031	.0036
	1	1 x D	0.1 x D	160	-	300	IPT	.0007	.0011	.0015	.0020	.0023	.0026	.0029	.0034	.0039	.0045
	2	1 x D	0.1 x D	80	-	130	IPT	.0004	.0006	.0008	.0010	.0012	.0014	.0015	.0018	.0021	.0024
H	3	1 x D	0.15 x D	80	-	130	IPT	.0004	.0006	.0008	.0010	.0012	.0014	.0015	.0018	.0021	.0024
	4	1 x D	0.15 x D	160	-	200	IPT	.0005	.0008	.0011	.0014	.0017	.0019	.0021	.0025	.0028	.0033
	1	1 x D	0.1 x D	260	-	460	IPT	.0007	.0010	.0014	.0017	.0020	.0023	.0026	.0030	.0034	.0039

NOTE: Lower value of cutting speed is used for high stock removal applications or for higher hardness (machinability) within group.  
 Higher value of cutting speed is used for finishing applications or for lower hardness (machinability) within group.  
 Above parameters are based on ideal conditions. For smaller taper machining centers, please adjust parameters accordingly on >1/2" diameter.

Finishers • Series 4S05 4S07 • Application Data • TiCN-CT • Inch

Material Group													Recommended feed per tooth (IPT = inch/th) for side milling (A). D1 – Diameter								
			Uncoated		TiCN		TiAlN		AlTiN		frac. dec.	3/16	1/4	5/16	3/8	1/2	5/8	3/4	1		
	Cutting Speed – vc SFM		Cutting Speed – vc SFM		Cutting Speed – vc SFM		Cutting Speed – vc SFM														
	ap	ae	min	max	min	max	min	max	min	max	min	max									
P	1	1 x D	0.2 x D	200	260	400	520	500	650	590	720	Fz	.0014	.0018	.0023	.0027	.0035	.0039	.0043	.0050	
	2	1 x D	0.2 x D	180	250	360	500	450	625	520	660	Fz	.0014	.0018	.0023	.0027	.0035	.0039	.0043	.0050	
	3	1 x D	0.1 x D	160	210	320	420	400	525	520	590	Fz	.0011	.0015	.0020	.0023	.0029	.0034	.0038	.0046	
	4	1 x D	0.1 x D	–	–	240	380	300	475	460	520	Fz	.0010	.0014	.0018	.0020	.0026	.0030	.0033	.0039	
	5	1 x D	0.1 x D	–	–	160	260	200	325	200	330	Fz	.0009	.0012	.0016	.0018	.0023	.0027	.0030	.0036	
	6	1 x D	0.1 x D	–	–	120	180	150	225	160	260	Fz	.0008	.0010	.0013	.0015	.0019	.0022	.0024	.0028	
M	1	1 x D	0.1 x D	100	130	200	265	260	330	260	330	Fz	.0011	.0015	.0020	.0023	.0029	.0034	.0038	.0046	
	2	1 x D	0.1 x D	–	–	160	210	200	260	200	260	Fz	.0009	.0012	.0016	.0018	.0023	.0027	.0030	.0036	
	3	1 x D	0.1 x D	–	–	160	210	200	260	200	260	Fz	.0008	.0010	.0013	.0015	.0019	.0022	.0024	.0028	
K	1	1 x D	0.1 x D	160	210	300	420	390	520	390	520	Fz	.0014	.0018	.0023	.0027	.0035	.0039	.0043	.0050	
	2	1 x D	0.1 x D	–	–	300	370	360	460	360	460	Fz	.0011	.0015	.0020	.0023	.0029	.0034	.0038	.0046	
	3	1 x D	0.1 x D	–	–	265	345	330	430	330	430	Fz	.0009	.0012	.0016	.0018	.0023	.0027	.0030	.0036	
S	1	1 x D	0.1 x D	–	–	120	220	160	300	300	380	Fz	.0011	.0015	.0020	.0023	.0029	.0034	.0039	.0045	
	2	1 x D	0.1 x D	–	–	50	100	80	130	70	130	Fz	.0006	.0008	.0010	.0012	.0015	.0018	.0021	.0024	
	3	1 x D	0.15 x D	–	–	130	208	80	130	160	260	Fz	.0006	.0008	.0010	.0012	.0015	.0018	.0021	.0024	
	4	1 x D	0.15 x D	–	–	120	170	160	200	150	210	Fz	.0008	.0011	.0014	.0017	.0021	.0025	.0028	.0033	
H	1	1 x D	0.1 x D	–	–	210	360	260	450	330	460	Fz	.0010	.0014	.0018	.0020	.0026	.0030	.0033	.0039	

NOTE: Lower value of cutting speed is used for high-stock removal applications or for higher hardness (machinability) within group.  
Higher value of cutting speed is used for finishing applications or for lower hardness (machinability) within group.  
For tools 2 x D < LOC < 3 x D ae = 0.25 x D, for tools with LOC longer than 3 x D ae = 0.1 x D.

INDEXABLE MILLING

SOLID END MILLING

HOLEMAKING

TAPPING

TURNING

Finishers • Series 4C03 • Application Data • TiCN-CT • TiAlN • Inch

Material Group	Side Milling (A) and Slotting (B)		Uncoated		TiCN		TiAlN		Recommended feed per tooth (IPT = inch/th) for side milling (A). For slotting (B), reduce IPT by 20%.															
	A		B		Cutting Speed - vc SFM		Cutting Speed - vc SFM		Cutting Speed - vc SFM		D1 - Diameter													
	ap	ae	ap		min	max	min	max	min	max	frac.	1/8	3/16	1/4	5/16	3/8	7/16	1/2	5/8	3/4	1			
	ap	ae	ap		min	max	min	max	min	max	dec.	.1250	.1875	.2500	.3125	.3750	.4375	.5000	.6250	.7500	1.0000			
P	0	1.5 x D	0.3 x D	0.5 x D	245	-	330	392	-	528	490	-	660	IPT	.0088	.0135	.0183	.0234	.0273	.0308	.0340	.0395	.0438	.0489
	1	1.5 x D	0.3 x D	0.5 x D	245	-	330	392	-	528	490	-	660	IPT	.0088	.0135	.0183	.0234	.0273	.0308	.0340	.0395	.0438	.0489
	2	1.5 x D	0.3 x D	0.5 x D	230	-	310	368	-	496	460	-	620	IPT	.0088	.0135	.0183	.0234	.0273	.0308	.0340	.0395	.0438	.0489
	3	1.5 x D	0.3 x D	0.5 x D	195	-	260	312	-	416	390	-	520	IPT	.0072	.0111	.0152	.0195	.0229	.0260	.0289	.0341	.0386	.0451
	4	1.5 x D	0.3 x D	0.3 x D	150	-	245	240	-	392	300	-	490	IPT	.0066	.0101	.0138	.0175	.0204	.0231	.0257	.0301	.0337	.0386
	5	1.5 x D	0.3 x D	0.5 x D	100	-	165	160	-	264	200	-	330	IPT	.0059	.0091	.0123	.0156	.0183	.0208	.0231	.0273	.0309	.0361
M	6	1.5 x D	0.3 x D	0.3 x D	80	-	125	128	-	200	160	-	250	IPT	.0050	.0076	.0103	.0131	.0153	.0173	.0191	.0223	.0249	.0281
	1	1.5 x D	0.3 x D	0.5 x D	150	-	190	240	-	304	300	-	380	IPT	.0072	.0111	.0152	.0195	.0229	.0260	.0289	.0341	.0386	.0451
	2	1.5 x D	0.3 x D	0.5 x D	100	-	130	160	-	208	200	-	260	IPT	.0059	.0091	.0123	.0156	.0183	.0208	.0231	.0273	.0309	.0361
K	3	1.5 x D	0.3 x D	0.5 x D	100	-	115	160	-	184	200	-	230	IPT	.0050	.0076	.0103	.0131	.0153	.0173	.0191	.0223	.0249	.0281
	1	1.5 x D	0.3 x D	0.5 x D	195	-	245	312	-	392	390	-	490	IPT	.0088	.0135	.0183	.0234	.0273	.0308	.0340	.0395	.0438	.0489
	2	1.5 x D	0.3 x D	0.5 x D	180	-	230	288	-	368	360	-	460	IPT	.0072	.0111	.0152	.0195	.0229	.0260	.0289	.0341	.0386	.0451
S	3	1.5 x D	0.3 x D	0.5 x D	180	-	215	288	-	344	360	-	430	IPT	.0059	.0091	.0123	.0156	.0183	.0208	.0231	.0273	.0309	.0361
	1	1.5 x D	0.3 x D	0.3 x D	80	-	150	128	-	240	160	-	300	IPT	.0072	.0111	.0152	.0195	.0229	.0260	.0289	.0341	.0386	.0451
	2	1.5 x D	0.3 x D	0.3 x D	40	-	65	64	-	104	80	-	130	IPT	.0039	.0060	.0081	.0103	.0121	.0138	.0153	.0182	.0206	.0243
	3	1.5 x D	0.3 x D	0.3 x D	40	-	65	64	-	104	80	-	130	IPT	.0039	.0060	.0081	.0103	.0121	.0138	.0153	.0182	.0206	.0243
H	4	1.5 x D	0.3 x D	0.5 x D	80	-	100	128	-	160	160	-	200	IPT	.0048	.0077	.0108	.0143	.0168	.0191	.0213	.0251	.0284	.0331
H	1	1.5 x D	0.3 x D	0.3 x D	130	-	230	208	-	368	260	-	460	IPT	.0066	.0101	.0138	.0175	.0204	.0231	.0257	.0301	.0337	.0386

NOTE: Lower value of cutting speed is used for high stock removal applications or for higher hardness (machinability) within group. Higher value of cutting speed is used for finishing applications or for lower hardness (machinability) within group.

Finishers • Series 4C43 • Application Data • TiCN-CT • TiAlN • Inch

Material Group	Side Milling (A) and Slotting (B)		Uncoated		TiCN		TiAlN		Recommended feed per tooth (IPT = inch/th) for side milling (A). For slotting (B), reduce IPT by 20%.														
	A		B		Cutting Speed - vc SFM		Cutting Speed - vc SFM		Cutting Speed - vc SFM		D1 - Diameter												
	ap	ae	ap		min	max	min	max	min	max	frac.	1/8	3/16	1/4	5/16	3/8	1/2	5/8	3/4	1			
	ap	ae	ap		min	max	min	max	min	max	dec.	.1250	.1880	.2500	.3130	.3750	.5000	.6250	.7500	1.000			
P	0	1.25 x D	0.3 x D	0.5 x D	245	-	330	392	-	528	490	-	660	IPT	.0009	.0013	.0018	.0023	.0027	.0034	.0039	.0044	.0049
	1	1.25 x D	0.3 x D	0.5 x D	245	-	330	392	-	528	490	-	660	IPT	.0009	.0013	.0018	.0023	.0027	.0034	.0039	.0044	.0049
	2	1.25 x D	0.3 x D	0.5 x D	230	-	310	368	-	496	460	-	620	IPT	.0009	.0013	.0018	.0023	.0027	.0034	.0039	.0044	.0049
	3	1.25 x D	0.3 x D	0.5 x D	195	-	260	312	-	416	390	-	520	IPT	.0007	.0011	.0015	.0020	.0023	.0029	.0034	.0039	.0045
	4	1.25 x D	0.3 x D	0.3 x D	150	-	245	240	-	392	300	-	490	IPT	.0007	.0010	.0014	.0017	.0020	.0026	.0030	.0034	.0039
	5	1.25 x D	0.3 x D	0.5 x D	100	-	165	160	-	264	200	-	330	IPT	.0006	.0009	.0012	.0016	.0018	.0023	.0027	.0031	.0036
M	6	1.25 x D	0.3 x D	0.3 x D	80	-	125	128	-	200	160	-	250	IPT	.0005	.0008	.0010	.0013	.0015	.0019	.0022	.0025	.0028
	1	1.25 x D	0.3 x D	0.5 x D	150	-	190	240	-	304	300	-	380	IPT	.0007	.0011	.0015	.0020	.0023	.0029	.0034	.0039	.0045
	2	1.25 x D	0.3 x D	0.5 x D	100	-	130	160	-	208	200	-	260	IPT	.0006	.0009	.0012	.0016	.0018	.0023	.0027	.0031	.0036
K	3	1.25 x D	0.3 x D	0.5 x D	100	-	115	160	-	184	200	-	230	IPT	.0005	.0008	.0010	.0013	.0015	.0019	.0022	.0025	.0028
	1	1.25 x D	0.3 x D	0.5 x D	195	-	245	312	-	392	390	-	490	IPT	.0009	.0013	.0018	.0023	.0027	.0034	.0039	.0044	.0049
	2	1.25 x D	0.3 x D	0.5 x D	180	-	230	288	-	368	360	-	460	IPT	.0007	.0011	.0015	.0020	.0023	.0029	.0034	.0039	.0045
S	3	1.25 x D	0.3 x D	0.5 x D	180	-	215	288	-	344	360	-	430	IPT	.0006	.0009	.0012	.0016	.0018	.0023	.0027	.0031	.0036
	1	1.25 x D	0.3 x D	0.3 x D	80	-	150	128	-	240	160	-	300	IPT	.0007	.0011	.0015	.0020	.0023	.0029	.0034	.0039	.0045
	2	1.25 x D	0.3 x D	0.3 x D	40	-	65	64	-	104	80	-	130	IPT	.0004	.0006	.0008	.0010	.0012	.0015	.0018	.0021	.0024
	3	1.25 x D	0.3 x D	0.3 x D	40	-	65	64	-	104	80	-	130	IPT	.0004	.0006	.0008	.0010	.0012	.0015	.0018	.0021	.0024
H	4	1.25 x D	0.3 x D	0.5 x D	80	-	100	128	-	160	160	-	200	IPT	.0005	.0008	.0011	.0014	.0017	.0021	.0025	.0028	.0033
	1	1.25 x D	0.3 x D	0.3 x D	130	-	230	208	-	368	260	-	460	IPT	.0007	.0010	.0014	.0017	.0020	.0026	.0030	.0034	.0039

NOTE: Lower value of cutting speed is used for high stock removal applications or for higher hardness (machinability) within group. Higher value of cutting speed is used for finishing applications or for lower hardness (machinability) within group.

Finishers • Series 4C05 4C15 • Application Data • WP15PE • Inch

Material Group	Side Milling (A)		WP15PE		Recommended feed per tooth (IPT = inch/th) for side milling (A).										
	A		Cutting Speed – vc			D1 – Diameter									
	ap	ae	min	max	frac. dec.	1/8	3/16	1/4	5/16	3/8	1/2	5/8	3/4	1	
	ap	ae	min	max	dec.	1/8	3/16	1/4	5/16	3/8	1/2	5/8	3/4	1	
P	0	Ap1 max 0.1 x D	490	–	660	IPT	.0009	.0013	.0018	.0023	.0027	.0034	.0039	.0044	.0049
	1	Ap1 max 0.1 x D	490	–	660	IPT	.0009	.0013	.0018	.0023	.0027	.0034	.0039	.0044	.0049
	2	Ap1 max 0.1 x D	460	–	620	IPT	.0009	.0013	.0018	.0023	.0027	.0034	.0039	.0044	.0049
	3	Ap1 max 0.1 x D	390	–	520	IPT	.0007	.0011	.0015	.0020	.0023	.0029	.0034	.0039	.0045
	4	Ap1 max 0.1 x D	300	–	490	IPT	.0007	.0010	.0014	.0017	.0020	.0026	.0030	.0034	.0039
	5	Ap1 max 0.1 x D	200	–	330	IPT	.0006	.0009	.0012	.0016	.0018	.0023	.0027	.0031	.0036
M	1	Ap1 max 0.1 x D	300	–	380	IPT	.0007	.0011	.0015	.0020	.0023	.0029	.0034	.0039	.0045
	2	Ap1 max 0.1 x D	200	–	260	IPT	.0006	.0009	.0012	.0016	.0018	.0023	.0027	.0031	.0036
	3	Ap1 max 0.1 x D	200	–	230	IPT	.0005	.0008	.0010	.0013	.0015	.0019	.0022	.0025	.0028
K	1	Ap1 max 0.1 x D	390	–	490	IPT	.0009	.0013	.0018	.0023	.0027	.0034	.0039	.0044	.0049
	2	Ap1 max 0.1 x D	360	–	460	IPT	.0007	.0011	.0015	.0020	.0023	.0029	.0034	.0039	.0045
	3	Ap1 max 0.1 x D	360	–	430	IPT	.0006	.0009	.0012	.0016	.0018	.0023	.0027	.0031	.0036
H	1	Ap1 max 0.1 x D	260	–	460	IPT	.0007	.0010	.0014	.0017	.0020	.0026	.0030	.0034	.0039
	2	Ap1 max 0.1 x D	230	–	390	IPT	.0005	.0008	.0010	.0013	.0015	.0019	.0022	.0025	.0028

NOTE: Lower value of cutting speed is used for high stock removal applications or for higher hardness (machinability) within group.  
 Higher value of cutting speed is used for finishing applications or for lower hardness (machinability) within group.  
 Above parameters are based on ideal conditions. For smaller taper machining centers, please adjust parameters accordingly on >1/2" diameter.



Finishers • Series 4S0F 4S1F • Application Data • WP15PE • TiAlN-RT • Inch

Material Group	Side Milling (A)		TiAlN			Recommended feed per tooth (IPT = inch/th) for side milling (A).						
	A		Cutting Speed – vc			D1 – Diameter						
	ap	ae	min	max	frac. dec.	1/4	3/8	1/2	5/8	3/4	1	
	ap	ae	min	max	dec.	1/4	3/8	1/2	5/8	3/4	1	
P	1	1.5 x D 0.07 x D	500	–	650	IPT	.0018	.0027	.0035	.0039	.0043	.0050
	2	1.5 x D 0.07 x D	450	–	625	IPT	.0018	.0027	.0035	.0039	.0043	.0050
	3	1.5 x D 0.07 x D	400	–	525	IPT	.0015	.0023	.0029	.0034	.0038	.0046
	4	1.5 x D 0.03 x D	300	–	475	IPT	.0014	.0020	.0026	.0030	.0033	.0039
	5	1.5 x D 0.05 x D	200	–	325	IPT	.0012	.0018	.0023	.0027	.0030	.0036
	6	1.5 x D 0.03 x D	150	–	225	IPT	.0010	.0015	.0019	.0022	.0024	.0028
M	1	1.5 x D 0.07 x D	260	–	330	IPT	.0015	.0023	.0029	.0034	.0038	.0046
	2	1.5 x D 0.07 x D	200	–	260	IPT	.0012	.0018	.0023	.0027	.0030	.0036
	3	1.5 x D 0.05 x D	200	–	260	IPT	.0010	.0015	.0019	.0022	.0024	.0028
K	1	1.5 x D 0.07 x D	390	–	520	IPT	.0018	.0027	.0035	.0039	.0043	.0050
	2	1.5 x D 0.07 x D	360	–	460	IPT	.0015	.0023	.0029	.0034	.0038	.0046
	3	1.5 x D 0.05 x D	330	–	430	IPT	.0012	.0018	.0023	.0027	.0030	.0036
S	1	1.5 x D 0.03 x D	160	–	300	IPT	.0015	.0023	.0029	.0034	.0039	.0045
	2	1.5 x D 0.02 x D	80	–	130	IPT	.0008	.0012	.0015	.0018	.0021	.0024
	3	1.5 x D 0.05 x D	80	–	130	IPT	.0008	.0012	.0015	.0018	.0021	.0024
	4	1.5 x D 0.05 x D	160	–	200	IPT	.0011	.0017	.0021	.0025	.0028	.0033
H	1	1.5 x D 0.03 x D	260	–	450	IPT	.0014	.0020	.0026	.0030	.0033	.0039

NOTE: Lower value of cutting speed is used for high stock removal applications or for higher hardness (machinability) within group.  
 Higher value of cutting speed is used for finishing applications or for lower hardness (machinability) within group.  
 Above parameters are based on ideal conditions. For smaller taper machining centers, please adjust parameters accordingly on >1/2" diameter.



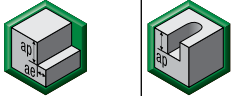

## Finishers • Series DC03 • Application Data • TiAlN-LW • Metric

Material Group																				
	Side Milling (A) and Slotting (B)			TiAlN			Recommended feed per tooth (fz = mm/th) for side milling (A). For slotting (B), reduce fz by 20%.													
	A		B	Cutting Speed – vc m/min			D1 – Diameter													
	ap	ae	ap	min	max	mm	3,0	4,0	5,0	6,0	8,0	10,0	12,0	14,0	16,0	18,0	20,0			
P	0	0,75 x D	0,4 x D	0,5 x D	150	–	200	fz	0,021	0,028	0,036	0,044	0,060	0,072	0,083	0,092	0,101	0,108	0,114	
	1	0,75 x D	0,4 x D	0,5 x D	150	–	200	fz	0,021	0,028	0,036	0,044	0,060	0,072	0,083	0,092	0,101	0,108	0,114	
	2	0,75 x D	0,4 x D	0,5 x D	140	–	190	fz	0,021	0,028	0,036	0,044	0,060	0,072	0,083	0,092	0,101	0,108	0,114	
	3	0,75 x D	0,4 x D	0,5 x D	120	–	160	fz	0,017	0,023	0,030	0,036	0,050	0,061	0,070	0,079	0,087	0,095	0,101	
	4	0,75 x D	0,4 x D	0,3 x D	90	–	150	fz	0,016	0,021	0,027	0,033	0,045	0,054	0,062	0,070	0,077	0,083	0,088	
	5	0,75 x D	0,4 x D	0,5 x D	60	–	100	fz	0,014	0,019	0,024	0,029	0,040	0,048	0,056	0,063	0,070	0,076	0,081	
M	1	0,75 x D	0,4 x D	0,5 x D	90	–	115	fz	0,017	0,023	0,030	0,036	0,050	0,061	0,070	0,079	0,087	0,095	0,101	
	2	0,75 x D	0,4 x D	0,5 x D	60	–	80	fz	0,014	0,019	0,024	0,029	0,040	0,048	0,056	0,063	0,070	0,076	0,081	
K	1	0,75 x D	0,4 x D	0,5 x D	120	–	150	fz	0,021	0,028	0,036	0,044	0,060	0,072	0,083	0,092	0,101	0,108	0,114	
	2	0,75 x D	0,4 x D	0,5 x D	110	–	140	fz	0,017	0,023	0,030	0,036	0,050	0,061	0,070	0,079	0,087	0,095	0,101	
S	1	0,75 x D	0,4 x D	0,3 x D	50	–	90	fz	0,017	0,023	0,030	0,036	0,050	0,061	0,070	0,079	0,087	0,095	0,101	
	2	0,75 x D	0,4 x D	0,3 x D	25	–	40	fz	0,009	0,013	0,016	0,019	0,026	0,032	0,037	0,042	0,046	0,050	0,054	
	3	0,75 x D	0,4 x D	0,3 x D	25	–	40	fz	0,009	0,013	0,016	0,019	0,026	0,032	0,037	0,042	0,046	0,050	0,054	
	4	0,75 x D	0,4 x D	0,5 x D	50	–	60	fz	0,011	0,016	0,021	0,026	0,037	0,045	0,052	0,058	0,064	0,069	0,074	
H	1	0,75 x D	0,4 x D	0,3 x D	80	–	140	fz	0,016	0,021	0,027	0,033	0,045	0,054	0,062	0,070	0,077	0,083	0,088	

NOTE: Lower value of cutting speed is used for high stock removal applications or for higher hardness (machinability) within group.  
Higher value of cutting speed is used for finishing applications or for lower hardness (machinability) within group.  
Above parameters are based on ideal conditions. For smaller taper machining centers, please adjust parameters accordingly on >12mm diameters.

## Finishers • Series 4603 • Application Data • WP15PE • Metric

Material Group																				
	Side Milling (A) and Slotting (B)			WP15PE/TiAlN			Recommended feed per tooth (fz = mm/th) for side milling (A). For slotting (B), reduce fz by 20%.													
	A		B	Cutting Speed – vc m/min			D1 – Diameter													
	ap	ae	ap	min	max	mm	3,0	4,0	5,0	6,0	8,0	10,0	12,0	16,0	18,0	20,0				
P	0	1,5 x D	0,3 x D	0,5 x D	150	–	200	fz	0,017	0,023	0,029	0,035	0,048	0,058	0,066	0,081	0,086	0,091		
	1	1,5 x D	0,3 x D	0,5 x D	150	–	200	fz	0,017	0,023	0,029	0,035	0,048	0,058	0,066	0,081	0,086	0,091		
	2	1,5 x D	0,3 x D	0,5 x D	140	–	190	fz	0,017	0,023	0,029	0,035	0,048	0,058	0,066	0,081	0,086	0,091		
	3	1,5 x D	0,3 x D	0,5 x D	120	–	160	fz	0,014	0,019	0,024	0,029	0,040	0,048	0,056	0,070	0,076	0,081		
	4	1,5 x D	0,3 x D	0,3 x D	90	–	150	fz	0,013	0,017	0,022	0,026	0,036	0,043	0,050	0,061	0,066	0,070		
	5	1,5 x D	0,3 x D	0,5 x D	60	–	100	fz	0,011	0,015	0,019	0,024	0,032	0,039	0,045	0,056	0,060	0,065		
M	1	1,5 x D	0,3 x D	0,5 x D	50	–	75	fz	0,010	0,013	0,016	0,020	0,027	0,032	0,037	0,046	0,049	0,052		
	2	1,5 x D	0,3 x D	0,5 x D	90	–	115	fz	0,014	0,019	0,024	0,029	0,040	0,048	0,056	0,070	0,076	0,081		
K	1	1,5 x D	0,3 x D	0,5 x D	60	–	80	fz	0,011	0,015	0,019	0,024	0,032	0,039	0,045	0,056	0,060	0,065		
	2	1,5 x D	0,3 x D	0,5 x D	120	–	150	fz	0,017	0,023	0,029	0,035	0,048	0,058	0,066	0,081	0,086	0,091		
S	1	1,5 x D	0,3 x D	0,5 x D	110	–	140	fz	0,014	0,019	0,024	0,029	0,040	0,048	0,056	0,070	0,076	0,081		
	2	1,5 x D	0,3 x D	0,5 x D	110	–	130	fz	0,011	0,015	0,019	0,024	0,032	0,039	0,045	0,056	0,060	0,065		
	3	1,5 x D	0,3 x D	0,3 x D	50	–	90	fz	0,017	0,023	0,030	0,036	0,050	0,061	0,070	0,079	0,087	0,095	0,101	
H	1	1,5 x D	0,3 x D	0,3 x D	25	–	40	fz	0,009	0,013	0,016	0,019	0,026	0,032	0,037	0,046	0,050	0,054		
	2	1,5 x D	0,3 x D	0,3 x D	25	–	40	fz	0,009	0,013	0,016	0,019	0,026	0,032	0,037	0,046	0,050	0,054		
H	3	1,5 x D	0,3 x D	0,5 x D	50	–	60	fz	0,011	0,016	0,021	0,026	0,037	0,045	0,052	0,064	0,069	0,074		
	4	1,5 x D	0,3 x D	0,3 x D	80	–	140	fz	0,013	0,017	0,022	0,026	0,036	0,043	0,050	0,061	0,066	0,070		

NOTE: Lower value of cutting speed is used for high stock removal applications or for higher hardness (machinability) within group.  
Higher value of cutting speed is used for finishing applications or for lower hardness (machinability) within group.  
Above parameters are based on ideal conditions. For smaller taper machining centers, please adjust parameters accordingly on >12mm diameters.

Finishers • Series D503 • Application Data • TiAlN • Metric

Material Group																					
	Side Milling (A) and Slotting (B)			TiAlN			Recommended feed per tooth (fz = mm/th) for side milling (A). For slotting (B), reduce fz by 20%.														
	A		B	Cutting Speed – vc m/min			D1 – Diameter														
	ap	ae	ap	min	max	mm	3,0	4,0	5,0	6,0	8,0	10,0	12,0	14,0	16,0	18,0	20,0				
P	0	0,75 x D	0,4 x D	0,5 x D	150	–	200	fz	0,021	0,028	0,036	0,044	0,060	0,072	0,083	0,092	0,101	0,108	0,114		
	1	0,75 x D	0,4 x D	0,5 x D	150	–	200	fz	0,021	0,028	0,036	0,044	0,060	0,072	0,083	0,092	0,101	0,108	0,114		
	2	0,75 x D	0,4 x D	0,5 x D	140	–	190	fz	0,021	0,028	0,036	0,044	0,060	0,072	0,083	0,092	0,101	0,108	0,114		
	3	0,75 x D	0,4 x D	0,5 x D	120	–	160	fz	0,017	0,023	0,030	0,036	0,050	0,061	0,070	0,079	0,087	0,095	0,101		
	4	0,75 x D	0,4 x D	0,3 x D	90	–	150	fz	0,016	0,021	0,027	0,033	0,045	0,054	0,062	0,070	0,077	0,083	0,088		
	5	0,75 x D	0,4 x D	0,5 x D	60	–	100	fz	0,014	0,019	0,024	0,029	0,040	0,048	0,056	0,063	0,070	0,076	0,081		
M	1	0,75 x D	0,4 x D	0,5 x D	90	–	115	fz	0,017	0,023	0,030	0,036	0,050	0,061	0,070	0,079	0,087	0,095	0,101		
	2	0,75 x D	0,4 x D	0,5 x D	60	–	80	fz	0,014	0,019	0,024	0,029	0,040	0,048	0,056	0,063	0,070	0,076	0,081		
	3	0,75 x D	0,4 x D	0,5 x D	60	–	70	fz	0,012	0,016	0,020	0,025	0,034	0,040	0,047	0,052	0,057	0,061	0,065		
K	1	0,75 x D	0,4 x D	0,5 x D	120	–	150	fz	0,021	0,028	0,036	0,044	0,060	0,072	0,083	0,092	0,101	0,108	0,114		
	2	0,75 x D	0,4 x D	0,5 x D	110	–	140	fz	0,017	0,023	0,030	0,036	0,050	0,061	0,070	0,079	0,087	0,095	0,101		
	3	0,75 x D	0,4 x D	0,5 x D	110	–	130	fz	0,014	0,019	0,024	0,029	0,040	0,048	0,056	0,063	0,070	0,076	0,081		
S	1	0,75 x D	0,4 x D	0,3 x D	50	–	90	fz	0,017	0,023	0,030	0,036	0,050	0,061	0,070	0,079	0,087	0,095	0,101		
	2	0,75 x D	0,4 x D	0,3 x D	25	–	40	fz	0,009	0,013	0,016	0,019	0,026	0,032	0,037	0,042	0,046	0,050	0,054		
	3	0,75 x D	0,4 x D	0,3 x D	25	–	40	fz	0,009	0,013	0,016	0,019	0,026	0,032	0,037	0,042	0,046	0,050	0,054		
	4	0,75 x D	0,4 x D	0,5 x D	50	–	60	fz	0,011	0,016	0,021	0,026	0,037	0,045	0,052	0,058	0,064	0,069	0,074		
H	1	0,75 x D	0,4 x D	0,3 x D	80	–	140	fz	0,016	0,021	0,027	0,033	0,045	0,054	0,062	0,070	0,077	0,083	0,088		

NOTE: Lower value of cutting speed is used for high stock removal applications or for higher hardness (machinability) within group.  
Higher value of cutting speed is used for finishing applications or for lower hardness (machinability) within group.  
Above parameters are based on ideal conditions. For smaller taper machining centers, please adjust parameters accordingly on greater than 12mm diameters.

Finishers • Series D513 • Application Data • TiAlN • Metric

Material Group																					
	Side Milling (A) and Slotting (B)			TiAlN			Recommended feed per tooth (fz = mm/th) for side milling (A). For slotting (B), reduce fz by 20%.														
	A		B	Cutting Speed – vc m/min			D1 – Diameter														
	ap	ae	ap	min	max	mm	3,0	4,0	5,0	6,0	8,0	10,0	12,0	14,0	16,0	18,0	20,0				
P	0	1,25 x D	0,2 x D	0,25 x D	150	–	200	fz	0,021	0,028	0,036	0,044	0,060	0,072	0,083	0,092	0,101	0,108	0,114		
	1	1,25 x D	0,2 x D	0,25 x D	150	–	200	fz	0,021	0,028	0,036	0,044	0,060	0,072	0,083	0,092	0,101	0,108	0,114		
	2	1,25 x D	0,2 x D	0,25 x D	140	–	190	fz	0,021	0,028	0,036	0,044	0,060	0,072	0,083	0,092	0,101	0,108	0,114		
	3	1,25 x D	0,2 x D	0,25 x D	120	–	160	fz	0,017	0,023	0,030	0,036	0,050	0,061	0,070	0,079	0,087	0,095	0,101		
	4	1,25 x D	0,2 x D	0,25 x D	90	–	150	fz	0,016	0,021	0,027	0,033	0,045	0,054	0,062	0,070	0,077	0,083	0,088		
	5	1,25 x D	0,2 x D	0,25 x D	60	–	100	fz	0,014	0,019	0,024	0,029	0,040	0,048	0,056	0,063	0,070	0,076	0,081		
M	1	1,25 x D	0,2 x D	0,25 x D	90	–	115	fz	0,017	0,023	0,030	0,036	0,050	0,061	0,070	0,079	0,087	0,095	0,101		
	2	1,25 x D	0,2 x D	0,25 x D	60	–	80	fz	0,014	0,019	0,024	0,029	0,040	0,048	0,056	0,063	0,070	0,076	0,081		
	3	1,25 x D	0,2 x D	0,25 x D	60	–	70	fz	0,012	0,016	0,020	0,025	0,034	0,040	0,047	0,052	0,057	0,061	0,065		
K	1	1,25 x D	0,2 x D	0,25 x D	120	–	150	fz	0,021	0,028	0,036	0,044	0,060	0,072	0,083	0,092	0,101	0,108	0,114		
	2	1,25 x D	0,2 x D	0,25 x D	110	–	140	fz	0,017	0,023	0,030	0,036	0,050	0,061	0,070	0,079	0,087	0,095	0,101		
	3	1,25 x D	0,2 x D	0,25 x D	110	–	130	fz	0,014	0,019	0,024	0,029	0,040	0,048	0,056	0,063	0,070	0,076	0,081		
S	1	1,25 x D	0,2 x D	0,25 x D	50	–	90	fz	0,017	0,023	0,030	0,036	0,050	0,061	0,070	0,079	0,087	0,095	0,101		
	2	1,25 x D	0,2 x D	0,25 x D	25	–	40	fz	0,009	0,013	0,016	0,019	0,026	0,032	0,037	0,042	0,046	0,050	0,054		
	3	1,25 x D	0,2 x D	0,25 x D	25	–	40	fz	0,009	0,013	0,016	0,019	0,026	0,032	0,037	0,042	0,046	0,050	0,054		
	4	1,25 x D	0,2 x D	0,25 x D	50	–	60	fz	0,011	0,016	0,021	0,026	0,037	0,045	0,052	0,058	0,064	0,069	0,074		
H	1	1,25 x D	0,2 x D	0,25 x D	80	–	140	fz	0,016	0,021	0,027	0,033	0,045	0,054	0,062	0,070	0,077	0,083	0,088		

NOTE: Lower value of cutting speed is used for high stock removal applications or for higher hardness (machinability) within group.  
Higher value of cutting speed is used for finishing applications or for lower hardness (machinability) within group.  
Above parameters are based on ideal conditions. For smaller taper machining centers, please adjust parameters accordingly on >12mm diameters.

## Finishers • Series D507 • Application Data • WP15PE • Metric

Material Group	Side Milling (A)		WP15PE			Recommended feed per tooth (fz = mm/th) for side milling (A).										
	A		Cutting Speed – vc m/min			mm	D1 – Diameter									
	ap	ae	min	–	max		4,0	6,0	8,0	10,0	12,0	14,0	16,0	18,0	20,0	
	0	1,0 x D	0,2 x D	150	–	200	fz	0,028	0,044	0,060	0,072	0,083	0,092	0,101	0,108	0,114
P	1	1,0 x D	0,2 x D	150	–	200	fz	0,028	0,044	0,060	0,072	0,083	0,092	0,101	0,108	0,114
	2	1,0 x D	0,2 x D	140	–	190	fz	0,028	0,044	0,060	0,072	0,083	0,092	0,101	0,108	0,114
	3	1,0 x D	0,1 x D	120	–	160	fz	0,023	0,036	0,050	0,061	0,070	0,079	0,087	0,095	0,101
	4	1,0 x D	0,1 x D	90	–	150	fz	0,021	0,033	0,045	0,054	0,062	0,070	0,077	0,083	0,088
	5	1,0 x D	0,1 x D	60	–	100	fz	0,019	0,029	0,040	0,048	0,056	0,063	0,070	0,076	0,081
	6	1,0 x D	0,1 x D	50	–	75	fz	0,016	0,025	0,034	0,040	0,047	0,052	0,057	0,061	0,065
M	1	1,0 x D	0,1 x D	90	–	115	fz	0,023	0,036	0,050	0,061	0,070	0,079	0,087	0,095	0,101
	2	1,0 x D	0,1 x D	60	–	80	fz	0,019	0,029	0,040	0,048	0,056	0,063	0,070	0,076	0,081
	3	1,0 x D	0,1 x D	60	–	70	fz	0,016	0,025	0,034	0,040	0,047	0,052	0,057	0,061	0,065
K	1	1,0 x D	0,1 x D	120	–	150	fz	0,028	0,044	0,060	0,072	0,083	0,092	0,101	0,108	0,114
	2	1,0 x D	0,1 x D	110	–	140	fz	0,023	0,036	0,050	0,061	0,070	0,079	0,087	0,095	0,101
	3	1,0 x D	0,1 x D	110	–	130	fz	0,019	0,029	0,040	0,048	0,056	0,063	0,070	0,076	0,081
S	1	1,0 x D	0,1 x D	50	–	90	fz	0,023	0,036	0,050	0,061	0,070	0,079	0,087	0,095	0,101
	2	1,0 x D	0,1 x D	25	–	40	fz	0,013	0,019	0,026	0,032	0,037	0,042	0,046	0,050	0,054
	3	1,0 x D	0,15 x D	25	–	40	fz	0,013	0,019	0,026	0,032	0,037	0,042	0,046	0,050	0,054
	4	1,0 x D	0,15 x D	50	–	60	fz	0,016	0,026	0,037	0,045	0,052	0,058	0,064	0,069	0,074
H	1	1,0 x D	0,1 x D	80	–	140	fz	0,021	0,033	0,045	0,054	0,062	0,070	0,077	0,083	0,088



NOTE: Lower value of cutting speed is used for high stock removal applications or for higher hardness (machinability) within group.  
Higher value of cutting speed is used for finishing applications or for lower hardness (machinability) within group.  
Above parameters are based on ideal conditions. For smaller taper machining centers, please adjust parameters accordingly on diameters >12mm.

## Finishers • Series D517 • Application Data • WP15PE • Metric

Material Group	Side Milling (A)		WP15PE			Recommended feed per tooth (fz = mm/th) for side milling (A).										
	A		Cutting Speed – vc m/min			mm	D1 – Diameter									
	ap	ae	min	–	max		4,0	6,0	8,0	10,0	12,0	14,0	16,0	18,0	20,0	
	0	Ap1 max	0,05 x D	150	–	200	fz	0,028	0,044	0,060	0,072	0,083	0,092	0,101	0,108	0,114
P	1	Ap1 max	0,05 x D	150	–	200	fz	0,028	0,044	0,060	0,072	0,083	0,092	0,101	0,108	0,114
	2	Ap1 max	0,05 x D	140	–	190	fz	0,028	0,044	0,060	0,072	0,083	0,092	0,101	0,108	0,114
	3	Ap1 max	0,05 x D	120	–	160	fz	0,023	0,036	0,050	0,061	0,070	0,079	0,087	0,095	0,101
	4	Ap1 max	0,05 x D	90	–	150	fz	0,021	0,033	0,045	0,054	0,062	0,070	0,077	0,083	0,088
	5	Ap1 max	0,05 x D	60	–	100	fz	0,019	0,029	0,040	0,048	0,056	0,063	0,070	0,076	0,081
	6	Ap1 max	0,05 x D	50	–	75	fz	0,016	0,025	0,034	0,040	0,047	0,052	0,057	0,061	0,065
M	1	Ap1 max	0,05 x D	90	–	115	fz	0,023	0,036	0,050	0,061	0,070	0,079	0,087	0,095	0,101
	2	Ap1 max	0,05 x D	60	–	80	fz	0,019	0,029	0,040	0,048	0,056	0,063	0,070	0,076	0,081
	3	Ap1 max	0,05 x D	60	–	70	fz	0,016	0,025	0,034	0,040	0,047	0,052	0,057	0,061	0,065
K	1	Ap1 max	0,05 x D	120	–	150	fz	0,028	0,044	0,060	0,072	0,083	0,092	0,101	0,108	0,114
	2	Ap1 max	0,05 x D	110	–	140	fz	0,023	0,036	0,050	0,061	0,070	0,079	0,087	0,095	0,101
	3	Ap1 max	0,05 x D	110	–	130	fz	0,019	0,029	0,040	0,048	0,056	0,063	0,070	0,076	0,081
S	1	Ap1 max	0,04 x D	50	–	90	fz	0,023	0,036	0,050	0,061	0,070	0,079	0,087	0,095	0,101
	2	Ap1 max	0,04 x D	25	–	40	fz	0,013	0,019	0,026	0,032	0,037	0,042	0,046	0,050	0,054
	3	Ap1 max	0,05 x D	25	–	40	fz	0,013	0,019	0,026	0,032	0,037	0,042	0,046	0,050	0,054
	4	Ap1 max	0,05 x D	50	–	60	fz	0,016	0,026	0,037	0,045	0,052	0,058	0,064	0,069	0,074
H	1	Ap1 max	0,04 x D	80	–	140	fz	0,021	0,033	0,045	0,054	0,062	0,070	0,077	0,083	0,088



NOTE: Lower value of cutting speed is used for high stock removal applications or for higher hardness (machinability) within group.  
Higher value of cutting speed is used for finishing applications or for lower hardness (machinability) within group.  
For better surface finish, reduce feed per tooth.  
Above parameters are based on ideal conditions. For smaller taper machining centers, please adjust parameters accordingly on diameters >12mm.

Finishers • Series 4503 JJ • Application Data • WP15PE • Metric

Material Group	 																		
	Side Milling (A) and Slotting (B)			WP15PE			Recommended feed per tooth (fz = mm/th) for side milling (A). For slotting (B), reduce fz by 20%.												
	A		B	Cutting Speed – vc m/min			D1 – Diameter												
	ap	ae	ap	min	max	mm	3,0	4,0	5,0	6,0	8,0	10,0	12,0	16,0	18,0	20,0			
P	0	1,5 x D	0,3 x D	0,5 x D	150	–	200	fz	0,021	0,028	0,036	0,044	0,060	0,072	0,083	0,101	0,108	0,114	
	1	1,5 x D	0,3 x D	0,5 x D	150	–	200	fz	0,021	0,028	0,036	0,044	0,060	0,072	0,083	0,101	0,108	0,114	
	2	1,5 x D	0,3 x D	0,5 x D	140	–	190	fz	0,021	0,028	0,036	0,044	0,060	0,072	0,083	0,101	0,108	0,114	
	3	1,5 x D	0,3 x D	0,5 x D	120	–	160	fz	0,017	0,023	0,030	0,036	0,050	0,061	0,070	0,087	0,095	0,101	
	4	1,5 x D	0,3 x D	0,3 x D	90	–	150	fz	0,016	0,021	0,027	0,033	0,045	0,054	0,062	0,077	0,083	0,088	
	5	1,5 x D	0,3 x D	0,5 x D	60	–	100	fz	0,014	0,019	0,024	0,029	0,040	0,048	0,056	0,070	0,076	0,081	
M	1	1,5 x D	0,3 x D	0,5 x D	90	–	115	fz	0,017	0,023	0,030	0,036	0,050	0,061	0,070	0,087	0,095	0,101	
	2	1,5 x D	0,3 x D	0,5 x D	60	–	80	fz	0,014	0,019	0,024	0,029	0,040	0,048	0,056	0,070	0,076	0,081	
K	1	1,5 x D	0,3 x D	0,5 x D	120	–	150	fz	0,021	0,028	0,036	0,044	0,060	0,072	0,083	0,101	0,108	0,114	
	2	1,5 x D	0,3 x D	0,5 x D	110	–	140	fz	0,017	0,023	0,030	0,036	0,050	0,061	0,070	0,087	0,095	0,101	
S	1	1,5 x D	0,3 x D	0,3 x D	50	–	90	fz	0,017	0,023	0,030	0,036	0,050	0,061	0,070	0,087	0,095	0,101	
	2	1,5 x D	0,3 x D	0,3 x D	25	–	40	fz	0,009	0,013	0,016	0,019	0,026	0,032	0,037	0,046	0,050	0,054	
	3	1,5 x D	0,3 x D	0,5 x D	25	–	40	fz	0,009	0,013	0,016	0,019	0,026	0,032	0,037	0,046	0,050	0,054	
	4	1,5 x D	0,3 x D	0,5 x D	50	–	60	fz	0,011	0,016	0,021	0,026	0,037	0,045	0,052	0,064	0,069	0,074	
H	1	1,5 x D	0,3 x D	0,3 x D	80	–	140	fz	0,016	0,021	0,027	0,033	0,045	0,054	0,062	0,077	0,083	0,088	

NOTE: Lower value of cutting speed is used for high stock removal applications or for higher hardness (machinability) within group.  
Higher value of cutting speed is used for finishing applications or for lower hardness (machinability) within group.  
Above parameters are based on ideal conditions. For smaller taper machining centers, please adjust parameters accordingly on >12mm diameters.

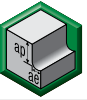
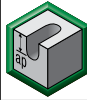
Finishers • Series 4001 JJ • Application Data • WP15PE • Metric

Material Group	 																					
	Side Milling (A) and Slotting (B)			WP15PE			Recommended feed per tooth (fz = mm/th) for side milling (A). For slotting (B), reduce fz by 20%.															
	A		B	Cutting Speed – vc m/min			D1 – Diameter															
	ap	ae	ap	min	max	mm	2,0	3,0	4,0	5,0	6,0	8,0	10,0	12,0	14,0	16,0	18,0	20,0	25,0			
P	0	1,25 x D	0,25 x D	0,5 x D	150	–	200	fz	0,012	0,019	0,026	0,032	0,039	0,054	0,065	0,075	0,083	0,091	0,097	0,103	0,111	
	1	1,25 x D	0,25 x D	0,5 x D	150	–	200	fz	0,012	0,019	0,026	0,032	0,039	0,054	0,065	0,075	0,083	0,091	0,097	0,103	0,111	
	2	1,25 x D	0,25 x D	0,5 x D	140	–	190	fz	0,012	0,019	0,026	0,032	0,039	0,054	0,065	0,075	0,083	0,091	0,097	0,103	0,111	
	3	1,25 x D	0,25 x D	0,5 x D	120	–	160	fz	0,010	0,016	0,021	0,027	0,033	0,045	0,054	0,063	0,071	0,078	0,085	0,091	0,102	
M	1	1,25 x D	0,25 x D	0,5 x D	90	–	115	fz	0,010	0,016	0,021	0,027	0,033	0,045	0,054	0,063	0,071	0,078	0,085	0,091	0,102	
	2	1,25 x D	0,25 x D	0,5 x D	60	–	80	fz	0,008	0,013	0,017	0,022	0,026	0,036	0,044	0,051	0,057	0,063	0,068	0,073	0,082	
K	1	1,25 x D	0,25 x D	0,5 x D	120	–	150	fz	0,012	0,019	0,026	0,032	0,039	0,054	0,065	0,075	0,083	0,091	0,097	0,103	0,111	
	2	1,25 x D	0,25 x D	0,5 x D	110	–	140	fz	0,010	0,016	0,021	0,027	0,033	0,045	0,054	0,063	0,071	0,078	0,085	0,091	0,102	
N	1	1,25 x D	0,25 x D	0,5 x D	500	–	2000	fz	0,018	0,027	0,036	0,045	0,054	0,072	0,090	0,108	0,126	0,144	0,162	0,180	0,225	
	2	1,25 x D	0,25 x D	0,5 x D	500	–	1500	fz	0,016	0,024	0,032	0,041	0,049	0,065	0,081	0,097	0,113	0,130	0,146	0,162	0,203	
	3	1,25 x D	0,25 x D	0,5 x D	250	–	1000	fz	0,016	0,024	0,032	0,041	0,049	0,065	0,081	0,097	0,113	0,130	0,146	0,162	0,203	
	4	1,25 x D	0,25 x D	0,5 x D	100	–	750	fz	0,018	0,027	0,036	0,045	0,054	0,072	0,090	0,108	0,126	0,144	0,162	0,180	0,225	

NOTE: Lower value of cutting speed is used for high stock removal applications or for higher hardness (machinability) within group.  
Higher value of cutting speed is used for finishing applications or for lower hardness (machinability) within group.  
Above parameters are based on ideal conditions. For smaller taper machining centers, please adjust parameters accordingly on >12mm diameters.

ALUFLASH end mills are for machining companies seeking a vibration-free tool capable of achieving advanced milling applications at accelerated RPMs.

### Features and Benefits

**Balanced by design** to significantly limit vibrations at high RPMs.

**“W” flute shape** form evacuates chips to increase process security.

**Parabolic core** for increased tool stability and reduced deflection and risk of breakage.

**Double rake gashing** for improved chip evacuation and higher ramping capabilities and Z-axis machining.



ALUFLASH end mills will drill into the full material and execute advanced ramping angles at high-feed rates without RPM limitations.

## **SAFE**

The ALUFLASH end mills' balanced design obliterates any apprehension of spindle damage.

## **ADVANCED**

ALUFLASH provides advanced milling capabilities with steep ramping angles, drilling into the full material and cornering without vibration marks.

## **ACCELERATED**

The ALUFLASH end mills enable machinists to increase cutting speeds to the machine capacity, creating limitless performance in any aluminum application.



# ACCELERATED ALUMINUM MACHINING

## PRODUCT

SOLID CARBIDE END MILL

GRADE

UNCOATED

FLUTE

2 & 3

DIAMETER RANGE

INCH

1/8–1"

METRIC

3–20mm

## INDUSTRY



GENERAL  
ENGINEERING



AEROSPACE

## APPLICATIONS

MATERIALS

N

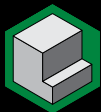

SIDE MILLING



SLOTTING



HELICAL  
INTERPOLATION



RAMPING



DYNAMIC  
MILLING



PLUNGING



DRILLING

**ALUFLASH • Series 2A09 • Square End • 2 Flute • Regular Length • Cylindrical Shank • Inch**

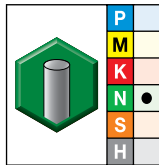
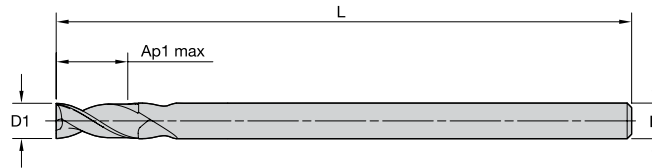

UNCOATED

- first choice
- alternate choice

order #	catalog #	D1	D	length of cut Ap1 max	length L	Z U
6853394	2A09E03000SZT	1/8	1/8	1/4	2	2
6853396	2A09E05001SZT	3/16	3/16	5/16	2	2
6853398	2A09E07003SZT	1/4	1/4	3/8	2	2
6853421	2A09E08004SZT	5/16	5/16	5/8	2 1/2	2
6853423	2A09E10005SZT	3/8	3/8	1	3	2
6853426	2A09E13006SZT	1/2	1/2	1 1/4	3 1/2	2
6853431	2A09E19009SZT	3/4	3/4	1 5/8	4 1/4	2
6853435	2A09E2500ASZT	1	1	2 1/2	5 1/2	2

**ALUFLASH • Series 2A09 • Radius • 2 Flute • Regular Length • Cylindrical Shank • Inch**

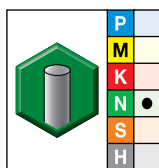
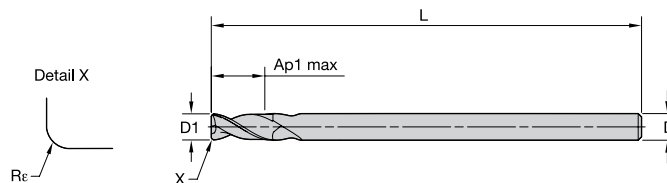

UNCOATED

- first choice
- alternate choice

order #	catalog #	D1	D	length of cut Ap1 max	length L	Re	Z U
6853395	2A09E03000RAT	1/8	1/8	1/4	2	.015	2
6853397	2A09E05001RAT	3/16	3/16	5/16	2	.015	2
6853399	2A09E07003RAT	1/4	1/4	3/8	2	.015	2
6853400	2A09E07003RET	1/4	1/4	3/8	2	.030	2
6853422	2A09E08004RAT	5/16	5/16	5/8	2 1/2	.015	2
6853424	2A09E10005RAT	3/8	3/8	1	3	.015	2
6853425	2A09E10005RET	3/8	3/8	1	3	.030	2
6853427	2A09E13006RAT	1/2	1/2	1 1/4	3 1/2	.015	2
6853428	2A09E13006RET	1/2	1/2	1 1/4	3 1/2	.030	2
6853429	2A09E13006RGT	1/2	1/2	1 1/4	3 1/2	.060	2
6853430	2A09E13006RKT	1/2	1/2	1 1/4	3 1/2	.120	2
6853432	2A09E19009RET	3/4	3/4	1 5/8	4 1/4	.030	2
6853433	2A09E19009RGT	3/4	3/4	1 5/8	4 1/4	.060	2
6853434	2A09E19009RKT	3/4	3/4	1 5/8	4 1/4	.120	2
6853436	2A09E2500ARET	1	1	2 1/2	5 1/2	.030	2
6853437	2A09E2500ARGT	1	1	2 1/2	5 1/2	.060	2
6853438	2A09E2500ARKT	1	1	2 1/2	5 1/2	.120	2

ALUFLASH • Series 2A19 • Square End • 2 Flute • Long Length • Cylindrical Shank • Inch

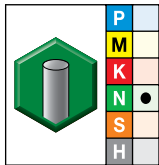
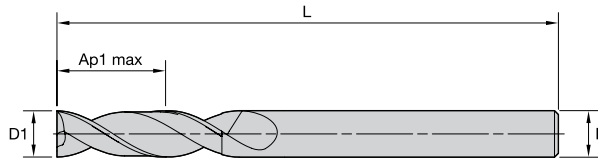

UNCOATED

- first choice
- alternate choice

order #	catalog #	D1	D	length of cut Ap1 max	length L	Z U
6853379	2A19E03010SZT	1/8	1/8	1/2	2	2
6853381	2A19E05011SZT	3/16	3/16	5/8	2	2
6853383	2A19E07013SZT	1/4	1/4	3/4	2 1/2	2
6853386	2A19E08014SZT	5/16	5/16	1 1/4	3	2
6853388	2A19E10015SZT	3/8	3/8	1 1/2	4	2
6853391	2A19E13016SZT	1/2	1/2	2	4	2

ALUFLASH • Series 2A19 • Radius • 2 Flute • Long Length • Cylindrical Shank • Inch

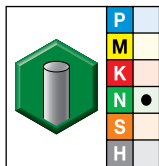
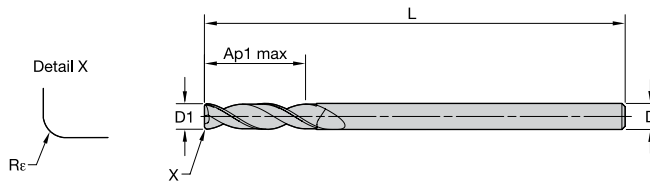

UNCOATED

- first choice
- alternate choice

order #	catalog #	D1	D	length of cut Ap1 max	length L	Re	Z U
6853380	2A19E03010RAT	1/8	1/8	1/2	2	.015	2
6853382	2A19E05011RAT	3/16	3/16	5/8	2	.015	2
6853384	2A19E07013RAT	1/4	1/4	3/4	2 1/2	.015	2
6853385	2A19E07013RET	1/4	1/4	3/4	2 1/2	.030	2
6853387	2A19E08014RAT	5/16	5/16	1 1/4	3	.015	2
6853389	2A19E10015RAT	3/8	3/8	1 1/2	4	.015	2
6853390	2A19E10015RET	3/8	3/8	1 1/2	4	.030	2
6853392	2A19E13016RAT	1/2	1/2	2	4	.015	2
6853393	2A19E13016RET	1/2	1/2	2	4	.030	2



**ALUFLASH • Series 2AN9 • Square End • 2 Flute • Regular Length • Regular Neck • Cylindrical Shank • Inch**

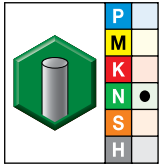
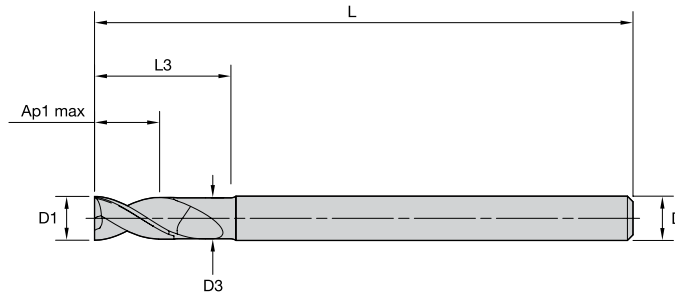

UNCOATED

- first choice
- alternate choice

order #	catalog #	D1	D	D3	length of cut Ap1 max	length L	L3	Z U
6859874	2AN9E03000SZT	1/8	1/8	.118	3/16	1 1/2	3/8	2
6859876	2AN9E05001SZT	3/16	3/16	.176	1/4	2 1/4	9/16	2
6859878	2AN9E07003SZT	1/4	1/4	.235	5/16	2 1/2	3/4	2
6859883	2AN9E08004SZT	5/16	5/16	.294	3/8	2 1/2	1	2
6859886	2AN9E10005SZT	3/8	3/8	.353	1/2	3	1 1/4	2
6859889	2AN9E13006SZT	1/2	1/2	.470	5/8	3 1/2	1 1/2	2
6859892	2AN9E16008SZT	5/8	5/8	.588	3/4	4	2	2
6859895	2AN9E19009SZT	3/4	3/4	.705	1	5	2 1/4	2
6859898	2AN9E2500ASZT	1	1	.940	1 1/4	5 1/2	2 1/2	2

**ALUFLASH • Series 2AN9 • Radius • 2 Flute • Regular Length • Regular Neck • Cylindrical Shank • Inch**

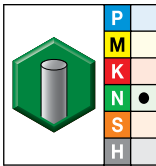
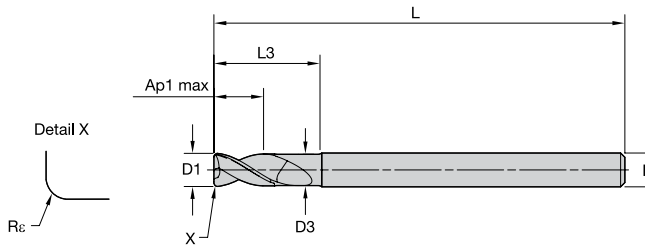

UNCOATED

- first choice
- alternate choice

order #	catalog #	D1	D	D3	length of cut Ap1 max	length L	L3	Rε	Z U
6859875	2AN9E03000RAT	1/8	1/8	.118	3/16	1 1/2	3/8	.015	2
6859877	2AN9E05001RAT	3/16	3/16	.176	1/4	2 1/4	9/16	.015	2
6859881	2AN9E07003RET	1/4	1/4	.235	5/16	2 1/2	3/4	.030	2
6859882	2AN9E07003RGT	1/4	1/4	.235	5/16	2 1/2	3/4	.060	2
6859884	2AN9E08004RET	5/16	5/16	.294	3/8	2 1/2	1	.030	2
6859885	2AN9E08004RGT	5/16	5/16	.294	3/8	2 1/2	1	.060	2
6859887	2AN9E10005RET	3/8	3/8	.353	1/2	3	1 1/4	.030	2
6859888	2AN9E10005RGT	3/8	3/8	.353	1/2	3	1 1/4	.060	2
6859890	2AN9E13006RET	1/2	1/2	.470	5/8	3 1/2	1 1/2	.030	2
6859891	2AN9E13006RGT	1/2	1/2	.470	5/8	3 1/2	1 1/2	.060	2
6859893	2AN9E16008RET	5/8	5/8	.588	3/4	4	2	.030	2
6859894	2AN9E16008RGT	5/8	5/8	.588	3/4	4	2	.060	2
6859896	2AN9E19009RET	3/4	3/4	.705	1	5	2 1/4	.030	2
6859897	2AN9E19009RGT	3/4	3/4	.705	1	5	2 1/4	.060	2
6859899	2AN9E2500ARET	1	1	.940	1 1/4	5 1/2	2 1/2	.030	2
6859900	2AN9E2500ARGT	1	1	.940	1 1/4	5 1/2	2 1/2	.060	2

**ALUFLASH • Series 2AL9 • Square End • 2 Flute • Regular Length • Medium Neck • Cylindrical Shank • Inch**

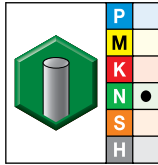
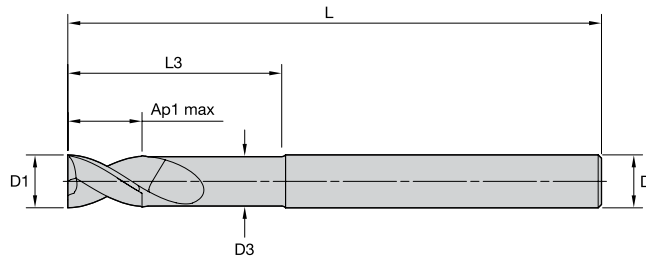

UNCOATED

- first choice
- alternate choice

order #	catalog #	D1	D	D3	length of cut Ap1 max	length L	L3	Z U
6859607	2AL9E07013SZT	1/4	1/4	.235	5/16	2 1/2	1	2
6859651	2AL9E08014SZT	5/16	5/16	.294	3/8	3	1 1/4	2
6859654	2AL9E10015SZT	3/8	3/8	.353	1/2	3	1 1/2	2
6859657	2AL9E13016SZT	1/2	1/2	.470	5/8	4	2	2
6859660	2AL9E16018SZT	5/8	5/8	.588	3/4	5	2 1/2	2
6859673	2AL9E19019SZT	3/4	3/4	.705	1	5	3	2
6859676	2AL9E2501ASZT	1	1	.940	1 1/4	5 1/2	3	2

**ALUFLASH • Series 2AL9 • Radius • 2 Flute • Regular Length • Medium Neck • Cylindrical Shank • Inch**

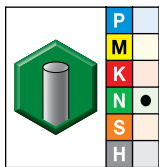
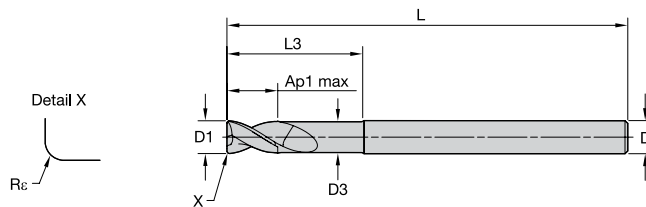

UNCOATED

- first choice
- alternate choice

order #	catalog #	D1	D	D3	length of cut Ap1 max	length L	L3	Re	Z U
6859606	2AL9E05011RAT	3/16	3/16	.176	1/4	2 1/4	3/4	.015	2
6859608	2AL9E07013RET	1/4	1/4	.235	5/16	2 1/2	1	.030	2
6859610	2AL9E07013RGT	1/4	1/4	.235	5/16	2 1/2	1	.060	2
6859652	2AL9E08014RET	5/16	5/16	.294	3/8	3	1 1/4	.030	2
6859653	2AL9E08014RGT	5/16	5/16	.294	3/8	3	1 1/4	.060	2
6859655	2AL9E10015RET	3/8	3/8	.353	1/2	3	1 1/2	.030	2
6859656	2AL9E10015RGT	3/8	3/8	.353	1/2	3	1 1/2	.060	2
6859658	2AL9E13016RET	1/2	1/2	.470	5/8	4	2	.030	2
6859659	2AL9E13016RGT	1/2	1/2	.470	5/8	4	2	.060	2
6859671	2AL9E16018RET	5/8	5/8	.588	3/4	5	2 1/2	.030	2
6859672	2AL9E16018RGT	5/8	5/8	.588	3/4	5	2 1/2	.060	2
6859674	2AL9E19019RET	3/4	3/4	.705	1	5	3	.030	2
6859675	2AL9E19019RGT	3/4	3/4	.705	1	5	3	.060	2
6859677	2AL9E2501ARET	1	1	.940	1 1/4	5 1/2	3	.030	2
6859678	2AL9E2501ARGT	1	1	.940	1 1/4	5 1/2	3	.060	2

INDEXABLE MILLING

**ALUFLASH • Series 2AF9 • Square End • 2 Flute • Regular Length • Long Neck • Cylindrical Shank • Inch**

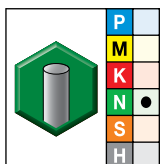
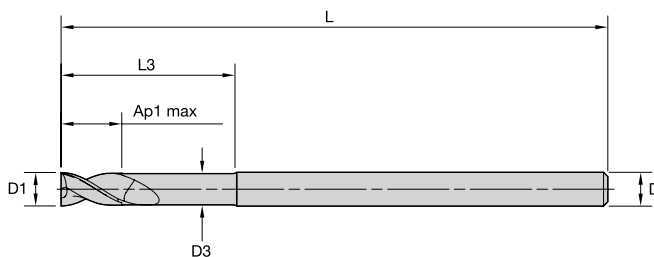

UNCOATED

- first choice
- alternate choice

order #	catalog #	D1	D	D3	length of cut Ap1 max	length L	L3	Z U
6859680	2AF9E03020SZT	1/8	1/8	.118	3/16	2	5/8	2
6859682	2AF9E05021SZT	3/16	3/16	.176	1/4	2 1/4	1	2
6859684	2AF9E07023SZT	1/4	1/4	.235	5/16	3	1 1/4	2
6859687	2AF9E08024SZT	5/16	5/16	.294	3/8	3	1 1/2	2
6859690	2AF9E10025SZT	3/8	3/8	.353	1/2	3 1/2	2	2
6859693	2AF9E13026SZT	1/2	1/2	.470	5/8	4 1/2	2 1/2	2
6859696	2AF9E16028SZT	5/8	5/8	.588	3/4	5	3 1/4	2
6859699	2AF9E19029SZT	3/4	3/4	.705	1	5 1/2	3 1/2	2
6859702	2AF9E2502ASZT	1	1	.940	1 1/4	6 1/2	3 3/4	2

HOLEMAKING

**ALUFLASH • Series 2AF9 • Radius • 2 Flute • Regular Length • Long Neck • Cylindrical Shank • Inch**

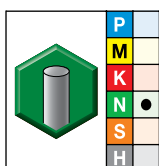
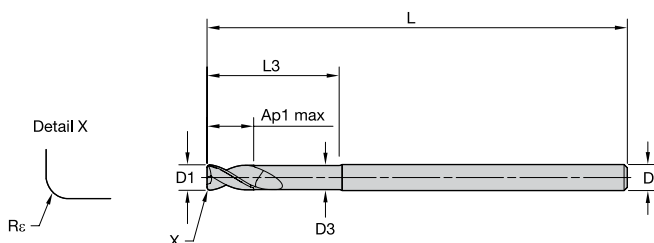

UNCOATED

- first choice
- alternate choice

order #	catalog #	D1	D	D3	length of cut Ap1 max	length L	L3	Re	Z U
6859681	2AF9E03020RAT	1/8	1/8	.118	3/16	2	5/8	.015	2
6859683	2AF9E05021RAT	3/16	3/16	.176	1/4	2 1/4	1	.015	2
6859685	2AF9E07023RET	1/4	1/4	.235	5/16	3	1 1/4	.030	2
6859686	2AF9E07023RGT	1/4	1/4	.235	5/16	3	1 1/4	.060	2
6859688	2AF9E08024RET	5/16	5/16	.294	3/8	3	1 1/2	.030	2
6859689	2AF9E08024RGT	5/16	5/16	.294	3/8	3	1 1/2	.060	2
6859691	2AF9E10025RET	3/8	3/8	.353	1/2	3 1/2	2	.030	2
6859692	2AF9E10025RGT	3/8	3/8	.353	1/2	3 1/2	2	.060	2
6859694	2AF9E13026RET	1/2	1/2	.470	5/8	4 1/2	2 1/2	.030	2
6859695	2AF9E13026RGT	1/2	1/2	.470	5/8	4 1/2	2 1/2	.060	2
6859697	2AF9E16028RET	5/8	5/8	.588	3/4	5	3 1/4	.030	2
6859698	2AF9E16028RGT	5/8	5/8	.588	3/4	5	3 1/4	.060	2
6859700	2AF9E19029RET	3/4	3/4	.705	1	5 1/2	3 1/2	.030	2
6859701	2AF9E19029RGT	3/4	3/4	.705	1	5 1/2	3 1/2	.060	2
6859703	2AF9E2502ARET	1	1	.940	1 1/4	6 1/2	3 3/4	.030	2
6859704	2AF9E2502ARGT	1	1	.940	1 1/4	6 1/2	3 3/4	.060	2

TAPPING

TURNING

ALUFLASH • Series 3A09 • Square End • 3 Flute • Regular Length • Cylindrical Shank • Inch

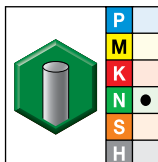
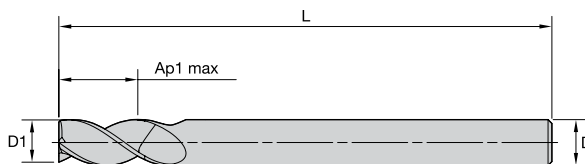

UNCOATED

- first choice
- alternate choice

order #	catalog #	D1	D	length of cut Ap1 max	length L	Z U
6853347	3A09E05001SZT	3/16	3/16	5/16	2	3
6853349	3A09E07003SZT	1/4	1/4	3/8	2	3
6853352	3A09E08004SZT	5/16	5/16	5/8	2 1/2	3
6853354	3A09E10005SZT	3/8	3/8	1	3	3
6853358	3A09E13006SZT	1/2	1/2	1 1/4	3 1/2	3
6853363	3A09E16008SZT	5/8	5/8	1 1/2	3 1/2	3
6853366	3A09E19009SZT	3/4	3/4	1 5/8	4	3
6853371	3A09E2500ASZT	1	1	2 1/2	5 1/2	3

ALUFLASH • Series 3A09 • Radius • 3 Flute • Regular Length • Cylindrical Shank • Inch

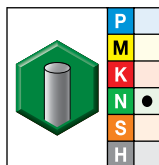
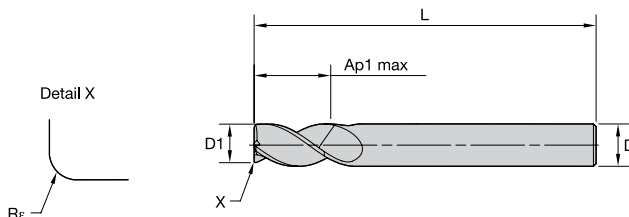

UNCOATED

- first choice
- alternate choice

order #	catalog #	D1	D	length of cut Ap1 max	length L	Re	Z U
6853348	3A09E05001RAT	3/16	3/16	5/16	2	.015	3
6853350	3A09E07003RAT	1/4	1/4	3/8	2	.015	3
6853351	3A09E07003RET	1/4	1/4	3/8	2	.030	3
6853353	3A09E08004RAT	5/16	5/16	5/8	2 1/2	.015	3
6853355	3A09E10005RAT	3/8	3/8	1	3	.015	3
6853356	3A09E10005RET	3/8	3/8	1	3	.030	3
6853357	3A09E10005RGT	3/8	3/8	1	3	.060	3
6853359	3A09E13006RAT	1/2	1/2	1 1/4	3 1/2	.015	3
6853360	3A09E13006RET	1/2	1/2	1 1/4	3 1/2	.030	3
6853361	3A09E13006RGT	1/2	1/2	1 1/4	3 1/2	.060	3
6853362	3A09E13006RKT	1/2	1/2	1 1/4	3 1/2	.120	3
6853364	3A09E16008RGT	5/8	5/8	1 1/2	3 1/2	.060	3
6853365	3A09E16008RKT	5/8	5/8	1 1/2	3 1/2	.120	3
6853367	3A09E19009RET	3/4	3/4	1 5/8	4	.030	3
6853368	3A09E19009RGT	3/4	3/4	1 5/8	4	.060	3
6853369	3A09E19009RKT	3/4	3/4	1 5/8	4	.120	3
6853370	3A09E19009RPT	3/4	3/4	1 5/8	4	.190	3
6853372	3A09E2500ARET	1	1	2 1/2	5 1/2	.030	3
6853373	3A09E2500ARGT	1	1	2 1/2	5 1/2	.060	3
6853374	3A09E2500ARJT	1	1	2 1/2	5 1/2	.090	3
6853375	3A09E2500ARKT	1	1	2 1/2	5 1/2	.120	3
6853376	3A09E2500ARPT	1	1	2 1/2	5 1/2	.190	3
6853377	3A09E2500ARQT	1	1	2 1/2	5 1/2	.250	3

INDEXABLE MILLING

SOLID END MILLING

HOLEMAKING

TAPPING

TURNING

## ALUFLASH • Series 3A19 • Square End • 3 Flute • Medium Length • Cylindrical Shank • Inch

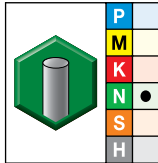
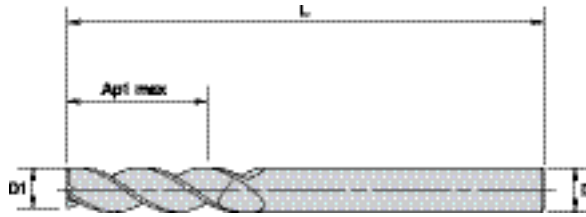

UNCOATED

- first choice
- alternate choice

order #	catalog #	D1	D	length of cut Ap1 max	length L	Z U
6853307	3A19E05011SZT	3/16	3/16	5/8	2	3
6853309	3A19E07013SZT	1/4	1/4	3/4	2 1/2	3
6853323	3A19E10015SZT	3/8	3/8	1 1/2	4	3
6853327	3A19E13016SZT	1/2	1/2	2	4	3
6853331	3A19E16018SZT	5/8	5/8	2	5	3
6853335	3A19E19019SZT	3/4	3/4	2 1/2	5	3
6853339	3A19E2501ASZT	1	1	3 1/4	6 1/2	3

## ALUFLASH • Series 3A19 • Radius • 3 Flute • Medium Length • Cylindrical Shank • Inch

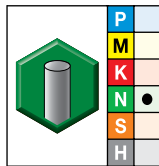
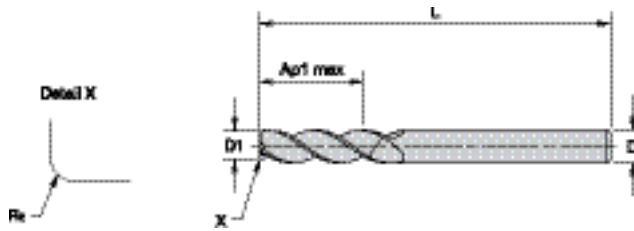

UNCOATED

- first choice
- alternate choice

order #	catalog #	D1	D	length of cut Ap1 max	length L	Re	Z U
6853308	3A19E05011RAT	3/16	3/16	5/8	2	.015	3
6853310	3A19E07013RAT	1/4	1/4	3/4	2 1/2	.015	3
6853321	3A19E07013RET	1/4	1/4	3/4	2 1/2	.030	3
6853322	3A19E07013RGT	1/4	1/4	3/4	2 1/2	.060	3
6853324	3A19E10015RAT	3/8	3/8	1 1/2	4	.015	3
6853325	3A19E10015RET	3/8	3/8	1 1/2	4	.030	3
6853326	3A19E10015RGT	3/8	3/8	1 1/2	4	.060	3
6853328	3A19E13016RET	1/2	1/2	2	4	.030	3
6853329	3A19E13016RGT	1/2	1/2	2	4	.060	3
6853330	3A19E13016RKT	1/2	1/2	2	4	.120	3
6853332	3A19E16018RET	5/8	5/8	2	5	.030	3
6853333	3A19E16018RGT	5/8	5/8	2	5	.060	3
6853334	3A19E16018RKT	5/8	5/8	2	5	.120	3
6853336	3A19E19019RET	3/4	3/4	2 1/2	5	.030	3
6853337	3A19E19019RGT	3/4	3/4	2 1/2	5	.060	3
6853338	3A19E19019RKT	3/4	3/4	2 1/2	5	.120	3
6853340	3A19E2501ARET	1	1	3 1/4	6 1/2	.030	3
6853341	3A19E2501ARGT	1	1	3 1/4	6 1/2	.060	3
6853342	3A19E2501ARJT	1	1	3 1/4	6 1/2	.090	3
6853343	3A19E2501ARKT	1	1	3 1/4	6 1/2	.120	3
6853344	3A19E2501ARPT	1	1	3 1/4	6 1/2	.190	3
6853345	3A19E2501ARQT	1	1	3 1/4	6 1/2	.250	3

ALUFLASH • Series 3A29 • Square End • 3 Flute • Long Length • Cylindrical Shank • Inch

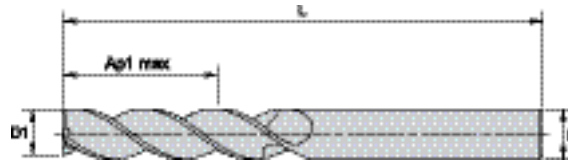

UNCOATED

- first choice
- alternate choice

order #	catalog #	D1	D	length of cut Ap1 max	length L	Z U
6853216	3A29E07023SZT	1/4	1/4	1	3 1/4	3
6853220	3A29E08024SZT	5/16	5/16	1 1/4	3	3
6853282	3A29E10025SZT	3/8	3/8	1 3/4	4	3
6853285	3A29E13026SZT	1/2	1/2	2 1/4	4 1/2	3
6853289	3A29E19029SZT	3/4	3/4	3	5 1/2	3
6853303	3A29E2502ASZT	1	1	4	7	3

ALUFLASH • Series 3A29 • Radius • 3 Flute • Long Length • Cylindrical Shank • Inch

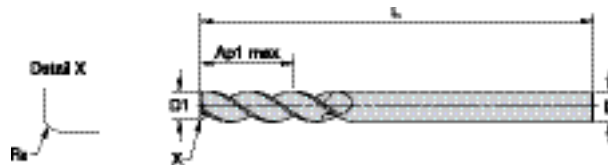

UNCOATED

- first choice
- alternate choice

order #	catalog #	D1	D	length of cut Ap1 max	length L	Re	Z U
6853217	3A29E07023RAT	1/4	1/4	1	3 1/4	.015	3
6853218	3A29E07023RET	1/4	1/4	1	3 1/4	.030	3
6853219	3A29E07023RGT	1/4	1/4	1	3 1/4	.060	3
6853281	3A29E08024RAT	5/16	5/16	1 1/4	3	.015	3
6853283	3A29E10025RET	3/8	3/8	1 3/4	4	.030	3
6853284	3A29E10025RGT	3/8	3/8	1 3/4	4	.060	3
6853286	3A29E13026RET	1/2	1/2	2 1/4	4 1/2	.030	3
6853287	3A29E13026RGT	1/2	1/2	2 1/4	4 1/2	.060	3
6853288	3A29E13026RKT	1/2	1/2	2 1/4	4 1/2	.120	3
6853290	3A29E19029RET	3/4	3/4	3	5 1/2	.030	3
6853301	3A29E19029RGT	3/4	3/4	3	5 1/2	.060	3
6853302	3A29E19029RKT	3/4	3/4	3	5 1/2	.120	3
6853304	3A29E2502ARET	1	1	4	7	.030	3
6853305	3A29E2502ARGT	1	1	4	7	.060	3
6853306	3A29E2502ARKT	1	1	4	7	.120	3

INDEXABLE MILLING

**ALUFLASH • Series 3AN9 • Square End • 3 Flute • Regular Length • Regular Neck • Cylindrical Shank • Inch**

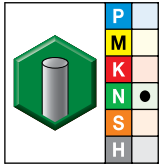
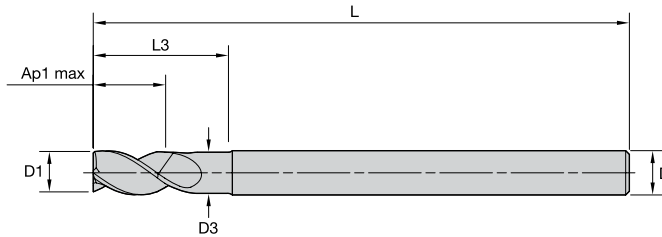

UNCOATED

- first choice
- alternate choice

order #	catalog #	D1	D	D3	length of cut Ap1 max	length L	L3	Z U
6859706	3AN9E05001SZT	3/16	3/16	.176	1/4	2 1/4	9/16	3
6859708	3AN9E07003SZT	1/4	1/4	.235	5/16	2 1/2	3/4	3
6859711	3AN9E08004SZT	5/16	5/16	.294	3/8	2 1/2	1	3
6859715	3AN9E10005SZT	3/8	3/8	.353	1/2	3	1 1/4	3
6859718	3AN9E13006SZT	1/2	1/2	.470	5/8	3 1/2	1 1/2	3
6859721	3AN9E16008SZT	5/8	5/8	.588	3/4	4	2	3
6859724	3AN9E19009SZT	3/4	3/4	.705	1	5	2 1/4	3
6859727	3AN9E2500ASZT	1	1	.940	1 1/4	5 1/2	2 1/2	3

HOLEMAKING

**ALUFLASH • Series 3AN9 • Radius • 3 Flute • Regular Length • Regular Neck • Cylindrical Shank • Inch**

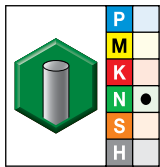
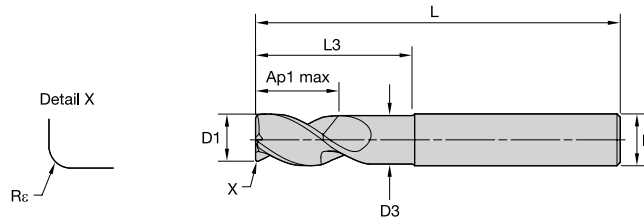

UNCOATED

- first choice
- alternate choice

order #	catalog #	D1	D	D3	length of cut Ap1 max	length L	L3	R <sub>e</sub>	Z U
6859707	3AN9E05001RAT	3/16	3/16	.176	1/4	2 1/4	9/16	.015	3
6859709	3AN9E07003RET	1/4	1/4	.235	5/16	2 1/2	3/4	.030	3
6859710	3AN9E07003RGT	1/4	1/4	.235	5/16	2 1/2	3/4	.060	3
6859712	3AN9E08004RET	5/16	5/16	.294	3/8	2 1/2	1	.030	3
6859714	3AN9E08004RGT	5/16	5/16	.294	3/8	2 1/2	1	.060	3
6859716	3AN9E10005RET	3/8	3/8	.353	1/2	3	1 1/4	.030	3
6859717	3AN9E10005RGT	3/8	3/8	.353	1/2	3	1 1/4	.060	3
6859719	3AN9E13006RET	1/2	1/2	.470	5/8	3 1/2	1 1/2	.030	3
6859720	3AN9E13006RGT	1/2	1/2	.470	5/8	3 1/2	1 1/2	.060	3
6859722	3AN9E16008RET	5/8	5/8	.588	3/4	4	2	.030	3
6859723	3AN9E16008RGT	5/8	5/8	.588	3/4	4	2	.060	3
6859725	3AN9E19009RET	3/4	3/4	.705	1	5	2 1/4	.030	3
6859726	3AN9E19009RGT	3/4	3/4	.705	1	5	2 1/4	.060	3
6859728	3AN9E2500ARET	1	1	.940	1 1/4	5 1/2	2 1/2	.030	3
6859729	3AN9E2500ARGT	1	1	.940	1 1/4	5 1/2	2 1/2	.060	3

TAPPING

TURNING

**ALUFLASH • Series 3AF9 • Square End • 3 Flute • Regular Length • Long Neck • Cylindrical Shank • Inch**

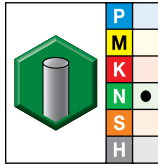
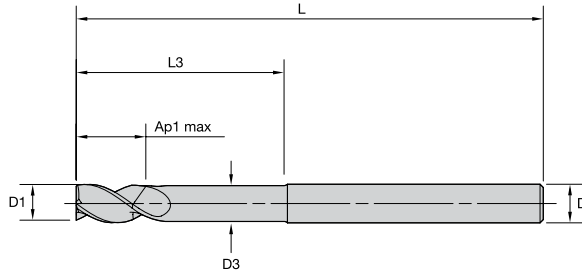

UNCOATED

- first choice
- alternate choice

order #	catalog #	D1	D	D3	length of cut Ap1 max	length L	L3	Z U
6859818	3AF9E05021SZT	3/16	3/16	.176	1/4	2 1/4	1	3
6859820	3AF9E07023SZT	1/4	1/4	.235	5/16	3	1 1/4	3
6859843	3AF9E08024SZT	5/16	5/16	.294	3/8	3	1 1/2	3
6859846	3AF9E10025SZT	3/8	3/8	.353	1/2	3 1/2	2	3
6859849	3AF9E13026SZT	1/2	1/2	.470	5/8	4 1/2	2 1/2	3
6859862	3AF9E16028SZT	5/8	5/8	.588	3/4	5	3 1/4	3
6859866	3AF9E19029SZT	3/4	3/4	.705	1	5 1/2	3 1/2	3
6859869	3AF9E2502ASZT	1	1	.940	1 1/4	6 1/2	3 3/4	3

**ALUFLASH • Series 3AF9 • Radius • 3 Flute • Regular Length • Long Neck • Cylindrical Shank • Inch**

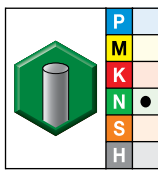
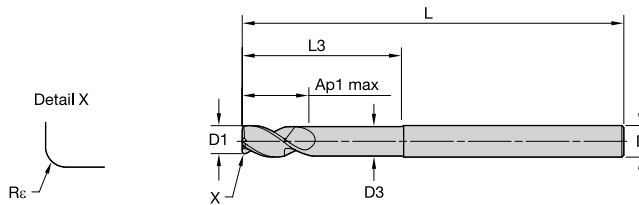

UNCOATED

- first choice
- alternate choice

order #	catalog #	D1	D	D3	length of cut Ap1 max	length L	L3	Rε	Z U
6859819	3AF9E05021RAT	3/16	3/16	.176	1/4	2 1/4	1	.015	3
6859841	3AF9E07023RET	1/4	1/4	.235	5/16	3	1 1/4	.030	3
6859842	3AF9E07023RGT	1/4	1/4	.235	5/16	3	1 1/4	.060	3
6859844	3AF9E08024RET	5/16	5/16	.294	3/8	3	1 1/2	.030	3
6859845	3AF9E08024RGT	5/16	5/16	.294	3/8	3	1 1/2	.060	3
6859847	3AF9E10025RET	3/8	3/8	.353	1/2	3 1/2	2	.030	3
6859848	3AF9E10025RGT	3/8	3/8	.353	1/2	3 1/2	2	.060	3
6859850	3AF9E13026RET	1/2	1/2	.470	5/8	4 1/2	2 1/2	.030	3
6859861	3AF9E13026RGT	1/2	1/2	.470	5/8	4 1/2	2 1/2	.060	3
6859864	3AF9E16028RET	5/8	5/8	.588	3/4	5	3 1/4	.030	3
6859865	3AF9E16028RGT	5/8	5/8	.588	3/4	5	3 1/4	.060	3
6859867	3AF9E19029RET	3/4	3/4	.705	1	5 1/2	3 1/2	.030	3
6859868	3AF9E19029RGT	3/4	3/4	.705	1	5 1/2	3 1/2	.060	3
6859870	3AF9E2502ARET	1	1	.940	1 1/4	6 1/2	3 3/4	.030	3
6859871	3AF9E2502ARGT	1	1	.940	1 1/4	6 1/2	3 3/4	.060	3



**ALUFLASH • Series 3AL9 • Square End • 3 Flute • Regular Length • Medium Neck • Cylindrical Shank • Inch**

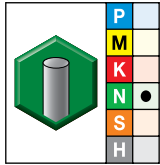
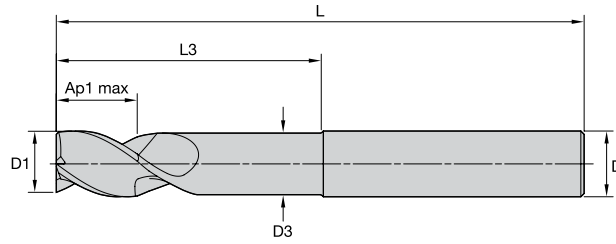

UNCOATED

- first choice
- alternate choice

order #	catalog #	D1	D	D3	length of cut Ap1 max	length L	L3	Z U
6859740	3AL9E05011SZT	3/16	3/16	.176	1/4	2 1/4	3/4	3
6859783	3AL9E07013SZT	1/4	1/4	.235	5/16	2 1/2	1	3
6859786	3AL9E08014SZT	5/16	5/16	.294	3/8	3	1 1/4	3
6859789	3AL9E10015SZT	3/8	3/8	.353	1/2	3	1 1/2	3
6859802	3AL9E13016SZT	1/2	1/2	.470	5/8	4	2	3
6859805	3AL9E16018SZT	5/8	5/8	.588	3/4	5	2 1/2	3
6859808	3AL9E19019SZT	3/4	3/4	.705	1	5	3	3
6859811	3AL9E2501ASZT	1	1	.940	1 1/4	5 1/2	3	3

**ALUFLASH • Series 3AL9 • Radiused • 3 Flute • Regular Length • Medium Neck • Cylindrical Shank • Inch**

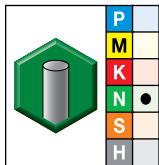
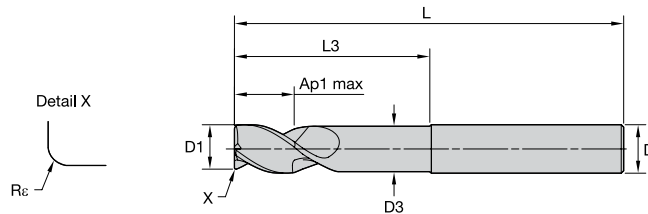

UNCOATED

- first choice
- alternate choice

order #	catalog #	D1	D	D3	length of cut Ap1 max	length L	L3	Re	Z U
6859781	3AL9E05011RAT	3/16	3/16	.176	1/4	2 1/4	3/4	.015	3
6859784	3AL9E07013RET	1/4	1/4	.235	5/16	2 1/2	1	.030	3
6859785	3AL9E07013RGT	1/4	1/4	.235	5/16	2 1/2	1	.060	3
6859787	3AL9E08014RET	5/16	5/16	.294	3/8	3	1 1/4	.030	3
6859788	3AL9E08014RGT	5/16	5/16	.294	3/8	3	1 1/4	.060	3
6859790	3AL9E10015RET	3/8	3/8	.353	1/2	3	1 1/2	.030	3
6859801	3AL9E10015RGT	3/8	3/8	.353	1/2	3	1 1/2	.060	3
6859803	3AL9E13016RET	1/2	1/2	.470	5/8	4	2	.030	3
6859804	3AL9E13016RGT	1/2	1/2	.470	5/8	4	2	.060	3
6859806	3AL9E16018RET	5/8	5/8	.588	3/4	5	2 1/2	.030	3
6859807	3AL9E16018RGT	5/8	5/8	.588	3/4	5	2 1/2	.060	3
6859809	3AL9E19019RET	3/4	3/4	.705	1	5	3	.030	3
6859810	3AL9E19019RGT	3/4	3/4	.705	1	5	3	.060	3
6859812	3AL9E2501ARET	1	1	.940	1 1/4	5 1/2	3	.030	3
6859813	3AL9E2501ARGT	1	1	.940	1 1/4	5 1/2	3	.060	3

ALUFLASH • Series 2A09 • Square End • 2 Flute • Regular Length • Cylindrical Shank • Metric

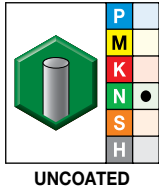
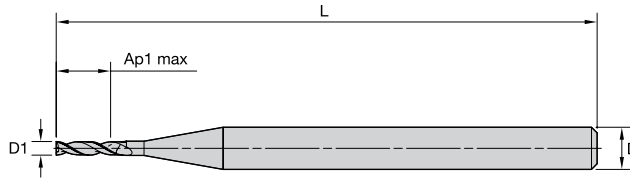

- first choice
- alternate choice

order #	catalog #	D1	D	length of cut Ap1 max	length L	Z U
6853514	2A09M01000SZT	1,0	3	4,00	38	2
6853515	2A09M01500SZT	1,5	3	6,00	38	2
6853517	2A09M02000SZT	2,0	3	8,00	38	2
6853519	2A09M02500SZT	2,5	3	9,00	38	2
6853542	2A09M04001SZT	4,0	4	12,00	50	2
6853544	2A09M05002SZT	5,0	5	14,00	50	2
6853547	2A09M06003SZT	6,0	6	16,00	50	2
6853549	2A09M08004SZT	8,0	8	20,00	63	2
6853552	2A09M12006SZT	12,0	12	25,00	76	2
6853554	2A09M16008SZT	16,0	16	32,00	89	2
6853556	2A09M20009SZT	20,0	20	40,00	104	2

ALUFLASH • Series 2A09 • Radius • 2 Flute • Regular Length • Cylindrical Shank • Metric

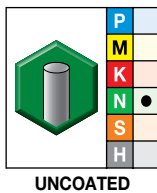
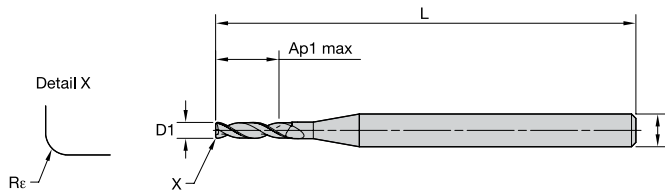

- first choice
- alternate choice

order #	catalog #	D1	D	length of cut Ap1 max	length L	Re	Z U
6853516	2A09M01500RAT	1,5	3	6,00	38	0,20	2
6853518	2A09M02000RAT	2,0	3	8,00	38	0,20	2
6853520	2A09M02500RAT	2,5	3	9,00	38	0,20	2
6853541	2A09M03000RAT	3,0	3	12,00	38	0,20	2
6853543	2A09M04001RAT	4,0	4	12,00	50	0,20	2
6853546	2A09M05002RAT	5,0	5	14,00	50	0,20	2
6853548	2A09M06003RET	6,0	6	16,00	50	0,50	2
6853550	2A09M08004RET	8,0	8	20,00	63	0,50	2
6853551	2A09M10005RJT	10,0	10	22,00	76	1,00	2
6853553	2A09M12006RJT	12,0	12	25,00	76	1,00	2
6853555	2A09M16008RJT	16,0	16	32,00	89	1,00	2
6853557	2A09M20009RJT	20,0	20	40,00	104	1,00	2

INDEXABLE MILLING

## ALUFLASH • Series 3A09 • Square End • 3 Flute • Regular Length • Cylindrical Shank • Metric

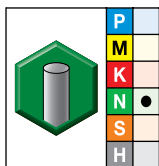
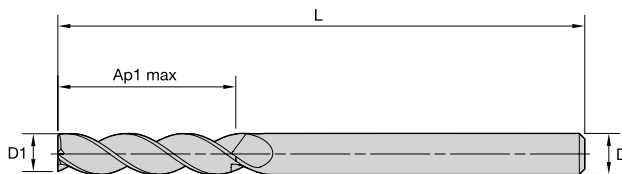

UNCOATED

- first choice
- alternate choice

order #	catalog #	D1	D	length of cut Ap1 max	length L	Z U
6853511	3A09M03000SZT	3,0	3	12,00	38	3

SOLID END MILLING

HOLEMAKING

## ALUFLASH • Series 3A09 • Radius • 3 Flute • Regular Length • Cylindrical Shank • Metric

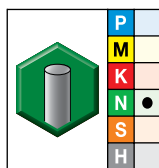
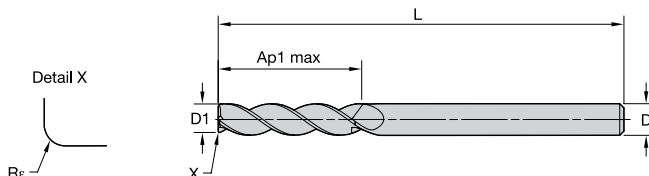

UNCOATED

- first choice
- alternate choice

order #	catalog #	D1	D	length of cut Ap1 max	length L	Re	Z U
6853512	3A09M03000RAT	3,0	3	12,00	38	0,20	3
6853513	3A09M04001RET	4,0	4	12,00	63	0,50	3

TAPPING

TURNING

## ALUFLASH • Series 3AN9 • Square End • 3 Flute • Regular Length • Regular Neck • Cylindrical Shank • Metric

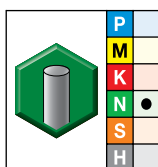
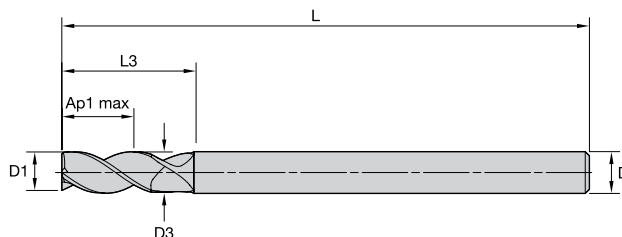

UNCOATED

- first choice
- alternate choice

order #	catalog #	D1	D	D3	length of cut Ap1 max	length L	L3	Z U
6853460	3AN9M04001SZT	4,0	4	3,76	8,00	50	12,00	3
6853462	3AN9M05002SZT	5,0	5	4,70	10,00	63	15,00	3
6853465	3AN9M06003SZT	6,0	6	5,64	13,00	63	18,00	3
6853469	3AN9M08004SZT	8,0	8	7,52	18,00	76	24,00	3
6853474	3AN9M10005SZT	10,0	10	9,40	22,00	76	30,00	3
6853479	3AN9M12006SZT	12,0	12	11,28	25,00	76	36,00	3
6853486	3AN9M16008SZT	16,0	16	15,04	32,00	89	48,00	3
6853494	3AN9M20009SZT	20,0	20	18,80	40,00	115	60,00	3

**ALUFLASH • Series 3AN9 • Radius • 3 Flute • Regular Length • Regular Neck • Cylindrical Shank • Metric**

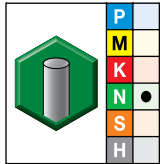

UNCOATED

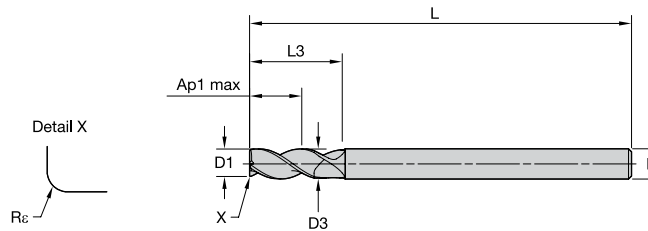

- first choice
- alternate choice

order #	catalog #	D1	D	D3	length of cut Ap1 max	length L	L3	Re	Z U
6853461	3AN9M04001RAT	4,0	4	3,76	8,00	50	12,00	0,20	3
6853463	3AN9M05002RAT	5,0	5	4,70	10,00	63	15,00	0,20	3
6853464	3AN9M05002RET	5,0	5	4,70	10,00	63	15,00	0,50	3
6853466	3AN9M06003RAT	6,0	6	5,64	13,00	63	18,00	0,20	3
6853467	3AN9M06003RET	6,0	6	5,64	13,00	63	18,00	0,50	3
6853468	3AN9M06003RJT	6,0	6	5,64	13,00	63	18,00	1,00	3
6853470	3AN9M08004RAT	8,0	8	7,52	18,00	76	24,00	0,20	3
6853471	3AN9M08004RET	8,0	8	7,52	18,00	76	24,00	0,50	3
6853473	3AN9M08004RHT	8,0	8	7,52	18,00	76	24,00	1,50	3
6853472	3AN9M08004RJT	8,0	8	7,52	18,00	76	24,00	1,00	3
6853475	3AN9M10005RAT	10,0	10	9,40	22,00	76	30,00	0,20	3
6853476	3AN9M10005RET	10,0	10	9,40	22,00	76	30,00	0,50	3
6853478	3AN9M10005RHT	10,0	10	9,40	22,00	76	30,00	1,50	3
6853477	3AN9M10005RJT	10,0	10	9,40	22,00	76	30,00	1,00	3
6853480	3AN9M12006RAT	12,0	12	11,28	25,00	76	36,00	0,20	3
6853481	3AN9M12006RET	12,0	12	11,28	25,00	76	36,00	0,50	3
6853483	3AN9M12006RHT	12,0	12	11,28	25,00	76	36,00	1,50	3
6853482	3AN9M12006RJT	12,0	12	11,28	25,00	76	36,00	1,00	3
6853484	3AN9M12006RKT	12,0	12	11,28	25,00	76	36,00	2,00	3
6853485	3AN9M12006RPT	12,0	12	11,28	25,00	76	36,00	3,00	3
6853487	3AN9M16008RAT	16,0	16	15,04	32,00	89	48,00	0,20	3
6853488	3AN9M16008RET	16,0	16	15,04	32,00	89	48,00	0,50	3
6853490	3AN9M16008RHT	16,0	16	15,04	32,00	89	48,00	1,50	3
6853489	3AN9M16008RJT	16,0	16	15,04	32,00	89	48,00	1,00	3
6853491	3AN9M16008RMT	16,0	16	15,04	32,00	89	48,00	2,50	3
6853492	3AN9M16008RPT	16,0	16	15,04	32,00	89	48,00	3,00	3
6853493	3AN9M16008RQT	16,0	16	15,04	32,00	89	48,00	4,00	3
6853495	3AN9M20009RAT	20,0	20	18,80	40,00	115	60,00	0,20	3
6853496	3AN9M20009RHT	20,0	20	18,80	40,00	115	60,00	1,50	3
6853497	3AN9M20009RKT	20,0	20	18,80	40,00	115	60,00	2,00	3
6853498	3AN9M20009RPT	20,0	20	18,80	40,00	115	60,00	3,00	3
6853499	3AN9M20009RQT	20,0	20	18,80	40,00	115	60,00	4,00	3
6853500	3AN9M20009RRT	20,0	20	18,80	40,00	115	60,00	5,00	3

INDEXABLE MILLING

SOLID END MILLING

HOLEMAKING

TAPPING

TURNING

INDEXABLE MILLING

**ALUFLASH • Series 3AP9 • Radius • 3 Flute • Long Length • Regular Neck • Cylindrical Shank • Metric**

SOLID END MILLING

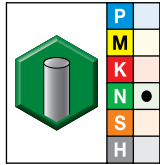
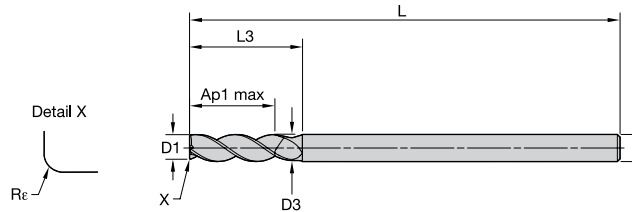

UNCOATED

- first choice
- alternate choice

HOLEMAKING

order #	catalog #	D1	D	D3	length of cut Ap1 max	length L	L3	Re	Z U
6853439	3AP9M04011RAT	4,0	4	3,76	12,00	63	16,00	0,20	3
6853440	3AP9M05002RAT	5,0	5	4,70	15,00	63	20,00	0,20	3
6853441	3AP9M06013RET	6,0	6	5,64	18,00	76	24,00	0,50	3
6853442	3AP9M06013RJT	6,0	6	5,64	18,00	76	24,00	1,00	3
6853443	3AP9M08014RET	8,0	8	7,52	24,00	76	32,00	0,50	3
6853444	3AP9M08014RJT	8,0	8	7,52	24,00	76	32,00	1,00	3
6853445	3AP9M10015RET	10,0	10	9,40	30,00	89	40,00	0,50	3
6853446	3AP9M10015RHT	10,0	10	9,40	30,00	89	40,00	1,50	3
6853447	3AP9M10015RKT	10,0	10	9,40	30,00	89	40,00	2,00	3
6853449	3AP9M12016RET	12,0	12	11,28	36,00	100	48,00	0,50	3
6853450	3AP9M12016RHT	12,0	12	11,28	36,00	100	48,00	1,50	3
6853451	3AP9M12016RPT	12,0	12	11,28	36,00	100	48,00	3,00	3
6853452	3AP9M16018RET	16,0	16	15,04	48,00	110	64,00	0,50	3
6853453	3AP9M16018RHT	16,0	16	15,04	48,00	110	64,00	1,50	3
6853454	3AP9M16018RPT	16,0	16	15,04	48,00	110	64,00	3,00	3
6853455	3AP9M20019RET	20,0	20	18,80	60,00	150	80,00	0,50	3
6853456	3AP9M20019RHT	20,0	20	18,80	60,00	150	80,00	1,50	3
6853457	3AP9M20019RKT	20,0	20	18,80	60,00	150	80,00	2,00	3
6853458	3AP9M20019RPT	20,0	20	18,80	60,00	150	80,00	3,00	3
6853459	3AP9M20019RQT	20,0	20	18,80	60,00	150	80,00	4,00	3

TAPPING

**ALUFLASH • Series 3AP9 • Square End • 3 Flute • Long Length • Regular Neck • Cylindrical Shank • Metric**

TURNING

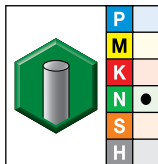
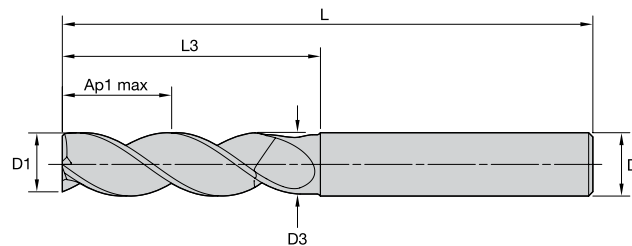





UNCOATED

- first choice
- alternate choice

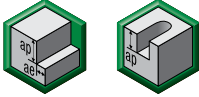
order #	catalog #	D1	D	D3	length of cut Ap1 max	length L	L3	Z U
6853448	3AP9M12016SZT	12,0	12	11,28	36,00	100	48,00	3

ALUFLASH • Side Milling and Slotting • Application Data • Inch

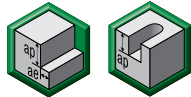
																					
		<b>Side Milling (A) and Slotting (B)</b>		<b>UNCOATED</b>			<b>Recommended feed per tooth (Fz = IPT) for side milling (A). For slotting (B), reduce Fz by 20%.</b>														
		<b>A</b>		<b>B</b>	<b>Cutting Speed – Vc SFM</b>			<b>D1 – Diameter</b>													
<b>Material Group</b>	<b>ap</b>	<b>ae</b>	<b>ap</b>	<b>min</b>	<b>Start</b>	<b>max</b>	<b>Fraction</b>	<b>1/8</b>	<b>5/32</b>	<b>3/16</b>	<b>1/4</b>	<b>5/16</b>	<b>3/8</b>	<b>1/2</b>	<b>9/16</b>	<b>5/8</b>	<b>23/32</b>	<b>3/4</b>	<b>1</b>		
<b>N</b>	1	Ap1 max	0,5 x D1	1 x D1	1500	1800	6000	IPT	.0009	.0017	.0022	.0026	.0035	.0043	.0052	.0060	.0069	.0078	.0087	.0108	
	2	Ap1 max	0,5 x D1	1 x D1	1500	1800	4500	IPT	.0008	.0016	.0019	.0023	.0031	.0039	.0047	.0054	.0062	.0070	.0078	.0097	
	3	Ap1 max	0,5 x D1	1 x D1	1500	1800	4500	IPT	.0006	.0012	.0015	.0018	.0024	.0030	.0036	.0042	.0048	.0054	.0061	.0076	
	4	Ap1 max	0,5 x D1	1 x D1	1200	1350	2250	IPT	.0006	.0012	.0015	.0018	.0024	.0030	.0036	.0042	.0048	.0054	.0061	.0076	
	5	Ap1 max	0,5 x D1	1 x D1	750	1200	3000	IPT	.0008	.0016	.0020	.0023	.0031	.0039	.0047	.0054	.0062	.0070	.0078	.0097	

																					
		<b>Side Milling (A) and Slotting (B)</b>		<b>UNCOATED</b>			<b>Recommended feed per tooth (Fz = IPT) for side milling (A). For slotting (B), reduce Fz by 20%.</b>														
		<b>A</b>		<b>B</b>	<b>Cutting Speed – Vc SFM</b>			<b>D1 – Diameter</b>													
<b>Material Group</b>	<b>ap</b>	<b>ae</b>	<b>ap</b>	<b>min</b>	<b>Start</b>	<b>max</b>	<b>Fraction</b>	<b>1/8</b>	<b>5/32</b>	<b>3/16</b>	<b>1/4</b>	<b>5/16</b>	<b>3/8</b>	<b>1/2</b>	<b>9/16</b>	<b>5/8</b>	<b>23/32</b>	<b>3/4</b>	<b>1</b>		
<b>N</b>	1	Ap1 max	0,5 x D1	1 x D	1500	1800	6000	IPT	.0009	.0017	.0022	.0026	.0035	.0043	.0052	.0060	.0069	.0078	.0087	.0108	
	2	Ap1 max	0,5 x D1	1 x D	1500	1800	4500	IPT	.0008	.0016	.0019	.0023	.0031	.0039	.0047	.0054	.0062	.0070	.0078	.0097	
	3	Ap1 max	0,5 x D1	1 x D	1500	1800	4500	IPT	.0006	.0012	.0015	.0018	.0024	.0030	.0036	.0042	.0048	.0054	.0061	.0076	
	4	Ap1 max	0,5 x D1	1 x D	1200	1350	2250	IPT	.0006	.0012	.0015	.0018	.0024	.0030	.0036	.0042	.0048	.0054	.0061	.0076	
	5	Ap1 max	0,5 x D1	1 x D	750	1200	3000	IPT	.0008	.0016	.0020	.0023	.0031	.0039	.0047	.0054	.0062	.0070	.0078	.0097	

ALUFLASH • Ramping 2 Flute • Application Data • Inch



INDEXABLE MILLING



SOLID END MILLING

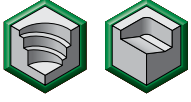

HOLEMAKING

TAPPING

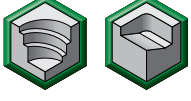

TURNING

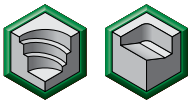

																		
		Helical Interpolation / Ramping 0° - 15°			UNCOATED													
		Cutting Speed – Vc SFM			Recommended feed per tooth (fz = IPT) for helical interpolation and ramping													
					Diameter – D1 [Ømin-Ømax]													
Material Group	Max Depth	min	Start	max	Fraction	1/8	5/32	3/16	1/4	5/16	3/8	1/2	9/16	5/8	23/32	3/4	1	
					Decimals	.180	.297	.356	.475	.594	.713	.950	1.047	1.188	1.346	1.425	1.900	
N	1	1.25 x D1	1500	1800	6000	IPT	.0009	.0017	.0022	.0026	.0035	.0043	.0052	.0060	.0069	.0078	.0087	.0108
	2	1.25 x D1	1500	1800	4500	IPT	.0008	.0016	.0019	.0023	.0031	.0039	.0047	.0054	.0062	.0070	.0078	.0097
	3	1.25 x D1	1500	1800	4500	IPT	.0006	.0012	.0015	.0018	.0024	.0030	.0036	.0042	.0048	.0054	.0061	.0076
	4	1.25 x D1	1200	1350	2250	IPT	.0006	.0012	.0015	.0018	.0024	.0030	.0036	.0042	.0048	.0054	.0061	.0076
	5	1.25 x D1	750	1200	3000	IPT	.0008	.0016	.0020	.0023	.0031	.0039	.0047	.0054	.0062	.0070	.0078	.0097



																		
		Helical Interpolation / Ramping 15° - 30°			UNCOATED													
		Cutting Speed – Vc SFM			Recommended feed per tooth (fz = IPT) for helical interpolation and ramping													
					Diameter – D1 [Ømin-Ømax]													
Material Group	Max Depth	min	Start	max	Fraction	1/8	5/32	3/16	1/4	5/16	3/8	1/2	9/16	5/8	23/32	3/4	1	
					Decimals	.180	.297	.356	.475	.594	.713	.950	1.047	1.188	1.346	1.425	1.900	
N	1	1.25 x D1	1500	1800	4800	IPT	.0006	.0013	.0016	.0019	.0026	.0032	.0039	.0045	.0052	.0058	.0065	.0081
	2	1.25 x D1	1500	1800	3600	IPT	.0006	.0012	.0014	.0018	.0023	.0029	.0035	.0041	.0047	.0053	.0058	.0073
	3	1.25 x D1	1500	1800	3600	IPT	.0005	.0009	.0011	.0014	.0018	.0023	.0027	.0032	.0036	.0041	.0045	.0057
	4	1.25 x D1	1200	1350	1800	IPT	.0005	.0009	.0011	.0014	.0018	.0023	.0027	.0032	.0036	.0041	.0045	.0057
	5	1.25 x D1	750	1200	2400	IPT	.0006	.0012	.0015	.0018	.0023	.0029	.0035	.0041	.0047	.0053	.0058	.0073

																		
		Helical Interpolation / Ramping 30° - 45°			UNCOATED													
		Cutting Speed – Vc SFM			Recommended feed per tooth (fz = IPT) for helical interpolation and ramping													
					Diameter – D1 [Ømin-Ømax]													
Material Group	Max Depth	min	Start	max	Fraction	1/8	5/32	3/16	1/4	5/16	3/8	1/2	9/16	5/8	23/32	3/4	1	
					Decimals	.180	.297	.356	.475	.594	.713	.950	1.047	1.188	1.346	1.425	1.900	
N	1	1.25 x D1	1260	1500	2400	IPT	.0005	.0010	.0013	.0016	.0021	.0026	.0031	.0036	.0042	.0047	.0052	.0065
	2	1.25 x D1	1260	1500	2400	IPT	.0005	.0009	.0011	.0014	.0019	.0023	.0028	.0033	.0037	.0042	.0047	.0058
	3	1.25 x D1	1260	1500	2400	IPT	.0004	.0007	.0009	.0011	.0015	.0018	.0022	.0025	.0029	.0033	.0036	.0045
	4	1.25 x D1	1020	1140	1350	IPT	.0004	.0007	.0009	.0011	.0015	.0018	.0022	.0025	.0029	.0033	.0036	.0045
	5	1.25 x D1	630	1020	1800	IPT	.0005	.0009	.0012	.0014	.0019	.0023	.0028	.0033	.0037	.0042	.0047	.0058

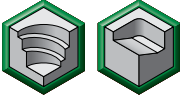
ALUFLASH • Ramping 3 Flute • Application Data • Inch

Material Group	Max Depth	Helical Interpolation / Ramping			 													
		0° - 15°			UNCOATED													
		Cutting Speed – Vc m/min			Recommended feed per tooth (fz = IPT) for helical interpolation and ramping – fz x 1													
					Diameter – D1 [Ømin-Ømax]													
		min	Start	max	Fraction	1/8	5/32	3/16	1/4	5/16	3/8	1/2	9/16	5/8	23/32	3/4	1	
					Decimals	.180	.180	.216	.288	.359	.431	.575	.633	.719	.814	.863	1.150	
N	1	1.25 x D1	1500	1800	6000	IPT	.0009	.0017	.0022	.0026	.0035	.0043	.0052	.0060	.0069	.0078	.0087	.0108
	2	1.25 x D1	1500	1800	4500	IPT	.0008	.0016	.0019	.0023	.0031	.0039	.0047	.0054	.0062	.0070	.0078	.0097
	3	1.25 x D1	1500	1800	4500	IPT	.0006	.0012	.0015	.0018	.0024	.0030	.0036	.0042	.0048	.0054	.0061	.0076
	4	1.25 x D1	1200	1350	2250	IPT	.0006	.0012	.0015	.0018	.0024	.0030	.0036	.0042	.0048	.0054	.0061	.0076
	5	1.25 x D1	750	1200	3000	IPT	.0008	.0016	.0020	.0023	.0031	.0039	.0047	.0054	.0062	.0070	.0078	.0097

Material Group	Max Depth	Helical Interpolation / Ramping			 													
		15° - 30°			UNCOATED													
		Cutting Speed – Vc m/min			Recommended feed per tooth (fz = IPT) for helical interpolation and ramping – fz x 1													
					Diameter – D1 [Ømin-Ømax]													
		min	Start	max	Fraction	1/8	5/32	3/16	1/4	5/16	3/8	1/2	9/16	5/8	23/32	3/4	1	
					Decimals	.180	.180	.216	.288	.359	.431	.575	.633	.719	.814	.863	1.150	
N	1	1.25 x D1	1500	1800	4800	IPT	.0006	.0013	.0016	.0019	.0026	.0032	.0039	.0045	.0052	.0058	.0065	.0081
	2	1.25 x D1	1500	1800	3600	IPT	.0006	.0012	.0014	.0018	.0023	.0029	.0035	.0041	.0047	.0053	.0058	.0073
	3	1.25 x D1	1500	1800	3600	IPT	.0005	.0009	.0011	.0014	.0018	.0023	.0027	.0032	.0036	.0041	.0045	.0057
	4	1.25 x D1	1200	1350	1800	IPT	.0005	.0009	.0011	.0014	.0018	.0023	.0027	.0032	.0036	.0041	.0045	.0057
	5	1.25 x D1	750	1200	2400	IPT	.0006	.0012	.0015	.0018	.0023	.0029	.0035	.0041	.0047	.0053	.0058	.0073

Material Group	Max Depth	Helical Interpolation / Ramping			 													
		30° - 45°			UNCOATED													
		Cutting Speed – Vc m/min			Recommended feed per tooth (fz = IPT) for helical interpolation and ramping – fz x 1													
					Diameter – D1 [Ømin-Ømax]													
		min	Start	max	Fraction	1/8	5/32	3/16	1/4	5/16	3/8	1/2	9/16	5/8	23/32	3/4	1	
					Decimals	.180	.180	.216	.288	.359	.431	.575	.633	.719	.814	.863	1.150	
N	1	1.25 x D1	1260	1500	2400	IPT	.0005	.0010	.0013	.0016	.0021	.0026	.0031	.0036	.0042	.0047	.0052	.0065
	2	1.25 x D1	1260	1500	2400	IPT	.0005	.0009	.0011	.0014	.0019	.0023	.0028	.0033	.0037	.0042	.0047	.0058
	3	1.25 x D1	1260	1500	2400	IPT	.0004	.0007	.0009	.0011	.0015	.0018	.0022	.0025	.0029	.0033	.0036	.0045
	4	1.25 x D1	1020	1140	1350	IPT	.0004	.0007	.0009	.0011	.0015	.0018	.0022	.0025	.0029	.0033	.0036	.0045
	5	1.25 x D1	630	1020	1800	IPT	.0005	.0009	.0012	.0014	.0019	.0023	.0028	.0033	.0037	.0042	.0047	.0058







ALUFLASH • Plunging • Application Data • Inch

																				
Plunging/Drilling				UNCOATED				Recommended feed per revolution (fn =IPR) for plunging 2-flute end mills												
				Cutting Speed – Vc SFM				D1 – Diameter												
Material Group	Max Depth	Applicable	Coolant	min	Start	max	Fraction	1/8	5/32	3/16	1/4	5/16	3/8	1/2	9/16	5/8	23/32	3/4	1	
N	1	1.5 x D	●	Required	360	780	1200	IPR	.0031	.0047	.0053	.0059	.0063	.0079	.0087	.0093	.0098	.0104	.0110	.0118
	2	1.5 x D	●	Required	360	750	840	IPR	.0031	.0047	.0053	.0059	.0063	.0079	.0087	.0093	.0098	.0104	.0110	.0118
	3	1.5 x D	●	Required	300	600	780	IPR	.0031	.0047	.0053	.0059	.0063	.0079	.0087	.0093	.0098	.0104	.0110	.0118
	4	1 x D	●	Required	180	450	780	IPR	.0024	.0031	.0039	.0047	.0055	.0063	.0079	.0083	.0087	.0093	.0098	.0110
	5	1.5 x D	●	Required	180	600	1200	IPR	.0031	.0047	.0053	.0059	.0063	.0079	.0087	.0093	.0098	.0104	.0110	.0118

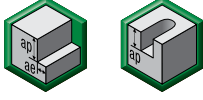
																				
Plunging/Drilling				UNCOATED				Recommended feed per revolution (fn =IPR) for plunging 3-flute end mills												
				Cutting Speed – Vc SFM				D1 – Diameter												
Material Group	Max Depth	Applicable	Coolant	min	Start	max	Fraction	1/8	5/32	3/16	1/4	5/16	3/8	1/2	9/16	5/8	23/32	3/4	1	
N	1	1.5 x D	●	Required	360	780	1200	IPR	.0022	.0033	.0037	.0041	.0044	.0055	.0061	.0065	.0069	.0073	.0077	.0083
	2	1.5 x D	●	Required	360	750	840	IPR	.0022	.0033	.0037	.0041	.0044	.0055	.0061	.0065	.0069	.0073	.0077	.0083
	3	1.5 x D	●	Required	300	600	780	IPR	.0022	.0033	.0037	.0041	.0044	.0055	.0061	.0065	.0069	.0073	.0077	.0083
	4	1 x D	●	Required	180	450	780	IPR	.0017	.0022	.0028	.0033	.0039	.0044	.0055	.0058	.0061	.0065	.0069	.0077
	5	1.5 x D	●	Required	180	600	1200	IPR	.0022	.0033	.0037	.0041	.0044	.0055	.0061	.0065	.0069	.0073	.0077	.0083

ALUFLASH • Side Milling and Slotting • Application Data • Metric

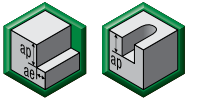
																					
		Side Milling (A) and Slotting (B)			UNCOATED			Recommended feed per tooth (fz = mm/z) for side milling (A). For slotting (B), reduce fz by 20%.													
		A		B	Cutting Speed – Vc m/min			D1 – Diameter													
Material Group		ap	ae	ap	min	Start	max	mm	2,0	4,0	5,0	6,0	8,0	10,0	12,0	14,0	16,0	18,0	20,0	25,0	
	N	1	Ap1 max	0,5 x D1	1 x D	500	600	2000	fz	0,022	0,044	0,055	0,066	0,088	0,110	0,132	0,153	0,176	0,198	0,220	0,275
	2	Ap1 max	0,5 x D1	1 x D	500	600	1500	fz	0,020	0,040	0,048	0,059	0,079	0,099	0,119	0,138	0,158	0,178	0,198	0,198	0,247
	3	Ap1 max	0,5 x D1	1 x D	500	600	1500	fz	0,015	0,031	0,038	0,046	0,062	0,077	0,092	0,107	0,123	0,138	0,154	0,192	0,192
	4	Ap1 max	0,5 x D1	1 x D	400	450	750	fz	0,015	0,031	0,038	0,046	0,062	0,077	0,092	0,107	0,123	0,138	0,154	0,192	0,192
	5	Ap1 max	0,5 x D1	1 x D	250	400	1000	fz	0,020	0,040	0,050	0,059	0,079	0,099	0,119	0,138	0,158	0,178	0,198	0,198	0,247

																					
		Side Milling (A) and Slotting (B)			UNCOATED			Recommended feed per tooth (fz = mm/z) for side milling (A). For slotting (B), reduce fz by 20%.													
		A		B	Cutting Speed – Vc m/min			D1 – Diameter													
Material Group		ap	ae	ap	min	Start	max	mm	2,0	4,0	5,0	6,0	8,0	10,0	12,0	14,0	16,0	18,0	20,0	25,0	
	N	1	Ap1 max	0,5 x D1	1 x D	500	600	2000	fz	0,022	0,044	0,055	0,066	0,088	0,110	0,132	0,153	0,176	0,198	0,220	0,275
	2	Ap1 max	0,5 x D1	1 x D	500	600	1500	fz	0,020	0,040	0,048	0,059	0,079	0,099	0,119	0,138	0,158	0,178	0,198	0,198	0,247
	3	Ap1 max	0,5 x D1	1 x D	500	600	1500	fz	0,015	0,031	0,038	0,046	0,062	0,077	0,092	0,107	0,123	0,138	0,154	0,192	0,192
	4	Ap1 max	0,5 x D1	1 x D	400	450	750	fz	0,015	0,031	0,038	0,046	0,062	0,077	0,092	0,107	0,123	0,138	0,154	0,192	0,192
	5	Ap1 max	0,5 x D1	1 x D	250	400	1000	fz	0,020	0,040	0,050	0,059	0,079	0,099	0,119	0,138	0,158	0,178	0,198	0,198	0,247

INDEXABLE MILLING

SOLID END MILLING

HOLEMAKING

TAPPING

TURNING

ALUFLASH • Ramping 2 Flute • Application Data • Metric

INDEXABLE MILLING

SOLID END MILLING

HOLEMAKING

TAPPING



TURNING

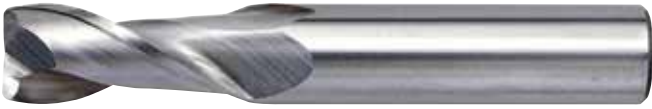

Material Group	Max Depth	Helical Interpolation / Ramping 0° - 15°																
		UNCOATED			Recommended feed per tooth (fz = mm/z) for helical interpolation and ramping													
		Cutting Speed – Vc m/min			Diameter – D1 [Ømin–Ømax]													
		min	Start	max	mm	3,0	4,0	5,0	6,0	8,0	10,0	12,0	14,0	16,0	18,0	20,0	25,0	
			mm	2,5-4,8	4,6-7,6	5,8-9,5	6,9-11,4	9,2-15,2	11,5-19,0	13,8-22,8	16,1-26,6	18,4-30,4	20,7-34,2	23,0-38,0	28,8-47,5			
N	1	1,25 x D1	500	600	2000	fz	0,022	0,044	0,055	0,066	0,088	0,110	0,132	0,153	0,176	0,198	0,220	0,275
	2	1,25 x D1	500	600	1500	fz	0,020	0,040	0,048	0,059	0,079	0,099	0,119	0,138	0,158	0,178	0,198	0,247
	3	1,25 x D1	500	600	1500	fz	0,015	0,031	0,038	0,046	0,062	0,077	0,092	0,107	0,123	0,138	0,154	0,192
	4	1,25 x D1	400	450	750	fz	0,015	0,031	0,038	0,046	0,062	0,077	0,092	0,107	0,123	0,138	0,154	0,192
	5	1,25 x D1	250	400	1000	fz	0,020	0,040	0,050	0,059	0,079	0,099	0,119	0,138	0,158	0,178	0,198	0,247



Material Group	Max Depth	Helical Interpolation / Ramping 15° - 30°																
		UNCOATED			Recommended feed per tooth (fz = mm/z) for helical interpolation and ramping													
		Cutting Speed – Vc m/min			Diameter – D1 [Ømin–Ømax]													
		min	Start	max	mm	3,0	4,0	5,0	6,0	8,0	10,0	12,0	14,0	16,0	18,0	20,0	25,0	
			mm	2,5-4,8	4,6-7,6	5,8-9,5	6,9-11,4	9,2-15,2	11,5-19,0	13,8-22,8	16,1-26,6	18,4-30,4	20,7-34,2	23,0-38,0	28,8-47,5			
N	1	1,25 x D1	500	600	1600	fz	0,017	0,033	0,041	0,050	0,066	0,082	0,099	0,115	0,132	0,148	0,165	0,206
	2	1,25 x D1	500	600	1200	fz	0,015	0,030	0,036	0,045	0,059	0,074	0,089	0,104	0,119	0,134	0,148	0,185
	3	1,25 x D1	500	600	1200	fz	0,012	0,023	0,029	0,035	0,046	0,058	0,069	0,080	0,092	0,104	0,115	0,144
	4	1,25 x D1	400	450	600	fz	0,012	0,023	0,029	0,035	0,046	0,058	0,069	0,080	0,092	0,104	0,115	0,144
	5	1,25 x D1	250	400	800	fz	0,015	0,030	0,038	0,045	0,059	0,074	0,089	0,104	0,119	0,134	0,148	0,185

Material Group	Max Depth	Helical Interpolation / Ramping 30° - 45°																
		UNCOATED			Recommended feed per tooth (fz = mm/z) for helical interpolation and ramping													
		Cutting Speed – Vc m/min			Diameter – D1 [Ømin–Ømax]													
		min	Start	max	mm	3,0	4,0	5,0	6,0	8,0	10,0	12,0	14,0	16,0	18,0	20,0	25,0	
			mm	2,5-4,8	4,6-7,6	5,8-9,5	6,9-11,4	9,2-15,2	11,5-19,0	13,8-22,8	16,1-26,6	18,4-30,4	20,7-34,2	23,0-38,0	28,8-47,5			
N	1	1,25 x D1	420	500	800	fz	0,013	0,026	0,033	0,040	0,053	0,066	0,079	0,092	0,106	0,119	0,132	0,165
	2	1,25 x D1	420	500	800	fz	0,012	0,024	0,029	0,036	0,048	0,059	0,071	0,083	0,095	0,107	0,119	0,148
	3	1,25 x D1	420	500	800	fz	0,009	0,018	0,023	0,028	0,037	0,046	0,055	0,064	0,074	0,083	0,092	0,115
	4	1,25 x D1	340	380	450	fz	0,009	0,018	0,023	0,028	0,037	0,046	0,055	0,064	0,074	0,083	0,092	0,115
	5	1,25 x D1	210	340	600	fz	0,012	0,024	0,030	0,036	0,048	0,059	0,071	0,083	0,095	0,107	0,119	0,148



ALUFLASH • Ramping 3 Flute • Application Data • Metric



																		
		Helical Interpolation / Ramping 0° - 15°			UNCOATED													
		Recommended feed per tooth (fz = mm/z) for helical interpolation and ramping – fz x 1			Cutting Speed – Vc m/min													
		Diameter – D1 [Ømin-Ømax]			Recommended feed per tooth (fz = mm/z) for helical interpolation and ramping – fz x 1													
Material Group	Max Depth	min	Start	max	mm	3,0	4,0	5,0	6,0	8,0	10,0	12,0	14,0	16,0	18,0	20,0	25,0	
					mm	2,5-4,8	4,6-7,6	5,8-9,5	6,9-11,4	9,2-15,2	11,5-19,0	13,8-22,8	16,1-26,6	18,4-30,4	20,7-34,2	23,0-38,0	28,8-47,5	
N	1	1,25 x D1	500	600	2000	fz	0,022	0,044	0,055	0,066	0,088	0,110	0,132	0,153	0,176	0,198	0,220	0,275
	2	1,25 x D1	500	600	1500	fz	0,020	0,040	0,048	0,059	0,079	0,099	0,119	0,138	0,158	0,178	0,198	0,247
	3	1,25 x D1	500	600	1500	fz	0,015	0,031	0,038	0,046	0,062	0,077	0,092	0,107	0,123	0,138	0,154	0,192
	4	1,25 x D1	400	450	750	fz	0,015	0,031	0,038	0,046	0,062	0,077	0,092	0,107	0,123	0,138	0,154	0,192
	5	1,25 x D1	250	400	1000	fz	0,020	0,040	0,050	0,059	0,079	0,099	0,119	0,138	0,158	0,178	0,198	0,247

																		
		Helical Interpolation / Ramping 15° - 30°			UNCOATED													
		Recommended feed per tooth (fz = mm/z) for helical interpolation and ramping – fz x 1			Cutting Speed – Vc m/min													
		Diameter – D1 [Ømin-Ømax]			Recommended feed per tooth (fz = mm/z) for helical interpolation and ramping – fz x 1													
Material Group	Max Depth	min	Start	max	mm	3,0	4,0	5,0	6,0	8,0	10,0	12,0	14,0	16,0	18,0	20,0	25,0	
					mm	2,5-4,8	4,6-7,6	5,8-9,5	6,9-11,4	9,2-15,2	11,5-19,0	13,8-22,8	16,1-26,6	18,4-30,4	20,7-34,2	23,0-38,0	28,8-47,5	
N	1	1,25 x D1	500	600	1600	fz	0,017	0,033	0,041	0,050	0,066	0,082	0,099	0,115	0,132	0,148	0,165	0,206
	2	1,25 x D1	500	600	1200	fz	0,015	0,030	0,036	0,045	0,059	0,074	0,089	0,104	0,119	0,134	0,148	0,185
	3	1,25 x D1	500	600	1200	fz	0,012	0,023	0,029	0,035	0,046	0,058	0,069	0,080	0,092	0,104	0,115	0,144
	4	1,25 x D1	400	450	600	fz	0,012	0,023	0,029	0,035	0,046	0,058	0,069	0,080	0,092	0,104	0,115	0,144
	5	1,25 x D1	250	400	800	fz	0,015	0,030	0,038	0,045	0,059	0,074	0,089	0,104	0,119	0,134	0,148	0,185

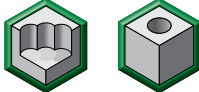
																		
		Helical Interpolation / Ramping 30° - 45°			UNCOATED													
		Recommended feed per tooth (fz = mm/z) for helical interpolation and ramping – fz x 1			Cutting Speed – Vc m/min													
		Diameter – D1 [Ømin-Ømax]			Recommended feed per tooth (fz = mm/z) for helical interpolation and ramping – fz x 1													
Material Group	Max Depth	min	Start	max	mm	3,0	4,0	5,0	6,0	8,0	10,0	12,0	14,0	16,0	18,0	20,0	25,0	
					mm	2,5-4,8	4,6-7,6	5,8-9,5	6,9-11,4	9,2-15,2	11,5-19,0	13,8-22,8	16,1-26,6	18,4-30,4	20,7-34,2	23,0-38,0	28,8-47,5	
N	1	1,25 x D1	420	500	800	fz	0,013	0,026	0,033	0,040	0,053	0,066	0,079	0,092	0,106	0,119	0,132	0,165
	2	1,25 x D1	420	500	800	fz	0,012	0,024	0,029	0,036	0,048	0,059	0,071	0,083	0,095	0,107	0,119	0,148
	3	1,25 x D1	420	500	800	fz	0,009	0,018	0,023	0,028	0,037	0,046	0,055	0,064	0,074	0,083	0,092	0,115
	4	1,25 x D1	340	380	450	fz	0,009	0,018	0,023	0,028	0,037	0,046	0,055	0,064	0,074	0,083	0,092	0,115
	5	1,25 x D1	210	340	600	fz	0,012	0,024	0,030	0,036	0,048	0,059	0,071	0,083	0,095	0,107	0,119	0,148

ALUFLASH • Plunging • Application Data • Metric

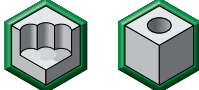
																				
Plunging/Drilling				UNCOATED				Recommended feed per revolution (fn =mm/rev) for plunging 2-flute end mills												
				Cutting Speed – Vc m/min				D1 – Diameter												
Material Group	Max Depth	Applicable	Coolant	min	Start	max	mm	2,0	4,0	5,0	6,0	8,0	10,0	12,0	14,0	16,0	18,0	20,0	25,0	
N	1	1,5 x D	●	Required	120	260	400	fn	0,080	0,120	0,135	0,150	0,160	0,200	0,220	0,235	0,250	0,265	0,280	0,300
	2	1,5 x D	●	Required	120	250	280	fn	0,080	0,120	0,135	0,150	0,160	0,200	0,220	0,235	0,250	0,265	0,280	0,300
	3	1,5 x D	●	Required	100	200	260	fn	0,080	0,120	0,135	0,150	0,160	0,200	0,220	0,235	0,250	0,265	0,280	0,300
	4	1 x D	●	Required	60	150	260	fn	0,060	0,080	0,100	0,120	0,140	0,160	0,200	0,210	0,220	0,235	0,250	0,280
	5	1,5 x D	●	Required	60	200	400	fn	0,080	0,120	0,135	0,150	0,160	0,200	0,220	0,235	0,250	0,265	0,280	0,300

																				
Plunging/Drilling				UNCOATED				Recommended feed per revolution (fn =mm/rev) for plunging 3-flute end mills												
				Cutting Speed – Vc m/min				D1 – Diameter												
Material Group	Max Depth	Applicable	Coolant	min	Start	max	mm	2,0	4,0	5,0	6,0	8,0	10,0	12,0	14,0	16,0	18,0	20,0	25,0	
N	1	1,5 x D	●	Required	120	260	400	fn	0,056	0,084	0,095	0,105	0,112	0,140	0,154	0,165	0,175	0,186	0,196	0,210
	2	1,5 x D	●	Required	120	250	280	fn	0,056	0,084	0,095	0,105	0,112	0,140	0,154	0,165	0,175	0,186	0,196	0,210
	3	1,5 x D	●	Required	100	200	260	fn	0,056	0,084	0,095	0,105	0,112	0,140	0,154	0,165	0,175	0,186	0,196	0,210
	4	1 x D	●	Required	60	150	260	fn	0,042	0,056	0,070	0,084	0,098	0,112	0,140	0,147	0,154	0,165	0,175	0,196
	5	1,5 x D	●	Required	60	200	400	fn	0,056	0,084	0,095	0,105	0,112	0,140	0,154	0,165	0,175	0,186	0,196	0,210



The X-Feed solid end mill is for machining companies looking for a reliable high feed solution that can operate on all kind of steels with a hardness above 60 HRC or on heat-resistant alloys like titanium, INCONEL®, and stainless steels.

### Features and Benefits

**Low lead angle** for high-speed applications.

**6 flutes** across the entire diameter range.

**Long neck** to reach the bottom of the deepest cavities.

**Different edge preparations** to machine ISO P and H material or ISO S and M categories.



The X-Feed milling line will deliver high feed-rates in multiple applications, from hardened steels up to 60 HRC, to the most demanding superalloys such as titanium or PH steels.

## **FAST**

Constant 6-flute design to provide the high feed-rate on the entire diameter range.

## **LONG**

With its 3 x D long neck, the X-Feed makes it possible to machine deep cavities with ease.

## **VERSATILE**

The X-Feed range includes different geometries to machine steels, hardened steels, plus stainless steels and superalloys.



# HIGH SPEED

## PRODUCT

SOLID CARBIDE END MILL

GRADE

AITIN

FLUTE

6

DIAMETER RANGE

INCH

1/4-1"

METRIC

6-25mm

## INDUSTRY



GENERAL ENGINEERING



AEROSPACE



ENERGY



TRANSPORTATION

## APPLICATIONS

MATERIALS



FACING



RAMPING



HELICAL INTERPOLATION



SLOTING



3D PROFILING



PLUNGING



## X-Feed • Series 7FN6 • 37–52 HRC • High Feed • 6 Flute • Cylindrical Shank • Inch

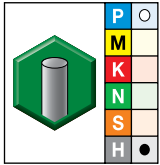
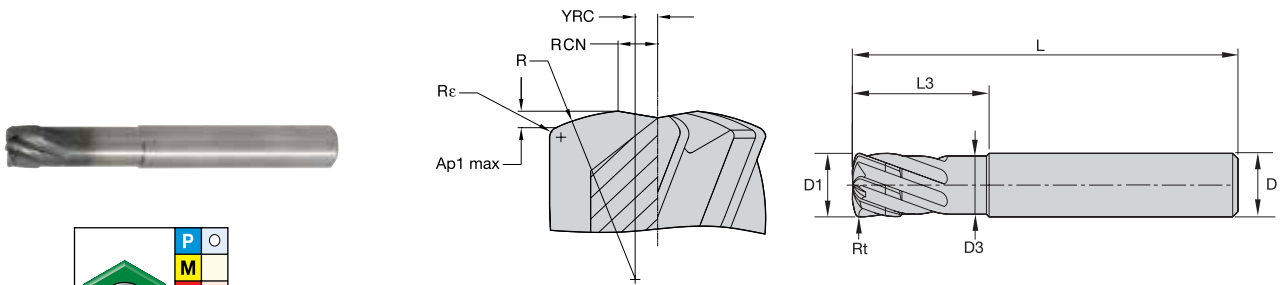

AlTiN-MT1

- first choice
- alternate choice

order #	catalog #	D1	D	D3	length of cut	length		Rt	Z U
					Ap1 max	L3	L		
3484760	TM7FN607002	1/4	1/4	.21	.013	3/4	2 1/2	.027	6
3484762	TM7FN610004	3/8	3/8	.34	.313	1 1/4	3 1/2	.040	6
3484763	TM7FN613005	1/2	1/2	.46	.375	1 1/2	4	.054	6
3484764	TM7FN616006	5/8	5/8	.59	.375	2	4 1/2	.067	6
3484765	TM7FN619007	3/4	3/4	.71	.438	2 1/2	5	.080	6

NOTE: YRC = distance from center line to the crown of the R radius.  
 RCN = distance from center line to the start of the cutting edge. This dimension can also help determine the minimum circle size when helical ramping.  
 R = the head radius size.  
 Rε = the shoulder radius or radius at the corner of the cutter.

INDEXABLE MILLING

SOLID END MILLING

HOLEMAKING

TAPPING

TURNING

**X-Feed • Series 7FNS • Stainless Steel/Hi Temp • High Feed • 6 Flute • Cylindrical Shank • Inch**

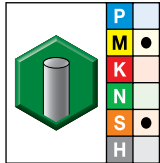

AITIN-MT

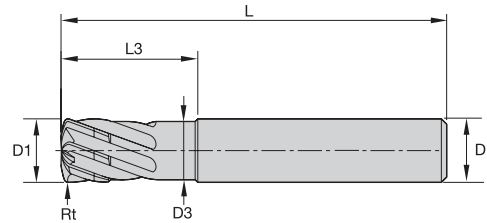
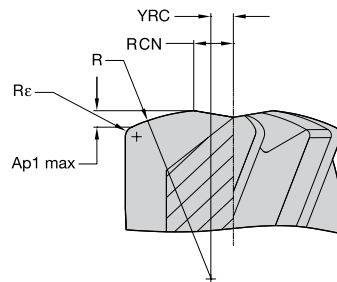

- first choice
- alternate choice

order #	catalog #	D1	D	D3	L3	length		R $\epsilon$	Rt	Z U
						L				
6441876	7FNS07002	1/4	1/4	.21	.73	2 1/2		.016	.027	6
6441877	7FNS10004	3/8	3/8	.34	1.23	3 1/2		.023	.040	6
6441878	7FNS13005	1/2	1/2	.46	1.48	4		.031	.054	6
6441879	7FNS16006	5/8	5/8	.59	1.98	4 1/2		.039	.067	6
6441880	7FNS19007	3/4	3/4	.71	2.48	5		.047	.080	6
6441881	7FNS25008	1	1	.96	2.98	5 1/2		.063	.106	6

NOTE: YRC = distance from center line to the crown of the R radius.  
 RCN = distance from center line to the start of the cutting edge. This dimension can also help determine the minimum circle size when helical ramping.  
 R = the head radius size.  
 R $\epsilon$  = the shoulder radius or radius at the corner of the cutter.

INDEXABLE MILLING

SOLID END MILLING

HOLEMAKING

TAPPING

TURNING

## X-Feed • Series 7FN7 • >52 HRC • High Feed • 6 Flute • Cylindrical Shank • Inch

INDEXABLE MILLING

SOLID END MILLING

HOLEMAKING

TAPPING

TURNING

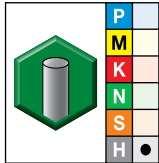

AITiN-MT1

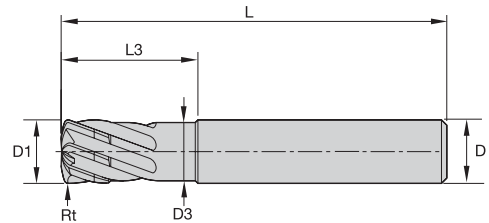
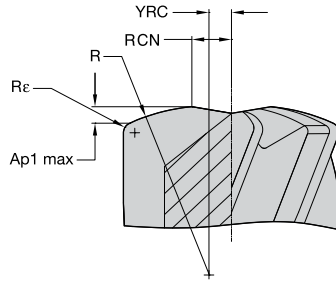

- first choice
- alternate choice

order #	catalog #	D1	D	D3	length of cut Ap1 max	L3	length L	Rt	Z U
3484769	TM7FN710004	3/8	3/8	.34	.012	1 1/4	3 1/2	.036	6
3484770	TM7FN713005	1/2	1/2	.46	.016	1 1/2	4	.048	6
3484772	TM7FN719007	3/4	3/4	.71	.025	2 1/2	5	.072	6

NOTE: YRC = distance from center line to the crown of the R radius.  
 RCN = distance from center line to the start of the cutting edge. This dimension can also help determine the minimum circle size when helical ramping.  
 R = the head radius size.  
 Rε = the shoulder radius or radius at the corner of the cutter.

## X-Feed • Series 70N6 71N6 • 37–52 HRC • High Feed • 6 Flute • Cylindrical Shank • Metric

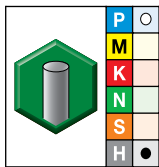

AITiN-MT1

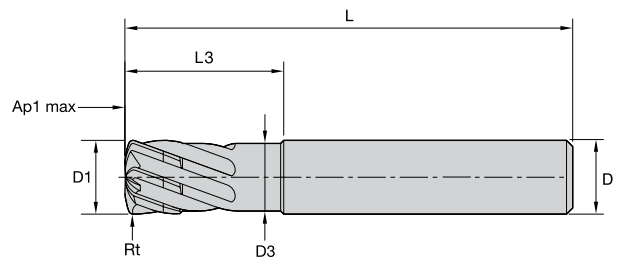
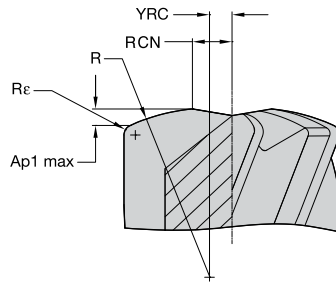

- first choice
- alternate choice

order #	catalog #	D1	D	D3	length of cut Ap1 max	L3	length L	Rε	Rt	Z U
3745400	71N606002MT	6,0	6	5,50	0,32	9,00	57	0,38	0,62	6
3341346	70N606002MT	6,0	6	5,50	0,32	18,00	63	0,38	0,62	6
3745401	71N608003MT	8,0	8	7,50	0,42	12,00	63	0,50	0,83	6
3341348	70N608003MT	8,0	8	7,50	0,42	24,00	76	0,50	0,83	6
3745402	71N610004MT	10,0	10	9,00	0,53	15,00	72	0,63	1,04	6
3101466	70N610004MT	10,0	10	9,00	0,53	30,00	89	0,63	1,04	6
3745413	71N612005MT	12,0	12	11,00	0,63	18,00	83	0,75	1,24	6
3101467	70N612005MT	12,0	12	11,00	0,63	36,00	100	0,75	1,24	6
3484748	70N616006MT	16,0	16	15,00	0,84	48,00	110	1,00	1,66	6
3484749	70N620007MT	20,0	20	19,00	1,05	60,00	125	1,25	2,07	6

NOTE: YRC = distance from center line to the crown of the R radius.  
 RCN = distance from center line to the start of the cutting edge. This dimension can also help determine the minimum circle size when helical ramping.  
 R = the head radius size.  
 Rε = the shoulder radius or radius at the corner of the cutter.

**X-Feed • Series 70NS • Stainless Steel/High-Temp • High Feed • 6 Flute • Cylindrical Shank • Metric**

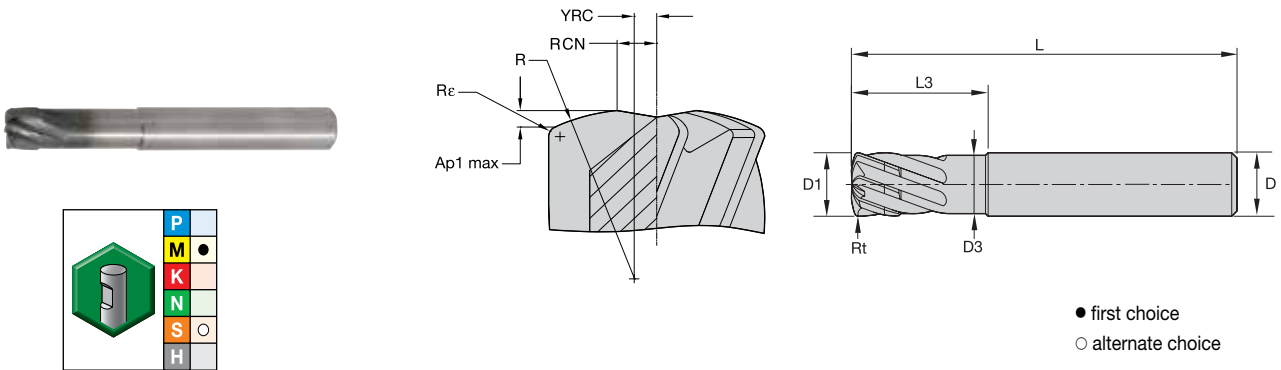

- first choice
- alternate choice

order #	catalog #	D1	D	D3	length of cut Ap1 max	L3	length L	Rε	Z U
6441882	70NS06002	6,0	6	5,50	0,32	17,75	63	0,38	6
6441883	70NS08003	8,0	8	7,50	0,42	23,75	76	0,50	6
6441884	70NS10004	10,0	10	9,00	0,53	29,50	89	0,63	6
6441885	70NS12005	12,0	12	11,00	0,63	35,50	100	0,75	6
6441886	70NS16006	16,0	16	15,00	0,84	47,50	110	1,00	6
6441887	70NS20007	20,0	20	19,00	1,05	59,50	125	1,25	6
6441888	70NS25008	25,0	25	23,50	1,31	74,25	150	1,56	6

NOTE: YRC = distance from center line to the crown of the R radius.  
 RCN = distance from center line to the start of the cutting edge. This dimension can also help determine the minimum circle size when helical ramping.  
 R = the head radius size.  
 Rε = the shoulder radius or radius at the corner of the cutter.

**X-Feed • Series 70N7 • >52 HRC • High Feed • 6 Flute • Cylindrical Shank • Metric**

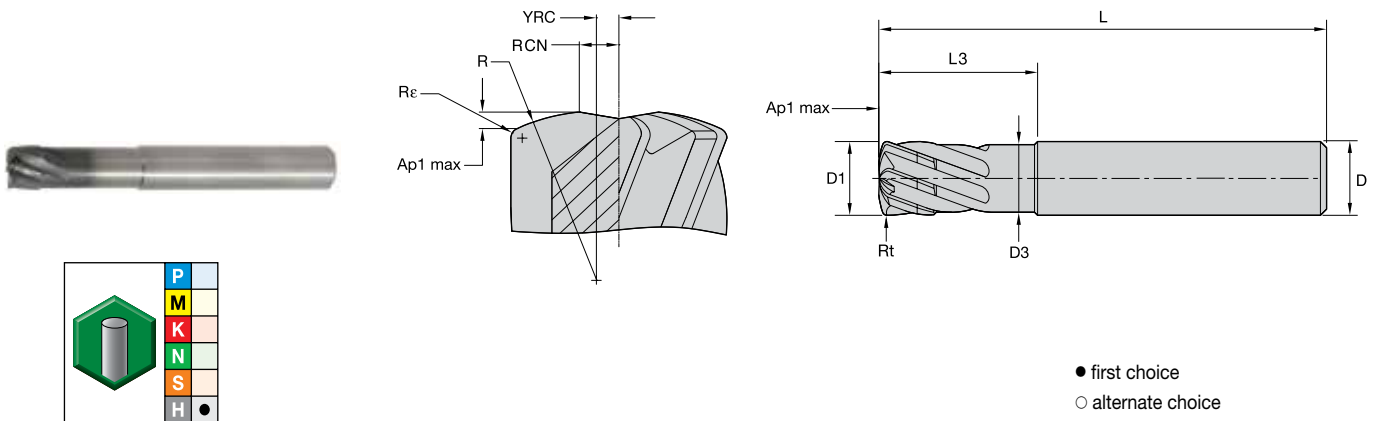

- first choice
- alternate choice



order #	catalog #	D1	D	D3	length of cut Ap1 max	L3	length L	Rε	Rt	Z U
3484756	70N706002MT	6,0	6	5,50	0,20	18,00	63	0,38	0,58	6
3484757	70N708003MT	8,0	8	7,50	0,27	24,00	76	0,50	0,77	6
3484758	70N710004MT	10,0	10	9,00	0,33	30,00	89	0,63	0,96	6
3403492	70N712005MT	12,0	12	11,00	0,40	36,00	100	0,75	1,15	6
3477329	70N716006MT	16,0	16	15,00	0,54	48,00	110	1,00	1,54	6
3484759	70N720007MT	20,0	20	19,00	0,67	60,00	125	1,25	1,92	6

NOTE: YRC = distance from center line to the crown of the R radius.  
 RCN = distance from center line to the start of the cutting edge. This dimension can also help determine the minimum circle size when helical ramping.  
 R = the head radius size.  
 Rε = the shoulder radius or radius at the corner of the cutter.

X-Feed • Series 7FN6 • Application Data • AlTiN-MT1 • Inch

INDEXABLE MILLING

SOLID END MILLING



													
		Profile Milling		AlTiN			Recommended feed per tooth (IPT = inch/th) for 3D milling/profiling (A)						
Material Group	A	Cutting Speed – vc SFM			D1 – Diameter								
		ap	ae	min	max	frac. dec.	1/4	5/16	3/8	1/2	5/8	3/4	
P	4	0.05 x D	0.55 x D	528	–	594	IPT	.0130	.0160	.0190	.0250	.0260	.0280
H	1	0.05 x D	0.55 x D	462	–	528	IPT	.0130	.0160	.0190	.0250	.0260	.0280
H	2	0.05 x D	0.55 x D	330	–	396	IPT	.0080	.0090	.0110	.0150	.0190	.0230

NOTE: Lower value of cutting speed is used for high-stock removal applications or for higher hardness (machinability) within group.  
 Higher value of cutting speed is used for finishing applications or for lower hardness (machinability) within group.  
 For better surface finish, reduce feed per tooth.  
 Above parameters are based on ideal conditions. For smaller taper machining centers, please adjust parameters on diameters >1/2".

X-Feed • Series 7FNS • Application Data • AlTiN-MT • Inch

HOLEMAKING

TAPPING

														
		Profile Milling		AlTiN-MT			Recommended feed per tooth (IPT = inch/th) for 3D milling/profiling (A)							
Material Group	A	Cutting Speed – Vc SFM			D1 – Diameter									
		ap	ae	min	max	frac. dec.	1/4	5/16	3/8	1/2	5/8	3/4	1	
M	1	0.5 x D	0.55 x D	290	–	375	IPT	.0118	.0156	.0188	.0213	.0281	.0338	.0450
M	2	0.5 x D	0.55 x D	190	–	260	IPT	.0094	.0125	.0150	.0189	.0250	.0300	.0400
M	3	0.5 x D	0.55 x D	190	–	230	IPT	.0094	.0125	.0150	.0189	.0250	.0300	.0400
S	1	0.5 x D	0.55 x D	160	–	300	IPT	.0015	.0020	.0023	.0029	.0034	.0039	.0045
S	2	0.5 x D	0.55 x D	80	–	130	IPT	.0008	.0010	.0012	.0015	.0018	.0021	.0024
S	3	0.5 x D	0.55 x D	80	–	130	IPT	.0008	.0010	.0012	.0015	.0018	.0021	.0024
S	4	0.5 x D	0.55 x D	160	–	200	IPT	.0011	.0014	.0017	.0021	.0025	.0028	.0033

TURNING

7FNS Inch									Ramping Guide for Circular and Linear Interpolation						
Geometrical Parameters									Circular Interpolation		Linear Interpolation				
									Allowed Range of Hole Diameter		Calculated Length (mm) per Ramp Angle				
diameter	Ap1 max	Rfm	Rt	Rc	Xfm	Yfm	YD	Number	Smallest	Largest	Ramp Angle (degree)				
[inch]	[inch]	[inch]	[inch]	[inch]	[inch]	[inch]	[inch]	flutes			1	2	3	4	5
1/4	0.0133	1/4	0.0269	0.0160	0.0133	0.0313	0.0525	6	0.355	0.5	0.76	0.38	0.25	0.19	0.15
3/8	0.0200	3/8	0.0399	0.0235	0.0200	0.0469	0.0788	6	0.5325	0.75	1.14	0.57	0.38	0.29	0.23
1/2	0.0266	1/2	0.0538	0.0320	0.0266	0.0625	0.1050	6	0.71	1	1.52	0.76	0.51	0.38	0.30
5/8	0.0333	5/8	0.0672	0.0400	0.0333	0.0781	0.1313	6	0.8875	1.25	1.91	0.95	0.63	0.48	0.38
3/4	0.0399	3/4	0.0798	0.0470	0.0399	0.0938	0.1575	6	1.065	1.5	2.29	1.14	0.76	0.57	0.46
1	0.0532	1	0.1059	0.0620	0.0532	0.1250	0.2100	6	1.42	2	3.05	1.52	1.02	0.76	0.61
Recommended Feed											30%	30%	30%	30%	10%



NOTE: Lower value of cutting speed is used for high-stock removal applications or for higher hardness (machinability) within group.  
 Higher value of cutting speed is used for finishing applications or for lower hardness (machinability) within group.  
 For smaller taper machining centers, please adjust parameters accordingly on diameters greater than 1/2".

X-Feed • Series 7FN7 • Application Data • AlTiN-MT1 • Inch

Material Group													
	Profile Milling		AlTiN			Recommended feed per tooth (IPT = inch/th) for 3D milling/profiling (A)							
	A		Cutting Speed – vc SFM			D1 – Diameter							
	ap	ae	min		max	frac. dec.	1/4	5/16	3/8	1/2	5/8	3/4	
H	2	0.03 x D	0.55 x D	330	–	396	IPT	.0080	.0090	.0110	.0150	.0190	.0230
	3	0.03 x D	0.55 x D	265	–	330	IPT	.0080	.0090	.0110	.0150	.0190	.0230
	4	0.03 x D	0.55 x D	165	–	230	IPT	.0060	.0080	.0090	.0130	.0160	.0190

NOTE: Lower value of cutting speed is used for high-stock removal applications or for higher hardness (machinability) within group.  
 Higher value of cutting speed is used for finishing applications or for lower hardness (machinability) within group.  
 For better surface finish, reduce feed per tooth.  
 Above parameters are based on ideal conditions. For smaller taper machining centers, please adjust parameters on diameters >1/2".

X-Feed • Lists 70N6 71N6 • Application Data • AlTiN-MT1 • Metric

Material Group													
	Profile Milling		AlTiN			Recommended feed per tooth (fz = mm/th) for 3D milling/profiling (A)							
	A		Cutting Speed – vc m/min			D1 – Diameter							
	ap	ae	min		max	mm	6,0	8,0	10,0	12,0	16,0	20,0	
P	4	0,05 x D	0,55 x D	160	–	180	fz	0,300	0,500	0,500	0,500	0,600	0,700
H	1	0,05 x D	0,55 x D	140	–	160	fz	0,300	0,500	0,500	0,500	0,600	0,700
	2	0,05 x D	0,55 x D	100	–	120	fz	0,200	0,300	0,300	0,400	0,500	0,600



Tool List 70N6										Ramping Guide for Circular and Linear Interpolation						
Geometrical Parameters										Circular Interpolation		Linear Interpolation				
										Allowed Range of Hole Diameter		Calculated Length (mm) per Ramp Angle				
Tool	diameter	ap max	Rfm	Rt	Rc	Xfm	Yfm	YD	Number	Smallest	Largest	Ramp Angle (degree)				
	[mm]	[mm]	[mm]	[mm]	[mm]	[mm]	[mm]	[mm]	flutes			1	2	3	4	5
70N606003MT	6	0,32	6	0,62	0,375	0,32	0,75	1,32	6	8,64	12	18,12	9,06	6,03	4,52	3,61
70N608003MT	8	0,42	8	0,83	0,500	0,42	1,00	1,76	6	11,52	16	24,16	12,08	8,05	6,03	4,82
70N610004MT	10	0,53	10	1,04	0,625	0,53	1,25	2,20	6	14,4	20	30,20	15,09	10,06	7,54	6,02
70N612005MT	12	0,63	12	1,24	0,750	0,63	1,50	2,64	6	17,28	24	36,24	18,11	12,07	9,05	7,23
70N616006MT	16	0,84	16	1,66	1,000	0,84	2,00	3,52	6	23,04	32	48,31	24,15	16,09	12,06	9,64
70N620007MT	20	1,05	20	2,07	1,250	1,05	2,50	4,40	6	28,8	40	60,39	30,19	20,11	15,08	12,05
Recommended Feed											100%	70%	50%	30%	10%	

NOTE: Above parameters are based on ideal conditions. For smaller taper machining centers, please adjust parameters on diameters >12mm.

X-Feed • Series 70NS • Application Data • AlTiN-MT • Metric

INDEXABLE MILLING

SOLID END MILLING

Material Group														
	Profile Milling		AlTiN-MT			Recommended feed per tooth (fz = mm/th) for 3D milling/profiling (A)								
	A		Cutting Speed – Vc m/min			D1 – Diameter								
	ap	ae	min	max	mm	6,0	8,0	10,0	12,0	16,0	20,0	25,0		
M	1	0,05 x D	0,55 x D	90	–	115	fz	0,300	0,400	0,500	0,540	0,720	0,900	1,125
	2	0,05 x D	0,55 x D	60	–	80	fz	0,240	0,320	0,400	0,480	0,640	0,800	1,000
	3	0,05 x D	0,55 x D	60	–	70	fz	0,240	0,320	0,400	0,480	0,640	0,800	1,000
S	1	0,05 x D	0,55 x D	50	–	90	fz	0,270	0,360	0,450	0,500	0,650	0,800	1,000
	2	0,05 x D	0,55 x D	25	–	40	fz	0,240	0,320	0,400	0,480	0,600	0,700	0,900
	3	0,05 x D	0,55 x D	25	–	40	fz	0,180	0,240	0,300	0,350	0,430	0,500	0,600
	4	0,05 x D	0,55 x D	50	–	60	fz	0,210	0,280	0,350	0,420	0,560	0,700	0,875

HOLEMAKING

TAPPING

70NS Metric															
Geometrical Parameters									Ramping Guide for Circular and Linear Interpolation						
									Circular Interpolation		Linear Interpolation				
									Allowed Range of Hole Diameter		Calculated Length (mm) per Ramp Angle				
diameter	Ap1 max	Rfm	Rt	Rc	Xfm	Yfm	YD	Number	Smallest	Largest	Ramp Angle (degree)				
[mm]	[mm]	[mm]	[mm]	[mm]	[mm]	[mm]	[mm]	flutes			1	2	3	4	5
6	0,32	6	0,67	0,375	0,338	0,75	1,26	6	8,52	12	18,12	9,06	6,03	4,52	3,61
8	0,42	8	0,89	0,500	0,450	1,00	1,68	6	11,36	16	24,16	12,08	8,05	6,03	4,82
10	0,53	10	1,12	0,625	0,562	1,25	2,10	6	14,2	20	30,20	15,09	10,06	7,54	6,02
12	0,63	12	1,34	0,750	0,674	1,50	2,52	6	17,04	24	36,24	18,11	12,07	9,05	7,23
16	0,84	16	1,79	1,000	0,915	2,00	3,36	6	22,72	32	48,31	24,15	16,09	12,06	9,64
20	1,05	20	2,23	1,250	1,124	2,50	4,20	6	28,4	40	60,39	30,19	20,11	15,08	12,05
25	1,25	25	2,90	1,5625	1,405	3,1250	5,25	6	35,5	50	70,61	35,80	23,85	17,88	14,29
Recommended Feed											30%	30%	30%	30%	10%

NOTE: Lower value of cutting speed is used for high stock removal applications or for higher hardness (machinability) within group.  
 Higher value of cutting speed is used for finishing applications or for lower hardness (machinability) within group.  
 Above parameters are based on ideal conditions. For smaller taper machining centers, please adjust parameters accordingly on diameters greater than 12mm.

TURNING

X-Feed • Series 70N7 • Application Data • AlTiN-MT1 • Metric

Material Group												
	Profile Milling		AlTiN			Recommended feed per tooth (fz = mm/th) for 3D milling/ profiling (A)						
	A		Cutting Speed – vc m/min			D1 – Diameter						
	ap	ae	min		max	mm	6,0	8,0	10,0	12,0	16,0	20,0
H 2	0,03 x D	0,55 x D	100	–	120	fz	0,200	0,300	0,300	0,400	0,500	0,600
3	0,03 x D	0,55 x D	80	–	100	fz	0,200	0,300	0,300	0,400	0,500	0,600
4	0,03 x D	0,55 x D	50	–	70	fz	0,150	0,200	0,250	0,300	0,400	0,500

Tool List 70N7															
Geometrical Parameters									Ramping Guide for Circular and Linear Interpolation						
									Circular Interpolation		Linear Interpolation				
									Allowed Range of Hole Diameter		Calculated Length (mm) per Ramp Angle				
diameter	Ap1 max	Rfm	Rt	Rc	Xfm	Yfm	YD	Number			Ramp Angle (degree)				
[mm]	[mm]	[mm]	[mm]	[mm]	[mm]	[mm]	[mm]	flutes	Smallest	Largest	1	2	3	4	5
6	0,20	9	0,58	0,375	0,20	0,75	1,26	6	8,52	12	11,51	5,75	3,83	2,87	2,30
8	0,27	12	0,77	0,500	0,27	1,00	1,68	6	11,36	16	15,34	7,67	5,11	3,83	3,06
10	0,33	15	0,96	0,625	0,33	1,25	2,10	6	14,2	20	19,18	9,58	6,39	4,79	3,83
12	0,40	18	1,15	0,750	0,40	1,50	2,52	6	17,04	24	23,01	11,50	7,66	5,74	4,59
16	0,54	24	1,54	1,000	0,54	2,00	3,36	6	22,72	32	30,68	15,34	10,22	7,66	6,12
20	0,67	30	1,92	1,250	0,67	2,50	4,20	6	28,4	40	38,35	19,17	12,77	9,57	7,65
Recommended Feed											100%	70%	50%	30%	10%

NOTE: Above parameters are based on ideal conditions. For smaller taper machining centers, please adjust parameters accordingly on diameters >12mm.



Vision Plus end mills are focused on delivering productivity in primarily the die and mold industry, in roughing or finishing operations for hardened steel up to 67 HRC.

### Features and Benefits

**Negative rakes** to make the cutting edge robust.

**High helix angles** to reduce chip thickness and guarantee wall straightness in finishing operations.

**Specific substrate engineered** to perform on high hardness steels.



The Vision Plus series offers a variety of tools to machine the most complex components including various end face geometries.

## **ROBUST**

Dedicated design to attack all types of hardened steels up to 67 HRC.

## **SPECIFIC**

Specifically engineered design to compete in the die and mold industry, in all applications of hardened steels and high alloyed steels.

## **PRODUCTIVE**

Vision Plus end mills include geometries and edge preparations designed to increase feed-rates and achieve higher metal removal rates.

# HARD MACHINING MADE EASY

## PRODUCT

SOLID CARBIDE END MILL

GRADE

WU10PE  
AT1N

FLUTE

2-6

DIAMETER RANGE

METRIC

0,3-25mm

INCH

1/8-1"

## INDUSTRY



## APPLICATIONS

MATERIALS

P

H



SIDE MILLING



3D PROFILING



HELICAL  
INTERPOLATION



RAMPING

## Vision Plus • Series 7S05 • Sharp Edge • Cylindrical Shank • Inch

INDEXABLE MILLING

SOLID END MILLING

HOLEMAKING

TAPPING

TURNING

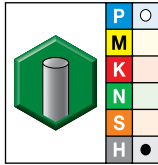
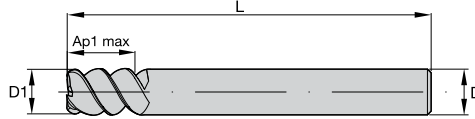

● first choice  
○ alternate choice

AITIN-MT1

order #	catalog #	D1	D	length of cut Ap1 max	length L	ZU
3083618	TM7S0507002	1/4	1/4	3/8	3	4
3321600	TM7S1507002	1/4	1/4	5/8	3	4
3043480	TM7S0508000	5/16	5/16	1/2	4	4
3054914	TM7S1508000	5/16	5/16	3/4	4	4
3082394	TM7S2508000	5/16	5/16	1 1/8	4	4
3100520	TM7S0510004	3/8	3/8	9/16	4	4
3048589	TM7S1510004	3/8	3/8	15/16	4	5
3054915	TM7S2510004	3/8	3/8	1 5/16	4	5
3047518	TM7S0513005	1/2	1/2	3/4	5	4
3084183	TM7S1513005	1/2	1/2	1 1/4	5	6
3081614	TM7S2513005	1/2	1/2	1 3/4	5	6
3063997	TM7S1516006	5/8	5/8	1 9/16	5	6
3050197	TM7S2516006	5/8	5/8	2 3/16	5	6
3091702	TM7S1519007	3/4	3/4	1 7/8	6	6
3321602	TM7S2519007	3/4	3/4	2 5/8	6	6
3104294	TM7S2525008	1	1	3 1/2	6	6

Vision Plus • Series 7S7R • Radius • Cylindrical Shank • Inch

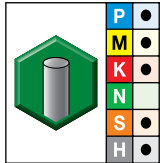
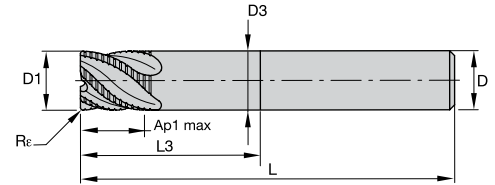
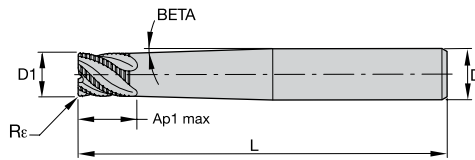

AITiN-MT1

- first choice
- alternate choice

order #	catalog #	D1	D	D3	length of cut		length		Rε	BETA	ZU
					Ap1 max	L3	L				
3096974	TM7S7R10005A	3/8	1/2	—	3/8	3/8	5		.030	2.500	4
3116105	TM7S7R13006A	1/2	5/8	.470	1/2	—	5		.040	—	4
3044789	TM7S7R19007A	3/4	3/4	.713	3/4	2 1/4	6		.050	—	6

Vision Plus • Series 7S5F • Ball Nose • Cylindrical Shank • Inch

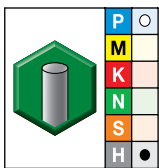
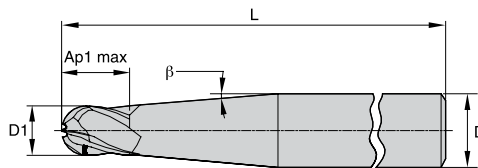

AITiN-MT1

- first choice
- alternate choice

order #	catalog #	D1	D	length of cut		length		BETA	ZU
				Ap1 max		L			
3047519	TM7S5F03002	1/8	1/4	1/8		3		2.5	4
3062915	TM7S5F05002	3/16	1/4	3/16		3		2.5	4
3058580	TM7S5F07004	1/4	3/8	1/4		4		2.5	4
3061865	TM7S5F08004	5/16	3/8	5/16		4		2.5	4
3058738	TM7S5F10005	3/8	1/2	3/8		5		2.5	4
3062363	TM7S5F13006	1/2	5/8	1/2		5		2.5	4

## Vision Plus • Series 7505 7515 7525 7545 • Sharp Edge • Cylindrical Shank • Metric

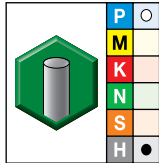
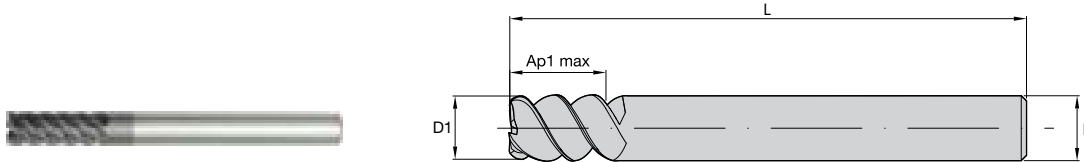

● first choice  
○ alternate choice

TiAlN-LT1

order #	catalog #	D1	D	length of cut Ap1 max	length L	ZU
2499570	754503002LT	3,0	6	4,50	50	4
2499567	750503002LT	3,0	6	4,50	57	4
2499571	754504002LT	4,0	6	6,00	50	4
2499568	750504002LT	4,0	6	6,00	57	4
2499572	754505002LT	5,0	6	7,50	50	4
2499569	750505002LT	5,0	6	7,50	76	4
1848805	754506002LT	6,0	6	9,00	50	4
1724462	750506002LT	6,0	6	9,00	76	4
1724468	751506002LT	6,0	6	15,00	76	4
1724487	752506002LT	6,0	6	21,00	76	4
1860603	754508003LT	8,0	8	12,00	63	4
1724463	750508003LT	8,0	8	12,00	100	4
1724469	751508003LT	8,0	8	20,00	100	4
1724489	752508003LT	8,0	8	28,00	100	4
1860604	754510004LT	10,0	10	15,00	76	4
1724464	750510004LT	10,0	10	15,00	100	4
1724481	751510004LT	10,0	10	25,00	100	5
1724490	752510004LT	10,0	10	35,00	100	5
1860605	754512005LT	12,0	12	18,00	76	4
1724465	750512005LT	12,0	12	18,00	125	4
1724482	751512005LT	12,0	12	30,00	125	6
1724531	752512005LT	12,0	12	42,00	125	6
1860606	754516006LT	16,0	16	24,00	89	4
1724483	751516006LT	16,0	16	40,00	125	6
1724533	752516006LT	16,0	16	56,00	125	6
1724484	751520007LT	20,0	20	50,00	150	6
1724536	752520007LT	20,0	20	70,00	150	6
1747878	751525008LT	25,0	25	63,00	150	6
1747931	752525008LT	25,0	25	88,00	150	6

Vision Plus • Series 7585 7595 • Radius • Cylindrical Shank • Metric

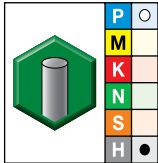
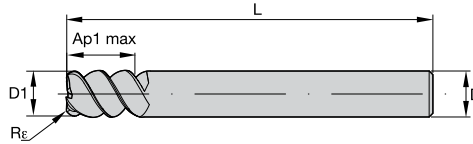

● first choice  
○ alternate choice

TiAIN-LT1

order #	catalog #	D1	D	length of cut Ap1 max	length L	Re	ZU
2540317	759503002LT	3,0	6	4,50	50	0,25	4
2540318	759503012LT	3,0	6	4,50	50	0,50	4
2540319	759504002LT	4,0	6	6,00	50	0,25	4
2540320	759504012LT	4,0	6	6,00	50	0,50	4
2540321	759505002LT	5,0	6	7,50	50	0,25	4
2540322	759505012LT	5,0	6	7,50	50	0,50	4
1862105	759506002LT	6,0	6	9,00	50	0,25	4
1862106	759506012LT	6,0	6	9,00	50	0,50	4
2541273	759506022LT	6,0	6	9,00	50	0,75	4
2541274	759506032LT	6,0	6	9,00	50	1,00	4
1860609	758506002LT	6,0	6	9,00	76	0,25	4
1860610	758506012LT	6,0	6	9,00	76	0,50	4
1862107	759508003LT	8,0	8	12,00	63	0,50	4
2541275	759508023LT	8,0	8	12,00	63	0,75	4
1862108	759508013LT	8,0	8	12,00	63	1,00	4
2541276	759508033LT	8,0	8	12,00	63	1,50	4
1860611	758508003LT	8,0	8	12,00	100	0,50	4
1860612	758508013LT	8,0	8	12,00	100	1,00	4
1862109	759510004LT	10,0	10	15,00	76	0,50	4
1862110	759510014LT	10,0	10	15,00	76	1,00	4
2541277	759510024LT	10,0	10	15,00	76	1,50	4
2541278	759510034LT	10,0	10	15,00	76	2,00	4
1860623	758510004LT	10,0	10	15,00	100	0,50	4
1860624	758510014LT	10,0	10	15,00	100	1,00	4
1862111	759512005LT	12,0	12	18,00	76	0,50	4
2541279	759512025LT	12,0	12	18,00	76	1,00	4
2541280	759512035LT	12,0	12	18,00	76	2,00	4
1860625	758512005LT	12,0	12	18,00	125	0,50	4
1862113	759516006LT	16,0	16	24,00	89	0,50	4
1860628	758516016LT	16,0	16	24,00	125	1,50	4
2541293	759520027LT	20,0	20	30,00	104	1,00	4

INDEXABLE MILLING

SOLID END MILLING

HOLEMAKING

TAPPING

TURNING

## Vision Plus • Series 75N2 • Radius • Cylindrical Shank • Metric

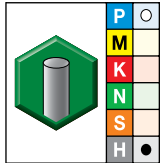
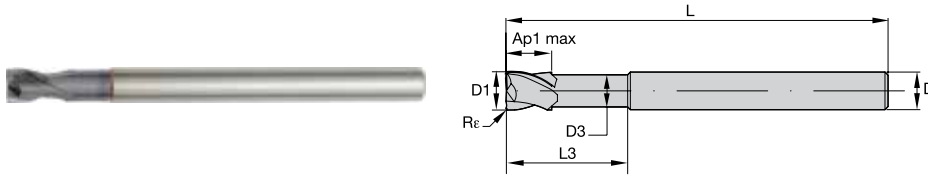

WU10PE

- first choice
- alternate choice

order #	catalog #	D1	D	D3	length of cut Ap1 max	L3	length L	Re	ZU
2544530	75N203022RT	3,0	6	2,80	3,00	9,00	75	0,30	2
2544737	75N204022RT	4,0	6	3,70	4,00	12,00	75	0,30	2
2545166	75N206062RT	6,0	6	5,50	6,00	18,00	75	1,00	2

## Vision Plus • Series 75N5 • Neck • Cylindrical Shank • Metric

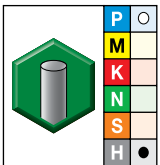
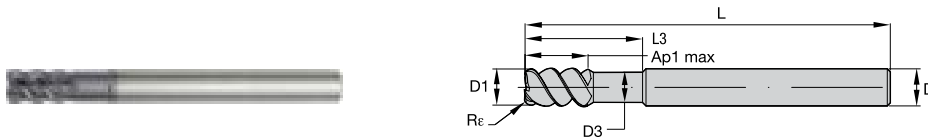

TiAlN-LT1

- first choice
- alternate choice

order #	catalog #	D1	D	D3	length of cut Ap1 max	L3	length L	Re	ZU
2544367	75N503022LT	3,0	6	2,7	4,50	9,00	57	0,25	4
2544368	75N503042LT	3,0	6	2,7	4,50	9,00	57	0,50	4
2544369	75N504022LT	4,0	6	3,7	6,00	12,00	57	0,25	4
2544370	75N504042LT	4,0	6	3,7	6,00	12,00	57	0,50	4
2544371	75N505022LT	5,0	6	4,6	7,50	15,00	76	0,25	4
2544372	75N505042LT	5,0	6	4,6	7,50	15,00	76	0,50	4
1862119	75N506002LT	6,0	6	5,4	9,00	18,00	76	—	4
2544443	75N506022LT	6,0	6	5,4	9,00	18,00	76	0,25	4
2544444	75N506042LT	6,0	6	5,4	9,00	18,00	76	0,50	4
2544446	75N506082LT	6,0	6	5,4	9,00	18,00	76	1,00	4
1862120	75N508003LT	8,0	8	7,4	12,00	24,00	100	—	4
2544447	75N508023LT	8,0	8	7,4	12,00	24,00	100	0,50	4
2544448	75N508033LT	8,0	8	7,4	12,00	24,00	100	1,00	4
2544449	75N508043LT	8,0	8	7,4	12,00	24,00	100	1,50	4
2544450	75N508053LT	8,0	8	7,4	12,00	24,00	100	2,00	4
1862121	75N510004LT	10,0	10	9,4	15,00	30,00	100	—	4
2544452	75N510024LT	10,0	10	9,2	15,00	30,00	100	0,50	4
2544483	75N510034LT	10,0	10	9,2	15,00	30,00	100	1,00	4
2544484	75N510044LT	10,0	10	9,2	15,00	30,00	100	1,50	4
2544485	75N510054LT	10,0	10	9,2	15,00	30,00	100	2,00	4
1862122	75N512005LT	12,0	12	11,4	18,00	36,00	125	—	4
2544486	75N512025LT	12,0	12	11,0	18,00	36,00	125	0,50	4
2544487	75N512035LT	12,0	12	11,0	18,00	36,00	125	1,00	4
2544489	75N512055LT	12,0	12	11,0	18,00	36,00	125	2,00	4
1862123	75N516006LT	16,0	16	15,4	24,00	48,00	125	—	4
2544490	75N516026LT	16,0	16	15,0	24,00	48,00	125	0,50	4
1862124	75N520007LT	20,0	20	19,4	30,00	60,00	150	—	4
2544523	75N520047LT	20,0	20	19,0	30,00	60,00	150	2,00	4

Vision Plus • Series 7670 • Radius • Cylindrical Shank • Metric

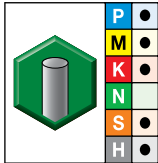
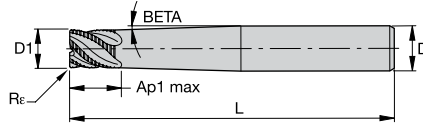

TIAIN-LT1

- first choice
- alternate choice

order #	catalog #	D1	D	D3	length of cut Ap1 max	length L	Re	ZU
1724621	767016006LT	16,0	16	15,00	16,00	125	1,00	6

Vision Plus • Series D518 • Sharp Edge • Weldon® • Metric

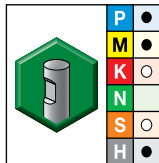
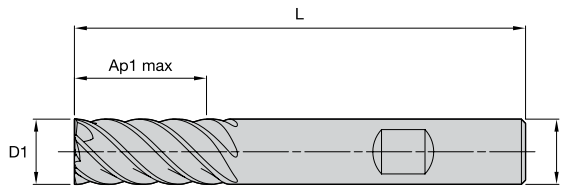

WP15PE

- first choice
- alternate choice

order #	catalog #	D1	D	length of cut Ap1 max	length L	ZU
5559116	D51804002W	4,0	6	11,00	57	4
5559117	D51805002W	5,0	6	13,00	57	4
5559118	D51806002W	6,0	6	13,00	57	6
5559120	D51808003W	8,0	8	19,00	63	6
5559122	D51810004W	10,0	10	22,00	72	6
5559123	D51812005W	12,0	12	26,00	83	6
5559124	D51814014W	14,0	14	26,00	83	6
5559125	D51816006W	16,0	16	32,00	92	8
5559127	D51820007W	20,0	20	38,00	104	8
5559128	D51825008W	25,0	25	45,00	121	8



## Vision Plus • Series D618 • Sharp Edge • Cylindrical Shank • Metric

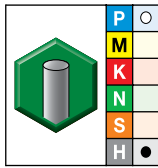
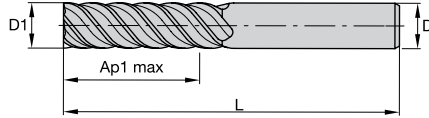

WU10PE

- first choice
- alternate choice

order #	catalog #	D1	D	length of cut Ap1 max	length L	ZU
2256338	D61803002RJ	3,0	4	8,00	50	4
2257304	D61804002RJ	4,0	6	12,00	57	4
2256340	D61805002RJ	5,0	6	13,00	57	4
2256341	D61806002RJ	6,0	6	15,00	60	6
2256353	D61808003RJ	8,0	8	20,00	75	6
2256354	D61810004RJ	10,0	10	25,00	80	6
2256355	D61812005RJ	12,0	12	30,00	100	6
2256356	D61816006RJ	16,0	16	40,00	110	6
2256357	D61820007RJ	20,0	20	45,00	120	6

## Vision Plus • Series 7050 7060 • Ball Nose • Cylindrical Shank • Metric

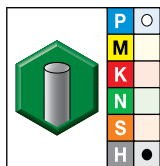
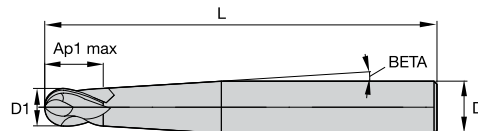

WU10PE

- first choice
- alternate choice

order #	catalog #	D1	D	length of cut Ap1 max	length L	BETA	ZU
1724321	705002001RT	2,0	4	2,00	63	2.5	4
1724323	705003002RT	3,0	6	3,00	75	2.5	4
1724324	705004002RT	4,0	6	4,00	75	2.5	4
2495916	706004002RT	4,0	6	4,00	75	1.5	4
1724325	705005002RT	5,0	6	5,00	75	2.5	4
1724326	705006004RT	6,0	10	6,00	100	2.5	4
2495918	706006004RT	6,0	10	6,00	100	1.5	4
1724327	705008004RT	8,0	10	8,00	100	2.5	4
1724328	705010005RT	10,0	12	10,00	125	2.5	4
1724330	705016006RT	16,0	16	16,00	125	—	4

Vision Plus • Series 7061 • Ball Nose • Cylindrical Shank • Metric

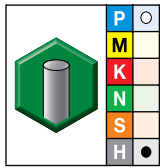
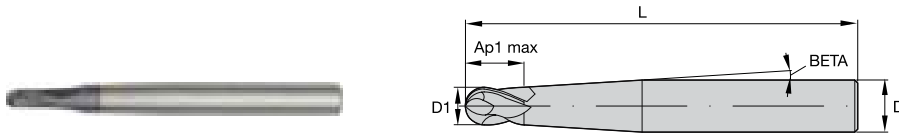

- first choice
- alternate choice

WU10PE

order #	catalog #	D1	D	length of cut Ap1 max	length L	BETA	ZU
2495994	706101001RT	1,0	4	1,00	63	3.5	2
2495995	706102001RT	2,0	4	2,00	63	3.5	2
2495997	706103002RT	3,0	6	3,00	75	1.5	2
2495998	706104002RT	4,0	6	4,00	75	1.5	2
2496000	706106004RT	6,0	10	6,00	100	1.5	2
2496001	706108004RT	8,0	10	8,00	100	1.5	2

Vision Plus • Series 7150 • Ball Nose • Cylindrical Shank • Metric

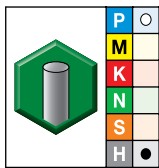
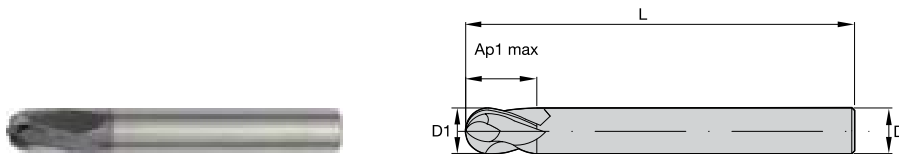

- first choice
- alternate choice

WU10PE

order #	catalog #	D1	D	length of cut Ap1 max	length L	ZU
1859882	715003000RT	3,0	3	3,00	38	4
1859904	715004001RT	4,0	4	4,00	50	4
1859906	715005001RT	5,0	5	5,00	50	4
1859907	715006002RT	6,0	6	6,00	50	4
1859908	715008003RT	8,0	8	8,00	63	4
1859909	715010004RT	10,0	10	10,00	76	4
1859910	715012005RT	12,0	12	12,00	76	4

Vision Plus • Series 7151 • Ball Nose • Cylindrical Shank • Metric

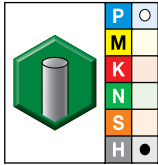
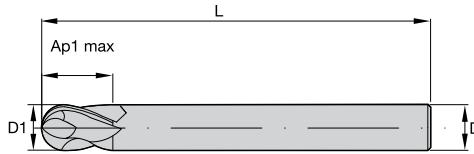

WU10PE

- first choice
- alternate choice

order #	catalog #	D1	D	length of cut Ap1 max	length L	ZU
1860036	715101000RT	1,0	3	3,00	38	2
1860090	715102000RT	2,0	3	3,00	38	2
1860106	715103000RT	3,0	3	3,00	38	2
1860109	715104001RT	4,0	4	4,00	50	2
1860111	715105001RT	5,0	5	5,00	50	2
1860112	715106002RT	6,0	6	6,00	50	2
1860133	715108003RT	8,0	8	8,00	63	2
1860134	715110004RT	10,0	10	10,00	76	2
1860135	715112005RT	12,0	12	12,00	76	2

Vision Plus • Series 70N1 • Ball Nose • Neck • Cylindrical Shank • Metric

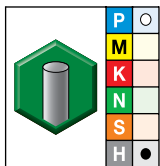
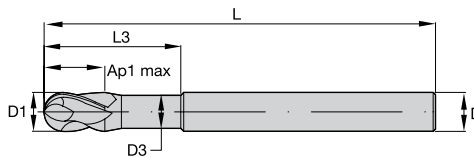

WU10PE

- first choice
- alternate choice

order #	catalog #	D1	D	D3	length of cut Ap1 max	length L	ZU
2545190	70N101001RT	1,0	4	0,80	1,00	63	2
2545191	70N101501RT	1,5	4	1,30	1,50	63	2
2545192	70N102002RT	2,0	6	1,80	2,00	76	2
2545213	70N103002RT	3,0	6	2,80	3,00	76	2
2545214	70N104002RT	4,0	6	3,70	4,00	76	2
2545215	70N105002RT	5,0	6	4,60	5,00	76	2
2545216	70N106002RT	6,0	6	5,50	6,00	76	2
2545217	70N108003RT	8,0	8	7,50	8,00	100	2
2545218	70N110004RT	10,0	10	9,50	10,00	100	2
2545219	70N112005RT	12,0	12	11,50	12,00	125	2

Vision Plus Micro • Series 7N02 7N12 7N22 • Sharp Edge • Cylindrical Shank • Metric

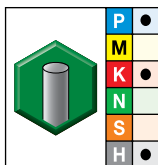
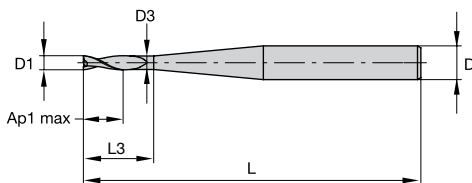

● first choice  
○ alternate choice

WU10PE

order #	catalog #	D1	D	D3	length of cut Ap1 max	L3	length L	ZU
2256390	7N0200302RJ	0,3	6	0,24	0,40	0,40	50	2
2256438	7N2200400RJ	0,4	3	0,34	0,60	2,00	38	2
2256439	7N2200410RJ	0,4	3	0,34	0,60	4,00	38	2
2256391	7N0200402RJ	0,4	6	0,34	0,60	0,60	50	2
2256440	7N2200500RJ	0,5	3	0,44	0,70	2,00	38	2
2256441	7N2200510RJ	0,5	3	0,44	0,70	4,00	38	2
2256442	7N2200520RJ	0,5	3	0,44	0,70	6,00	38	2
2256392	7N0200502RJ	0,5	6	0,44	0,70	1,50	50	2
2256443	7N2200600RJ	0,6	3	0,54	0,90	2,00	38	2
2256444	7N2200610RJ	0,6	3	0,54	0,90	4,00	38	2
2256445	7N2200620RJ	0,6	3	0,54	0,90	6,00	38	2
2256393	7N0200602RJ	0,6	6	0,54	0,90	1,80	50	2
2256447	7N2200711RJ	0,7	4	0,64	1,00	4,00	50	2
2256448	7N2200721RJ	0,7	4	0,64	1,00	6,00	50	2
2256449	7N2200801RJ	0,8	4	0,74	1,20	4,00	50	2
2256450	7N2200811RJ	0,8	4	0,74	1,20	6,00	50	2
2256451	7N2200821RJ	0,8	4	0,74	1,20	8,00	50	2
2256394	7N0200802RJ	0,8	6	0,74	1,20	2,40	50	2
2256455	7N2201001RJ	1,0	4	0,94	1,50	6,00	50	2
2256456	7N2201011RJ	1,0	4	0,94	1,50	8,00	50	2
2256457	7N2201021RJ	1,0	4	0,94	1,50	10,00	50	2
2256458	7N2201031RJ	1,0	4	0,94	1,50	12,00	50	2
2256395	7N0201002RJ	1,0	6	0,94	1,50	2,50	50	2
2256406	7N1201002RJ	1,0	6	0,94	1,50	5,00	60	2
2256459	7N2201201RJ	1,2	4	1,14	1,80	6,00	50	2
2256460	7N2201211RJ	1,2	4	1,14	1,80	8,00	50	2
2256462	7N2201231RJ	1,2	4	1,14	1,80	12,00	50	2
2256396	7N0201202RJ	1,2	6	1,14	1,80	3,00	50	2
2256407	7N1201202RJ	1,2	6	1,14	1,80	6,00	60	2
2256463	7N2201401RJ	1,4	4	1,34	2,10	6,00	50	2
2256464	7N2201411RJ	1,4	4	1,34	2,10	8,00	50	2
2256465	7N2201421RJ	1,4	4	1,35	2,10	10,00	50	2
2256467	7N2201441RJ	1,4	4	1,34	2,10	16,00	50	2
2256397	7N0201402RJ	1,4	6	1,34	2,10	3,50	50	2
2256468	7N2201501RJ	1,5	4	1,44	2,30	6,00	50	2
2256469	7N2201511RJ	1,5	4	1,44	2,30	10,00	50	2
2256470	7N2201521RJ	1,5	4	1,44	2,30	12,00	50	2
2256471	7N2201531RJ	1,5	4	1,44	2,30	16,00	50	2
2256472	7N2201541RJ	1,5	4	1,44	2,30	18,00	63	2
2256473	7N2201551RJ	1,5	4	1,44	2,30	20,00	63	2
2256398	7N0201502RJ	1,5	6	1,44	2,30	3,80	50	2
2256409	7N1201502RJ	1,5	6	1,44	2,30	7,50	60	2
3454428	7N2201571RJ	1,6	4	1,54	2,80	11,70	50	2
2256479	7N2201701RJ	1,7	4	1,64	2,60	6,00	50	2
2256481	7N2201721RJ	1,7	4	1,64	2,60	12,00	50	2
2256484	7N2201801RJ	1,8	4	1,74	2,70	6,00	50	2
2256485	7N2201811RJ	1,8	4	1,74	2,70	10,00	50	2
2256486	7N2201821RJ	1,8	4	1,74	2,70	12,00	50	2
2256487	7N2201831RJ	1,8	4	1,74	2,70	16,00	50	2
2256400	7N0201802RJ	1,8	6	1,74	2,70	4,50	50	2
2256489	7N2201901RJ	1,9	4	1,84	2,80	6,00	50	2
2256494	7N2202001RJ	2,0	4	1,96	3,00	6,00	50	2

INDEXABLE MILLING

SOLID END MILLING

HOLEMAKING

TAPPING

TURNING

## Vision Plus Micro • Series 7N02 7N12 7N22 • Sharp Edge • Cylindrical Shank • Metric

(continued)

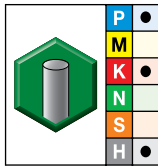
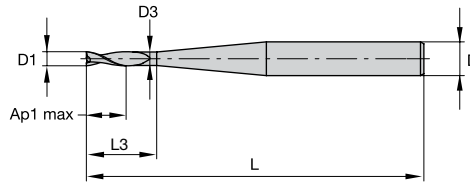

● first choice  
○ alternate choice

WU10PE

order #	catalog #	D1	D	D3	length of cut Ap1 max	L3	length L	ZU
2256495	7N2202011RJ	2,0	4	1,96	3,00	10,00	50	2
2256496	7N2202021RJ	2,0	4	1,96	3,00	16,00	50	2
2256497	7N2202031RJ	2,0	4	1,96	3,00	20,00	63	2
2256498	7N2202041RJ	2,0	4	1,96	3,00	20,00	75	2
2256401	7N0202002RJ	2,0	6	1,94	3,00	5,00	50	2
2256412	7N1202002RJ	2,0	6	1,96	3,00	10,00	60	2
3454429	7N2202051RJ	2,1	4	2,00	3,00	8,00	50	2
2256499	7N2202501RJ	2,5	4	2,40	3,70	8,00	50	2
2256500	7N2202511RJ	2,5	4	2,40	3,70	10,00	50	2
2256501	7N2202521RJ	2,5	4	2,44	3,70	16,00	63	2
2256502	7N2202531RJ	2,5	4	2,44	3,70	20,00	63	2
2256503	7N2202541RJ	2,5	4	2,44	3,70	30,00	80	2
2256402	7N0202502RJ	2,5	6	2,44	3,70	5,00	50	2
2256504	7N2203002RJ	3,0	6	2,94	4,50	8,00	50	2
2256505	7N2203012RJ	3,0	6	2,94	4,50	10,00	50	2
2256506	7N2203022RJ	3,0	6	2,94	4,50	16,00	63	2
2256507	7N2203032RJ	3,0	6	2,94	4,50	20,00	63	2
2256508	7N2203042RJ	3,0	6	2,94	4,50	20,00	80	2
3454434	7N2203062RJ	3,1	6	3,00	4,50	25,00	76	2

INDEXABLE MILLING

SOLID END MILLING

HOLEMAKING

TAPPING

TURNING

Vision Plus Micro • Series 7N01 • Ball Nose • Cylindrical Shank • Metric

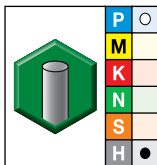
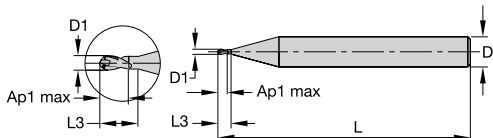

WU10PE

- first choice
- alternate choice

order #	catalog #	D1	D	length of cut Ap1 max	length L	ZU
2256358	7N0100302RJ	0,3	6	0,30	50	2
2256359	7N0100402RJ	0,4	6	0,40	50	2
2256360	7N0100502RJ	0,5	6	0,50	50	2
2256361	7N0100602RJ	0,6	6	0,60	50	2
2256362	7N0100802RJ	0,8	6	0,80	50	2
2256363	7N0101002RJ	1,0	6	2,50	50	2
2256364	7N0101202RJ	1,2	6	1,20	50	2
2256366	7N0101502RJ	1,5	6	1,50	50	2
2256369	7N0102002RJ	2,0	6	2,00	50	2
2256370	7N0102502RJ	2,5	6	2,50	50	2
2256371	7N0103002RJ	3,0	6	3,00	50	2
2256372	7N0104002RJ	4,0	6	4,00	50	2
2256373	7N0106002RJ	6,0	6	6,00	50	2

Vision Plus Micro • Series 7N21 • Ball Nose • Cylindrical Shank • Metric

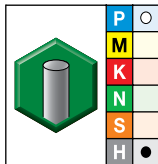
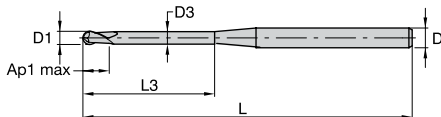

WU10PE

- first choice
- alternate choice

order #	catalog #	D1	D	D3	length of cut Ap1 max	L3	length L	ZU
3665122	7N2100501RT	0,5	4	0,44	1,00	5,00	63	2
3665141	7N2100801RT	0,8	4	0,74	1,30	8,00	63	2
3665142	7N2101001RT	1,0	4	0,94	1,60	10,00	63	2
3665164	7N2101501RT	1,5	4	1,44	2,40	16,00	63	2
3665166	7N2102001RT	2,0	4	1,94	3,20	20,00	63	2
3665168	7N2103001RT	3,0	4	2,90	4,50	30,00	63	2

Vision Plus • Series 7S05 • Application Data • AlTiN-MT1 • Inch

INDEXABLE MILLING

SOLID END MILLING

HOLEMAKING

TAPPING

TURNING

Material Group	Side Milling (A) and Slotting (B)			AITiN		Recommended feed per tooth (IPT = inch/th) for side milling (A). For slotting (B), reduce IPT by 20%.									
	A		B	Cutting Speed – vc SFM		D1 – Diameter									
	ap	ae	ap	min	max	frac. dec.	1/4	5/16	3/8	1/2	5/8	3/4	1		
P	3	1 x D	0.4 x D	1 x D	390	–	520	IPT	.0017	.0021	.0025	.0032	.0037	.0042	.0050
	4	1 x D	0.4 x D	0.75 x D	300	–	490	IPT	.0015	.0019	.0022	.0029	.0033	.0036	.0043
H	1	1 x D	0.4 x D	0.75 x D	260	–	460	IPT	.0015	.0019	.0022	.0029	.0033	.0036	.0043
	2	1 x D	0.3 x D	0.5 x D	230	–	390	IPT	.0011	.0014	.0017	.0021	.0024	.0027	.0031
	3	1 x D	0.15 x D	0.3 x D	200	–	300	IPT	.0009	.0011	.0013	.0017	.0020	.0022	.0027
	4	1 x D	0.1 x D	0.15 x D	160	–	230	IPT	.0006	.0008	.0009	.0011	.0013	.0015	.0018

NOTE: Lower value of cutting speed is used for high stock removal applications or for higher hardness (machinability) within group.  
 Higher value of cutting speed is used for finishing applications or for lower hardness (machinability) within group.  
 When using tools with 6 flutes, reduce slotting ap by 60%.  
 Above parameters are based on ideal conditions. For smaller taper machining centers, please adjust parameters on diameters >1/2".

Vision Plus • Series 7S7R • Application Data • AlTiN-MT1 • Inch

Material Group	Side Milling (A) and Slotting (B)			AITiN			Recommended feed per tooth (IPT = inch/th) for side milling (A). For slotting (B), reduce IPT by 20%.										
	A		B	Cutting Speed – vc SFM			D1 – Diameter										
	ap	ae	ap	min		max	frac.	5/32	3/16	1/4	5/16	3/8	1/2	5/8	3/4	1	
	ap	ae	ap	min		max	dec.	.1563	.1875	.2500	.3125	.3750	.5000	.6250	.7500	1.000	
P	3	0.8 x D	0.5 x D	0.75 x D	390	–	520	IPT	.0009	.0011	.0015	.0020	.0023	.0029	.0034	.0039	.0045
	4	0.8 x D	0.4 x D	0.5 x D	300	–	490	IPT	.0008	.0010	.0014	.0017	.0020	.0026	.0030	.0034	.0039
	5	0.8 x D	0.5 x D	0.75 x D	200	–	330	IPT	.0007	.0009	.0012	.0016	.0018	.0023	.0027	.0031	.0036
	6	0.8 x D	0.4 x D	0.5 x D	160	–	250	IPT	.0006	.0008	.0010	.0013	.0015	.0019	.0022	.0025	.0028
M	1	0.8 x D	0.5 x D	0.75 x D	300	–	380	IPT	.0009	.0011	.0015	.0020	.0023	.0029	.0034	.0039	.0045
	2	0.8 x D	0.4XD	0.75 x D	200	–	260	IPT	.0007	.0009	.0012	.0016	.0018	.0023	.0027	.0031	.0036
	3	0.8 x D	0.4 x D	0.75 x D	200	–	230	IPT	.0006	.0008	.0010	.0013	.0015	.0019	.0022	.0025	.0028
K	1	0.8 x D	0.5 x D	0.75 x D	390	–	490	IPT	.0011	.0013	.0018	.0023	.0027	.0034	.0039	.0044	.0049
	2	0.8 x D	0.5 x D	0.75 x D	360	–	460	IPT	.0009	.0011	.0015	.0020	.0023	.0029	.0034	.0039	.0045
	3	0.8 x D	0.4 x D	0.75 x D	360	–	430	IPT	.0007	.0009	.0012	.0016	.0018	.0023	.0027	.0031	.0036
S	1	0.8 x D	0.4 x D	0.75 x D	160	–	300	IPT	.0009	.0011	.0015	.0020	.0023	.0029	.0034	.0039	.0045
	2	0.8 x D	0.4 x D	0.75 x D	80	–	130	IPT	.0005	.0006	.0008	.0010	.0012	.0015	.0018	.0021	.0024
	3	0.8 x D	0.25 x D	0.3 x D	80	–	130	IPT	.0005	.0006	.0008	.0010	.0012	.0015	.0018	.0021	.0024
	4	0.8 x D	0.3 x D	0.5 x D	160	–	200	IPT	.0006	.0008	.0011	.0014	.0017	.0021	.0025	.0028	.0033
H	1	0.8 x D	0.5 x D	0.5 x D	260	–	460	IPT	.0008	.0010	.0014	.0017	.0020	.0026	.0030	.0034	.0039
	2	0.8 x D	0.2 x D	0.3 x D	230	–	390	IPT	.0006	.0008	.0010	.0013	.0015	.0019	.0022	.0025	.0028
	3	0.8 x D	0.15 x D	0.2 x D	200	–	300	IPT	.0005	.0006	.0008	.0010	.0012	.0015	.0018	.0021	.0024

NOTE: Lower value of cutting speed is used for high stock removal applications or for higher hardness (machinability) within group.  
Higher value of cutting speed is used for finishing applications or for lower hardness (machinability) within group.  
When using tools with 6 flutes, reduce slotting ap by 40%.  
Above parameters are based on ideal conditions. For smaller taper machining centers, please adjust parameters on diameters >1/2.

INDEXABLE MILLING

SOLID END MILLING

HOLEMAKING

TAPPING

TURNING



Vision Plus • Series 7S5F • Application Data • AlTiN-MT1 • Inch



INDEXABLE MILLING



SOLID END MILLING



HOLEMAKING

TAPPING

TURNING

																	
		Profile Milling		AlTiN			Recommended feed per tooth (IPT = inch/th) for 3D milling/profiling (A)										
Material Group	A	Cutting Speed – vc		D1 – Diameter													
		SFM		frac.	1/8	5/32	3/16	1/4	5/16	3/8	7/16	1/2	5/8	3/4			
		ap	ae	min	max	dec.	.1250	.1563	.1875	.2500	.3125	.3750	.4375	.5000	.6250	.7500	
P	3	0.5 x D	0.5 x D	910	–	1210	IPT	.0031	.0039	.0048	.0065	.0084	.0098	.0112	.0124	.0147	.0166
	4	0.5 x D	0.5 x D	680	–	1130	IPT	.0029	.0036	.0044	.0059	.0075	.0088	.0099	.0110	.0129	.0145
H	1	0.5 x D	0.5 x D	600	–	1060	IPT	.0029	.0036	.0044	.0059	.0075	.0088	.0099	.0110	.0129	.0145
	2	0.5 x D	0.5 x D	530	–	910	IPT	.0022	.0027	.0033	.0044	.0056	.0066	.0074	.0082	.0096	.0107
	3	0.5 x D	0.5 x D	450	–	680	IPT	.0017	.0021	.0026	.0035	.0044	.0052	.0059	.0066	.0078	.0089
	4	0.5 x D	0.5 x D	380	–	530	IPT	.0011	.0014	.0017	.0023	.0030	.0035	.0039	.0044	.0052	.0058

																	
		Profile Milling		AlTiN			Recommended feed per tooth (IPT = inch/th) for 3D milling/profiling (A)										
Material Group	A	Cutting Speed – vc		D1 – Diameter													
		SFM		frac.	1/8	5/32	3/16	1/4	5/16	3/8	7/16	1/2	5/8	3/4			
		ap	ae	min	max	dec.	.1250	.1563	.1875	.2500	.3125	.3750	.4375	.5000	.6250	.7500	
P	3	0.1 x D	0.1 x D	790	–	1050	IPT	.0022	.0027	.0033	.0046	.0059	.0069	.0078	.0087	.0102	.0116
	4	0.1 x D	0.1 x D	590	–	980	IPT	.0020	.0025	.0030	.0041	.0052	.0061	.0069	.0077	.0090	.0101
H	1	0.1 x D	0.1 x D	520	–	920	IPT	.0020	.0025	.0030	.0041	.0052	.0061	.0069	.0077	.0090	.0101
	2	0.1 x D	0.1 x D	460	–	790	IPT	.0015	.0019	.0023	.0031	.0039	.0046	.0052	.0057	.0067	.0075
	3	0.1 x D	0.1 x D	390	–	590	IPT	.0012	.0015	.0018	.0024	.0031	.0036	.0041	.0046	.0054	.0062
	4	0.1 x D	0.1 x D	330	–	460	IPT	.0008	.0010	.0012	.0016	.0021	.0024	.0027	.0031	.0036	.0041

																	
		Profile Milling		AlTiN			Recommended feed per tooth (IPT = inch/th) for 3D milling/profiling (A)										
Material Group	A	Cutting Speed – vc		D1 – Diameter													
		SFM		frac.	1/8	5/32	3/16	1/4	5/16	3/8	7/16	1/2	5/8	3/4			
		ap	ae	min	max	dec.	.1250	.1563	.1875	.2500	.3125	.3750	.4375	.5000	.6250	.7500	
P	3	0.2 x D	0.2 x D	510	–	680	IPT	.0009	.0012	.0014	.0020	.0025	.0030	.0034	.0038	.0044	.0050
	4	0.2 x D	0.2 x D	380	–	640	IPT	.0009	.0011	.0013	.0018	.0023	.0027	.0030	.0033	.0039	.0044
H	1	0.2 x D	0.2 x D	340	–	600	IPT	.0009	.0011	.0013	.0018	.0023	.0027	.0030	.0033	.0039	.0044
	2	0.2 x D	0.2 x D	300	–	510	IPT	.0007	.0008	.0010	.0013	.0017	.0020	.0022	.0025	.0029	.0032
	3	0.2 x D	0.2 x D	260	–	380	IPT	.0005	.0006	.0008	.0011	.0013	.0016	.0018	.0020	.0024	.0027
	4	0.2 x D	0.2 x D	210	–	300	IPT	.0003	.0004	.0005	.0007	.0009	.0010	.0012	.0013	.0016	.0018

NOTE: Lower value of cutting speed is used for high stock removal applications or for higher hardness (machinability) within group.  
 Higher value of cutting speed is used for finishing applications or for lower hardness (machinability) within group.  
 For better surface finish, reduce feed per tooth.  
 Above parameters are based on ideal conditions. For smaller taper machining centers, please adjust parameters on diameters >1/2".

Vision Plus • Series 7505 7545 7515 7525 • Application Data • TiAlN-LT1 • Metric

Material Group	Side Milling (A) and Slotting (B)		TiAlN		Recommended feed per tooth (fz = mm/th) for side milling (A). For slotting (B), reduce fz by 20%.																	
	A		B		Cutting Speed – vc m/min			mm	D1 – Diameter													
	ap	ae	ap	min	max	4,0	5,0		6,0	8,0	10,0	12,0	14,0	16,0	18,0	20,0	25,0					
P	3	1 x D	0,4 x D	1 x D	120	–	160	fz	0,026	0,033	0,040	0,055	0,067	0,077	0,087	0,096	0,104	0,111	0,125			
	4	1 x D	0,4 x D	0,75 x D	90	–	150	fz	0,024	0,030	0,036	0,049	0,059	0,069	0,077	0,084	0,091	0,097	0,107			
H	1	1 x D	0,4 x D	0,75 x D	80	–	140	fz	0,024	0,030	0,036	0,049	0,059	0,069	0,077	0,084	0,091	0,097	0,107			
	2	1 x D	0,3 x D	0,5 x D	70	–	120	fz	0,018	0,022	0,027	0,037	0,044	0,051	0,057	0,063	0,067	0,071	0,078			
	3	1 x D	0,15 x D	0,3 x D	60	–	90	fz	0,014	0,018	0,021	0,029	0,035	0,041	0,046	0,051	0,055	0,059	0,067			
	4	1 x D	0,1 x D	0,15 x D	50	–	70	fz	0,009	0,012	0,014	0,019	0,023	0,027	0,031	0,034	0,037	0,039	0,044			

NOTE: Lower value of cutting speed is used for high stock removal applications or for higher hardness (machinability) within group.  
Higher value of cutting speed is used for finishing applications or for lower hardness (machinability) within group.  
For better surface finish, reduce feed per tooth.

Vision Plus • Series 7515 • Application Data • TiAlN-LT1 • Metric

Material Group	Side Milling (A) and Slotting (B)		TiAlN		Recommended feed per tooth (fz = mm/th) for side milling (A). For slotting (B), reduce fz by 20%.																	
	A		B		Cutting Speed – vc m/min			mm	D1 – Diameter													
	ap	ae	ap	min	max	3,0	4,0		5,0	6,0	8,0	10,0	12,0	16,0	20,0	25,0						
P	3	2 x D	0,3 x D	0,75 x D	160	–	180	fz	0,019	0,026	0,033	0,040	0,055	0,067	0,077	0,096	0,111	0,125				
	4	2 x D	0,25 x D	0,5 x D	140	–	160	fz	0,017	0,024	0,030	0,036	0,049	0,059	0,069	0,084	0,097	0,107				
H	1	2 x D	0,25 x D	0,5 x D	120	–	140	fz	0,017	0,024	0,030	0,036	0,049	0,059	0,069	0,084	0,097	0,107				
	2	2 x D	0,2 x D	0,4 x D	80	–	130	fz	0,013	0,018	0,022	0,027	0,037	0,044	0,051	0,063	0,071	0,078				
	3	2 x D	0,1 x D	0,2 x D	70	–	100	fz	0,010	0,014	0,018	0,021	0,029	0,035	0,041	0,051	0,059	0,067				
	4	2 x D	0,05 x D	0,05 x D	50	–	70	fz	0,007	0,009	0,012	0,014	0,019	0,023	0,027	0,034	0,039	0,044				

NOTE: Lower value of cutting speed is used for high stock removal applications or for higher hardness (machinability) within group.  
Higher value of cutting speed is used for finishing applications or for lower hardness (machinability) within group.  
For better surface finish, reduce feed per tooth.

Vision Plus • Series 7525 • Application Data • TiAlN-LT1 • Metric

Material Group	Side Milling (A) and Slotting (B)		TiAlN		Recommended feed per tooth (fz = mm/th) for side milling (A). For slotting (B), reduce fz by 20%.																	
	A		B		Cutting Speed – vc m/min			mm	D1 – Diameter													
	ap	ae	ap	min	max	3,0	4,0		5,0	6,0	8,0	10,0	12,0	16,0	20,0	25,0						
P	3	3 x D	0,2 x D	0,5 x D	160	–	180	fz	0,019	0,026	0,033	0,040	0,055	0,067	0,077	0,096	0,111	0,125				
	4	3 x D	0,2 x D	0,3 x D	140	–	160	fz	0,017	0,024	0,030	0,036	0,049	0,059	0,069	0,084	0,097	0,107				
H	1	3 x D	0,2 x D	0,3 x D	120	–	140	fz	0,017	0,024	0,030	0,036	0,049	0,059	0,069	0,084	0,097	0,107				
	2	3 x D	0,15 x D	0,2 x D	80	–	130	fz	0,013	0,018	0,022	0,027	0,037	0,044	0,051	0,063	0,071	0,078				
	3	3 x D	0,05 x D	–	70	–	100	fz	0,010	0,014	0,018	0,021	0,029	0,035	0,041	0,051	0,059	0,067				
	4	3 x D	0,03 x D	–	50	–	70	fz	0,007	0,009	0,012	0,014	0,019	0,023	0,027	0,034	0,039	0,044				

NOTE: Lower value of cutting speed is used for high stock removal applications or for higher hardness (machinability) within group.  
Higher value of cutting speed is used for finishing applications or for lower hardness (machinability) within group.  
For better surface finish, reduce feed per tooth.

Vision Plus • Series 7585 7595 • Application Data • TiAlN-LT1 • Metric

Material Group							Recommended feed per tooth (fz = mm/th) for side milling (A). For slotting (B), reduce fz by 20%.														
		Side Milling (A) and Slotting (B)		TiAlN			D1 – Diameter														
		A		B	Cutting Speed – vc m/min			mm													
		ap	ae	ap	min		max		4,0	5,0	6,0	8,0	10,0	12,0	14,0	16,0	18,0	20,0	25,0		
P	3	1 x D	0,4 x D	1 x D	120	–	160	fz	0,019	0,033	0,040	0,055	0,067	0,077	0,077	0,096	0,096	0,111	0,125		
	4	1 x D	0,4 x D	0,75 x D	90	–	150	fz	0,017	0,030	0,036	0,049	0,059	0,069	0,069	0,084	0,084	0,097	0,107		
H	1	1 x D	0,4 x D	0,75 x D	80	–	140	fz	0,017	0,030	0,036	0,049	0,059	0,069	0,069	0,084	0,084	0,097	0,107		
	2	1 x D	0,3 x D	0,5 x D	70	–	120	fz	0,013	0,022	0,027	0,037	0,044	0,051	0,051	0,063	0,063	0,071	0,078		
	3	1 x D	0,15 x D	0,3 x D	60	–	90	fz	0,010	0,018	0,021	0,029	0,035	0,041	0,041	0,051	0,051	0,059	0,067		
	4	1 x D	0,1 x D	0,15 x D	50	–	70	fz	0,007	0,012	0,014	0,019	0,023	0,027	0,027	0,034	0,034	0,039	0,044		

NOTE: Lower value of cutting speed is used for high stock removal applications or for higher hardness (machinability) within group.  
Higher value of cutting speed is used for finishing applications or for lower hardness (machinability) within group.  
For better surface finish, reduce feed per tooth.

Vision Plus™ • Series 75N2 • Application Data • WU10PE • Metric

Material Group							Recommended feed per tooth (fz = mm/th) for side milling (A). For slotting (B), reduce fz by 20%.								
		Side Milling (A) and Slotting (B)		WU10PE			D1 – Diameter								
		A		B	Cutting Speed – vc m/min			mm							
		ap	ae	ap	min		max		3,0	4,0	5,0	6,0	8,0	10,0	12,0
P	3	0,75 x D	0,1 x D	0,4 x D	160	–	180	fz	0,017	0,023	0,030	0,036	0,050	0,061	0,070
	4	0,75 x D	0,1 x D	0,4 x D	140	–	160	fz	0,016	0,021	0,027	0,033	0,045	0,054	0,062
H	1	0,75 x D	0,1 x D	0,4 x D	120	–	140	fz	0,016	0,021	0,027	0,033	0,045	0,054	0,062
	2	0,75 x D	0,05 x D	0,3 x D	100	–	130	fz	0,016	0,020	0,025	0,029	0,034	0,037	0,040
	3	0,75 x D	0,03 x D	0,2 x D	70	–	100	fz	0,013	0,016	0,019	0,023	0,026	0,029	0,032
	4	0,75 x D	0,01 x D	0,1 x D	50	–	70	fz	0,008	0,011	0,013	0,015	0,018	0,019	0,021



NOTE: Lower value of cutting speed is used for high stock removal applications or for higher hardness (machinability) within group.  
Higher value of cutting speed is used for finishing applications or for lower hardness (machinability) within group.

Vision Plus • Series 75N5 Finishing • Application Data • WU10PE • Metric

Material Group							Recommended feed per tooth (fz = mm/th) for side milling (A). For slotting (B), reduce fz by 20%.														
		Side Milling (A) and Slotting (B)		TiAlN			D1 – Diameter														
		A		B	Cutting Speed – vc m/min			mm													
		ap	ae	ap	min		max		4,0	5,0	6,0	8,0	10,0	12,0	14,0	16,0	18,0	20,0	25,0		
P	3	1 x D	0,4 x D	1 x D	120	–	160	fz	0,026	0,033	0,040	0,055	0,067	0,077	0,087	0,096	0,104	0,111	0,125		
	4	1 x D	0,4 x D	0,75 x D	90	–	150	fz	0,024	0,030	0,036	0,049	0,059	0,069	0,077	0,084	0,091	0,097	0,107		
H	1	1 x D	0,4 x D	0,75 x D	80	–	140	fz	0,024	0,030	0,036	0,049	0,059	0,069	0,077	0,084	0,091	0,097	0,107		
	2	1 x D	0,3 x D	0,5 x D	70	–	120	fz	0,018	0,022	0,027	0,037	0,044	0,051	0,057	0,063	0,067	0,071	0,078		
	3	1 x D	0,15 x D	0,3 x D	60	–	90	fz	0,014	0,018	0,021	0,029	0,035	0,041	0,046	0,051	0,055	0,059	0,067		
	4	1 x D	0,1 x D	0,15 x D	50	–	70	fz	0,009	0,012	0,014	0,019	0,023	0,027	0,031	0,034	0,037	0,039	0,044		

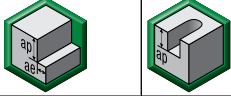

NOTE: Lower value of cutting speed is used for high stock removal applications or for higher hardness (machinability) within group.  
Higher value of cutting speed is used for finishing applications or for lower hardness (machinability) within group.  
For better surface finish, reduce feed per tooth.

Vision Plus • Series 7670 • Application Data • TiAlN-LT1 • Metric

Material Group																	
	Side Milling (A) and Slotting (B)		TiAlN		Recommended feed per tooth (fz = mm/th) for side milling (A).												
			Cutting Speed – vc m/min		For slotting (B), reduce fz by 10%.												
	A		B		D1 – Diameter												
	ap	ae	ap	min	max	mm	4,0	5,0	6,0	8,0	10,0	12,0	16,0	20,0	25,0		
P	3	0,8 x D	0,5 x D	0,75 x D	160	–	180	fz	0,020	0,025	0,031	0,043	0,051	0,063	0,078	0,101	0,114
	4	0,8 x D	0,4 x D	0,5 x D	140	–	160	fz	0,018	0,023	0,028	0,038	0,046	0,056	0,069	0,088	0,098
	5	0,8 x D	0,5 x D	0,75 x D	60	–	100	fz	0,016	0,021	0,025	0,034	0,041	0,051	0,063	0,081	0,091
	6	0,8 x D	0,4 x D	0,5 x D	50	–	80	fz	0,014	0,017	0,021	0,029	0,034	0,042	0,051	0,065	0,071
M	1	0,8 x D	0,5 x D	0,75 x D	80	–	100	fz	0,020	0,025	0,031	0,043	0,051	0,063	0,078	0,101	0,114
	2	0,8 x D	0,4 x D	0,75 x D	60	–	80	fz	0,016	0,021	0,025	0,034	0,041	0,051	0,063	0,081	0,091
	3	0,8 x D	0,4 x D	0,75 x D	60	–	80	fz	0,014	0,017	0,021	0,029	0,034	0,042	0,051	0,065	0,071
K	1	0,8 x D	0,5 x D	0,75 x D	120	–	160	fz	0,024	0,031	0,037	0,051	0,061	0,075	0,091	0,114	0,124
	2	0,8 x D	0,5 x D	0,75 x D	110	–	140	fz	0,020	0,025	0,031	0,043	0,051	0,063	0,078	0,101	0,114
	3	0,8 x D	0,4 x D	0,75 x D	100	–	130	fz	0,016	0,021	0,025	0,034	0,041	0,051	0,063	0,081	0,091
S	1	0,8 x D	0,4 x D	0,75 x D	50	–	90	fz	0,023	0,030	0,036	0,050	0,061	0,070	0,087	0,101	0,114
	2	0,8 x D	0,25 x D	0,3 x D	25	–	40	fz	0,013	0,016	0,019	0,026	0,032	0,037	0,046	0,054	0,061
	3	0,8 x D	0,4 x D	0,75 x D	25	–	40	fz	0,013	0,016	0,019	0,026	0,032	0,037	0,046	0,054	0,061
	4	0,8 x D	0,3 x D	0,5 x D	50	–	60	fz	0,016	0,021	0,026	0,037	0,045	0,052	0,064	0,074	0,084
H	1	0,8 x D	0,5 x D	0,5 x D	120	–	140	fz	0,018	0,023	0,028	0,038	0,046	0,056	0,069	0,088	0,098
	2	0,8 x D	0,2 x D	0,3 x D	80	–	130	fz	0,014	0,017	0,021	0,029	0,034	0,042	0,051	0,065	0,071
	3	0,8 x D	0,15 x D	0,2 x D	70	–	100	fz	0,011	0,014	0,017	0,023	0,027	0,034	0,041	0,052	0,057

NOTE: Lower value of cutting speed is used for high stock removal applications or for higher hardness (machinability) within group.  
 Higher value of cutting speed is used for finishing applications or for lower hardness (machinability) within group.  
 For rougher tool with 6 flutes, use ap in slotting 60% of table value.  
 Above parameters are based on ideal conditions. For smaller taper machining centers, please adjust parameters on diameters >12mm.

Vision Plus™ • Series D518 • Application Data • WP15PE • Metric

Material Group																		
	Side Milling (A)		WP15PE		Recommended feed per tooth (fz = mm/th) for side milling (A).													
	A		Cutting Speed – vc m/min		D1 – Diameter													
		ap	ae	min	max	mm	4,0	5,0	6,0	8,0	10,0	12,0	14,0	16,0	18,0	20,0	25,0	
P	0	Ap1 max	0,05 x D	150	–	200	fz	0,028	0,036	0,044	0,060	0,072	0,083	0,092	0,101	0,108	0,114	0,124
	1	Ap1 max	0,05 x D	150	–	200	fz	0,028	0,036	0,044	0,060	0,072	0,083	0,092	0,101	0,108	0,114	0,124
	2	Ap1 max	0,05 x D	140	–	190	fz	0,028	0,036	0,044	0,060	0,072	0,083	0,092	0,101	0,108	0,114	0,124
	3	Ap1 max	0,05 x D	120	–	160	fz	0,023	0,030	0,036	0,050	0,061	0,070	0,079	0,087	0,095	0,101	0,114
	4	Ap1 max	0,05 x D	90	–	150	fz	0,021	0,027	0,033	0,045	0,054	0,062	0,070	0,077	0,083	0,088	0,098
	5	Ap1 max	0,05 x D	60	–	100	fz	0,019	0,024	0,029	0,040	0,048	0,056	0,063	0,070	0,076	0,081	0,091
M	6	Ap1 max	0,04 x D	50	–	75	fz	0,016	0,020	0,025	0,034	0,040	0,047	0,052	0,057	0,061	0,065	0,071
	1	Ap1 max	0,05 x D	90	–	115	fz	0,023	0,030	0,036	0,050	0,061	0,070	0,079	0,087	0,095	0,101	0,114
	2	Ap1 max	0,05 x D	60	–	80	fz	0,019	0,024	0,029	0,040	0,048	0,056	0,063	0,070	0,076	0,081	0,091
K	3	Ap1 max	0,05 x D	60	–	70	fz	0,016	0,020	0,025	0,034	0,040	0,047	0,052	0,057	0,061	0,065	0,071
	1	Ap1 max	0,05 x D	120	–	150	fz	0,028	0,036	0,044	0,060	0,072	0,083	0,092	0,101	0,108	0,114	0,124
	2	Ap1 max	0,05 x D	110	–	140	fz	0,023	0,030	0,036	0,050	0,061	0,070	0,079	0,087	0,095	0,101	0,114
S	3	Ap1 max	0,05 x D	110	–	130	fz	0,019	0,024	0,029	0,040	0,048	0,056	0,063	0,070	0,076	0,081	0,091
	1	Ap1 max	0,04 x D	50	–	90	fz	0,023	0,030	0,036	0,050	0,061	0,070	0,079	0,087	0,095	0,101	0,114
	2	Ap1 max	0,04 x D	25	–	40	fz	0,013	0,016	0,019	0,026	0,032	0,037	0,042	0,046	0,050	0,054	0,061
	3	Ap1 max	0,05 x D	25	–	40	fz	0,013	0,016	0,019	0,026	0,032	0,037	0,042	0,046	0,050	0,054	0,061
H	4	Ap1 max	0,05 x D	50	–	60	fz	0,016	0,021	0,026	0,037	0,045	0,052	0,058	0,064	0,069	0,074	0,084
	1	Ap1 max	0,04 x D	80	–	140	fz	0,021	0,027	0,033	0,045	0,054	0,062	0,070	0,077	0,083	0,088	0,098
	2	Ap1 max	0,05 x D	70	–	120	fz	0,016	0,020	0,025	0,034	0,040	0,047	0,052	0,057	0,061	0,065	0,071

NOTE: Lower value of cutting speed is used for high stock removal applications or for higher hardness (machinability) within group.  
 Higher value of cutting speed is used for finishing applications or for lower hardness (machinability) within group.  
 For better surface finish, reduce feed per tooth.

Vision Plus • Series D618 • Application Data • WU10PE • Metric

INDEXABLE MILLING

SOLID END MILLING

		Side Milling (A)		WU10PE			Recommended feed per tooth (fz = mm/th) for side milling (A).													
Material Group	A	Cutting Speed – vc m/min			mm	D1 – Diameter														
		ap	ae	min		max	3,0	4,0	5,0	6,0	8,0	10,0	12,0	16,0	20,0					
P	3	2 x D	0,15 x D	120	–	160	fz	0,019	0,026	0,033	0,040	0,055	0,067	0,077	0,096	0,111				
	4	2 x D	0,15 x D	90	–	150	fz	0,017	0,024	0,030	0,036	0,049	0,059	0,069	0,084	0,097				
H	1	2 x D	0,15 x D	80	–	140	fz	0,017	0,024	0,030	0,036	0,049	0,059	0,069	0,084	0,097				
	2	2 x D	0,15 x D	70	–	120	fz	0,013	0,018	0,022	0,027	0,037	0,044	0,051	0,063	0,071				
	3	2 x D	0,1 x D	60	–	90	fz	0,010	0,014	0,018	0,021	0,029	0,035	0,041	0,051	0,059				
	4	2 x D	0,05 x D	50	–	70	fz	0,007	0,009	0,012	0,014	0,019	0,023	0,027	0,034	0,039				

NOTE: Lower value of cutting speed is used for high stock removal applications or for higher hardness (machinability) within group.  
Higher value of cutting speed is used for finishing applications or for lower hardness (machinability) within group.  
For better surface finish, reduce feed per tooth.  
Above parameters are based on ideal conditions. For smaller taper machining centers, please adjust parameters accordingly on diameters >12mm.

HOLEMAKING

Vision Plus • Series 7050 7060 Roughing • Application Data • WU10PE • Metric

TAPPING

		A		WU10PE			Recommended feed per tooth (Fz=mm/th) for 3D milling/profiling (A) - roughing													
Material Group	A	Cutting Speed – vc m/min			mm	D1 – Diameter														
		ap	ae	Min		Max	2,0	3,0	4,0	6,0	8,0	10,0	12,0	16,0	20,0					
P	3	0,2 x D	0,1 x D	208	–	234	Fz	0,015	0,023	0,031	0,049	0,067	0,081	0,094	0,117	0,136				
	4	0,2 x D	0,1 x D	182	–	208	Fz	0,014	0,021	0,029	0,044	0,060	0,073	0,084	0,103	0,118				
H	1	0,15 x D	0,1 x D	140	–	196	Fz	0,021	0,032	0,043	0,066	0,090	0,109	0,125	0,154	0,177				
	2	0,1 x D	0,075 x D	119	–	204	Fz	0,024	0,036	0,048	0,074	0,101	0,121	0,140	0,171	0,194				
	3	0,05 x D	0,05 x D	138	–	207	Fz	0,027	0,041	0,055	0,084	0,114	0,138	0,161	0,200	0,233				
	4	0,05 x D	0,05 x D	115	–	161	Fz	0,018	0,027	0,037	0,056	0,076	0,092	0,107	0,133	0,154				

NOTE: Please use the reference table to optimize your cutting speed based on the average cutting angle of the application.

TURNING

Vision Plus • Series 7050 7060 Semi-Finishing • Application Data • WU10PE • Metric

		Profile Milling		WU10PE			Recommended feed per tooth (fz = mm/th) for 3D milling/profiling (A) – semi-finishing													
Material Group	A	Cutting Speed – vc m/min			mm	D1 – Diameter														
		ap	ae	min		max	1,0	2,0	2,5	3,0	4,0	5,0	6,0	8,0	10,0	12,0				
P	3	0,1 x D	0,1 x D	240	–	320	fz	0,017	0,034	0,043	0,052	0,070	0,089	0,109	0,150	0,182	0,211			
	4	0,1 x D	0,1 x D	180	–	300	fz	0,016	0,031	0,040	0,048	0,064	0,081	0,099	0,134	0,162	0,187			
H	1	0,1 x D	0,1 x D	160	–	280	fz	0,016	0,031	0,040	0,048	0,064	0,081	0,099	0,134	0,162	0,187			
	2	0,1 x D	0,1 x D	140	–	240	fz	0,012	0,024	0,030	0,036	0,048	0,061	0,074	0,101	0,121	0,140			
	3	0,1 x D	0,1 x D	120	–	180	fz	0,009	0,019	0,024	0,028	0,038	0,048	0,058	0,079	0,096	0,112			
	4	0,1 x D	0,1 x D	100	–	140	fz	0,006	0,012	0,016	0,019	0,025	0,032	0,039	0,053	0,064	0,074			

NOTE: Please use the reference table to optimize your cutting speed based on the average cutting angle of the application.

Vision Plus • Series 7050 7060 Finishing • Application Data • WU10PE • Metric

Material Group	A		WU10PE Cutting Speed – vc m/min		mm	Recommended feed per tooth (Fz=mm/th) for 3D milling/profiling (A) - finishing										
	ap	ae	Min	Max		D1 - Diameter										
						2,0	3,0	4,0	6,0	8,0	10,0	12,0	16,0	20,0		
P	3	0,04 x D	0,04 x D	416	–	468	Fz	0,052	0,080	0,108	0,168	0,231	0,279	0,324	0,403	0,466
	4	0,04 x D	0,04 x D	364	–	416	Fz	0,048	0,073	0,099	0,152	0,207	0,249	0,288	0,355	0,406
H	1	0,03 x D	0,03 x D	290	–	406	Fz	0,052	0,078	0,106	0,162	0,221	0,266	0,308	0,379	0,434
	2	0,03 x D	0,03 x D	203	–	348	Fz	0,039	0,059	0,080	0,122	0,166	0,199	0,230	0,281	0,320
	3	0,02 x D	0,02 x D	216	–	324	Fz	0,033	0,050	0,067	0,102	0,139	0,168	0,196	0,244	0,284
	4	0,02 x D	0,02 x D	180	–	252	Fz	0,022	0,033	0,045	0,068	0,093	0,112	0,130	0,162	0,187

NOTE: Please use the reference table to optimize your cutting speed based on the average cutting angle of the application.

Vision Plus • Series 7061 Roughing • Application Data • WU10PE • Metric

Material Group	A		WU10PE Cutting Speed – vc m/min		mm	Recommended feed per tooth (Fz=mm/th) for 3D milling/profiling (A) - roughing										
	ap	ae	Min	Max		D1 - Diameter										
						2,0	3,0	4,0	6,0	8,0	10,0	12,0	16,0	20,0		
P	3	0,2D	0,1D	208	–	234	Fz	0,015	0,023	0,031	0,049	0,067	0,081	0,094	0,117	0,136
	4	0,2D	0,1D	182	–	208	Fz	0,014	0,021	0,029	0,044	0,060	0,073	0,084	0,103	0,118
H	1	0,15D	0,1D	140	–	196	Fz	0,021	0,032	0,043	0,066	0,090	0,109	0,125	0,154	0,177
	2	0,1D	0,075D	119	–	204	Fz	0,024	0,036	0,048	0,074	0,101	0,121	0,140	0,171	0,194
	3	0,05D	0,05D	138	–	207	Fz	0,027	0,041	0,055	0,084	0,114	0,138	0,161	0,200	0,233
	4	0,05D	0,05D	115	–	161	Fz	0,018	0,027	0,037	0,056	0,076	0,092	0,107	0,133	0,154

NOTE: Please use the reference table to optimize your cutting speed based on the average cutting angle of the application.

Vision Plus • Series 7061 Semi-Finishing • Application Data • WU10PE • Metric

Material Group	A		WU10PE Cutting Speed – vc m/min		mm	Recommended feed per tooth (fz = mm/th) for 3D milling/profiling (A) – semi-finishing											
	ap	ae	min	max		D1 – Diameter											
						1,0	2,0	2,5	3,0	4,0	5,0	6,0	8,0	10,0	12,0		
P	3	0,1 x D	0,05 x D	240	–	320	fz	0,017	0,034	0,043	0,052	0,070	0,089	0,109	0,150	0,182	0,211
	4	0,1 x D	0,1 x D	180	–	300	fz	0,016	0,031	0,040	0,048	0,064	0,081	0,099	0,134	0,162	0,187
H	1	0,1 x D	0,1 x D	160	–	280	fz	0,016	0,031	0,040	0,048	0,064	0,081	0,099	0,134	0,162	0,187
	2	0,1 x D	0,1 x D	140	–	240	fz	0,012	0,024	0,030	0,036	0,048	0,061	0,074	0,101	0,121	0,140
	3	0,1 x D	0,1 x D	120	–	180	fz	0,009	0,019	0,024	0,028	0,038	0,048	0,058	0,079	0,096	0,112
	4	0,1 x D	0,1 x D	100	–	140	fz	0,006	0,012	0,016	0,019	0,025	0,032	0,039	0,053	0,064	0,074

NOTE: Please use the reference table to optimize your cutting speed based on the average cutting angle of the application.

### Vision Plus • Series 7061 Finishing • Application Data • WU10PE • Metric

Material Group	A		WU10PE Recommended feed per tooth (Fz=mm/th) for 3D milling/profiling (A) - finishing													
	Cutting Speed – vc m/min		D1 - Diameter													
	ap	ae	mm													
	ap	ae	Min	Max	2,0	3,0	4,0	6,0	8,0	10,0	12,0	16,0	20,0			
P	3	0,04 x D	0,04 x D	416	–	468	Fz	0,052	0,080	0,108	0,168	0,231	0,279	0,324	0,403	0,466
	4	0,04 x D	0,04 x D	364	–	416	Fz	0,048	0,073	0,099	0,152	0,207	0,249	0,288	0,355	0,406
H	1	0,03 x D	0,03 x D	290	–	406	Fz	0,052	0,078	0,106	0,162	0,221	0,266	0,308	0,379	0,434
	2	0,03 x D	0,03 x D	203	–	348	Fz	0,039	0,059	0,080	0,122	0,166	0,199	0,230	0,281	0,320
	3	0,02 x D	0,02 x D	216	–	324	Fz	0,033	0,050	0,067	0,102	0,139	0,168	0,196	0,244	0,284
	4	0,02 x D	0,02 x D	180	–	252	Fz	0,022	0,033	0,045	0,068	0,093	0,112	0,130	0,162	0,187

NOTE: Please use the reference table to optimize your cutting speed based on the average cutting angle of the application.

### Vision Plus • Series 7150 Roughing • Application Data • WU10PE • Metric

Material Group	A		WU10PE Recommended feed per tooth (Fz=mm/th) for 3D milling/profiling (A) - roughing													
	Cutting Speed – vc m/min		D1 - Diameter													
	ap	ae	mm													
	ap	ae	Min	Max	2,0	3,0	4,0	6,0	8,0	10,0	12,0	16,0	20,0			
P	3	0,2 x D	0,1 x D	208	–	234	Fz	0,015	0,023	0,031	0,049	0,067	0,081	0,094	0,117	0,136
	4	0,2 x D	0,1 x D	182	–	208	Fz	0,014	0,021	0,029	0,044	0,060	0,073	0,084	0,103	0,118
H	1	0,15 x D	0,1 x D	140	–	196	Fz	0,021	0,032	0,043	0,066	0,090	0,109	0,125	0,154	0,177
	2	0,1 x D	0,075 x D	119	–	204	Fz	0,024	0,036	0,048	0,074	0,101	0,121	0,140	0,171	0,194
	3	0,05 x D	0,05 x D	138	–	207	Fz	0,027	0,041	0,055	0,084	0,114	0,138	0,161	0,200	0,233
	4	0,05 x D	0,05 x D	115	–	161	Fz	0,018	0,027	0,037	0,056	0,076	0,092	0,107	0,133	0,154

NOTE: Please use the reference table to optimize your cutting speed based on the average cutting angle of the application.

### Vision Plus • Series 7150 Semi-Finishing • Application Data • WU10PE • Metric

Material Group	A		WU10PE Recommended feed per tooth (fz = mm/th) for 3D milling/profiling (A) – semi-finishing														
	Cutting Speed – vc m/min		D1 – Diameter														
	ap	ae	mm														
	ap	ae	min	max	1,0	2,0	2,5	3,0	4,0	5,0	6,0	8,0	10,0	12,0			
P	3	0,1 x D	0,1 x D	240	–	320	fz	0,017	0,034	0,043	0,052	0,070	0,089	0,109	0,150	0,182	0,211
	4	0,1 x D	0,1 x D	180	–	300	fz	0,016	0,031	0,040	0,048	0,064	0,081	0,099	0,134	0,162	0,187
H	1	0,1 x D	0,1 x D	160	–	280	fz	0,016	0,031	0,040	0,048	0,064	0,081	0,099	0,134	0,162	0,187
	2	0,1 x D	0,1 x D	140	–	240	fz	0,012	0,024	0,030	0,036	0,048	0,061	0,074	0,101	0,121	0,140
	3	0,1 x D	0,1 x D	120	–	180	fz	0,009	0,019	0,024	0,028	0,038	0,048	0,058	0,079	0,096	0,112
	4	0,1 x D	0,1 x D	100	–	140	fz	0,006	0,012	0,016	0,019	0,025	0,032	0,039	0,053	0,064	0,074

NOTE: Please use the reference table to optimize your cutting speed based on the average cutting angle of the application.



Vision Plus • Series 7150 Finishing • Application Data • WU10PE • Metric

Material Group	A		WU10PE Recommended feed per tooth (Fz=mm/th) for 3D milling/profiling (A) - finishing													
	A		Cutting Speed – vc m/min			mm	D1 - Diameter									
	ap	ae	Min	–	Max		2,0	3,0	4,0	6,0	8,0	10,0	12,0	16,0	20,0	
						Fz										
P	3	0,04 x D	0,04 x D	416	–	468	Fz	0,052	0,080	0,108	0,168	0,231	0,279	0,324	0,403	0,466
	4	0,04 x D	0,04 x D	364	–	416	Fz	0,048	0,073	0,099	0,152	0,207	0,249	0,288	0,355	0,406
H	1	0,03 x D	0,03 x D	290	–	406	Fz	0,052	0,078	0,106	0,162	0,221	0,266	0,308	0,379	0,434
	2	0,03 x D	0,03 x D	203	–	348	Fz	0,039	0,059	0,080	0,122	0,166	0,199	0,230	0,281	0,320
	3	0,02 x D	0,02 x D	216	–	324	Fz	0,033	0,050	0,067	0,102	0,139	0,168	0,196	0,244	0,284
	4	0,02 x D	0,02 x D	180	–	252	Fz	0,022	0,033	0,045	0,068	0,093	0,112	0,130	0,162	0,187

NOTE: Please use the reference table to optimize your cutting speed based on the average cutting angle of the application.

Vision Plus • Series 7151 Roughing • Application Data • WU10PE • Metric

Material Group	A		WU10PE Recommended feed per tooth (Fz=mm/th) for 3D milling/profiling (A) - roughing													
	A		Cutting Speed – vc m/min			mm	D1 - Diameter									
	ap	ae	Min	–	Max		2,0	3,0	4,0	6,0	8,0	10,0	12,0	16,0	20,0	
						Fz										
P	3	0,2 x D	0,1 x D	208	–	234	Fz	0,015	0,023	0,031	0,049	0,067	0,081	0,094	0,117	0,136
	4	0,2 x D	0,1 x D	182	–	208	Fz	0,014	0,021	0,029	0,044	0,060	0,073	0,084	0,103	0,118
H	1	0,15 x D	0,1 x D	140	–	196	Fz	0,021	0,032	0,043	0,066	0,090	0,109	0,125	0,154	0,177
	2	0,1 x D	0,075 x D	119	–	204	Fz	0,024	0,036	0,048	0,074	0,101	0,121	0,140	0,171	0,194
	3	0,05 x D	0,05 x D	138	–	207	Fz	0,027	0,041	0,055	0,084	0,114	0,138	0,161	0,200	0,233
	4	0,05 x D	0,05 x D	115	–	161	Fz	0,018	0,027	0,037	0,056	0,076	0,092	0,107	0,133	0,154

NOTE: Please use the reference table to optimize your cutting speed based on the average cutting angle of the application.

Vision Plus • Series 7151 Semi-Finishing • Application Data • WU10PE • Metric

Material Group	A		WU10PE Recommended feed per tooth (fz = mm/th) for 3D milling/profiling (A) – semi-finishing														
	A		Cutting Speed – vc m/min			mm	D1 – Diameter										
	ap	ae	min	–	max		1,0	2,0	2,5	3,0	4,0	5,0	6,0	8,0	10,0	12,0	
						fz											
P	3	0,1 x D	0,05 x D	240	–	320	fz	0,017	0,034	0,043	0,052	0,070	0,089	0,109	0,150	0,182	0,211
	4	0,1 x D	0,1 x D	180	–	300	fz	0,016	0,031	0,040	0,048	0,064	0,081	0,099	0,134	0,162	0,187
H	1	0,1 x D	0,1 x D	160	–	280	fz	0,016	0,031	0,040	0,048	0,064	0,081	0,099	0,134	0,162	0,187
	2	0,1 x D	0,1 x D	140	–	240	fz	0,012	0,024	0,030	0,036	0,048	0,061	0,074	0,101	0,121	0,140
	3	0,1 x D	0,1 x D	120	–	180	fz	0,009	0,019	0,024	0,028	0,038	0,048	0,058	0,079	0,096	0,112
	4	0,1 x D	0,1 x D	100	–	140	fz	0,006	0,012	0,016	0,019	0,025	0,032	0,039	0,053	0,064	0,074

NOTE: Please use the reference table to optimize your cutting speed based on the average cutting angle of the application.



**Vision Plus • Series 7151 Finishing • Application Data • WU10PE • Metric**

Material Group	A		WU10PE Recommended feed per tooth (Fz=mm/th) for 3D milling/profiling (A) - finishing													
	ap	ae	Cutting Speed – vc m/min			mm	D1 - Diameter									
			Min	Max	2,0		3,0	4,0	6,0	8,0	10,0	12,0	16,0	20,0		
	P	3	0,04 x D	0,04 x D	416	–	468	Fz	0,052	0,080	0,108	0,168	0,231	0,279	0,324	0,403
4		0,04 x D	0,04 x D	364	–	416	Fz	0,048	0,073	0,099	0,152	0,207	0,249	0,288	0,355	0,406
H	1	0,03 x D	0,03 x D	290	–	406	Fz	0,052	0,078	0,106	0,162	0,221	0,266	0,308	0,379	0,434
	2	0,03 x D	0,03 x D	203	–	348	Fz	0,039	0,059	0,080	0,122	0,166	0,199	0,230	0,281	0,320
	3	0,02 x D	0,02 x D	216	–	324	Fz	0,033	0,050	0,067	0,102	0,139	0,168	0,196	0,244	0,284
	4	0,02 x D	0,02 x D	180	–	252	Fz	0,022	0,033	0,045	0,068	0,093	0,112	0,130	0,162	0,187

NOTE: Please use the reference table to optimize your cutting speed based on the average cutting angle of the application.

**Vision Plus • Series 70N1 Roughing • Application Data • WU10PE • Metric**

Material Group	A		WU10PE Recommended feed per tooth (Fz=mm/th) for 3D milling/profiling (A) - roughing													
	ap	ae	Cutting Speed – vc m/min			mm	D1 - Diameter									
			Min	Max	2,0		3,0	4,0	6,0	8,0	10,0	12,0	16,0	20,0		
	P	3	0,2 x D	0,1 x D	208	–	234	Fz	0,015	0,023	0,031	0,049	0,067	0,081	0,094	0,117
4		0,2 x D	0,1 x D	182	–	208	Fz	0,014	0,021	0,029	0,044	0,060	0,073	0,084	0,103	0,118
H	1	0,15 x D	0,1 x D	140	–	196	Fz	0,021	0,032	0,043	0,066	0,090	0,109	0,125	0,154	0,177
	2	0,1 x D	0,075 x D	119	–	204	Fz	0,024	0,036	0,048	0,074	0,101	0,121	0,140	0,171	0,194
	3	0,05 x D	0,05 x D	138	–	207	Fz	0,027	0,041	0,055	0,084	0,114	0,138	0,161	0,200	0,233
	4	0,05 x D	0,05 x D	115	–	161	Fz	0,018	0,027	0,037	0,056	0,076	0,092	0,107	0,133	0,154

NOTE: Please use the reference table to optimize your cutting speed based on the average cutting angle of the application.

**Vision Plus • Series 70N1 Semi-Finishing • Application Data • WU10PE • Metric**

Material Group	A		WU10PE Recommended feed per tooth (fz = mm/th) for 3D milling/profiling (A) – semi-finishing														
	ap	ae	Cutting Speed – vc m/min			mm	D1 – Diameter										
			min	max	1,0		2,0	2,5	3,0	4,0	5,0	6,0	8,0	10,0	12,0		
	P	3	0,1 x D	0,1 x D	240	–	320	fz	0,017	0,034	0,043	0,052	0,070	0,089	0,109	0,150	0,182
4		0,1 x D	0,1 x D	180	–	300	fz	0,016	0,031	0,040	0,048	0,064	0,081	0,099	0,134	0,162	0,187
H	1	0,1 x D	0,1 x D	160	–	280	fz	0,016	0,031	0,040	0,048	0,064	0,081	0,099	0,134	0,162	0,187
	2	0,1 x D	0,1 x D	140	–	240	fz	0,012	0,024	0,030	0,036	0,048	0,061	0,074	0,101	0,121	0,140
	3	0,1 x D	0,1 x D	120	–	180	fz	0,009	0,019	0,024	0,028	0,038	0,048	0,058	0,079	0,096	0,112
	4	0,1 x D	0,1 x D	100	–	140	fz	0,006	0,012	0,016	0,019	0,025	0,032	0,039	0,053	0,064	0,074

NOTE: Please use the reference table to optimize your cutting speed based on the average cutting angle of the application.

Vision Plus • Series 70N1 Finishing • Application Data • WU10PE • Metric

Material Group																
	A		WU10PE			Recommended feed per tooth (Fz=mm/th) for 3D milling/profiling (A) - finishing										
			Cutting Speed – vc m/min			D1 - Diameter										
	ap	ae	Min	–	Max	mm	2,0	3,0	4,0	6,0	8,0	10,0	12,0	16,0	20,0	
P	3	0,04 x D	0,04 x D	416	–	468	Fz	0,052	0,080	0,108	0,168	0,231	0,279	0,324	0,403	0,466
	4	0,04 x D	0,04 x D	364	–	416	Fz	0,048	0,073	0,099	0,152	0,207	0,249	0,288	0,355	0,406
H	1	0,03 x D	0,03 x D	290	–	406	Fz	0,052	0,078	0,106	0,162	0,221	0,266	0,308	0,379	0,434
	2	0,03 x D	0,03 x D	203	–	348	Fz	0,039	0,059	0,080	0,122	0,166	0,199	0,230	0,281	0,320
	3	0,02 x D	0,02 x D	216	–	324	Fz	0,033	0,050	0,067	0,102	0,139	0,168	0,196	0,244	0,284
	4	0,02 x D	0,02 x D	180	–	252	Fz	0,022	0,033	0,045	0,068	0,093	0,112	0,130	0,162	0,187

NOTE: Please use the reference table to optimize your cutting speed based on the average cutting angle of the application.

INDEXABLE MILLING

SOLID END MILLING

HOLE/MAKING

TAPPING

TURNING

## Vision Plus • Series 7N02 7N12 7N22 • Application Data • WU10PE • Metric

INDEXABLE MILLING

SOLID END MILLING

HOLEMAKING

TAPPING

TURNING

Material Group	Side Milling (A) and Slotting (B)		WU10PE			Recommended feed per tooth (fz = mm/th) for side milling (A). For slotting (B), reduce fz by 20%.												
	A		B		Cutting Speed – vc m/min			D1 – Diameter										
	ap	ae	ap	min	max	mm	0,3	0,4	0,5	0,6	0,8	1,0	1,5	2,0	2,5	3,0		
	ap	ae	ap	min	max	mm	0,3	0,4	0,5	0,6	0,8	1,0	1,5	2,0	2,5	3,0		
P	0	1,25 x D	0,25 x D	0,75 x D	150	–	200	fz	0,002	0,003	0,003	0,004	0,005	0,007	0,010	0,014	0,017	0,021
	1	1,25 x D	0,25 x D	0,75 x D	150	–	200	fz	0,002	0,003	0,003	0,004	0,005	0,007	0,010	0,014	0,017	0,021
	2	1,25 x D	0,25 x D	0,75 x D	140	–	190	fz	0,002	0,003	0,003	0,004	0,005	0,007	0,010	0,014	0,017	0,021
	3	1,25 x D	0,25 x D	0,75 x D	120	–	160	fz	0,002	0,002	0,003	0,003	0,004	0,006	0,008	0,011	0,014	0,017
	4	1,25 x D	0,25 x D	0,5 x D	90	–	150	fz	0,002	0,002	0,003	0,003	0,004	0,005	0,008	0,010	0,013	0,016
K	1	1,25 x D	0,25 x D	0,75 x D	60	–	100	fz	0,001	0,002	0,002	0,003	0,004	0,005	0,007	0,009	0,012	0,014
	2	1,25 x D	0,25 x D	0,5 x D	120	–	150	fz	0,002	0,003	0,003	0,004	0,005	0,007	0,010	0,014	0,017	0,021
H	1	1,25 x D	0,25 x D	0,5 x D	80	–	140	fz	0,002	0,002	0,003	0,003	0,004	0,005	0,008	0,010	0,013	0,016
	2	1,25 x D	0,25 x D	0,3 x D	70	–	120	fz	0,001	0,002	0,002	0,002	0,003	0,004	0,006	0,008	0,010	0,012
	3	1,25 x D	0,25 x D	0,25 x D	60	–	90	fz	0,001	0,001	0,002	0,002	0,002	0,003	0,005	0,006	0,008	0,009

Material Group	Side Milling (A) and Slotting (B)		WU10PE			Recommended feed per tooth (IPT = inch/th) for side milling (A). For slotting (B), reduce IPT by 20%.												
	A		B		Cutting Speed – vc SFM			D1 – Diameter										
	ap	ae	ap	min	max	mm	0,3	0,4	0,5	0,6	0,8	1,0	1,5	2,0	2,5	3,0		
	ap	ae	ap	min	max	mm	0,3	0,4	0,5	0,6	0,8	1,0	1,5	2,0	2,5	3,0		
P	0	1.25 x D	0.25 x D	0.75 x D	492	–	656	IPT	.0001	.0001	.0001	.0002	.0002	.0003	.0004	.0005	.0007	.0008
	1	1.25 x D	0.25 x D	0.75 x D	492	–	656	IPT	.0001	.0001	.0001	.0002	.0002	.0003	.0004	.0005	.0007	.0008
	2	1.25 x D	0.25 x D	0.75 x D	459	–	623	IPT	.0001	.0001	.0001	.0002	.0002	.0003	.0004	.0005	.0007	.0008
	3	1.25 x D	0.25 x D	0.75 x D	394	–	525	IPT	.0001	.0001	.0001	.0001	.0002	.0002	.0003	.0004	.0006	.0007
	4	1.25 x D	0.25 x D	0.5 x D	295	–	492	IPT	.0001	.0001	.0001	.0001	.0002	.0002	.0003	.0004	.0005	.0006
K	1	1.25 x D	0.25 x D	0.75 x D	197	–	328	IPT	.0001	.0001	.0001	.0001	.0001	.0002	.0003	.0004	.0005	.0006
	2	1.25 x D	0.25 x D	0.5 x D	394	–	492	IPT	.0001	.0001	.0001	.0002	.0002	.0003	.0004	.0005	.0007	.0008
H	1	1.25 x D	0.25 x D	0.5 x D	361	–	459	IPT	.0001	.0001	.0001	.0001	.0002	.0002	.0003	.0004	.0006	.0007
	1	1.25 x D	0.25 x D	0.5 x D	262	–	459	IPT	.0001	.0001	.0001	.0001	.0002	.0002	.0003	.0004	.0005	.0006
	2	1.25 x D	0.25 x D	0.3 x D	230	–	394	IPT	.0000	.0001	.0001	.0001	.0001	.0002	.0002	.0003	.0004	.0005
3	1.25 x D	0.25 x D	0.25 x D	197	–	295	IPT	.0000	.0000	.0001	.0001	.0001	.0002	.0002	.0003	.0003	.0004	

NOTE: Lower value of cutting speed is used for high stock removal applications or for higher hardness (machinability) within group.  
Higher value of cutting speed is used for finishing applications or for lower hardness (machinability) within group.  
For tools with reach > 3 x D, reduce fz by 20%.  
For tools with reach > 5 x D, reduce fz by 30%.

Vision Plus • Series 7N01 • Application Data • WU10PE • Metric

Material Group	Profile Milling		WU10PE			Recommended feed per tooth (fz = mm/th) for 3D milling/profiling (A) – finishing									
	A		Cutting Speed – vc m/min			mm	D1 – Diameter								
	ap	ae	min	max	0,5		0,6	0,8	1,0	1,5	2,0	2,5	3,0		
	P	3	0,04 x D	0,04 x D	432	–	576	fz	0,012	0,015	0,020	0,025	0,038	0,051	0,064
4		0,04 x D	0,04 x D	324	–	540	fz	0,012	0,014	0,019	0,023	0,035	0,047	0,059	0,072
H	1	0,03 x D	0,03 x D	288	–	504	fz	0,012	0,014	0,019	0,023	0,035	0,047	0,059	0,072
	2	0,03 x D	0,03 x D	252	–	432	fz	0,009	0,011	0,014	0,018	0,027	0,036	0,045	0,054
	3	0,02 x D	0,02 x D	216	–	324	fz	0,007	0,008	0,011	0,014	0,021	0,028	0,035	0,043
	4	0,02 x D	0,02 x D	180	–	252	fz	0,005	0,006	0,007	0,009	0,014	0,019	0,024	0,028

Material Group	Profile Milling		WU10PE			Recommended feed per tooth (fz = mm/th) for 3D milling/profiling (A) – semi-finishing									
	A		Cutting Speed – vc m/min			mm	D1 – Diameter								
	ap	ae	min	max	0,5		0,6	0,8	1,0	1,5	2,0	2,5	3,0		
	P	3	0,1 x D	0,05 x D	300	–	400	fz	0,008	0,010	0,013	0,017	0,025	0,034	0,043
4		0,1 x D	0,05 x D	225	–	375	fz	0,008	0,009	0,012	0,016	0,023	0,031	0,040	0,048
H	1	0,07 x D	0,1 x D	200	–	350	fz	0,008	0,009	0,012	0,016	0,023	0,031	0,040	0,048
	2	0,05 x D	0,04 x D	175	–	300	fz	0,006	0,007	0,009	0,012	0,018	0,024	0,030	0,036
	3	0,03 x D	0,03 x D	150	–	225	fz	0,005	0,006	0,007	0,009	0,014	0,019	0,024	0,028
	4	0,03 x D	0,03 x D	125	–	175	fz	0,003	0,004	0,005	0,006	0,009	0,012	0,016	0,019

Material Group	Profile Milling		WU10PE			Recommended feed per tooth (fz = mm/th) for 3D milling/profiling (A) – roughing									
	A		Cutting Speed – vc m/min			mm	D1 – Diameter								
	ap	ae	min	max	0,5		0,6	0,8	1,0	1,5	2,0	2,5	3,0		
	P	3	0,2 x D	0,1 x D	216	–	288	fz	0,004	0,005	0,007	0,008	0,013	0,017	0,021
4		0,2 x D	0,1 x D	162	–	270	fz	0,004	0,005	0,006	0,008	0,012	0,016	0,020	0,024
H	1	0,15 x D	0,1 x D	144	–	252	fz	0,004	0,005	0,006	0,008	0,012	0,016	0,020	0,024
	2	0,1 x D	0,075 x D	126	–	216	fz	0,003	0,004	0,005	0,006	0,009	0,012	0,015	0,018
	3	0,05 x D	0,05 x D	108	–	162	fz	0,002	0,003	0,004	0,005	0,007	0,009	0,012	0,014
	4	0,05 x D	0,05 x D	90	–	126	fz	0,002	0,002	0,002	0,003	0,005	0,006	0,008	0,009

NOTE: Please use reference table for correction of vc based on averages degree of the mold.

## Vision Plus • Series 7N21 Roughing • Application Data • WU10PE • Metric

Material Group	A		WU10PE Recommended feed per tooth (Fz=mm/th) for 3D milling/profiling (A) - roughing												
			Cutting Speed – vc m/min			D1 - Diameter									
	ap	ae	Min	Max	mm	0,5	0,6	0,8	1,0	1,5	2,0	2,5	3,0		
						Fz	Fz	Fz	Fz	Fz	Fz	Fz	Fz	Fz	
P	3	0,2 x D	0,1 x D	208	–	234	Fz	0,0037	0,0044	0,0059	0,0075	0,0113	0,0152	0,0192	0,0232
	4	0,2 x D	0,1 x D	182	–	208	Fz	0,0035	0,0042	0,0056	0,0070	0,0105	0,0141	0,0177	0,0213
H	1	0,15 x D	0,1 x D	140	–	196	Fz	0,0052	0,0062	0,0083	0,0104	0,0157	0,0211	0,0265	0,0319
	2	0,1 x D	0,075 x D	119	–	204	Fz	0,0059	0,0070	0,0094	0,0118	0,0178	0,0238	0,0299	0,0360
	3	0,05 x D	0,05 x D	138	–	207	Fz	0,0066	0,0080	0,0106	0,0133	0,0201	0,0269	0,0338	0,0408
	4	0,05 x D	0,05 x D	115	–	161	Fz	0,0044	0,0053	0,0071	0,0089	0,0134	0,0179	0,0226	0,0272

NOTE: Please use the reference table to optimize your cutting speed based on the average cutting angle of the application.

INDEXABLE MILLING

SOLID END MILLING

HOLEMAKING

TAPPING

TURNING

Vision Plus • Series 7N21 Semi-Finishing • Application Data • WU10PE • Metric

Material Group	Profile Milling		WU10PE			Recommended feed per tooth (fz = mm/th) for 3D milling/profiling (A) – finishing									
	A		Cutting Speed – vc m/min			mm	D1 – Diameter								
	ap	ae	min	max	0,5		0,6	0,8	1,0	1,5	2,0	2,5	3,0		
P	3	0,04 x D	0,04 x D	432	–	576	fz	0,012	0,015	0,020	0,025	0,038	0,051	0,064	0,078
	4	0,04 x D	0,04 x D	324	–	540	fz	0,012	0,014	0,019	0,023	0,035	0,047	0,059	0,072
H	1	0,03 x D	0,03 x D	288	–	504	fz	0,012	0,014	0,019	0,023	0,035	0,047	0,059	0,072
	2	0,03 x D	0,03 x D	252	–	432	fz	0,009	0,011	0,014	0,018	0,027	0,036	0,045	0,054
	3	0,02 x D	0,02 x D	216	–	324	fz	0,007	0,008	0,011	0,014	0,021	0,028	0,035	0,043
	4	0,02 x D	0,02 x D	180	–	252	fz	0,005	0,006	0,007	0,009	0,014	0,019	0,024	0,028

Material Group	Profile Milling		WU10PE			Recommended feed per tooth (fz = mm/th) for 3D milling/profiling (A) – semi-finishing									
	A		Cutting Speed – vc m/min			mm	D1 – Diameter								
	ap	ae	min	max	0,5		0,6	0,8	1,0	1,5	2,0	2,5	3,0		
P	3	0,1 x D	0,05 x D	300	–	400	fz	0,008	0,010	0,013	0,017	0,025	0,034	0,043	0,052
	4	0,1 x D	0,05 x D	225	–	375	fz	0,008	0,009	0,012	0,016	0,023	0,031	0,040	0,048
H	1	0,07 x D	0,1 x D	200	–	350	fz	0,008	0,009	0,012	0,016	0,023	0,031	0,040	0,048
	2	0,05 x D	0,1 x D	175	–	300	fz	0,006	0,007	0,009	0,012	0,018	0,024	0,030	0,036
	3	0,03 x D	0,03 x D	150	–	225	fz	0,005	0,006	0,007	0,009	0,014	0,019	0,024	0,028
	4	0,03 x D	0,03 x D	125	–	175	fz	0,003	0,004	0,005	0,006	0,009	0,012	0,016	0,019

Material Group	Profile Milling		WU10PE			Recommended feed per tooth (fz = mm/th) for 3D milling/profiling (A) – roughing									
	A		Cutting Speed – vc m/min			mm	D1 – Diameter								
	ap	ae	min	max	0,5		0,6	0,8	1,0	1,5	2,0	2,5	3,0		
P	3	0,2 x D	0,1 x D	216	–	288	fz	0,004	0,005	0,007	0,008	0,013	0,017	0,021	0,026
	4	0,2 x D	0,1 x D	162	–	270	fz	0,004	0,005	0,006	0,008	0,012	0,016	0,020	0,024
H	1	0,15 x D	0,1 x D	144	–	252	fz	0,004	0,005	0,006	0,008	0,012	0,016	0,020	0,024
	2	0,1 x D	0,075 x D	126	–	216	fz	0,003	0,004	0,005	0,006	0,009	0,012	0,015	0,018
	3	0,05 x D	0,05 x D	108	–	162	fz	0,002	0,003	0,004	0,005	0,007	0,009	0,012	0,014
	4	0,05 x D	0,05 x D	90	–	126	fz	0,002	0,002	0,002	0,003	0,005	0,006	0,008	0,009

NOTE: Please use reference table for correction of vc based on averages degree of the mold.

## Vision Plus • Series 7N21 Finishing • Application Data • WU10PE • Metric



INDEXABLE MILLING

SOLID END MILLING

HOLE/MAKING

TAPPING

TURNING

															
		A		WU10PE			Recommended feed per tooth (Fz=mm/th) for 3D milling/profiling (A) - finishing								
Material Group				Cutting Speed – vc m/min			D1 - Diameter								
		ap	ae	Min		Max	mm	0,5	0,6	0,8	1,0	1,5	2,0	2,5	3,0
P	3	0,04 x D	0,04 x D	416	–	468	Fz	0,0127	0,0153	0,0204	0,0256	0,0389	0,0522	0,0659	0,0796
	4	0,04 x D	0,04 x D	364	–	416	Fz	0,0119	0,0143	0,0191	0,0239	0,0361	0,0484	0,0609	0,0734
H	1	0,03 x D	0,03 x D	290	–	406	Fz	0,0127	0,0153	0,0204	0,0255	0,0386	0,0517	0,0650	0,0784
	2	0,03 x D	0,03 x D	203	–	348	Fz	0,0096	0,0116	0,0154	0,0193	0,0292	0,0391	0,0491	0,0592
	3	0,02 x D	0,02 x D	216	–	324	Fz	0,0081	0,0097	0,0130	0,0163	0,0245	0,0328	0,0413	0,0497
	4	0,02 x D	0,02 x D	180	–	252	Fz	0,0054	0,0065	0,0087	0,0108	0,0164	0,0219	0,0275	0,0331

Please use the reference table to optimize your cutting speed based on the average cutting angle of the application.





# HSS End Mills

## High-Performance Solid End Milling

The next generation of premium cobalt HSS roughers are designed specifically for titanium and stainless steels. They are engineered with an eccentric relief (ER) grind to provide a stronger cutting edge that requires less torque to operate. The unique proprietary chipbreaker geometry will break and control the chip, enabling higher metal removal rates and greater productivity. The HSS rougher offers the best-in-class performance for difficult-to-machine workpiece materials.

### Features and Benefits

**High cobalt and vanadium content PM HSS** providing superior wear resistance and red hardness.

**Different edge preparations and geometries** to machine a wide range of materials.

**Center cutting offering** excellent performance in roughing applications, especially in titanium.



WavCut™ tools for machining titanium are best suited for applications in aerospace and energy, providing high metal removal rates (MRR) and increased tool life. The special wave design of these 4- and 6-fluted end mills requires less horsepower during roughing and semi-finishing, and provides excellent chip formation. Since chips evacuate easily, WavCut tools do not recut chips, thus increasing tool life. Also, the edges change the radial cutting edge position without changing the diameter.

## HIGH

## **SOPHISTICATED PERFORMANCE**

Sophisticated roughing profiles capable of dealing with chip formation issues.

High-performance finishers with specific geometries for different workpiece materials.

## **EFFICIENT**

Increase stock removal rates over regular roughing tools due to reduced horsepower consumption.

# HIGH SPEED STEEL

## PRODUCT

SOLID CARBIDE END MILL

GRADE

UNCOATED  
TiCN

FLUTE

4-8

DIAMETER RANGE

INCH

1/2-2"

METRIC

6-50mm

## INDUSTRY



GENERAL  
ENGINEERING



AEROSPACE



ENERGY



TRANSPORTATION

## APPLICATIONS

MATERIALS

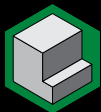

SIDE MILLING



RAMPING



HELICAL  
INTERPOLATION



SLOTING



DYNAMIC  
MILLING



PLUNGING

## HSS Roughers • Series 6AOR • Chamfer • Weldon® • Inch

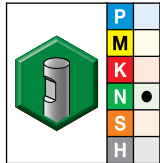
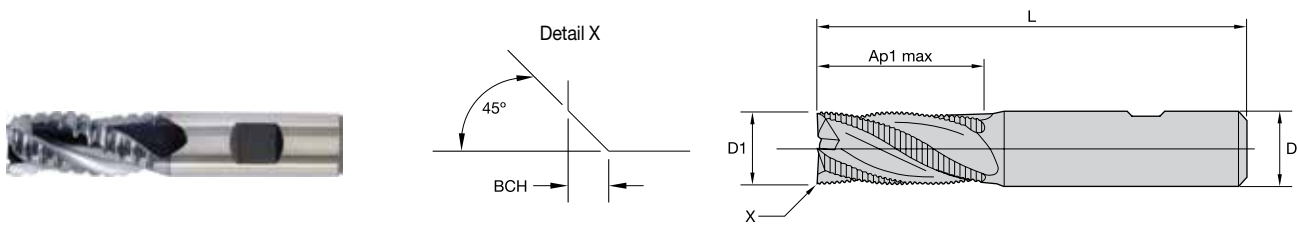

- first choice
- alternate choice

TiCN

order #	catalog #	D1	D	length of cut Ap1 max	length L	BCH	ZU
2840160	TC6A0R13005	1/2	1/2	1 1/4	3 1/4	.014	3
2840121	TC6A1R13005	1/2	1/2	2	4	.014	3
2840146	TC6A0R19007	3/4	3/4	1 5/8	3 7/8	.014	3
2840087	TC6A3R19007	3/4	3/4	2 1/4	4 1/2	.014	3
2840108	TC6A1R19007	3/4	3/4	3	5 1/4	.014	3
2840138	TC6A0R25008	1	1	2	4 1/2	.020	3
1839782	TC6A3R25008	1	1	3	5 1/2	.020	3
2840103	TC6A1R25008	1	1	4	6 1/2	.020	3
2840132	TC6A0R32009	1 1/4	1 1/4	2	4 1/2	.020	3
2840073	TC6A3R32009	1 1/4	1 1/4	3	5 1/2	.020	3
2840099	TC6A1R32009	1 1/4	1 1/4	4	6 1/2	.020	3

NOTE: For application data, please see page B364.

## HSS Roughers • Series 6TOR • Chamfer • Weldon® • Inch

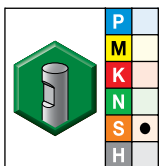
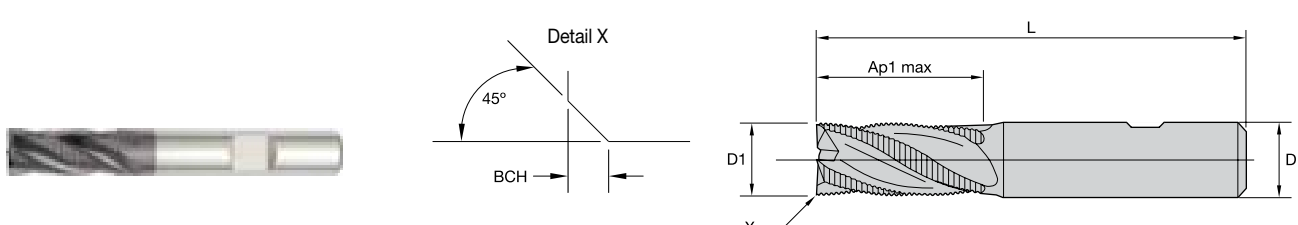

- first choice
- alternate choice

TiAlN

order #	catalog #	D1	D	length of cut Ap1 max	length L	BCH	ZU
2836219	TF6TOR13005	1/2	1/2	1 1/4	3 1/4	.035	4
2836188	TF6T1R13005	1/2	1/2	2	4	.035	4
2836212	TF6TOR16006	5/8	5/8	1 5/8	3 3/4	.047	4
2836206	TF6TOR19007	3/4	3/4	1 5/8	3 7/8	.047	4
2836151	TF6T3R19007	3/4	3/4	2 1/4	4 1/2	.047	4
2836176	TF6T1R19007	3/4	3/4	3	5 1/4	.047	4
2836204	TF6TOR25008	1	1	2	4 1/2	.059	5
2836145	TF6T3R25008	1	1	3	5 1/2	.059	5
2836169	TF6T1R25008	1	1	4	6 1/2	.059	5
2836199	TF6TOR32009	1 1/4	1 1/4	2	4 1/2	.059	6
2836138	TF6T3R32009	1 1/4	1 1/4	3	5 1/2	.059	6
2836163	TF6T1R32009	1 1/4	1 1/4	4	6 1/2	.059	6
2836193	TF6TOR38009	1 1/2	1 1/4	2	4 1/2	.059	6
2836132	TF6T3R38009	1 1/2	1 1/4	3	5 1/2	.059	6

NOTE: For application data, please see page B364.

HSS Roughers • Series 6ANR • Chamfer • Neck • Weldon® • Inch

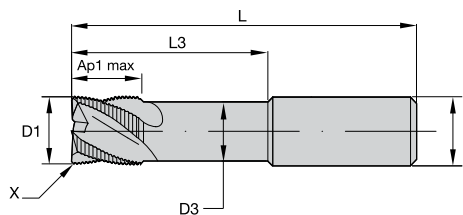
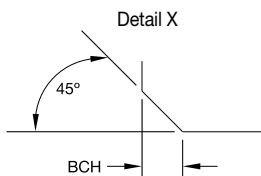
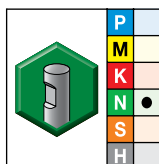

- first choice
- alternate choice

TiCN		D1	D	D3	length of cut Ap1 max	L3	length L	BCH	ZU
2840040	TC6ANR13005	1/2	1/2	.470	1 1/4	2	4	.014	3
2840034	TC6ANR13015	1/2	1/2	.470	1 1/4	3	5	.014	3
2840007	TC6ANR19007	3/4	3/4	.705	1 5/8	4	6 1/4	.014	3
2840000	TC6ANR19017	3/4	3/4	.705	1 5/8	6	8 1/4	.014	3
2839994	TC6ANR25008	1	1	.940	2	4	6 1/2	.020	3
1907409	TC6ANR25018	1	1	.940	2	6	8 1/2	.020	3

NOTE: For application data, please see page B364.

HSS Roughers • Series 6TNR • Chamfer • Neck • Weldon® • Inch

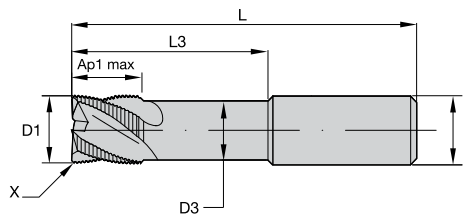
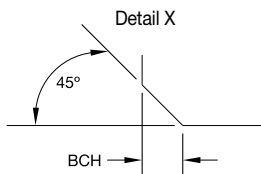
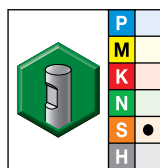

- first choice
- alternate choice

TiAlN		D1	D	D3	length of cut Ap1 max	L3	length L	BCH	ZU
2836087	TF6TNR16016	5/8	5/8	.588	1 5/8	4	6 1/8	.047	4
2836081	TF6TNR19007	3/4	3/4	.705	1 5/8	4	6 1/4	.047	4
2836075	TF6TNR19017	3/4	3/4	.705	1 5/8	6	8 1/4	.047	4
2836068	TF6TNR25008	1	1	.940	2	4	6 1/2	.059	5
2836063	TF6TNR25018	1	1	.940	2	6	8 1/2	.059	5
2836059	TF6TNR32009	1 1/4	1 1/4	1.175	2	4	6 1/2	.059	6
2836054	TF6TNR32019	1 1/4	1 1/4	1.175	2	6	8 1/2	.059	6

NOTE: For application data, please see page B365.

## HSS ER Roughers • Series 620E • Radius • Whistle Notch • Weldon® NAS 986 • Inch

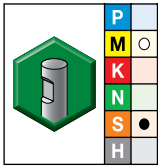
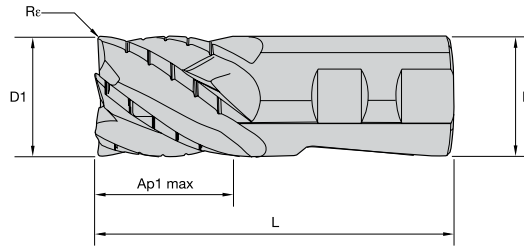

- first choice
- alternate choice

UNCOATED

order #	catalog #	D1	D	length of cut Ap1 max	length L	Re	ZU
5329387	620E32009CW	1 1/4	1 1/4	2	4 1/2	.060	6
5599913	620E32009EW	1 1/4	1 1/4	2	4 1/2	.120	6
5329388	623E32009CW	1 1/4	1 1/4	3	5 1/2	.060	6
5599914	623E32009EW	1 1/4	1 1/4	3	5 1/2	.120	6
5599915	621E32009EW	1 1/4	1 1/4	4	6 1/2	.120	6
5329554	623E3800ACW	1 1/2	1 1/2	3	6 1/4	.060	6
5329555	621E3800ACW	1 1/2	1 1/2	4	7 1/4	.060	6
5329556	625E51022CW	2	2	2	5 3/4	.060	6
5599972	625E51022EW	2	2	2	5 3/4	.120	6
5329557	625E51032CW	2	2	3	6 3/4	.060	6
5599973	625E51032EW	2	2	3	6 3/4	.120	6
5329558	625E51042CW	2	2	4	7 3/4	.060	6
5599974	625E51042EW	2	2	4	7 3/4	.120	6
5329559	625E51062CW	2	2	6	9 3/4	.060	6
5599975	625E51062EW	2	2	6	9 3/4	.120	6

NOTE: For application data, please see page B366.

INDEXABLE MILLING

SOLID END MILLING

HOLEMAKING

TAPPING

TURNING

WavCut I • Series 620W • Chamfer • Weldon® • Inch

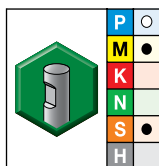
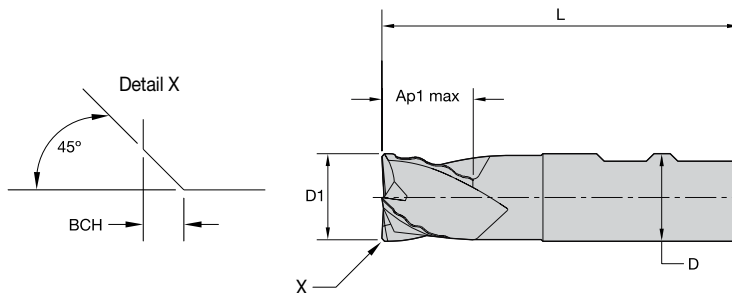

● first choice  
○ alternate choice

UNCOATED

order #	catalog #	D1	D	length of cut Ap1 max	length L	BCH	ZU
2709800	620W19077	3/4	3/4	1 5/8	3 7/8	.039	4
2709779	620W25078	1	1	2	4 1/2	.039	4
2709772	620W25088	1	1	2	4 1/2	.039	6
2709389	623W25078	1	1	3	5 1/2	.039	4
3032729	623W25088	1	1	3	5 1/2	.039	6
2709606	621W25088	1	1	4	6 1/2	.039	6
2709613	621W25078	1	1	4	6 1/2	.039	4
2709747	620W32089	1 1/4	1 1/4	2	4 1/2	.039	6
2709375	623W32089	1 1/4	1 1/4	3	5 1/2	.039	6
2709583	621W32089	1 1/4	1 1/4	4	6 1/2	.039	6
2709487	622W32089	1 1/4	1 1/4	6	8 1/2	.039	6
2709562	621W38089	1 1/2	1 1/4	4	6 1/2	.039	6
2709233	625W51722	2	2	2	5 3/4	.039	6
2709219	625W51732	2	2	3	6 3/4	.039	6
2709206	625W51742	2	2	4	7 3/4	.039	6
2709200	625W51762	2	2	6	9 3/4	.039	6
2709191	625W51782	2	2	8	11 3/4	.039	6

NOTE: For application data, please see page B367.

INDEXABLE MILLING

SOLID END MILLING

HOLEMAKING

TAPPING

TURNING

## WavCut II • Series 620V • Weldon® • Inch

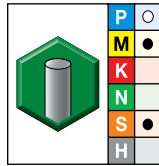
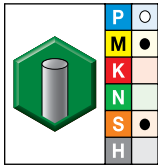
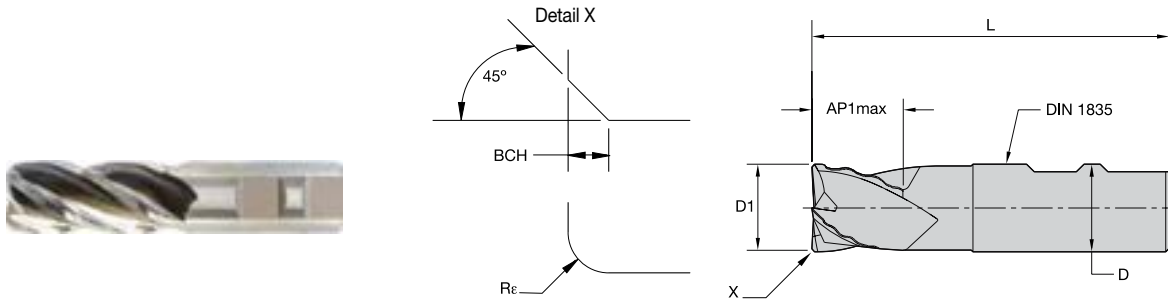

- first choice
- alternate choice

UNCOATED		TiAlN		D1	D	length of cut Ap1 max	length L	Re	BCH	Z U
order #	catalog #	order #	catalog #							
—	—	2686847	TF620V19077	3/4	3/4	1 5/8	3 7/8	—	.039	4
2709865	620V25088	—	—	1	1	2	4 1/2	—	.039	6
3887310	620V25288	—	—	1	1	2	4 1/2	.060	—	6
2709872	620V25078	—	—	1	1	2	4 1/2	—	.039	4
3887449	621V25288	—	—	1	1	4	6 1/2	.060	—	6
2709837	620V32089	—	—	1 1/4	1 1/4	2	4 1/2	—	.039	6
2709844	620V32079	—	—	1 1/4	1 1/4	2	4 1/2	—	.039	4
3185195	623V32079	—	—	1 1/4	1 1/4	3	5 1/2	—	.039	4
2709428	623V32089	—	—	1 1/4	1 1/4	3	5 1/2	—	.039	6
2709662	621V32089	—	—	1 1/4	1 1/4	4	6 1/2	—	.039	6
2709669	621V32079	—	—	1 1/4	1 1/4	4	6 1/2	—	.039	4
3887452	622V32289	—	—	1 1/4	1 1/4	6	8 1/2	.060	—	6
3887451	621V38289	—	—	1 1/2	1 1/4	4	6 1/2	.060	—	6
2709641	621V38089	—	—	1 1/2	1 1/4	4	6 1/2	—	.039	6
3887453	622V38289	—	—	1 1/2	1 1/4	6	8 1/2	.060	—	6
3887457	625V51232	—	—	2	2	3	6 3/4	.060	—	6
3887458	625V51242	—	—	2	2	4	7 3/4	.060	—	6
3887460	625V51282	—	—	2	2	8	11 3/4	.060	—	6

NOTE: For application data, please see page B368.

HSS Roughers • List 6N06 • Chamfer • Weldon® • Metric

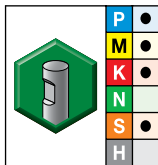
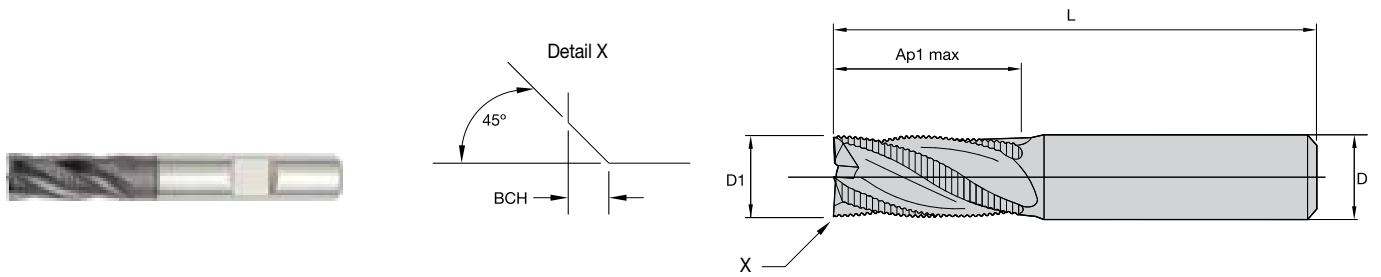

- first choice
- alternate choice

TiAlN-LW

order #	catalog #	D1	D	length of cut Ap1 max	length L	BCH	ZU
1660373	6N0606002LW	6,0	6	13,00	57	0,25	4
1660389	6N0608004LW	8,0	10	19,00	69	0,25	4
1660397	6N0609004LW	9,0	10	19,00	69	0,25	4
1660405	6N0610004LW	10,0	10	22,00	72	0,25	4
1660421	6N0612005LW	12,0	12	26,00	83	0,35	4
1660437	6N0614005LW	14,0	12	26,00	83	0,35	4
1660453	6N0616006LW	16,0	16	32,00	92	0,35	4
1660479	6N0620007LW	20,0	20	38,00	104	0,35	4
1660487	6N0622007LW	22,0	20	38,00	104	0,50	5
1660497	6N0625008LW	25,0	25	45,00	121	0,50	5
1660507	6N0630008LW	30,0	25	45,00	121	0,50	5

NOTE: For application data, please see page B369.

HSS Roughers • List 6NL6 • Chamfer • Neck • Weldon • Metric

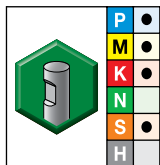
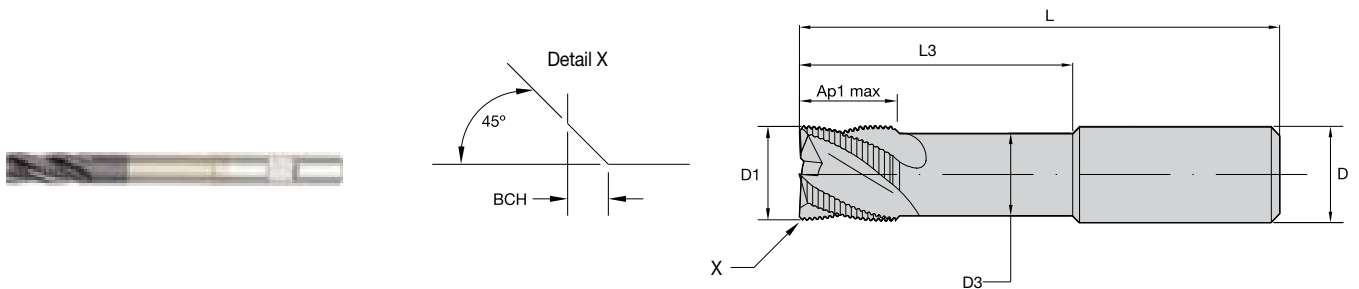

- first choice
- alternate choice

TiAlN-LW

order #	catalog #	D1	D	D3	length of cut Ap1 max	L3	length L	BCH	ZU
1660623	6NL612005LW	12,0	12	12	26,00	78,00	125	0,35	4
1660629	6NL616006LW	16,0	16	15	32,00	87,00	138	0,35	4
1660635	6NL620007LW	20,0	20	20	38,00	108,00	160	0,35	4
1660640	6NL625008LW	25,0	25	25	45,00	155,00	216	0,50	5

NOTE: For application data, please see page B369.



## WavCut I • List 664W • Chamfer • Weldon® • Metric

INDEXABLE MILLING

SOLID END MILLING

HOLEMAKING

TAPPING

TURNING

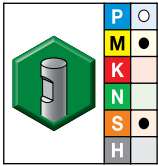
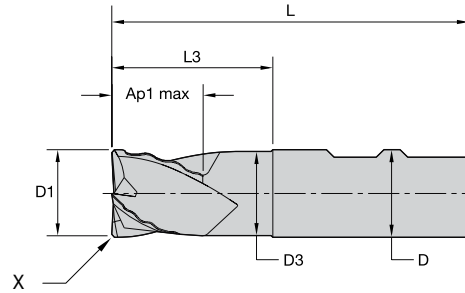
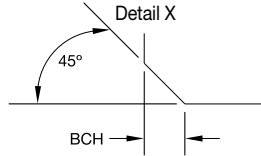

- first choice
- alternate choice

UNCOATED-WW

order #	catalog #	D1	D	D3	length of cut Ap1 max	L3	length L	BCH	ZU
3871691	664W25008WW	25,0	25	23	26,00	46,00	102	1,00	5
3871692	660W25008WW	25,0	25	23	45,00	65,00	121	1,00	5
3871833	661W25008WW	25,0	25	23	90,00	110,00	166	1,00	6
3871835	660W32009WW	32,0	32	30	53,00	73,00	133	1,00	6
3871836	661W32009WW	32,0	32	30	100,00	110,00	170	1,00	6
3871837	664W40009WW	40,0	32	—	38,00	58,00	118	1,00	6
3871839	661W40009WW	40,0	32	—	100,00	110,00	170	1,00	6
3871840	664W50000WW	50,0	50	47	40,00	60,00	140	1,00	6
3871841	660W50000WW	50,0	50	47	75,00	95,00	175	1,00	6
3871842	661W50000WW	50,0	50	47	110,00	130,00	210	1,00	8

NOTE: For application data, please see page B370.

HSS Finishers • Series 3405 • Sharp Edge • Weldon® • Inch

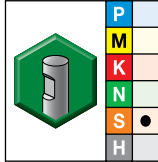
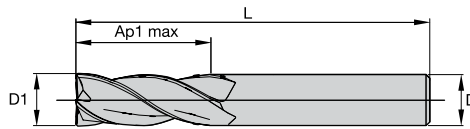

UNCOATED

- first choice
- alternate choice

order #	catalog #	D1	D	length of cut Ap1 max	length L	ZU
2866063	341513005	1/2	1/2	2	4	4
2865982	343725008	1	1	3	5 1/2	6
2866036	341725008	1	1	4	6 1/2	6
2866051	341525008	1	1	4	6 1/2	4
2866006	342725008	1	1	6	8 1/2	6
2865978	343732009	1 1/4	1 1/4	3	5 1/2	6
2866033	341732009	1 1/4	1 1/4	4	6 1/2	6
2866003	342732009	1 1/4	1 1/4	6	8 1/2	6
2865999	342738009	1 1/2	1 1/4	6	8 1/2	6
2865960	345751020	2	2	2	5 3/4	6
2865955	345751040	2	2	4	7 3/4	6
2865951	345751060	2	2	6	9 3/4	6

NOTE: For application data, please see page B370.

INDEXABLE MILLING

SOLID END MILLING

HOLE/MAKING

TAPPING

TURNING

## HSS Roughers • Series 6AOR • Application Data • TiCN • Inch

Material Group	Side Milling (A) and Slotting (B)		Uncoated			TiCN			Recommended feed per tooth (IPT = inch/th) for side milling (A). For slotting (B), reduce IPT by 20%.						
	A		B		Cutting Speed – vc SFM			Cutting Speed – vc SFM			D1 – Diameter				
	ap	ae	ap	ap	min	–	max	min	–	max	frac. dec.	1/2	3/4	1	1 1/4
	N	1	1.25 x D	0.5 x D	1 x D	1050	–	1750	1500	–	2500	IPT	.0055	.0075	.0085
2		1.25 x D	0.5 x D	1 x D	840	–	1400	1200	–	2000	IPT	.0050	.0068	.0077	.0090

NOTE: Side milling applications – For longest length tools, reduce ae by 30%.  
 Slot milling applications – For longest length tools, reduce ap by 30%.  
 Lower value of cutting speed is used for high stock removal applications or for higher hardness (machinability) within group.  
 Higher value of cutting speed is used for finishing applications or for lower hardness (machinability) within group.  
 Above parameters are based on ideal conditions. For smaller taper machining centers, please adjust parameters accordingly on diameters >1/2".

## HSS Roughers • Series 6TOR • Application Data • TiAlN • Inch

Material Group	Side Milling (A) and Slotting (B)		TiAlN			Recommended feed per tooth (IPT = inch/th) for side milling (A). For slotting (B), reduce IPT by 20%.								
	A		B		Cutting Speed – vc SFM			D1 – Diameter						
	ap	ae	ap	ap	min	–	max	frac. dec.	1/2	5/8	3/4	1	1 1/4	1 1/2
	S	3	1.25 x D	0.5 x D	1 x D	50	–	90	IPT	.0028	.0033	.0036	.0040	.0050
4		1.25 x D	0.3 x D	0.5 x D	50	–	90	IPT	.0026	.0030	.0033	.0036	.0045	.0055



NOTE: Side milling applications – For longest length tools, reduce ae by 30%.  
 Slot milling applications – For longest length tools, reduce ap by 30%.  
 Lower value of cutting speed is used for high stock removal applications or for higher hardness (machinability) within group.  
 Higher value of cutting speed is used for finishing applications or for lower hardness (machinability) within group.  
 Above parameters are based on ideal conditions. For smaller taper machining centers, please adjust parameters accordingly on diameters >1/2".

## HSS Roughers • Series 6ANR • Application Data • TiCN • Inch

Material Group	Side Milling (A) and Slotting (B)		TiCN			Recommended feed per tooth (IPT = inch/th) for side milling (A). For slotting (B), reduce IPT by 20%.						
	A		B		Cutting Speed – vc SFM			D1 – Diameter				
	ap	ae	ap	ap	min	–	max	frac. dec.	1/2	3/4	1	1 1/4
	N	1	1 x D	0.3 x D	0.75 x D	1500	–	2500	IPT	.0055	.0075	.0085
2		1 x D	0.3 x D	0.5 x D	1200	–	2000	IPT	.0050	.0068	.0077	.0090

NOTE: Side milling applications – For longest length tools, reduce ae by 30%.  
 Slot milling applications – For longest length tools, reduce ap by 30%.  
 Lower value of cutting speed is used for high stock removal applications or for higher hardness (machinability) within group.  
 Higher value of cutting speed is used for finishing applications or for lower hardness (machinability) within group.  
 Above parameters are based on ideal conditions. For smaller taper machining centers, please adjust parameters accordingly on diameters >1/2".

HSS Roughers • Series 6TNR • Application Data • TiAlN • Inch

<b>Material Group</b>												
	<b>Side Milling (A) and Slotting (B)</b>					<b>TiAlN</b>			<b>Recommended feed per tooth (IPT = inch/th) for side milling (A). For slotting (B), reduce IPT by 20%.</b>			
	<b>A</b>		<b>B</b>			<b>Cutting Speed – vc SFM</b>			<b>D1 – Diameter</b>			
	<b>ap</b>	<b>ae</b>	<b>ap</b>	<b>min</b>	<b>max</b>	<b>frac.</b>	<b>5/8</b>	<b>3/4</b>	<b>1</b>	<b>1 1/4</b>		
<b>3</b>	0.75 x D	0.4 x D	0.5 x D	50	–	90	<b>dec.</b>	.6250	.7500	1.0000	1.2500	
<b>4</b>	0.75 x D	0.3 x D	0.3 x D	50	–	90	<b>IPT</b>	.0033	.0036	.0040	.0050	
<b>S</b>	0.75 x D	0.3 x D	0.3 x D	50	–	90	<b>IPT</b>	.0030	.0033	.0036	.0045	

NOTE: Side milling applications – For longest length tools, reduce ae by 30%.  
 Slot milling applications – For longest length tools, reduce ap by 30%.  
 Lower value of cutting speed is used for high stock removal applications or for higher hardness (machinability) within group.  
 Higher value of cutting speed is used for finishing applications or for lower hardness (machinability) within group.  
 Above parameters are based on ideal conditions. For smaller taper machining centers, please adjust parameters accordingly on diameters >1/2".

INDEXABLE MILLING



SOLID END MILLING

HOLE/MAKING

TAPPING

TURNING

## HSS ER Roughers • Series 620E • Application Data • Uncoated • Inch

Material Group	 							Recommended feed per tooth (IPT=inch/th) for side milling (A). For slotting (B), reduce IPT by 20%.				
	Side Milling (A) and Slotting (B)			Uncoated								
	A		B	Cutting Speed – vc SFM			D1 – Diameter					
	ap	ae	ap	min		max	frac.	1 1/4	1 1/2	2		
M	1	1.5 x D	0.5 x D	1 x D	40	–	60	dec.	1.2500	1.5000	2.0000	
	2	1.5 x D	0.5 x D	1 x D	40	–	60	IPT	.0052	.0053	.0053	
S	4	1.5 x D	0.5 x D	1 x D	16	–	50	IPT	.0038	.0039	.0039	



NOTE: Side milling applications – for longest length tools, reduce ae by 30%.

Slot milling applications – for longest length tools, reduce ap by 30%.

Lower value of cutting speed is used for high stock removal applications or for higher hardness (machinability) within group.

Higher value of cutting speed is used for finishing applications or for lower hardness (machinability) within group.

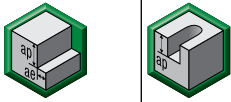
WavCut™ I • Series 620W • Application Data • Uncoated • Inch

Material Group													
	Side Milling (A) and Slotting (B)			Uncoated		Recommended feed per tooth (IPT = inch/th) for side milling (A). For slotting (B), reduce IPT by 20%.							
	A		B	Cutting Speed – vc SFM			D1 – Diameter						
	ap	ae	ap	min	max	frac. dec.	3/4	1	1 1/4	1 1/2	2		
<b>P</b>	<b>5</b>	1.5 x D	0.4 x D	1 x D	30	–	50	IPT	.0030	.0040	.0045	.0050	.0055
<b>M</b>	<b>1</b>	1.5 x D	0.4 x D	1 x D	30	–	50	IPT	.0040	.0045	.0050	.0055	.0060
	<b>2</b>	1.5 x D	0.4 x D	1 x D	30	–	40	IPT	.0035	.0040	.0045	.0050	.0055
<b>S</b>	<b>4</b>	1.5 x D	0.4 x D	0.75 x D	50	–	70	IPT	.0033	.0040	.0050	.0055	.0060

NOTE: Side milling applications – For longest length tools, reduce ae by 30%.  
 Slot milling applications – For longest length tools, reduce ap by 30%.  
 Lower value of cutting speed is used for high stock removal applications or for higher hardness (machinability) within group.  
 Higher value of cutting speed is used for finishing applications or for lower hardness (machinability) within group.  
 Above parameters are based on ideal conditions. For smaller taper machining centers, please adjust parameters accordingly on diameters >1/2".

INDEXABLE MILLING



SOLID END MILLING

HOLE/MAKING

TAPPING

TURNING

## WavCut II • Series 620V • Application Data • Uncoated - TiAlN • Inch

Material Group	 										Recommended feed per tooth (Fz=inch/th) for side milling (A). For slotting (B), reduce Fz by 20%.					
	A		B		Uncoated			TiAlN			D1 - Diameter					
					Cutting Speed – vc SFM			Cutting Speed – vc SFM			–					
	ap	ae	ap	Min	–	Max	Min	–	Max	frac.	3/4	1	1 1/4	1 1/2	2	
<b>P</b>	<b>5</b>	1.5 x D	0.4 x D	1 x D	30	–	50	80	–	110	Fz	.0030	.0040	.0045	.0050	.0055
<b>M</b>	<b>1</b>	1.5 x D	0.4 x D	1 x D	30	–	50	80	–	110	Fz	.0040	.0045	.0050	.0055	.0060
	<b>2</b>	1.5 x D	0.4 x D	1 x D	30	–	40	80	–	100	Fz	.0035	.0040	.0045	.0050	.0055
<b>S</b>	<b>4</b>	1.5 x D	0.4 x D	0.75 x D	50	–	70	50	–	90	Fz	.0033	.0040	.0050	.0055	.0060

NOTE: Side milling applications - For longest length tools, reduce ae by 30%.  
 Slot milling applications - For longest length tools, reduce ap by 30%.  
 Lower value of cutting speed is used for high-stock removal applications or for higher hardness (machinability) within group.  
 Higher value of cutting speed is used for finishing applications or for lower hardness (machinability) within group.  
 Above parameters are based on ideal conditions. For smaller taper machining centers, please adjust parameters accordingly on diameters greater than 1/2".

INDEXABLE MILLING

SOLID END MILLING

HOLEMAKING

TAPPING

TURNING

HSS Roughers • Series 6N06 • Application Data • TiAlN-LW • Metric

Material Group	Side Milling (A) and Slotting (B)		TiCN		TiAlN		Recommended feed per tooth (fz = mm/th) for side milling (A). For slotting (B), reduce fz by 20%.												
	A		B		Cutting Speed – vc m/min		Cutting Speed – vc m/min		mm	D1 – Diameter									
	ap	ae	ap		min	max	min	max		6,0	8,0	10,0	12,0	16,0	18,0	20,0	25,0	30,0	
	1,5 x D	0,5 x D	1 x D						fz	fz	fz	fz	fz	fz	fz	fz	fz	fz	
P	1	1,5 x D	0,5 x D	1 x D	56	–	64	70	80	fz	0,046	0,062	0,072	0,079	0,097	0,104	0,109	0,119	0,143
	2	1,5 x D	0,5 x D	1 x D	48	–	64	60	80	fz	0,046	0,062	0,072	0,079	0,097	0,104	0,109	0,119	0,143
	3	1,5 x D	0,5 x D	1 x D	40	–	56	50	70	fz	0,038	0,052	0,061	0,067	0,084	0,091	0,097	0,109	0,131
	5	1,5 x D	0,5 x D	1 x D	20	–	28	25	35	fz	0,031	0,042	0,048	0,054	0,067	0,073	0,078	0,087	0,105
M	1	1,5 x D	0,5 x D	1 x D	20	–	28	25	35	fz	0,038	0,052	0,061	0,067	0,084	0,091	0,097	0,109	0,131
	2	1,5 x D	0,5 x D	1 x D	20	–	24	25	30	fz	0,031	0,042	0,048	0,054	0,067	0,073	0,078	0,087	0,105
	3	1,5 x D	0,5 x D	1 x D	12	–	16	15	20	fz	0,026	0,035	0,040	0,045	0,055	0,059	0,062	0,068	0,082
K	1	1,5 x D	0,5 x D	1 x D	56	–	64	70	80	fz	0,046	0,062	0,072	0,079	0,097	0,104	0,109	0,119	0,143
	2	1,5 x D	0,5 x D	1 x D	40	–	56	50	70	fz	0,038	0,052	0,061	0,067	0,084	0,091	0,097	0,109	0,131
S	1	1,5 x D	0,5 x D	1 x D	12	–	24	15	30	fz	0,038	0,052	0,061	0,067	0,084	0,091	0,097	0,109	0,131
	2	1,5 x D	0,5 x D	1 x D	4	–	12	5	15	fz	0,021	0,027	0,032	0,036	0,045	0,048	0,052	0,059	0,071
	3	1,5 x D	0,5 x D	1 x D	12	–	22	15	28	fz	0,031	0,042	0,048	0,054	0,067	0,073	0,078	0,087	0,105
	4	1,5 x D	0,5 x D	1 x D	12	–	22	15	28	fz	0,027	0,038	0,045	0,050	0,062	0,067	0,071	0,080	0,096

NOTE: Lower value of cutting speed is used for high stock removal applications or for higher hardness (machinability) within group.  
Higher value of cutting speed is used for finishing applications or for lower hardness (machinability) within group.  
Above parameters are based on ideal conditions. For smaller taper machining centers, please adjust parameters accordingly on diameters >12mm.



HSS Roughers • Series 6NL6 • Application Data • TiAlN-LW • Metric

Material Group	Side Milling (A) and Slotting (B)		TiAlN		Recommended feed per tooth (fz = mm/th) for side milling (A). For slotting (B), reduce fz by 20%.									
	A		B		Cutting Speed – vc m/min		mm	D1 – Diameter						
	ap	ae	ap		min	max		10,0	12,0	16,0	20,0	25,0		
	1,5 x D	0,5 x D	1 x D				fz	fz	fz	fz	fz			
P	1	1,5 x D	0,5 x D	1 x D	70	–	80	fz	0,063	0,070	0,085	0,096	0,104	
	2	1,5 x D	0,5 x D	1 x D	60	–	80	fz	0,063	0,070	0,085	0,096	0,104	
	3	1,5 x D	0,5 x D	1 x D	50	–	70	fz	0,053	0,059	0,073	0,085	0,096	
	5	1,5 x D	0,5 x D	1 x D	25	–	35	fz	0,042	0,047	0,059	0,068	0,076	
M	1	1,5 x D	0,5 x D	1 x D	25	–	35	fz	0,053	0,059	0,073	0,085	0,096	
	2	1,5 x D	0,5 x D	1 x D	25	–	30	fz	0,042	0,047	0,059	0,068	0,076	
	3	1,5 x D	0,5 x D	1 x D	15	–	20	fz	0,035	0,039	0,048	0,054	0,060	
K	1	1,5 x D	0,5 x D	1 x D	70	–	80	fz	0,063	0,070	0,085	0,096	0,104	
	2	1,5 x D	0,5 x D	1 x D	50	–	70	fz	0,053	0,059	0,073	0,085	0,096	
S	1	1,5 x D	0,5 x D	1 x D	15	–	30	fz	0,053	0,059	0,073	0,085	0,096	
	2	1,5 x D	0,5 x D	1 x D	5	–	15	fz	0,028	0,031	0,039	0,045	0,051	
	3	1,5 x D	0,5 x D	1 x D	15	–	30	fz	0,042	0,047	0,059	0,068	0,076	
	4	1,5 x D	0,5 x D	1 x D	10	–	20	fz	0,039	0,043	0,054	0,062	0,070	

NOTE: Lower value of cutting speed is used for high stock removal applications or for higher hardness (machinability) within group.  
Higher value of cutting speed is used for finishing applications or for lower hardness (machinability) within group.  
Above parameters are based on ideal conditions. For smaller taper machining centers, please adjust parameters accordingly on diameters >12mm.





## WavCut I • Series 664W 660W 661W • Application Data • Uncoated-WW • Metric

												
		Side Milling (A) and Slotting (B)			Uncoated			Recommended feed per tooth (fz = mm/th) for side milling (A). For slotting (B), reduce fz by 20%.				
Material Group		A		B	Cutting Speed – vc m/min			mm	D1 – Diameter			
		ap	ae	ap	min		max		25,0	32,0	40,0	50,0
P	5	1,5 x D	0,4 x D	1 x D	10	–	14	fz	0,091	0,105	0,124	0,146
M	1	1,5 x D	0,4 x D	1 x D	10	–	14	fz	0,114	0,131	0,155	0,182
	2	1,5 x D	0,4 x D	1 x D	10	–	12	fz	0,091	0,105	0,124	0,146
S	3	1,5 x D	0,4 x D	0,75 x D	6	–	11	fz	0,091	0,105	0,124	0,146
	4	1,5 x D	0,4 x D	0,75 x D	6	–	11	fz	0,084	0,096	0,114	0,134

NOTE: Lower value of cutting speed is used for high stock removal applications or for higher hardness (machinability) within group.  
 Higher value of cutting speed is used for finishing applications or for lower hardness (machinability) within group.  
 Above parameters are based on ideal conditions. For smaller taper machining centers, please adjust parameters accordingly on diameters >12mm.

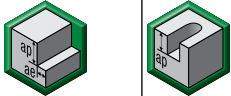
## WavCut I • Series 3405 • Application Data • Uncoated-WW • Metric

																	
		Side Milling (A) and Slotting (B)			Uncoated		TiAlN		Recommended feed per tooth (IPT = inch/th) for side milling (A). For slotting (B), reduce IPT by 20%.								
Material Group		A		B	Cutting Speed – vc SFM		Cutting Speed – vc SFM		D1 – Diameter								
		ap	ae	ap	min	max	min	max	frac.	3/8	1/2	5/8	3/4	1	1 1/4	1 1/2	2
S	3	1.5 x D	0.1 x D	0.5 x D	50	– 80	50	– 90	IPT	.0020	.0025	.0029	.0032	.0038	.0042	.0045	.0048
	4	1.5 x D	0.1 x D	0.4 x D	40	– 60	50	– 90	IPT	.0018	.0023	.0026	.0029	.0035	.0038	.0041	.0044

NOTE: Side milling applications – For longest reach (L3) tools, reduce ae by 30%.  
 Slot milling applications – For longest reach (L3) tools, reduce ap by 30%.  
 For cutting aluminum with high silicon, coating is recommended.  
 Lower value of cutting speed is used for high stock removal applications or for higher hardness (machinability) within group.  
 Higher value of cutting speed is used for finishing applications or for lower hardness (machinability) within group.  
 Above parameters are based on ideal conditions. For smaller taper machining centers, please adjust parameters accordingly on diameters >1/2".





# Holemaking

<b>Selection Guide and Grade Descriptions</b> .....	<b>C4–C6</b>
<b>Solid Carbide Drills</b> .....	<b>C8–C46</b>
VariDrill.....	C8–C29
TOP DRILL S+.....	C30–C35
TOP DRILL Deep Hole Drills.....	C36–C46
<b>Modular Drills</b> .....	<b>C48–87</b>
TOP DRILL Modular X.....	C48–C67
TOP DRILL M1.....	C68–C87
<b>Indexable Drills</b> .....	<b>C88–C117</b>
Top Cut 4.....	C88–C117

## Added Value for Your Performance

### Optimized Purchase

- Broad selection of holemaking tools.
- Integrated into a full range of cutting tools and service offers.
- On-site service for an efficient development and implementation of machining solutions.

### Control of Total Tooling Costs

- Process-safe regrinding service.
- Reduction of stocks through efficient modular concepts.
- Multiple platforms per application to achieve the most cost-efficient solution.

- Solid Carbide Drills
- Modular Drills
- Indexable Drills

## Select the Correct Holemaking Product Platform for Your Application

diameter	hourly rate					
	low (rough)		normal (M/C)		high (fine)	
	IT11	IT10	IT9	IT8	IT7	IT6
inch	hole quality					
0.118"						
0.236"						
0.354"						
0.472"						
0.591"						
0.709"						
0.827"						
0.945"						
1.063"						
1.181"						
1.299"						
1.417"						
1.535"						
1.654"						
1.772"						
2.283"						
2.008"						
2.126"						
2.244"						
2.362"						
2.598"						
2.716"						
2.834"						
2.952"						
4.331"						

## Grades and Grade Descriptions

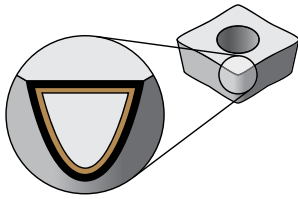

Coatings provide high-speed capability and are engineered for finishing to heavy roughing.

P	Steel
M	Stainless Steel
K	Cast Iron
N	Non-Ferrous
S	High-Temp Alloys
H	Hardened Materials

wear resistance ← → toughness

Grade	Coating	Grade Description	Material Group																						
			P	M	K	N	S	H	P	M	K	N	S	H											
WK15PD		<p><b>Composition:</b> With a newly developed unique multilayered PVD AlCrN coating and a high-quality submicron carbide substrate, this grade gives the highest level of wear resistance at high cutting speeds.</p> <p><b>Application:</b> This grade offers extraordinary wear resistance in drilling of cast iron materials. With its high hot hardness, it allows for high-speed machining.</p>																							
			K																						
WM15PD		<p><b>Composition:</b> With PVD AlTiN coating for wear resistance along with unalloyed, sub-micron tungsten carbide containing 10% cobalt.</p> <p><b>Application:</b> For use in cast iron, stainless steel, non-ferrous, and super alloys. Grade capable to operate at higher temperatures to guarantee high performance at faster cutting speeds.</p>	P																						
			M																						
			K																						
			N																						
			S																						
			H																						
WU20PD		<p><b>Composition:</b> With a multilayered PVD TiN-TiAlN coating, a high-quality, sub-micron, carbide substrate and a state-of-the-art surface condition, this grade gives the highest level of wear resistance at high cutting speeds.</p> <p><b>Application:</b> First choice for alloyed and high-alloyed steels and cast irons. A state-of-the-art surface condition enables superior chip evacuation even when MQL is applied.</p>	P																						
			K																						
WU25PD		<p><b>Composition:</b> With a multilayered PVD TiN-TiAlN coating and a high-quality, sub-micron, carbide substrate, this grade gives a high level of wear resistance at medium to high cutting speeds.</p> <p><b>Application:</b> First choice for high reliability in all materials. This grade should be used at medium to high speeds and feeds. It is a general-purpose grade that performs very well for alloyed and high-alloy steel and cast iron, but can also be used with excellent performance in all other material groups.</p>	P																						
			M																						
			K																						
			N																						
			S																						
			H																						
WP40PD		<p><b>Composition:</b> With a multilayered TiN-TiAlN coating and a high-quality, tough substrate containing 11% cobalt.</p> <p><b>Application:</b> For use in steel, cast iron, stainless steel, and super alloys. This grade is suitable for critical operations and unstable conditions.</p>	P																						
			M																						
			K																						
			N																						
			S																						
			H																						
WN10HD		<p><b>Composition:</b> This uncoated fine-grain carbide with high hardness offers excellent abrasive wear resistance.</p> <p><b>Application:</b> First choice for precision drilling of non-ferrous materials.</p>																							
			K																						

## Grades and Grade Descriptions

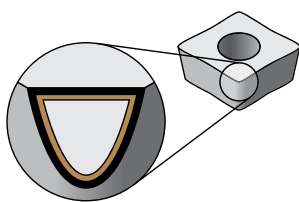

Coatings provide high-speed capability and are engineered for finishing to heavy roughing.

P	Steel
M	Stainless Steel
K	Cast Iron
N	Non-Ferrous
S	High-Temp Alloys
H	Hardened Materials

wear resistance ← → toughness

Grade	Coating	Grade Description	Material Hardness (HV)																					
			05	10	15	20	25	30	35	40	45													
WN15HD		<b>Composition:</b> Submicron grain size tungsten carbide for excellent wear resistance and edge retention. <b>Application:</b> For use in aluminum and non-ferrous materials																						
			K																					
			N																					
WPK10CH		<b>Composition:</b> With an advanced CVD TiCN-Al <sub>2</sub> O <sub>3</sub> coating combined with a cobalt-enriched carbide substrate, this grade offers a balanced combination of deformation resistance and edge toughness. <b>Application:</b> Offers outstanding abrasion and crater wear resistance for high-speed machining of steels and cast irons. Use for very high cutting speeds with low to medium feed rates.																						
			P																					
			K																					
WN10PH		<b>Composition:</b> Submicron grain size tungsten carbide with PVD TiB <sub>2</sub> coating for excellent wear resistance. <b>Application:</b> For use in aluminum and non-ferrous applications.																						
			N																					
WU20PH		<b>Composition:</b> With a wear-resistant TiAlN coating and unalloyed, submicron tungsten carbide containing 10% cobalt. <b>Application:</b> This is a universal grade for use in steel, cast iron, stainless steel, and super alloys at medium machining speeds.																						
			P																					
			M																					
			K																					
			N																					
			S																					
WU25CH		<b>Composition:</b> Advanced CVD TiCN-Al <sub>2</sub> O <sub>3</sub> coating together with a newly engineered, tough carbide substrate. Ensures adequate deformation resistance and excellent edge strength and offers very good wear resistance over a wide range of machining conditions. <b>Application:</b> high-productivity grade with high speeds and feeds. First choice for high productivity with excellent reliability in steels, stainless steels, and cast irons.																						
			P																					
			M																					
WU40PH		<b>Composition:</b> With a multilayered PVD TiN-TiAlN coating and a tough substrate, this grade withstands interruptions and provides high wear resistance for long tool life. <b>Application:</b> First choice for high reliability in most materials. This grade should be used at medium speeds and high feeds due to sharper edges and as a grade for high-toughness applications. It covers steel, stainless steel, cast iron, and high-temp alloys under certain conditions.																						
			P																					
			M																					







The VariDrill solid carbide drill is a versatile drill designed for use in multi-material drilling operations.



**The point design** offers the ultimate solution for multi-material drilling

**Low runout** on the shank

**Marginless design** to distribute cutting forces evenly for less chipping on the cutting edge

**WU25PD grade** to enhance wear-resistance

The VariDrill solid carbide drill series is a multi-material drill offered in a wide range of sizes from .39–.787" (1–20mm) in 0.1mm steps in 3 x D, 5 x D, and 8 x D, with and without coolant channels.

### WU25PD



**Delivers a smooth surface finish across multiple materials:**

Steel, stainless steel, aluminum, cast iron, and high-temp alloys.

# MULTI-MATERIAL DRILLING

## PRODUCT

GRADE

WU25PD

## DIAMETER RANGE

.0394–.7874" (1–20mm)  
.0591–.7874" (1.5–20mm)

## INDUSTRY



## MATERIALS

FIRST CHOICE



## Applications



DRILLING



STACKED PLATES



PLAIN SHANK: HELIX ANGLE:  $\leq H6$



HELIX ANGLE: 30°



DIN 6537



DIN 6535



THROUGH COOLANT



FLOOD COOLANT



THROUGH COOLANT: MQL



### SERIES

VDS201

### COOLANT

Non-Coolant

### LENGTH RATIO

3 x D

### DIAMETER RANGE

.0394–.7874" (1–20mm)

VDS202

Non-Coolant

5 x D

.0394–.7874" (1–20mm)

VDS401

Through Coolant

3 x D

.0591–.7874" (1.5–20mm)

VDS402

Through Coolant

5 x D

.0591–.7874" (1.5–20mm)

VDS403

Through Coolant

8 x D

.0591–.7874" (1.5–20mm)

## PRECISION SHANK

Low Runout  
Increase the overall drill stability



## VariDrill™ • Catalog Numbering System

Each character in our catalog number signifies a specific trait of that product.  
Use the following key columns and corresponding images to easily identify which attributes apply.

VDS	4	0	1	A	06350	WU25PD
VariDrill Spiral	Flute Style - Coolant	Point	Length	Shank	Diameter in Inch	
	<p>2 = 2 Flute Spiral Non- Coolant</p> <p>4 = 2 Flute Spiral Coolant</p>	<p>0 = Conventional Cone Point</p>	<p>1 = ~ 3 x D 2 = ~ 5 x D 3 = ~ 8 x D</p>	<p>A = Cylindrical Shank, DIN 6535 - 2mm steps</p> <p>F = Whistle Notch 2, DIN 6535 - 2mm steps</p>	<p>03000 = 3,000mm 06350 = 1/4"</p>	<p>WIDIA™; Universal, Application 25 = roughing carbide, PVD coated, Drill</p>

## New type "A"

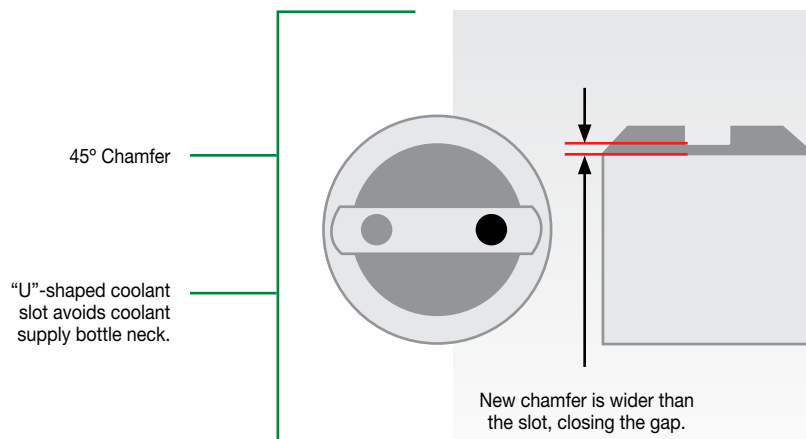

New standard back end fulfills the requirements of DIN 6535 and 69090-03 for variable use of internal coolant or MQL.

VariDrill™ • 3 x D • VDS201A / VDS401A • A-Shank

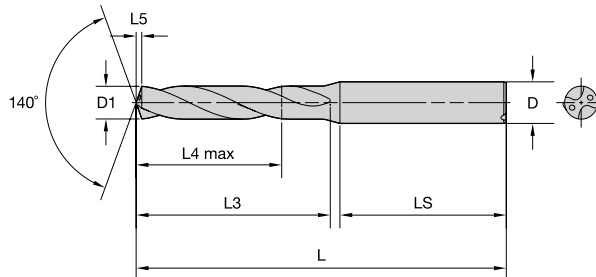

For information on L, L3, and L4 max, see page C46.

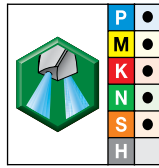
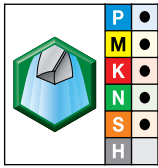

● first choice  
○ alternate choice

grade WU25PD TiAlN		grade WU25PD TiAlN		D1 diameter				L4 max	L3	L5	L	LS	D
order #	catalog #	order #	catalog #	mm	in	fraction	wire size						
4144195	VDS201A01000	-	-	1,000	.0394	-	-	5	7	0,2	58	28	4
4144196	VDS201A01016	-	-	1,016	.0400	-	-	5	7	0,1	58	28	4
4144197	VDS201A01041	-	-	1,041	.0410	-	-	5	7	0,2	58	28	4
4144198	VDS201A01067	-	-	1,067	.0420	-	-	5	7	0,2	58	28	4
4144199	VDS201A01092	-	-	1,092	.0430	-	-	5	7	0,2	58	28	4
4144200	VDS201A01100	-	-	1,100	.0433	-	-	5	7	0,2	58	28	4
4144201	VDS201A01181	-	-	1,181	.0465	-	-	5	7	0,2	58	28	4
4144202	VDS201A01191	-	-	1,191	.0469	3/64	-	5	7	0,2	58	28	4
4144523	VDS201A01200	-	-	1,200	.0472	-	-	5	7	0,2	58	28	4
4144524	VDS201A01300	-	-	1,300	.0512	-	-	5	7	0,2	58	28	4
4144526	VDS201A01397	-	-	1,397	.0550	-	-	5	7	0,2	58	28	4
4144527	VDS201A01400	-	-	1,400	.0551	-	-	5	7	0,2	58	28	4
4144528	VDS201A01500	4140270	VDS401A01500	1,500	.0591	-	-	6	9	0,2	58	28	4
4144529	VDS201A01600	-	-	1,600	.0630	-	-	6	9	0,3	58	28	4
-	-	4140271	VDS401A01600	1,600	.0630	-	-	6	9	0,2	58	28	4
4144530	VDS201A01700	4140272	VDS401A01700	1,700	.0669	-	-	6	9	0,3	58	28	4
4144531	VDS201A01800	4140423	VDS401A01800	1,800	.0709	-	-	6	9	0,3	58	28	4
4144532	VDS201A01900	4140424	VDS401A01900	1,900	.0748	-	-	6	9	0,3	58	28	4
4144533	VDS201A01984	4140425	VDS401A01984	1,984	.0781	5/64	-	10	13	0,3	58	28	4
4144534	VDS201A02000	4140426	VDS401A02000	2,000	.0787	-	-	10	13	0,3	58	28	4
4144535	VDS201A02100	4140427	VDS401A02100	2,100	.0827	-	-	10	13	0,3	58	28	4
4144536	VDS201A02200	4140428	VDS401A02200	2,200	.0866	-	-	10	13	0,3	58	28	4
4144537	VDS201A02300	4140429	VDS401A02300	2,300	.0906	-	-	10	13	0,4	58	28	4
4144538	VDS201A02383	4140430	VDS401A02383	2,383	.0938	3/32	-	12	17	0,4	58	28	4
4144539	VDS201A02400	4140431	VDS401A02400	2,400	.0945	-	-	12	17	0,4	58	28	4
4144540	VDS201A02439	4140432	VDS401A02439	2,439	.0960	-	41	12	17	0,4	58	28	4
4144541	VDS201A02489	4140433	VDS401A02489	2,489	.0980	-	40	12	17	0,4	58	28	4
4144542	VDS201A02500	4140434	VDS401A02500	2,500	.0984	-	-	12	17	0,4	58	28	4
4144543	VDS201A02578	4140435	VDS401A02578	2,578	.1015	-	38	12	17	0,4	58	28	4
4144544	VDS201A02600	4140436	VDS401A02600	2,600	.1024	-	-	12	17	0,4	58	28	4
4144545	VDS201A02642	4140437	VDS401A02642	2,642	.1040	-	37	12	17	0,4	58	28	4
4144546	VDS201A02700	4140438	VDS401A02700	2,700	.1063	-	-	12	17	0,4	58	28	4
4144547	VDS201A02705	4140439	VDS401A02705	2,705	.1065	-	36	12	17	0,4	58	28	4
4144548	VDS201A02779	4140440	VDS401A02779	2,779	.1094	7/64	-	12	17	0,4	58	28	4
4144549	VDS201A02800	4140441	VDS401A02800	2,800	.1102	-	-	12	17	0,5	58	28	4
4144550	VDS201A02820	4140442	VDS401A02820	2,820	.1110	-	34	12	17	0,5	58	28	4
4144551	VDS201A02870	4140443	VDS401A02870	2,870	.1130	-	33	12	17	0,5	58	28	4
4144552	VDS201A02900	4140444	VDS401A02900	2,900	.1142	-	-	12	17	0,5	58	28	4
4144553	VDS201A02947	4140445	VDS401A02947	2,947	.1160	-	32	12	17	0,5	58	28	4
4143907	VDS201A03000	4140299	VDS401A03000	3,000	.1181	-	-	14	20	0,5	62	36	6
4143908	VDS201A03048	4140300	VDS401A03048	3,048	.1200	-	31	14	20	0,5	62	36	6
4143909	VDS201A03100	4140301	VDS401A03100	3,100	.1220	-	-	14	20	0,5	62	36	6
4143910	VDS201A03175	4140302	VDS401A03175	3,175	.1250	1/8	-	14	20	0,5	62	36	6
4143911	VDS201A03200	4140303	VDS401A03200	3,200	.1260	-	-	14	20	0,5	62	36	6
4143912	VDS201A03264	4140304	VDS401A03264	3,264	.1285	-	30	14	20	0,5	62	36	6
4143913	VDS201A03300	4140305	VDS401A03300	3,300	.1299	-	-	14	20	0,5	62	36	6
4143914	VDS201A03400	4140306	VDS401A03400	3,400	.1339	-	-	14	20	0,6	62	36	6
4143915	VDS201A03455	4140307	VDS401A03455	3,455	.1360	-	29	14	20	0,6	62	36	6

## VariDrill • 3 x D • VDS201A / VDS401A • A-Shank

(continued)

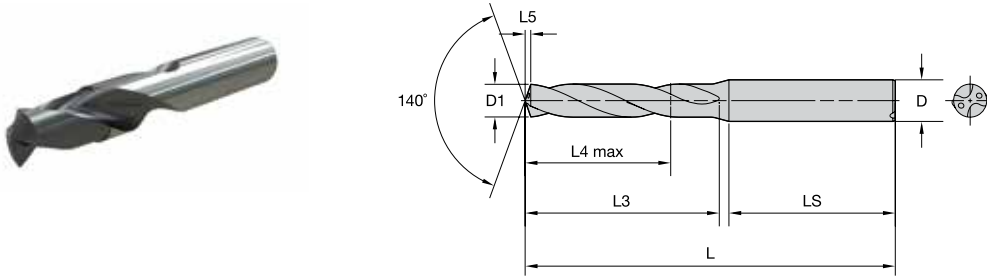

For information on L, L3, and L4 max, see page C46.

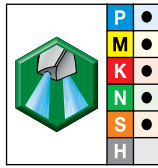
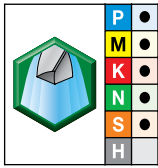

● first choice  
○ alternate choice

grade WU25PD TiAlN		grade WU25PD TiAlN		D1 diameter				L4 max	L3	L5	L	LS	D
order #	catalog #	order #	catalog #	mm	in	fraction	wire size						
4143916	VDS201A03500	4140308	VDS401A03500	3,500	.1378	—	—	14	20	0,6	62	36	6
4143917	VDS201A03571	4140309	VDS401A03571	3,571	.1406	9/64	—	14	20	0,6	62	36	6
4143918	VDS201A03600	4140310	VDS401A03600	3,600	.1417	—	—	14	20	0,6	62	36	6
4143919	VDS201A03658	4140311	VDS401A03658	3,658	.1440	—	27	14	20	0,6	62	36	6
4143920	VDS201A03700	4140312	VDS401A03700	3,700	.1457	—	—	14	20	0,6	62	36	6
4143921	VDS201A03734	4140313	VDS401A03734	3,734	.1470	—	26	14	20	0,6	62	36	6
4143922	VDS201A03800	4140314	VDS401A03800	3,800	.1496	—	—	17	24	0,6	66	36	6
4143923	VDS201A03900	4140315	VDS401A03900	3,900	.1535	—	—	17	24	0,6	66	36	6
4143924	VDS201A03970	4140316	VDS401A03970	3,970	.1563	5/32	—	17	24	0,7	66	36	6
4143925	VDS201A04000	4140317	VDS401A04000	4,000	.1575	—	—	17	24	0,7	66	36	6
4143926	VDS201A04039	4140318	VDS401A04039	4,039	.1590	—	21	17	24	0,7	66	36	6
4143927	VDS201A04090	4140319	VDS401A04090	4,090	.1610	—	20	17	24	0,7	66	36	6
4143928	VDS201A04100	4140320	VDS401A04100	4,100	.1614	—	—	17	24	0,7	66	36	6
4143929	VDS201A04200	4140321	VDS401A04200	4,200	.1654	—	—	17	24	0,7	66	36	6
4143930	VDS201A04217	—	—	4,217	.1660	—	19	17	24	0,7	66	36	6
4143931	VDS201A04300	4140323	VDS401A04300	4,300	.1693	—	—	17	24	0,7	66	36	6
4143932	VDS201A04366	4140324	VDS401A04366	4,366	.1719	11/64	—	17	24	0,7	66	36	6
4143933	VDS201A04400	4140325	VDS401A04400	4,400	.1732	—	—	17	24	0,7	66	36	6
4143934	VDS201A04500	4140326	VDS401A04500	4,500	.1772	—	—	17	24	0,7	66	36	6
4143935	VDS201A04600	4140328	VDS401A04600	4,600	.1811	—	—	17	24	0,8	66	36	6
4143936	VDS201A04623	4140329	VDS401A04623	4,623	.1820	—	14	17	24	0,8	66	36	6
4143937	VDS201A04700	4140330	VDS401A04700	4,700	.1850	—	13	17	24	0,8	66	36	6
4143938	VDS201A04763	4140331	VDS401A04763	4,763	.1875	3/16	—	20	28	0,8	66	36	6
4143939	VDS201A04800	4140332	VDS401A04800	4,800	.1890	—	12	20	28	0,8	66	36	6
4143940	VDS201A04852	4140333	VDS401A04852	4,852	.1910	—	11	20	28	0,8	66	36	6
4143941	VDS201A04900	4140334	VDS401A04900	4,900	.1929	—	—	20	28	0,8	66	36	6
4143942	VDS201A05000	4140335	VDS401A05000	5,000	.1969	—	—	20	28	0,8	66	36	6
4143943	VDS201A05100	4140336	VDS401A05100	5,100	.2008	—	—	20	28	0,9	66	36	6
4143944	VDS201A05106	4140337	VDS401A05106	5,106	.2010	—	7	20	28	0,9	66	36	6
4143945	VDS201A05159	4140338	VDS401A05159	5,159	.2031	13/64	—	20	28	0,9	66	36	6
4143946	VDS201A05200	4140339	VDS401A05200	5,200	.2047	—	—	20	28	0,9	66	36	6
4143947	VDS201A05300	4140340	VDS401A05300	5,300	.2087	—	—	20	28	0,9	66	36	6
4143948	VDS201A05400	4140341	VDS401A05400	5,400	.2126	—	—	20	28	0,9	66	36	6
4143949	VDS201A05410	4140342	VDS401A05410	5,410	.2130	—	3	20	28	0,9	66	36	6
4143950	VDS201A05500	4140343	VDS401A05500	5,500	.2165	—	—	20	28	0,9	66	36	6
4143951	VDS201A05558	4140344	VDS401A05558	5,558	.2188	7/32	—	20	28	0,9	66	36	6
4143952	VDS201A05600	4140345	VDS401A05600	5,600	.2205	—	—	20	28	0,9	66	36	6
4143953	VDS201A05616	4140346	VDS401A05616	5,616	.2211	—	2	20	28	0,9	66	36	6
4143954	VDS201A05700	4140347	VDS401A05700	5,700	.2244	—	—	20	28	1,0	66	36	6
4143955	VDS201A05800	4140348	VDS401A05800	5,800	.2283	—	—	20	28	1,0	66	36	6
4143956	VDS201A05900	4140349	VDS401A05900	5,900	.2323	—	—	20	28	1,0	66	36	6
4143957	VDS201A05954	4140350	VDS401A05954	5,954	.2344	15/64	—	20	28	1,0	66	36	6
4143958	VDS201A06000	4140351	VDS401A06000	6,000	.2362	—	—	20	28	1,0	66	36	6
4143959	VDS201A06100	4140352	VDS401A06100	6,100	.2402	—	—	24	34	1,0	79	36	8
4143960	VDS201A06200	4140353	VDS401A06200	6,200	.2441	—	—	24	34	1,0	79	36	8
4143961	VDS201A06300	4140354	VDS401A06300	6,300	.2480	—	—	24	34	1,1	79	36	8
4143962	VDS201A06350	4140355	VDS401A06350	6,350	.2500	1/4	E	24	34	1,1	79	36	8
4143963	VDS201A06400	4140356	VDS401A06400	6,400	.2520	—	—	24	34	1,1	79	36	8

VariDrill • 3 x D • VDS201A / VDS401A • A-Shank

(continued)

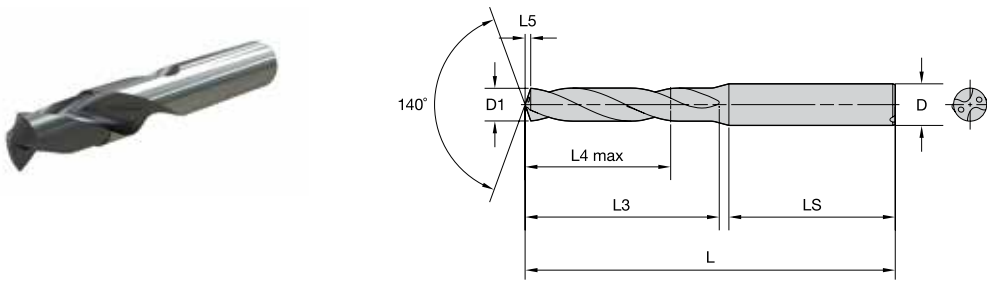

For information on L, L3, and L4 max, see page C46.

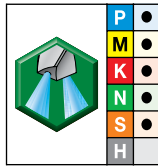
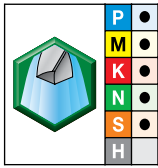

● first choice  
○ alternate choice

grade WU25PD TiAlN		grade WU25PD TiAlN		D1 diameter				L4 max	L3	L5	L	LS	D
order #	catalog #	order #	catalog #	mm	in	fraction	wire size						
4143964	VDS201A06500	4140357	VDS401A06500	6,500	.2559	—	—	24	34	1,1	79	36	8
4143965	VDS201A06528	4140358	VDS401A06528	6,528	.2570	—	F	24	34	1,1	79	36	8
4143966	VDS201A06600	4140359	VDS401A06600	6,600	.2598	—	—	24	34	1,1	79	36	8
4143967	VDS201A06630	4140360	VDS401A06630	6,630	.2610	—	G	24	34	1,1	79	36	8
4143968	VDS201A06700	4140361	VDS401A06700	6,700	.2638	—	—	24	34	1,1	79	36	8
4143969	VDS201A06746	4140362	VDS401A06746	6,746	.2656	17/64	—	24	34	1,1	79	36	8
4143970	VDS201A06800	4140363	VDS401A06800	6,800	.2677	—	—	24	34	1,1	79	36	8
4143971	VDS201A06900	4140364	VDS401A06900	6,900	.2717	—	—	24	34	1,2	79	36	8
4143972	VDS201A07000	4140365	VDS401A07000	7,000	.2756	—	—	24	34	1,2	79	36	8
4143973	VDS201A07100	4140366	VDS401A07100	7,100	.2795	—	—	29	41	1,2	79	36	8
4143974	VDS201A07145	4140367	VDS401A07145	7,145	.2813	9/32	—	29	41	1,2	79	36	8
4143975	VDS201A07200	4140368	VDS401A07200	7,200	.2835	—	—	29	41	1,2	79	36	8
4143976	VDS201A07300	4140369	VDS401A07300	7,300	.2874	—	—	29	41	1,2	79	36	8
4143977	VDS201A07400	4140370	VDS401A07400	7,400	.2913	—	—	29	41	1,3	79	36	8
4143978	VDS201A07500	4140371	VDS401A07500	7,500	.2953	—	—	29	41	1,3	79	36	8
4143979	VDS201A07541	4140372	VDS401A07541	7,541	.2969	19/64	—	29	41	1,3	79	36	8
4143980	VDS201A07600	4140373	VDS401A07600	7,600	.2992	—	—	29	41	1,3	79	36	8
4143981	VDS201A07700	4140374	VDS401A07700	7,700	.3031	—	—	29	41	1,3	79	36	8
4143982	VDS201A07800	4140375	VDS401A07800	7,800	.3071	—	—	29	41	1,3	79	36	8
4143983	VDS201A07900	4140376	VDS401A07900	7,900	.3110	—	—	29	41	1,3	79	36	8
4143984	VDS201A07938	4140377	VDS401A07938	7,938	.3125	5/16	—	29	41	1,3	79	36	8
4143985	VDS201A08000	4140378	VDS401A08000	8,000	.3150	—	—	29	41	1,4	79	36	8
4143986	VDS201A08100	4140379	VDS401A08100	8,100	.3189	—	—	35	47	1,4	89	40	10
4143987	VDS201A08200	4140380	VDS401A08200	8,200	.3228	—	—	35	47	1,4	89	40	10
4143988	VDS201A08300	4140381	VDS401A08300	8,300	.3268	—	—	35	47	1,4	89	40	10
4143989	VDS201A08334	4140382	VDS401A08334	8,334	.3281	21/64	—	35	47	1,4	89	40	10
4143990	VDS201A08400	4140383	VDS401A08400	8,400	.3307	—	—	35	47	1,4	89	40	10
4143991	VDS201A08433	4140384	VDS401A08433	8,433	.3320	—	Q	35	47	1,4	89	40	10
4143992	VDS201A08500	4140385	VDS401A08500	8,500	.3346	—	—	35	47	1,4	89	40	10
4143993	VDS201A08600	4140386	VDS401A08600	8,600	.3386	—	—	35	47	1,5	89	40	10
4143994	VDS201A08700	4140387	VDS401A08700	8,700	.3425	—	—	35	47	1,5	89	40	10
4143995	VDS201A08733	4140388	VDS401A08733	8,733	.3438	11/32	—	35	47	1,5	89	40	10
4143996	VDS201A08800	4140389	VDS401A08800	8,800	.3465	—	—	35	47	1,5	89	40	10
4143997	VDS201A08900	4140390	VDS401A08900	8,900	.3504	—	—	35	47	1,5	89	40	10
4143998	VDS201A09000	4140391	VDS401A09000	9,000	.3543	—	—	35	47	1,5	89	40	10
4143999	VDS201A09100	—	—	9,100	.3583	—	—	35	47	1,5	89	40	10
—	—	4140392	VDS401A09100	9,100	.3583	—	—	35	47	1,6	89	40	10
4144000	VDS201A09129	4140393	VDS401A09129	9,129	.3594	23/64	—	35	47	1,6	89	40	10
4144001	VDS201A09200	4140394	VDS401A09200	9,200	.3622	—	—	35	47	1,6	89	40	10
4144002	VDS201A09300	4140395	VDS401A09300	9,300	.3661	—	—	35	47	1,6	89	40	10
4144003	VDS201A09347	4140396	VDS401A09347	9,347	.3680	—	U	35	47	1,6	89	40	10
4144004	VDS201A09400	4140397	VDS401A09400	9,400	.3701	—	—	35	47	1,6	89	40	10
4144005	VDS201A09500	4140398	VDS401A09500	9,500	.3740	—	—	35	47	1,6	89	40	10
4144006	VDS201A09525	4140399	VDS401A09525	9,525	.3750	3/8	—	35	47	1,6	89	40	10
4144007	VDS201A09600	4140400	VDS401A09600	9,600	.3780	—	—	35	47	1,6	89	40	10
4144008	VDS201A09700	4140401	VDS401A09700	9,700	.3819	—	—	35	47	1,7	89	40	10
4144009	VDS201A09800	4140402	VDS401A09800	9,800	.3858	—	—	35	47	1,7	89	40	10
4144010	VDS201A09900	4140403	VDS401A09900	9,900	.3898	—	—	35	47	1,7	89	40	10

## VariDrill™ • 3 x D • VDS201A / VDS401A • A-Shank

(continued)

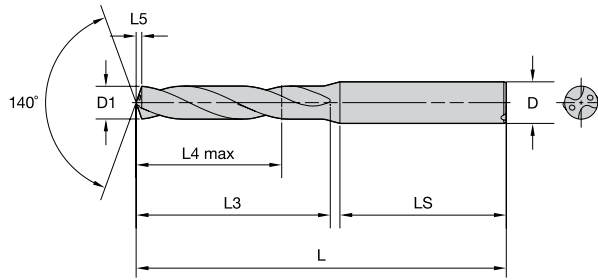

For information on L, L3, and L4 max, see page C46.

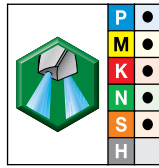
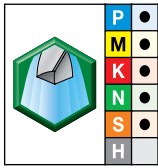

● first choice  
○ alternate choice

grade WU25PD TiAlN		grade WU25PD TiAlN		D1 diameter				L4 max	L3	L5	L	LS	D
order #	catalog #	order #	catalog #	mm	in	fraction	wire size						
4144011	VDS201A09921	4140404	VDS401A09921	9,921	.3906	25/64	—	35	47	1,7	89	40	10
4144172	VDS201A10000	4140001	VDS401A10000	10,000	.3937	—	—	35	47	1,7	89	40	10
4144423	VDS201A10100	4140002	VDS401A10100	10,100	.3976	—	—	40	55	1,7	102	45	12
4144424	VDS201A10200	4140163	VDS401A10200	10,200	.4016	—	—	40	55	1,7	102	45	12
4144425	VDS201A10300	4140164	VDS401A10300	10,300	.4055	—	—	40	55	1,8	102	45	12
4144426	VDS201A10320	4140165	VDS401A10320	10,320	.4063	13/32	—	40	55	1,8	102	45	12
4144427	VDS201A10400	4140166	VDS401A10400	10,400	.4094	—	—	40	55	1,8	102	45	12
4144428	VDS201A10500	4140167	VDS401A10500	10,500	.4134	—	—	40	55	1,8	102	45	12
4144429	VDS201A10600	4140168	VDS401A10600	10,600	.4173	—	—	40	55	1,8	102	45	12
4144430	VDS201A10700	4140169	VDS401A10700	10,700	.4213	—	—	40	55	1,8	102	45	12
4144431	VDS201A10716	4140170	VDS401A10716	10,716	.4219	27/64	—	40	55	1,8	102	45	12
4144432	VDS201A10800	4140171	VDS401A10800	10,800	.4252	—	—	40	55	1,9	102	45	12
4144433	VDS201A10900	4140172	VDS401A10900	10,900	.4291	—	—	40	55	1,9	102	45	12
4144434	VDS201A11000	4140173	VDS401A11000	11,000	.4331	—	—	40	55	1,9	102	45	12
4144435	VDS201A11100	4140174	VDS401A11100	11,100	.4370	—	—	40	55	1,9	102	45	12
4144436	VDS201A11113	4140175	VDS401A11113	11,113	.4375	7/16	—	40	55	1,9	102	45	12
4144437	VDS201A11200	4140176	VDS401A11200	11,200	.4409	—	—	40	55	1,9	102	45	12
4144438	VDS201A11300	4140177	VDS401A11300	11,300	.4449	—	—	40	55	1,9	102	45	12
4144439	VDS201A11400	4140178	VDS401A11400	11,400	.4488	—	—	40	55	2,0	102	45	12
4144440	VDS201A11500	4140179	VDS401A11500	11,500	.4528	—	—	40	55	2,0	102	45	12
4144441	VDS201A11509	4140180	VDS401A11509	11,509	.4531	29/64	—	40	55	2,0	102	45	12
4144442	VDS201A11600	4140181	VDS401A11600	11,600	.4567	—	—	40	55	2,0	102	45	12
4144443	VDS201A11700	4140182	VDS401A11700	11,700	.4606	—	—	40	55	2,0	102	45	12
4144444	VDS201A11800	4140183	VDS401A11800	11,800	.4646	—	—	40	55	2,0	102	45	12
4144445	VDS201A11900	4140184	VDS401A11900	11,900	.4685	—	—	40	55	2,0	102	45	12
4144446	VDS201A11908	4140185	VDS401A11908	11,908	.4688	15/32	—	40	55	2,0	102	45	12
4144447	VDS201A12000	4140186	VDS401A12000	12,000	.4724	—	—	40	55	2,1	102	45	12
4144448	VDS201A12100	4140187	VDS401A12100	12,100	.4764	—	—	43	60	2,1	107	45	14
4144449	VDS201A12200	4140188	VDS401A12200	12,200	.4803	—	—	43	60	2,1	107	45	14
4144450	VDS201A12300	4140189	VDS401A12300	12,300	.4843	—	—	43	60	2,1	107	45	14
4144451	VDS201A12304	4140190	VDS401A12304	12,304	.4844	31/64	—	43	60	2,1	107	45	14
4144452	VDS201A12400	4140191	VDS401A12400	12,400	.4882	—	—	43	60	2,1	107	45	14
4144453	VDS201A12500	4140192	VDS401A12500	12,500	.4921	—	—	43	60	2,2	107	45	14
4144454	VDS201A12600	4140194	VDS401A12600	12,600	.4961	—	—	43	60	2,2	107	45	14
4144455	VDS201A12700	4140195	VDS401A12700	12,700	.5000	1/2	—	43	60	2,2	107	45	14
4144456	VDS201A12800	4140196	VDS401A12800	12,800	.5039	—	—	43	60	2,2	107	45	14
4144457	VDS201A12900	4140197	VDS401A12900	12,900	.5079	—	—	43	60	2,2	107	45	14
4144458	VDS201A13000	4140198	VDS401A13000	13,000	.5118	—	—	43	60	2,2	107	45	14
4144459	VDS201A13096	4140199	VDS401A13096	13,096	.5156	33/64	—	43	60	2,3	107	45	14
4144460	VDS201A13100	4140200	VDS401A13100	13,100	.5157	—	—	43	60	2,3	107	45	14
4144461	VDS201A13200	4140201	VDS401A13200	13,200	.5197	—	—	43	60	2,3	107	45	14
4144462	VDS201A13300	4140202	VDS401A13300	13,300	.5236	—	—	43	60	2,3	107	45	14
4144463	VDS201A13400	4140203	VDS401A13400	13,400	.5276	—	—	43	60	2,3	107	45	14
4144464	VDS201A13500	4140204	VDS401A13500	13,500	.5315	—	—	43	60	2,3	107	45	14
4144465	VDS201A13600	4140205	VDS401A13600	13,600	.5354	—	—	43	60	2,3	107	45	14
4144466	VDS201A13700	4140206	VDS401A13700	13,700	.5394	—	—	43	60	2,4	107	45	14
4144467	VDS201A13800	4140207	VDS401A13800	13,800	.5433	—	—	43	60	2,4	107	45	14
4144468	VDS201A13891	—	—	13,891	.5469	35/64	—	43	60	2,4	107	45	14



VariDrill™ • 3 x D • VDS201A / VDS401A • A-Shank

(continued)

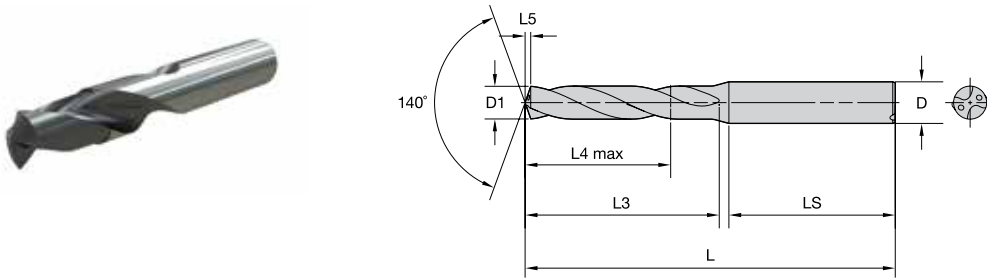

For information on L, L3, and L4 max, see page C46.

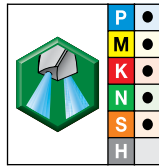
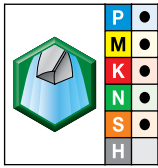

● first choice  
○ alternate choice

grade WU25PD TiAlN		grade WU25PD TiAlN		D1 diameter				L4 max	L3	L5	L	LS	D
order #	catalog #	order #	catalog #	mm	in	fraction	wire size						
4144469	VDS201A13900	4140209	VDS401A13900	13,900	.5472	—	—	43	60	2,4	107	45	14
4144470	VDS201A14000	4140210	VDS401A14000	14,000	.5512	—	—	43	60	2,4	107	45	14
4144471	VDS201A14100	4140211	VDS401A14100	14,100	.5551	—	—	45	65	2,4	115	48	16
4144472	VDS201A14200	4140212	VDS401A14200	14,200	.5591	—	—	45	65	2,5	115	48	16
4144473	VDS201A14288	4140213	VDS401A14288	14,288	.5625	9/16	—	45	65	2,5	115	48	16
4144474	VDS201A14300	4140214	VDS401A14300	14,300	.5630	—	—	45	65	2,5	115	48	16
4144475	VDS201A14400	4140215	VDS401A14400	14,400	.5669	—	—	45	65	2,5	115	48	16
4144476	VDS201A14500	4140216	VDS401A14500	14,500	.5709	—	—	45	65	2,5	115	48	16
4144477	VDS201A14600	4140217	VDS401A14600	14,600	.5748	—	—	45	65	2,5	115	48	16
4144478	VDS201A14684	4140218	VDS401A14684	14,684	.5781	37/64	—	45	65	2,5	115	48	16
4144479	VDS201A14700	4140219	VDS401A14700	14,700	.5787	—	—	45	65	2,5	115	48	16
4144480	VDS201A14800	4140220	VDS401A14800	14,800	.5827	—	—	45	65	2,6	115	48	16
4144481	VDS201A14900	4140221	VDS401A14900	14,900	.5866	—	—	45	65	2,6	115	48	16
4144482	VDS201A15000	4140222	VDS401A15000	15,000	.5906	—	—	45	65	2,6	115	48	16
4144483	VDS201A15083	4140223	VDS401A15083	15,083	.5938	19/32	—	45	65	2,6	115	48	16
4144484	VDS201A15100	4140224	VDS401A15100	15,100	.5945	—	—	45	65	2,6	115	48	16
4144485	VDS201A15200	4140225	VDS401A15200	15,200	.5984	—	—	45	65	2,6	115	48	16
4144486	VDS201A15300	4140226	VDS401A15300	15,300	.6024	—	—	45	65	2,6	115	48	16
4144487	VDS201A15400	4140227	VDS401A15400	15,400	.6063	—	—	45	65	2,7	115	48	16
4144488	VDS201A15479	4140228	VDS401A15479	15,479	.6094	39/64	—	45	65	2,7	115	48	16
4144489	VDS201A15500	4140229	VDS401A15500	15,500	.6102	—	—	45	65	2,7	115	48	16
4144490	VDS201A15600	4140230	VDS401A15600	15,600	.6142	—	—	45	65	2,7	115	48	16
4144491	VDS201A15700	4140231	VDS401A15700	15,700	.6181	—	—	45	65	2,7	115	48	16
4144492	VDS201A15800	4140232	VDS401A15800	15,800	.6220	—	—	45	65	2,7	115	48	16
4144493	VDS201A15875	4140233	VDS401A15875	15,875	.6250	5/8	—	45	65	2,8	115	48	16
4144494	VDS201A15900	4140234	VDS401A15900	15,900	.6260	—	—	45	65	2,8	115	48	16
4144495	VDS201A16000	4140235	VDS401A16000	16,000	.6299	—	—	45	65	2,8	115	48	16
4144496	VDS201A16100	4140236	VDS401A16100	16,100	.6339	—	—	51	73	2,8	123	48	18
4144497	VDS201A16200	4140237	VDS401A16200	16,200	.6378	—	—	51	73	2,8	123	48	18
4144498	VDS201A16271	—	—	16,271	.6406	41/64	—	51	73	2,8	123	48	18
4144499	VDS201A16300	4140239	VDS401A16300	16,300	.6417	—	—	51	73	2,8	123	48	18
4144500	VDS201A16400	4140241	VDS401A16400	16,400	.6457	—	—	51	73	2,8	123	48	18
4144501	VDS201A16500	4140242	VDS401A16500	16,500	.6496	—	—	51	73	2,9	123	48	18
4144503	VDS201A16600	4140243	VDS401A16600	16,600	.6535	—	—	51	73	2,9	123	48	18
4144504	VDS201A16670	4140244	VDS401A16670	16,670	.6563	21/32	—	51	73	2,9	123	48	18
4144505	VDS201A16700	4140245	VDS401A16700	16,700	.6575	—	—	51	73	2,9	123	48	18
4144506	VDS201A16800	4140246	VDS401A16800	16,800	.6614	—	—	51	73	2,9	123	48	18
4144507	VDS201A16900	4140247	VDS401A16900	16,900	.6654	—	—	51	73	2,9	123	48	18
4144508	VDS201A17000	—	—	17,000	.6693	—	—	51	73	3,0	123	48	18
—	—	4140248	VDS401A17000	17,000	.6693	—	—	51	73	2,9	123	48	18
4144509	VDS201A17100	4140249	VDS401A17100	17,100	.6732	—	—	51	73	3,0	123	48	18
4144510	VDS201A17200	4140250	VDS401A17200	17,200	.6772	—	—	51	73	3,0	123	48	18
4144511	VDS201A17300	4140251	VDS401A17300	17,300	.6811	—	—	51	73	3,0	123	48	18
4144512	VDS201A17400	4140252	VDS401A17400	17,400	.6850	—	—	51	73	3,0	123	48	18
4144513	VDS201A17463	4140253	VDS401A17463	17,463	.6875	11/16	—	51	73	3,0	123	48	18
4144514	VDS201A17500	4140254	VDS401A17500	17,500	.6890	—	—	51	73	3,0	123	48	18
4144515	VDS201A17600	4140255	VDS401A17600	17,600	.6929	—	—	51	73	3,1	123	48	18
4144516	VDS201A17700	4140256	VDS401A17700	17,700	.6969	—	—	51	73	3,1	123	48	18



## VariDrill • 3 x D • VDS201A / VDS401A • A-Shank

(continued)

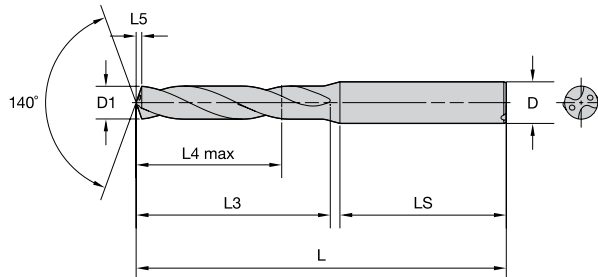

For information on L, L3, and L4 max, see page C46.

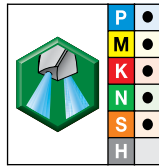
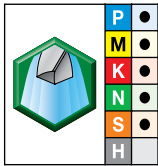

● first choice  
○ alternate choice

grade WU25PD TiAlN		grade WU25PD TiAlN		D1 diameter				L4 max	L3	L5	L	LS	D
order #	catalog #	order #	catalog #	mm	in	fraction	wire size						
4144517	VDS201A17800	4140257	VDS401A17800	17,800	.7008	—	—	51	73	3,1	123	48	18
4144518	VDS201A17859	—	—	17,859	.7031	45/64	—	51	73	3,1	123	48	18
4144519	VDS201A17900	—	—	17,900	.7047	—	—	51	73	3,1	123	48	18
4144590	VDS201A18000	4140449	VDS401A18000	18,000	.7087	—	—	51	73	3,1	123	48	18
4144591	VDS201A18100	4140450	VDS401A18100	18,100	.7126	—	—	55	79	3,1	131	50	20
4144592	VDS201A18200	4140451	VDS401A18200	18,200	.7165	—	—	55	79	3,2	131	50	20
4144593	VDS201A18258	4140452	VDS401A18258	18,258	.7188	23/32	—	55	79	3,2	131	50	20
4144594	VDS201A18300	4140463	VDS401A18300	18,300	.7205	—	—	55	79	3,2	131	50	20
—	—	4140464	VDS401A18400	18,400	.7244	—	—	55	79	3,2	131	50	20
4144596	VDS201A18500	4140465	VDS401A18500	18,500	.7283	—	—	55	79	3,2	131	50	20
4144597	VDS201A18600	4140466	VDS401A18600	18,600	.7323	—	—	55	79	3,2	131	50	20
4144598	VDS201A18654	4140467	VDS401A18654	18,654	.7344	47/64	—	55	79	3,2	131	50	20
4144599	VDS201A18700	—	—	18,700	.7362	—	—	55	79	3,3	131	50	20
—	—	4140468	VDS401A18700	18,700	.7362	—	—	55	79	3,2	131	50	20
4144600	VDS201A18800	4140469	VDS401A18800	18,800	.7402	—	—	55	79	3,3	131	50	20
4144601	VDS201A18900	4140470	VDS401A18900	18,900	.7441	—	—	55	79	3,3	131	50	20
4144602	VDS201A19000	4140471	VDS401A19000	19,000	.7480	—	—	55	79	3,3	131	50	20
4144603	VDS201A19050	4140472	VDS401A19050	19,050	.7500	3/4	—	55	79	3,3	131	50	20
4144604	VDS201A19100	4140473	VDS401A19100	19,100	.7520	—	—	55	79	3,3	131	50	20
4144605	VDS201A19200	4140474	VDS401A19200	19,200	.7559	—	—	55	79	3,3	131	50	20
4144606	VDS201A19300	4140475	VDS401A19300	19,300	.7598	—	—	55	79	3,4	131	50	20
4144607	VDS201A19400	4140476	VDS401A19400	19,400	.7638	—	—	55	79	3,4	131	50	20
4144608	VDS201A19500	4140477	VDS401A19500	19,500	.7677	—	—	55	79	3,4	131	50	20
—	—	4140478	VDS401A19600	19,600	.7717	—	—	55	79	3,4	131	50	20
4144610	VDS201A19700	4140479	VDS401A19700	19,700	.7756	—	—	55	79	3,4	131	50	20
4144611	VDS201A19800	4140480	VDS401A19800	19,800	.7795	—	—	55	79	3,4	131	50	20
4144612	VDS201A19900	4140481	VDS401A19900	19,900	.7835	—	—	55	79	3,5	131	50	20
4144613	VDS201A20000	4140482	VDS401A20000	20,000	.7874	—	—	55	79	3,5	131	50	20

INDEXABLE MILLING

SOLID END MILLING

HOLEMAKING

TAPPING

TURNING

VariDrill • 5 x D • VDS202A / VDS402A • A-Shank

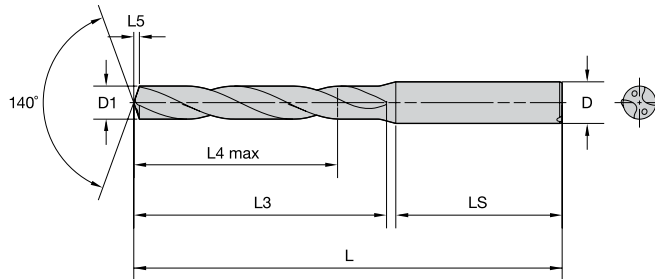

For information on L, L3, and L4 max, see page C46.

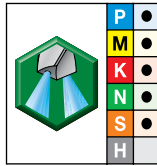
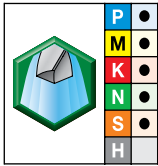

● first choice

○ alternate choice

grade WU25PD TiAlN		grade WU25PD TiAlN		D1 diameter									
order #	catalog #	order #	catalog #	mm	in	fraction	wire size	L4 max	L3	L5	L	LS	D
4148000	VDS202A01000	-	-	1,000	.0394	-	-	6	9	0,1	58	28	4
4148001	VDS202A01016	-	-	1,016	.0400	-	-	6	9	0,1	58	28	4
4148002	VDS202A01041	-	-	1,041	.0410	-	-	6	9	0,2	58	28	4
4148003	VDS202A01067	-	-	1,067	.0420	-	-	6	9	0,2	58	28	4
4148005	VDS202A01100	-	-	1,100	.0433	-	-	6	9	0,2	58	28	4
4148006	VDS202A01181	-	-	1,181	.0465	-	-	6	9	0,2	58	28	4
4148007	VDS202A01191	-	-	1,191	.0469	3/64	-	6	9	0,2	58	28	4
4148008	VDS202A01200	-	-	1,200	.0472	-	-	6	9	0,2	58	28	4
4148009	VDS202A01300	-	-	1,300	.0512	-	-	6	9	0,2	58	28	4
4148010	VDS202A01321	-	-	1,321	.0520	-	-	6	9	0,2	58	28	4
4148011	VDS202A01397	-	-	1,397	.0550	-	-	6	9	0,2	58	28	4
4148012	VDS202A01400	-	-	1,400	.0551	-	-	6	9	0,2	58	28	4
4148013	VDS202A01500	4142871	VDS402A01500	1,500	.0591	-	-	9	12	0,2	58	28	4
4148014	VDS202A01600	4142884	VDS402A01600	1,600	.0630	-	-	9	12	0,2	58	28	4
4148015	VDS202A01700	4142887	VDS402A01700	1,700	.0669	-	-	9	12	0,3	58	28	4
4148016	VDS202A01800	4142890	VDS402A01800	1,800	.0709	-	-	9	12	0,3	58	28	4
4148017	VDS202A01900	4142893	VDS402A01900	1,900	.0748	-	-	9	12	0,3	58	28	4
4148018	VDS202A01984	4142896	VDS402A01984	1,984	.0781	5/64	-	14	18	0,3	58	28	4
4148019	VDS202A02000	4142899	VDS402A02000	2,000	.0787	-	-	14	18	0,3	58	28	4
4148020	VDS202A02100	4142902	VDS402A02100	2,100	.0827	-	-	14	18	0,3	58	28	4
4148021	VDS202A02200	4142905	VDS402A02200	2,200	.0866	-	-	14	18	0,3	58	28	4
4148022	VDS202A02300	4142908	VDS402A02300	2,300	.0906	-	-	14	18	0,4	58	28	4
4148023	VDS202A02383	4142911	VDS402A02383	2,383	.0938	3/32	-	17	22	0,4	58	28	4
4148024	VDS202A02400	4142924	VDS402A02400	2,400	.0945	-	-	17	22	0,4	58	28	4
4148025	VDS202A02439	4142927	VDS402A02439	2,439	.0960	-	41	17	22	0,4	58	28	4
4148026	VDS202A02489	4142930	VDS402A02489	2,489	.0980	-	40	17	22	0,4	58	28	4
4148027	VDS202A02500	4142933	VDS402A02500	2,500	.0984	-	-	17	22	0,4	58	28	4
4148028	VDS202A02578	4142936	VDS402A02578	2,578	.1015	-	38	17	22	0,4	58	28	4
4148029	VDS202A02600	4142939	VDS402A02600	2,600	.1024	-	-	17	22	0,4	58	28	4
4148030	VDS202A02642	4142942	VDS402A02642	2,642	.1040	-	37	17	22	0,4	58	28	4
4148031	VDS202A02700	4142945	VDS402A02700	2,700	.1063	-	-	17	22	0,4	58	28	4
4148032	VDS202A02705	-	-	2,705	.1065	-	36	17	22	0,4	58	28	4
4148033	VDS202A02779	4142951	VDS402A02779	2,779	.1094	7/64	-	17	22	0,4	58	28	4
4148034	VDS202A02800	4142964	VDS402A02800	2,800	.1102	-	-	17	22	0,5	58	28	4
4148035	VDS202A02820	4142967	VDS402A02820	2,820	.1110	-	34	17	22	0,5	58	28	4
4148036	VDS202A02870	4142970	VDS402A02870	2,870	.1130	-	33	17	22	0,5	58	28	4
4148037	VDS202A02900	4142973	VDS402A02900	2,900	.1142	-	-	17	22	0,5	58	28	4
4148038	VDS202A02947	4142976	VDS402A02947	2,947	.1160	-	32	17	22	0,5	58	28	4
4148142	VDS202A03000	4142844	VDS402A03000	3,000	.1181	-	-	23	28	0,5	66	36	6
4148143	VDS202A03048	4142846	VDS402A03048	3,048	.1200	-	31	23	28	0,5	66	36	6
4148144	VDS202A03100	4142847	VDS402A03100	3,100	.1220	-	-	23	28	0,5	66	36	6
4148145	VDS202A03175	4142849	VDS402A03175	3,175	.1250	1/8	-	23	28	0,5	66	36	6
4148146	VDS202A03200	4142851	VDS402A03200	3,200	.1260	-	-	23	28	0,5	66	36	6
4148147	VDS202A03264	4142864	VDS402A03264	3,264	.1285	-	30	23	28	0,5	66	36	6
4148148	VDS202A03300	4142865	VDS402A03300	3,300	.1299	-	-	23	28	0,5	66	36	6
4148149	VDS202A03400	4142867	VDS402A03400	3,400	.1339	-	-	23	28	0,6	66	36	6
4148150	VDS202A03455	4142869	VDS402A03455	3,455	.1360	-	29	23	28	0,6	66	36	6
4148151	VDS202A03500	4142872	VDS402A03500	3,500	.1378	-	-	23	28	0,6	66	36	6

INDEXABLE MILLING

SOLID END MILLING

HOLEMAKING

TAPPING

TURNING

## VariDrill • 5 x D • VDS202A / VDS402A • A-Shank

INDEXABLE MILLING

SOLID END MILLING

HOLEMAKING

TAPPING

TURNING

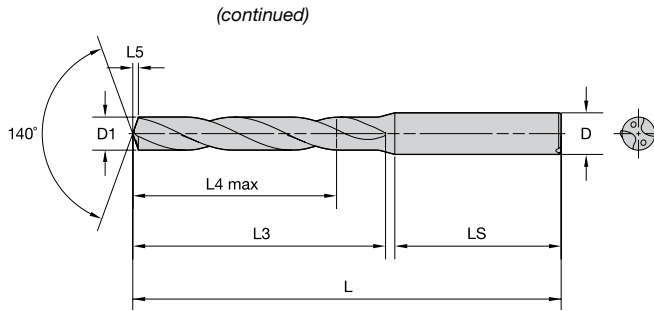

For information on L, L3, and L4 max, see page C46.

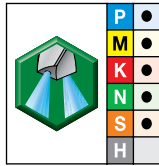
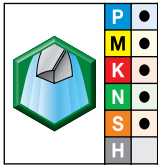

● first choice  
○ alternate choice

grade WU25PD TiAlN		grade WU25PD TiAlN		D1 diameter									
order #	catalog #	order #	catalog #	mm	in	fraction	wire size	L4 max	L3	L5	L	LS	D
4148152	VDS202A03571	4142885	VDS402A03571	3,571	.1406	9/64	—	23	28	0,6	66	36	6
4148153	VDS202A03600	4142888	VDS402A03600	3,600	.1417	—	—	23	28	0,6	66	36	6
4148154	VDS202A03658	4142891	VDS402A03658	3,658	.1440	—	27	23	28	0,6	66	36	6
4148155	VDS202A03700	4142894	VDS402A03700	3,700	.1457	—	—	23	28	0,6	66	36	6
4148156	VDS202A03734	4142897	VDS402A03734	3,734	.1470	—	26	23	28	0,6	66	36	6
4148157	VDS202A03800	4142900	VDS402A03800	3,800	.1496	—	—	29	36	0,6	74	36	6
4148158	VDS202A03900	4142903	VDS402A03900	3,900	.1535	—	—	29	36	0,6	74	36	6
4148159	VDS202A03970	4142906	VDS402A03970	3,970	.1563	5/32	—	29	36	0,7	74	36	6
4148160	VDS202A04000	4142909	VDS402A04000	4,000	.1575	—	—	29	36	0,7	74	36	6
4148161	VDS202A04039	4142912	VDS402A04039	4,039	.1590	—	21	29	36	0,7	74	36	6
4148162	VDS202A04090	4142925	VDS402A04090	4,090	.1610	—	20	29	36	0,7	74	36	6
4148163	VDS202A04100	4142928	VDS402A04100	4,100	.1614	—	—	29	36	0,7	74	36	6
4148164	VDS202A04200	4142931	VDS402A04200	4,200	.1654	—	—	29	36	0,7	74	36	6
4148165	VDS202A04217	4142934	VDS402A04217	4,217	.1660	—	19	29	36	0,7	74	36	6
4148166	VDS202A04300	4142937	VDS402A04300	4,300	.1693	—	—	29	36	0,7	74	36	6
4148167	VDS202A04366	4142940	VDS402A04366	4,366	.1719	11/64	—	29	36	0,7	74	36	6
4148168	VDS202A04400	4142943	VDS402A04400	4,400	.1732	—	—	29	36	0,7	74	36	6
4148169	VDS202A04500	4142946	VDS402A04500	4,500	.1772	—	—	29	36	0,7	74	36	6
4148170	VDS202A04600	4142949	VDS402A04600	4,600	.1811	—	—	29	36	0,8	74	36	6
4148171	VDS202A04623	4142952	VDS402A04623	4,623	.1820	—	14	29	36	0,8	74	36	6
4148172	VDS202A04700	4142965	VDS402A04700	4,700	.1850	—	13	29	36	0,8	74	36	6
4148173	VDS202A04763	4142968	VDS402A04763	4,763	.1875	3/16	—	35	44	0,8	82	36	6
4148174	VDS202A04800	4142971	VDS402A04800	4,800	.1890	—	12	35	44	0,8	82	36	6
4148175	VDS202A04852	4142974	VDS402A04852	4,852	.1910	—	11	35	44	0,8	82	36	6
4148176	VDS202A04900	4142977	VDS402A04900	4,900	.1929	—	—	35	44	0,8	82	36	6
4148177	VDS202A05000	4142979	VDS402A05000	5,000	.1969	—	—	35	44	0,8	82	36	6
4148178	VDS202A05100	4142981	VDS402A05100	5,100	.2008	—	—	35	44	0,9	82	36	6
4148179	VDS202A05106	4142984	VDS402A05106	5,106	.2010	—	7	35	44	0,9	82	36	6
4148180	VDS202A05159	4142996	VDS402A05159	5,159	.2031	13/64	—	35	44	0,9	82	36	6
4148181	VDS202A05200	4142997	VDS402A05200	5,200	.2047	—	—	35	44	0,9	82	36	6
4148182	VDS202A05300	4142999	VDS402A05300	5,300	.2087	—	—	35	44	0,9	82	36	6
4148183	VDS202A05400	4143000	VDS402A05400	5,400	.2126	—	—	35	44	0,9	82	36	6
4148184	VDS202A05410	4143001	VDS402A05410	5,410	.2130	—	3	35	44	0,9	82	36	6
4148185	VDS202A05500	4143002	VDS402A05500	5,500	.2165	—	—	35	44	0,9	82	36	6
4148186	VDS202A05558	4143003	VDS402A05558	5,558	.2188	7/32	—	35	44	0,9	82	36	6
4148187	VDS202A05600	4143004	VDS402A05600	5,600	.2205	—	—	35	44	0,9	82	36	6
4148188	VDS202A05616	4143005	VDS402A05616	5,616	.2211	—	2	35	44	0,9	82	36	6
4148189	VDS202A05700	4143006	VDS402A05700	5,700	.2244	—	—	35	44	1,0	82	36	6
4148190	VDS202A05800	4143007	VDS402A05800	5,800	.2283	—	—	35	44	1,0	82	36	6
4148191	VDS202A05900	4143008	VDS402A05900	5,900	.2323	—	—	35	44	1,0	82	36	6
4148192	VDS202A05954	4143009	VDS402A05954	5,954	.2344	15/64	—	35	44	1,0	82	36	6
4148193	VDS202A06000	4143010	VDS402A06000	6,000	.2362	—	—	35	44	1,0	82	36	6
4148194	VDS202A06100	4143011	VDS402A06100	6,100	.2402	—	—	43	53	1,0	91	36	8
4148195	VDS202A06200	4143012	VDS402A06200	6,200	.2441	—	—	43	53	1,0	91	36	8
4148196	VDS202A06300	4143023	VDS402A06300	6,300	.2480	—	—	43	53	1,1	91	36	8
4148197	VDS202A06350	4143024	VDS402A06350	6,350	.2500	1/4	E	43	53	1,1	91	36	8
4148198	VDS202A06400	4143025	VDS402A06400	6,400	.2520	—	—	43	53	1,1	91	36	8
4148199	VDS202A06500	4143026	VDS402A06500	6,500	.2559	—	—	43	53	1,1	91	36	8

VariDrill • 5 x D • VDS202A / VDS402A • A-Shank

(continued)

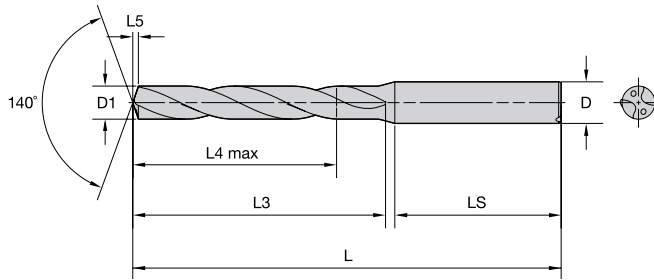

For information on L, L3, and L4 max, see page C46.

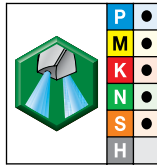
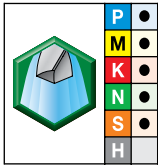

● first choice

○ alternate choice

grade WU25PD TiAlN		grade WU25PD TiAlN		D1 diameter									
order #	catalog #	order #	catalog #	mm	in	fraction	wire size	L4 max	L3	L5	L	LS	D
4148200	VDS202A06528	4143027	VDS402A06528	6,528	.2570	—	F	43	53	1,1	91	36	8
4148201	VDS202A06600	4143028	VDS402A06600	6,600	.2598	—	—	43	53	1,1	91	36	8
4148202	VDS202A06630	4143029	VDS402A06630	6,630	.2610	—	G	43	53	1,1	91	36	8
4148203	VDS202A06700	4143030	VDS402A06700	6,700	.2638	—	—	43	53	1,1	91	36	8
4148204	VDS202A06746	4143031	VDS402A06746	6,746	.2656	17/64	—	43	53	1,1	91	36	8
4148205	VDS202A06800	4143032	VDS402A06800	6,800	.2677	—	—	43	53	1,1	91	36	8
4148206	VDS202A06900	4143043	VDS402A06900	6,900	.2717	—	—	43	53	1,2	91	36	8
4148207	VDS202A07000	4143044	VDS402A07000	7,000	.2756	—	—	43	53	1,2	91	36	8
4148208	VDS202A07100	4143045	VDS402A07100	7,100	.2795	—	—	43	53	1,2	91	36	8
4148209	VDS202A07145	4143046	VDS402A07145	7,145	.2813	9/32	—	43	53	1,2	91	36	8
4148210	VDS202A07200	4143047	VDS402A07200	7,200	.2835	—	—	43	53	1,2	91	36	8
4148211	VDS202A07300	4143048	VDS402A07300	7,300	.2874	—	—	43	53	1,2	91	36	8
4148212	VDS202A07400	4143049	VDS402A07400	7,400	.2913	—	—	43	53	1,3	91	36	8
4148213	VDS202A07500	4143050	VDS402A07500	7,500	.2953	—	—	43	53	1,3	91	36	8
4148214	VDS202A07541	4143051	VDS402A07541	7,541	.2969	19/64	—	43	53	1,3	91	36	8
4148215	VDS202A07600	4143052	VDS402A07600	7,600	.2992	—	—	43	53	1,3	91	36	8
4148216	VDS202A07700	4143063	VDS402A07700	7,700	.3031	—	—	43	53	1,3	91	36	8
4148217	VDS202A07800	4143064	VDS402A07800	7,800	.3071	—	—	43	53	1,3	91	36	8
4148218	VDS202A07900	4143065	VDS402A07900	7,900	.3110	—	—	43	53	1,3	91	36	8
4148219	VDS202A07938	4143066	VDS402A07938	7,938	.3125	5/16	—	43	53	1,3	91	36	8
4148220	VDS202A08000	4143067	VDS402A08000	8,000	.3150	—	—	43	53	1,4	91	36	8
4148221	VDS202A08100	4143068	VDS402A08100	8,100	.3189	—	—	49	61	1,4	103	40	10
4148222	VDS202A08200	4143069	VDS402A08200	8,200	.3228	—	—	49	61	1,4	103	40	10
4148223	VDS202A08300	4143070	VDS402A08300	8,300	.3268	—	—	49	61	1,4	103	40	10
4148224	VDS202A08334	4143071	VDS402A08334	8,334	.3281	21/64	—	49	61	1,4	103	40	10
4148225	VDS202A08400	4143072	VDS402A08400	8,400	.3307	—	—	49	61	1,4	103	40	10
4148226	VDS202A08433	4143083	VDS402A08433	8,433	.3320	—	Q	49	61	1,4	103	40	10
4148227	VDS202A08500	4143084	VDS402A08500	8,500	.3346	—	—	49	61	1,4	103	40	10
4148228	VDS202A08600	4143085	VDS402A08600	8,600	.3386	—	—	49	61	1,5	103	40	10
4148229	VDS202A08700	4143086	VDS402A08700	8,700	.3425	—	—	49	61	1,5	103	40	10
4148230	VDS202A08733	4143087	VDS402A08733	8,733	.3438	11/32	—	49	61	1,5	103	40	10
4148231	VDS202A08800	4143088	VDS402A08800	8,800	.3465	—	—	49	61	1,5	103	40	10
4148232	VDS202A08900	4143089	VDS402A08900	8,900	.3504	—	—	49	61	1,5	103	40	10
4148233	VDS202A09000	4143090	VDS402A09000	9,000	.3543	—	—	49	61	1,5	103	40	10
4148234	VDS202A09100	4143091	VDS402A09100	9,100	.3583	—	—	49	61	1,6	103	40	10
4148235	VDS202A09129	4143092	VDS402A09129	9,129	.3594	23/64	—	49	61	1,6	103	40	10
4148236	VDS202A09200	4143103	VDS402A09200	9,200	.3622	—	—	49	61	1,6	103	40	10
4148237	VDS202A09300	4143104	VDS402A09300	9,300	.3661	—	—	49	61	1,6	103	40	10
4148238	VDS202A09347	4143105	VDS402A09347	9,347	.3680	—	U	49	61	1,6	103	40	10
4148239	VDS202A09400	4143106	VDS402A09400	9,400	.3701	—	—	49	61	1,6	103	40	10
4148240	VDS202A09500	4143107	VDS402A09500	9,500	.3740	—	—	49	61	1,6	103	40	10
4148241	VDS202A09525	4143108	VDS402A09525	9,525	.3750	3/8	—	49	61	1,6	103	40	10
4148242	VDS202A09600	4143109	VDS402A09600	9,600	.3780	—	—	49	61	1,6	103	40	10
4148243	VDS202A09700	4143110	VDS402A09700	9,700	.3819	—	—	49	61	1,7	103	40	10
4148244	VDS202A09800	4143111	VDS402A09800	9,800	.3858	—	—	49	61	1,7	103	40	10
4148245	VDS202A09900	4143112	VDS402A09900	9,900	.3898	—	—	49	61	1,7	103	40	10
4148246	VDS202A09921	4143113	VDS402A09921	9,921	.3906	25/64	—	49	61	1,7	103	40	10
4148258	VDS202A10000	4142823	VDS402A10000	10,000	.3937	—	—	49	61	1,7	103	40	10

INDEXABLE MILLING

SOLID END MILLING

HOLEMAKING

TAPPING

TURNING

## VariDrill • 5 x D • VDS202A / VDS402A • A-Shank

(continued)

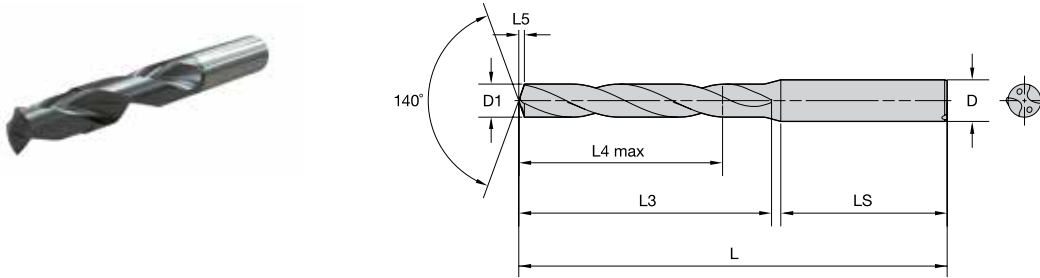

For information on L, L3, and L4 max, see page C46.

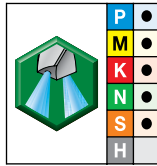
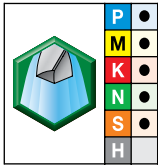

● first choice

○ alternate choice

grade WU25PD TiAlN		grade WU25PD TiAlN		D1 diameter				L4 max	L3	L5	L	LS	D
order #	catalog #	order #	catalog #	mm	in	fraction	wire size						
4148259	VDS202A10100	4142825	VDS402A10100	10,100	.3976	—	—	56	71	1,7	118	45	12
4148260	VDS202A10200	4142827	VDS402A10200	10,200	.4016	—	—	56	71	1,7	118	45	12
4148261	VDS202A10300	4142829	VDS402A10300	10,300	.4055	—	—	56	71	1,8	118	45	12
4148262	VDS202A10320	4142831	VDS402A10320	10,320	.4063	13/32	—	56	71	1,8	118	45	12
4148283	VDS202A10400	4142832	VDS402A10400	10,400	.4094	—	—	56	71	1,8	118	45	12
4148284	VDS202A10500	4142834	VDS402A10500	10,500	.4134	—	—	56	71	1,8	118	45	12
4148285	VDS202A10600	4142836	VDS402A10600	10,600	.4173	—	—	56	71	1,8	118	45	12
4148286	VDS202A10700	4142838	VDS402A10700	10,700	.4213	—	—	56	71	1,8	118	45	12
4148287	VDS202A10716	4142840	VDS402A10716	10,716	.4219	27/64	—	56	71	1,8	118	45	12
4148288	VDS202A10800	4142842	VDS402A10800	10,800	.4252	—	—	56	71	1,9	118	45	12
4148289	VDS202A10900	4142855	VDS402A10900	10,900	.4291	—	—	56	71	1,9	118	45	12
4148290	VDS202A11000	4142857	VDS402A11000	11,000	.4331	—	—	56	71	1,9	118	45	12
4148291	VDS202A11100	4142858	VDS402A11100	11,100	.4370	—	—	56	71	1,9	118	45	12
4148292	VDS202A11113	4142861	VDS402A11113	11,113	.4375	7/16	—	56	71	1,9	118	45	12
4148293	VDS202A11200	4142862	VDS402A11200	11,200	.4409	—	—	56	71	1,9	118	45	12
4148294	VDS202A11300	4142873	VDS402A11300	11,300	.4449	—	—	56	71	1,9	118	45	12
4148295	VDS202A11400	4142874	VDS402A11400	11,400	.4488	—	—	56	71	2,0	118	45	12
4148296	VDS202A11500	4142875	VDS402A11500	11,500	.4528	—	—	56	71	2,0	118	45	12
4148297	VDS202A11509	4142876	VDS402A11509	11,509	.4531	29/64	—	56	71	2,0	118	45	12
4148298	VDS202A11600	4142877	VDS402A11600	11,600	.4567	—	—	56	71	2,0	118	45	12
4148299	VDS202A11700	4142878	VDS402A11700	11,700	.4606	—	—	56	71	2,0	118	45	12
4148300	VDS202A11800	4142879	VDS402A11800	11,800	.4646	—	—	56	71	2,0	118	45	12
4148301	VDS202A11900	4142880	VDS402A11900	11,900	.4685	—	—	56	71	2,0	118	45	12
4148302	VDS202A11908	4142881	VDS402A11908	11,908	.4688	15/32	—	56	71	2,0	118	45	12
4148313	VDS202A12000	4142882	VDS402A12000	12,000	.4724	—	—	56	71	2,1	118	45	12
4148314	VDS202A12100	4142913	VDS402A12100	12,100	.4764	—	—	60	77	2,1	124	45	14
4148315	VDS202A12200	4142914	VDS402A12200	12,200	.4803	—	—	60	77	2,1	124	45	14
4148316	VDS202A12300	4142915	VDS402A12300	12,300	.4843	—	—	60	77	2,1	124	45	14
4148317	VDS202A12304	4142916	VDS402A12304	12,304	.4844	31/64	—	60	77	2,1	124	45	14
4148318	VDS202A12400	4142917	VDS402A12400	12,400	.4882	—	—	60	77	2,1	124	45	14
4148319	VDS202A12500	4142918	VDS402A12500	12,500	.4921	—	—	60	77	2,2	124	45	14
4148320	VDS202A12600	4142919	VDS402A12600	12,600	.4961	—	—	60	77	2,2	124	45	14
4148321	VDS202A12700	4142920	VDS402A12700	12,700	.5000	1/2	—	60	77	2,2	124	45	14
4148322	VDS202A12800	4142921	VDS402A12800	12,800	.5039	—	—	60	77	2,2	124	45	14
4148343	VDS202A12900	4142922	VDS402A12900	12,900	.5079	—	—	60	77	2,2	124	45	14
4148344	VDS202A13000	4142953	VDS402A13000	13,000	.5118	—	—	60	77	2,2	124	45	14
4148345	VDS202A13096	4142954	VDS402A13096	13,096	.5156	33/64	—	60	77	2,3	124	45	14
4148346	VDS202A13100	4142955	VDS402A13100	13,100	.5157	—	—	60	77	2,3	124	45	14
4148347	VDS202A13200	4142956	VDS402A13200	13,200	.5197	—	—	60	77	2,3	124	45	14
4148348	VDS202A13300	4142957	VDS402A13300	13,300	.5236	—	—	60	77	2,3	124	45	14
4148349	VDS202A13400	4142958	VDS402A13400	13,400	.5276	—	—	60	77	2,3	124	45	14
4148350	VDS202A13500	4142959	VDS402A13500	13,500	.5315	—	—	60	77	2,3	124	45	14
4148351	VDS202A13600	4142960	VDS402A13600	13,600	.5354	—	—	60	77	2,3	124	45	14
4148352	VDS202A13700	4142961	VDS402A13700	13,700	.5394	—	—	60	77	2,4	124	45	14
4148353	VDS202A13800	4142962	VDS402A13800	13,800	.5433	—	—	60	77	2,4	124	45	14
4148354	VDS202A13891	4142983	VDS402A13891	13,891	.5469	35/64	—	60	77	2,4	124	45	14
4148355	VDS202A13900	4142984	VDS402A13900	13,900	.5472	—	—	60	77	2,4	124	45	14
4148356	VDS202A14000	4142985	VDS402A14000	14,000	.5512	—	—	60	77	2,4	124	45	14



VariDrill • 5 x D • VDS202A / VDS402A • A-Shank

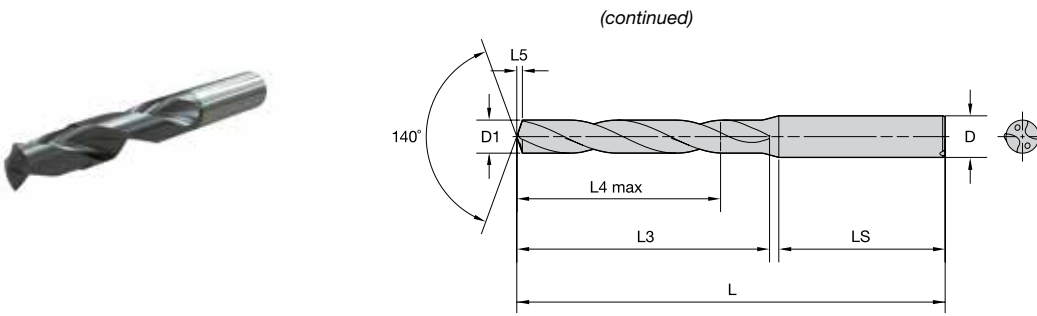

For information on L, L3, and L4 max, see page C46.

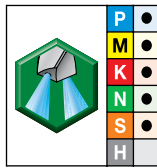
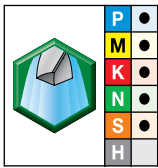

● first choice  
○ alternate choice

grade WU25PD TiAlN		grade WU25PD TiAlN		D1 diameter				L4 max	L3	L5	L	LS	D
order #	catalog #	order #	catalog #	mm	in	fraction	wire size						
4148357	VDS202A14100	4142986	VDS402A14100	14,100	.5551	—	—	63	83	2,4	133	48	16
4148358	VDS202A14200	4142987	VDS402A14200	14,200	.5591	—	—	63	83	2,5	133	48	16
4148359	VDS202A14288	4142988	VDS402A14288	14,288	.5625	9/16	—	63	83	2,5	133	48	16
4148360	VDS202A14300	4142989	VDS402A14300	14,300	.5630	—	—	63	83	2,5	133	48	16
4148361	VDS202A14400	4142990	VDS402A14400	14,400	.5669	—	—	63	83	2,5	133	48	16
4148362	VDS202A14500	4142991	VDS402A14500	14,500	.5709	—	—	63	83	2,5	133	48	16
4148363	VDS202A14600	4142992	VDS402A14600	14,600	.5748	—	—	63	83	2,5	133	48	16
4148364	VDS202A14684	4143013	VDS402A14684	14,684	.5781	37/64	—	63	83	2,5	133	48	16
4148365	VDS202A14700	4143014	VDS402A14700	14,700	.5787	—	—	63	83	2,5	133	48	16
4148366	VDS202A14800	4143015	VDS402A14800	14,800	.5827	—	—	63	83	2,6	133	48	16
4148367	VDS202A14900	4143016	VDS402A14900	14,900	.5866	—	—	63	83	2,6	133	48	16
4148368	VDS202A15000	4143017	VDS402A15000	15,000	.5906	—	—	63	83	2,6	133	48	16
4148369	VDS202A15083	4143018	VDS402A15083	15,083	.5938	19/32	—	63	83	2,6	133	48	16
4148370	VDS202A15100	4143019	VDS402A15100	15,100	.5945	—	—	63	83	2,6	133	48	16
4148371	VDS202A15200	4143020	VDS402A15200	15,200	.5984	—	—	63	83	2,6	133	48	16
4148372	VDS202A15300	4143021	VDS402A15300	15,300	.6024	—	—	63	83	2,6	133	48	16
—	—	4143022	VDS402A15400	15,400	.6063	—	—	63	83	2,7	133	48	16
—	—	4143033	VDS402A15479	15,479	.6094	39/64	—	63	83	2,7	133	48	16
4148375	VDS202A15500	4143034	VDS402A15500	15,500	.6102	—	—	63	83	2,7	133	48	16
4148376	VDS202A15600	4143035	VDS402A15600	15,600	.6142	—	—	63	83	2,7	133	48	16
4148377	VDS202A15700	4143036	VDS402A15700	15,700	.6181	—	—	63	83	2,7	133	48	16
4148378	VDS202A15800	4143037	VDS402A15800	15,800	.6220	—	—	63	83	2,7	133	48	16
4148379	VDS202A15875	4143038	VDS402A15875	15,875	.6250	5/8	—	63	83	2,8	133	48	16
4148380	VDS202A15900	4143039	VDS402A15900	15,900	.6260	—	—	63	83	2,8	133	48	16
4148381	VDS202A16000	4143040	VDS402A16000	16,000	.6299	—	—	63	83	2,8	133	48	16
4148382	VDS202A16100	4143041	VDS402A16100	16,100	.6339	—	—	71	93	2,8	143	48	18
4148383	VDS202A16200	4143042	VDS402A16200	16,200	.6378	—	—	71	93	2,8	143	48	18
4148384	VDS202A16271	4143053	VDS402A16271	16,271	.6406	41/64	—	71	93	2,8	143	48	18
4148385	VDS202A16300	4143054	VDS402A16300	16,300	.6417	—	—	71	93	2,8	143	48	18
—	—	4143055	VDS402A16400	16,400	.6457	—	—	71	93	2,8	143	48	18
4148387	VDS202A16500	4143056	VDS402A16500	16,500	.6496	—	—	71	93	2,9	143	48	18
4148388	VDS202A16600	4143057	VDS402A16600	16,600	.6535	—	—	71	93	2,9	143	48	18
4148389	VDS202A16670	4143058	VDS402A16670	16,670	.6563	21/32	—	71	93	2,9	143	48	18
—	—	4143059	VDS402A16700	16,700	.6575	—	—	71	93	2,9	143	48	18
4148391	VDS202A16800	4143060	VDS402A16800	16,800	.6614	—	—	71	93	2,9	143	48	18
—	—	4143061	VDS402A16900	16,900	.6654	—	—	71	93	2,9	143	48	18
4148393	VDS202A17000	4143062	VDS402A17000	17,000	.6693	—	—	71	93	3,0	143	48	18
4148394	VDS202A17100	4143073	VDS402A17100	17,100	.6732	—	—	71	93	3,0	143	48	18
—	—	4143074	VDS402A17200	17,200	.6772	—	—	71	93	3,0	143	48	18
4148396	VDS202A17300	4143075	VDS402A17300	17,300	.6811	—	—	71	93	3,0	143	48	18
—	—	4143076	VDS402A17400	17,400	.6850	—	—	71	93	3,0	143	48	18
4148398	VDS202A17463	4143077	VDS402A17463	17,463	.6875	11/16	—	71	93	3,0	143	48	18
4148399	VDS202A17500	4143078	VDS402A17500	17,500	.6890	—	—	71	93	3,0	143	48	18
4148400	VDS202A17600	4143079	VDS402A17600	17,600	.6929	—	—	71	93	3,1	143	48	18
4148401	VDS202A17700	4143080	VDS402A17700	17,700	.6969	—	—	71	93	3,1	143	48	18
4148402	VDS202A17800	4143081	VDS402A17800	17,800	.7008	—	—	71	93	3,1	143	48	18
—	—	4143082	VDS402A17859	17,859	.7031	45/64	—	71	93	3,1	143	48	18
—	—	4143093	VDS402A17900	17,900	.7047	—	—	71	93	3,1	143	48	18

## VariDrill • 5 x D • VDS202A / VDS402A • A-Shank

(continued)

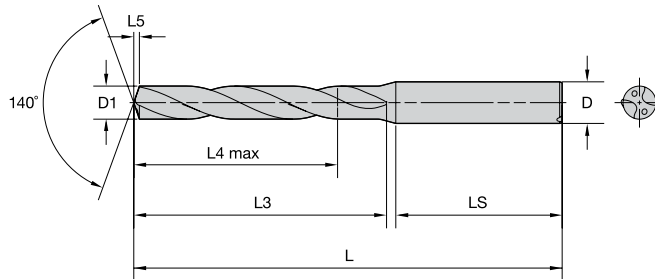

For information on L, L3, and L4 max, see page C46.

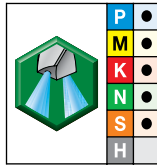
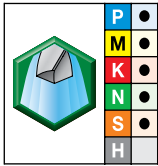

● first choice  
○ alternate choice

grade WU25PD TiAlN		grade WU25PD TiAlN		D1 diameter				L4 max	L3	L5	L	LS	D
order #	catalog #	order #	catalog #	mm	in	fraction	wire size						
4147921	VDS202A18000	4142803	VDS402A18000	18,000	.7087	—	—	71	93	3,1	143	48	18
4147922	VDS202A18100	4142804	VDS402A18100	18,100	.7126	—	—	77	101	3,1	153	50	20
4148303	VDS202A18200	4142805	VDS402A18200	18,200	.7165	—	—	77	101	3,2	153	50	20
4148304	VDS202A18258	4142806	VDS402A18258	18,258	.7188	23/32	—	77	101	3,2	153	50	20
—	—	4142807	VDS402A18300	18,300	.7205	—	—	77	101	3,2	153	50	20
—	—	4142808	VDS402A18400	18,400	.7244	—	—	77	101	3,2	153	50	20
4148307	VDS202A18500	4142809	VDS402A18500	18,500	.7283	—	—	77	101	3,2	153	50	20
—	—	4142810	VDS402A18600	18,600	.7323	—	—	77	101	3,2	153	50	20
—	—	4142811	VDS402A18654	18,654	.7344	47/64	—	77	101	3,2	153	50	20
—	—	4142812	VDS402A18700	18,700	.7362	—	—	77	101	3,3	153	50	20
4148311	VDS202A18800	4142824	VDS402A18800	18,800	.7402	—	—	77	101	3,3	153	50	20
—	—	4142826	VDS402A18900	18,900	.7441	—	—	77	101	3,3	153	50	20
4148323	VDS202A19000	4142828	VDS402A19000	19,000	.7480	—	—	77	101	3,3	153	50	20
4148324	VDS202A19050	4142830	VDS402A19050	19,050	.7500	3/4	—	77	101	3,3	153	50	20
4148325	VDS202A19100	4142833	VDS402A19100	19,100	.7520	—	—	77	101	3,3	153	50	20
—	—	4142835	VDS402A19200	19,200	.7559	—	—	77	101	3,3	153	50	20
4148327	VDS202A19300	4142837	VDS402A19300	19,300	.7598	—	—	77	101	3,4	153	50	20
4148328	VDS202A19400	4142839	VDS402A19400	19,400	.7638	—	—	77	101	3,4	153	50	20
4148329	VDS202A19500	4142841	VDS402A19500	19,500	.7677	—	—	77	101	3,4	153	50	20
—	—	4142853	VDS402A19600	19,600	.7717	—	—	77	101	3,4	153	50	20
—	—	4142854	VDS402A19700	19,700	.7756	—	—	77	101	3,4	153	50	20
4148332	VDS202A19800	4142856	VDS402A19800	19,800	.7795	—	—	77	101	3,4	153	50	20
4148333	VDS202A19900	4142859	VDS402A19900	19,900	.7835	—	—	77	101	3,5	153	50	20
4148334	VDS202A20000	4142860	VDS402A20000	20,000	.7874	—	—	77	101	3,5	153	50	20

VariDrill • 8 x D • VDS403A • A-Shank

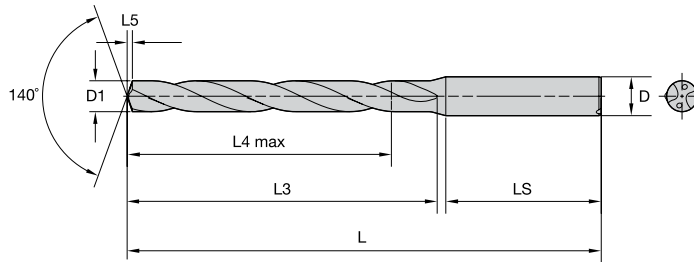

For information on L, L3, and L4 max, see page C46.

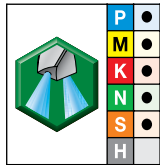

● first choice  
○ alternate choice

grade WU25PD TiAlN		D1 diameter					L4 max	L3	L5	L	LS	D
order #	catalog #	mm	in	fraction	wire size							
6023126	VDS403A01000	1,000	.0394	—	—	10	12	0,2	58	28	4	
6023129	VDS403A01100	1,100	.0433	—	—	10	12	0,2	58	28	4	
6023132	VDS403A01200	1,200	.0472	—	—	10	12	0,2	58	28	4	
6023133	VDS403A01300	1,300	.0512	—	—	10	12	0,2	58	28	4	
6023134	VDS403A01321	1,321	.0520	—	55	10	12	0,2	58	28	4	
6023136	VDS403A01400	1,400	.0551	—	—	10	12	0,2	58	28	4	
4143700	VDS403A01500	1,500	.0591	—	—	15	18	0,2	58	28	4	
4143701	VDS403A01600	1,600	.0630	—	—	15	18	0,2	58	28	4	
4143702	VDS403A01700	1,700	.0669	—	—	15	18	0,3	58	28	4	
4143723	VDS403A01800	1,800	.0709	—	—	15	18	0,3	58	28	4	
4143724	VDS403A01900	1,900	.0748	—	—	15	18	0,3	58	28	4	
4143725	VDS403A01984	1,984	.0781	5/64	—	22	26	0,3	66	28	4	
4143726	VDS403A02000	2,000	.0787	—	—	22	26	0,3	66	28	4	
4143727	VDS403A02100	2,100	.0827	—	—	22	26	0,3	66	28	4	
4143728	VDS403A02200	2,200	.0866	—	—	22	26	0,3	66	28	4	
4143729	VDS403A02300	2,300	.0906	—	—	22	26	0,4	66	28	4	
4143730	VDS403A02383	2,383	.0938	3/32	—	25	30	0,4	66	28	4	
4143731	VDS403A02400	2,400	.0945	—	—	25	30	0,4	66	28	4	
4143732	VDS403A02439	2,439	.0960	—	41	25	30	0,4	66	28	4	
4143733	VDS403A02489	2,489	.0980	—	40	25	30	0,4	66	28	4	
4143734	VDS403A02500	2,500	.0984	—	—	25	30	0,4	66	28	4	
4143735	VDS403A02578	2,578	.1015	—	38	25	30	0,4	66	28	4	
4143736	VDS403A02600	2,600	.1024	—	—	25	30	0,4	66	28	4	
4143737	VDS403A02642	2,642	.1040	—	37	25	30	0,4	66	28	4	
4143738	VDS403A02700	2,700	.1063	—	—	25	30	0,4	66	28	4	
4143739	VDS403A02705	2,705	.1065	—	36	25	30	0,4	66	28	4	
4143740	VDS403A02779	2,779	.1094	7/64	—	25	30	0,5	66	28	4	
4143741	VDS403A02800	2,800	.1102	—	—	25	30	0,5	66	28	4	
4143742	VDS403A02820	2,820	.1110	—	34	25	30	0,5	66	28	4	
4143743	VDS403A02870	2,870	.1130	—	33	25	30	0,5	66	28	4	
4143744	VDS403A02900	2,900	.1142	—	—	25	30	0,5	66	28	4	
4143745	VDS403A02947	2,947	.1160	—	32	25	30	0,5	66	28	4	
4143746	VDS403A03000	3,000	.1181	—	—	33	40	0,5	78	36	6	
4143747	VDS403A03048	3,048	.1200	—	31	33	40	0,5	78	36	6	
4143748	VDS403A03100	3,100	.1220	—	—	33	40	0,5	78	36	6	
4143749	VDS403A03175	3,175	.1250	1/8	—	33	40	0,5	78	36	6	
4143750	VDS403A03200	3,200	.1260	—	—	33	40	0,5	78	36	6	
4143751	VDS403A03264	3,264	.1285	—	30	33	40	0,5	78	36	6	
4143752	VDS403A03300	3,300	.1299	—	30	33	40	0,5	78	36	6	
4143753	VDS403A03400	3,400	.1339	—	—	33	40	0,6	78	36	6	
4143754	VDS403A03455	3,455	.1360	—	29	33	40	0,6	78	36	6	
4143755	VDS403A03500	3,500	.1378	—	21	33	40	0,6	78	36	6	
4143756	VDS403A03571	3,571	.1406	9/64	—	33	40	0,6	78	36	6	
4143757	VDS403A03600	3,600	.1417	—	—	33	40	0,6	78	36	6	
4143758	VDS403A03658	3,658	.1440	—	27	33	40	0,6	78	36	6	
4143759	VDS403A03700	3,700	.1457	—	—	33	40	0,6	78	36	6	
4143760	VDS403A03734	3,734	.1470	—	26	33	40	0,6	78	36	6	
4143761	VDS403A03800	3,800	.1496	—	—	41	49	0,6	87	36	6	
4143762	VDS403A03900	3,900	.1535	—	—	41	49	0,6	87	36	6	
4143763	VDS403A03970	3,970	.1563	5/32	—	41	49	0,7	87	36	6	
4143764	VDS403A04000	4,000	.1575	—	—	41	49	0,7	87	36	6	
4143765	VDS403A04039	4,039	.1590	—	21	41	49	0,7	87	36	6	



## VariDrill • 8 x D • VDS403A • A-Shank

(continued)

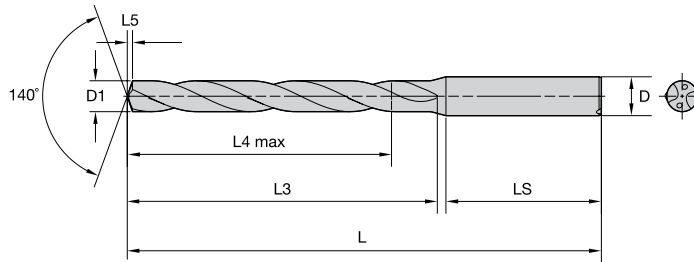

For information on L, L3, and L4 max, see page C46.

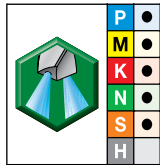

● first choice  
○ alternate choice

grade WU25PD TiAlN		D1 diameter					L4 max	L3	L5	L	LS	D
order #	catalog #	mm	in	fraction	wire size							
4143766	VDS403A04090	4,090	.1610	—	20	41	49	0,7	87	36	6	
4143767	VDS403A04100	4,100	.1614	—	—	41	49	0,7	87	36	6	
4143768	VDS403A04200	4,200	.1654	—	—	41	49	0,7	87	36	6	
4143769	VDS403A04217	4,217	.1660	—	19	41	49	0,7	87	36	6	
4143770	VDS403A04300	4,300	.1693	—	14	41	49	0,7	87	36	6	
4143771	VDS403A04366	4,366	.1719	11/64	—	41	49	0,7	87	36	6	
4143772	VDS403A04400	4,400	.1732	—	—	41	49	0,7	87	36	6	
4143773	VDS403A04500	4,500	.1772	—	—	41	49	0,7	87	36	6	
4143774	VDS403A04600	4,600	.1811	—	19	41	49	0,8	87	36	6	
4143775	VDS403A04623	4,623	.1820	—	14	41	49	0,8	87	36	6	
4143776	VDS403A04700	4,700	.1850	—	13	41	49	0,8	87	36	6	
4143777	VDS403A04763	4,763	.1875	3/16	13	48	56	0,8	94	36	6	
4143778	VDS403A04800	4,800	.1890	—	12	48	56	0,8	94	36	6	
4143779	VDS403A04852	4,852	.1910	—	11	48	56	0,8	94	36	6	
4143780	VDS403A04900	4,900	.1929	—	—	48	56	0,8	94	36	6	
4143781	VDS403A05000	5,000	.1969	—	—	48	56	0,8	94	36	6	
4143782	VDS403A05100	5,100	.2008	—	—	48	56	0,9	94	36	6	
4143783	VDS403A05106	5,106	.2010	—	7	48	56	0,9	94	36	6	
4143784	VDS403A05159	5,159	.2031	13/64	—	48	56	0,9	94	36	6	
4143785	VDS403A05200	5,200	.2047	—	—	48	56	0,9	94	36	6	
4143786	VDS403A05300	5,300	.2087	—	12	48	56	0,9	94	36	6	
4143787	VDS403A05400	5,400	.2126	—	7	48	56	0,9	94	36	6	
4143788	VDS403A05410	5,410	.2130	—	3	48	56	0,9	94	36	6	
4143789	VDS403A05500	5,500	.2165	—	3	48	56	0,9	94	36	6	
4143790	VDS403A05558	5,558	.2188	7/32	2	48	56	0,9	94	36	6	
4143791	VDS403A05600	5,600	.2205	—	—	48	56	0,9	94	36	6	
4143792	VDS403A05616	5,616	.2211	—	2	48	56	0,9	94	36	6	
4143793	VDS403A05700	5,700	.2244	—	—	48	56	1,0	94	36	6	
4143794	VDS403A05800	5,800	.2283	—	—	48	56	1,0	94	36	6	
4143795	VDS403A05900	5,900	.2323	—	—	48	56	1,0	94	36	6	
4143796	VDS403A05954	5,954	.2344	15/64	—	48	56	1,0	94	36	6	
4143797	VDS403A06000	6,000	.2362	—	—	48	56	1,0	94	36	6	
4143798	VDS403A06100	6,100	.2402	—	—	57	67	1,0	105	36	8	
4143799	VDS403A06200	6,200	.2441	—	F	57	67	1,0	105	36	8	
4143800	VDS403A06300	6,300	.2480	—	—	57	67	1,1	105	36	8	
4143801	VDS403A06350	6,350	.2500	1/4	E	57	67	1,1	105	36	8	
4143802	VDS403A06400	6,400	.2520	—	—	57	67	1,1	105	36	8	
4143803	VDS403A06500	6,500	.2559	—	—	57	67	1,1	105	36	8	
4143804	VDS403A06528	6,528	.2570	—	F	57	67	1,1	105	36	8	
4143805	VDS403A06600	6,600	.2598	—	E	57	67	1,1	105	36	8	
4143806	VDS403A06630	6,630	.2610	—	G	57	67	1,1	105	36	8	
4143807	VDS403A06700	6,700	.2638	—	—	57	67	1,1	105	36	8	
4143808	VDS403A06746	6,746	.2656	17/64	—	57	67	1,1	105	36	8	
4143809	VDS403A06800	6,800	.2677	—	—	57	67	1,1	105	36	8	
4143810	VDS403A06900	6,900	.2717	—	—	57	67	1,2	105	36	8	
4143811	VDS403A07000	7,000	.2756	—	—	57	67	1,2	105	36	8	
4143812	VDS403A07100	7,100	.2795	—	—	61	72	1,2	110	36	8	
4143813	VDS403A07145	7,145	.2813	9/32	—	61	72	1,2	110	36	8	
4143814	VDS403A07200	7,200	.2835	—	—	61	72	1,2	110	36	8	
4143815	VDS403A07300	7,300	.2874	—	—	61	72	1,2	110	36	8	
4143816	VDS403A07400	7,400	.2913	—	—	61	72	1,3	110	36	8	
4143817	VDS403A07500	7,500	.2953	—	—	61	72	1,3	110	36	8	

VariDrill • 8 x D • VDS403A • A-Shank

(continued)

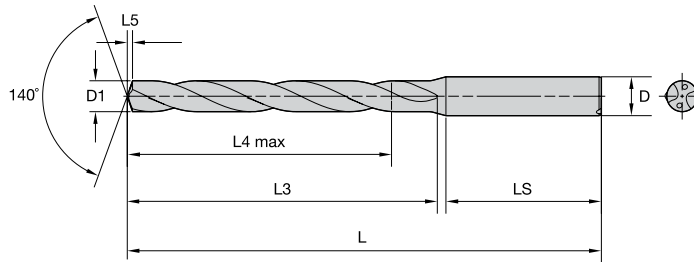

For information on L, L3, and L4 max, see page C46.

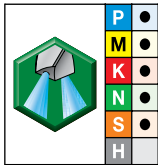

● first choice  
○ alternate choice

grade WU25PD TiAlN		D1 diameter				L4 max	L3	L5	L	LS	D
order #	catalog #	mm	in	fraction	wire size						
4143818	VDS403A07541	7,541	.2969	19/64	—	61	72	1,3	110	36	8
4143819	VDS403A07600	7,600	.2992	—	—	61	72	1,3	110	36	8
4143820	VDS403A07700	7,700	.3031	—	—	61	72	1,3	110	36	8
4143821	VDS403A07800	7,800	.3071	—	—	61	72	1,3	110	36	8
4143822	VDS403A07900	7,900	.3110	—	—	61	72	1,3	110	36	8
4143823	VDS403A07938	7,938	.3125	5/16	Q	61	72	1,3	110	36	8
4143824	VDS403A08000	8,000	.3150	—	—	61	72	1,4	110	36	8
4143825	VDS403A08100	8,100	.3189	—	—	68	80	1,4	122	40	10
4143826	VDS403A08200	8,200	.3228	—	—	68	80	1,4	122	40	10
4143827	VDS403A08300	8,300	.3268	—	—	68	80	1,4	122	40	10
4143828	VDS403A08334	8,334	.3281	21/64	—	68	80	1,4	122	40	10
4143829	VDS403A08400	8,400	.3307	—	—	68	80	1,4	122	40	10
4143830	VDS403A08433	8,433	.3320	—	Q	68	80	1,4	122	40	10
4143831	VDS403A08500	8,500	.3346	—	—	68	80	1,4	122	40	10
4143832	VDS403A08600	8,600	.3386	—	—	68	80	1,5	122	40	10
4143833	VDS403A08700	8,700	.3425	—	—	68	80	1,5	122	40	10
4143834	VDS403A08733	8,733	.3438	11/32	—	68	80	1,5	122	40	10
4143835	VDS403A08800	8,800	.3465	—	—	68	80	1,5	122	40	10
4143836	VDS403A08900	8,900	.3504	—	—	68	80	1,5	122	40	10
4143837	VDS403A09000	9,000	.3543	—	—	68	80	1,5	122	40	10
4143838	VDS403A09100	9,100	.3583	—	—	68	80	1,6	122	40	10
4143839	VDS403A09129	9,129	.3594	23/64	—	68	80	1,6	122	40	10
4143840	VDS403A09200	9,200	.3622	—	—	68	80	1,6	122	40	10
4143841	VDS403A09300	9,300	.3661	—	—	68	80	1,6	122	40	10
4143842	VDS403A09347	9,347	.3680	—	U	68	80	1,6	122	40	10
4143843	VDS403A09400	9,400	.3701	—	—	68	80	1,6	122	40	10
4143844	VDS403A09500	9,500	.3740	—	—	68	80	1,6	122	40	10
4143845	VDS403A09525	9,525	.3750	3/8	—	68	80	1,6	122	40	10
4143846	VDS403A09600	9,600	.3780	—	U	68	80	1,6	122	40	10
4143847	VDS403A09700	9,700	.3819	—	—	68	80	1,7	122	40	10
4143848	VDS403A09800	9,800	.3858	—	—	68	80	1,7	122	40	10
4143849	VDS403A09900	9,900	.3898	—	—	68	80	1,7	122	40	10
4143850	VDS403A09921	9,921	.3906	25/64	—	68	80	1,7	122	40	10
4143421	VDS403A10000	10,000	.3937	—	—	68	80	1,7	122	40	10
4143422	VDS403A10100	10,100	.3976	—	—	79	94	1,7	141	45	12
4143473	VDS403A10200	10,200	.4016	—	—	79	94	1,7	141	45	12
4143474	VDS403A10300	10,300	.4055	—	—	79	94	1,8	141	45	12
4143475	VDS403A10320	10,320	.4063	13/32	—	79	94	1,8	141	45	12
4143476	VDS403A10400	10,400	.4094	—	—	79	94	1,8	141	45	12
4143477	VDS403A10500	10,500	.4134	—	—	79	94	1,8	141	45	12
4143478	VDS403A10600	10,600	.4173	—	—	79	94	1,8	141	45	12
4143479	VDS403A10700	10,700	.4213	—	—	79	94	1,8	141	45	12
4143480	VDS403A10716	10,716	.4219	27/64	—	79	94	1,8	141	45	12
4143481	VDS403A10800	10,800	.4252	—	—	79	94	1,9	141	45	12
4143482	VDS403A10900	10,900	.4291	—	—	79	94	1,9	141	45	12
4143483	VDS403A11000	11,000	.4331	—	—	79	94	1,9	141	45	12
4143484	VDS403A11100	11,100	.4370	—	—	79	94	1,9	141	45	12
4143485	VDS403A11113	11,113	.4375	7/16	—	79	94	1,9	141	45	12
4143486	VDS403A11200	11,200	.4409	—	—	79	94	1,9	141	45	12
4143487	VDS403A11300	11,300	.4449	—	—	79	94	1,9	141	45	12
4143488	VDS403A11400	11,400	.4488	—	—	79	94	2,0	141	45	12
4143489	VDS403A11500	11,500	.4528	—	—	79	94	2,0	141	45	12

## VariDrill • 8 x D • VDS403A • A-Shank

(continued)

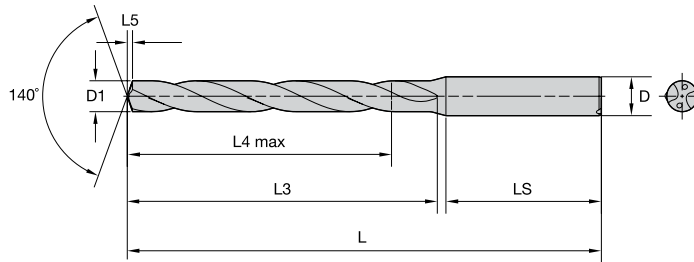

For information on L, L3, and L4 max, see page C46.

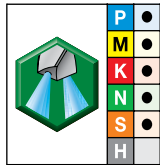

● first choice  
○ alternate choice

grade WU25PD TiAlN		D1 diameter					L4 max	L3	L5	L	LS	D
order #	catalog #	mm	in	fraction	wire size							
4143490	VDS403A11509	11,509	.4531	29/64	—	79	94	2,0	141	45	12	
4143491	VDS403A11600	11,600	.4567	—	—	79	94	2,0	141	45	12	
4143492	VDS403A11700	11,700	.4606	—	—	79	94	2,0	141	45	12	
4143493	VDS403A11800	11,800	.4646	—	—	79	94	2,0	141	45	12	
4143494	VDS403A11900	11,900	.4685	—	—	79	94	2,0	141	45	12	
4143495	VDS403A11908	11,908	.4688	15/32	—	79	94	2,0	141	45	12	
4143496	VDS403A12000	12,000	.4724	—	—	79	94	2,1	141	45	12	
4143497	VDS403A12100	12,100	.4764	—	—	91	108	2,1	155	45	14	
4143498	VDS403A12200	12,200	.4803	—	—	91	108	2,1	155	45	14	
4143499	VDS403A12300	12,300	.4843	—	—	91	108	2,1	155	45	14	
4143500	VDS403A12304	12,304	.4844	31/64	—	91	108	2,1	155	45	14	
4143501	VDS403A12400	12,400	.4882	—	—	91	108	2,1	155	45	14	
4143502	VDS403A12500	12,500	.4921	—	—	91	108	2,2	155	45	14	
4143503	VDS403A12600	12,600	.4961	—	—	91	108	2,2	155	45	14	
4143504	VDS403A12700	12,700	.5000	1/2	—	91	108	2,2	155	45	14	
4143505	VDS403A12800	12,800	.5039	—	—	91	108	2,2	155	45	14	
4143506	VDS403A12900	12,900	.5079	—	—	91	108	2,2	155	45	14	
4143507	VDS403A13000	13,000	.5118	—	—	91	108	2,2	155	45	14	
4143508	VDS403A13096	13,096	.5156	33/64	—	91	108	2,3	155	45	14	
4143509	VDS403A13100	13,100	.5157	—	—	91	108	2,3	155	45	14	
4143510	VDS403A13200	13,200	.5197	—	—	91	108	2,3	155	45	14	
4143511	VDS403A13300	13,300	.5236	—	—	91	108	2,3	155	45	14	
4143512	VDS403A13400	13,400	.5276	—	—	91	108	2,3	155	45	14	
4143513	VDS403A13500	13,500	.5315	—	—	91	108	2,3	155	45	14	
4143514	VDS403A13600	13,600	.5354	—	—	91	108	2,3	155	45	14	
4143515	VDS403A13700	13,700	.5394	—	—	91	108	2,4	155	45	14	
4143516	VDS403A13800	13,800	.5433	—	—	91	108	2,4	155	45	14	
4143517	VDS403A13891	13,891	.5469	35/64	—	91	108	2,4	155	45	14	
4143518	VDS403A13900	13,900	.5472	—	—	91	108	2,4	155	45	14	
4143519	VDS403A14000	14,000	.5512	—	—	91	108	2,4	155	45	14	
4143520	VDS403A14100	14,100	.5551	—	—	101	121	2,4	171	48	16	
4143521	VDS403A14200	14,200	.5591	—	—	101	121	2,5	171	48	16	
4143522	VDS403A14288	14,288	.5625	9/16	—	101	121	2,5	171	48	16	
4143523	VDS403A14300	14,300	.5630	—	—	101	121	2,5	171	48	16	
4143524	VDS403A14400	14,400	.5669	—	—	101	121	2,5	171	48	16	
4143525	VDS403A14500	14,500	.5709	—	—	101	121	2,5	171	48	16	
4143526	VDS403A14600	14,600	.5748	—	—	101	121	2,5	171	48	16	
4143527	VDS403A14684	14,684	.5781	37/64	—	101	121	2,5	171	48	16	
4143528	VDS403A14700	14,700	.5787	—	—	101	121	2,5	171	48	16	
4143529	VDS403A14800	14,800	.5827	—	—	101	121	2,6	171	48	16	
4143530	VDS403A14900	14,900	.5866	—	—	101	121	2,6	171	48	16	
4143531	VDS403A15000	15,000	.5906	—	—	101	121	2,6	171	48	16	
4143532	VDS403A15083	15,083	.5938	19/32	—	101	121	2,6	171	48	16	
4143533	VDS403A15100	15,100	.5945	—	—	101	121	2,6	171	48	16	
4143534	VDS403A15200	15,200	.5984	—	—	101	121	2,6	171	48	16	
4143535	VDS403A15300	15,300	.6024	—	—	101	121	2,6	171	48	16	
4143536	VDS403A15400	15,400	.6063	—	—	101	121	2,7	171	48	16	
4143537	VDS403A15479	15,479	.6094	39/64	—	101	121	2,7	171	48	16	
4143538	VDS403A15500	15,500	.6102	—	—	128	146	2,7	197	48	16	
4143539	VDS403A15600	15,600	.6142	—	—	101	121	2,7	171	48	16	
4143540	VDS403A15700	15,700	.6181	—	—	101	121	2,7	171	48	16	
4143541	VDS403A15800	15,800	.6220	—	—	101	121	2,7	171	48	16	

VariDrill • 8 x D • VDS403A • A-Shank

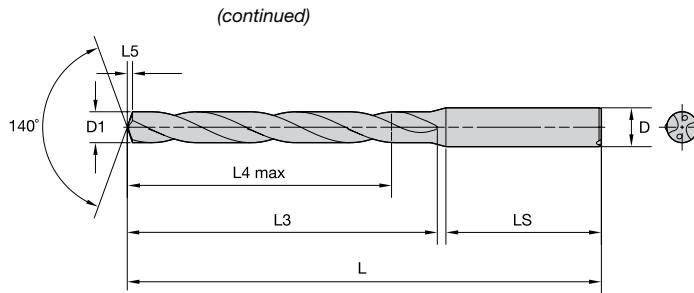

For information on L, L3, and L4 max, see page C46.

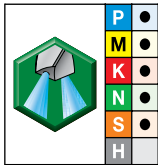

● first choice  
○ alternate choice

grade WU25PD TiAlN		D1 diameter				L4 max	L3	L5	L	LS	D
order #	catalog #	mm	in	fraction	wire size						
4143542	VDS403A15875	15,875	.6250	5/8	—	101	121	2,8	171	48	16
4143543	VDS403A15900	15,900	.6260	—	—	101	121	2,8	171	48	16
4143544	VDS403A16000	16,000	.6299	—	—	101	121	2,8	171	48	16
4143546	VDS403A16200	16,200	.6378	—	—	113	135	2,8	185	48	18
4143547	VDS403A16271	16,271	.6406	41/64	—	113	135	2,8	185	48	18
4143548	VDS403A16300	16,300	.6417	—	—	113	135	2,8	185	48	18
4143549	VDS403A16400	16,400	.6457	—	—	113	135	2,8	185	48	18
4143550	VDS403A16500	16,500	.6496	—	—	113	135	2,9	185	48	18
4143551	VDS403A16600	16,600	.6535	—	—	113	135	2,9	185	48	18
4143552	VDS403A16670	16,670	.6563	21/32	—	113	135	2,9	185	48	18
4143553	VDS403A16700	16,700	.6575	—	—	113	135	2,9	185	48	18
4143554	VDS403A16800	16,800	.6614	—	—	113	135	2,9	185	48	18
4143555	VDS403A16900	16,900	.6654	—	—	113	135	2,9	185	48	18
4143556	VDS403A17000	17,000	.6693	—	—	113	135	3,0	185	48	18
4143557	VDS403A17100	17,100	.6732	—	—	113	135	3,0	185	48	18
4143558	VDS403A17200	17,200	.6772	—	—	113	135	3,0	185	48	18
4143559	VDS403A17300	17,300	.6811	—	—	113	135	3,0	185	48	18
4143560	VDS403A17400	17,400	.6850	—	—	113	135	3,0	185	48	18
4143561	VDS403A17463	17,463	.6875	11/16	—	113	135	3,0	185	48	18
4143562	VDS403A17500	17,500	.6890	—	—	113	135	3,0	185	48	18
4143563	VDS403A17600	17,600	.6929	—	—	113	135	3,1	185	48	18
4143564	VDS403A17700	17,700	.6969	—	—	113	135	3,1	185	48	18
4143565	VDS403A17800	17,800	.7008	—	—	113	135	3,1	185	48	18
4144209	VDS403A18000	18,000	.7087	—	—	113	135	3,1	185	48	18
4144211	VDS403A18100	18,100	.7126	—	—	124	148	3,1	200	50	20
4144212	VDS403A18200	18,200	.7165	—	—	124	148	3,2	200	50	20
4144246	VDS403A18300	18,300	.7205	—	—	124	148	3,2	200	50	20
4144248	VDS403A18400	18,400	.7244	—	—	124	148	3,2	200	50	20
4144250	VDS403A18500	18,500	.7283	—	—	124	148	3,2	200	50	20
4144252	VDS403A18600	18,600	.7323	—	—	124	148	3,2	200	50	20
4144256	VDS403A18700	18,700	.7362	—	—	124	148	3,3	200	50	20
4144258	VDS403A18800	18,800	.7402	—	—	124	148	3,3	200	50	20
4144260	VDS403A18900	18,900	.7441	—	—	124	148	3,3	200	50	20
4144262	VDS403A19000	19,000	.7480	—	—	124	148	3,3	200	50	20
4144275	VDS403A19050	19,050	.7500	3/4	—	124	148	3,3	200	50	20
4144277	VDS403A19100	19,100	.7520	—	—	124	148	3,3	200	50	20
4144281	VDS403A19300	19,300	.7598	—	—	124	148	3,4	200	50	20
4144283	VDS403A19400	19,400	.7638	—	—	124	148	3,4	200	50	20
4144285	VDS403A19500	19,500	.7677	—	—	124	148	3,4	200	50	20
4144289	VDS403A19700	19,700	.7756	—	—	124	148	3,4	200	50	20
4144291	VDS403A19800	19,800	.7795	—	—	124	148	3,4	200	50	20
4144303	VDS403A19900	19,900	.7835	—	—	124	148	3,5	200	50	20
4144305	VDS403A20000	20,000	.7874	—	—	124	148	3,5	200	50	20

INDEXABLE MILLING

SOLID END MILLING

HOLEMAKING

TAPPING

TURNING







# TOP DRILL S+™

Solid Carbide Drills 12 x D • TDS+

TDS+ solid carbide drills are for shop floors seeking a drill with optimal performance and hole quality in steel, stainless steel, and cast iron materials using one universal geometry and grade.



**135° point geometry**  
Low thrust with excellent centering capabilities

**4-margin design to full length**  
Provides stability in interrupted cut with optimal hole quality

**30° helix with optimized flute profile**  
Reduces risk of chip jamming and catastrophic failure

**Sub-micron grain substrate**  
Superior resistance against drill breakage

TDS+ 12 x D drills are capable of drilling holes in steel and cast iron without a pilot drill due to its 135° P point geometry and four full-length margins

**WU20PD**



Sub-micron grain carbide  
TiAlN multilayer for steel, stainless steel, and cast iron

# OPTIMAL PERFORMANCE

## PRODUCT

TDS P Point with 135° P point angle for excellent centering and low thrust

## DIAMETER RANGE

.1181–.7874" (3–20mm)

## INDUSTRY



## MATERIALS

### FIRST CHOICE



### SECOND CHOICE



## APPLICATIONS



DRILLING



INCLINED EXIT



STACKED PLATES



DRILLING DEPTH: 12X



2 FLUTE/4 MARGIN/ COOLANT



THROUGH COOLANT



MQL (MINIMUM QUANTITY LUBRICANT)



HELIX ANGLE: 30°



PLAIN SHANK: ≤H6



DIN 6535

## SERIES

TDS504

## COOLANT

Through Coolant

## LENGTH RATIO

12 x D

## DIAMETER RANGE

.1181–.7874" (3–20mm)

## Shank Style

A - Shank DIN 6535 HA  
(round cylindrical, 2mm steps)





## TDS+ • Catalog Numbering System

Each character in our catalog number signifies a specific trait of that product.  
Use the following key columns and corresponding images to easily identify which attributes apply.

TDS	5	0	4	A	06350	WU20PD
Top Drill Spiral	Flute Style - Coolant	Point	Length	Shank	Diameter in letric	
	5 = 2 Flute Through Coolant	0 = Conventional Cone Point  1 = Conventional Cone Point with Chamfer	1 = ~ 3 x D 2 = ~ 5 x D 3 = ~ 8 x D 4 = ~ 12 x D	A = Cylindrical Shank, DIN 6535 - 2mm steps  F = Whistle Notch 2, DIN 6535 - 2mm steps	03000 = 3,000mm 06350 = 1/4" = E	WIDIA™; Universal, Application 20 = medium carbide, PVD coated, Drill

TOP DRILL S+™ • 12 x D • TDS504A • A-Shank

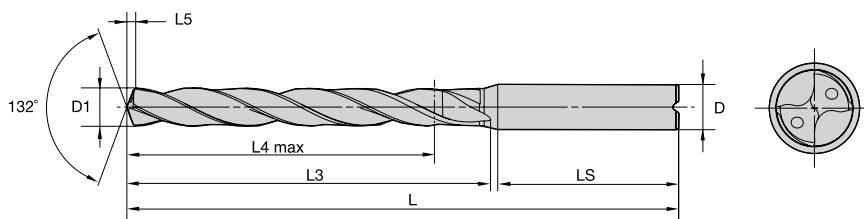

For information on L, L3, and L4 max, see page C46

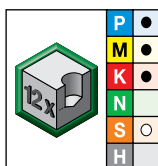

● first choice

○ alternate choice

grade WU20PD TiAlN		D1 diameter				L	L4 max	L3	L5	LS	D
order #	catalog #	mm	in	fraction	wire size						
4173459	TDS504A03000	3,000	.1181	—	—	93	44	52,0	0,6	36	6
4173460	TDS504A03175	3,175	.1250	1/8	—	93	44	52,0	0,7	36	6
4173461	TDS504A03264	3,264	.1285	—	30	93	44	53,0	0,7	36	6
4173545	TDS504A03455	3,455	.1360	—	29	93	44	53,0	0,7	36	6
4173462	TDS504A03500	3,500	.1378	—	—	93	44	53,0	0,7	36	6
4173546	TDS504A03734	3,734	.1470	—	26	93	45	54,0	0,8	36	6
4173463	TDS504A03970	3,970	.1563	5/32	—	107	56	66,0	0,8	36	6
4173464	TDS504A04000	4,000	.1575	—	—	107	56	66,0	0,8	36	6
4173465	TDS504A04500	4,500	.1772	—	—	107	56	67,0	0,9	36	6
4173466	TDS504A04600	4,600	.1811	—	—	107	57	68,0	1,0	36	6
4173467	TDS504A04763	4,763	.1875	3/16	—	125	69	82,0	1,0	36	6
4173468	TDS504A04800	4,800	.1890	—	12	125	69	82,0	1,0	36	6
4173469	TDS504A05000	5,000	.1969	—	—	125	70	83,0	1,1	36	6
4173470	TDS504A05100	5,100	.2008	—	—	125	70	83,0	1,1	36	6
4173471	TDS504A05200	5,200	.2047	—	—	125	70	83,0	1,1	36	6
4173472	TDS504A05300	5,300	.2087	—	—	125	71	84,0	1,1	36	6
4173473	TDS504A05410	5,410	.2130	—	3	125	71	84,0	1,1	36	6
4173474	TDS504A05500	5,500	.2165	—	—	125	71	84,0	1,2	36	6
4173475	TDS504A05558	5,558	.2188	7/32	—	125	71	84,0	1,2	36	6
4173476	TDS504A05600	5,600	.2205	—	—	125	72	85,0	1,2	36	6
4173477	TDS504A05700	5,700	.2244	—	—	125	72	85,0	1,2	36	6
4173478	TDS504A05800	5,800	.2283	—	—	125	71	85,0	1,2	36	6
4173479	TDS504A06000	6,000	.2362	—	—	125	72	86,0	1,3	36	6
4173480	TDS504A06200	6,200	.2441	—	—	139	82	97,0	1,3	36	8
4173481	TDS504A06350	6,350	.2500	1/4	E	139	83	98,0	1,3	36	8
4173482	TDS504A06500	6,500	.2559	—	—	139	83	98,0	1,4	36	8
4173484	TDS504A06600	6,600	.2598	—	—	139	84	99,0	1,4	36	8
4173485	TDS504A06746	6,746	.2656	17/64	—	139	83	99,0	1,4	36	8
4173486	TDS504A06800	6,800	.2677	—	—	139	83	99,0	1,4	36	8
4173487	TDS504A06909	6,909	.2720	—	I	139	84	100,0	1,5	36	8
4173488	TDS504A07000	7,000	.2756	—	—	139	84	100,0	1,5	36	8
4173489	TDS504A07145	7,145	.2813	9/32	—	153	94	111,0	1,5	36	8
4173490	TDS504A07500	7,500	.2953	—	—	153	95	112,0	1,6	36	8
4173491	TDS504A07541	7,541	.2969	19/64	—	153	95	112,0	1,6	36	8
4173492	TDS504A07700	7,700	.3031	—	—	153	96	113,0	1,6	36	8
4173493	TDS504A07800	7,800	.3071	—	—	153	95	113,0	1,7	36	8
4173494	TDS504A07938	7,938	.3125	5/16	—	153	96	114,0	1,7	36	8
4173495	TDS504A08000	8,000	.3150	—	—	153	96	114,0	1,7	36	8
4173496	TDS504A08100	8,100	.3189	—	—	185	116	136,0	1,7	40	10
4173497	TDS504A08334	8,334	.3281	21/64	—	185	117	137,0	1,8	40	10
4173498	TDS504A08433	8,433	.3320	—	Q	185	117	137,0	1,8	40	10
4173499	TDS504A08500	8,500	.3346	—	—	185	117	137,0	1,8	40	10
4173500	TDS504A08700	8,700	.3425	—	—	185	118	138,0	1,9	40	10
4173501	TDS504A08733	8,733	.3438	11/32	—	185	117	138,0	1,9	40	10
4173502	TDS504A09000	9,000	.3543	—	—	185	118	139,0	1,9	40	10
4173503	TDS504A09100	9,100	.3583	—	—	185	118	139,0	1,9	40	10
4173504	TDS504A09129	9,129	.3594	23/64	—	185	118	139,0	1,9	40	10
4173547	TDS504A09347	9,347	.3680	—	U	185	119	140,0	2,0	40	10

## TOP DRILL S+™ • 12 x D • TDS504A • A-Shank

INDEXABLE MILLING

SOLID END MILLING

HOLEMAKING

TAPPING

TURNING

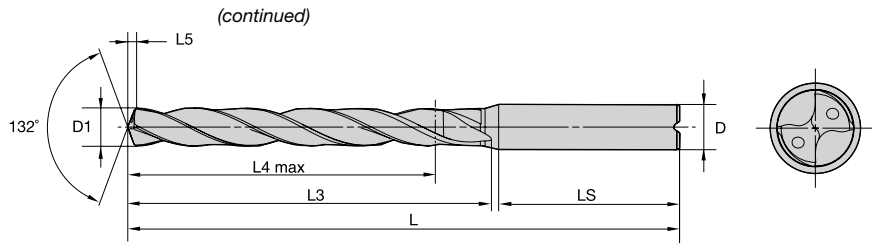

For information on L, L3, and L4 max, see page C46

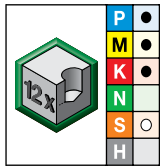

● first choice  
○ alternate choice

grade WU20PD TiAIN		D1 diameter				L	L4 max	L3	L5	LS	D
order #	catalog #	mm	in	fraction	wire size						
4173505	TDS504A09500	9,500	.3740	—	—	185	119	140,0	2,0	40	10
4173506	TDS504A09525	9,525	.3750	3/8	—	185	119	140,0	2,0	40	10
4173507	TDS504A09921	9,921	.3906	25/64	—	185	120	142,0	2,1	40	10
4173508	TDS504A10000	10,000	.3937	—	—	185	120	142,0	2,1	40	10
4173509	TDS504A10200	10,200	.4016	—	—	218	140	164,0	2,2	45	12
4173510	TDS504A10300	10,300	.4055	—	—	218	141	165,0	2,2	45	12
4173511	TDS504A10320	10,320	.4063	13/32	—	218	141	165,0	2,2	45	12
4173512	TDS504A10500	10,500	.4134	—	—	218	141	165,0	2,2	45	12
4173513	TDS504A10716	10,716	.4219	27/64	—	218	142	166,0	2,3	45	12
4173514	TDS504A10800	10,800	.4252	—	—	218	141	166,0	2,3	45	12
4173515	TDS504A11000	11,000	.4331	—	—	218	142	167,0	2,4	45	12
4173516	TDS504A11113	11,113	.4375	7/16	—	218	142	167,0	2,4	45	12
4173517	TDS504A11500	11,500	.4528	—	—	218	143	168,0	2,5	45	12
4173518	TDS504A11800	11,800	.4646	—	—	218	143	169,0	2,5	45	12
4173519	TDS504A12000	12,000	.4724	—	—	218	144	170,0	2,6	45	12
4173520	TDS504A12100	12,100	.4764	—	—	246	164	192,0	2,6	45	14
4148906	TDS504A12500	12,500	.4921	—	—	246	165	193,0	2,7	45	14
4173522	TDS504A12700	12,700	.5000	1/2	—	246	166	194,0	2,7	45	14
4173523	TDS504A13000	13,000	.5118	—	—	246	166	195,0	2,8	45	14
4173524	TDS504A13100	13,100	.5157	—	—	246	166	195,0	2,8	45	14
4173525	TDS504A13500	13,500	.5315	—	—	246	167	196,0	2,9	45	14
4173526	TDS504A14000	14,000	.5512	—	—	246	168	198,0	3,0	45	14
4173527	TDS504A14100	14,100	.5551	—	—	277	188	220,0	3,0	48	16
4173528	TDS504A14288	14,288	.5625	9/16	—	277	188	220,0	3,1	48	16
4173529	TDS504A14500	14,500	.5709	—	—	277	189	221,0	3,1	48	16
4173530	TDS504A14684	14,684	.5781	37/64	—	277	190	222,0	3,2	48	16
4173531	TDS504A15000	15,000	.5906	—	—	277	190	223,0	3,2	48	16
4173533	TDS504A15875	15,875	.6250	5/8	—	277	192	225,0	3,4	48	16
4173534	TDS504A16000	16,000	.6299	—	—	277	192	226,0	3,4	48	16
4173535	TDS504A16500	16,500	.6496	—	—	305	213	249,0	3,6	48	18
4173536	TDS504A17000	17,000	.6693	—	—	305	214	250,0	3,7	48	18
4173537	TDS504A17463	17,463	.6875	11/16	—	305	215	252,0	3,8	48	18
4173538	TDS504A17500	17,500	.6890	—	—	305	215	252,0	3,8	48	18
4173539	TDS504A18000	18,000	.7087	—	—	305	216	253,0	3,9	48	18
4173541	TDS504A19000	19,000	.7480	—	—	334	238	278,0	4,1	50	20
4173543	TDS504A19500	19,500	.7677	—	—	334	239	280,0	4,2	50	20
4173544	TDS504A20000	20,000	.7874	—	—	334	240	281,0	4,3	50	20

Application Data • TDS+ Series • WU20PD™ • Through Coolant • Inch

Material Group	Cutting Speed – vc Range – SFM			Recommended Feed Rate (f) by Diameter									
	min	-	max	Tool Diameter (inch)	.125-1/8	.188-3/16	.250-1/4	.313-5/16	.375-3/8	.500-1/2	.625-5/8	.750-3/4	
	<b>P</b>	0	260	-	520	IPR	.002-.005	.003-.005	.004-.007	.004-.009	.005-.010	.006-.012	.007-.014
	1	230	-	460	IPR	.003-.006	.003-.006	.004-.009	.005-.010	.006-.012	.007-.014	.009-.017	.011-.021
	2	300	-	460	IPR	.003-.006	.003-.006	.005-.009	.006-.010	.007-.012	.008-.014	.009-.017	.012-.021
	3	200	-	330	IPR	.003-.006	.004-.007	.005-.009	.006-.011	.007-.013	.009-.015	.010-.019	.013-.023
	4	160	-	330	IPR	.003-.006	.003-.007	.005-.009	.006-.011	.007-.013	.007-.015	.009-.019	.011-.023
	5	160	-	260	IPR	.003-.005	.004-.006	.005-.007	.006-.009	.008-.011	.009-.012	.011-.015	.013-.017
	6	130	-	230	IPR	.002-.003	.002-.004	.003-.006	.004-.007	.005-.009	.006-.009	.007-.013	.009-.016
<b>M</b>	1	100	-	160	IPR	.002-.003	.002-.004	.003-.004	.004-.005	.004-.006	.005-.006	.006-.007	.006-.008
	2	130	-	200	IPR	.002-.003	.002-.004	.003-.005	.004-.006	.004-.006	.005-.007	.006-.008	.006-.009
	3	100	-	160	IPR	.002-.003	.002-.004	.003-.004	.004-.005	.004-.006	.005-.006	.006-.007	.006-.008
<b>K</b>	1	260	-	560	IPR	.004-.009	.005-.009	.006-.012	.008-.015	.009-.017	.010-.019	.012-.024	.015-.029
	2	260	-	460	IPR	.005-.006	.005-.007	.006-.010	.008-.012	.009-.014	.010-.016	.012-.019	.015-.024
	3	260	-	430	IPR	.003-.007	.004-.007	.005-.010	.006-.012	.007-.014	.007-.016	.009-.019	.012-.024
<b>N</b>	1	300	-	1030	IPR	.003-.006	.004-.006	.005-.008	.006-.009	.008-.011	.009-.013	.011-.016	.013-.019
	2	300	-	890	IPR	.003-.006	.004-.008	.005-.009	.006-.011	.008-.013	.009-.014	.011-.017	.013-.020
	3	300	-	890	IPR	.005-.006	.005-.006	.006-.008	.006-.009	.008-.011	.009-.013	.011-.016	.013-.017
	4	300	-	590	IPR	.003-.006	.001-.008	.005-.009	.006-.011	.008-.013	.009-.014	.011-.016	.013-.019
<b>S</b>	1	30	-	100	IPR	.001-.002	.002-.003	.002-.004	.003-.005	.004-.005	.004-.006	.005-.006	.006-.007
	2	30	-	80	IPR	.001-.002	.001-.002	.002-.003	.003-.004	.003-.004	.004-.005	.004-.006	.004-.006
	3	30	-	100	IPR	.001-.002	.001-.002	.002-.003	.002-.004	.003-.004	.003-.004	.004-.005	.004-.006
	4	30	-	130	IPR	.001-.002	.001-.002	.002-.003	.003-.004	.003-.004	.004-.005	.004-.006	.004-.006

Application Data • TDS+ Series • WU20PD™ • Through Coolant • Metric

Material Group	Cutting Speed – vc Range – m/min			Recommended Feed Rate (f) by Diameter									
	min	-	max	Tool Diameter (mm)	3,0	4,0	6,0	8,0	10,0	12,0	16,0	20,0	
	<b>P</b>	0	80	-	160	mm/r	0,06-0,12	0,07-0,14	0,09-0,19	0,11-0,22	0,13-0,26	0,15-0,30	0,19-0,36
	1	70	-	140	mm/r	0,07-0,14	0,08-0,16	0,11-0,22	0,13-0,26	0,15-0,31	0,18-0,35	0,22-0,42	0,28-0,54
	2	90	-	140	mm/r	0,07-0,14	0,08-0,16	0,12-0,22	0,14-0,26	0,17-0,31	0,20-0,35	0,24-0,42	0,31-0,53
	3	60	-	100	mm/r	0,08-0,15	0,09-0,17	0,13-0,23	0,15-0,28	0,19-0,33	0,22-0,38	0,26-0,47	0,34-0,59
	4	50	-	100	mm/r	0,07-0,15	0,08-0,17	0,12-0,23	0,14-0,28	0,17-0,33	0,19-0,38	0,23-0,47	0,29-0,59
	5	50	-	80	mm/r	0,08-0,13	0,10-0,15	0,12-0,19	0,16-0,24	0,20-0,27	0,24-0,30	0,28-0,38	0,32-0,44
	6	40	-	70	mm/r	0,05-0,08	0,06-0,10	0,08-0,14	0,10-0,18	0,13-0,22	0,14-0,24	0,18-0,32	0,23-0,41
<b>M</b>	1	30	-	50	mm/r	0,04-0,07	0,05-0,09	0,08-0,11	0,09-0,12	0,10-0,14	0,12-0,16	0,14-0,18	0,16-0,20
	2	40	-	60	mm/r	0,04-0,08	0,06-0,10	0,08-0,12	0,09-0,14	0,10-0,16	0,12-0,18	0,14-0,20	0,16-0,22
	3	30	-	50	mm/r	0,04-0,07	0,05-0,09	0,08-0,11	0,09-0,12	0,10-0,14	0,12-0,16	0,14-0,18	0,16-0,20
<b>K</b>	1	80	-	170	mm/r	0,11-0,22	0,12-0,24	0,16-0,31	0,20-0,38	0,23-0,44	0,25-0,49	0,31-0,60	0,38-0,74
	2	80	-	140	mm/r	0,12-0,16	0,13-0,19	0,16-0,25	0,20-0,31	0,23-0,36	0,25-0,40	0,31-0,48	0,38-0,60
	3	80	-	130	mm/r	0,08-0,17	0,09-0,19	0,12-0,25	0,14-0,30	0,17-0,35	0,19-0,40	0,24-0,48	0,30-0,60
<b>N</b>	1	90	-	315	mm/r	0,08-0,14	0,10-0,16	0,12-0,20	0,16-0,24	0,20-0,28	0,24-0,32	0,28-0,40	0,32-0,48
	2	90	-	270	mm/r	0,08-0,16	0,10-0,20	0,12-0,24	0,16-0,28	0,20-0,32	0,24-0,36	0,28-0,44	0,32-0,52
	3	90	-	270	mm/r	0,12-0,14	0,13-0,16	0,14-0,20	0,16-0,24	0,20-0,28	0,24-0,32	0,28-0,40	0,32-0,44
	4	90	-	180	mm/r	0,08-0,16	0,01-0,20	0,12-0,24	0,16-0,28	0,20-0,32	0,24-0,36	0,28-0,40	0,32-0,48
<b>S</b>	1	10	-	30	mm/r	0,03-0,06	0,04-0,08	0,06-0,10	0,08-0,12	0,09-0,13	0,10-0,14	0,12-0,16	0,14-0,18
	2	10	-	25	mm/r	0,02-0,04	0,03-0,06	0,05-0,08	0,07-0,10	0,08-0,11	0,09-0,12	0,10-0,14	0,11-0,16
	3	10	-	30	mm/r	0,02-0,04	0,02-0,05	0,04-0,07	0,06-0,09	0,07-0,10	0,08-0,11	0,09-0,13	0,10-0,15
	4	10	-	40	mm/r	0,02-0,04	0,03-0,06	0,05-0,08	0,07-0,10	0,08-0,11	0,09-0,12	0,10-0,14	0,11-0,16

nominal size range	Inch tolerance D1 tolerance m7	D tolerance h6
>.1181-2362	.0000/.0005	.0000/- .0003
>.2360-3937	.0000/.0006	.0000/- .0004
>.3937-7087	.0000/.0007	.0000/- .0004
>.7078-1.0000	.0000/.0009	.0000/- .0005

nominal size range	Metric tolerance D1 tolerance m7	D tolerance h6
>3-6	0,004/0,016	0,000/-0,008
>6-10	0,006/0,021	0,000/-0,009
>10-18	0,007/0,025	0,000/-0,011
>18-25,4	0,008/0,029	0,000/-0,013

# TOP DRILL™ Deep Hole

## Solid Carbide Deep Hole Drills • TDD

TDD solid carbide deep hole drills consistently deliver high MRRs in steel and cast iron materials using one universal grade.



**132° cone point geometry**  
Improves hole quality, and productivity.

**4-margin design**  
Improves process stability, increases tool life, enables interrupted cuts.

**30° helix with optimized flute profile**  
Reduces risk of chip jamming and catastrophic failure.

**Ultra-fine grain substrate**  
Superior resistance against drill breakage.

The Solid Carbide Deep Hole Drills are enhanced with a cone point geometry which enables the drill to outperform gun drills and HSS deep hole drills in deep hole applications up to 30 x D.

**WU20PD**



Ultra-fine grain carbide  
TiAlN multilayer for steel and cast iron

# CONSISTENT PERFORMANCE

## PRODUCT

### POINT GEOMETRY/GRADE

UP 132° cone point geometry, low thrust, excellent centering

### DIAMETER RANGE

.1181–.5118" (3,0–13,0mm)

## INDUSTRY



## MATERIALS

### FIRST CHOICE



### SECOND CHOICE



## APPLICATIONS



DRILLING



INCLINED EXIT



STACKED PLATES



2 FLUTE/4 MARGIN/ COOLANT



THROUGH COOLANT



MQL (MINIMUM QUANTITY LUBRICANT)



HELIX ANGLE: 30°



PLAIN SHANK: ≤H5

### SERIES

### LENGTH RATIO

### DIAMETER RANGE

TDD105Z (H101Z)

15 x D

.1181–.5118" (3,0–13,0mm)

TDD106Z (H102Z)

20 x D

.1181–.5118" (3,0–13,0mm)

TDD107Z (H103Z)

25 x D

.1181–.5118" (3,0–13,0mm)

TDD108Z (H104Z)

30 x D

.1181–.5118" (3,0–13,0mm)

## Z-SHANK

Round cylindrical, 1mm steps



## TDD • Catalog Numbering System

Each character in our catalog number signifies a specific trait of that product.  
Use the following key columns and corresponding images to easily identify which attributes apply.

TD	D	105	Z	06350	WU20PD
Top Drill	Deep Hole Drills	Length	Shank	Diameter in Inch	
TD = Top Drill		5 = 15 x D (H101) 6 = 20 x D (H102) 7 = 25 x D (H103) 8 = 30 x D (H104)	Z = Cylindrical Shank, 1mm steps	03000 = 3,000mm 06350 = 1/4"	WIDIA™, Universal, PVD, Drilling

TOP DRILL Deep Hole • 15 x D • TDD105 • 2 Flute

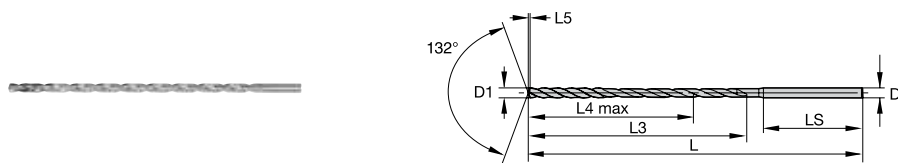

For information on L, L3, and L4 max, see page C46

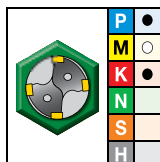

● first choice  
○ alternate choice

grade WU20PD TiAlN		D1 diameter				D	L3	L4 max	L5	LS	L
order #	catalog #	mm	in	fraction	wire size						
3899626	TDD105Z03000	3,000	.1181	—	—	3	52	45	0,6	30	86
3899627	TDD105Z03175	3,175	.1250	1/8	—	4	67	58	0,6	32	105
3899628	TDD105Z03500	3,500	.1378	—	—	4	68	59	0,7	32	105
3899629	TDD105Z03571	3,571	.1406	9/64	—	4	68	59	0,7	32	105
3899630	TDD105Z03800	3,800	.1496	—	—	4	69	60	0,8	32	105
3899631	TDD105Z03970	3,970	.1563	5/32	—	4	70	60	0,8	32	105
3899632	TDD105Z04000	4,000	.1575	—	—	4	70	60	0,8	32	105
3899683	TDD105Z04039	4,039	.1590	—	21	5	84	73	0,8	34	124
3899684	TDD105Z04300	4,300	.1693	—	—	5	85	74	0,9	34	124
3899685	TDD105Z04500	4,500	.1772	—	—	5	85	74	0,9	34	124
3899686	TDD105Z04623	4,623	.1820	—	14	5	86	75	1,0	34	124
3899687	TDD105Z04763	4,763	.1875	3/16	—	5	86	75	1,0	34	124
3899688	TDD105Z05000	5,000	.1969	—	—	5	87	75	1,0	34	124
3899689	TDD105Z05159	5,159	.2031	13/64	—	6	101	88	1,1	36	143
3899690	TDD105Z05410	5,410	.2130	—	3	6	102	89	1,1	36	143
3899691	TDD105Z05500	5,500	.2165	—	—	6	102	89	1,1	36	143
3899692	TDD105Z05558	5,558	.2188	7/32	—	6	102	89	1,2	36	143
3899693	TDD105Z05800	5,800	.2283	—	—	6	103	89	1,2	36	143
3899694	TDD105Z06000	6,000	.2362	—	—	6	104	90	1,2	36	143
3899695	TDD105Z06200	6,200	.2441	—	—	7	118	103	1,3	38	162
3899696	TDD105Z06350	6,350	.2500	1/4	E	7	119	104	1,3	38	162
3899697	TDD105Z06500	6,500	.2559	—	—	7	119	104	1,4	38	162
3899698	TDD105Z06528	6,528	.2570	—	F	7	119	104	1,4	38	162
3899699	TDD105Z06746	6,746	.2656	17/64	—	7	120	104	1,4	38	162
3899700	TDD105Z06800	6,800	.2677	—	—	7	120	104	1,4	38	162
3899701	TDD105Z06909	6,909	.2720	—	I	7	121	105	1,4	38	162
3899702	TDD105Z07000	7,000	.2756	—	—	7	121	105	1,5	38	162
3900612	TDD105Z07145	7,145	.2813	9/32	—	8	135	118	1,5	40	181
3900633	TDD105Z07500	7,500	.2953	—	—	8	136	119	1,6	40	181
3899764	TDD106Z07500	7,500	.2953	—	—	8	174	157	1,6	40	221
3900635	TDD105Z07938	7,938	.3125	5/16	—	8	138	120	1,7	40	181
3900636	TDD105Z08000	8,000	.3150	—	—	8	138	120	1,7	40	181
3900637	TDD105Z08334	8,334	.3281	21/64	—	9	153	134	1,8	42	200
3900638	TDD105Z08433	8,433	.3320	—	Q	9	153	134	1,8	42	200
3900639	TDD105Z08500	8,500	.3346	—	—	9	153	134	1,8	42	200
3900640	TDD105Z08733	8,733	.3438	11/32	—	9	154	134	1,8	42	200
3900641	TDD105Z09000	9,000	.3543	—	—	9	155	135	1,9	42	200
3900643	TDD105Z09500	9,500	.3740	—	—	10	170	149	2,0	44	219
3900644	TDD105Z09525	9,525	.3750	3/8	—	10	170	149	2,0	44	219
3900645	TDD105Z09750	9,750	.3839	—	—	10	171	149	2,1	44	219
3900647	TDD105Z10000	10,000	.3937	—	—	10	172	150	2,1	44	219
3900648	TDD105Z10200	10,200	.4016	—	—	11	186	163	2,2	46	238
3900649	TDD105Z10320	10,317	.4062	13/32	—	11	187	164	2,2	46	238
3900650	TDD105Z10500	10,500	.4134	—	—	11	187	164	2,2	46	238
3900652	TDD105Z11000	11,000	.4331	—	—	11	189	165	2,3	46	238
3900653	TDD105Z11113	11,113	.4375	7/16	—	12	203	178	2,4	48	257
3900654	TDD105Z11500	11,500	.4528	—	—	12	204	179	2,4	48	257
3900656	TDD105Z12000	12,000	.4724	—	—	12	206	180	2,5	48	257
3900657	TDD105Z12304	12,304	.4844	31/64	—	13	221	194	2,6	50	276
3900658	TDD105Z12500	12,500	.4921	—	—	13	221	194	2,7	50	276
3900659	TDD105Z12700	12,700	.5000	1/2	—	13	222	195	2,7	50	276
3900660	TDD105Z13000	13,000	.5118	—	—	13	223	195	2,8	50	276



## TOP DRILL Deep Hole • 20 x D • TDD106 • 2 Flute

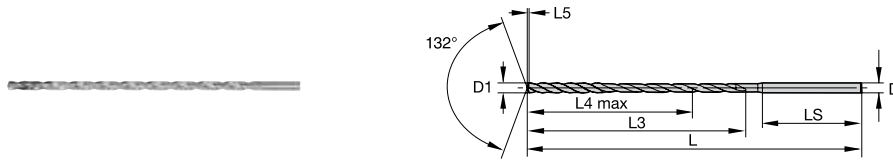

For information on L, L3, and L4 max, see page C46

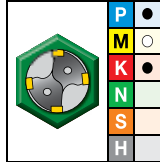

● first choice  
○ alternate choice

grade WU20PD TiAlN		D1 diameter				D	L3	L4 max	L5	LS	L
order #	catalog #	mm	in	fraction	wire size						
3899782	TDD106Z03000	3,000	.1181	—	—	3	67	60	0,6	30	101
3899803	TDD106Z03175	3,175	.1250	1/8	—	4	83	74	0,6	32	125
3899804	TDD106Z03500	3,500	.1378	—	—	4	86	77	0,7	32	125
3899805	TDD106Z03571	3,571	.1406	9/64	—	4	86	77	0,7	32	125
3899806	TDD106Z03800	3,800	.1496	—	—	4	88	79	0,8	32	125
3899807	TDD106Z03970	3,970	.1563	5/32	—	4	89	79	0,8	32	125
3899808	TDD106Z04000	4,000	.1575	—	—	4	90	80	0,8	32	125
3899809	TDD106Z04039	4,039	.1590	—	21	5	104	93	0,8	34	149
3899810	TDD106Z04300	4,300	.1693	—	—	5	106	95	0,9	34	149
3899811	TDD106Z04500	4,500	.1772	—	—	5	108	97	0,9	34	149
3899812	TDD106Z04623	4,623	.1820	—	14	5	109	98	1,0	34	149
3899813	TDD106Z04763	4,763	.1875	3/16	—	5	110	99	1,0	34	149
3899814	TDD106Z05000	5,000	.1969	—	—	5	112	100	1,0	34	149
3899815	TDD106Z05159	5,159	.2031	13/64	—	6	127	114	1,1	36	173
3899816	TDD106Z05410	5,410	.2130	—	3	6	129	116	1,1	36	173
3899818	TDD106Z05500	5,500	.2165	—	—	6	130	117	1,1	36	173
3899819	TDD106Z05558	5,558	.2188	7/32	—	6	130	117	1,2	36	173
3899820	TDD106Z05800	5,800	.2283	—	—	6	132	118	1,2	36	173
3899821	TDD106Z06000	6,000	.2362	—	—	6	134	120	1,2	36	173
3899822	TDD106Z06200	6,200	.2441	—	—	7	149	134	1,3	38	197
3899823	TDD106Z06350	6,350	.2500	1/4	E	7	151	136	1,3	38	197
3899824	TDD106Z06500	6,500	.2559	—	—	7	152	137	1,4	38	197
3899825	TDD106Z06528	6,528	.2570	—	F	7	152	137	1,4	38	197
3899826	TDD106Z06746	6,746	.2656	17/64	—	7	154	138	1,4	38	197
3899827	TDD106Z06800	6,800	.2677	—	—	7	154	138	1,4	38	197
3899829	TDD106Z07000	7,000	.2756	—	—	7	156	140	1,5	38	197
3899763	TDD106Z07145	7,145	.2813	9/32	—	8	171	154	1,5	40	221
3899765	TDD106Z07541	7,541	.2969	19/64	—	8	174	157	1,6	40	221
3899766	TDD106Z07938	7,938	.3125	5/16	—	8	177	159	1,7	40	221
3899767	TDD106Z08000	8,000	.3150	—	—	8	178	160	1,7	40	221
3899769	TDD106Z08433	8,433	.3320	—	Q	9	195	176	1,8	42	245
3899770	TDD106Z08500	8,500	.3346	—	—	9	196	177	1,8	42	245
3899771	TDD106Z08733	8,733	.3438	11/32	—	9	198	178	1,8	42	245
3899772	TDD106Z09000	9,000	.3543	—	—	9	200	180	1,9	42	245
3899784	TDD106Z09500	9,500	.3740	—	—	10	218	197	2,0	44	269
3899785	TDD106Z09525	9,525	.3750	3/8	—	10	218	197	2,0	44	269
3899787	TDD106Z09921	9,921	.3906	25/64	—	10	221	199	2,1	44	269
3899788	TDD106Z10000	10,000	.3937	—	—	10	222	200	2,1	44	269
3899789	TDD106Z10200	10,200	.4016	—	—	11	237	214	2,2	46	293
3899790	TDD106Z10320	10,317	.4062	13/32	—	11	238	215	2,2	46	293
3899791	TDD106Z10500	10,500	.4134	—	—	11	240	217	2,2	46	293
3899792	TDD106Z10716	10,716	.4219	27/64	—	11	242	219	2,3	46	293
3899793	TDD106Z11000	11,000	.4331	—	—	11	244	220	2,3	46	293
3899794	TDD106Z11113	11,113	.4375	7/16	—	12	259	234	2,4	48	317
3899795	TDD106Z11500	11,500	.4528	—	—	12	262	237	2,4	48	317
3899797	TDD106Z12000	12,000	.4724	—	—	12	266	240	2,5	48	317
3899799	TDD106Z12500	12,500	.4921	—	—	13	284	257	2,7	50	341
3899800	TDD106Z12700	12,700	.5000	1/2	—	13	285	258	2,7	50	341
3899801	TDD106Z13000	13,000	.5118	—	—	13	288	260	2,8	50	341

INDEXABLE MILLING

SOLID END MILLING

HOLEMAKING

TAPPING

TURNING

TOP DRILL Deep Hole • 25 x D • TDD107 • 2 Flute

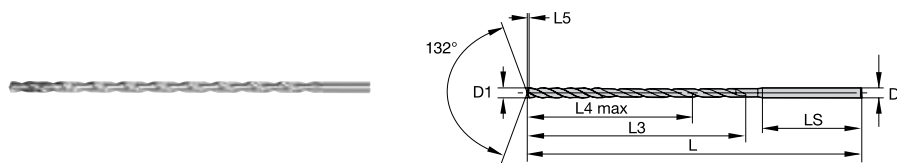

For information on L, L3, and L4 max, see page C46

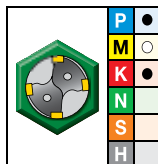

● first choice  
○ alternate choice

grade WU20PD TiAlN		D1 diameter				D	L3	L4 max	L5	LS	L
order #	catalog #	mm	in	fraction	wire size						
3899708	TDD107Z03000	3,000	.1181	—	—	3	82	75	0,6	30	116
3899709	TDD107Z03175	3,175	.1250	1/8	—	4	99	90	0,6	32	145
3899710	TDD107Z03500	3,500	.1378	—	—	4	103	94	0,7	32	145
3899712	TDD107Z03800	3,800	.1496	—	—	4	107	98	0,8	32	145
3899733	TDD107Z03970	3,970	.1563	5/32	—	4	109	99	0,8	32	145
3899734	TDD107Z04000	4,000	.1575	—	—	4	110	100	0,8	32	145
3899737	TDD107Z04500	4,500	.1772	—	—	5	130	119	0,9	34	174
3899739	TDD107Z04763	4,763	.1875	3/16	—	5	134	123	1,0	34	174
3899740	TDD107Z05000	5,000	.1969	—	—	5	137	125	1,0	34	174
3899743	TDD107Z05500	5,500	.2165	—	—	6	157	144	1,1	36	203
3899744	TDD107Z05558	5,558	.2188	7/32	—	6	158	145	1,2	36	203
3899745	TDD107Z05800	5,800	.2283	—	—	6	161	147	1,2	36	203
3899746	TDD107Z06000	6,000	.2362	—	—	6	164	150	1,2	36	203
3899748	TDD107Z06350	6,350	.2500	1/4	E	7	182	167	1,3	38	232
3899749	TDD107Z06500	6,500	.2559	—	—	7	184	169	1,4	38	232
3899750	TDD107Z06528	6,528	.2570	—	F	7	185	170	1,4	38	232
3899753	TDD107Z06909	6,909	.2720	—	I	7	190	174	1,4	38	232
3899754	TDD107Z07000	7,000	.2756	—	—	7	191	175	1,5	38	232
3899567	TDD107Z07541	7,541	.2969	19/64	—	8	212	195	1,6	40	261
3899569	TDD107Z08000	8,000	.3150	—	—	8	218	200	1,7	40	261
3899571	TDD107Z08433	8,433	.3320	—	Q	9	237	218	1,8	42	290
3899572	TDD107Z08500	8,500	.3346	—	—	9	238	219	1,8	42	290
3899604	TDD107Z09000	9,000	.3543	—	—	9	245	225	1,9	42	290
3899606	TDD107Z09500	9,500	.3740	—	—	10	265	244	2,0	44	319
3899607	TDD107Z09525	9,525	.3750	3/8	—	10	266	245	2,0	44	319
3899610	TDD107Z10000	10,000	.3937	—	—	10	272	250	2,1	44	319
3899611	TDD107Z10300	10,300	.4055	—	—	11	290	267	2,2	46	348
3899612	TDD107Z10320	10,320	.4063	13/32	—	11	290	267	2,2	46	348
3899613	TDD107Z10500	10,500	.4134	—	—	11	292	269	2,2	46	348
3899614	TDD107Z10716	10,716	.4219	27/64	—	11	295	272	2,3	46	348
3899615	TDD107Z11000	11,000	.4331	—	—	11	299	275	2,3	46	348
3899616	TDD107Z11113	11,113	.4375	7/16	—	12	314	289	2,4	48	377
3899617	TDD107Z11500	11,500	.4528	—	—	12	319	294	2,4	48	377
3899619	TDD107Z12000	12,000	.4724	—	—	12	326	300	2,5	48	377
3899621	TDD107Z12500	12,500	.4921	—	—	13	346	319	2,7	50	406
3899622	TDD107Z12700	12,700	.5000	1/2	—	13	349	322	2,7	50	406
3899623	TDD107Z13000	13,000	.5118	—	—	13	353	325	2,8	50	406

INDEXABLE MILLING

SOLID END MILLING

HOLEMAKING

TAPPING

TURNING

## TOP DRILL Deep Hole • 30 x D • TDD108 • 2 Flute

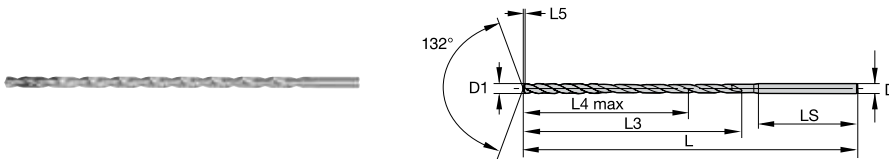

For information on L, L3, and L4 max, see page C46

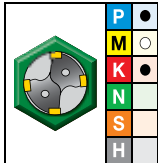

● first choice  
○ alternate choice

grade WU20PD TiAlN		D1 diameter					D	L3	L4 max	L5	LS	L
order #	catalog #	mm	in	fraction	wire size							
3899539	TDD108Z03000	3,000	.1181	—	—	3	97	90	0,6	30	131	
3899540	TDD108Z03175	3,175	.1250	1/8	—	4	115	106	0,6	32	165	
3899541	TDD108Z03500	3,500	.1378	—	—	4	121	112	0,7	32	165	
3899573	TDD108Z03800	3,800	.1496	—	—	4	126	117	0,8	32	165	
3899574	TDD108Z03970	3,970	.1563	5/32	—	4	129	119	0,8	32	165	
3899575	TDD108Z04000	4,000	.1575	—	—	4	130	120	0,8	32	165	
3899576	TDD108Z04039	4,039	.1590	—	21	5	144	133	0,8	34	199	
3899577	TDD108Z04300	4,300	.1693	—	—	5	149	138	0,9	34	199	
3899578	TDD108Z04500	4,500	.1772	—	—	5	153	142	0,9	34	199	
3899579	TDD108Z04623	4,623	.1820	—	14	5	155	144	1,0	34	199	
3899580	TDD108Z04763	4,763	.1875	3/16	—	5	157	146	1,0	34	199	
3899581	TDD108Z05000	5,000	.1969	—	—	5	162	150	1,0	34	199	
3899582	TDD108Z05159	5,159	.2031	13/64	—	6	179	166	1,1	36	233	
3899583	TDD108Z05410	5,410	.2130	—	3	6	183	170	1,1	36	233	
3899584	TDD108Z05500	5,500	.2165	—	—	6	185	172	1,1	36	233	
3899586	TDD108Z05800	5,800	.2283	—	—	6	190	176	1,2	36	233	
3899587	TDD108Z06000	6,000	.2362	—	—	6	194	180	1,2	36	233	
3899588	TDD108Z06200	6,200	.2441	—	—	7	211	196	1,3	38	267	
3899589	TDD108Z06350	6,350	.2500	1/4	E	7	214	199	1,3	38	267	
3899590	TDD108Z06500	6,500	.2559	—	—	7	217	202	1,4	38	267	
3899592	TDD108Z06746	6,746	.2656	17/64	—	7	221	205	1,4	38	267	
3899593	TDD108Z06800	6,800	.2677	—	—	7	222	206	1,4	38	267	
3899594	TDD108Z06909	6,909	.2720	—	I	7	224	208	1,4	38	267	
3899595	TDD108Z07000	7,000	.2756	—	—	7	226	210	1,5	38	267	
3899600	TDD108Z07145	7,145	.2813	9/32	—	8	242	225	1,5	40	301	
3899601	TDD108Z07500	7,500	.2953	—	—	8	249	232	1,6	40	301	
3899653	TDD108Z07938	7,938	.3125	5/16	—	8	257	239	1,7	40	301	
3899654	TDD108Z08000	8,000	.3150	—	—	8	258	240	1,7	40	301	
3899657	TDD108Z08500	8,500	.3346	—	—	9	281	262	1,8	42	335	
3899659	TDD108Z09000	9,000	.3543	—	—	9	290	270	1,9	42	335	
3899661	TDD108Z09500	9,500	.3740	—	—	10	313	292	2,0	44	369	
3899662	TDD108Z09525	9,525	.3750	3/8	—	10	313	292	2,0	44	369	
3899663	TDD108Z09750	9,750	.3839	—	—	10	317	295	2,1	44	369	
3899665	TDD108Z10000	10,000	.3937	—	—	10	322	300	2,1	44	369	
3899666	TDD108Z10200	10,200	.4016	—	—	11	339	316	2,2	46	403	
3899667	TDD108Z10320	10,317	.4062	13/32	—	11	341	318	2,2	46	403	
3899668	TDD108Z10500	10,500	.4134	—	—	11	345	322	2,2	46	403	
3899670	TDD108Z11000	11,000	.4331	—	—	11	354	330	2,3	46	403	
3899671	TDD108Z11113	11,113	.4375	7/16	—	12	370	345	2,4	48	437	
3899672	TDD108Z11500	11,500	.4528	—	—	12	377	352	2,4	48	437	
3899674	TDD108Z12000	12,000	.4724	—	—	12	386	360	2,5	48	437	
3899675	TDD108Z12304	12,304	.4844	31/64	—	13	405	378	2,6	50	471	
3899676	TDD108Z12500	12,500	.4921	—	—	13	409	382	2,7	50	471	
3899677	TDD108Z12700	12,700	.5000	1/2	—	13	412	385	2,7	50	471	
3899678	TDD108Z13000	13,000	.5118	—	—	13	418	390	2,8	50	471	

INDEXABLE MILLING

SOLID END MILLING

HOLEMAKING

TAPPING

TURNING

Application Data • TDD Series • WU20PD • Through Coolant • Inch

Material Group	Cutting Speed – vc Range – SFM			Recommended Feed Rate (f) by Diameter									
	min	-	max	Tool Diameter (inch)	0.125-1/8	0.188-3/16	0.250-1/4	0.313-5/16	0.375-3/8	0.500-1/2	0.625-5/8	0.750-3/4	
	<b>P</b>	1	295	-	425	IPR	0.003-0.005	0.005-0.007	0.007-0.008	0.008-0.009	0.009-0.010	0.010-0.011	0.011-0.012
	2	260	-	375	IPR	0.003-0.005	0.005-0.007	0.007-0.008	0.008-0.009	0.009-0.010	0.010-0.011	0.011-0.012	0.012-0.013
	3	230	-	360	IPR	0.002-0.004	0.004-0.006	0.006-0.007	0.007-0.008	0.008-0.009	0.009	0.009-0.010	0.010-0.011
	4	215	-	310	IPR	0.002-0.004	0.004-0.006	0.006-0.007	0.007-0.008	0.008-0.009	0.009	0.009-0.010	0.010-0.011
<b>K</b>	1	345	-	475	IPR	0.004-0.006	0.006-0.008	0.008-0.010	0.010-0.011	0.011-0.012	0.012-0.013	0.013-0.014	0.014-0.015
	2	280	-	390	IPR	0.004-0.006	0.006-0.008	0.008-0.010	0.010-0.011	0.011-0.012	0.012-0.013	0.013-0.014	0.014-0.015
	3	325	-	460	IPR	0.004-0.006	0.006-0.008	0.008-0.010	0.010-0.011	0.011-0.012	0.012-0.013	0.013-0.014	0.014-0.015

Application Data • TDD Series • WU20PD™ • Through Coolant • Metric

Material Group	Cutting Speed – vc Range – m/min			Recommended Feed Rate (f) by Diameter									
	min	-	max	Tool Diameter (mm)	3,0	4,0	6,0	8,0	10,0	12,0	16,0	20,0	
	<b>P</b>	1	90	-	130	mm/r	0,08-0,12	0,12-0,18	0,18-0,20	0,20-0,22	0,22-0,25	0,25-0,28	0,28-0,30
	2	80	-	115	mm/r	0,08-0,12	0,12-0,18	0,18-0,20	0,20-0,22	0,22-0,25	0,25-0,28	0,28-0,30	0,30-0,34
	3	70	-	110	mm/r	0,05-0,10	0,10-0,16	0,16-0,18	0,18-0,20	0,20-0,22	0,22-0,24	0,24-0,26	0,26-0,28
	4	65	-	95	mm/r	0,05-0,10	0,10-0,16	0,16-0,18	0,18-0,20	0,20-0,22	0,22-0,24	0,24-0,26	0,26-0,28
<b>K</b>	1	105	-	145	mm/r	0,10-0,15	0,15-0,20	0,20-0,25	0,25-0,28	0,28-0,30	0,30-0,33	0,33-0,36	0,36-0,38
	2	85	-	120	mm/r	0,10-0,15	0,15-0,20	0,20-0,25	0,25-0,28	0,28-0,30	0,30-0,33	0,33-0,36	0,36-0,38
	3	100	-	140	mm/r	0,10-0,15	0,15-0,20	0,20-0,25	0,25-0,28	0,28-0,30	0,30-0,33	0,33-0,36	0,36-0,38

Inch tolerance			
D1	D1 tolerance m7	D	D tolerance h6
> .1181-.2362	.0000/-.0005	> .1181-.2362	.0000/-.0003
> .2362-.3937	.0000/-.0006	> .2362-.3937	.0000/-.0004
> .3937-.5118	.0000/-.0007	> .3937-.5118	.0000/-.0004

Metric tolerance			
nominal size range	D1 tolerance	D1 tolerance	D tolerance h6
>3-6	0,000/-0,012	>3-6	0,000/-0,008
>6-10	0,000/-0,015	>6-10	0,000/-0,009
>10-13	0,000/-0,018	>10-13	0,000/-0,011

## Deep-Hole Drills Application Rules

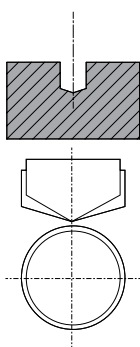

### 1) Pilot Drill Hole — IMPORTANT!

- The point angle of the pilot drill must be greater than one of the following deep-hole drills to protect its cutting corners.
- The diameter size of the pilot drill must be greater than one of the deep-hole drills to enable easy fit and protect margin lands. The required difference in diameter is covered by design with the different position of tolerance.
- Drill  $\varnothing$  = nominal  $\varnothing$  up to nominal  $+0.0004"$  ( $+0,010\text{mm}$ ).
- Depth of pilot hole: minimum  $2 \times D$ .
- Deeper pilot holes are preferable.

#### Recommendations:

- Use a conical (TDS\*) or split-point drill to pilot (do not use a TDG, VariDrill™, or TDS  $12 \times D$  or any competitive drill).
- Check the pilot drill for wear, which can lead to premature wear on the TDD10\* cutting edge and possibly catastrophic failure.
- TOP DRILL S™ for steel or cast iron (TDS4\* series) and TOP DRILL S +™ for multiple applications (TDS501\* series  $3 \times D$  and TD502\* series  $5 \times D$ ) with a  $140^\circ$  point angle are recommended.
- TDS503\* series  $8 \times D$  and TDS504\* series  $12 \times D$  is not recommended as the point angle is  $132^\circ$ !

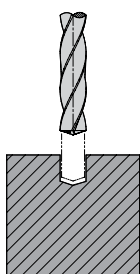

### 2) Feed TDD10\* into Pilot Hole

- Max 500 RPM and recommended feed rate; no rapid traverse.
- Run counter-clockwise, especially in horizontal applications to protect the cutting edge, when entering the pilot hole.
- Depth:  $.039"$  (1mm) above the bottom of pilot hole.
- Feed TDD10\* into pilot hole

#### Recommendations:

- Reduce cutting speed to minimize imbalances in machine spindle/adaptor!

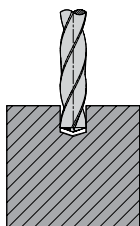

### 3) Drill Hole

Cutting Parameters: Start recommended speed and feed rate at  $.039"$  (1mm) from the bottom of the pilot hole, clockwise.

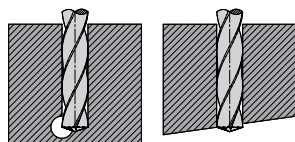

#### Recommendations:

- DO NOT PECK OR DWELL up to  $30 \times D$ !
- With long-chipping steel materials, it may be necessary to increase feed rate by 10–20% to provide optimal chip control.
- For long-chipping aluminum materials, it may be necessary to decrease feed rate and increase speed.
- Reduce feed rate on angled exits and crossholes by 50–60%.

*HP feed recommendations are usually higher than with competitive SC drills!*

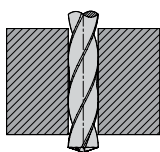

### 4) Drill Retraction

Cutting Parameters: 50–500 RPM and feed rate 2–6 m/min.

#### Recommendations:

To achieve the best tool performance, we recommend using the deep-hole drill with a hydraulic chuck.

*Reduce cutting speed to minimize imbalances in machine spindle/adaptor!*

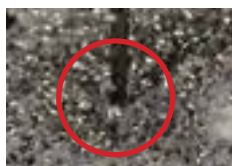

### 5) Vertical Applications

- If the pilot holes are close to each other, chips can fall into the neighboring hole.
- Do not enter a pilot hole that might contain chips with a deep hole drill to avoid chip jamming, wear, or breakage.
- If required holes are close to each other, use smart drilling strategies, make sure the pilot holes are getting properly cleaned, or switch to horizontal drilling.

*Horizontal drilling process preferred for optimum chip evacuation.*

## Deep-Hole Drills Application Rules



### 6) Coolant

- For increased stability, the coolant channels of the TDD10\* are smaller than on typical WIDIA™ drills.
- Steady supply of coolant delivered to the cutting edges necessary. If coolant supply is not steady or is unequal through both channels, check:
  - Coolant filtering system.
  - Sealing of adapter/spindle.
  - Chips blocking the coolant hole on the drill shank.
- Make sure that the coolant supply reaches the cutting edge before drilling begins.
- Pressure by diameter: <5mm 40–50 bar maximum; >5mm 25 bar minimum.

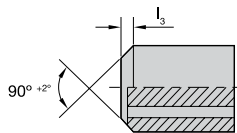

MQL back end according to DIN 69090-3

### 7) Minimal Quantity Lubrication

- On MQL applications, make sure that the coolant is directly supplied from the chuck into the back end of the drill shank (without gap) to avoid leakage.
- Pressure should be between 1–10 bar depending on coolant hole size.
- Spray contains an amount of oil less than 50 ml/h.
- If required, the shank can be evenly optimized for MQL applications with enlarged 90° chamfer instead of 40°.



### 8) Shanks

- Other than normal SC Drills, TDD10\* series have a “Z” shank, increasing with 1mm steps.
- For drills with uneven shank size, use reduction sleeves to adapt the shank to the customer’s toolholder.
- The clamping force is better with increasing diameter.
- If required, DIN shanks (even, 2mm steps) are available as custom solutions.

Achieve the best tool performance with hydraulic chucks.

D1	12mm hydraulic reducer sleeve		20mm hydraulic reducer sleeve		25mm hydraulic reducer sleeve		32mm hydraulic reducer sleeve		.500" hydraulic reducer sleeve		.750" hydraulic reducer sleeve	
	order number	catalog number	order number	catalog number	order number	catalog number	order number	catalog number	order number	catalog number	order number	catalog number
3	3026450	12MHC030M	3026648	20MHC030M	3026662	25MHC030M	–	–	2248993	50HC030M	2248995	75HC030M
4	3026451	12MHC040M	3026649	20MHC040M	3026663	25MHC040M	–	–	1606050	50HC040M	2248996	75HC040M
5	3026452	12MHC050M	3026650	20MHC050M	3026664	25MHC050M	–	–	2248994	50HC050M	2248997	75HC050M
6	3026643	12MHC060M	3026651	20MHC060M	3026665	25MHC060M	3026675	32MHC060M	1606061	50HC060M	1093271	75HC060M
7	3026644	12MHC070M	3026652	20MHC070M	3026666	25MHC070M	3026676	32MHC070M	–	–	–	–
8	3026645	12MHC080M	3026653	20MHC080M	3026667	25MHC080M	3026677	32MHC080M	1606062	50HC080M	1093272	75HC080M
9	3026646	12MHC090M	3026654	20MHC090M	3026668	25MHC090M	3026678	32MHC090M	–	–	–	–
10	3026647	12MHC100M	3026655	20MHC100M	3026669	25MHC100M	3026679	32MHC100M	1606064	50HC100M	1093273	75HC100M
11	–	–	3026656	20MHC110M	–	–	3026680	32MHC110M	–	–	–	–
12	–	–	3026657	20MHC120M	3026669	25MHC120M	3026681	32MHC120M	–	–	1093524	75HC120M
13	–	–	3026658	20MHC130M	–	–	3026682	32MHC130M	–	–	–	–
14	–	–	3026659	20MHC140M	3026671	25MHC140M	3026683	32MHC140M	–	–	1093525	75HC140M
15	–	–	3026660	20MHC150M	–	–	3026684	32MHC150M	–	–	–	–
16	–	–	3026661	20MHC160M	3026672	25MHC160M	3026685	32MHC160M	–	–	1093526	75HC160M

## Shank Designs to DIN 6535

INDEXABLE MILLING



Form HE,  
2° angle design F

SOLID END MILLING



Form HA,  
straight design A

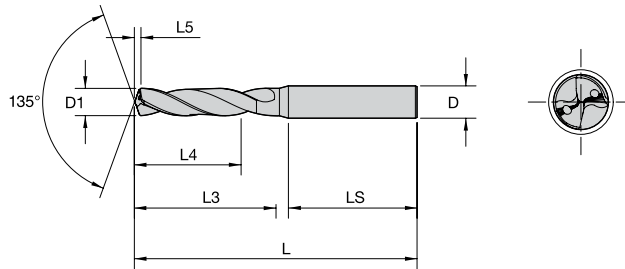

inch Ø		DIN 6535		SHORT* ~3 x D			LONG* ~5 x D			EXTRA LONG** ~8 x D		
D1 min	D1 max	D	LS	L	L3	L4 max	L	L3	L4 max	L	L3	L4 max
.0394	.0551	.1575	1.10	2.28	.28	.20	2.28	.35	.24	2.28	.47	.39
.0552	.0748	.1575	1.10	2.28	.35	.24	2.28	.47	.35	2.28	.71	.59
.0748	.0906	.1575	1.10	2.28	.51	.35	2.28	.71	.55	2.60	1.02	.87
.0906	.1177	.1575	1.10	2.28	.67	.47	2.28	.87	.67	2.60	1.18	.98
.1181	.1476	.2362	1.42	2.44	.79	.55	2.60	1.10	.91	3.07	1.57	1.30
.1477	.1870	.2362	1.42	2.60	.94	.67	2.91	1.42	1.14	3.43	1.93	1.61
.1870	.2362	.2362	1.42	2.60	1.10	.79	3.23	1.73	1.38	3.70	2.20	1.89
.2363	.2756	.3150	1.42	3.11	1.34	.94	3.58	2.09	1.69	4.13	2.64	2.24
.2756	.3150	.3150	1.42	3.11	1.61	1.14	3.58	2.09	1.69	4.33	2.83	2.40
.3150	.3937	.3937	1.57	3.50	1.85	1.38	4.06	2.40	1.93	4.80	3.15	2.68
.3937	.4724	.4724	1.77	4.02	2.17	1.57	4.65	2.80	2.20	5.55	3.70	3.11
.4725	.5512	.5512	1.77	4.21	2.36	1.69	4.88	3.03	2.36	6.10	4.25	3.58
.5512	.6299	.6299	1.89	4.53	2.56	1.77	5.24	3.27	2.48	6.73	4.76	3.98
.6300	.7087	.7087	1.89	4.84	2.87	2.01	5.63	3.66	2.80	7.28	5.32	4.45
.7087	.7874	.7874	1.97	5.16	3.11	2.17	6.02	3.98	3.03	7.87	5.83	4.88
.7874	.8661	.7874	1.97	5.55	3.39	2.36	6.57	4.41	3.35	8.54	6.38	5.35
.8662	.9843	.9843	2.20	6.02	3.74	2.56	7.24	4.96	3.86	9.37	7.09	5.91

mm Ø		DIN 6535		SHORT* ~3 x D			REGULAR* ~5 x D			LONG** ~8 x D		
D1 min	D1 max	D	LS min	L	L3	L4	L	L3	L4	L	L3	L4
1,000	1,400	4	28	58	7	5	58	9	6	58	12	10
1,401	1,900	4	28	58	9	6	58	12	9	58	18	15
1,901	2,300	4	28	58	13	9	58	18	14	66	26	22
2,301	2,990	4	28	58	17	12	58	22	17	66	30	25
3,000	3,750	6	36	62	20	14	66	28	23	78	40	33
3,751	4,750	6	36	66	24	17	74	36	29	87	49	41
4,751	6,000	6	36	66	28	20	82	44	35	94	56	48
6,001	7,000	8	36	79	34	24	91	53	43	105	67	57
7,001	8,000	8	36	79	41	29	91	53	43	110	72	61
8,001	10,000	10	40	89	47	35	103	61	49	122	80	68
10,001	12,000	12	45	102	55	40	118	71	56	141	94	79
12,001	14,000	14	45	107	60	43	124	77	60	155	108	91
14,001	16,000	16	48	115	65	45	133	83	63	171	121	101
16,001	18,000	18	48	123	73	51	143	93	71	185	135	113
18,001	20,000	20	50	131	79	55	153	101	77	200	148	124
20,001	22,000	20	50	141	86	60	167	112	85	217	162	136
22,001	25,000	25	56	153	95	65	184	126	98	238	180	150

\* D1 < 20mm to DIN 6537K  
D1 > 20mm to factory standard  
\*\*To factory standard

### Tolerances of Drills and Holes

High-performance solid carbide drills with tolerances of m7 create holes with tolerances of H9. H8 can be achieved in very good conditions. The drill should be used for holes in H8, and in favorable conditions, H7 can be achieved. Solid carbide drills with H7 create holes in K9-11. Other drilling tolerances require special solid carbide drill versions.

Tolerances of diameter D1 on:  
Spiral Flute  
TDG Drill

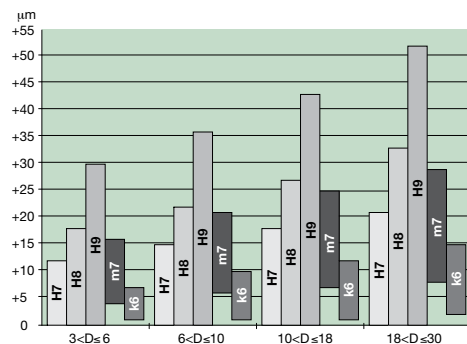



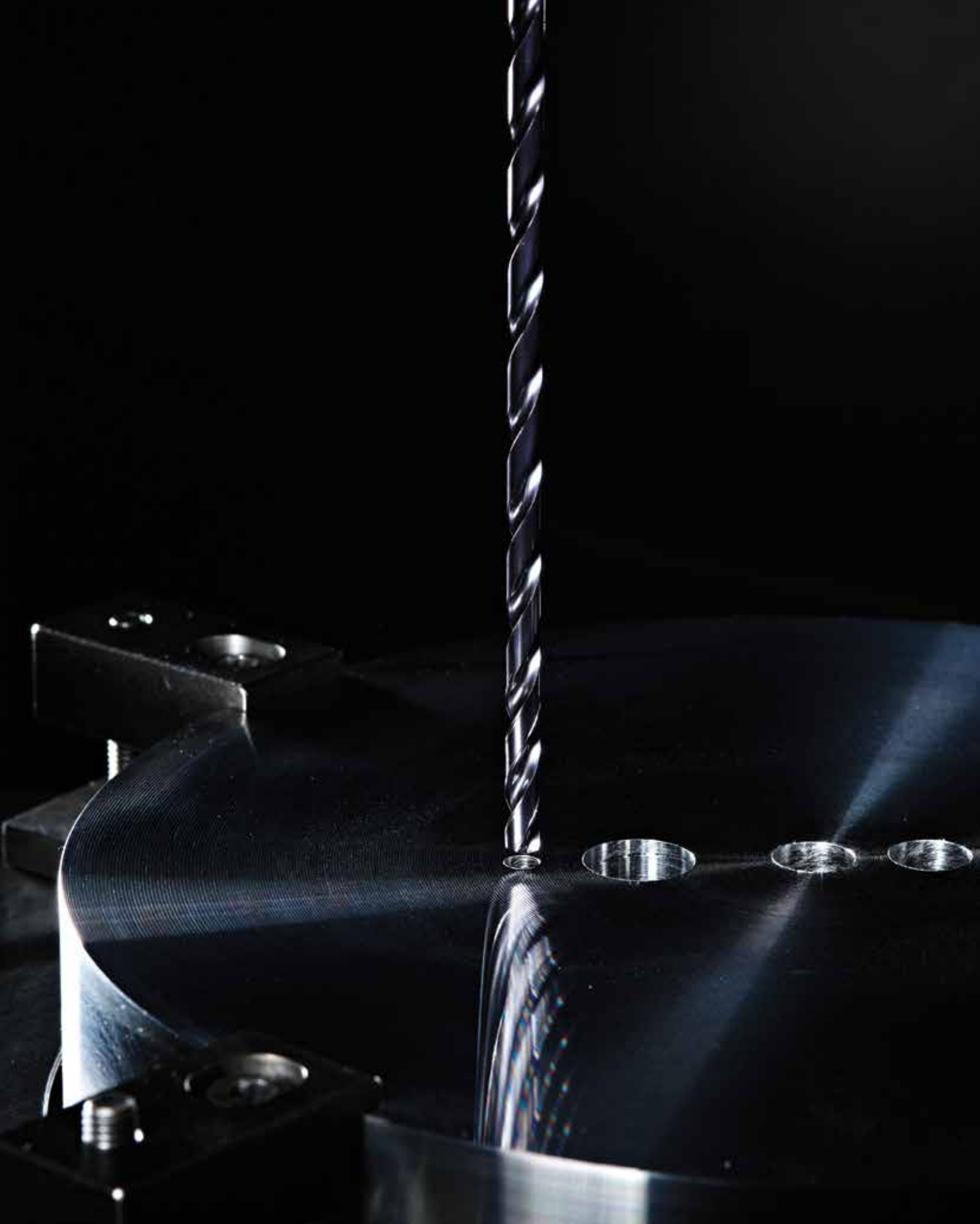



# TOP DRILL™ Modular X

TDMX

The TDMX modular drill will deliver maximum clamping stability between the carbide insert and the pocket seat, enabling safe operations under unstable conditions using material-specific point geometries and grades.



**Extra stable pocket seat design** to increase stability to securely face high demanding applications.

**Coolant channels** exit behind the cutting edge to ensure the best coolant delivery.

**Two standard screws** clamp and unclamp the insert, without disassembling the tool from the holder.

**Margin lands on the entire body length** to ensure straightness and increased hole quality.

**Polished flutes**  
Improved chip evacuation.

The TDMX modular drilling line features material-specific inserts seated in an advanced pocket seat design which maximizes the insert clamping rigidity and enables higher productivity even under unstable machining conditions.

TDMX heads can be re-conditioned to increase the total life cycle of the tool.

**PK**



First choice for steel and cast iron drilling.

**FPE**



Flat bottom drilling, stacked plates, piloting for deep hole drilling.

**MS**



First choice for stainless steel and super alloys.

# MODULAR STABILITY

## PRODUCT

### POINT GEOMETRY/GRADE

FPE / WP40PD  
PK / WP40PD  
MS / WM15PD

### DIAMETER RANGE

.629–1.574" (16–40mm)

## INDUSTRY



## MATERIALS

### FIRST CHOICE



## APPLICATIONS



DRILLING



INCLINED  
ENTRY



INCLINED  
EXIT



CROSS  
HOLES



STACKED  
PLATES



FLAT  
BOTTOM

## STEEL BODIES



## FLANGED SHANK

Increase overall drill stability in deep-drilling applications. Suitable for machining and turning centers.

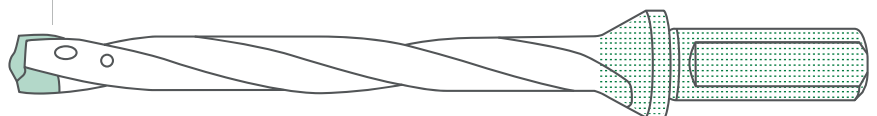

## TDMX Inserts • Catalog Numbering System

Each character in our catalog number signifies a specific trait of that product. Use the following key columns and corresponding images to easily identify which attributes apply.

TDMX	08130	PK	WP40PD
Top Drill Modular X	Insert Diameter	Insert Geometry	Grade
	Inch = .813"	PK = steel and cast iron	WIDIA™; P = Primarily steel Application <b>30 &amp; 40</b> = tough carbide, PVD coated, Modular Drilling Insert

## TDMX Bodies • Catalog Numbering System

Each character in our catalog number signifies a specific trait of that product. Use the following key columns and corresponding images to easily identify which attributes apply.

TDMX	0788	R5	SL	100
Top Drill Modular X	Drill Body Diameter	L/D Ratio	Shank Style	Shank Diameter
	Inch = .788"	5 x D	Side Lock	1.00"

TOP DRILL Modular X • 1.5 x D • Side Lock Shank • Inch

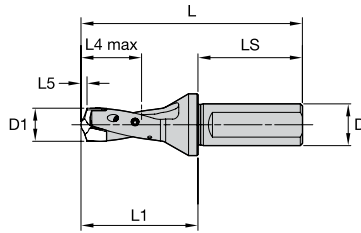

order number	catalog number	SSC	D1	D1 max	LS	D	L	L1	L4 max
6680912	TDMX0630R1SL075	A	.6300	.6692	1.97	.75	4.17	2.20	1.02
6680914	TDMX0670R1SL075	B	.6693	.7086	1.97	.75	4.29	2.32	1.06
6680915	TDMX0709R1SL100	C	.7087	.7480	2.20	1.00	4.65	2.44	1.14
6680916	TDMX0749R1SL100	D	.7481	.7874	2.20	1.00	4.76	2.56	1.18
6680917	TDMX0788R1SL100	E	.7875	.8267	2.20	1.00	4.88	2.68	1.26
6680918	TDMX0827R1SL100	F	.8268	.8661	2.20	1.00	5.00	2.80	1.30
6680919	TDMX0867R1SL100	G	.8662	.9055	2.20	1.00	5.12	2.91	1.38
6680920	TDMX0906R1SL100	H	.9056	.9448	2.20	1.00	5.24	3.03	1.42
6680931	TDMX0945R1SL125	I	.9449	.9842	2.36	1.25	5.51	3.15	1.50
6680932	TDMX0985R1SL125	J	.9843	1.0236	2.36	1.25	5.63	3.27	1.54
6680933	TDMX1024R1SL125	K	1.0237	1.0629	2.36	1.25	5.75	3.39	1.61
6680934	TDMX1063R1SL125	L	1.0630	1.1023	2.36	1.25	5.87	3.50	1.65
6680935	TDMX1103R1SL125	M	1.1024	1.1417	2.36	1.25	5.98	3.62	1.73
6680937	TDMX1142R1SL125	N	1.1418	1.1811	2.36	1.25	6.10	3.74	1.77
6680938	TDMX1182R1SL125	O	1.1812	1.2204	2.36	1.25	6.22	3.86	1.85
6680940	TDMX1221R1SL125	P	1.2205	1.2598	2.36	1.25	6.34	3.98	1.89

NOTE: SSC = Pocket Seat Reference. To correspond with the SSC on the inserts.  
L5 is dependent on the insert.

TOP DRILL Modular X • 3 x D • Side Lock Shank • Inch

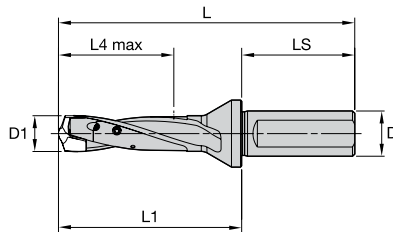

order number	catalog number	SSC	D1	D1 max	LS	D	L	L1	L4 max
6572186	TDMX0630R3SL075	A	.6300	.6692	1.97	.75	5.16	3.19	2.01
6572187	TDMX0670R3SL075	B	.6693	.7086	1.97	.75	5.35	3.39	2.13
6572188	TDMX0709R3SL100	C	.7087	.7480	2.20	1.00	5.75	3.54	2.24
6572189	TDMX0749R3SL100	D	.7481	.7874	2.20	1.00	5.94	3.74	2.36
6572190	TDMX0788R3SL100	E	.7875	.8267	2.20	1.00	6.10	3.90	2.48
6572191	TDMX0827R3SL100	F	.8268	.8661	2.20	1.00	6.30	4.09	2.60
6572192	TDMX0867R3SL100	G	.8662	.9055	2.20	1.00	6.46	4.25	2.72
6572193	TDMX0906R3SL100	H	.9056	.9448	2.20	1.00	6.65	4.45	2.83
6572194	TDMX0945R3SL125	I	.9449	.9842	2.36	1.25	6.97	4.61	2.95
6572195	TDMX0985R3SL125	J	.9843	1.0236	2.36	1.25	7.17	4.80	3.07
6572196	TDMX1024R3SL125	K	1.0237	1.0629	2.36	1.25	7.32	4.96	3.19
6572197	TDMX1063R3SL125	L	1.0630	1.1023	2.36	1.25	7.52	5.16	3.31
6572198	TDMX1103R3SL125	M	1.1024	1.1417	2.36	1.25	7.68	5.32	3.43
6572199	TDMX1142R3SL125	N	1.1418	1.1811	2.36	1.25	7.87	5.51	3.54
6572200	TDMX1182R3SL125	O	1.1812	1.2204	2.36	1.25	8.03	5.67	3.66
6572201	TDMX1221R3SL125	P	1.2205	1.2598	2.36	1.25	8.23	5.87	3.78
6572202	TDMX1260R3SL150	Q	1.2599	1.3385	2.76	1.50	8.98	6.22	4.02
6572203	TDMX1339R3SL150	R	1.3386	1.4173	2.76	1.50	9.33	6.57	4.25
6572204	TDMX1418R3SL150	S	1.4174	1.4960	2.76	1.50	9.69	6.93	4.49
6572205	TDMX1497R3SL150	T	1.4961	1.5748	2.76	1.50	10.04	7.28	4.72

NOTE: SSC = Pocket Seat Reference. To correspond with the SSC on the inserts.  
L5 is dependent on the insert.

INDEXABLE MILLING

SOLID END MILLING

HOLEMAKING

TAPPING

TURNING

## TOP DRILL Modular X • 5 x D • Side Lock Shank • Inch

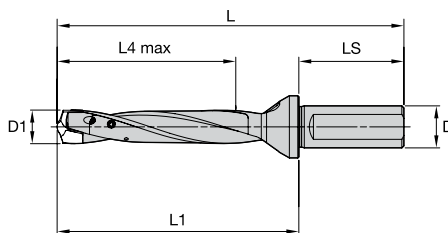

order number	catalog number	SSC	D1	D1 max	LS	D	L	L1	L4 max
6572206	TDMX0630R5SL075	A	.6300	.6692	1.97	.75	6.50	4.53	3.35
6572207	TDMX0670R5SL075	B	.6693	.7086	1.97	.75	6.77	4.80	3.54
6572208	TDMX0709R5SL100	C	.7087	.7480	2.20	1.00	7.24	5.04	3.74
6572210	TDMX0749R5SL100	D	.7481	.7874	2.20	1.00	7.52	5.32	3.94
6572231	TDMX0788R5SL100	E	.7875	.8267	2.20	1.00	7.76	5.55	4.13
6572232	TDMX0827R5SL100	F	.8268	.8661	2.20	1.00	8.03	5.83	4.33
6572233	TDMX0867R5SL100	G	.8662	.9055	2.20	1.00	8.27	6.06	4.53
6572234	TDMX0906R5SL100	H	.9056	.9448	2.20	1.00	8.54	6.34	4.72
6572235	TDMX0945R5SL125	I	.9449	.9842	2.36	1.25	8.94	6.57	4.92
6572236	TDMX0985R5SL125	J	.9843	1.0236	2.36	1.25	9.21	6.85	5.12
6572237	TDMX1024R5SL125	K	1.0237	1.0629	2.36	1.25	9.45	7.09	5.32
6572238	TDMX1063R5SL125	L	1.0630	1.1023	2.36	1.25	9.72	7.36	5.51
6572239	TDMX1103R5SL125	M	1.1024	1.1417	2.36	1.25	9.96	7.60	5.71
6572240	TDMX1142R5SL125	N	1.1418	1.1811	2.36	1.25	10.24	7.87	5.91
6572241	TDMX1182R5SL125	O	1.1812	1.2204	2.36	1.25	10.47	8.11	6.10
6572242	TDMX1221R5SL125	P	1.2205	1.2598	2.36	1.25	10.75	8.39	6.30
6572243	TDMX1260R5SL150	Q	1.2599	1.3385	2.76	1.50	11.65	8.90	6.69
6572244	TDMX1339R5SL150	R	1.3386	1.4173	2.76	1.50	12.17	9.41	7.09
6572245	TDMX1418R5SL150	S	1.4174	1.4960	2.76	1.50	12.68	9.92	7.48
6572246	TDMX1497R5SL150	T	1.4961	1.5748	2.76	1.50	13.19	10.43	7.87

NOTE: SSC = Pocket Seat Reference. To correspond with the SSC on the inserts.  
L5 is dependent on the insert.

## TOP DRILL Modular X • 8 x D • Side Lock Shank • Inch

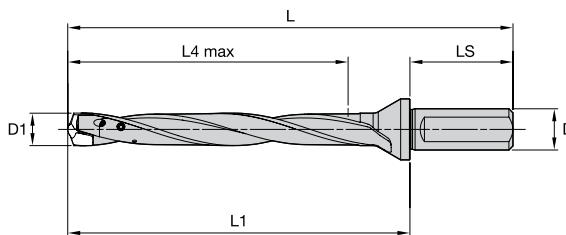

order number	catalog number	SSC	D1	D1 max	LS	D	L	L1	L4 max
6572247	TDMX0630R8SL075	A	.6300	.6692	1.97	.75	8.50	6.54	5.35
6572248	TDMX0670R8SL075	B	.6693	.7086	1.97	.75	8.90	6.93	5.67
6572249	TDMX0709R8SL100	C	.7087	.7480	2.20	1.00	9.49	7.28	5.98
6572250	TDMX0749R8SL100	D	.7481	.7874	2.20	1.00	9.88	7.68	6.30
6572251	TDMX0788R8SL100	E	.7875	.8267	2.20	1.00	10.24	8.03	6.61
6572252	TDMX0827R8SL100	F	.8268	.8661	2.20	1.00	10.63	8.43	6.93
6572253	TDMX0867R8SL100	G	.8662	.9055	2.20	1.00	10.98	8.78	7.24
6572254	TDMX0906R8SL100	H	.9056	.9448	2.20	1.00	11.38	9.17	7.56
6572255	TDMX0945R8SL125	I	.9449	.9842	2.36	1.25	11.89	9.53	7.87
6572256	TDMX0985R8SL125	J	.9843	1.0236	2.36	1.25	12.28	9.92	8.19
6572257	TDMX1024R8SL125	K	1.0237	1.0629	2.36	1.25	12.64	10.28	8.50
6572258	TDMX1063R8SL125	L	1.0630	1.1023	2.36	1.25	13.03	10.67	8.82
6572259	TDMX1103R8SL125	M	1.1024	1.1417	2.36	1.25	13.39	11.02	9.13
6572260	TDMX1142R8SL125	N	1.1418	1.1811	2.36	1.25	13.78	11.42	9.45
6572261	TDMX1182R8SL125	O	1.1812	1.2204	2.36	1.25	14.13	11.77	9.76
6572262	TDMX1221R8SL125	P	1.2205	1.2598	2.36	1.25	14.53	12.17	10.08
6572263	TDMX1260R8SL150	Q	1.2599	1.3385	2.76	1.50	15.67	12.91	10.71
6572264	TDMX1339R8SL150	R	1.3386	1.4173	2.76	1.50	16.42	13.66	11.34
6572265	TDMX1418R8SL150	S	1.4174	1.4960	2.76	1.50	17.17	14.41	11.97
6572266	TDMX1497R8SL150	T	1.4961	1.5748	2.76	1.50	17.91	15.16	12.60

NOTE: SSC = Pocket Seat Reference. To correspond with the SSC on the inserts.  
L5 is dependent on the insert.

INDEXABLE MILLING

SOLID END MILLING

HOLEMAKING

TAPPING

TURNING

TOP DRILL Modular X • 12 x D • Flanged Round Shank • Inch

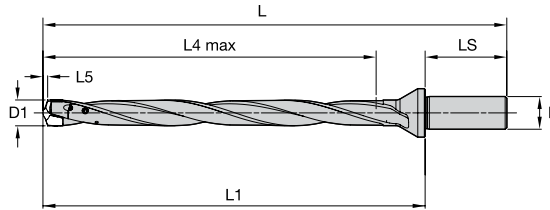

order number	catalog number	SSC	D1	D1 max	LS	D	L	L1	L4 max
6680978	TDMX0630R12SF075	A	.6300	.6692	1.97	.75	11.18	9.21	8.03
6680979	TDMX0670R12SF075	B	.6693	.7086	1.97	.75	11.73	9.76	8.50
6680980	TDMX0709R12SF100	C	.7087	.7480	2.20	1.00	12.48	10.28	8.98
6681001	TDMX0749R12SF100	D	.7481	.7874	2.20	1.00	13.03	10.83	9.45
6681002	TDMX0788R12SF100	E	.7875	.8267	2.20	1.00	13.54	11.34	9.92
6681003	TDMX0827R12SF100	F	.8268	.8661	2.20	1.00	14.09	11.89	10.39
6681004	TDMX0867R12SF100	G	.8662	.9055	2.20	1.00	14.61	12.40	10.87
6681005	TDMX0906R12SF100	H	.9056	.9448	2.20	1.00	15.16	12.95	11.34
6681006	TDMX0945R12SF125	I	.9449	.9842	2.36	1.25	15.83	13.46	11.81
6681007	TDMX0985R12SF125	J	.9843	1.0236	2.36	1.25	16.38	14.02	12.28
6681008	TDMX1024R12SF125	K	1.0237	1.0629	2.36	1.25	16.89	14.53	12.76
6681010	TDMX1063R12SF125	L	1.0630	1.1023	2.36	1.25	17.44	15.08	13.23
6681011	TDMX1103R12SF125	M	1.1024	1.1417	2.36	1.25	17.95	15.59	13.70
6681012	TDMX1142R12SF125	N	1.1418	1.1811	2.36	1.25	18.50	16.14	14.17
6681013	TDMX1182R12SF125	O	1.1812	1.2204	2.36	1.25	19.02	16.65	14.65
6681015	TDMX1221R12SF125	P	1.2205	1.2598	2.36	1.25	19.57	17.20	15.12

NOTE: SSC = Pocket Seat Reference. To correspond with the SSC on the inserts.  
L5 is dependent on the insert.

TOP DRILL Modular X • 1.5 x D • Side Lock Shank • Metric

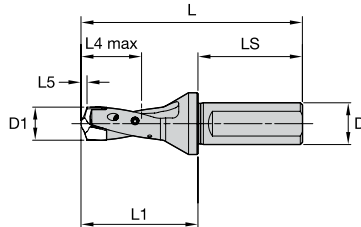

order number	catalog number	SSC	D1	D1 max	LS	D	L	L1	L4 max
6680951	TDMX160R1SL20M	A	16,000	16,999	50	20	106	56	26
6680952	TDMX170R1SL20M	B	17,000	17,999	50	20	109	59	27
6680953	TDMX180R1SL25M	C	18,000	18,999	56	25	118	62	29
6680954	TDMX190R1SL25M	D	19,000	19,999	56	25	121	65	30
6680955	TDMX200R1SL25M	E	20,000	20,999	56	25	124	68	32
6680956	TDMX210R1SL25M	F	21,000	21,999	56	25	127	71	33
6680957	TDMX220R1SL25M	G	22,000	22,999	56	25	130	74	35
6680958	TDMX230R1SL25M	H	23,000	23,999	56	25	133	77	36
6680959	TDMX240R1SL32M	I	24,000	24,999	60	32	140	80	38
6680960	TDMX250R1SL32M	J	25,000	25,999	60	32	143	83	39
6680971	TDMX260R1SL32M	K	26,000	26,999	60	32	146	86	41
6680972	TDMX270R1SL32M	L	27,000	27,999	60	32	149	89	42
6680973	TDMX280R1SL32M	M	28,000	28,999	60	32	152	92	44
6680974	TDMX290R1SL32M	N	29,000	29,999	60	32	155	95	45
6680975	TDMX300R1SL32M	O	30,000	30,999	60	32	158	98	47
6680976	TDMX310R1SL32M	P	31,000	31,999	60	32	161	101	48

NOTE: SSC = Pocket Seat Reference. To correspond with the SSC on the inserts.  
L5 is dependent on the insert.

## TOP DRILL Modular X • 3 x D • Side Lock Shank • Metric

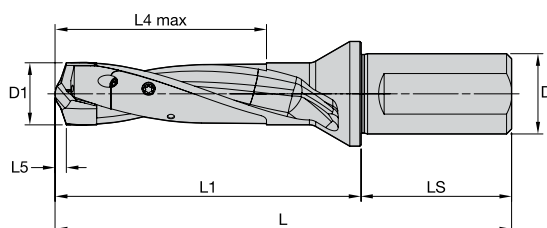

order number	catalog number	SSC	D1	D1 max	LS	D	L	L1	L4 max
6572091	TDMX160R3SL20M	A	16,000	16,999	50	20	131	81	51
6572092	TDMX170R3SL20M	B	17,000	17,999	50	20	136	86	54
6572093	TDMX180R3SL25M	C	18,000	18,999	56	25	146	90	57
6572094	TDMX190R3SL25M	D	19,000	19,999	56	25	151	95	60
6572096	TDMX200R3SL25M	E	20,000	20,999	56	25	155	99	63
6572097	TDMX210R3SL25M	F	21,000	21,999	56	25	160	104	66
6572098	TDMX220R3SL25M	G	22,000	22,999	56	25	164	108	69
6572099	TDMX230R3SL25M	H	23,000	23,999	56	25	169	113	72
6572100	TDMX240R3SL32M	I	24,000	24,999	60	32	177	117	75
6572101	TDMX250R3SL32M	J	25,000	25,999	60	32	182	122	78
6572102	TDMX260R3SL32M	K	26,000	26,999	60	32	186	126	81
6572104	TDMX270R3SL32M	L	27,000	27,999	60	32	191	131	84
6572105	TDMX280R3SL32M	M	28,000	28,999	60	32	195	135	87
6572106	TDMX290R3SL32M	N	29,000	29,999	60	32	200	140	90
6572107	TDMX300R3SL32M	O	30,000	30,999	60	32	204	144	93
6572108	TDMX310R3SL32M	P	31,000	31,999	60	32	209	149	96
6572109	TDMX320R3SL40M	Q	32,000	33,999	70	40	228	158	102
6572110	TDMX340R3SL40M	R	34,000	35,999	70	40	237	167	108
6572121	TDMX360R3SL40M	S	36,000	37,999	70	40	246	176	114
6572122	TDMX380R3SL40M	T	38,000	40,000	70	40	255	185	120

NOTE: SSC = Pocket Seat Reference. To correspond with the SSC on the inserts.  
L5 is dependent on the insert.

## TOP DRILL Modular X • 5 x D • Side Lock Shank • Metric

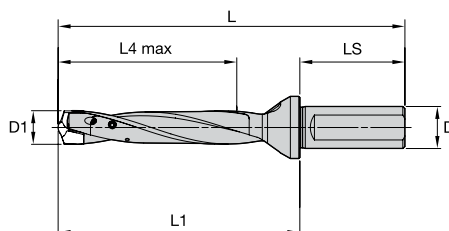

order number	catalog number	SSC	D1	D1 max	LS	D	L	L1	L4 max
6572125	TDMX160R5SL20M	A	16,000	16,999	50	20	165	115	85
6572126	TDMX170R5SL20M	B	17,000	17,999	50	20	172	122	90
6572127	TDMX180R5SL25M	C	18,000	18,999	56	25	184	128	95
6572128	TDMX190R5SL25M	D	19,000	19,999	56	25	191	135	100
6572129	TDMX200R5SL25M	E	20,000	20,999	56	25	197	141	105
6572130	TDMX210R5SL25M	F	21,000	21,999	56	25	204	148	110
6572141	TDMX220R5SL25M	G	22,000	22,999	56	25	210	154	115
6572142	TDMX230R5SL25M	H	23,000	23,999	56	25	217	161	120
6572143	TDMX240R5SL32M	I	24,000	24,999	60	32	227	167	125
6572144	TDMX250R5SL32M	J	25,000	25,999	60	32	234	174	130
6572145	TDMX260R5SL32M	K	26,000	26,999	60	32	240	180	135
6572146	TDMX270R5SL32M	L	27,000	27,999	60	32	247	187	140
6572147	TDMX280R5SL32M	M	28,000	28,999	60	32	253	193	145
6572148	TDMX290R5SL32M	N	29,000	29,999	60	32	260	200	150
6572149	TDMX300R5SL32M	O	30,000	30,999	60	32	266	206	155
6572150	TDMX310R5SL32M	P	31,000	31,999	60	32	273	213	160
6572151	TDMX320R5SL40M	Q	32,000	33,999	70	40	296	226	170
6572152	TDMX340R5SL40M	R	34,000	35,999	70	40	309	239	180
6572153	TDMX360R5SL40M	S	36,000	37,999	70	40	322	252	190
6572154	TDMX380R5SL40M	T	38,000	40,000	70	40	335	265	200

NOTE: SSC = Pocket Seat Reference. To correspond with the SSC on the inserts.  
L5 is dependent on the insert.



TOP DRILL Modular X • 8 x D • Side Lock Shank • Metric

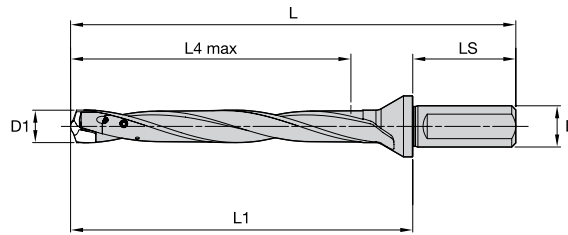

order number	catalog number	SSC	D1	D1 max	LS	D	L	L1	L4 max
6572155	TDMX160R8SL20M	A	16,000	16,999	50	20	216	166	136
6572156	TDMX170R8SL20M	B	17,000	17,999	50	20	226	176	144
6572157	TDMX180R8SL25M	C	18,000	18,999	56	25	241	185	152
6572158	TDMX190R8SL25M	D	19,000	19,999	56	25	251	195	160
6572159	TDMX200R8SL25M	E	20,000	20,999	56	25	260	204	168
6572160	TDMX210R8SL25M	F	21,000	21,999	56	25	270	214	176
6572171	TDMX220R8SL25M	G	22,000	22,999	56	25	279	223	184
6572172	TDMX230R8SL25M	H	23,000	23,999	56	25	289	233	192
6572173	TDMX240R8SL32M	I	24,000	24,999	60	32	302	242	200
6572174	TDMX250R8SL32M	J	25,000	25,999	60	32	312	252	208
6572175	TDMX260R8SL32M	K	26,000	26,999	60	32	321	261	216
6572176	TDMX270R8SL32M	L	27,000	27,999	60	32	331	271	224
6572177	TDMX280R8SL32M	M	28,000	28,999	60	32	340	280	232
6572178	TDMX290R8SL32M	N	29,000	29,999	60	32	350	290	240
6572179	TDMX300R8SL32M	O	30,000	30,999	60	32	359	299	248
6572180	TDMX310R8SL32M	P	31,000	31,999	60	32	369	309	256
6572181	TDMX320R8SL40M	Q	32,000	33,999	70	40	398	328	272
6572182	TDMX340R8SL40M	R	34,000	35,999	70	40	417	374	288
6572183	TDMX360R8SL40M	S	36,000	37,999	70	40	436	366	304
6572184	TDMX380R8SL40M	T	38,000	40,000	70	40	455	385	320

NOTE: SSC = Pocket Seat Reference. To correspond with the SSC on the inserts.  
L5 is dependent on the insert.

TOP DRILL Modular X • 12 x D • Flanged Round Shank • Metric

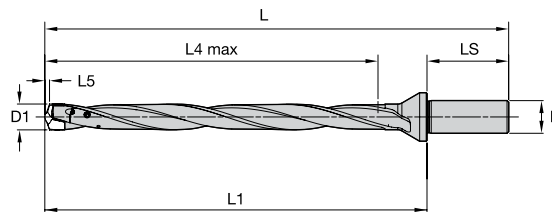

order number	catalog number	SSC	D1	D1 max	LS	D	L	L1	L4 max
6681017	TDMX160R12SF20M	A	16,000	16,999	50	20	284	234	204
6681018	TDMX170R12SF20M	B	17,000	17,999	50	20	298	248	216
6681019	TDMX180R12SF25M	C	18,000	18,999	56	25	317	261	228
6681020	TDMX190R12SF25M	D	19,000	19,999	56	25	331	275	240
6681041	TDMX200R12SF25M	E	20,000	20,999	56	25	344	288	252
6681042	TDMX210R12SF25M	F	21,000	21,999	56	25	358	302	264
6681043	TDMX220R12SF25M	G	22,000	22,999	56	25	371	315	276
6681044	TDMX230R12SF25M	H	23,000	23,999	56	25	385	329	288
6681045	TDMX240R12SF32M	I	24,000	24,999	60	32	402	342	300
6681046	TDMX250R12SF32M	J	25,000	25,999	60	32	416	356	312
6681047	TDMX260R12SF32M	K	26,000	26,999	60	32	429	369	324
6681049	TDMX270R12SF32M	L	27,000	27,999	60	32	443	383	336
6681050	TDMX280R12SF32M	M	28,000	28,999	60	32	456	396	348
6681051	TDMX290R12SF32M	N	29,000	29,999	60	32	470	410	360
6681052	TDMX300R12SF32M	O	30,000	30,999	60	32	483	423	372
6681053	TDMX310R12SF32M	P	31,000	31,999	60	32	497	437	384

NOTE: SSC = Pocket Seat Reference. To correspond with the SSC on the inserts.  
L5 is dependent on the insert.



## TOP DRILL™ Modular X • Inserts • PK

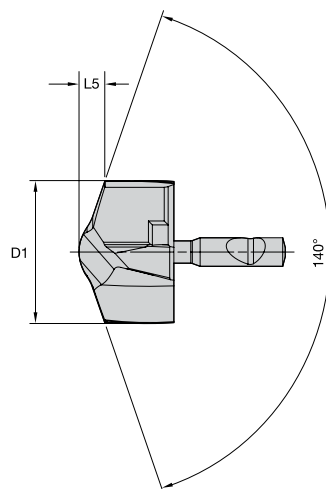

- first choice
- alternate choice

P	<span style="background-color: yellow;">■</span>	●
M	<span style="background-color: cyan;">■</span>	○
K	<span style="background-color: red;">■</span>	●
N	<span style="background-color: green;">■</span>	○
S	<span style="background-color: orange;">■</span>	○
H	<span style="background-color: grey;">■</span>	○

catalog number	D1		L5		SSC	WP40PD
	mm	in	mm	in		
TDMX16000PKM	16,00	.630	3,21	.126	A	6568446
TDMX16200PKM	16,20	.638	3,25	.128	A	6568447
TDMX16281PKM	16,28	.641	3,26	.128	A	6568448
TDMX16500PKM	16,50	.650	3,30	.130	A	6568449
TDMX16667PKM	16,67	.656	3,33	.131	A	6568450
TDMX17000PKM	17,00	.669	3,39	.134	B	6568461
TDMX17064PKM	17,06	.672	3,41	.134	B	6568462
TDMX17463PKM	17,46	.688	3,48	.137	B	6568464
TDMX17500PKM	17,50	.689	3,49	.137	B	6568465
TDMX17600PKM	17,60	.693	3,50	.138	B	6568467
TDMX17800PKM	17,80	.701	3,54	.139	B	6568471
TDMX17859PKM	17,86	.703	3,55	.140	B	6568472
TDMX18000PKM	18,00	.709	3,58	.141	C	6568473
TDMX18255PKM	18,26	.719	3,64	.143	C	6568474
TDMX18500PKM	18,50	.728	3,68	.145	C	6568475
TDMX18651PKM	18,65	.734	3,71	.146	C	6568476
TDMX18800PKM	18,80	.740	3,74	.147	C	6568477
TDMX19000PKM	19,00	.748	3,78	.149	D	6568478
TDMX19050PKM	19,05	.750	3,78	.149	D	6568479
TDMX19200PKM	19,20	.756	3,81	.150	D	6568480
TDMX19270PKM	19,27	.759	3,82	.150	D	6568481
TDMX19450PKM	19,45	.766	3,86	.152	D	6568482
TDMX19500PKM	19,50	.768	3,87	.152	D	6568483
TDMX19700PKM	19,70	.776	3,90	.154	D	6568484
TDMX19840PKM	19,84	.781	3,93	.155	D	6568485
TDMX20000PKM	20,00	.787	3,97	.156	E	6568813
TDMX20100PKM	20,10	.791	3,99	.157	E	6568814
TDMX20200PKM	20,20	.795	4,01	.158	E	6568815
TDMX20239PKM	20,24	.797	4,02	.158	E	6568816
TDMX20300PKM	20,30	.799	4,03	.159	E	6568817
TDMX20400PKM	20,40	.803	4,05	.159	E	6568818
TDMX20500PKM	20,50	.807	4,06	.160	E	6568819
TDMX20600PKM	20,60	.811	4,08	.161	E	6568820
TDMX20650PKM	20,65	.813	4,09	.161	E	6568841
TDMX20700PKM	20,70	.815	4,10	.161	E	6568842
TDMX20800PKM	20,80	.819	4,12	.162	E	6568843
TDMX20900PKM	20,90	.823	4,14	.163	E	6568844
TDMX21000PKM	21,00	.827	4,16	.164	F	6568845
TDMX21430PKM	21,43	.844	4,23	.167	F	6568846
TDMX21500PKM	21,50	.847	4,25	.167	F	6568847
TDMX22000PKM	22,00	.866	4,35	.171	G	6568848
TDMX22225PKM	22,23	.875	4,39	.173	G	6568849
TDMX22450PKM	22,45	.884	4,44	.175	G	6568850
TDMX22500PKM	22,50	.886	4,44	.175	G	6568851
TDMX23000PKM	23,00	.906	4,54	.179	H	6568852
TDMX23500PKM	23,50	.925	4,63	.182	H	6568853
TDMX23813PKM	23,81	.938	4,68	.184	H	6568854
TDMX24000PKM	24,00	.945	4,73	.186	I	6568856
TDMX24500PKM	24,50	.965	4,82	.190	I	6568857
TDMX24605PKM	24,61	.969	4,84	.191	I	6568858
TDMX25000PKM	25,00	.984	4,91	.193	J	6568859
TDMX25400PKM	25,40	1.000	4,99	.197	J	6568860

TOP DRILL™ Modular X • Inserts • PK

(continued)

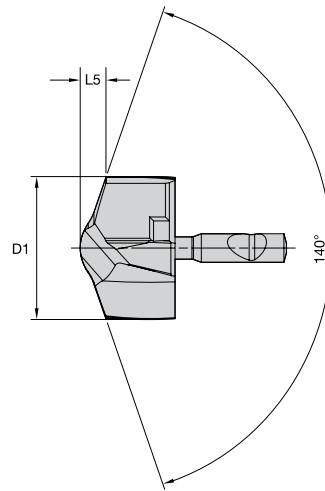

- first choice
- alternate choice

P	<span style="background-color: yellow;">■</span>	●
M	<span style="background-color: cyan;">■</span>	○
K	<span style="background-color: red;">■</span>	●
N	<span style="background-color: green;">■</span>	
S	<span style="background-color: orange;">■</span>	
H	<span style="background-color: grey;">■</span>	

catalog number	D1		L5		SSC	WP40PD
	mm	in	mm	in		
TDMX25500PKM	25,50	1.004	5,01	.197	J	6568861
TDMX25670PKM	25,67	1.011	5,04	.198	J	6568862
TDMX25700PKM	25,70	1.012	5,04	.198	J	6568863
TDMX25760PKM	25,76	1.014	5,05	.199	J	6568864
TDMX25796PKM	25,80	1.016	5,06	.199	J	6568865
TDMX26000PKM	26,00	1.024	5,11	.201	K	6568866
TDMX26192PKM	26,19	1.031	5,15	.203	K	6568867
TDMX26400PKM	26,40	1.039	5,18	.204	K	6568868
TDMX26500PKM	26,50	1.043	5,20	.205	K	6568869
TDMX26589PKM	26,59	1.047	5,22	.206	K	6568870
TDMX27000PKM	27,00	1.063	5,29	.208	L	6568871
TDMX27500PKM	27,50	1.083	5,38	.212	L	6568872
TDMX27780PKM	27,78	1.094	5,43	.214	L	6568873
TDMX28000PKM	28,00	1.102	5,49	.216	M	6568874
TDMX28176PKM	28,18	1.109	5,52	.217	M	6568875
TDMX28500PKM	28,50	1.122	5,58	.220	M	6568876
TDMX28575PKM	28,58	1.125	5,59	.220	M	6568877
TDMX29000PKM	29,00	1.142	5,67	.223	N	6568878
TDMX29367PKM	29,37	1.156	5,74	.226	N	6568879
TDMX29500PKM	29,50	1.161	5,76	.227	N	6568880
TDMX29764PKM	29,76	1.172	5,81	.229	N	6568891
TDMX30000PKM	30,00	1.181	5,87	.231	O	6568892
TDMX30163PKM	30,16	1.188	5,90	.232	O	6568893
TDMX30500PKM	30,50	1.201	5,96	.235	O	6568896
TDMX30955PKM	30,96	1.219	6,04	.238	O	6568897
TDMX31000PKM	31,00	1.221	6,05	.238	P	6568898
TDMX31500PKM	31,50	1.240	6,14	.242	P	6568899
TDMX31750PKM	31,75	1.250	6,18	.243	P	6568900
TDMX32000PKM	32,00	1.260	6,25	.246	Q	6568901
TDMX32500PKM	32,50	1.280	6,34	.250	Q	6568902
TDMX33000PKM	33,00	1.299	6,43	.253	Q	6568903
TDMX33338PKM	33,34	1.313	6,49	.256	Q	6568904
TDMX34000PKM	34,00	1.339	6,61	.260	R	6568905
TDMX34130PKM	34,13	1.344	6,64	.261	R	6568906
TDMX34925PKM	34,93	1.375	6,78	.267	R	6568907
TDMX35000PKM	35,00	1.378	6,79	.267	R	6568908
TDMX35500PKM	35,50	1.398	6,89	.271	R	6568909
TDMX36000PKM	36,00	1.417	7,00	.276	S	6568910
TDMX36500PKM	36,50	1.437	7,09	.279	S	6568911
TDMX37000PKM	37,00	1.457	7,18	.283	S	6568912
TDMX37500PKM	37,50	1.476	7,27	.286	S	6568913
TDMX38000PKM	38,00	1.496	7,36	.290	T	6568914
TDMX38100PKM	38,10	1.500	7,38	.291	T	6568915
TDMX38500PKM	38,50	1.516	7,46	.294	T	6568916
TDMX39000PKM	39,00	1.535	7,55	.297	T	6568917
TDMX39289PKM	39,29	1.547	7,60	.299	T	6568918
TDMX39500PKM	39,50	1.555	7,64	.301	T	6568919
TDMX40000PKM	40,00	1.575	7,73	.304	T	6568920

NOTE: SSC = Pocket Seat Reference. To correspond with the SSC on the toolholder.

## TOP DRILL™ Modular X • Inserts • FPE

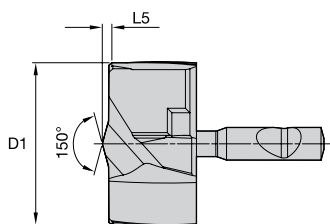

● first choice

○ alternate choice

P	<span style="background-color: yellow;">■</span>	●
M	<span style="background-color: cyan;">■</span>	○
K	<span style="background-color: red;">■</span>	●
N	<span style="background-color: green;">■</span>	
S	<span style="background-color: orange;">■</span>	
H	<span style="background-color: grey;">■</span>	

catalog number	D1		L5		SSC	WP40PD
	mm	in	mm	in		
TDMX16000FPEM	16,00	.630	1,16	.046	A	6693048
TDMX16281FPEM	16,28	.641	1,17	.046	A	6693049
TDMX16500FPEM	16,50	.650	1,17	.046	A	6693050
TDMX16667FPEM	16,67	.656	1,17	.046	A	6693111
TDMX17000FPEM	17,00	.669	1,18	.047	B	6693112
TDMX17064FPEM	17,06	.672	1,18	.047	B	6693113
TDMX17500FPEM	17,50	.689	1,19	.047	B	6693114
TDMX18000FPEM	18,00	.709	1,28	.050	C	6693115
TDMX18500FPEM	18,50	.728	1,28	.050	C	6693116
TDMX19000FPEM	19,00	.748	1,29	.051	D	6693117
TDMX19050FPEM	19,05	.750	1,29	.051	D	6693118
TDMX19500FPEM	19,50	.768	1,30	.051	D	6693119
TDMX19840FPEM	19,84	.781	1,31	.052	D	6693120
TDMX20000FPEM	20,00	.787	1,39	.055	E	6693131
TDMX20500FPEM	20,50	.807	1,40	.055	E	6693132
TDMX21000FPEM	21,00	.827	1,40	.055	F	6693133
TDMX21500FPEM	21,50	.847	1,41	.056	F	6693134
TDMX22000FPEM	22,00	.866	1,50	.059	G	6693135
TDMX22500FPEM	22,50	.886	1,51	.059	G	6693136
TDMX23000FPEM	23,00	.906	1,51	.059	H	6693137
TDMX23500FPEM	23,50	.925	1,52	.060	H	6693138
TDMX24000FPEM	24,00	.945	1,61	.063	I	6693139
TDMX24500FPEM	24,50	.965	1,62	.064	I	6693140
TDMX25000FPEM	25,00	.984	1,62	.064	J	6693151
TDMX25400FPEM	25,40	1.000	1,63	.064	J	6693152
TDMX25500FPEM	25,50	1.004	1,63	.064	J	6693153
TDMX26000FPEM	26,00	1.024	1,72	.068	K	6693154
TDMX26400FPEM	26,40	1.039	1,72	.068	K	6693194
TDMX26500FPEM	26,50	1.043	1,72	.068	K	6693155
TDMX27000FPEM	27,00	1.063	1,73	.068	L	6693156
TDMX27500FPEM	27,50	1.083	1,74	.069	L	6693157
TDMX28000FPEM	28,00	1.102	1,83	.072	M	6693158
TDMX28500FPEM	28,50	1.122	1,83	.072	M	6693160
TDMX29000FPEM	29,00	1.142	1,84	.072	N	6693161
TDMX29500FPEM	29,50	1.161	1,85	.073	N	6693162
TDMX30000FPEM	30,00	1.181	1,93	.076	O	6693163
TDMX30500FPEM	30,50	1.201	1,94	.076	O	6693164
TDMX31000FPEM	31,00	1.221	1,94	.076	P	6693165
TDMX31500FPEM	31,50	1.240	1,95	.077	P	6693166
TDMX31750FPEM	31,75	1.250	1,95	.077	P	6693167
TDMX32000FPEM	32,00	1.260	2,08	.082	Q	6693168
TDMX32500FPEM	32,50	1.280	2,08	.082	Q	6693169
TDMX33000FPEM	33,00	1.299	2,09	.082	Q	6693170
TDMX34000FPEM	34,00	1.339	2,10	.083	R	6693181
TDMX35000FPEM	35,00	1.378	2,11	.083	R	6693182
TDMX35500FPEM	35,50	1.398	2,12	.084	R	6693183
TDMX36000FPEM	36,00	1.417	2,29	.090	S	6693184
TDMX36500FPEM	36,50	1.437	2,29	.090	S	6693185
TDMX37000FPEM	37,00	1.457	2,30	.091	S	6693186
TDMX37500FPEM	37,50	1.476	2,30	.091	S	6693187
TDMX38000FPEM	38,00	1.496	2,31	.091	T	6693188
TDMX38100FPEM	38,10	1.500	2,31	.091	T	6693189
TDMX38500FPEM	38,50	1.516	2,32	.091	T	6693190
TDMX39000FPEM	39,00	1.535	2,32	.091	T	6693191
TDMX39500FPEM	39,50	1.555	2,33	.092	T	6693192
TDMX40000FPEM	40,00	1.575	2,33	.092	T	6693193

NOTE: SSC = Pocket Seat Reference. To correspond with the SSC on the toolholder.

Inch tolerance	
D1	tolerance k8
.3125-.3906	.000/+ .0009
>.3906-.6250	.000/+ .0011
>.6692-.7090	.000/+ .0010
>.7090-.8228	.000/+ .0013

Metric tolerance	
D1	tolerance k8
8-10	0,000/+0,022
>10-17	0,000/+0,027
>17-18	0,000/+0,027
>18-21	0,000/+0,033

TOP DRILL™ Modular X • Inserts • MS

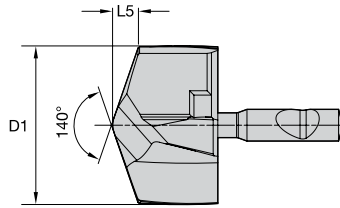

- first choice
- alternate choice

P	Blue	●
M	Yellow	○
K	Red	○
N	Green	○
S	Orange	●
H	Grey	○

catalog number	D1		L5		SSC	WM15PD
	mm	in	mm	in		
TDMX16000MSM	16,00	.630	2,84	.112	A	6568922
TDMX16200MSM	16,20	.638	2,88	.113	A	6568923
TDMX16281MSM	16,28	.641	2,89	.114	A	6568924
TDMX16500MSM	16,50	.650	2,93	.115	A	6568925
TDMX16667MSM	16,67	.656	2,96	.117	A	6568926
TDMX17000MSM	17,00	.669	3,01	.119	B	6568927
TDMX17064MSM	17,06	.672	3,02	.119	B	6568929
TDMX17463MSM	17,46	.688	3,09	.122	B	6568930
TDMX17500MSM	17,50	.689	3,10	.122	B	6568931
TDMX17600MSM	17,60	.693	3,12	.123	B	6568932
TDMX17800MSM	17,80	.701	3,15	.124	B	6568933
TDMX17859MSM	17,86	.703	3,16	.124	B	6568934
TDMX18000MSM	18,00	.709	3,19	.126	C	6568935
TDMX18255MSM	18,26	.719	3,24	.128	C	6568938
TDMX18500MSM	18,50	.728	3,28	.129	C	6568939
TDMX18651MSM	18,65	.734	3,30	.130	C	6568940
TDMX18800MSM	18,80	.740	3,33	.131	C	6568941
TDMX19000MSM	19,00	.748	3,36	.132	D	6568942
TDMX19050MSM	19,05	.750	3,37	.133	D	6568943
TDMX19200MSM	19,20	.756	3,40	.134	D	6568944
TDMX19270MSM	19,27	.759	3,41	.134	D	6568945
TDMX19450MSM	19,45	.766	3,44	.135	D	6568946
TDMX19500MSM	19,50	.768	3,45	.136	D	6568947
TDMX19700MSM	19,70	.776	3,48	.137	D	6568948
TDMX19840MSM	19,84	.781	3,51	.138	D	6568949
TDMX20000MSM	20,00	.787	3,54	.139	E	6568961
TDMX20100MSM	20,10	.791	3,56	.140	E	6568962
TDMX20200MSM	20,20	.795	3,57	.141	E	6568963
TDMX20239MSM	20,24	.797	3,58	.141	E	6568964
TDMX20300MSM	20,30	.799	3,59	.141	E	6568965
TDMX20400MSM	20,40	.803	3,61	.142	E	6568966
TDMX20500MSM	20,50	.807	3,63	.143	E	6568967
TDMX20600MSM	20,60	.811	3,64	.143	E	6568968
TDMX20650MSM	20,65	.813	3,65	.144	E	6568969
TDMX20700MSM	20,70	.815	3,66	.144	E	6568973
TDMX20800MSM	20,80	.819	3,68	.145	E	6568980
TDMX20900MSM	20,90	.823	3,69	.145	E	6568981
TDMX21000MSM	21,00	.827	3,71	.146	F	6568982
TDMX21430MSM	21,43	.844	3,79	.149	F	6568983
TDMX21500MSM	21,50	.847	3,80	.150	F	6568984
TDMX22000MSM	22,00	.866	3,89	.153	G	6568985
TDMX22225MSM	22,23	.875	3,93	.155	G	6568986
TDMX22450MSM	22,45	.884	3,97	.156	G	6568987
TDMX22500MSM	22,50	.886	3,97	.156	G	6568988
TDMX23000MSM	23,00	.906	4,06	.160	H	6568989
TDMX23500MSM	23,50	.925	4,15	.163	H	6568990
TDMX23813MSM	23,81	.938	4,20	.165	H	6568991
TDMX24000MSM	24,00	.945	4,24	.167	I	6568993
TDMX24500MSM	24,50	.965	4,32	.170	I	6568994
TDMX24605MSM	24,61	.969	4,34	.171	I	6568995
TDMX25000MSM	25,00	.984	4,41	.174	J	6568996
TDMX25400MSM	25,40	1.000	4,48	.176	J	6568998
TDMX25500MSM	25,50	1.004	4,49	.177	J	6568999
TDMX25670MSM	25,67	1.011	4,52	.178	J	6569000
TDMX25700MSM	25,70	1.012	4,53	.178	J	6569001
TDMX25760MSM	25,76	1.014	4,54	.179	J	6569002
TDMX25796MSM	25,80	1.016	4,55	.179	J	6569003
TDMX26000MSM	26,00	1.024	4,59	.181	K	6569006
TDMX26192MSM	26,19	1.031	4,62	.182	K	6569007
TDMX26400MSM	26,40	1.039	4,65	.183	K	6569008
TDMX26500MSM	26,50	1.043	4,67	.184	K	6569009
TDMX26589MSM	26,59	1.047	4,69	.185	K	6569010
TDMX27000MSM	27,00	1.063	4,76	.187	L	6569502
TDMX27500MSM	27,50	1.083	4,84	.191	L	6569503

INDEXABLE MILLING

SOLID END MILLING

HOLEMAKING

TAPPING

TURNING

## TOP DRILL™ Modular X • Inserts • MS

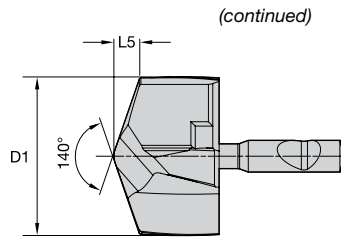

- first choice
- alternate choice

P		●
M		○
K		○
N		○
S		●
H		○

catalog number	D1		L5		SSC	WM15PD
	mm	in	mm	in		
TDMX27780MSM	27,78	1.094	4,89	.193	L	6569504
TDMX28000MSM	28,00	1.102	4,93	.194	M	6569505
TDMX28176MSM	28,18	1.109	4,96	.195	M	6569506
TDMX28500MSM	28,50	1.122	5,02	.198	M	6569507
TDMX28575MSM	28,58	1.125	5,03	.198	M	6569508
TDMX29000MSM	29,00	1.142	5,11	.201	N	6569509
TDMX29367MSM	29,37	1.156	5,17	.204	N	6569510
TDMX29500MSM	29,50	1.161	5,19	.204	N	6569521
TDMX29764MSM	29,76	1.172	5,24	.206	N	6569522
TDMX30000MSM	30,00	1.181	5,28	.208	O	6569523
TDMX30163MSM	30,16	1.188	5,31	.209	O	6569524
TDMX30500MSM	30,50	1.201	5,37	.211	O	6569525
TDMX30955MSM	30,96	1.219	5,45	.215	O	6569526
TDMX31000MSM	31,00	1.221	5,45	.215	P	6569527
TDMX31500MSM	31,50	1.240	5,54	.218	P	6569528
TDMX31750MSM	31,75	1.250	5,58	.220	P	6569529
TDMX32000MSM	32,00	1.260	5,63	.222	Q	6569530
TDMX32500MSM	32,50	1.280	5,72	.225	Q	6569531
TDMX33000MSM	33,00	1.299	5,80	.228	Q	6569532
TDMX33338MSM	33,34	1.313	5,86	.231	Q	6569533
TDMX34000MSM	34,00	1.339	5,98	.235	R	6569534
TDMX34130MSM	34,13	1.344	6,00	.236	R	6569535
TDMX34925MSM	34,93	1.375	6,13	.241	R	6569536
TDMX35000MSM	35,00	1.378	6,15	.242	R	6569537
TDMX35500MSM	35,50	1.398	6,23	.245	R	6569538
TDMX36000MSM	36,00	1.417	6,33	.249	S	6569539
TDMX36500MSM	36,50	1.437	6,41	.252	S	6569540
TDMX37000MSM	37,00	1.457	6,50	.256	S	6569551
TDMX37500MSM	37,50	1.476	6,59	.259	S	6569552
TDMX38000MSM	38,00	1.496	6,67	.263	T	6569553
TDMX38100MSM	38,10	1.500	6,69	.263	T	6569554
TDMX38289MSM	38,29	1.507	6,72	.265	T	6569557
TDMX38500MSM	38,50	1.516	6,76	.266	T	6569555
TDMX39000MSM	39,00	1.535	6,84	.269	T	6569556
TDMX39500MSM	39,50	1.555	6,93	.273	T	6569558
TDMX40000MSM	40,00	1.575	7,01	.276	T	6569559

NOTE: SSC = Pocket Seat Reference. To correspond with the SSC on the toolholder.

Application Data • PK • WP40PD™ • Inch

Material Group		Cutting Speed – Vc Range – SFM			Recommended Feed Rate (f) by Diameter					
		min	Starting Value	max	Tool Diameter (inch)	.630	.787	1.000	1.260	1.575
		P	1	295	410	558	IPR	.007-.018	.010-.019	.010-.020
2	344		459	590	IPR	.009-.018	.011-.020	.012-.020	.013-.022	.014-.024
3	164		246	328	IPR	.009-.018	.011-.020	.012-.020	.013-.022	.014-.024
4	164		246	328	IPR	.007-.018	.009-.019	.010-.020	.011-.022	.011-.023
5	164		213	262	IPR	.006-.013	.007-.014	.009-.017	.009-.018	.010-.019
6	164		213	262	IPR	.006-.013	.007-.014	.009-.017	.009-.018	.010-.019
M	1	131	262	361	IPR	.004-.010	.005-.012	.005-.013	.006-.014	.006-.015
	2	115	180	246	IPR	.004-.010	.005-.012	.005-.013	.006-.014	.006-.015
K	1	197	312	558	IPR	.010-.019	.011-.020	.013-.022	.014-.024	.015-.026
	2	197	246	295	IPR	.010-.019	.011-.020	.013-.022	.014-.024	.015-.026
	3	131	213	295	IPR	.008-.017	.009-.019	.010-.020	.011-.022	.011-.023

NOTE: Through coolant recommended for greater than 3 x D applications.  
Material group M is recommended for secondary applications.

Application Data • PK • WP40PD • Metric

Material Group		Cutting Speed – Vc Range – m/min			Recommended Feed Rate (f) by Diameter					
		min	Starting Value	max	Tool Diameter (mm)	16,0	20,0	25,0	32,0	40,0
		P	1	90	125	170	mm/r	0,19-0,45	0,25-0,48	0,25-0,52
2	105		140	180	mm/r	0,23-0,46	0,28-0,50	0,30-0,52	0,33-0,57	0,35-0,60
3	50		75	100	mm/r	0,23-0,46	0,28-0,50	0,30-0,52	0,33-0,57	0,35-0,60
4	50		75	100	mm/r	0,19-0,45	0,22-0,48	0,25-0,50	0,28-0,55	0,29-0,58
5	50		65	80	mm/r	0,16-0,32	0,18-0,36	0,22-0,42	0,24-0,46	0,25-0,48
6	50		65	80	mm/r	0,16-0,32	0,18-0,36	0,22-0,42	0,24-0,46	0,25-0,48
M	1	40	80	110	mm/r	0,11-0,26	0,13-0,28	0,13-0,32	0,14-0,35	0,15-0,37
	2	35	55	75	mm/r	0,11-0,26	0,13-0,28	0,13-0,32	0,14-0,35	0,15-0,37
	3	20	35	50	mm/r	0,11-0,26	0,13-0,28	0,13-0,32	0,14-0,35	0,15-0,37
K	1	60	95	170	mm/r	0,25-0,48	0,28-0,52	0,32-0,56	0,35-0,62	0,37-0,65
	2	60	75	90	mm/r	0,25-0,48	0,28-0,52	0,32-0,56	0,35-0,62	0,37-0,65
	3	40	65	90	mm/r	0,21-0,44	0,23-0,48	0,25-0,50	0,28-0,55	0,29-0,58

NOTE: Through coolant recommended for greater than 3 x D applications.  
Material group M is recommended for secondary applications.

Application Data • FPE • WP40PD™ • Inch

Material Group		Cutting Speed – Vc Range – SFM			Recommended Feed Rate (f) by Diameter					
		min	Starting Value	max	Tool Diameter (inch)	.630	.787	1.000	1.260	1.575
		P	1	360	460	560	IPR	.007-.010	.007-.011	.009-.015
2	330		390	460	IPR	.007-.010	.009-.011	.011-.015	.013-.017	.013-.030
3	260		330	390	IPR	.006-.009	.007-.010	.009-.013	.010-.015	.013-.026
4	230		300	360	IPR	.005-.009	.006-.010	.007-.013	.008-.015	.010-.026
M	1	130	200	260	IPR	.004-.007	.005-.008	.006-.010	.007-.011	.008-.012
	2	110	180	230	IPR	.004-.007	.005-.008	.006-.010	.007-.011	.008-.012
	3	70	130	200	IPR	.004-.007	.005-.008	.006-.010	.007-.011	.008-.012
K	1	300	440	570	IPR	.007-.010	.009-.011	.011-.015	.013-.017	.013-.030
	2	260	390	460	IPR	.007-.010	.009-.011	.011-.015	.013-.017	.013-.030
S	3	230	360	410	IPR	.007-.010	.008-.011	.009-.015	.010-.017	.011-.022
	1	70	130	200	IPR	.004-.007	.005-.008	.006-.010	.007-.011	.008-.012
	3	50	100	150	IPR	.004-.007	.005-.008	.006-.010	.007-.011	.008-.012

NOTE: Through coolant recommended for greater than 3 x D applications.  
Material group M is recommended for secondary applications.

Application Data • FPE • WP40PD • Metric

Material Group		Cutting Speed – Vc Range – SFM			Recommended Feed Rate (f) by Diameter					
		min	Starting Value	max	Tool Diameter (inch)	.630	.787	1.000	1.260	1.575
		P	1	295	410	558	IPR	.007-.018	.010-.019	.010-.020
2	344		459	590	IPR	.009-.018	.011-.020	.012-.020	.013-.022	.014-.024
3	164		246	328	IPR	.009-.018	.011-.020	.012-.020	.013-.022	.014-.024
4	164		246	328	IPR	.007-.018	.009-.019	.010-.020	.011-.022	.011-.023
5	164		213	262	IPR	.006-.013	.007-.014	.009-.017	.009-.018	.010-.019
6	164		213	262	IPR	.006-.013	.007-.014	.009-.017	.009-.018	.010-.019
M	1	131	262	361	IPR	.004-.010	.005-.012	.005-.013	.006-.014	.006-.015
	2	115	180	246	IPR	.004-.010	.005-.012	.005-.013	.006-.014	.006-.015
	3	66	115	164	IPR	.004-.010	.005-.012	.005-.013	.006-.014	.006-.015
K	1	197	312	558	IPR	.010-.019	.011-.020	.013-.022	.014-.024	.015-.026
	2	197	246	295	IPR	.010-.019	.011-.020	.013-.022	.014-.024	.015-.026
	3	131	213	295	IPR	.008-.017	.009-.019	.010-.020	.011-.022	.011-.023

NOTE: Through coolant recommended for greater than 3 x D applications.  
Material group M is recommended for secondary applications.



Application Data • MS • WM15PD™ • Inch

Material Group		Cutting Speed – Vc Range – SFM			Recommended Feed Rate (f) by Diameter					
		min	Starting Value	max	Tool Diameter (inch)	0.630	0.787	1.000	1.260	1.575
		<b>M</b>	1	131	262	361	IPR	.004 – .010	.005 – .012	.005 – .013
	2	115	180	246	IPR	.004 – .010	.005 – .012	.005 – .013	.006 – .014	.006 – .015
	3	66	115	164	IPR	.004 – .010	.005 – .012	.005 – .013	.006 – .014	.006 – .015
<b>K</b>	1	295	443	574	IPR	.007 – .010	.009 – .019	.011 – .015	.013 – .017	.013 – .020
	2	262	394	459	IPR	.007 – .010	.009 – .019	.011 – .015	.013 – .017	.013 – .020
	3	230	361	410	IPR	.007 – .010	.009 – .019	.009 – .015	.010 – .017	.011 – .020
<b>N</b>	1	295	508	722	IPR	.010 – .020	.011 – .022	.013 – .025	.013 – .028	.013 – .028
	2	295	508	722	IPR	.010 – .020	.011 – .022	.013 – .025	.013 – .028	.013 – .028
	3	262	394	525	IPR	.010 – .020	.011 – .022	.013 – .025	.013 – .028	.013 – .028
	4	295	508	722	IPR	.010 – .020	.011 – .022	.013 – .025	.013 – .028	.013 – .028
	5	525	656	787	IPR	.010 – .020	.011 – .022	.013 – .025	.013 – .028	.013 – .028
	6	525	656	787	IPR	.010 – .020	.011 – .022	.013 – .025	.013 – .028	.013 – .028
<b>S</b>	1	66	131	197	IPR	.003 – .005	.004 – .006	.004 – .007	.005 – .008	.006 – .010
	2	49	98	148	IPR	.003 – .005	.004 – .006	.004 – .007	.005 – .008	.006 – .010
	3	49	98	148	IPR	.003 – .005	.004 – .006	.004 – .007	.005 – .008	.006 – .010
	4	33	82	131	IPR	.003 – .005	.005 – .008	.006 – .010	.007 – .011	.008 – .012

NOTE: Through coolant recommended for greater than 3 x D applications.

Application Data • MS • WM15PD • Metric

Material Group		Cutting Speed – Vc Range – m/min			Recommended Feed Rate (f) by Diameter					
		min	Starting Value	max	Tool Diameter (mm)	16,0	20,0	25,4	32,0	40,0
		<b>M</b>	1	40	80	110	mm/r	0,11 – 0,26	0,13 – 0,28	0,13 – 0,32
	2	35	55	75	mm/r	0,11 – 0,26	0,13 – 0,28	0,13 – 0,32	0,14 – 0,35	0,15 – 0,37
	3	20	35	50	mm/r	0,11 – 0,26	0,13 – 0,28	0,13 – 0,32	0,14 – 0,35	0,15 – 0,37
<b>K</b>	1	90	135	175	mm/r	0,19 – 0,25	0,22 – 0,29	0,29 – 0,38	0,32 – 0,43	0,33 – 0,50
	2	80	120	140	mm/r	0,19 – 0,25	0,22 – 0,29	0,29 – 0,38	0,32 – 0,43	0,33 – 0,50
	3	70	110	125	mm/r	0,18 – 0,26	0,21 – 0,29	0,23 – 0,37	0,25 – 0,42	0,27 – 0,46
<b>N</b>	1	90	155	220	mm/r	0,25 – 0,50	0,28 – 0,56	0,32 – 0,63	0,32 – 0,70	0,32 – 0,70
	2	90	155	220	mm/r	0,25 – 0,50	0,28 – 0,56	0,32 – 0,63	0,32 – 0,70	0,32 – 0,70
	3	80	120	160	mm/r	0,25 – 0,50	0,28 – 0,56	0,32 – 0,63	0,32 – 0,70	0,32 – 0,70
	4	90	155	220	mm/r	0,25 – 0,50	0,28 – 0,56	0,32 – 0,63	0,32 – 0,70	0,32 – 0,70
	5	160	200	240	mm/r	0,25 – 0,50	0,28 – 0,56	0,32 – 0,63	0,32 – 0,70	0,32 – 0,70
	6	160	200	240	mm/r	0,25 – 0,50	0,28 – 0,56	0,32 – 0,63	0,32 – 0,70	0,32 – 0,70
<b>S</b>	1	20	40	60	mm/r	0,07 – 0,12	0,09 – 0,14	0,11 – 0,17	0,13 – 0,20	0,16 – 0,25
	2	15	30	45	mm/r	0,07 – 0,12	0,09 – 0,14	0,11 – 0,17	0,13 – 0,20	0,16 – 0,25
	3	15	30	45	mm/r	0,07 – 0,12	0,09 – 0,14	0,11 – 0,17	0,13 – 0,20	0,16 – 0,25
	4	10	25	40	mm/r	0,07 – 0,12	0,13 – 0,20	0,16 – 0,25	0,18 – 0,28	0,21 – 0,31

NOTE: Through coolant recommended for greater than 3 x D applications.



## Assembling and Disassembling Instructions

### Assembly

#### 1 Insert positioning

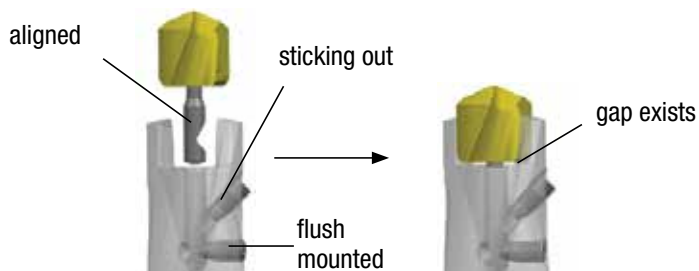

#### 2 Insert clamping

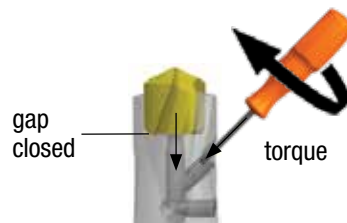

Drill diameter	Torque
ø .6300-.7874"	1.1 ft. lbs.
ø .7875-.9448"	1.5 ft. lbs.
ø .9449-1.1023"	2.2 ft. lbs.
ø 1.1024-1.5748"	3.3 ft. lbs.

### Disassembly

#### 1 Clamping screw loosening

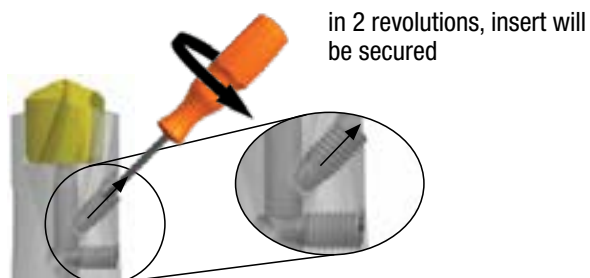

#### 2 Insert pushing out

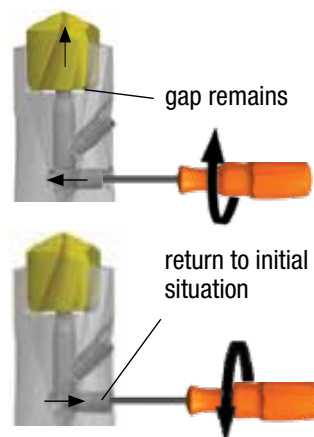

#### 3 Further clamping screw loosening

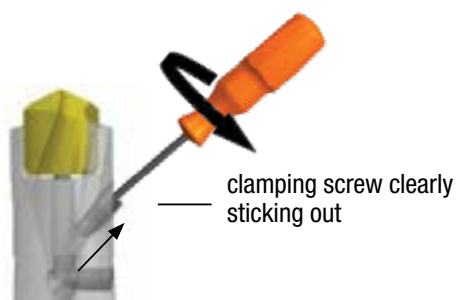

#### 4 Insert removal



Application Guidelines

Deep-Hole Drilling from 12 x D

- Use the FPE(M) geometry in combination with the 1.5 x D body for pilot hole.
- The point angle of spot drill should be greater than point angle of the insert (>140°).
- The 150° point on the FPE(M) insert is perfect as spot for the regular 140° insert.
- The 12 x D body has a cylindrical straight shank with flange.
- Shank tolerance h6.
- Best used in combination with a hydraulic chuck to minimize the runout.

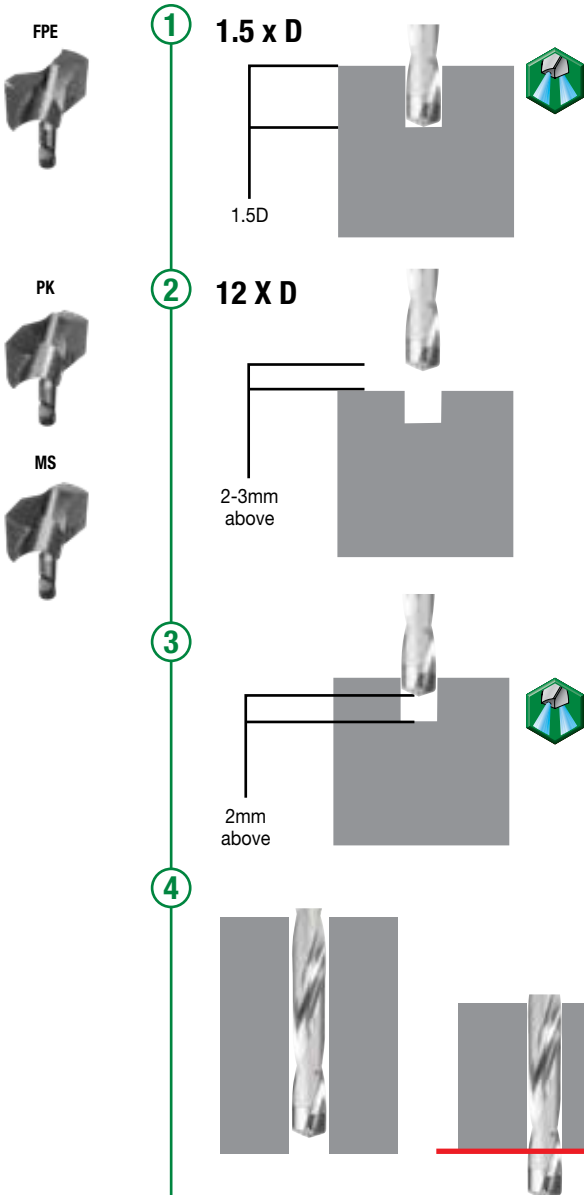
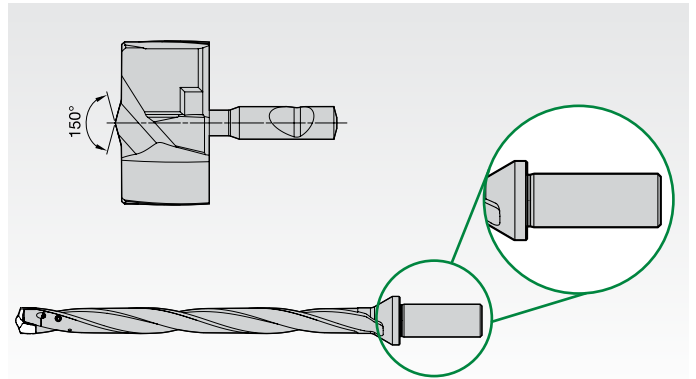

Step 1

Use 1.5 x D FPE geometry drill to create a guide hole with thru coolant and ensure no chips are stuck in the hole.

Step 2

Use 12 x D PK(M), MS(M) geometry drill for deep hole.

- Spindle RPM 500 max (If horizontal machine spindle direction CCW) and 2-3 above the work piece rapid traverse.
- Feed in recommended feed rate and position 2.0mm above the pilot hole depth.

Step 3

- Switch on the through coolant and ensure coolant flow and spindle rotation CW, recommended spindle RPM.

Step 4

- Feed in for the entire depth with recommended cutting parameters (feed reduction 25% near exit).
- Ensure the carbide head does not come out of the hole if through.
- For best surface finish Vf, 2.0 to 3.0mm per min is recommended during retraction.

## TDMX Application Notes • Power and Coolant Requirements

Drive Power (kW)

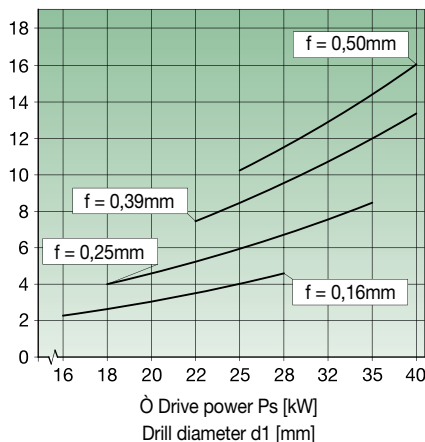

Feed Force (kN)

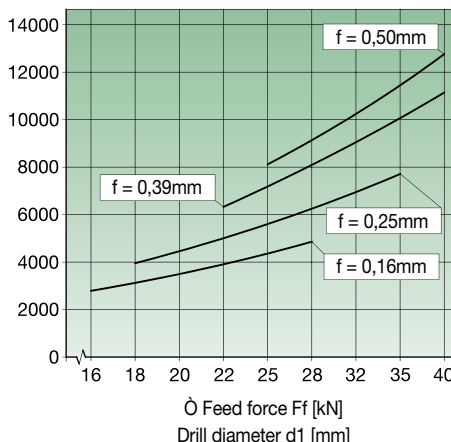

Torque (Nm)

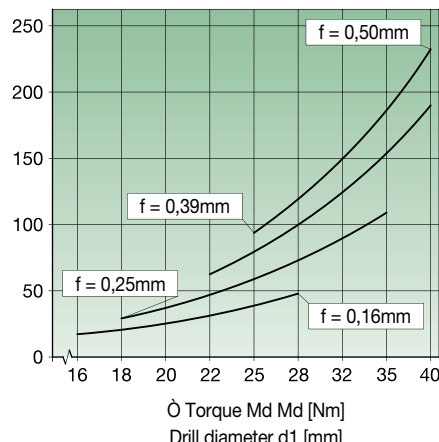

NOTE: The diagrams above are used to determine the drive power, feed force, and torque. They are based on cutting force measurement in tempered steels in Cgr. 6. Tensile strength:  $R_m = 600 \text{ N/mm}^2$ . The base cutting speed used is:  $v_c = 80 \text{ m/min}$ .

### TDMX • Regrinding Length • FPE • Inch

SSC	diameter range D	L min.	L new
A	.6300-.6692	.3858	.4252
B	.6693-.7086	.3858	.4252
C	.7087-.7480	.4173	.4606
D	.7481-.7874	.4173	.4606
E	.7875-.8267	.4488	.4961
F	.8268-.8661	.4488	.4961
G	.8662-.9055	.4764	.5276
H	.9056-.9448	.4764	.5276
I	.9449-.9842	.5118	.5669
J	.9843-1.0236	.5118	.5669
K	1.0237-1.0629	.5433	.6024
L	1.063-1.1023	.5433	.6024
M	1.1024-1.1417	.5827	.6457
N	1.1418-1.1811	.5827	.6457
O	1.1812-1.2204	.6142	.6811
P	1.2205-1.2598	.6142	.6811
Q	1.2599-1.3385	.7008	.7756
R	1.3386-1.4173	.7008	.7756
S	1.4174-1.4960	.7638	.8465
T	1.4961-1.5748	.7638	.8465

### TDMX • Regrinding Length • PK and MS • Inch

SSC	diameter range D	L min.	L new
A	.63-.6692	.4409	.4921
B	.6693-.7086	.4409	.4921
C	.7087-.748	.4803	.5354
D	.7481-.7874	.4803	.5354
E	.7875-.8267	.5197	.5787
F	.8268-.8661	.5197	.5787
G	.8662-.9055	.5591	.622
H	.9056-.9448	.5591	.622
I	.9449-.9842	.5984	.6654
J	.9843-1.0236	.5984	.6654
K	1.0237-1.0629	.6378	.7087
L	1.063-1.1023	.6378	.7087
M	1.1024-1.1417	.6772	.752
N	1.1418-1.1811	.6772	.752
O	1.1812-1.2204	.7165	.7953
P	1.2205-1.2598	.7165	.7953
Q	1.2599-1.3385	.7913	.878
R	1.3386-1.4173	.7913	.878
S	1.4174-1.496	.8701	.9646
T	1.4961-1.5748	.8701	.9646

NOTE: SSC = Pocket Seat Reference. To correspond with the SSC on the inserts.

The following coolant pressure is recommended:

relative drilling depth	coolant pressure
1-3 x D	8 bars
5 x D	12 bars
7 x D	20 bars
10 x D	30 bars
12 x D	30 bars

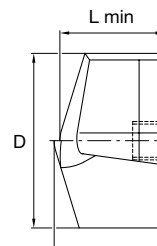

L new

TDMX Application Guidelines



Up to 1D



Recommended



Recommended

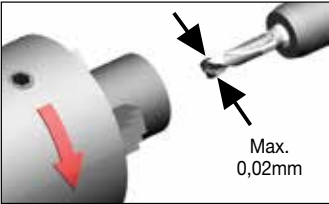
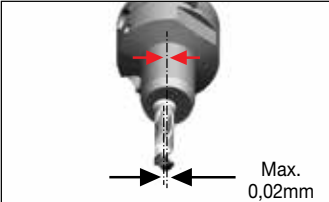

Dry not recommended

Application Recommendation	Work Piece Shape	Remarks																		
Flat Face Recommended		1.5 x D , 3 x D and 5 x D - No Feed Reduction 8 x D No Feed Reduction Optional 25% Reduction 12 x D 25% entry and exit Reduction																		
Stacked Plates Recommended		Minimize as much as possible the space between the two plates. The FPE geometry is a problem solver in this situation																		
Inclined Entry Recommended		<table border="1"> <thead> <tr> <th colspan="2">1.5 x D, 3 x D and 5 x D</th> <th>8 x D and 12 x D</th> </tr> <tr> <th>INCLINATION</th> <th>FEEDRATE</th> <td rowspan="5">Pilot Drilling or Pre-Machining on all surfaces recommended</td> </tr> </thead> <tbody> <tr> <td>1°</td> <td>90%</td> </tr> <tr> <td>2°</td> <td>75%</td> </tr> <tr> <td>3°</td> <td>50%</td> </tr> <tr> <td>&gt;3°</td> <td>Pilot Drilling or Pre-Machining</td> </tr> </tbody> </table>	1.5 x D, 3 x D and 5 x D		8 x D and 12 x D	INCLINATION	FEEDRATE	Pilot Drilling or Pre-Machining on all surfaces recommended	1°	90%	2°	75%	3°	50%	>3°	Pilot Drilling or Pre-Machining				
1.5 x D, 3 x D and 5 x D		8 x D and 12 x D																		
INCLINATION	FEEDRATE	Pilot Drilling or Pre-Machining on all surfaces recommended																		
1°	90%																			
2°	75%																			
3°	50%																			
>3°	Pilot Drilling or Pre-Machining																			
Inclined Exit Recommended		<table border="1"> <thead> <tr> <th colspan="2">1.5 x D, 3 x D and 5 x D</th> <th>8 x D and 12 x D</th> </tr> <tr> <th>INCLINATION</th> <th>FEEDRATE</th> <th>FEEDRATE</th> </tr> </thead> <tbody> <tr> <td>5°</td> <td>100%</td> <td>75%</td> </tr> <tr> <td>&gt;5°</td> <td>75% - 50%</td> <td>75% - 50%</td> </tr> <tr> <td>&gt;20°Cast Iron</td> <td>50%</td> <td>50%</td> </tr> <tr> <td>&gt;20°Steel</td> <td>Not Recommended</td> <td>Not Recommended</td> </tr> </tbody> </table>	1.5 x D, 3 x D and 5 x D		8 x D and 12 x D	INCLINATION	FEEDRATE	FEEDRATE	5°	100%	75%	>5°	75% - 50%	75% - 50%	>20°Cast Iron	50%	50%	>20°Steel	Not Recommended	Not Recommended
1.5 x D, 3 x D and 5 x D		8 x D and 12 x D																		
INCLINATION	FEEDRATE	FEEDRATE																		
5°	100%	75%																		
>5°	75% - 50%	75% - 50%																		
>20°Cast Iron	50%	50%																		
>20°Steel	Not Recommended	Not Recommended																		
Cross Holes Recommended		Cross hole out of center and center edge in contact - Recommended Cross hole on center and < drill diameter - Recommended Cross hole on center and > drill diameter - Exercise Caution Cross hole on center and = drill diameter - Exercise Caution Cross hole out of center and center edge not in contact - Not Recommended																		
Convex / Concave Surface		Always pre-machine the surface																		
Half Cylindrical Not Recommended		<p><b>Usage Precautions</b> <b>Core deviation</b></p> <p>1) For Turning Machines</p>  <p>Set deviation amount under 0,02mm between workpiece and drill.</p> <p>2) For Machining Centers</p> 																		
Hole Expansion Not Recommended																				
Pipe Material Not Recommended																				
Cored hole Not Recommended																				

# TOP DRILL M1™

## Universal Modular Drilling • TDM1

The TDM1 modular drill is for customers seeking an easy-to-use system capable of operating on a variety of materials with one single point geometry, and a tool body featuring a quick-change, front-clamping mechanism.

### 140° cone point geometry

Low thrust with excellent centering capabilities

### Front-locking system

Easy to change and apply

### Differential flute design

Good stability and easy evacuation of chips

### Sub-micron grain substrate

Longer life and superior resistance against drill breakage



The TDM1 modular drill is designed with a front-locking mechanism, point geometry UP, and wear-resistant PVD coating for consistent hole quality.

### WU25PD

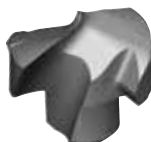

Sub-micron grain carbide

TiAlN multilayer for steel, stainless steel, and cast iron

# MODULAR VERSATILITY

## PRODUCT

TDM1 is a front clamping drill with universal point geometry and grade suited for PMK materials.

## DIAMETER RANGE

.313-.984" (8-25,99mm)

## INDUSTRY



## MATERIALS

### FIRST CHOICE



### SECOND CHOICE



## APPLICATIONS



DRILLING



THROUGH COOLANT



2 FLUTE/2 MARGIN/ COOLANT

## STEEL BODIES

SERIES	COOLANT	LENGTH RATIO	DIAMETER RANGE
TDM1	Through Coolant	3 x D	.313-.984" (7,94-25,99mm)
TDM1	Through Coolant	5 x D	.313-.984" (7,94-25,99mm)
TDM1	Through Coolant	8 x D	.313-.984" (7,94-25,99mm)

## Shank Style

SCF & SS Shank for inch tools

SCF Shank for metric tools

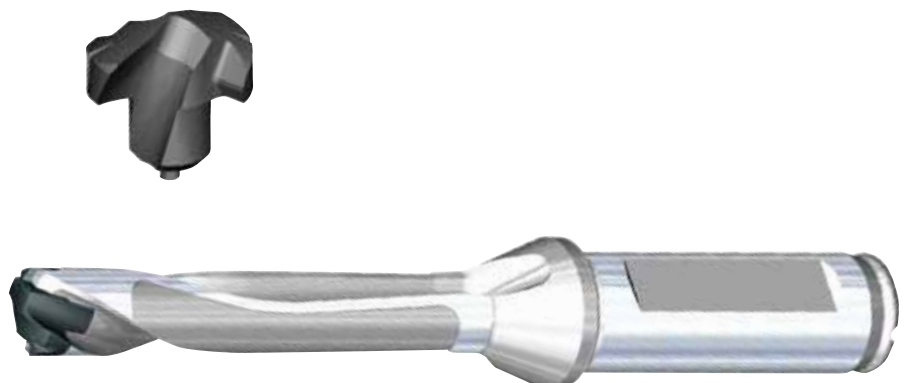

## TDM1 Inserts • Catalog Numbering System

Each character in our catalog number signifies a specific trait of that product. Use the following key columns and corresponding images to easily identify which attributes apply.

TDM1	2599	UPM	WU25PD
Top Drill Modular	Insert Diameter	Insert Geometry	Grade
	<b>mm</b> = 25.99 <b>Inch</b> = 1.023"	<b>PK</b> = steel and cast iron	<b>WIDIA™</b> ; Universal, Application <b>25</b> = wear resistant carbide, PVD coated, Modular Drill Insert

## TDM1 Bodies • Catalog Numbering System

Each character in our catalog number signifies a specific trait of that product. Use the following key columns and corresponding images to easily identify which attributes apply.

TDM1	0984	R8	SCF	100
Top Drill Modular	Drill Body Diameter	L/D Ratio	Shank Style	Shank Diameter
	<b>Inch</b> = .984"	8 x D	Flanged shanks with flat SCF	1.00"

TOP DRILL M1™ • 3 x D • Flanged Shank • Inch

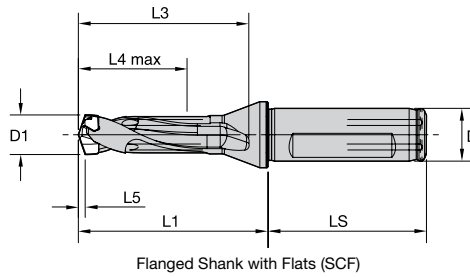

order number	catalog number	D1	D1 max	D	L1	L3	L4 max	L5	LS	SSC
4098937	TDM0313R3SCF050	.313	.3343	.5000	1.63	1.41	1.00	.057	1.77	W10
4098938	TDM0335R3SCF050	.335	.3539	.5000	1.75	1.53	1.06	.062	1.77	W11
4098939	TDM0354R3SCF050	.354	.3736	.5000	1.88	1.66	1.12	.065	1.77	W12
4098940	TDM0374R3SCF050	.374	.3933	.5000	1.88	1.66	1.18	.068	1.77	W13
4098941	TDM0394R3SCF063	.394	.4130	.6250	2.00	1.78	1.24	.072	1.89	W14
4098942	TDM0413R3SCF063	.413	.4327	.6250	2.00	1.78	1.30	.076	1.89	W15
4099013	TDM0433R3SCF063	.433	.4524	.6250	2.13	1.91	1.36	.079	1.89	W16
4099014	TDM0453R3SCF063	.453	.4723	.6250	2.25	2.03	1.42	.082	1.89	W17
4099015	TDM0472R3SCF063	.472	.4917	.6250	2.38	2.16	1.48	.087	1.89	W18
4099016	TDM0492R3SCF063	.492	.5114	.6250	2.38	2.16	1.54	.090	1.89	W19
4099017	TDM0512R3SCF063	.512	.5311	.6250	2.50	2.28	1.59	.093	1.89	W20
4099018	TDM0532R3SCF063	.532	.5508	.6250	2.50	2.28	1.65	.098	1.89	W21
4099019	TDM0551R3SCF063	.551	.5705	.6250	2.63	2.41	1.71	.101	1.89	W22
4099020	TDM0571R3SCF063	.571	.5902	.6250	2.75	2.53	1.77	.104	1.89	W23
4099021	TDM0591R3SCF075	.591	.6295	.7500	2.88	2.66	1.89	.107	1.97	W24
4099022	TDM0630R3SCF075	.630	.6689	.7500	3.00	2.78	2.01	.113	1.97	W25
4099023	TDM0669R3SCF075	.669	.7083	.7500	3.25	3.03	2.13	.121	1.97	W26
4099024	TDM0709R3SCF075	.709	.7476	.7500	3.38	3.16	2.24	.129	1.97	W27
4099025	TDM0748R3SCF075	.748	.7870	.7500	3.50	3.28	2.36	.134	1.97	W28
4099026	TDM0787R3SCF100	.787	.8264	1.0000	3.75	3.53	2.48	.143	2.20	W29
4099027	TDM0827R3SCF100	.827	.8657	1.0000	3.88	3.66	2.60	.151	2.20	W30
4099028	TDM0866R3SCF100	.866	.9051	1.0000	4.00	3.78	2.72	.156	2.20	W31
4099029	TDM0906R3SCF100	.906	.9445	1.0000	4.25	4.03	2.84	.167	2.20	W32
4099030	TDM0945R3SCF100	.945	.9839	1.0000	4.38	4.16	2.95	.173	2.20	W33
4099031	TDM0984R3SCF100	.984	1.0232	1.0000	4.50	4.28	3.07	.178	2.20	W34

NOTE: SSC = Pocket Seat Reference. To correspond with the SSC on the inserts.

INDEXABLE MILLING

SOLID END MILLING

HOLEMAKING

TAPPING

TURNING



## TOP DRILL M1™ • 5 x D • Flanged Shank • Inch

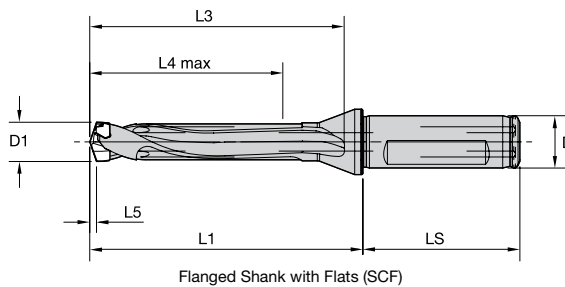

order number	catalog number	D1	D1 max	D	L1	L3	L4 max	L5	LS	SSC
4099032	TDM0313R5SCF050	.313	.3346	.5000	2.38	2.16	1.67	.057	1.77	W10
4099033	TDM0335R5SCF050	.335	.3542	.5000	2.50	2.28	1.77	.054	1.77	W11
4099034	TDM0354R5SCF050	.354	.3736	.5000	2.63	2.41	1.87	.065	1.77	W12
4099035	TDM0374R5SCF050	.374	.3933	.5000	2.75	2.53	1.97	.068	1.77	W13
4099036	TDM0394R5SCF063	.394	.4133	.6250	2.88	2.66	2.07	.064	1.89	W14
4099037	TDM0413R5SCF063	.413	.4327	.6250	3.00	2.78	2.17	.076	1.89	W15
4099038	TDM0433R5SCF063	.433	.4524	.6250	3.13	2.91	2.26	.079	1.89	W16
4099039	TDM0453R5SCF063	.453	.4723	.6250	3.25	3.03	2.36	.082	1.89	W17
4099040	TDM0472R5SCF063	.472	.4920	.6250	3.37	3.16	2.46	.079	1.89	W18
4099041	TDM0492R5SCF063	.492	.5114	.6250	3.50	3.28	2.56	.090	1.89	W19
4099042	TDM0512R5SCF063	.512	.5311	.6250	3.63	3.41	2.66	.093	1.89	W20
4099043	TDM0532R5SCF063	.532	.5508	.6250	3.75	3.53	2.76	.098	1.89	W21
4099044	TDM0551R5SCF063	.551	.5705	.6250	3.88	3.66	2.85	.101	1.89	W22
4099045	TDM0571R5SCF063	.571	.5902	.6250	4.00	3.78	2.95	.104	1.89	W23
4099046	TDM0591R5SCF075	.591	.6295	.7500	4.25	4.03	3.15	.107	1.97	W24
4099047	TDM0630R5SCF075	.630	.6689	.7500	4.50	4.28	3.35	.113	1.97	W25
4099048	TDM0669R5SCF075	.669	.7083	.7500	4.75	4.53	3.54	.121	1.97	W26
4099049	TDM0709R5SCF075	.709	.7476	.7500	5.00	4.78	3.74	.129	1.97	W27
4099050	TDM0748R5SCF075	.748	.7870	.7500	5.25	5.03	3.94	.134	1.97	W28
4099051	TDM0787R5SCF100	.787	.8264	1.0000	5.38	5.16	4.13	.143	2.20	W29
4099052	TDM0827R5SCF100	.827	.8657	1.0000	5.75	5.53	4.33	.151	2.20	W30
4099053	TDM0866R5SCF100	.866	.9051	1.0000	6.00	5.78	4.53	.156	2.20	W31
4099054	TDM0906R5SCF100	.906	.9445	1.0000	6.13	5.91	4.72	.167	2.20	W32
4099055	TDM0945R5SCF100	.945	.9839	1.0000	6.38	6.16	4.92	.173	2.20	W33
4099056	TDM0984R5SCF100	.984	1.0232	1.0000	6.75	6.53	5.12	.178	2.20	W34

NOTE: SSC = Pocket Seat Reference. To correspond with the SSC on the inserts.

INDEXABLE MILLING

SOLID END MILLING

HOLEMAKING

TAPPING

TURNING

TOP DRILL M1™ • 8 x D • Flanged Shank • Inch

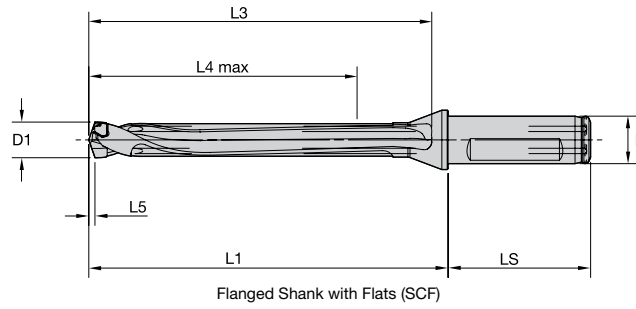

order number	catalog number	D1	D1 max	D	L1	L3	L4 max	L5	LS	SSC
4099057	TDM0313R8SCF050	.313	.3343	.5000	3.38	3.16	2.68	.057	1.77	W10
4099058	TDM0335R8SCF050	.335	.3539	.5000	3.50	3.28	2.83	.062	1.77	W11
4099059	TDM0354R8SCF050	.354	.3736	.5000	3.75	3.53	2.99	.065	1.77	W12
4099060	TDM0374R8SCF050	.374	.3933	.5000	4.00	3.78	3.15	.068	1.77	W13
4099061	TDM0394R8SCF063	.394	.4130	.6250	4.13	3.91	3.31	.072	1.89	W14
4099062	TDM0413R8SCF063	.413	.4327	.6250	4.25	4.03	3.46	.076	1.89	W15
4099063	TDM0433R8SCF063	.433	.4524	.6250	4.50	4.28	3.62	.079	1.89	W16
4099064	TDM0453R8SCF063	.453	.4720	.6250	4.63	4.41	3.78	.083	1.89	W17
4099065	TDM0472R8SCF063	.472	.4917	.6250	4.88	4.66	3.94	.087	1.89	W18
4099066	TDM0492R8SCF063	.492	.5114	.6250	5.00	4.78	4.09	.090	1.89	W19
4099067	TDM0512R8SCF063	.512	.5311	.6250	5.13	4.91	4.25	.093	1.89	W20
4099068	TDM0532R8SCF063	.532	.5508	.6250	5.38	5.16	4.41	.098	1.89	W21
4099069	TDM0551R8SCF063	.551	.5705	.6250	5.63	5.41	4.57	.101	1.89	W22
4099070	TDM0571R8SCF063	.571	.5902	.6250	5.75	5.53	4.72	.104	1.89	W23
4099071	TDM0591R8SCF075	.591	.6298	.7500	6.13	5.91	5.13	.097	1.97	W24
4099072	TDM0630R8SCF075	.630	.6689	.7500	6.50	6.28	5.35	.113	1.97	W25
4099073	TDM0669R8SCF075	.669	.7083	.7500	6.88	6.66	5.67	.121	1.97	W26
4099074	TDM0709R8SCF075	.709	.7476	.7500	7.25	7.03	5.98	.129	1.97	W27
4099075	TDM0748R8SCF075	.748	.7870	.7500	7.50	7.28	6.30	.134	1.97	W28
4099077	TDM0827R8SCF100	.827	.8657	1.0000	8.25	8.03	6.93	.151	2.20	W30
4099078	TDM0866R8SCF100	.866	.9054	1.0000	8.63	8.41	7.24	.144	2.20	W31
4099079	TDM0906R8SCF100	.906	.9445	1.0000	9.00	8.78	7.56	.167	2.20	W32
4099080	TDM0945R8SCF100	.945	.9839	1.0000	9.38	9.16	7.87	.173	2.20	W33
4099081	TDM0984R8SCF100	.984	1.0232	1.0000	9.75	9.53	8.19	.178	2.20	W34

NOTE: SSC = Pocket Seat Reference. To correspond with the SSC on the inserts.

INDEXABLE MILLING

SOLID END MILLING

HOLEMAKING

TAPPING

TURNING

## TOP DRILL M1™ • 3 x D • Straight Round Shank • Inch

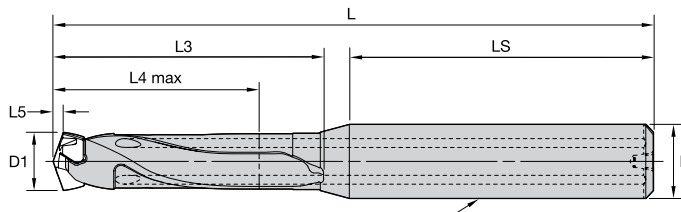

Round Shank (no flats)  
For information on L, L3, L4 max, L5, LS, and D, see the Modular Drill foldout table.

order number	catalog number	D1	D1 max	D	L	L3	L4 max	L5	LS	SSC
3851478	TDM0313R3SS038	.313	.3343	.3750	3.13	1.42	1.00	.060	1.59	W10
3851480	TDM0335R3SS038	.335	.3539	.3750	3.25	1.54	1.06	.065	1.59	W11
3851482	TDM0354R3SS038	.354	.3736	.3750	3.38	1.67	1.12	.069	1.59	W12
3851545	TDM0374R3SS044	.374	.3933	.4375	3.38	1.59	1.18	.072	1.67	W13
3851544	TDM0374R3SS038	.375	.3936	.3750	3.38	1.67	1.18	.060	1.59	W13
3851548	TDM0394R3SS044	.394	.4130	.4375	3.63	1.84	1.24	.076	1.67	W14
3851550	TDM0413R3SS044	.413	.4327	.4375	3.75	1.96	1.30	.081	1.67	W15
3851552	TDM0433R3SS044	.433	.4524	.4375	3.88	2.09	1.36	.084	1.67	W16
3851554	TDM0453R3SS050	.453	.4720	.5000	3.88	1.97	1.42	.086	1.79	W17
3851556	TDM0472R3SS050	.472	.4917	.5000	4.00	2.09	1.48	.092	1.79	W18
3851558	TDM0492R3SS050	.492	.5114	.5000	4.13	2.22	1.54	.095	1.79	W19
3851559	TDM0492R3SS056	.492	.5114	.5625	4.13	2.22	1.54	.095	1.79	W19
3851562	TDM0512R3SS056	.512	.5311	.5625	4.25	2.34	1.60	.098	1.79	W20
3851564	TDM0532R3SS056	.532	.5508	.5625	4.25	2.34	1.65	.104	1.79	W21
3851566	TDM0551R3SS056	.551	.5705	.5625	4.50	2.59	1.71	.107	1.79	W22
3851568	TDM0571R3SS063	.571	.5902	.6250	4.50	2.47	1.77	.109	1.91	W23
3851570	TDM0591R3SS063	.591	.6295	.6250	4.75	2.72	1.89	.113	1.91	W24
3851572	TDM0630R3SS069	.630	.6689	.6875	4.88	2.85	2.01	.119	1.91	W25
3851574	TDM0669R3SS069	.669	.7083	.6875	5.00	2.97	2.12	.127	1.91	W26
3851576	TDM0709R3SS075	.709	.7476	.7500	5.25	3.13	2.24	.136	2.00	W27
3851578	TDM0748R3SS075	.748	.7870	.7500	5.50	3.38	2.36	.142	2.00	W28
3851580	TDM0787R3SS081	.787	.8264	.8125	5.75	3.63	2.48	.150	2.00	W29
3992477	TDM0827R3SS088	.827	.8657	.8750	5.87	3.69	2.60	.150	2.07	W30
3992478	TDM0866R3SS088	.866	.9051	.8750	6.00	3.81	2.72	.154	2.07	W31
3992479	TDM0906R3SS094	.906	.9445	.9375	6.25	3.98	2.83	.165	2.15	W32
3992481	TDM0984R3SS100	.984	1.0232	1.0000	7.37	4.26	3.07	.177	3.00	W34

NOTE: SSC = Pocket Seat Reference. To correspond with the SSC on the inserts.

INDEXABLE MILLING

SOLID END MILLING

HOLEMAKING

TAPPING

TURNING

TOP DRILL M1™ • 5 x D • Straight Round Shank • Inch

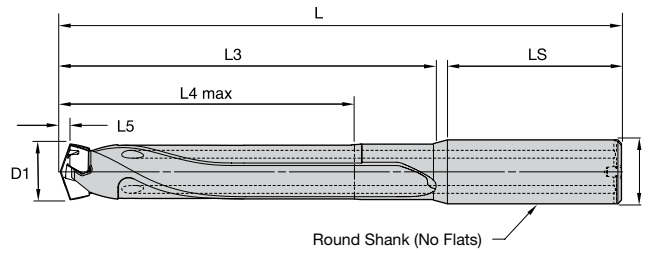

order number	catalog number	D1	D1 max	D	L	L3	L4 max	L5	LS	SSC
3851479	TDM0313R5SS038	.313	.3343	.3750	3.88	2.17	1.67	.060	1.59	W10
3851481	TDM0335R5SS038	.335	.3539	.3750	4.00	2.29	1.77	.065	1.59	W11
3851543	TDM0354R5SS038	.354	.3736	.3750	4.13	2.42	1.87	.069	1.59	W12
3851546	TDM0374R5SS038	.374	.3933	.3750	4.25	2.54	1.97	.072	1.59	W13
3851547	TDM0374R5SS044	.374	.3933	.4375	4.38	2.59	1.97	.072	1.67	W13
3851549	TDM0394R5SS044	.394	.4130	.4375	4.63	2.84	2.07	.076	1.67	W14
3851551	TDM0413R5SS044	.413	.4327	.4375	4.75	2.96	2.16	.081	1.67	W15
3851553	TDM0433R5SS044	.433	.4524	.4375	4.88	3.09	2.26	.084	1.67	W16
3851555	TDM0453R5SS050	.453	.4720	.5000	5.00	3.09	2.36	.086	1.79	W17
3851557	TDM0472R5SS050	.472	.4917	.5000	5.00	3.09	2.46	.092	1.79	W18
3851560	TDM0492R5SS050	.492	.5114	.5000	5.13	3.22	2.56	.095	1.79	W19
3851561	TDM0492R5SS056	.492	.5114	.5625	5.13	3.22	2.56	.095	1.79	W19
3851563	TDM0512R5SS056	.512	.5311	.5625	5.25	3.34	2.66	.098	1.79	W20
3851565	TDM0532R5SS056	.532	.5508	.5625	5.50	3.59	2.75	.104	1.79	W21
3851567	TDM0551R5SS056	.551	.5705	.5625	5.75	3.84	2.85	.107	1.79	W22
3851569	TDM0571R5SS063	.571	.5902	.6250	5.75	3.72	2.95	.109	1.91	W23
3851571	TDM0591R5SS063	.591	.6295	.6250	6.00	3.97	3.15	.113	1.91	W24
3851573	TDM0630R5SS069	.630	.6689	.6875	6.25	4.22	3.34	.119	1.91	W25
3851575	TDM0669R5SS069	.669	.7083	.6875	6.50	4.47	3.54	.127	1.91	W26
3851577	TDM0709R5SS075	.709	.7476	.7500	6.88	4.76	3.74	.136	2.00	W27
3851579	TDM0748R5SS075	.748	.7870	.7500	7.13	5.01	3.94	.142	2.00	W28
3851581	TDM0787R5SS081	.787	.8264	.8125	7.50	5.38	4.13	.150	2.00	W29
3992503	TDM0827R5SS088	.827	.8657	.8750	7.63	5.44	4.33	.150	2.07	W30
3992504	TDM0866R5SS088	.866	.9051	.8750	7.87	5.69	4.53	.154	2.07	W31
3992506	TDM0945R5SS100	.945	.9839	1.0000	9.37	6.26	4.92	.169	3.00	W33
3992507	TDM0984R5SS100	.984	1.0232	1.0000	9.63	6.51	5.12	.177	3.00	W34

NOTE: SSC = Pocket Seat Reference. To correspond with the SSC on the inserts.

INDEXABLE MILLING

SOLID END MILLING

HOLEMAKING

TAPPING

TURNING

## TOP DRILL M1™ • 8 x D • Straight Round Shank • Inch

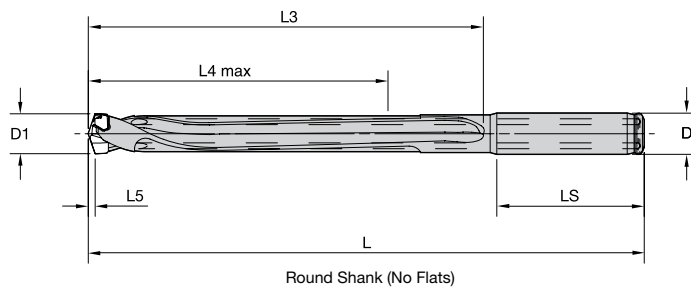

order number	catalog number	D1	D1 max	D	L	L3	L4 max	L5	LS	SSC
3992536	TDM0313R8SS038	.313	.3343	.3750	4.87	3.17	2.68	.055	1.59	W10
3992537	TDM0335R8SS038	.335	.3539	.3750	5.13	3.42	2.83	.063	1.59	W11
3992539	TDM0374R8SS038	.374	.3933	.3750	5.37	3.67	3.15	.067	1.59	W13
3992540	TDM0374R8SS044	.374	.3933	.4375	5.37	3.59	3.15	.067	1.67	W13
3992541	TDM0394R8SS044	.394	.4130	.4375	5.75	3.96	3.31	.071	1.67	W14
3992542	TDM0413R8SS044	.433	.4327	.4375	6.00	4.21	4.33	.068	1.67	K
3992543	TDM0433R8SS044	.433	.4524	.4375	6.25	4.46	3.62	.079	1.67	W16
3992544	TDM0453R8SS050	.453	.4720	.5000	6.50	4.56	3.78	.083	1.79	W17
3992545	TDM0472R8SS050	.472	.4917	.5000	6.75	4.84	3.94	.087	1.79	W18
3992546	TDM0492R8SS050	.492	.5114	.5000	7.00	5.08	4.09	.091	1.79	W19
3992548	TDM0512R8SS056	.512	.5311	.5625	7.13	5.22	4.25	.091	1.79	W20
3992549	TDM0532R8SS056	.532	.5508	.5625	7.25	5.34	4.41	.098	1.79	W21
3992550	TDM0551R8SS056	.551	.5705	.5625	7.37	5.47	4.57	.098	1.79	W22
3992551	TDM0571R8SS063	.571	.5902	.6250	7.50	5.47	4.72	.102	1.91	W23
3992552	TDM0591R8SS063	.591	.6295	.6250	7.75	5.72	5.04	.106	1.91	W24
3992553	TDM0630R8SS069	.630	.6689	.6875	8.00	5.97	5.35	.114	1.91	W25
3992554	TDM0669R8SS069	.669	.7083	.6875	8.75	6.72	5.67	.118	1.91	W26
3992556	TDM0748R8SS075	.748	.7870	.7500	9.63	7.51	6.30	.134	2.00	W28
3992557	TDM0787R8SS081	.787	.8264	.8125	10.00	7.88	6.61	.142	2.00	W29
3992558	TDM0827R8SS088	.827	.8657	.8750	10.25	8.06	6.93	.150	2.07	W30
3992560	TDM0906R8SS094	.906	.9445	.9375	11.13	8.86	7.56	.165	2.15	W32
3992561	TDM0945R8SS100	.945	.9839	1.0000	12.25	9.13	7.87	.169	3.00	W33
3992562	TDM0984R8SS100	.984	1.0232	1.0000	12.63	9.51	8.19	.177	3.00	W34

SSC = Pocket Seat Reference. To correspond with the SSC on the inserts.

INDEXABLE MILLING

SOLID END MILLING

HOLEMAKING

TAPPING

TURNING

TOP DRILL M1™ • 3 x D • Flanged Shank • Metric

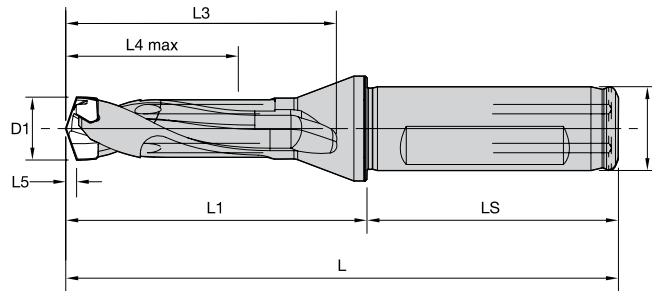

Round Shank (No Flats)

order number	catalog number	D1	D1 max	D	L	L1	L3	L4 max	L5	LS	SSC
3850904	TDM080R3SCF12M	7,94	8,49	12	86	41	35	26	1,5	45	W10
3850906	TDM085R3SCF12M	8,50	8,99	12	88	43	37	27	1,6	45	W11
3850908	TDM090R3SCF12M	9,00	9,49	12	90	45	39	29	1,7	45	W12
3850910	TDM095R3SCF12M	9,50	9,99	12	92	47	41	30	1,8	45	W13
3850912	TDM100R3SCF16M	10,00	10,49	16	97	49	43	32	1,9	48	W14
3850924	TDM105R3SCF16M	10,50	10,99	16	99	51	45	33	2,0	48	W15
3850926	TDM110R3SCF16M	11,00	11,49	16	101	53	47	35	2,1	48	W16
3850928	TDM115R3SCF16M	11,50	11,99	16	103	55	49	36	2,2	48	W17
3850930	TDM120R3SCF16M	12,00	12,49	16	106	58	52	38	2,3	48	W18
3850932	TDM125R3SCF16M	12,50	12,99	16	108	60	54	39	2,4	48	W19
3850934	TDM130R3SCF16M	13,00	13,49	16	110	62	56	41	2,5	48	W20
3850936	TDM135R3SCF16M	13,50	13,99	16	112	64	58	42	2,6	48	W21
3850938	TDM140R3SCF16M	14,00	14,49	16	114	66	60	44	2,7	48	W22
3850940	TDM145R3SCF16M	14,50	14,99	16	116	68	62	45	2,8	48	W23
3850942	TDM150R3SCF20M	15,00	15,99	20	122	72	66	48	2,8	50	W24
3850944	TDM160R3SCF20M	16,00	16,99	20	126	76	70	51	3,0	50	W25
3850946	TDM170R3SCF20M	17,00	17,99	20	131	81	75	54	3,2	50	W26
3850948	TDM180R3SCF25M	18,00	18,99	25	141	85	79	57	3,4	56	W27
3850950	TDM190R3SCF25M	19,00	19,99	25	144	89	83	60	3,6	56	W28
3850952	TDM200R3SCF25M	20,00	20,99	25	149	93	87	63	3,8	56	W29
3992070	TDM210R3SCF25M	21,00	21,99	25	153	97	91	66	3,7	56	W30
3992071	TDM220R3SCF25M	22,00	22,99	25	158	102	96	69	3,9	56	W31
3992072	TDM230R3SCF25M	23,00	23,99	25	162	106	100	72	4,1	56	W32
3992483	TDM240R3SCF25M	24,00	24,99	25	166	110	104	75	4,2	56	W33
3992484	TDM250R3SCF25M	25,00	25,99	25	170	114	108	78	4,4	56	W34

NOTE: SSC = Pocket Seat Reference. To correspond with the SSC on the inserts.

INDEXABLE MILLING

SOLID END MILLING

HOLEMAKING

TAPPING

TURNING

## TOP DRILL M1™ • 5 x D • Flanged Shank • Metric

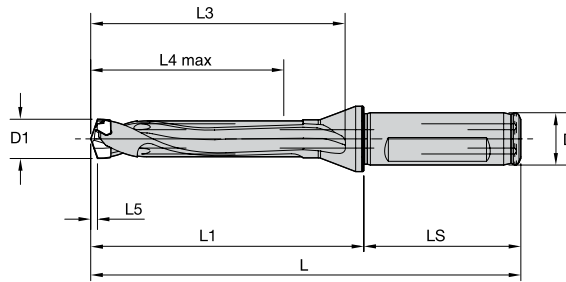

order number	catalog number	D1	D1 max	D	L	L1	L3	L4 max	L5	LS	SSC
3850905	TDM080R5SCF12M	7,94	8,49	12	104	59	53	43	1,5	45	W10
3850907	TDM085R5SCF12M	8,50	8,99	12	107	62	56	45	1,6	45	W11
3850909	TDM090R5SCF12M	9,00	9,49	12	110	65	59	48	1,7	45	W12
3850911	TDM095R5SCF12M	9,50	9,99	12	114	69	63	50	1,8	45	W13
3850923	TDM100R5SCF16M	10,00	10,49	16	120	72	66	53	1,9	48	W14
3850925	TDM105R5SCF16M	10,50	10,99	16	123	75	69	55	2,0	48	W15
3850927	TDM110R5SCF16M	11,00	11,49	16	126	78	72	58	2,1	48	W16
3850929	TDM115R5SCF16M	11,50	11,99	16	129	81	75	60	2,2	48	W17
3850931	TDM120R5SCF16M	12,00	12,49	16	132	84	78	63	2,3	48	W18
3850933	TDM125R5SCF16M	12,50	12,99	16	135	87	81	65	2,4	48	W19
3850935	TDM130R5SCF16M	13,00	13,49	16	138	90	84	68	2,5	48	W20
3850937	TDM135R5SCF16M	13,50	13,99	16	142	94	88	70	2,6	48	W21
3850939	TDM140R5SCF16M	14,00	14,49	16	145	97	91	73	2,7	48	W22
3850941	TDM145R5SCF16M	14,50	14,99	16	148	100	94	75	2,8	48	W23
3850943	TDM150R5SCF20M	15,00	15,99	20	156	106	100	80	2,8	50	W24
3850945	TDM160R5SCF20M	16,00	16,99	20	162	112	106	85	3,0	50	W25
3850947	TDM170R5SCF20M	17,00	17,99	20	169	119	113	90	3,2	50	W26
3850949	TDM180R5SCF25M	18,00	18,99	25	181	125	119	95	3,4	56	W27
3850951	TDM190R5SCF25M	19,00	19,99	25	187	131	125	100	3,6	56	W28
3850953	TDM200R5SCF25M	20,00	20,99	25	193	137	131	105	3,8	56	W29
3992485	TDM210R5SCF25M	21,00	21,99	25	200	144	138	110	3,7	56	W30
3992486	TDM220R5SCF25M	22,00	22,99	25	206	150	144	115	3,9	56	W31
3992487	TDM230R5SCF25M	23,00	23,99	25	212	156	150	120	4,1	56	W32
3992488	TDM240R5SCF25M	24,00	24,99	25	218	162	156	125	4,2	56	W33
3992489	TDM250R5SCF25M	25,00	25,99	25	225	169	163	130	4,4	56	W34

NOTE: SSC = Pocket Seat Reference. To correspond with the SSC on the inserts.

INDEXABLE MILLING

SOLID END MILLING

HOLEMAKING

TAPPING

TURNING

TOP DRILL M1™ • 8 x D • Flanged Shank • Metric

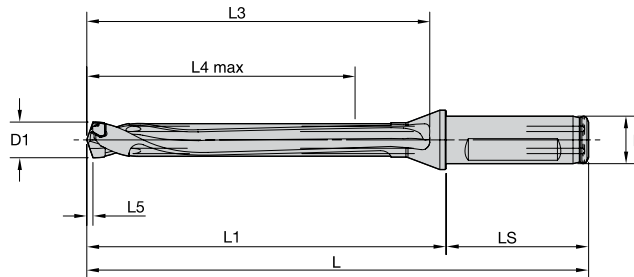

order number	catalog number	D1	D1 max	D	L	L1	L3	L4 max	L5	LS	SSC
3992141	TDM080R8SCF12M	7,94	8,49	12	129	84	79	68	1,4	45	W10
3992142	TDM085R8SCF12M	8,50	8,99	12	134	89	83	72	1,5	45	W11
3992213	TDM090R8SCF12M	9,00	9,49	12	138	93	88	76	1,6	45	W12
3992214	TDM095R8SCF12M	9,50	9,99	12	144	99	93	80	1,7	45	W13
3992215	TDM100R8SCF16M	10,00	10,49	16	151	103	98	84	1,8	48	W14
3992216	TDM105R8SCF16M	10,50	10,99	16	156	108	102	88	1,9	48	W15
3992217	TDM110R8SCF16M	11,00	11,49	16	160	112	107	92	2,0	48	W16
3992218	TDM115R8SCF16M	11,50	11,99	16	165	117	111	96	2,1	48	W17
3992219	TDM120R8SCF16M	12,00	12,49	16	169	121	116	100	2,1	48	W18
3992220	TDM125R8SCF16M	12,50	12,99	16	174	126	120	104	2,2	48	W19
3992221	TDM130R8SCF16M	13,00	13,49	16	178	130	125	108	2,3	48	W20
3992222	TDM135R8SCF16M	13,50	13,99	16	184	136	130	112	2,4	48	W21
3992223	TDM140R8SCF16M	14,00	14,49	16	188	140	135	116	2,5	48	W22
3992224	TDM145R8SCF16M	14,50	14,99	16	193	145	139	120	2,6	48	W23
3992225	TDM150R8SCF20M	15,00	15,99	20	204	154	148	128	2,7	50	W24
3992226	TDM160R8SCF20M	16,00	16,99	20	213	163	157	136	2,8	50	W25
3992227	TDM170R8SCF20M	17,00	17,99	20	223	173	167	144	3,0	50	W26
3992228	TDM180R8SCF25M	18,00	18,99	25	238	182	176	152	2,9	56	W27
3992229	TDM190R8SCF25M	19,00	19,99	25	247	191	185	160	3,4	56	W28
3992230	TDM200R8SCF25M	20,00	20,99	25	256	200	194	168	3,6	56	W29
3992231	TDM210R8SCF25M	21,00	21,99	25	266	210	204	176	3,7	56	W30
3992232	TDM220R8SCF25M	22,00	22,99	25	275	219	213	184	3,9	56	W31
3992233	TDM230R8SCF25M	23,00	23,99	25	284	228	222	192	4,1	56	W32
3992234	TDM240R8SCF25M	24,00	24,99	25	293	237	231	200	4,2	56	W33
3992235	TDM250R8SCF25M	25,00	25,99	25	303	247	241	208	4,4	56	W34

NOTE: SSC = Pocket Seat Reference. To correspond with the SSC on the inserts.

INDEXABLE MILLING

SOLID END MILLING

HOLEMAKING

TAPPING

TURNING



INDEXABLE MILLING

SOLID END MILLING

HOLEMAKING

TAPPING

TURNING

## TOP DRILL M1™ • Inserts • UP

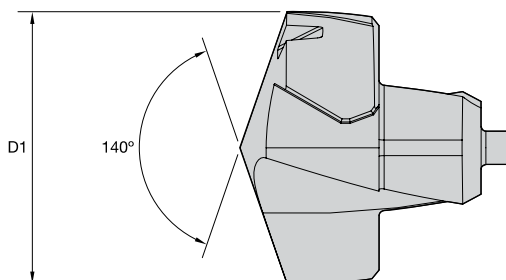

● first choice

○ alternate choice

grade WU25PD TiAlN		D1		
order #	catalog #	mm	in	SSC
3850959	TDM0794UPM	7,94	.313	W10
3848984	TDM0800UPM	8,00	.315	W10
3848985	TDM0810UPM	8,10	.319	W10
3850960	TDM0816UPM	8,16	.321	W10
3850961	TDM0820UPM	8,20	.323	W10
3848986	TDM0830UPM	8,30	.327	W10
3850962	TDM0833UPM	8,33	.328	W10
3848987	TDM0840UPM	8,40	.331	W10
3850963	TDM0843UPM	8,43	.332	W10
3848988	TDM0850UPM	8,50	.335	W11
3848989	TDM0860UPM	8,60	.339	W11
3850964	TDM0861UPM	8,61	.339	W11
3848990	TDM0870UPM	8,70	.343	W11
3850965	TDM0873UPM	8,73	.344	W11
3848991	TDM0880UPM	8,80	.347	W11
3850966	TDM0884UPM	8,84	.348	W11
3848992	TDM0890UPM	8,90	.350	W11
3849043	TDM0900UPM	9,00	.354	W12
3850967	TDM0909UPM	9,09	.358	W12
3849044	TDM0910UPM	9,10	.358	W12
3850968	TDM0913UPM	9,13	.359	W12
3849045	TDM0920UPM	9,20	.362	W12
3849046	TDM0930UPM	9,30	.366	W12
3850969	TDM0935UPM	9,35	.368	W12
3849047	TDM0940UPM	9,40	.370	W12
3849048	TDM0950UPM	9,50	.374	W13
3850970	TDM0953UPM	9,53	.375	W13
3850971	TDM0956UPM	9,56	.376	W13
3850972	TDM0958UPM	9,58	.377	W13
3849049	TDM0960UPM	9,60	.378	W13
3850973	TDM0970UPM	9,70	.382	W13
3850974	TDM0980UPM	9,80	.386	W13
3849050	TDM0990UPM	9,90	.390	W13
3850975	TDM0992UPM	9,92	.391	W13
3849051	TDM1000UPM	10,00	.394	W14
3850976	TDM1002UPM	10,02	.395	W14
3850977	TDM1008UPM	10,08	.397	W14
3849052	TDM1010UPM	10,10	.398	W14
3849053	TDM1020UPM	10,20	.402	W14
3850978	TDM1026UPM	10,26	.404	W14
3849054	TDM1030UPM	10,30	.406	W14
3850979	TDM1032UPM	10,32	.406	W14
3849055	TDM1040UPM	10,40	.409	W14
3850980	TDM1049UPM	10,49	.413	W14
3849056	TDM1050UPM	10,50	.413	W15
3849057	TDM1060UPM	10,60	.417	W15
3849058	TDM1070UPM	10,70	.421	W15
3850981	TDM1072UPM	10,72	.422	W15

TOP DRILL M1™ • Inserts • UP

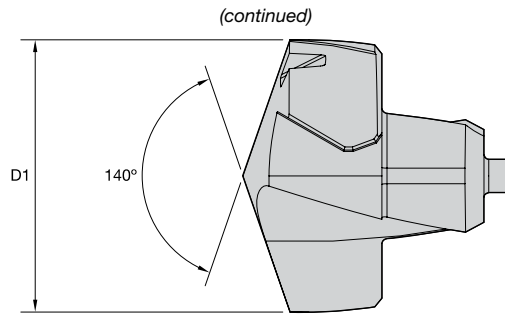

● first choice  
○ alternate choice

grade WU25PD TiAlN		D1		
order #	catalog #	mm	in	SSC
3849059	TDM1080UPM	10,80	.425	W15
3849060	TDM1090UPM	10,90	.429	W15
3849061	TDM1100UPM	11,00	.433	W16
3849062	TDM1110UPM	11,10	.437	W16
3850982	TDM1111UPM	11,11	.438	W16
3849063	TDM1120UPM	11,20	.441	W16
3849064	TDM1130UPM	11,30	.445	W16
3849065	TDM1140UPM	11,40	.449	W16
3849066	TDM1150UPM	11,50	.453	W17
3850983	TDM1151UPM	11,51	.453	W17
3849067	TDM1160UPM	11,60	.457	W17
3850984	TDM1161UPM	11,61	.457	W17
3849068	TDM1170UPM	11,70	.461	W17
3849069	TDM1180UPM	11,80	.465	W17
3849070	TDM1190UPM	11,90	.469	W17
3850985	TDM1191UPM	11,91	.469	W17
3849071	TDM1200UPM	12,00	.473	W18
3849072	TDM1210UPM	12,10	.476	W18
3849073	TDM1220UPM	12,20	.480	W18
3850986	TDM1230UPM	12,30	.484	W18
3849074	TDM1240UPM	12,40	.488	W18
3850987	TDM1247UPM	12,47	.491	W18
3849075	TDM1250UPM	12,50	.492	W19
3849076	TDM1260UPM	12,60	.496	W19
3850988	TDM1270UPM	12,70	.500	W19
3849077	TDM1280UPM	12,80	.504	W19
3850989	TDM1290UPM	12,90	.508	W19
3849078	TDM1300UPM	13,00	.512	W20
3850990	TDM1310UPM	13,10	.516	W20
3849079	TDM1320UPM	13,20	.520	W20
3849080	TDM1330UPM	13,30	.524	W20
3849081	TDM1340UPM	13,40	.528	W20
3850991	TDM1349UPM	13,49	.531	W20
3849082	TDM1350UPM	13,50	.532	W21
3849083	TDM1360UPM	13,60	.535	W21
3849084	TDM1370UPM	13,70	.539	W21
3849085	TDM1380UPM	13,80	.543	W21
3850992	TDM1389UPM	13,89	.547	W21
3850993	TDM1390UPM	13,90	.547	W21
3849086	TDM1400UPM	14,00	.551	W22
3849087	TDM1410UPM	14,10	.555	W22
3849088	TDM1420UPM	14,20	.559	W22
3850994	TDM1429UPM	14,29	.563	W22
3849089	TDM1430UPM	14,30	.563	W22
3849090	TDM1440UPM	14,40	.567	W22
3849091	TDM1450UPM	14,50	.571	W23
3849092	TDM1460UPM	14,60	.575	W23
3850995	TDM1467UPM	14,67	.577	W23

## TOP DRILL M1™ • Inserts • UP

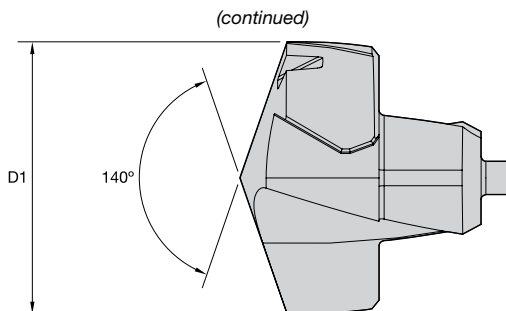

● first choice  
○ alternate choice

grade WU25PD TiAlN		D1		
order #	catalog #	mm	in	SSC
3850996	TDM1468UPM	14,68	.578	W23
3849093	TDM1470UPM	14,70	.579	W23
3849094	TDM1480UPM	14,80	.583	W23
3849095	TDM1490UPM	14,90	.587	W23
3849096	TDM1500UPM	15,00	.591	W24
3850997	TDM1508UPM	15,08	.594	W24
3849097	TDM1510UPM	15,10	.595	W24
3849098	TDM1520UPM	15,20	.598	W24
3849099	TDM1530UPM	15,30	.602	W24
3849100	TDM1540UPM	15,40	.606	W24
3850998	TDM1548UPM	15,48	.609	W24
3849101	TDM1550UPM	15,50	.610	W24
3849102	TDM1560UPM	15,60	.614	W24
3849103	TDM1570UPM	15,70	.618	W24
3849104	TDM1580UPM	15,80	.622	W24
3850999	TDM1588UPM	15,88	.625	W24
3849105	TDM1600UPM	16,00	.630	W25
3851000	TDM1603UPM	16,03	.631	W25
3851001	TDM1608UPM	16,08	.633	W25
3849106	TDM1610UPM	16,10	.634	W25
4010625	TDM1618UPM	16,18	.637	W25
3849107	TDM1620UPM	16,20	.638	W25
3851002	TDM1627UPM	16,27	.641	W25
3849108	TDM1630UPM	16,30	.642	W25
3849109	TDM1640UPM	16,40	.646	W25
3849110	TDM1650UPM	16,50	.650	W25
3849111	TDM1660UPM	16,60	.654	W25
3851003	TDM1667UPM	16,67	.656	W25
3849112	TDM1670UPM	16,70	.658	W25
3849113	TDM1680UPM	16,80	.661	W25
3851004	TDM1687UPM	16,87	.664	W25
3849114	TDM1690UPM	16,90	.665	W25
3849119	TDM1700UPM	17,00	.669	W26
3851005	TDM1707UPM	17,07	.672	W26
3849120	TDM1710UPM	17,10	.673	W26
3849121	TDM1720UPM	17,20	.677	W26
3849122	TDM1730UPM	17,30	.681	W26
3849193	TDM1740UPM	17,40	.685	W26
3851006	TDM1746UPM	17,46	.688	W26
3849194	TDM1750UPM	17,50	.689	W26
3849195	TDM1760UPM	17,60	.693	W26
3849196	TDM1770UPM	17,70	.697	W26
3849197	TDM1780UPM	17,80	.701	W26
3851007	TDM1786UPM	17,86	.703	W26
3849198	TDM1790UPM	17,90	.705	W26
3849199	TDM1800UPM	18,00	.709	W27
3849200	TDM1810UPM	18,10	.713	W27
3849201	TDM1820UPM	18,20	.717	W27

TOP DRILL M1™ • Inserts • UP

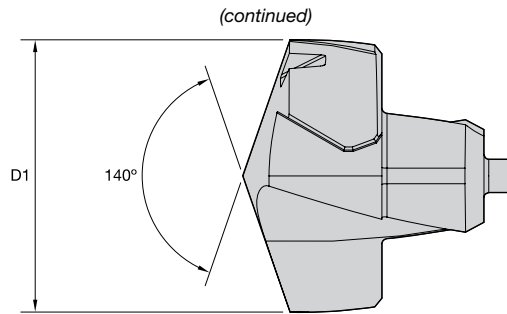

- first choice
- alternate choice

grade WU25PD TiAlN		D1		
order #	catalog #	mm	in	SSC
3851008	TDM1826UPM	18,26	.719	W27
3849202	TDM1830UPM	18,30	.721	W27
3849203	TDM1840UPM	18,40	.724	W27
3849204	TDM1850UPM	18,50	.728	W27
3849205	TDM1860UPM	18,60	.732	W27
3851009	TDM1865UPM	18,65	.734	W27
3849206	TDM1870UPM	18,70	.736	W27
3849207	TDM1880UPM	18,80	.740	W27
3849208	TDM1890UPM	18,90	.744	W27
3849209	TDM1900UPM	19,00	.748	W28
3851010	TDM1905UPM	19,05	.750	W28
3849210	TDM1910UPM	19,10	.752	W28
3849211	TDM1920UPM	19,20	.756	W28
3851011	TDM1923UPM	19,23	.757	W28
3851012	TDM1925UPM	19,25	.758	W28
3851013	TDM1928UPM	19,28	.759	W28
3849212	TDM1930UPM	19,30	.760	W28
3851014	TDM1935UPM	19,35	.762	W28
3849213	TDM1940UPM	19,40	.764	W28
3851015	TDM1945UPM	19,45	.766	W28
3849214	TDM1950UPM	19,50	.768	W28
3849215	TDM1960UPM	19,60	.772	W28
3849216	TDM1970UPM	19,70	.776	W28
3849217	TDM1980UPM	19,80	.780	W28
3851016	TDM1984UPM	19,84	.781	W28
3849218	TDM1990UPM	19,90	.784	W28
3849219	TDM2000UPM	20,00	.788	W29
3849220	TDM2010UPM	20,10	.791	W29
3849221	TDM2020UPM	20,20	.795	W29
3851017	TDM2024UPM	20,24	.797	W29
3849222	TDM2030UPM	20,30	.799	W29
3849223	TDM2040UPM	20,40	.803	W29
3849224	TDM2050UPM	20,50	.807	W29
3849225	TDM2060UPM	20,60	.811	W29
3851018	TDM2064UPM	20,64	.813	W29
3849226	TDM2070UPM	20,70	.815	W29
3849227	TDM2080UPM	20,80	.819	W29
3849228	TDM2090UPM	20,90	.823	W29
3849229	TDM2099UPM	20,99	.826	W29
4003225	TDM2100UPM	21,00	.827	W30
4003203	TDM2144UPM	21,44	.844	W30
3969291	TDM2150UPM	21,50	.846	W30
4003226	TDM2200UPM	22,00	.866	W31
4003204	TDM2223UPM	22,23	.875	W31
4003205	TDM2245UPM	22,45	.884	W31
4003227	TDM2250UPM	22,50	.887	W31
4003228	TDM2300UPM	23,00	.906	W32
4003229	TDM2350UPM	23,50	.925	W32

INDEXABLE MILLING

SOLID END MILLING

HOLEMAKING

TAPPING

TURNING

TOP DRILL M1™ • Inserts • UP

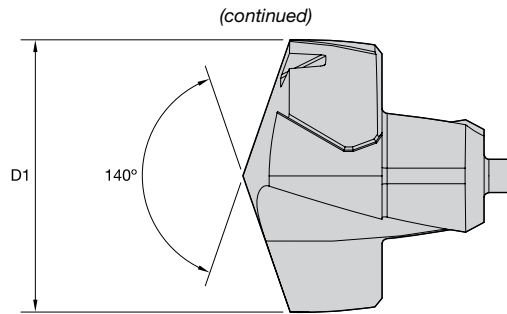

P	●
M	○
K	●
N	○
S	○
H	○

- first choice
- alternate choice

grade WU25PD TiAlN		D1		
order #	catalog #	mm	in	SSC
4003206	TDM2381UPM	23,81	.938	W32
4003230	TDM2400UPM	24,00	.945	W33
4003231	TDM2450UPM	24,50	.965	W33
4003207	TDM2461UPM	24,61	.969	W33
4003232	TDM2500UPM	25,00	.984	W34
4003208	TDM2540UPM	25,40	1,000	W34
4002444	TDM2550UPM	25,50	1,004	W34
4003209	TDM2568UPM	25,68	1,011	W34
4003210	TDM2581UPM	25,81	1,016	W34
3992013	TDM2599UPM	25,99	1,023	W34

NOTE: SSC = Pocket Seat Reference. To correspond with the SSC on the toolholder.

Application Data • UP • WU25PD • Inch

Material Group		Cutting Speed – vc Range – SFM		Recommended Feed Rate								
		min	Starting Value	max	Tool Diameter (inch)	.315	.394	.472	.551	.630	.787	1.000
		P	1	262	410	558	IPR	.004-.008	.005-.010	.006-.012	.007-.015	.007-.018
2	345		459	591	IPR	.004-.011	.005-.014	.006-.015	.008-.018	.009-.018	.011-.020	.012-.020
3	164		246	328	IPR	.004-.011	.005-.014	.006-.015	.008-.018	.009-.018	.011-.020	.012-.020
4	164		246	328	IPR	.004-.011	.005-.014	.006-.015	.007-.018	.007-.018	.009-.019	.010-.020
5	160		210	260	IPR	.004-.008	.004-.009	.004-.010	.006-.011	.006-.013	.007-.014	.009-.017
6	160		210	260	IPR	.004-.008	.004-.009	.004-.010	.006-.011	.006-.013	.007-.014	.009-.017
M	1	130	260	360	IPR	.002-.009	.003-.009	.004-.010	.004-.010	.004-.010	.005-.012	.006-.013
	2	110	180	250	IPR	.002-.009	.003-.009	.004-.010	.004-.010	.004-.010	.005-.012	.006-.013
	3	70	110	160	IPR	.002-.009	.003-.009	.004-.010	.004-.010	.004-.010	.005-.012	.006-.013
K	1	197	312	558	IPR	.006-.011	.006-.013	.007-.014	.008-.017	.010-.019	.011-.020	.013-.022
	2	197	246	295	IPR	.006-.011	.006-.012	.007-.013	.008-.016	.010-.019	.011-.020	.013-.022
	3	131	213	295	IPR	.006-.012	.007-.013	.007-.014	.008-.016	.008-.017	.009-.019	.010-.020

NOTE: Through coolant recommended for greater than 3 x D applications.

Application Data • UP • WU25PD™ • Metric

Material Group		Cutting Speed – vc Range – m/min		Recommended Feed Rate								
		min	Starting Value	max	Tool Diameter (mm)	8,0	10,0	12,0	14,0	16,0	20,0	25,0
		P	1	90	125	170	mm/r	0,11-0,20	0,13-0,25	0,14-0,31	0,17-0,39	0,19-0,45
2	105		140	180	mm/r	0,11-0,28	0,12-0,35	0,16-0,37	0,21-0,46	0,23-0,46	0,28-0,50	0,30-0,52
3	50		75	100	mm/r	0,11-0,28	0,12-0,35	0,16-0,37	0,21-0,46	0,23-0,46	0,28-0,50	0,30-0,52
4	50		75	100	mm/r	0,11-0,28	0,12-0,35	0,16-0,37	0,17-0,36	0,19-0,45	0,22-0,48	0,25-0,50
5	50		65	80	mm/r	0,10-0,20	0,10-0,23	0,10-0,25	0,14-0,29	0,16-0,32	0,18-0,36	0,22-0,42
6	50		65	80	mm/r	0,10-0,20	0,10-0,23	0,10-0,25	0,14-0,29	0,16-0,32	0,18-0,36	0,22-0,42
M	1	40	80	110	mm/r	0,06-0,22	0,08-0,23	0,09-0,24	0,10-0,25	0,11-0,26	0,13-0,28	0,13-0,32
	2	35	55	75	mm/r	0,06-0,22	0,08-0,23	0,09-0,24	0,10-0,25	0,11-0,26	0,13-0,28	0,13-0,32
	3	20	35	50	mm/r	0,06-0,22	0,08-0,23	0,09-0,24	0,10-0,25	0,11-0,26	0,13-0,28	0,13-0,32
K	1	60	95	170	mm/r	0,15-0,29	0,16-0,32	0,17-0,35	0,21-0,42	0,25-0,48	0,28-0,52	0,32-0,56
	2	60	75	90	mm/r	0,15-0,29	0,16-0,30	0,17-0,33	0,21-0,41	0,25-0,48	0,28-0,52	0,32-0,56
	3	40	65	90	mm/r	0,16-0,30	0,17-0,33	0,18-0,36	0,20-0,41	0,21-0,44	0,23-0,48	0,25-0,50

NOTE: Through coolant recommended for greater than 3 x D applications.

INDEXABLE MILLING

SOLID END MILLING

HOLEMAKING

TAPPING

TURNING

## Application Data • Victory™ TOP DRILL M1™

### How to attach inserts



1) Fix drill holder on arbor. For insert exchange, fix arbor on the machine or set on tool presetter.



2) Remove dust using air blast.



3) Put insert into drill holder. (Use gloves to protect your hands.)



4) Turn lightly in a clockwise direction. (Use gloves to protect your hands.)



5) Set the wrench properly.\*



6) Make sure the wrench fits with the insert slot for the wrench. (Is the wrench unfixed from the slot?)

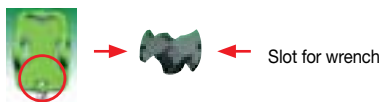

7) Slowly turn the wrench in a clockwise direction.



8) Complete.

### How to detach inserts



1) Remove dust from insert using air blast.



2) Set the wrench properly.\*



3) Fit the wrench to insert slot.



4) Turn the wrench in a counterclockwise direction.



5) Once lock is released, insert can be turned with fingers. (Use gloves to protect your hands.)



6) Remove insert. (Use gloves to protect your hands.)

\*To order the TDM1 Wrench, please use order number 3861623 and catalog number 170.315.

## Application Data • Victory™ TOP DRILL M1™

### Cautions

#### Coolant



1) Internal coolant is recommended.

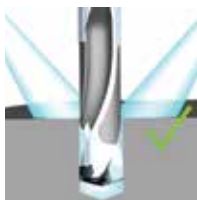

2) In case of external coolant, cutting depth must be 3 x D or less.



3) Dry cutting is not recommended. Limited applicability in cast iron materials, MQL strongly recommended.

#### Usage Precautions

##### Core deviation

1) For Turning Machines

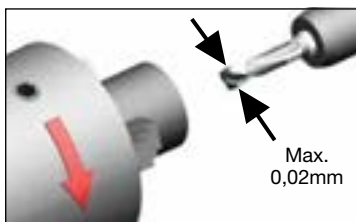

Set deviation amount under 0,02mm between workpiece and drill.

2) For Machining Centers

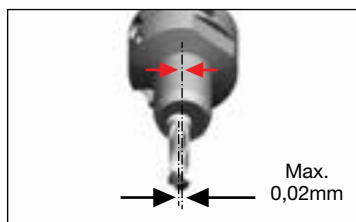

Do not use any arbor with a damaged attachment surface. Center of arbor deviation must be within 0,02mm.

Application Recommendation	Workpiece Shape
Flat Face <b>Recommended</b>	
Stacked Plates <b>Recommended</b>	
Inclined Surface >3° <b>Not Recommended</b>	
Half Cylindrical <b>Not Recommended</b>	
Hole Expansion <b>Not Recommended</b>	
Concave Surface <b>Not Recommended</b>	
Pipe Material <b>Not Recommended</b>	
Cored Hole <b>Not Recommended</b>	



# Top Cut 4™

## Efficient Indexable Drill • TC4

Top Cut 4 indexable drills are equipped with centering capabilities and inboard and outboard inserts delivering outstanding flexibility and versatility in multiple materials.

**Large Coolant Holes**  
Improves coolant in the cutting zone and facilitates easy chip evacuation.

**Large Optimized Chip Flutes** to enable chip flow and reduce vibrations.

**Rigid Cross Section – Sturdy Body**  
Higher tool life even in tough conditions.



Top Cut 4 indexable drill portfolio encompasses dual four-edged front inserts, instead of traditional drill point geometry, enabling it to perform in a variety of applications on multiple materials.

### FOUR CHIP BREAKERS IN FOUR GRADES

**-V34**



**P K**

First choice for machining steel, cast iron and short chipping materials. Suitable for severe cutting conditions.

**-V36**



**P M K N**

This insert is suitable for situations with low power consumption.

**-V38**



**P M S**

First choice for long chipping materials in titanium and stainless steel.

**-DU**



**P M K**

First choice for low-powered applications, machining of steel, cast iron and stainless steel.

# FLEXIBLE AND VERSATILE

## PRODUCT

Top Cut 4™ is an efficient drill which performs on PMKN materials with true four cutting edges.

## DIAMETER RANGE

.472–2.677" (12–68mm)

## INDUSTRY



## MATERIALS



## APPLICATIONS



DRILLING



INCLINED ENTRY



INCLINED EXIT



CROSS HOLES



BLIND



HALF-CYLINDRICAL DRILLING



CORNER DRILLING 45°



X-OFFSET



CONVEX



CHAIN DRILLING

## STEEL BODIES

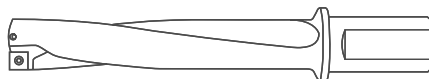
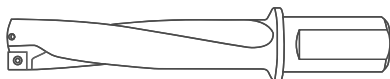
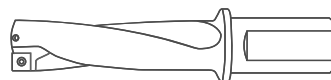

## INSERTS

### GRADES

WN10PH, WPK10CH,  
WU25CH, WU20PH,  
WU40PH

## FLANGED SR SHANK



## Top Cut 4™ Catalog Numbering System

The guide below provides an example of how to select the Top Cut 4 tool body and accompanying inserts for a stable steel drilling application.

### Metric Body

<b>TCF</b> Tool Family Top Cut 4	<b>250</b> Diameter Metric = 3 digits (e.g. 250 = 25mm) Inch = 4 digits (e.g. 2500 = 2.5")	<b>R</b> Right-Hand Cutting	<b>3</b> Length Diameter Ratio L/D = 3 x D	<b>SL</b> Shank Style SL = Side Lock Adapter	<b>32</b> Shank Size	<b>M</b> Metric	<b>D</b> Insert Size
--	---	-----------------------------------	--	--	-------------------------	--------------------	-------------------------

### Inch Body

<b>TCF</b> Tool Family Top Cut 4	<b>1000</b> Diameter Metric = 3 digits (e.g. 250 = 25mm) Inch = 4 digits (e.g. 2500 = 2.5")	<b>R</b> Right-Hand Cutting	<b>3</b> Length Diameter Ratio L/D = 3 x D	<b>SSF</b> Shank Style SSF = Straight Shank Flange	<b>100</b> Shank Size	<b>D</b> Insert Size
--	--	-----------------------------------	--	---	--------------------------	-------------------------

### Periphery Insert

<b>TCF</b> Tool Family Top Cut 4	<b>08</b> Size In-Circle D1	<b>03</b> Insert Thickness	<b>08</b> Insert Corner Radius	<b>D</b> Insert Size	<b>P</b> Insert Positioning C = Central P = Periphery	<b>V34</b> Insert Geometry	<b>WU25CH</b> Grade
--	-----------------------------------	----------------------------------	---	-------------------------	---	----------------------------------	------------------------

Insert Geometry – V34 for steel or cast iron or V36 for stainless steel and long chipping steel.

### Insert Guide for Grades

<b>W</b>	<b>U</b>	<b>25</b>	<b>C</b>	<b>H</b>
<b>W</b>	<b>U</b>	<b>40</b>	<b>P</b>	<b>H</b>
<b>W</b>	<b>PK</b>	<b>10</b>	<b>C</b>	<b>H</b>
WIDIA™	Material Range U = Universal P = Steel K = Cast Iron	Toughness Range Choose high numbers for toughness in stable conditions, low numbers for high wear resistance at continuous cuts.	Coating P = PVD C = CVD	Application H = Holemaking

## Top Cut 4 • 2 x D • SLR Shank • Inch

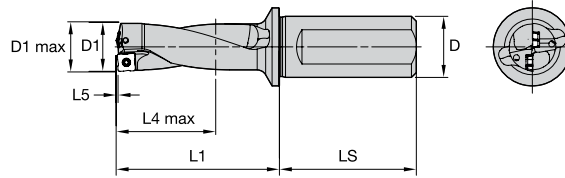

order number	catalog number	D1	D1 max	D	L1	L4 max	L5	LS	SSC	periphery insert	center insert
5537879	TCF0473R2SLR075A	.473	.493	.75	1.688	.963	.017	1.969	A	TCF040204AP	TCF040203AC
5537880	TCF0500R2SLR075A	.500	.520	.75	1.776	1.018	.018	1.969	A	TCF040204AP	TCF040203AC
5537881	TCF0531R2SLR075A	.531	.551	.75	1.876	1.081	.019	1.969	A	TCF040204AP	TCF040203AC
5578226	TCF0563R2SLR075B	.563	.583	.75	1.923	1.146	.020	1.969	B	TCF050204BP	TCF060203BC
5578227	TCF0594R2SLR075B	.594	.614	.75	2.021	1.210	.022	1.969	B	TCF050204BP	TCF060203BC
5578228	TCF0625R2SLR075B	.625	.645	.75	2.118	1.273	.023	1.969	B	TCF050204BP	TCF060203BC
5578229	TCF0656R2SLR075B	.656	.676	.75	2.215	1.336	.024	1.969	B	TCF050204BP	TCF060203BC
5578300	TCF0688R2SLR075B	.688	.708	.75	2.315	1.401	.025	1.969	B	TCF050204BP	TCF060203BC
5578301	TCF0703R2SLR075B	.703	.723	.75	2.362	1.431	.025	1.969	B	TCF050204BP	TCF060203BC
5578302	TCF0719R2SLR075B	.719	.739	.75	2.412	1.463	.026	1.969	B	TCF050204BP	TCF060203BC
5578303	TCF0734R2SLR075B	.734	.754	.75	2.459	1.494	.026	1.969	B	TCF050204BP	TCF060203BC
5578379	TCF0750R2SLR100C	.750	.770	1.00	2.510	1.527	.027	2.205	C	TCF070306CP	TCF070304CC
5578400	TCF0781R2SLR100C	.781	.801	1.00	2.607	1.590	.028	2.205	C	TCF070306CP	TCF070304CC
5578401	TCF0813R2SLR100C	.813	.833	1.00	2.707	1.655	.029	2.205	C	TCF070306CP	TCF070304CC
5578402	TCF0844R2SLR100C	.844	.864	1.00	2.804	1.718	.030	2.205	C	TCF070306CP	TCF070304CC
5578403	TCF0875R2SLR100C	.875	.895	1.00	2.901	1.781	.031	2.205	C	TCF070306CP	TCF070304CC
5578404	TCF0906R2SLR100C	.906	.926	1.00	2.998	1.844	.032	2.205	C	TCF070306CP	TCF070304CC
5578405	TCF0938R2SLR100C	.938	.958	1.00	3.097	1.908	.032	2.205	C	TCF070306CP	TCF070304CC
5537845	TCF0969R2SLR100D	.969	1.008	1.00	3.100	1.973	.035	2.205	D	TCF080308DP	TCF090305DC
5537846	TCF0984R2SLR100D	.984	1.023	1.00	3.146	2.004	.036	2.205	D	TCF080308DP	TCF090305DC
5537847	TCF1000R2SLR100D	1.000	1.039	1.00	3.194	2.036	.036	2.205	D	TCF080308DP	TCF090305DC
5537848	TCF1031R2SLR125D	1.031	1.070	1.25	3.327	2.099	.037	2.362	D	TCF080308DP	TCF090305DC
5537849	TCF1063R2SLR125D	1.063	1.102	1.25	3.424	2.164	.038	2.362	D	TCF080308DP	TCF090305DC
5537910	TCF1094R2SLR125D	1.094	1.133	1.25	3.518	2.227	.039	2.362	D	TCF080308DP	TCF090305DC
5537911	TCF1125R2SLR125D	1.125	1.164	1.25	3.612	2.290	.040	2.362	D	TCF080308DP	TCF090305DC
5537912	TCF1156R2SLR125D	1.156	1.195	1.25	3.706	2.353	.041	2.362	D	TCF080308DP	TCF090305DC
5537965	TCF1188R2SLR125E	1.188	1.227	1.25	3.685	2.419	.043	2.362	E	TCF100408EP	TCF120405EC
5537966	TCF1210R2SLR125E	1.210	1.249	1.25	3.750	2.464	.044	2.362	E	TCF100408EP	TCF120405EC
5537967	TCF1219R2SLR125E	1.219	1.258	1.25	3.776	2.482	.044	2.362	E	TCF100408EP	TCF120405EC
5537968	TCF1250R2SLR125E	1.250	1.289	1.25	3.867	2.545	.045	2.362	E	TCF100408EP	TCF120405EC
5537969	TCF1280R2SLR125E	1.281	1.320	1.25	3.958	2.608	.046	2.362	E	TCF100408EP	TCF120405EC
5538060	TCF1313R2SLR125E	1.313	1.352	1.25	4.052	2.673	.047	2.362	E	TCF100408EP	TCF120405EC
5538061	TCF1375R2SLR125E	1.375	1.414	1.25	4.233	2.799	.049	2.362	E	TCF100408EP	TCF120405EC
5538062	TCF1406R2SLR150E	1.406	1.445	1.50	4.364	2.862	.050	2.756	E	TCF100408EP	TCF120405EC
5538063	TCF1438R2SLR150E	1.438	1.438	1.50	4.457	2.926	.050	2.756	E	TCF100408EP	TCF120405EC
5578651	TCF1469R2SLR150F	1.469	1.508	1.50	4.550	2.991	.054	2.756	F	TCF120412FP	TCF150406FC
5578652	TCF1500R2SLR150F	1.500	1.539	1.50	4.641	3.055	.055	2.756	F	TCF120412FP	TCF150406FC
5578653	TCF1531R2SLR150F	1.531	1.570	1.50	4.732	3.118	.056	2.756	F	TCF120412FP	TCF150406FC
5578654	TCF1563R2SLR150F	1.563	1.602	1.50	4.826	3.183	.057	2.756	F	TCF120412FP	TCF150406FC
5578655	TCF1625R2SLR150F	1.625	1.664	1.50	5.007	3.308	.058	2.756	F	TCF120412FP	TCF150406FC
5578656	TCF1656R2SLR150F	1.656	1.695	1.50	5.098	3.371	.059	2.756	F	TCF120412FP	TCF150406FC
5578657	TCF1688R2SLR150F	1.688	1.727	1.50	5.192	3.436	.060	2.756	F	TCF120412FP	TCF150406FC
5578658	TCF1750R2SLR150F	1.750	1.789	1.50	5.373	3.562	.062	2.756	F	TCF120412FP	TCF150406FC
5578659	TCF1813R2SLR150G	1.813	1.852	1.50	5.379	3.692	.066	2.756	G	TCF150512GP	TCF180508GC
5578766	TCF1875R2SLR150G	1.875	1.914	1.50	5.554	3.818	.068	2.756	G	TCF150512GP	TCF180508GC
5578767	TCF1938R2SLR150G	1.938	1.977	1.50	5.732	3.945	.069	2.756	G	TCF150512GP	TCF180508GC
5578768	TCF2000R2SLR150G	2.000	2.039	1.50	5.907	4.071	.071	2.756	G	TCF150512GP	TCF180508GC
5578769	TCF2125R2SLR150G	2.125	2.164	1.50	6.261	4.324	.075	2.756	G	TCF150512GP	TCF180508GC
5578790	TCF2219R2SLR150G	2.219	2.258	1.50	6.527	4.515	.077	2.756	G	TCF150512GP	TCF180508GC
5538500	TCF2250R2SLR150H	2.250	2.289	1.50	6.392	4.581	.081	2.756	H	TCF180614HP	TCF210608HC
5538501	TCF2375R2SLR150H	2.375	2.414	1.50	6.734	4.835	.085	2.756	H	TCF180614HP	TCF210608HC
5538502	TCF2500R2SLR150H	2.500	2.539	1.50	7.074	5.088	.088	2.756	H	TCF180614HP	TCF210608HC

D	LS	
	mm	in
.75	50	1.9685
1.00	56	2.2047
1.25	60	2.3622
1.50	70	2.7559

NOTE: SSC = Pocket Seat Reference. To correspond with the SSC on the inserts.  
 NOTE: Drilling in stacked plates possible in certain applications. Ask for technical support.  
 Drill shipped with insert screws and Torx wrench.  
 See pages C103-C112 for inserts.  
 SSC = Pocket Seat Reference.  
 SLR = Side Lock.  
 D1 max is an achievable diameter using x-offset.

### WARNING

During through-hole operations, a slug or disc is produced as the tool breaks through the workpiece. When the drill is stationary and the workpiece is rotating, this slug may be hurled from the chuck by centrifugal force. Provide adequate shielding to protect bystanders.

# Indexable Drills • Top Cut 4™ Series

INDEXABLE MILLING

SOLID END MILLING

HOLEMAKING

TAPPING

TURNING

## Top Cut 4 • 3 x D • SLR Shank • Inch

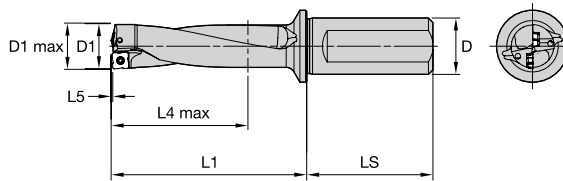

order number	catalog number	D1	D1 max	D	L1	L4 max	L5	LS	SSC	periphery insert	center insert
5537882	TCF0473R3SLR075A	.473	.493	.75	2.161	1.436	.017	1.969	A	TCF040204AP	TCF040203AC
5537883	TCF0500R3SLR075A	.500	.520	.75	2.276	1.518	.018	1.969	A	TCF040204AP	TCF040203AC
5537884	TCF0531R3SLR075A	.531	.551	.75	2.407	1.612	.019	1.969	A	TCF040204AP	TCF040203AC
5578304	TCF0563R3SLR075B	.563	.583	.75	2.486	1.709	.020	1.969	B	TCF050204BP	TCF060203BC
5578305	TCF0594R3SLR075B	.594	.614	.75	2.615	1.804	.022	1.969	B	TCF050204BP	TCF060203BC
5578306	TCF0625R3SLR075B	.625	.645	.75	2.743	1.898	.023	1.969	B	TCF050204BP	TCF060203BC
5578307	TCF0656R3SLR075B	.656	.676	.75	2.871	1.992	.024	1.969	B	TCF050204BP	TCF060203BC
5578308	TCF0688R3SLR075B	.688	.708	.75	3.003	2.089	.025	1.969	B	TCF050204BP	TCF060203BC
5578309	TCF0703R3SLR075B	.703	.723	.75	3.065	2.134	.025	1.969	B	TCF050204BP	TCF060203BC
5578310	TCF0719R3SLR075B	.719	.739	.75	3.131	2.182	.026	1.969	B	TCF050204BP	TCF060203BC
5578311	TCF0734R3SLR075B	.734	.754	.75	3.193	2.228	.026	1.969	B	TCF050204BP	TCF060203BC
5578406	TCF0750R3SLR100C	.750	.770	1.00	3.260	2.277	.027	2.205	C	TCF070306CP	TCF070304CC
5578407	TCF0781R3SLR100C	.781	.801	1.00	3.388	2.371	.028	2.205	C	TCF070306CP	TCF070304CC
5578408	TCF0813R3SLR100C	.813	.833	1.00	3.520	2.468	.029	2.205	C	TCF070306CP	TCF070304CC
5578409	TCF0844R3SLR100C	.844	.864	1.00	3.648	2.562	.030	2.205	C	TCF070306CP	TCF070304CC
5578410	TCF0875R3SLR100C	.875	.895	1.00	3.776	2.656	.031	2.205	C	TCF070306CP	TCF070304CC
5578411	TCF0906R3SLR100C	.906	.926	1.00	3.904	2.750	.032	2.205	C	TCF070306CP	TCF070304CC
5578412	TCF0938R3SLR100C	.938	.958	1.00	4.035	2.846	.032	2.205	C	TCF070306CP	TCF070304CC
5537913	TCF0969R3SLR100D	.969	1.008	1.00	4.069	2.942	.035	2.205	D	TCF080308DP	TCF090305DC
5537914	TCF0984R3SLR100D	.984	1.023	1.00	4.130	2.988	.036	2.205	D	TCF080308DP	TCF090305DC
5537915	TCF1000R3SLR100D	1.000	1.039	1.00	4.194	3.036	.036	2.205	D	TCF080308DP	TCF090305DC
5537916	TCF1031R3SLR125D	1.031	1.070	1.25	4.358	3.130	.037	2.362	D	TCF080308DP	TCF090305DC
5537917	TCF1063R3SLR125D	1.063	1.102	1.25	4.487	3.227	.038	2.362	D	TCF080308DP	TCF090305DC
5537918	TCF1094R3SLR125D	1.094	1.133	1.25	4.612	3.321	.039	2.362	D	TCF080308DP	TCF090305DC
5537919	TCF1125R3SLR125D	1.125	1.164	1.25	4.737	3.415	.040	2.362	D	TCF080308DP	TCF090305DC
5537920	TCF1156R3SLR125D	1.156	1.195	1.25	4.862	3.509	.041	2.362	D	TCF080308DP	TCF090305DC
5538064	TCF1188R3SLR125E	1.188	1.227	1.25	4.873	3.607	.043	2.362	E	TCF100408EP	TCF120405EC
5538065	TCF1210R3SLR125E	1.210	1.249	1.25	4.960	3.674	.044	2.362	E	TCF100408EP	TCF120405EC
5538066	TCF1219R3SLR125E	1.219	1.258	1.25	4.995	3.701	.044	2.362	E	TCF100408EP	TCF120405EC
5538067	TCF1250R3SLR125E	1.250	1.289	1.25	5.117	3.795	.045	2.362	E	TCF100408EP	TCF120405EC
5538068	TCF1280R3SLR125E	1.281	1.320	1.25	5.239	3.889	.046	2.362	E	TCF100408EP	TCF120405EC
5538069	TCF1313R3SLR125E	1.313	1.352	1.25	5.365	3.986	.047	2.362	E	TCF100408EP	TCF120405EC
5538080	TCF1375R3SLR125E	1.375	1.414	1.25	5.608	4.174	.049	2.362	E	TCF100408EP	TCF120405EC
5538081	TCF1406R3SLR150E	1.406	1.445	1.50	5.770	4.268	.050	2.756	E	TCF100408EP	TCF120405EC
5538082	TCF1438R3SLR150E	1.438	1.477	1.50	5.895	4.364	.050	2.756	E	TCF100408EP	TCF120405EC
5578659	TCF1469R3SLR150F	1.469	1.508	1.50	6.019	4.460	.054	2.756	F	TCF120412FP	TCF150406FC
5578670	TCF1500R3SLR150F	1.500	1.539	1.50	6.141	4.555	.055	2.756	F	TCF120412FP	TCF150406FC
5578671	TCF1531R3SLR150F	1.531	1.570	1.50	6.263	4.649	.056	2.756	F	TCF120412FP	TCF150406FC
5578672	TCF1563R3SLR150F	1.563	1.602	1.50	6.389	4.746	.057	2.756	F	TCF120412FP	TCF150406FC
5578673	TCF1625R3SLR150F	1.625	1.664	1.50	6.632	4.933	.058	2.756	F	TCF120412FP	TCF150406FC
5578674	TCF1656R3SLR150F	1.656	1.695	1.50	6.754	5.027	.059	2.756	F	TCF120412FP	TCF150406FC
5578675	TCF1688R3SLR150F	1.688	1.727	1.50	6.880	5.124	.060	2.756	F	TCF120412FP	TCF150406FC
5578676	TCF1750R3SLR150F	1.750	1.789	1.50	7.123	5.312	.062	2.756	F	TCF120412FP	TCF150406FC
5578791	TCF1813R3SLR150G	1.813	1.852	1.50	7.192	5.505	.066	2.756	G	TCF150512GP	TCF180508GC
5578792	TCF1875R3SLR150G	1.875	1.914	1.50	7.429	5.693	.068	2.756	G	TCF150512GP	TCF180508GC
5578793	TCF1938R3SLR150G	1.938	1.977	1.50	7.670	5.883	.069	2.756	G	TCF150512GP	TCF180508GC
5578794	TCF2000R3SLR150G	2.000	2.039	1.50	7.832	6.071	.071	2.756	G	TCF150512GP	TCF180508GC
5578795	TCF2125R3SLR150G	2.125	2.164	1.50	8.307	6.450	.075	2.756	G	TCF150512GP	TCF180508GC
5578796	TCF2219R3SLR150G	2.219	2.258	1.50	8.665	6.734	.077	2.756	G	TCF150512GP	TCF180508GC
5538503	TCF2250R3SLR150H	2.250	2.289	1.50	8.642	6.831	.081	2.756	H	TCF180614HP	TCF210608HC
5538504	TCF2375R3SLR150H	2.375	2.414	1.50	9.109	7.210	.085	2.756	H	TCF180614HP	TCF210608HC
5538505	TCF2500R3SLR150H	2.500	2.539	1.50	9.574	7.588	.088	2.756	H	TCF180614HP	TCF210608HC

D	LS	
	mm	in
.75	50	1.9685
1.00	56	2.2047
1.25	60	2.3622
1.50	70	2.7559

NOTE: SSC = Pocket Seat Reference. To correspond with the SSC on the inserts.  
 NOTE: Drilling in stacked plates possible in certain applications. Ask for technical support.  
 Drill shipped with insert screws and Torx wrench.  
 See pages C103-C112 for inserts.  
 SSC = Pocket Seat Reference.  
 SLR = Side Lock.  
 D1 max is an achievable diameter using x-offset.

**WARNING**  
 During through-hole operations, a slug or disc is produced as the tool breaks through the workpiece.  
 When the drill is stationary and the workpiece is rotating, this slug may be hurled from the chuck by centrifugal force.  
 Provide adequate shielding to protect bystanders.



## Top Cut 4 • 4 x D • SLR Shank • Inch

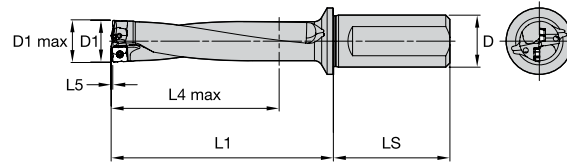

order number	catalog number	D1	D1 max	D	L1	L4 max	L5	LS	SSC	periphery insert	center insert
5537885	TCF0473R4SLR075A	.473	.493	.75	2.634	1.909	.017	1.969	A	TCF040204AP	TCF040203AC
5537886	TCF0500R4SLR075A	.500	.520	.75	2.776	2.018	.018	1.969	A	TCF040204AP	TCF040203AC
5537887	TCF0531R4SLR075A	.531	.551	.75	2.938	2.143	.019	1.969	A	TCF040204AP	TCF040203AC
5578312	TCF0563R4SLR075B	.563	.583	.75	3.049	2.272	.020	1.969	B	TCF050204BP	TCF060203BC
5578313	TCF0594R4SLR075B	.594	.614	.75	3.209	2.398	.022	1.969	B	TCF050204BP	TCF060203BC
5578314	TCF0625R4SLR075B	.625	.645	.75	3.368	2.523	.023	1.969	B	TCF050204BP	TCF060203BC
5578315	TCF0656R4SLR075B	.656	.676	.75	3.527	2.648	.024	1.969	B	TCF050204BP	TCF060203BC
5578316	TCF0688R4SLR075B	.688	.708	.75	3.691	2.777	.025	1.969	B	TCF050204BP	TCF060203BC
5578317	TCF0703R4SLR075B	.703	.723	.75	3.768	2.837	.025	1.969	B	TCF050204BP	TCF060203BC
5578318	TCF0719R4SLR075B	.719	.739	.75	3.850	2.901	.026	1.969	B	TCF050204BP	TCF060203BC
5578319	TCF0734R4SLR075B	.734	.754	.75	3.927	2.962	.026	1.969	B	TCF050204BP	TCF060203BC
5578413	TCF0750R4SLR100C	.750	.770	1.00	4.010	3.027	.027	2.205	C	TCF070306CP	TCF070304CC
5578414	TCF0781R4SLR100C	.781	.801	1.00	4.169	3.152	.028	2.205	C	TCF070306CP	TCF070304CC
5578415	TCF0813R4SLR100C	.813	.833	1.00	4.333	3.281	.029	2.205	C	TCF070306CP	TCF070304CC
5578416	TCF0844R4SLR100C	.844	.864	1.00	4.492	3.406	.030	2.205	C	TCF070306CP	TCF070304CC
5578417	TCF0875R4SLR100C	.875	.895	1.00	4.651	3.531	.031	2.205	C	TCF070306CP	TCF070304CC
5578418	TCF0906R4SLR100C	.906	.926	1.00	4.810	3.656	.032	2.205	C	TCF070306CP	TCF070304CC
5578419	TCF0938R4SLR100C	.938	.958	1.00	4.973	3.784	.032	2.205	C	TCF070306CP	TCF070304CC
5537921	TCF0969R4SLR100D	.969	1.008	1.00	5.038	3.911	.035	2.205	D	TCF080308DP	TCF090305DC
5537922	TCF0984R4SLR100D	.984	1.023	1.00	5.114	3.972	.036	2.205	D	TCF080308DP	TCF090305DC
5537923	TCF1000R4SLR100D	1.000	1.039	1.00	5.194	4.036	.036	2.205	D	TCF080308DP	TCF090305DC
5537924	TCF1031R4SLR125D	1.031	1.070	1.25	5.389	4.161	.037	2.362	D	TCF080308DP	TCF090305DC
5537925	TCF1063R4SLR125D	1.063	1.102	1.25	5.550	4.290	.038	2.362	D	TCF080308DP	TCF090305DC
5537926	TCF1094R4SLR125D	1.094	1.133	1.25	5.706	4.415	.039	2.362	D	TCF080308DP	TCF090305DC
5537927	TCF1125R4SLR125D	1.125	1.164	1.25	5.862	4.540	.040	2.362	D	TCF080308DP	TCF090305DC
5537928	TCF1156R4SLR125D	1.156	1.195	1.25	6.018	4.665	.041	2.362	D	TCF080308DP	TCF090305DC
5538083	TCF1188R4SLR125E	1.188	1.227	1.25	6.061	4.795	.043	2.362	E	TCF100408EP	TCF120405EC
5538084	TCF1210R4SLR125E	1.210	1.249	1.25	6.170	4.884	.044	2.362	E	TCF100408EP	TCF120405EC
5538085	TCF1219R4SLR125E	1.219	1.258	1.25	6.214	4.920	.044	2.362	E	TCF100408EP	TCF120405EC
5538086	TCF1250R4SLR125E	1.250	1.289	1.25	6.367	5.045	.045	2.362	E	TCF100408EP	TCF120405EC
5538087	TCF1280R4SLR125E	1.281	1.320	1.25	6.520	5.170	.046	2.362	E	TCF100408EP	TCF120405EC
5538088	TCF1313R4SLR125E	1.313	1.352	1.25	6.678	5.299	.047	2.362	E	TCF100408EP	TCF120405EC
5538089	TCF1375R4SLR125E	1.375	1.414	1.25	6.983	5.549	.049	2.362	E	TCF100408EP	TCF120405EC
5538090	TCF1406R4SLR150E	1.406	1.445	1.50	7.176	5.674	.050	2.756	E	TCF100408EP	TCF120405EC
5538091	TCF1438R4SLR150E	1.438	1.477	1.50	7.333	5.802	.050	2.756	E	TCF100408EP	TCF120405EC
5578677	TCF1469R4SLR150F	1.469	1.508	1.50	7.488	5.929	.054	2.756	F	TCF120412FP	TCF150406FC
5578678	TCF1500R4SLR150F	1.500	1.539	1.50	7.641	6.054	.055	2.756	F	TCF120412FP	TCF150406FC
5578679	TCF1531R4SLR150F	1.531	1.570	1.50	7.794	6.180	.056	2.756	F	TCF120412FP	TCF150406FC
5578680	TCF1563R4SLR150F	1.563	1.602	1.50	7.952	6.309	.057	2.756	F	TCF120412FP	TCF150406FC
5578681	TCF1625R4SLR150F	1.625	1.664	1.50	8.257	6.558	.058	2.756	F	TCF120412FP	TCF150406FC
5578682	TCF1656R4SLR150F	1.656	1.695	1.50	8.410	6.683	.059	2.756	F	TCF120412FP	TCF150406FC
5578683	TCF1688R4SLR150F	1.688	1.727	1.50	8.568	6.812	.060	2.756	F	TCF120412FP	TCF150406FC
5578684	TCF1750R4SLR150F	1.750	1.789	1.50	8.873	7.062	.062	2.756	F	TCF120412FP	TCF150406FC
5578797	TCF1813R4SLR150G	1.813	1.852	1.50	9.005	7.318	.066	2.756	G	TCF150512GP	TCF180508GC
5578798	TCF1875R4SLR150G	1.875	1.914	1.50	9.304	7.568	.068	2.756	G	TCF150512GP	TCF180508GC
5578799	TCF1938R4SLR150G	1.938	1.977	1.50	9.608	7.821	.069	2.756	G	TCF150512GP	TCF180508GC
5578800	TCF2000R4SLR150G	2.000	2.039	1.50	9.907	8.071	.071	2.756	G	TCF150512GP	TCF180508GC
5578801	TCF2125R4SLR150G	2.125	2.164	1.50	10.511	8.574	.075	2.756	G	TCF150512GP	TCF180508GC
5578802	TCF2219R4SLR150G	2.219	2.258	1.50	10.965	8.953	.077	2.756	G	TCF150512GP	TCF180508GC
5538506	TCF2250R4SLR150H	2.250	2.289	1.50	10.892	9.081	.081	2.756	H	TCF180614HP	TCF210608HC
5538507	TCF2375R4SLR150H	2.375	2.414	1.50	11.484	9.585	.085	2.756	H	TCF180614HP	TCF210608HC
5538508	TCF2500R4SLR150H	2.500	2.539	1.50	12.074	10.088	.088	2.756	H	TCF180614HP	TCF210608HC

D	LS	
	mm	in
.75	50	1.9685
1.00	56	2.2047
1.25	60	2.3622
1.50	70	2.7559

NOTE: SSC = Pocket Seat Reference. To correspond with the SSC on the inserts.  
 NOTE: Drilling in stacked plates possible in certain applications. Ask for technical support.  
 Drill shipped with insert screws and Torx wrench.  
 See pages C103-C112 for inserts.  
 SSC = Pocket Seat Reference.  
 SLR = Side Lock.  
 D1 max is an achievable diameter using x-offset.

### WARNING

During through-hole operations, a slug or disc is produced as the tool breaks through the workpiece. When the drill is stationary and the workpiece is rotating, this slug may be hurled from the chuck by centrifugal force. Provide adequate shielding to protect bystanders.

# Indexable Drills • Top Cut 4™ Series

INDEXABLE MILLING

SOLID END MILLING

HOLEMAKING

TAPPING

TURNING

## Top Cut 4 • 5 x D • SLR Shank • Inch

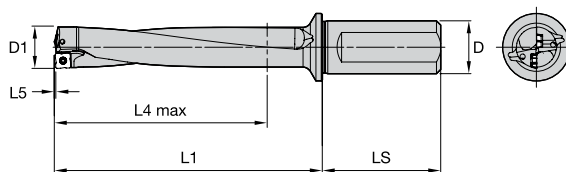

order number	catalog number	D1	D	L1	L4 max	L5	LS	SSC	periphery insert	center insert
5537888	TCF0473R5SLR075A	.473	.75	3.107	2.382	.017	1.969	A	TCF040204AP	TCF040203AC
5537889	TCF0500R5SLR075A	.500	.75	3.276	2.518	.018	1.969	A	TCF040204AP	TCF040203AC
5537890	TCF0531R5SLR075A	.531	.75	3.469	2.674	.019	1.969	A	TCF040204AP	TCF040203AC
5578320	TCF0563R5SLR075B	.563	.75	3.612	2.835	.020	1.969	B	TCF050204BP	TCF060203BC
5578321	TCF0594R5SLR075B	.594	.75	3.803	2.992	.022	1.969	B	TCF050204BP	TCF060203BC
5578322	TCF0625R5SLR075B	.625	.75	3.993	3.148	.023	1.969	B	TCF050204BP	TCF060203BC
5578323	TCF0656R5SLR075B	.656	.75	4.183	3.304	.024	1.969	B	TCF050204BP	TCF060203BC
5578324	TCF0688R5SLR075B	.688	.75	4.379	3.465	.025	1.969	B	TCF050204BP	TCF060203BC
5578325	TCF0703R5SLR075B	.703	.75	4.471	3.540	.025	1.969	B	TCF050204BP	TCF060203BC
5578326	TCF0719R5SLR075B	.719	.75	4.569	3.620	.026	1.969	B	TCF050204BP	TCF060203BC
5578327	TCF0734R5SLR075B	.734	.75	4.661	3.696	.026	1.969	B	TCF050204BP	TCF060203BC
5578420	TCF0750R5SLR100C	.750	1.00	4.760	3.777	.027	2.205	C	TCF070306CP	TCF070304CC
5578421	TCF0781R5SLR100C	.781	1.00	4.950	3.933	.028	2.205	C	TCF070306CP	TCF070304CC
5578422	TCF0813R5SLR100C	.813	1.00	5.146	4.094	.029	2.205	C	TCF070306CP	TCF070304CC
5578423	TCF0844R5SLR100C	.844	1.00	5.336	4.250	.030	2.205	C	TCF070306CP	TCF070304CC
5578424	TCF0875R5SLR100C	.875	1.00	5.526	4.406	.031	2.205	C	TCF070306CP	TCF070304CC
5578425	TCF0906R5SLR100C	.906	1.00	5.716	4.562	.032	2.205	C	TCF070306CP	TCF070304CC
5578426	TCF0938R5SLR100C	.938	1.00	5.911	4.722	.032	2.205	C	TCF070306CP	TCF070304CC
5537929	TCF0969R5SLR100D	.969	1.00	6.007	4.880	.035	2.205	D	TCF080308DP	TCF090305DC
5537930	TCF0984R5SLR100D	.984	1.00	6.098	4.956	.036	2.205	D	TCF080308DP	TCF090305DC
5537931	TCF1000R5SLR100D	1.000	1.00	6.194	5.036	.036	2.205	D	TCF080308DP	TCF090305DC
5537932	TCF1031R5SLR125D	1.031	1.25	6.420	5.192	.037	2.362	D	TCF080308DP	TCF090305DC
5537933	TCF1063R5SLR125D	1.063	1.25	6.613	5.353	.038	2.362	D	TCF080308DP	TCF090305DC
5537934	TCF1094R5SLR125D	1.094	1.25	6.800	5.509	.039	2.362	D	TCF080308DP	TCF090305DC
5537935	TCF1125R5SLR125D	1.125	1.25	6.987	5.665	.040	2.362	D	TCF080308DP	TCF090305DC
5537936	TCF1156R5SLR125D	1.156	1.25	7.174	5.821	.041	2.362	D	TCF080308DP	TCF090305DC
5538092	TCF1188R5SLR125E	1.188	1.25	7.249	5.983	.043	2.362	E	TCF100408EP	TCF120405EC
5538093	TCF1210R5SLR125E	1.210	1.25	7.380	6.094	.044	2.362	E	TCF100408EP	TCF120405EC
5538094	TCF1219R5SLR125E	1.219	1.25	7.433	6.139	.044	2.362	E	TCF100408EP	TCF120405EC
5538095	TCF1250R5SLR125E	1.250	1.25	7.617	6.295	.045	2.362	E	TCF100408EP	TCF120405EC
5538096	TCF1280R5SLR125E	1.281	1.25	7.801	6.451	.046	2.362	E	TCF100408EP	TCF120405EC
5538097	TCF1313R5SLR125E	1.313	1.25	7.991	6.612	.047	2.362	E	TCF100408EP	TCF120405EC
5538098	TCF1375R5SLR125E	1.375	1.25	8.358	6.924	.049	2.362	E	TCF100408EP	TCF120405EC
5538099	TCF1406R5SLR150E	1.406	1.50	8.582	7.080	.050	2.756	E	TCF100408EP	TCF120405EC
5538100	TCF1438R5SLR150E	1.438	1.50	8.771	7.240	.050	2.756	E	TCF100408EP	TCF120405EC
5578685	TCF1469R5SLR150F	1.469	1.50	8.957	7.398	.054	2.756	F	TCF120412FP	TCF150406FC
5578686	TCF1500R5SLR150F	1.500	1.50	9.141	7.554	.055	2.756	F	TCF120412FP	TCF150406FC
5578687	TCF1531R5SLR150F	1.531	1.50	9.325	7.711	.056	2.756	F	TCF120412FP	TCF150406FC
5578688	TCF1563R5SLR150F	1.563	1.50	9.515	7.872	.057	2.756	F	TCF120412FP	TCF150406FC
5578689	TCF1625R5SLR150F	1.625	1.50	9.882	8.183	.058	2.756	F	TCF120412FP	TCF150406FC
5578690	TCF1656R5SLR150F	1.656	1.50	10.066	8.339	.059	2.756	F	TCF120412FP	TCF150406FC
5578691	TCF1688R5SLR150F	1.688	1.50	10.256	8.500	.060	2.756	F	TCF120412FP	TCF150406FC
5578693	TCF1750R5SLR150G	1.750	1.50	10.623	8.812	.062	2.756	F	TCF120412FP	TCF150406FC
5578803	TCF1813R5SLR150G	1.813	1.50	10.818	9.131	.066	2.756	G	TCF150512GP	TCF180508GC
5578804	TCF1875R5SLR150G	1.875	1.50	11.179	9.443	.068	2.756	G	TCF150512GP	TCF180508GC
5578805	TCF1938R5SLR150G	1.938	1.50	11.546	9.759	.069	2.756	G	TCF150512GP	TCF180508GC
5578806	TCF2000R5SLR150G	2.000	1.50	11.907	10.071	.071	2.756	G	TCF150512GP	TCF180508GC
5578807	TCF2125R5SLR150G	2.125	1.50	12.636	10.699	.075	2.756	G	TCF150512GP	TCF180508GC
5578808	TCF2219R5SLR150G	2.219	1.50	13.184	11.172	.077	2.756	G	TCF150512GP	TCF180508GC
5538509	TCF2250R5SLR150H	2.250	1.50	13.142	11.331	.081	2.756	H	TCF180614HP	TCF210608HC
5538510	TCF2375R5SLR150H	2.375	1.50	13.859	11.960	.085	2.756	H	TCF180614HP	TCF210608HC
5538511	TCF2500R5SLR150H	2.500	1.50	14.574	12.588	.088	2.756	H	TCF180614HP	TCF210608HC

D	LS	
	mm	in
.75	50	1.9685
1.00	56	2.2047
1.25	60	2.3622
1.50	70	2.7559

NOTE: SSC = Pocket Seat Reference. To correspond with the SSC on the inserts.  
 NOTE: Drilling in stacked plates possible in certain applications. Ask for technical support.  
 Drill shipped with insert screws and Torx wrench.  
 See pages C103-C112 for inserts.  
 SSC = Pocket Seat Reference.  
 SLR = Side Lock.  
 D1 max is an achievable diameter using x-offset.

**WARNING**  
 During through-hole operations, a slug or disc is produced as the tool breaks through the workpiece.  
 When the drill is stationary and the workpiece is rotating, this slug may be hurled from the chuck by centrifugal force.  
 Provide adequate shielding to protect bystanders.

**Top Cut 4 • 2 x D • SLR Shanks • Metric**

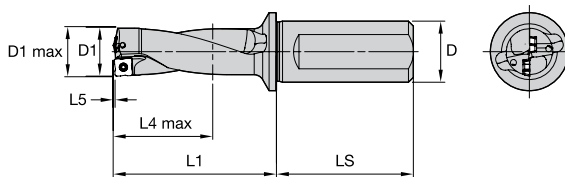

order number	catalog number	D1	D1 max	D	L1	L4 max	L5	LS	SSC	periphery insert	center insert
5537778	TCF120R2SLR20MA	12,00	12,50	20	43,4	24,4	0,43	50,00	A	TCF040204AP	TCF040203AC
5537779	TCF125R2SLR20MA	12,50	13,00	20	44,5	25,5	0,45	50,00	A	TCF040204AP	TCF040203AC
5537860	TCF127R2SLR20MA	12,70	13,20	20	45,9	25,9	0,46	50,00	A	TCF040204AP	TCF040203AC
5537861	TCF130R2SLR20MA	13,00	13,50	20	46,5	26,5	0,47	50,00	A	TCF040204AP	TCF040203AC
5537862	TCF135R2SLR20MA	13,50	14,00	20	48,5	27,5	0,48	50,00	A	TCF040204AP	TCF040203AC
5577828	TCF140R2SLR25MB	14,00	14,50	25	48,5	28,5	0,49	56,00	B	TCF050204BP	TCF060203BC
5577829	TCF145R2SLR25MB	14,50	15,00	25	49,5	29,5	0,52	56,00	B	TCF050204BP	TCF060203BC
5577920	TCF150R2SLR25MB	15,00	15,50	25	51,5	30,5	0,55	56,00	B	TCF050204BP	TCF060203BC
5577921	TCF155R2SLR25MB	15,50	16,00	25	53,6	31,6	0,56	56,00	B	TCF050204BP	TCF060203BC
5577922	TCF160R2SLR25MB	16,00	16,50	25	54,6	32,6	0,58	56,00	B	TCF050204BP	TCF060203BC
5577923	TCF165R2SLR25MB	16,50	17,00	25	56,6	33,6	0,60	56,00	B	TCF050204BP	TCF060203BC
5577924	TCF170R2SLR25MB	17,00	17,50	25	57,6	34,6	0,61	56,00	B	TCF050204BP	TCF060203BC
5577925	TCF175R2SLR25MB	17,50	18,00	25	59,6	35,6	0,63	56,00	B	TCF050204BP	TCF060203BC
5577926	TCF180R2SLR25MB	18,00	18,50	25	60,6	36,6	0,64	56,00	B	TCF050204BP	TCF060203BC
5577927	TCF185R2SLR25MB	18,50	19,00	25	62,7	37,7	0,65	56,00	B	TCF050204BP	TCF060203BC
5578820	TCF190R2SLR25MC	19,00	19,50	25	63,7	38,7	0,68	56,00	C	TCF070306CP	TCF070304CC
5578821	TCF195R2SLR25MC	19,50	20,00	25	65,7	39,7	0,71	56,00	C	TCF070306CP	TCF070304CC
5578822	TCF200R2SLR25MC	20,00	20,50	25	66,7	40,7	0,72	56,00	C	TCF070306CP	TCF070304CC
5578823	TCF205R2SLR25MC	20,50	21,00	25	68,7	41,7	0,74	56,00	C	TCF070306CP	TCF070304CC
5578824	TCF210R2SLR25MC	21,00	21,50	25	70,8	42,8	0,75	56,00	C	TCF070306CP	TCF070304CC
5578825	TCF220R2SLR25MC	22,00	22,50	25	73,8	44,8	0,78	56,00	C	TCF070306CP	TCF070304CC
5578826	TCF225R2SLR25MC	22,50	23,00	25	74,8	45,8	0,79	56,00	C	TCF070306CP	TCF070304CC
5578827	TCF230R2SLR25MC	23,00	23,50	25	76,8	46,8	0,80	56,00	C	TCF070306CP	TCF070304CC
5537167	TCF240R2SLR25MD	24,00	25,00	25	76,9	48,9	0,87	56,00	D	TCF080308DP	TCF090305DC
5537168	TCF250R2SLR32MD	25,00	26,00	32	80,9	50,9	0,91	60,00	D	TCF080308DP	TCF090305DC
5537169	TCF260R2SLR32MD	26,00	27,00	32	83,9	52,9	0,94	60,00	D	TCF080308DP	TCF090305DC
5537820	TCF265R2SLR32MD	26,50	27,50	32	86,0	54,0	0,95	60,00	D	TCF080308DP	TCF090305DC
5537821	TCF270R2SLR32MD	27,00	28,00	32	87,0	55,0	0,97	60,00	D	TCF080308DP	TCF090305DC
5537822	TCF280R2SLR32MD	28,00	29,00	32	90,0	57,0	0,99	60,00	D	TCF080308DP	TCF090305DC
5537823	TCF290R2SLR32MD	29,00	30,00	32	93,0	59,0	1,02	60,00	D	TCF080308DP	TCF090305DC
5537937	TCF300R2SLR32ME	30,00	31,00	32	93,1	61,1	1,09	60,00	E	TCF100408EP	TCF120405EC
5537938	TCF310R2SLR32ME	31,00	32,00	32	96,1	63,1	1,12	60,00	E	TCF100408EP	TCF120405EC
5537939	TCF320R2SLR32ME	32,00	33,00	32	99,2	65,2	1,15	60,00	E	TCF100408EP	TCF120405EC
5537940	TCF330R2SLR40ME	33,00	34,00	40	103,2	67,2	1,18	70,00	E	TCF100408EP	TCF120405EC
5537941	TCF340R2SLR40ME	34,00	35,00	40	106,2	69,2	1,21	70,00	E	TCF100408EP	TCF120405EC
5537942	TCF350R2SLR40ME	35,00	36,00	40	109,2	71,2	1,24	70,00	E	TCF100408EP	TCF120405EC
5537943	TCF360R2SLR40ME	36,00	37,00	40	112,3	73,3	1,27	70,00	E	TCF100408EP	TCF120405EC
5578539	TCF370R2SLR40MF	37,00	38,00	40	115,3	75,3	1,35	70,00	F	TCF120412FP	TCF150406FC
5578600	TCF375R2SLR40MF	37,50	38,50	40	116,4	76,4	1,36	70,00	F	TCF120412FP	TCF150406FC
5578601	TCF380R2SLR40MF	38,00	39,00	40	118,4	77,4	1,38	70,00	F	TCF120412FP	TCF150406FC
5578602	TCF390R2SLR40MF	39,00	40,00	40	121,4	79,4	1,41	70,00	F	TCF120412FP	TCF150406FC
5578603	TCF400R2SLR40MF	40,00	41,00	40	123,4	81,4	1,45	70,00	F	TCF120412FP	TCF150406FC
5578604	TCF410R2SLR40MF	41,00	42,00	40	126,5	83,5	1,48	70,00	F	TCF120412FP	TCF150406FC
5578605	TCF420R2SLR40MF	42,00	43,00	40	129,5	85,5	1,51	70,00	F	TCF120412FP	TCF150406FC
5578606	TCF430R2SLR40MF	43,00	44,00	40	132,5	87,5	1,53	70,00	F	TCF120412FP	TCF150406FC
5578607	TCF440R2SLR40MF	44,00	45,00	40	135,6	89,6	1,56	70,00	F	TCF120412FP	TCF150406FC
5578608	TCF450R2SLR40MF	45,00	46,00	40	138,6	91,6	1,59	70,00	F	TCF120412FP	TCF150406FC
5578694	TCF460R2SLR40MG	46,00	47,00	40	136,7	93,7	1,67	70,00	G	TCF150512GP	TCF180508GC
5578695	TCF470R2SLR40MG	47,00	48,00	40	139,7	95,7	1,70	70,00	G	TCF150512GP	TCF180508GC
5578696	TCF480R2SLR40MG	48,00	49,00	40	142,7	97,7	1,73	70,00	G	TCF150512GP	TCF180508GC
5578697	TCF490R2SLR40MG	49,00	50,00	40	145,8	99,8	1,76	70,00	G	TCF150512GP	TCF180508GC
5578698	TCF500R2SLR40MG	50,00	51,00	40	147,8	101,8	1,79	70,00	G	TCF150512GP	TCF180508GC
5578699	TCF505R2SLR40MG	50,50	51,50	40	149,8	102,8	1,80	70,00	G	TCF150512GP	TCF180508GC
5578710	TCF510R2SLR40MG	51,00	52,00	40	150,8	103,8	1,81	70,00	G	TCF150512GP	TCF180508GC
5578711	TCF520R2SLR40MG	52,00	53,00	40	153,8	105,8	1,84	70,00	G	TCF150512GP	TCF180508GC
5578712	TCF530R2SLR40MG	53,00	54,00	40	156,9	107,9	1,87	70,00	G	TCF150512GP	TCF180508GC
5578713	TCF540R2SLR40MG	54,00	55,00	40	159,9	109,9	1,89	70,00	G	TCF150512GP	TCF180508GC
5578714	TCF550R2SLR40MG	55,00	56,00	40	161,9	111,9	1,92	70,00	G	TCF150512GP	TCF180508GC
5578715	TCF560R2SLR40MG	56,00	57,00	40	164,9	113,9	1,94	70,00	G	TCF150512GP	TCF180508GC
5538613	TCF570R2SLR40MH	57,00	58,00	40	162,1	116,1	2,06	70,00	H	TCF180614HP	TCF210608HC
5538614	TCF580R2SLR40MH	58,00	59,00	40	165,1	118,1	2,09	70,00	H	TCF180614HP	TCF210608HC
5538615	TCF590R2SLR40MH	59,00	60,00	40	168,1	120,1	2,12	70,00	H	TCF180614HP	TCF210608HC
5538616	TCF600R2SLR40MH	60,00	61,00	40	170,1	122,1	2,15	70,00	H	TCF180614HP	TCF210608HC
5538617	TCF610R2SLR40MH	61,00	62,00	40	173,2	124,2	2,18	70,00	H	TCF180614HP	TCF210608HC



## Top Cut 4 • 2 x D • SLR Shanks • Metric

(continued)

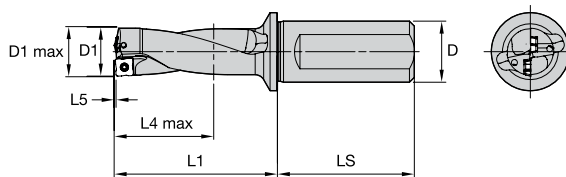

order number	catalog number	D1	D1 max	D	L1	L4 max	L5	LS	SSC	periphery insert	center insert
5538618	TCF620R2SLR40MH	62,00	63,00	40	176,2	126,2	2,20	70,00	H	TCF180614HP	TCF210608HC
5538619	TCF630R2SLR40MH	63,00	64,00	40	179,2	128,2	2,23	70,00	H	TCF180614HP	TCF210608HC
5538630	TCF640R2SLR40MH	64,00	65,00	40	181,3	130,3	2,26	70,00	H	TCF180614HP	TCF210608HC
5538631	TCF650R2SLR40MH	65,00	66,00	40	184,3	132,3	2,28	70,00	H	TCF180614HP	TCF210608HC
5538632	TCF660R2SLR40MH	66,00	67,00	40	187,3	134,3	2,31	70,00	H	TCF180614HP	TCF210608HC
5538633	TCF670R2SLR40MH	67,00	68,00	40	189,3	136,3	2,33	70,00	H	TCF180614HP	TCF210608HC
5538634	TCF680R2SLR40MH	68,00	69,00	40	192,4	138,4	2,36	70,00	H	TCF180614HP	TCF210608HC

D	LS	
	mm	in
.75	50	1,9685
1.00	56	2,2047
1.25	60	2,3622
1.50	70	2,7559

NOTE: SSC = Pocket Seat Reference. To correspond with the SSC on the inserts.

NOTE: Drilling in stacked plates possible in certain applications. Ask for technical support.

Drill shipped with insert screws and Torx wrench.

See pages C103-C112 for inserts.

SSC = Pocket Seat Reference.

SLR = Slide Lock.

D1 max is an achievable diameter using x-offset.

### WARNING

During through-hole operations, a slug or disc is produced as the tool breaks through the workpiece. When the drill is stationary and the workpiece is rotating, this slug may be hurled from the chuck by centrifugal force. Provide adequate shielding to protect bystanders.

Top Cut 4 • 3 x D • SLR Shanks • Metric

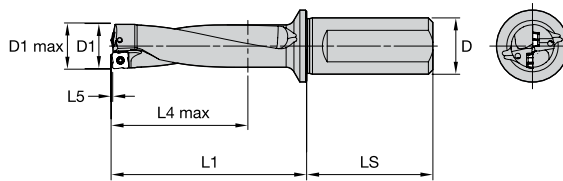

order number	catalog number	D1	D1 max	D	L1	L4 max	L5	LS	SSC	periphery insert	center insert
5537863	TCF120R3SLR20MA	12,00	12,50	20	55,4	36,4	0,43	50,00	A	TCF040204AP	TCF040203AC
5537864	TCF125R3SLR20MA	12,50	13,00	20	57,0	38,0	0,45	50,00	A	TCF040204AP	TCF040203AC
5537866	TCF127R3SLR20MA	12,70	13,20	20	58,6	38,6	0,46	50,00	A	TCF040204AP	TCF040203AC
5537867	TCF130R3SLR20MA	13,00	13,50	20	59,5	39,5	0,47	50,00	A	TCF040204AP	TCF040203AC
5537868	TCF135R3SLR20MA	13,50	14,00	20	61,0	41,0	0,48	50,00	A	TCF040204AP	TCF040203AC
5577928	TCF140R3SLR25MB	14,00	14,50	25	62,5	42,5	0,49	56,00	B	TCF050204BP	TCF060203BC
5577929	TCF145R3SLR25MB	14,50	15,00	25	64,0	44,0	0,52	56,00	B	TCF050204BP	TCF060203BC
5577930	TCF150R3SLR25MB	15,00	15,50	25	66,5	45,5	0,55	56,00	B	TCF050204BP	TCF060203BC
5577931	TCF155R3SLR25MB	15,50	16,00	25	69,1	47,1	0,56	56,00	B	TCF050204BP	TCF060203BC
5577932	TCF160R3SLR25MB	16,00	16,50	25	70,6	48,6	0,58	56,00	B	TCF050204BP	TCF060203BC
5577933	TCF165R3SLR25MB	16,50	17,00	25	73,1	50,1	0,60	56,00	B	TCF050204BP	TCF060203BC
5577934	TCF170R3SLR25MB	17,00	17,50	25	74,6	51,6	0,61	56,00	B	TCF050204BP	TCF060203BC
5577935	TCF175R3SLR25MB	17,50	18,00	25	77,1	53,1	0,63	56,00	B	TCF050204BP	TCF060203BC
5577936	TCF180R3SLR25MB	18,00	18,50	25	78,6	54,6	0,64	56,00	B	TCF050204BP	TCF060203BC
5577937	TCF185R3SLR25MB	18,50	19,00	25	81,2	56,2	0,65	56,00	B	TCF050204BP	TCF060203BC
5578828	TCF190R3SLR25MC	19,00	19,50	25	82,7	57,7	0,68	56,00	C	TCF070306CP	TCF070304CC
5578829	TCF195R3SLR25MC	19,50	20,00	25	85,2	59,2	0,71	56,00	C	TCF070306CP	TCF070304CC
5578830	TCF200R3SLR25MC	20,00	20,50	25	86,7	60,7	0,72	56,00	C	TCF070306CP	TCF070304CC
5578831	TCF205R3SLR25MC	20,50	21,00	25	89,2	62,2	0,74	56,00	C	TCF070306CP	TCF070304CC
5578832	TCF210R3SLR25MC	21,00	21,50	25	91,8	63,8	0,75	56,00	C	TCF070306CP	TCF070304CC
5578833	TCF220R3SLR25MC	22,00	22,50	25	95,8	66,8	0,78	56,00	C	TCF070306CP	TCF070304CC
5578834	TCF225R3SLR25MC	22,50	23,00	25	97,3	68,3	0,79	56,00	C	TCF070306CP	TCF070304CC
5578835	TCF230R3SLR25MC	23,00	23,50	25	99,8	69,8	0,80	56,00	C	TCF070306CP	TCF070304CC
5537824	TCF240R3SLR25MD	24,00	25,00	25	100,9	72,9	0,87	56,00	D	TCF080308DP	TCF090305DC
5537825	TCF250R3SLR32MD	25,00	26,00	32	105,9	75,9	0,91	60,00	D	TCF080308DP	TCF090305DC
5537826	TCF260R3SLR32MD	26,00	27,00	32	109,9	78,9	0,94	60,00	D	TCF080308DP	TCF090305DC
5537827	TCF265R3SLR32MD	26,50	27,50	32	112,5	80,5	0,95	60,00	D	TCF080308DP	TCF090305DC
5537828	TCF270R3SLR32MD	27,00	28,00	32	114,0	82,0	0,97	60,00	D	TCF080308DP	TCF090305DC
5537829	TCF280R3SLR32MD	28,00	29,00	32	118,0	85,0	0,99	60,00	D	TCF080308DP	TCF090305DC
5537830	TCF290R3SLR32MD	29,00	30,00	32	122,0	88,0	1,02	60,00	D	TCF080308DP	TCF090305DC
5537944	TCF300R3SLR32ME	30,00	31,00	32	123,1	91,1	1,09	60,00	E	TCF100408EP	TCF120405EC
5537945	TCF310R3SLR32ME	31,00	32,00	32	127,1	94,1	1,12	60,00	E	TCF100408EP	TCF120405EC
5537946	TCF320R3SLR32ME	32,00	33,00	32	131,2	97,2	1,15	60,00	E	TCF100408EP	TCF120405EC
5537947	TCF330R3SLR40ME	33,00	34,00	40	136,2	100,2	1,18	70,00	E	TCF100408EP	TCF120405EC
5537948	TCF340R3SLR40ME	34,00	35,00	40	140,2	103,2	1,21	70,00	E	TCF100408EP	TCF120405EC
5537949	TCF350R3SLR40ME	35,00	36,00	40	144,2	106,2	1,24	70,00	E	TCF100408EP	TCF120405EC
5537950	TCF360R3SLR40ME	36,00	37,00	40	148,3	109,3	1,27	70,00	E	TCF100408EP	TCF120405EC
5578609	TCF370R3SLR40MF	37,00	38,00	40	152,3	112,3	1,35	70,00	F	TCF120412FP	TCF150406FC
5578610	TCF375R3SLR40MF	37,50	38,50	40	153,9	113,9	1,36	70,00	F	TCF120412FP	TCF150406FC
5578611	TCF380R3SLR40MF	38,00	39,00	40	156,4	115,4	1,38	70,00	F	TCF120412FP	TCF150406FC
5578612	TCF390R3SLR40MF	39,00	40,00	40	160,4	118,4	1,41	70,00	F	TCF120412FP	TCF150406FC
5578613	TCF400R3SLR40MF	40,00	41,00	40	163,4	121,4	1,45	70,00	F	TCF120412FP	TCF150406FC
5578614	TCF410R3SLR40MF	41,00	42,00	40	167,5	124,5	1,48	70,00	F	TCF120412FP	TCF150406FC
5578615	TCF420R3SLR40MF	42,00	43,00	40	171,5	127,5	1,51	70,00	F	TCF120412FP	TCF150406FC
5578616	TCF430R3SLR40MF	43,00	44,00	40	175,5	130,5	1,53	70,00	F	TCF120412FP	TCF150406FC
5578617	TCF440R3SLR40MF	44,00	45,00	40	179,6	133,6	1,56	70,00	F	TCF120412FP	TCF150406FC
5578618	TCF450R3SLR40MF	45,00	46,00	40	183,6	136,6	1,59	70,00	F	TCF120412FP	TCF150406FC
5578716	TCF460R3SLR40MG	46,00	47,00	40	182,7	139,7	1,67	70,00	G	TCF150512GP	TCF180508GC
5578717	TCF470R3SLR40MG	47,00	48,00	40	186,7	142,7	1,70	70,00	G	TCF150512GP	TCF180508GC
5578718	TCF480R3SLR40MG	48,00	49,00	40	190,7	145,7	1,73	70,00	G	TCF150512GP	TCF180508GC
5578719	TCF490R3SLR40MG	49,00	50,00	40	194,8	148,8	1,76	70,00	G	TCF150512GP	TCF180508GC
5578720	TCF500R3SLR40MG	50,00	51,00	40	197,8	151,8	1,79	70,00	G	TCF150512GP	TCF180508GC
5578721	TCF505R3SLR40MG	50,50	51,50	40	200,3	153,3	1,80	70,00	G	TCF150512GP	TCF180508GC
5578722	TCF510R3SLR40MG	51,00	52,00	40	201,8	154,8	1,81	70,00	G	TCF150512GP	TCF180508GC
5578723	TCF520R3SLR40MG	52,00	53,00	40	205,8	157,8	1,84	70,00	G	TCF150512GP	TCF180508GC
5578724	TCF530R3SLR40MG	53,00	54,00	40	209,9	160,9	1,87	70,00	G	TCF150512GP	TCF180508GC
5578726	TCF540R3SLR40MG	54,00	55,00	40	213,9	163,9	1,89	70,00	G	TCF150512GP	TCF180508GC
5578727	TCF550R3SLR40MG	55,00	56,00	40	216,9	166,9	1,92	70,00	G	TCF150512GP	TCF180508GC
5578728	TCF560R3SLR40MG	56,00	57,00	40	220,9	169,9	1,94	70,00	G	TCF150512GP	TCF180508GC
5538635	TCF570R3SLR40MH	57,00	58,00	40	219,1	173,1	2,06	70,00	H	TCF180614HP	TCF210608HC
5538636	TCF580R3SLR40MH	58,00	59,00	40	223,1	176,1	2,09	70,00	H	TCF180614HP	TCF210608HC
5538637	TCF590R3SLR40MH	59,00	60,00	40	227,1	179,1	2,12	70,00	H	TCF180614HP	TCF210608HC
5538638	TCF600R3SLR40MH	60,00	61,00	40	230,1	182,1	2,15	70,00	H	TCF180614HP	TCF210608HC
5538639	TCF610R3SLR40MH	61,00	62,00	40	234,2	185,2	2,18	70,00	H	TCF180614HP	TCF210608HC

INDEXABLE MILLING

SOLID END MILLING

HOLEMAKING

TAPPING

TURNING

## Top Cut 4 • 3 x D • SLR Shanks • Metric

(continued)

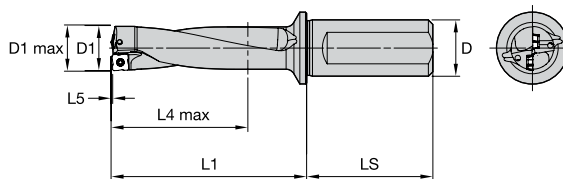

order number	catalog number	D1	D1 max	D	L1	L4 max	L5	LS	SSC	periphery insert	center insert
5538640	TCF620R3SLR40MH	62,00	63,00	40	238,2	188,2	2,20	70,00	H	TCF180614HP	TCF210608HC
5538641	TCF630R3SLR40MH	63,00	64,00	40	242,2	191,2	2,23	70,00	H	TCF180614HP	TCF210608HC
5538642	TCF640R3SLR40MH	64,00	65,00	40	245,3	194,3	2,26	70,00	H	TCF180614HP	TCF210608HC
5538643	TCF650R3SLR40MH	65,00	66,00	40	249,3	197,3	2,28	70,00	H	TCF180614HP	TCF210608HC
5538644	TCF660R3SLR40MH	66,00	67,00	40	253,3	200,3	2,31	70,00	H	TCF180614HP	TCF210608HC
5538645	TCF670R3SLR40MH	67,00	68,00	40	256,3	203,3	2,33	70,00	H	TCF180614HP	TCF210608HC
5538646	TCF680R3SLR40MH	68,00	69,00	40	260,4	206,4	2,36	70,00	H	TCF180614HP	TCF210608HC

D	LS	
	mm	in
.75	50	1.9685
1.00	56	2.2047
1.25	60	2.3622
1.50	70	2.7559

NOTE: SSC = Pocket Seat Reference. To correspond with the SSC on the inserts.

NOTE: Drilling in stacked plates possible in certain applications. Ask for technical support.

Drill shipped with insert screws and Torx wrench.

See pages C103-C112 for inserts.

SSC = Pocket Seat Reference.

SLR = Slide Lock.

D1 max is an achievable diameter using x-offset.

### WARNING

During through-hole operations, a slug or disc is produced as the tool breaks through the workpiece. When the drill is stationary and the workpiece is rotating, this slug may be hurled from the chuck by centrifugal force. Provide adequate shielding to protect bystanders.

Top Cut 4 • 4 x D • SLR Shanks • Metric

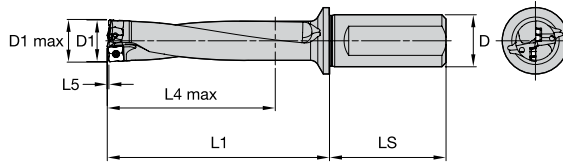

order number	catalog number	D1	D1 max	D	L1	L4 max	L5	LS	SSC	periphery insert	center insert
5537869	TCF120R4SLR20MA	12,00	12,50	20	67,4	48,4	0,43	50,00	A	TCF040204AP	TCF040203AC
5537870	TCF125R4SLR20MA	12,50	13,00	20	69,5	50,5	0,45	50,00	A	TCF040204AP	TCF040203AC
5537871	TCF127R4SLR20MA	12,70	13,20	20	71,3	51,3	0,46	50,00	A	TCF040204AP	TCF040203AC
5537872	TCF130R4SLR20MA	13,00	13,50	20	72,5	52,5	0,47	50,00	A	TCF040204AP	TCF040203AC
5537873	TCF135R4SLR20MA	13,50	14,00	20	75,5	54,5	0,48	50,00	A	TCF040204AP	TCF040203AC
5577938	TCF140R4SLR25MB	14,00	14,50	25	76,5	56,5	0,49	56,00	B	TCF050204BP	TCF060203BC
5577939	TCF145R4SLR25MB	14,50	15,00	25	78,5	58,5	0,52	56,00	B	TCF050204BP	TCF060203BC
5577940	TCF150R4SLR25MB	15,00	15,50	25	81,5	60,5	0,55	56,00	B	TCF050204BP	TCF060203BC
5577941	TCF155R4SLR25MB	15,50	16,00	25	84,6	62,6	0,56	56,00	B	TCF050204BP	TCF060203BC
5577942	TCF160R4SLR25MB	16,00	16,50	25	86,6	64,6	0,58	56,00	B	TCF050204BP	TCF060203BC
5577943	TCF165R4SLR25MB	16,50	17,00	25	89,6	66,6	0,60	56,00	B	TCF050204BP	TCF060203BC
5577944	TCF170R4SLR25MB	17,00	17,50	25	91,6	68,6	0,61	56,00	B	TCF050204BP	TCF060203BC
5577945	TCF175R4SLR25MB	17,50	18,00	25	94,6	70,6	0,63	56,00	B	TCF050204BP	TCF060203BC
5577946	TCF180R4SLR25MB	18,00	18,50	25	96,6	72,6	0,64	56,00	B	TCF050204BP	TCF060203BC
5577947	TCF185R4SLR25MB	18,50	19,00	25	99,7	74,7	0,65	56,00	B	TCF050204BP	TCF060203BC
5578836	TCF190R4SLR25MC	19,00	19,50	25	101,7	76,7	0,68	56,00	C	TCF070306CP	TCF070304CC
5578837	TCF195R4SLR25MC	19,50	20,00	25	104,7	78,7	0,71	56,00	C	TCF070306CP	TCF070304CC
5578838	TCF200R4SLR25MC	20,00	20,50	25	106,7	80,7	0,72	56,00	C	TCF070306CP	TCF070304CC
5578839	TCF205R4SLR25MC	20,50	21,00	25	109,7	82,7	0,74	56,00	C	TCF070306CP	TCF070304CC
5578840	TCF210R4SLR25MC	21,00	21,50	25	112,8	84,8	0,75	56,00	C	TCF070306CP	TCF070304CC
5578841	TCF220R4SLR25MC	22,00	22,50	25	117,8	88,8	0,78	56,00	C	TCF070306CP	TCF070304CC
5578842	TCF225R4SLR25MC	22,50	23,00	25	119,8	90,8	0,79	56,00	C	TCF070306CP	TCF070304CC
5578843	TCF230R4SLR25MC	23,00	23,50	25	122,8	92,8	0,80	56,00	C	TCF070306CP	TCF070304CC
5537831	TCF240R4SLR25MD	24,00	25,00	25	124,9	96,9	0,87	56,00	D	TCF080308DP	TCF090305DC
5537832	TCF250R4SLR32MD	25,00	26,00	32	130,9	100,9	0,91	60,00	D	TCF080308DP	TCF090305DC
5537833	TCF260R4SLR32MD	26,00	27,00	32	135,9	104,9	0,94	60,00	D	TCF080308DP	TCF090305DC
5537834	TCF265R4SLR32MD	26,50	27,50	32	139,0	107,0	0,95	60,00	D	TCF080308DP	TCF090305DC
5537835	TCF270R4SLR32MD	27,00	28,00	32	141,0	109,0	0,97	60,00	D	TCF080308DP	TCF090305DC
5537836	TCF280R4SLR32MD	28,00	29,00	32	146,0	113,0	0,99	60,00	D	TCF080308DP	TCF090305DC
5537837	TCF290R4SLR32MD	29,00	30,00	32	151,0	117,0	1,02	60,00	D	TCF080308DP	TCF090305DC
5537951	TCF300R4SLR32ME	30,00	31,00	32	153,1	121,1	1,09	60,00	E	TCF100408EP	TCF120405EC
5537952	TCF310R4SLR32ME	31,00	32,00	32	158,1	125,1	1,12	60,00	E	TCF100408EP	TCF120405EC
5537953	TCF320R4SLR32ME	32,00	33,00	32	163,2	129,2	1,15	60,00	E	TCF100408EP	TCF120405EC
5537954	TCF330R4SLR40ME	33,00	34,00	40	165,2	133,2	1,18	70,00	E	TCF100408EP	TCF120405EC
5537955	TCF340R4SLR40ME	34,00	35,00	40	174,2	137,2	1,21	70,00	E	TCF100408EP	TCF120405EC
5537956	TCF350R4SLR40ME	35,00	36,00	40	179,2	141,2	1,24	70,00	E	TCF100408EP	TCF120405EC
5537957	TCF360R4SLR40ME	36,00	37,00	40	184,3	145,3	1,27	70,00	E	TCF100408EP	TCF120405EC
5578619	TCF370R4SLR40MF	37,00	38,00	40	189,3	149,3	1,35	70,00	F	TCF120412FP	TCF150406FC
5578620	TCF375R4SLR40MF	37,50	38,50	40	191,4	151,4	1,36	70,00	F	TCF120412FP	TCF150406FC
5578621	TCF380R4SLR40MF	38,00	39,00	40	194,4	153,4	1,38	70,00	F	TCF120412FP	TCF150406FC
5578622	TCF390R4SLR40MF	39,00	40,00	40	199,4	157,4	1,41	70,00	F	TCF120412FP	TCF150406FC
5578623	TCF400R4SLR40MF	40,00	41,00	40	203,4	161,4	1,45	70,00	F	TCF120412FP	TCF150406FC
5578624	TCF410R4SLR40MF	41,00	42,00	40	208,5	165,5	1,48	70,00	F	TCF120412FP	TCF150406FC
5578625	TCF420R4SLR40MF	42,00	43,00	40	213,5	169,5	1,51	70,00	F	TCF120412FP	TCF150406FC
5578626	TCF430R4SLR40MF	43,00	44,00	40	218,5	173,5	1,53	70,00	F	TCF120412FP	TCF150406FC
5578627	TCF440R4SLR40MF	44,00	45,00	40	223,6	177,6	1,56	70,00	F	TCF120412FP	TCF150406FC
5578628	TCF450R4SLR40MF	45,00	46,00	40	228,6	181,6	1,59	70,00	F	TCF120412FP	TCF150406FC
5578729	TCF460R4SLR40MG	46,00	47,00	40	228,7	185,7	1,67	70,00	G	TCF150512GP	TCF180508GC
5578730	TCF470R4SLR40MG	47,00	48,00	40	233,7	189,7	1,70	70,00	G	TCF150512GP	TCF180508GC
5578731	TCF480R4SLR40MG	48,00	49,00	40	238,7	193,7	1,73	70,00	G	TCF150512GP	TCF180508GC
5578732	TCF490R4SLR40MG	49,00	50,00	40	243,8	197,8	1,76	70,00	G	TCF150512GP	TCF180508GC
5578733	TCF500R4SLR40MG	50,00	51,00	40	247,8	201,8	1,79	70,00	G	TCF150512GP	TCF180508GC
5578734	TCF505R4SLR40MG	50,50	51,50	40	250,8	203,8	1,80	70,00	G	TCF150512GP	TCF180508GC
5578735	TCF510R4SLR40MG	51,00	52,00	40	252,8	205,8	1,81	70,00	G	TCF150512GP	TCF180508GC
5578736	TCF520R4SLR40MG	52,00	53,00	40	257,8	209,8	1,84	70,00	G	TCF150512GP	TCF180508GC
5578737	TCF530R4SLR40MG	53,00	54,00	40	262,9	213,9	1,87	70,00	G	TCF150512GP	TCF180508GC
5578738	TCF540R4SLR40MG	54,00	55,00	40	267,9	217,9	1,89	70,00	G	TCF150512GP	TCF180508GC
5578739	TCF550R4SLR40MG	55,00	56,00	40	271,9	221,9	1,92	70,00	G	TCF150512GP	TCF180508GC
5578750	TCF560R4SLR40MG	56,00	57,00	40	276,9	225,9	1,94	70,00	G	TCF150512GP	TCF180508GC
5538647	TCF570R4SLR40MH	57,00	58,00	40	276,1	230,1	2,06	70,00	H	TCF180614HP	TCF210608HC
5538648	TCF580R4SLR40MH	58,00	59,00	40	281,1	234,1	2,09	70,00	H	TCF180614HP	TCF210608HC
5538649	TCF590R4SLR40MH	59,00	60,00	40	286,1	238,1	2,12	70,00	H	TCF180614HP	TCF210608HC
5538650	TCF600R4SLR40MH	60,00	61,00	40	290,1	242,1	2,15	70,00	H	TCF180614HP	TCF210608HC
5538651	TCF610R4SLR40MH	61,00	62,00	40	295,2	246,2	2,18	70,00	H	TCF180614HP	TCF210608HC

INDEXABLE MILLING

SOLID END MILLING

HOLEMAKING

TAPPING

TURNING

## Top Cut 4 • 4 x D • SLR Shanks • Metric

(continued)

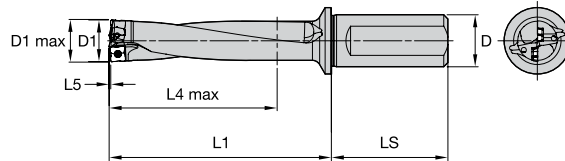

order number	catalog number	D1	D1 max	D	L1	L4 max	L5	LS	SSC	periphery insert	center insert
5538652	TCF620R4SLR40MH	62,00	63,00	40	300,2	250,2	2,20	70,00	H	TCF180614HP	TCF210608HC
5538653	TCF630R4SLR40MH	63,00	64,00	40	305,2	254,2	2,23	70,00	H	TCF180614HP	TCF210608HC
5538654	TCF640R4SLR40MH	64,00	65,00	40	309,3	258,3	2,26	70,00	H	TCF180614HP	TCF210608HC
5538655	TCF650R4SLR40MH	65,00	66,00	40	314,3	262,3	2,28	70,00	H	TCF180614HP	TCF210608HC
5538656	TCF660R4SLR40MH	66,00	67,00	40	319,3	266,3	2,31	70,00	H	TCF180614HP	TCF210608HC
5538657	TCF670R4SLR40MH	67,00	68,00	40	323,3	270,3	2,33	70,00	H	TCF180614HP	TCF210608HC
5538658	TCF680R4SLR40MH	68,00	69,00	40	328,4	274,4	2,36	70,00	H	TCF180614HP	TCF210608HC

D	LS	
	mm	in
.75	50	1,9685
1.00	56	2,2047
1.25	60	2,3622
1.50	70	2,7559

NOTE: SSC = Pocket Seat Reference. To correspond with the SSC on the inserts.

NOTE: Drilling in stacked plates possible in certain applications. Ask for technical support.

Drill shipped with insert screws and Torx wrench.

See pages C103-C112 for inserts.

SSC = Pocket Seat Reference.

SLR = Slide Lock.

D1 max is an achievable diameter using x-offset.

### WARNING

During through-hole operations, a slug or disc is produced as the tool breaks through the workpiece. When the drill is stationary and the workpiece is rotating, this slug may be hurled from the chuck by centrifugal force. Provide adequate shielding to protect bystanders.

Top Cut 4 • 5 x D • SLR Shank • Metric

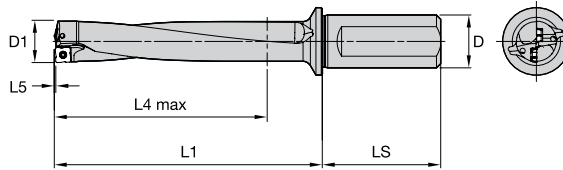

order number	catalog number	D1	D	L1	L4 max	L5	LS	SSC	periphery insert	center insert
5537874	TCF120R5SLR20MA	12,00	20	79,4	60,4	0,43	50,00	A	TCF040204AP	TCF040203AC
5537875	TCF125R5SLR20MA	12,50	20	82,0	63,0	0,45	50,00	A	TCF040204AP	TCF040203AC
5537876	TCF127R5SLR20MA	12,70	20	84,0	64,0	0,46	50,00	A	TCF040204AP	TCF040203AC
5537877	TCF130R5SLR20MA	13,00	20	85,5	65,5	0,47	50,00	A	TCF040204AP	TCF040203AC
5537878	TCF135R5SLR20MA	13,50	20	89,0	68,0	0,48	50,00	A	TCF040204AP	TCF040203AC
5577948	TCF140R5SLR25MB	14,00	25	90,5	70,5	0,49	56,00	B	TCF050204BP	TCF060203BC
5577949	TCF145R5SLR25MB	14,50	25	93,0	73,0	0,52	56,00	B	TCF050204BP	TCF060203BC
5577950	TCF150R5SLR25MB	15,00	25	96,5	75,5	0,55	56,00	B	TCF050204BP	TCF060203BC
5577951	TCF155R5SLR25MB	15,50	25	100,1	78,1	0,56	56,00	B	TCF050204BP	TCF060203BC
5577952	TCF160R5SLR25MB	16,00	25	102,6	80,6	0,58	56,00	B	TCF050204BP	TCF060203BC
5577953	TCF165R5SLR25MB	16,50	25	106,1	83,1	0,60	56,00	B	TCF050204BP	TCF060203BC
5577954	TCF170R5SLR25MB	17,00	25	108,6	85,6	0,61	56,00	B	TCF050204BP	TCF060203BC
5577955	TCF175R5SLR25MB	17,50	25	112,1	88,1	0,63	56,00	B	TCF050204BP	TCF060203BC
5577956	TCF180R5SLR25MB	18,00	25	114,6	90,6	0,64	56,00	B	TCF050204BP	TCF060203BC
5577957	TCF185R5SLR25MB	18,50	25	118,2	93,2	0,65	56,00	B	TCF050204BP	TCF060203BC
5578844	TCF190R5SLR25MC	19,00	25	120,7	95,7	0,68	56,00	C	TCF070306CP	TCF070304CC
5578845	TCF195R5SLR25MC	19,50	25	124,2	98,2	0,71	56,00	C	TCF070306CP	TCF070304CC
5578846	TCF200R5SLR25MC	20,00	25	126,7	100,7	0,72	56,00	C	TCF070306CP	TCF070304CC
5578847	TCF205R5SLR25MC	20,50	25	130,2	103,2	0,74	56,00	C	TCF070306CP	TCF070304CC
5578848	TCF210R5SLR25MC	21,00	25	133,8	105,8	0,75	56,00	C	TCF070306CP	TCF070304CC
5578849	TCF220R5SLR25MC	22,00	25	139,8	110,8	0,78	56,00	C	TCF070306CP	TCF070304CC
5578850	TCF225R5SLR25MC	22,50	25	142,3	113,3	0,79	56,00	C	TCF070306CP	TCF070304CC
5578851	TCF230R5SLR25MC	23,00	25	145,8	115,8	0,80	56,00	C	TCF070306CP	TCF070304CC
5537838	TCF240R5SLR25MD	24,00	25	148,9	120,9	0,87	56,00	D	TCF080308DP	TCF090305DC
5537839	TCF250R5SLR32MD	25,00	32	155,9	125,9	0,91	60,00	D	TCF080308DP	TCF090305DC
5537840	TCF260R5SLR32MD	26,00	32	161,9	130,9	0,94	60,00	D	TCF080308DP	TCF090305DC
5537841	TCF265R5SLR32MD	26,50	32	165,5	133,5	0,95	60,00	D	TCF080308DP	TCF090305DC
5537842	TCF270R5SLR32MD	27,00	32	168,0	136,0	0,97	60,00	D	TCF080308DP	TCF090305DC
5537843	TCF280R5SLR32MD	28,00	32	174,0	141,0	0,99	60,00	D	TCF080308DP	TCF090305DC
5537844	TCF290R5SLR32MD	29,00	32	180,0	146,0	1,02	60,00	D	TCF080308DP	TCF090305DC
5537958	TCF300R5SLR32ME	30,00	32	183,1	151,1	1,09	60,00	E	TCF100408EP	TCF120405EC
5537959	TCF310R5SLR32ME	31,00	32	189,1	156,1	1,12	60,00	E	TCF100408EP	TCF120405EC
5537960	TCF320R5SLR32ME	32,00	32	195,2	161,2	1,15	60,00	E	TCF100408EP	TCF120405EC
5537961	TCF330R5SLR40ME	33,00	40	202,2	166,2	1,18	70,00	E	TCF100408EP	TCF120405EC
5537962	TCF340R5SLR40ME	34,00	40	208,2	171,2	1,21	70,00	E	TCF100408EP	TCF120405EC
5537963	TCF350R5SLR40ME	35,00	40	214,2	176,2	1,24	70,00	E	TCF100408EP	TCF120405EC
5537964	TCF360R5SLR40ME	36,00	40	220,3	181,3	1,27	70,00	E	TCF100408EP	TCF120405EC
5578629	TCF370R5SLR40MF	37,00	40	226,3	186,3	1,35	70,00	F	TCF120412FP	TCF150406FC
5578640	TCF375R5SLR40MF	37,50	40	228,9	188,9	1,36	70,00	F	TCF120412FP	TCF150406FC
5578641	TCF380R5SLR40MF	38,00	40	232,4	191,4	1,38	70,00	F	TCF120412FP	TCF150406FC
5578642	TCF390R5SLR40MF	39,00	40	238,4	196,4	1,41	70,00	F	TCF120412FP	TCF150406FC
5578643	TCF400R5SLR40MF	40,00	40	243,4	201,4	1,45	70,00	F	TCF120412FP	TCF150406FC
5578644	TCF410R5SLR40MF	41,00	40	249,5	206,5	1,48	70,00	F	TCF120412FP	TCF150406FC
5578645	TCF420R5SLR40MF	42,00	40	255,5	211,5	1,51	70,00	F	TCF120412FP	TCF150406FC
5578646	TCF430R5SLR40MF	43,00	40	261,5	216,5	1,53	70,00	F	TCF120412FP	TCF150406FC
5578647	TCF440R5SLR40MF	44,00	40	267,6	221,6	1,56	70,00	F	TCF120412FP	TCF150406FC
5578648	TCF450R5SLR40MF	45,00	40	273,6	226,6	1,59	70,00	F	TCF120412FP	TCF150406FC
5578751	TCF460R5SLR40MG	46,00	40	274,7	231,7	1,67	70,00	G	TCF150512GP	TCF180508GC
5578752	TCF470R5SLR40MG	47,00	40	280,7	236,7	1,70	70,00	G	TCF150512GP	TCF180508GC
5578753	TCF480R5SLR40MG	48,00	40	286,7	241,7	1,73	70,00	G	TCF150512GP	TCF180508GC
5578754	TCF490R5SLR40MG	49,00	40	292,8	246,8	1,76	70,00	G	TCF150512GP	TCF180508GC
5578755	TCF500R5SLR40MG	50,00	40	297,8	251,8	1,79	70,00	G	TCF150512GP	TCF180508GC
5578756	TCF505R5SLR40MG	50,50	40	301,3	254,3	1,80	70,00	G	TCF150512GP	TCF180508GC
5578757	TCF510R5SLR40MG	51,00	40	303,8	256,8	1,81	70,00	G	TCF150512GP	TCF180508GC
5578758	TCF520R5SLR40MG	52,00	40	309,8	261,8	1,84	70,00	G	TCF150512GP	TCF180508GC
5578759	TCF530R5SLR40MG	53,00	40	315,9	266,9	1,87	70,00	G	TCF150512GP	TCF180508GC
5578760	TCF540R5SLR40MG	54,00	40	321,9	271,9	1,89	70,00	G	TCF150512GP	TCF180508GC
5578761	TCF550R5SLR40MG	55,00	40	326,9	276,9	1,92	70,00	G	TCF150512GP	TCF180508GC
5578762	TCF560R5SLR40MG	56,00	40	332,9	281,9	1,94	70,00	G	TCF150512GP	TCF180508GC
5538659	TCF570R5SLR40MH	57,00	40	333,1	287,1	2,06	70,00	H	TCF180614HP	TCF210608HC
5538660	TCF580R5SLR40MH	58,00	40	339,1	292,1	2,09	70,00	H	TCF180614HP	TCF210608HC
5538661	TCF590R5SLR40MH	59,00	40	345,1	297,1	2,12	70,00	H	TCF180614HP	TCF210608HC
5538662	TCF600R5SLR40MH	60,00	40	350,1	302,1	2,15	70,00	H	TCF180614HP	TCF210608HC
5538663	TCF610R5SLR40MH	61,00	40	356,2	307,2	2,18	70,00	H	TCF180614HP	TCF210608HC

INDEXABLE MILLING

SOLID END MILLING

HOLEMAKING

TAPPING

TURNING



## Top Cut 4 • 5 x D • SLR Shank • Metric

(continued)

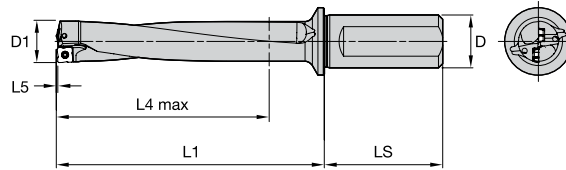

order number	catalog number	D1	D	L1	L4 max	L5	LS	SSC	periphery insert	center insert
5538684	TCF620R5SLR40MH	62,00	40	362,2	312,2	2,20	70,00	H	TCF180614HP	TCF210608HC
5538685	TCF630R5SLR40MH	63,00	40	368,2	317,2	2,23	70,00	H	TCF180614HP	TCF210608HC
5538686	TCF640R5SLR40MH	64,00	40	373,3	322,3	2,26	70,00	H	TCF180614HP	TCF210608HC
5538687	TCF650R5SLR40MH	65,00	40	379,3	327,3	2,28	70,00	H	TCF180614HP	TCF210608HC
5538688	TCF660R5SLR40MH	66,00	40	385,3	332,3	2,31	70,00	H	TCF180614HP	TCF210608HC
5538689	TCF670R5SLR40MH	67,00	40	390,3	337,3	2,33	70,00	H	TCF180614HP	TCF210608HC
5538700	TCF680R5SLR40MH	68,00	40	396,4	342,4	2,36	70,00	H	TCF180614HP	TCF210608HC

D	LS	
	mm	in
.75	50	1.9685
1.00	56	2.2047
1.25	60	2.3622
1.50	70	2.7559

NOTE: SSC = Pocket Seat Reference. To correspond with the SSC on the inserts.

NOTE: Drilling in stacked plates possible in certain applications. Ask for technical support.

Drill shipped with insert screws and Torx wrench.

See pages C103-C112 for inserts.

SSC = Pocket Seat Reference.

SLR = Side Lock.

D1 max is an achievable diameter using x-offset.

### WARNING

During through-hole operations, a slug or disc is produced as the tool breaks through the workpiece. When the drill is stationary and the workpiece is rotating, this slug may be hurled from the chuck by centrifugal force. Provide adequate shielding to protect bystanders.

## Top Cut 4 • Center Inserts • Roughing V34

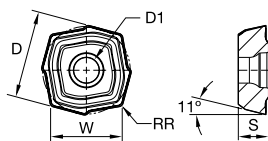

● first choice

○ alternate choice

P	<input checked="" type="checkbox"/>	<input type="checkbox"/>	<input type="checkbox"/>
M	<input type="checkbox"/>	<input type="checkbox"/>	<input type="checkbox"/>
K	<input type="checkbox"/>	<input type="checkbox"/>	<input type="checkbox"/>
N	<input type="checkbox"/>	<input type="checkbox"/>	<input type="checkbox"/>
S	<input type="checkbox"/>	<input type="checkbox"/>	<input type="checkbox"/>
H	<input type="checkbox"/>	<input type="checkbox"/>	<input type="checkbox"/>

catalog number	D		D1		W		S		RR		SSC	WU25CH	WU40PH
	mm	in	mm	in	mm	in	mm	in	mm	in			
TCF040203ACV34	4,47	.176	2,10	.083	3,65	.144	2,00	.079	0,300	.011	A	5541817	5541818
TCF060203BCV34	6,00	.236	2,40	.094	4,90	.193	2,40	.095	0,300	.011	B	5542602	5542604
TCF070304CCV34	7,59	.299	2,60	.102	6,20	.244	2,80	.110	0,400	.015	C	5542642	5542643
TCF090305DCV34	9,55	.376	2,80	.110	7,80	.307	3,00	.118	0,500	.019	D	5538554	5538555
TCF120405ECV34	12,00	.473	3,40	.134	9,80	.386	3,60	.142	0,500	.019	E	5538603	5538604
TCF150406FCV34	14,94	.588	4,80	.189	12,20	.480	4,20	.165	0,600	.023	F	5542623	5542624
TCF180508GCV34	17,88	.704	6,00	.236	14,60	.575	5,40	.213	0,800	.031	G	5542475	5542476
TCF210608HCV34	21,68	.853	7,50	.295	17,70	.697	6,50	.256	0,800	.031	H	5542002	5542003

NOTE: For application-specific insert selection, please refer to the application data on page C113.  
SSC = Pocket Seat Reference. To correspond with the SSC on the toolholder.

INDEXABLE MILLING

SOLID END MILLING

HOLEMAKING

TAPPING

TURNING



## Top Cut 4 • Periphery Inserts • Roughing V34

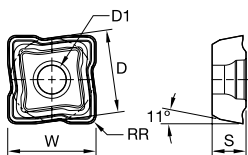

● first choice

○ alternate choice

P	<input checked="" type="checkbox"/>	<input type="checkbox"/>	<input type="checkbox"/>	<input type="checkbox"/>
M	<input type="checkbox"/>	<input type="checkbox"/>	<input type="checkbox"/>	<input type="checkbox"/>
K	<input type="checkbox"/>	<input type="checkbox"/>	<input checked="" type="checkbox"/>	<input type="checkbox"/>
N	<input type="checkbox"/>	<input type="checkbox"/>	<input type="checkbox"/>	<input type="checkbox"/>
S	<input type="checkbox"/>	<input type="checkbox"/>	<input type="checkbox"/>	<input type="checkbox"/>
H	<input type="checkbox"/>	<input type="checkbox"/>	<input type="checkbox"/>	<input type="checkbox"/>

catalog number	D		D1		W		S		RR		SSC	WPK10CH	WU25CH	WU40PH
	mm	in	mm	in	mm	in	mm	in	mm	in				
TCF040204APV34	4,14	.163	2,10	.083	4,40	.173	2,00	.079	0,400	.015	A	5541843	5541841	5541842
TCF050204BPV34	5,07	.200	2,40	.094	5,40	.213	2,40	.094	0,400	.015	B	5542620	5542608	5542609
TCF070306CPV34	6,67	.263	2,60	.102	7,10	.280	2,80	.110	0,600	.023	C	5542648	5542646	5542647
TCF080308DPV34	8,08	.318	2,80	.110	8,60	.339	3,00	.118	0,800	.031	D	5538600	5538558	5538559
TCF100408EPV34	9,96	.392	3,40	.134	10,60	.417	3,60	.142	0,800	.031	E	5538610	5538608	5538609
TCF120412FPV34	12,59	.496	4,80	.189	13,40	.528	4,20	.165	1,200	.046	F	5542629	5542627	5542628
TCF150512GPV34	15,13	.596	6,00	.236	16,10	.634	5,40	.213	1,200	.046	G	5542601	5542479	5542600
TCF180614HPV34	18,04	.710	7,50	.295	19,20	.756	6,50	.256	1,400	.054	H	5542008	5542006	5542007

NOTE: For application-specific insert selection, please refer to the application data on page C113.  
SSC = Pocket Seat Reference. To correspond with the SSC on the toolholder.

INDEXABLE MILLING

SOLID END MILLING

HOLEMAKING

TAPPING

TURNING

## Top Cut 4 • Center Inserts • Aluminum V36

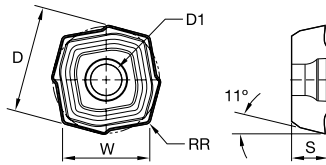

- first choice
- alternate choice

P	■
M	■
K	■
N	●
S	■
H	■

catalog number	D		D1		W		S		RR		SSC	WN10PH
	mm	in	mm	in	mm	in	mm	in	mm	in		
TCF040203ACV36	4,47	.176	2,10	.083	3,65	.144	2,00	.079	0,300	.011	A	6407887
TCF060203BCV36	6,00	.236	2,40	.094	4,90	.193	2,40	.095	0,300	.011	B	6372041
TCF070304CCV36	7,59	.299	2,60	.102	6,20	.244	2,80	.110	0,400	.015	C	6372042
TCF090305DCV36	9,55	.376	2,80	.110	7,80	.307	3,00	.118	0,500	.019	D	6372045
TCF120405ECV36	12,00	.473	3,40	.134	9,80	.386	3,60	.142	0,500	.019	E	6372047
TCF150406FCV36	14,94	.588	4,80	.189	12,20	.480	4,20	.165	0,600	.023	F	6346757
TCF180508GCV36	17,88	.704	6,00	.236	14,60	.575	5,40	.213	0,800	.031	G	6407890
TCF210608HCV36	21,68	.853	7,50	.295	17,70	.697	6,50	.256	0,800	.031	H	6372049

NOTE: SSC = Pocket Seat Reference. To correspond with the SSC on the toolholder.

INDEXABLE MILLING

SOLID END MILLING

HOLEMAKING

TAPPING

TURNING

## Top Cut 4 • Periphery Inserts • Aluminum V36

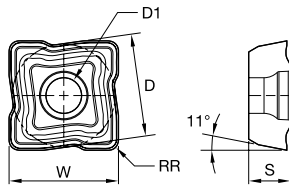

- first choice
- alternate choice

P	■
M	■
K	■
N	●
S	■
H	■

catalog number	D		D1		W		S		RR		SSC	WN10PH
	mm	in	mm	in	mm	in	mm	in	mm	in		
TCF040204APV36	4,14	.163	2,10	.083	4,40	.173	2,00	.079	0,400	.015	A	6407888
TCF050204BPV36	5,07	.200	2,40	.094	5,40	.213	2,40	.094	0,400	.015	B	6371850
TCF070306CPV36	6,67	.263	2,60	.102	7,10	.280	2,80	.110	0,600	.023	C	6372043
TCF080308DPV36	8,08	.318	2,80	.110	8,60	.339	3,00	.118	0,800	.031	D	6372044
TCF100408EPV36	9,96	.392	3,40	.134	10,60	.417	3,60	.142	0,800	.031	E	6372046
TCF120412FPV36	12,59	.496	4,80	.189	13,40	.528	4,20	.165	1,200	.046	F	6348893
TCF150512GPV36	15,13	.596	6,00	.236	16,10	.634	5,40	.213	1,200	.046	G	6407889
TCF180614HPV36	18,04	.710	7,50	.295	19,20	.756	6,50	.256	1,400	.054	H	6372048

NOTE: SSC = Pocket Seat Reference. To correspond with the SSC on the toolholder.

INDEXABLE MILLING

SOLID END MILLING

HOLEMAKING

TAPPING

TURNING

## Top Cut 4 • Center Inserts • Roughing V36

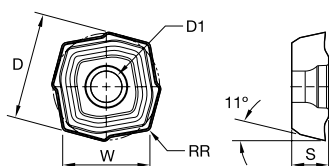

- first choice
- alternate choice

P	●	○
M	●	○
K	●	○
N	○	○
S	○	○
H	○	○

catalog number	D		D1		W		S		RR		SSC	WU25CH	WU40PH
	mm	in	mm	in	mm	in	mm	in	mm	in			
<b>TCF040203ACV36</b>	4,47	.176	2,10	.083	3,65	.144	2,00	.079	0,300	.011	A	5541819	5541840
<b>TCF060203BCV36</b>	6,00	.236	2,40	.094	4,90	.193	2,40	.095	0,300	.011	B	5542606	5542607
<b>TCF070304CCV36</b>	7,59	.299	2,60	.102	6,20	.244	2,80	.110	0,400	.015	C	5542644	5542645
<b>TCF090305DCV36</b>	9,55	.376	2,80	.110	7,80	.307	3,00	.118	0,500	.019	D	5538556	5538557
<b>TCF120405ECV36</b>	12,00	.473	3,40	.134	9,80	.386	3,60	.142	0,500	.019	E	5538606	5538607
<b>TCF150406FCV36</b>	14,94	.588	4,80	.189	12,20	.480	4,20	.165	0,600	.023	F	5542625	5542626
<b>TCF180508GCV36</b>	17,88	.704	6,00	.236	14,60	.575	5,40	.213	0,800	.031	G	5542477	5542478
<b>TCF210608HCV36</b>	21,68	.853	7,50	.295	17,70	.697	6,50	.256	0,800	.031	H	5542004	5542005

NOTE: For application-specific insert selection, please refer to the application data on page C113.  
SSC = Pocket Seat Reference. To correspond with the SSC on the toolholder.

INDEXABLE MILLING

SOLID END MILLING

HOLEMAKING

TAPPING

TURNING

## Top Cut 4 • Periphery Inserts • Roughing V36

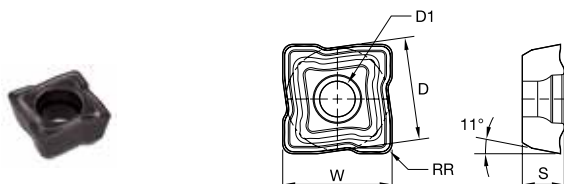

● first choice  
○ alternate choice

P	Blue	○	●
M	Yellow	○	●
K	Red	○	●
N	Green	○	●
S	Orange	○	●
H	Grey	○	●

catalog number	D		D1		W		S		RR		SSC	WU25CH	WU40PH
	mm	in	mm	in	mm	in	mm	in	mm	in			
TCF040204APV36	4,14	.163	2,10	.083	4,40	.173	2,00	.079	0,400	.015	A	5541844	5541845
TCF050204BPV36	5,07	.200	2,40	.094	5,40	.213	2,40	.094	0,400	.015	B	5542621	5542622
TCF070306CPV36	6,67	.263	2,60	.102	7,10	.280	2,80	.110	0,600	.023	C	5542649	5542650
TCF080308DPV36	8,08	.318	2,80	.110	8,60	.339	3,00	.118	0,800	.031	D	5538601	5538602
TCF100408EPV36	9,96	.392	3,40	.134	10,60	.417	3,60	.142	0,800	.031	E	5538611	5538612
TCF120412FPV36	12,59	.496	4,80	.189	13,40	.528	4,20	.165	1,200	.046	F	5542640	5542641
TCF150512GPV36	15,13	.596	6,00	.236	16,10	.634	5,40	.213	1,200	.046	G	5542603	5542605
TCF180614HPV36	18,04	.710	7,50	.295	19,20	.756	6,50	.256	1,400	.054	H	5542009	5542020

NOTE: For application-specific insert selection, please refer to the application data on page C113.  
SSC = Pocket Seat Reference. To correspond with the SSC on the toolholder.

INDEXABLE MILLING

SOLID END MILLING

HOLEMAKING

TAPPING

TURNING

## Top Cut 4 • Center Inserts • Long Chip Materials V38

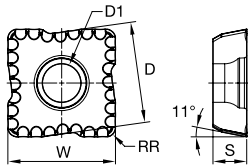

- first choice
- alternate choice

P	●
M	●
K	○
N	○
S	○
H	○

catalog number	D		D1		W		S		RR		SSC	WU40PH
	mm	in	mm	in	mm	in	mm	in	mm	in		
<b>TCF040203ACV38</b>	4,47	.176	2,10	.083	3,65	.144	2,00	.079	0,300	.012	A	6429458
<b>TCF060203BCV38</b>	6,00	.236	2,40	.094	4,90	.193	2,40	.095	0,300	.012	B	6429459
<b>TCF070304CCV38</b>	7,59	.299	2,60	.102	6,20	.244	2,80	.110	0,400	.015	C	6429460
<b>TCF090305DCV38</b>	9,55	.376	2,80	.110	7,80	.307	3,00	.118	0,500	.019	D	6429461
<b>TCF120405ECV38</b>	12,00	.473	3,40	.134	9,80	.386	3,60	.142	0,500	.019	E	6429462
<b>TCF150406FCV38</b>	14,94	.588	4,80	.189	12,20	.480	4,20	.165	0,600	.023	F	6429463
<b>TCF180508GCV38</b>	17,88	.704	6,00	.236	14,60	.575	5,40	.213	0,800	.031	G	6324383
<b>TCF210608HCV38</b>	21,68	.853	7,50	.295	17,70	.697	6,50	.256	0,800	.031	H	6429464

NOTE: SSC = Pocket Seat Reference. To correspond with the SSC on the toolholder.

INDEXABLE MILLING

SOLID END MILLING

HOLEMAKING

TAPPING

TURNING

## Top Cut 4 • Periphery Inserts • Long Chip Materials V38

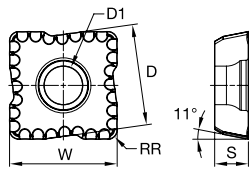

- first choice
- alternate choice

P	●	●
M	●	●
K	○	○
N	○	○
S	○	○
H	○	○

catalog number	D		D1		W		S		RR		SSC	WU25CH	WU40PH
	mm	in	mm	in	mm	in	mm	in	mm	in			
TCF040204APV38	4,14	.163	2,10	.083	4,40	.173	2,00	.079	0,400	.015	A	6429424	6429425
TCF050204BPV38	5,07	.200	2,40	.094	5,40	.213	2,40	.094	0,400	.015	B	6429426	6429427
TCF070306CPV38	6,67	.263	2,60	.102	7,10	.280	2,80	.110	0,600	.023	C	6429466	6429428
TCF080308DPV38	8,08	.318	2,80	.110	8,60	.339	3,00	.118	0,800	.031	D	6429429	6429430
TCF100408EPV38	9,96	.392	3,40	.134	10,60	.417	3,60	.142	0,800	.031	E	6429451	6429452
TCF120412FPV38	12,59	.496	4,80	.189	13,40	.528	4,20	.165	1,200	.046	F	6429453	6429454
TCF150512GPV38	15,13	.596	6,00	.236	16,10	.634	5,40	.213	1,200	.046	G	6429455	6324381
TCF180614HPV38	18,04	.710	7,50	.295	19,20	.756	6,50	.256	1,400	.054	H	6429456	6429457

NOTE: SSC = Pocket Seat Reference. To correspond with the SSC on the toolholder.

INDEXABLE MILLING

SOLID END MILLING

HOLEMAKING

TAPPING

TURNING

## Top Cut 4 • Center Inserts • Universal DU

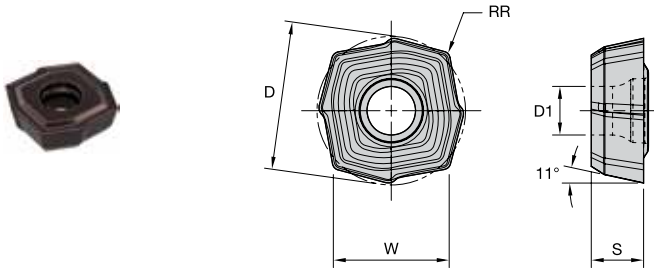

- first choice
- alternate choice

P	●
M	●
K	●
N	○
S	○
H	○

catalog number	D		D1		W		S		RR		SSC	WU20PH 6858590 6858611 6858612 6858613
	mm	in	mm	in	mm	in	mm	in	mm	in		
TCF070304CCDU	7,59	.299	2,60	.102	6,20	.244	2,80	.110	0,400	.015	C	
TCF090305DCDU	9,55	.376	2,80	.110	7,80	.307	3,00	.118	0,500	.019	D	
TCF120405ECDU	12,00	.473	3,40	.134	9,80	.386	3,60	.142	0,500	.019	E	
TCF150406FCDU	14,94	.588	4,80	.189	12,20	.480	4,20	.165	0,600	.023	F	

NOTE: For application-specific insert selection, please refer to the application data on page C113.  
SSC = Pocket Seat Reference. To correspond with the SSC on the toolholder.

INDEXABLE MILLING

SOLID END MILLING

HOLEMAKING

TAPPING

TURNING



INDEXABLE MILLING

SOLID END MILLING

HOLEMAKING

TAPPING

TURNING

## Top Cut 4 • Periphery Inserts • Universal DU

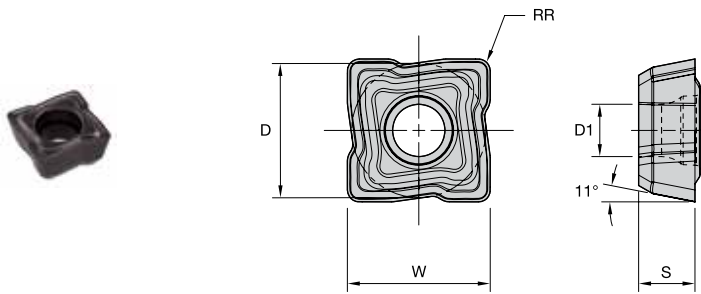

- first choice
- alternate choice

P	●
M	●
K	●
N	●
S	●
H	●

catalog number	D		D1		W		S		RR		SSC	WU20PH
	mm	in	mm	in	mm	in	mm	in	mm	in		
TCF070306CPDU	6,67	.263	2,60	.102	7,10	.280	2,80	.110	0,600	.023	C	6858586
TCF080308DPDU	8,08	.318	2,80	.110	8,60	.339	3,00	.118	0,800	.031	D	6858587
TCF100408EPDU	9,96	.392	3,40	.134	10,60	.417	3,60	.142	0,800	.031	E	6858588
TCF120412FPDU	12,59	.496	4,80	.189	13,40	.528	4,20	.165	1,200	.046	F	6858589

NOTE: For application-specific insert selection, please refer to the application data on page C113.  
SSC = Pocket Seat Reference. To correspond with the SSC on the toolholder.

Top Cut 4 • Insert Selection Guide

Material Group	Geometry	Light Machining		General Purpose		Heavy Machining	
		periphery insert	center insert	periphery insert	center insert	periphery insert	center insert
P1	V38/DU	WU25CH	WU40PH/WU20PH	WU40PH/WU20PH	WU40PH/WU20PH	WU40PH/WU20PH	WU40PH/WU20PH
P2-P4	V34/DU	WPK10CH	WU40PH/WU20PH	WU25CH/WU20PH	WU40PH/WU20PH	WU40PH/WU20PH	WU40PH/WU20PH
P5-P6	V36/DU	WU25CH	WU40PH/WU20PH	WU40PH/WU20PH	WU40PH/WU20PH	WU40PH/WU20PH	WU40PH/WU20PH
M1-M3	V36/DU	WU25CH	WU40PH/WU20PH	WU40PH/WU20PH	WU40PH/WU20PH	WU40PH/WU20PH	WU40PH/WU20PH
K1-K3	V34/DU	WPK10CH	WU40PH/WU20PH	WU40PH/WU20PH	WU40PH/WU20PH	WU40PH/WU20PH	WU40PH/WU20PH
N1-N4	V36	WN10PH	WN10PH	WN10PH	WN10PH	WN10PH	WN10PH
S1-S4	V38/DU	WU40PH/WU20PH	WU40PH/WU20PH	WU40PH/WU20PH	WU40PH/WU20PH	WU40PH/WU20PH	WU40PH/WU20PH

NOTE: All speed conditions are for stable conditions. For unstable conditions, it is suggested to reduce starting speeds by 10%. For interrupted cuts, reduce speed by 20%.

For 4 x D, it is highly recommended to start with feed and speed values reduced by 10% less than above data.

For 5 x D, diameter range 12–23,99mm (insert sizes A to C), it is highly recommended to start with feed and speed values reduced by 20% less than above data.

For 5 x D, diameter range 25–68mm (inserts sizes D to H), it is highly recommended to start with feed and speed values reduced by 15% less than above data.

For 4 x D and 5 x D, it is recommended to reduce feed rate during entry and exit by 30–50%.

INDEXABLE MILLING

SOLID END MILLING

HOLEMAKING

TAPPING

TURNING

## Top Cut 4 • Cutting Data • Inch

Material Group	Geometry	Grade		Cutting Speed – SFM			Tool Diameter	Recommended Feed Rate per Revolution			
								.473-.531"	.563-.734"	.750-.938"	.969-1.156"
		center	periphery	min	Start	max		Insert Size A	Insert Size B	Insert Size C	Insert Size D
P0	-V38	WU40PH	WU25CH	360	540	780	IPR	0.0024-0.0031	0.0031-0.0043	0.0039-0.0051	0.0043-0.0055
	-DU	WU20PH	WU20PH	290	430	625	IPR	-	-	0.0031-0.0041	0.0034-0.0044
P1	-V38	WU40PH	WU25CH	360	540	780	IPR	0.0024-0.0039	0.0031-0.0051	0.0039-0.0059	0.0043-0.0063
	-DU	WU20PH	WU20PH	290	430	625	IPR	-	-	0.0031-0.0047	0.0034-0.0050
P2	-V34	WU40PH	WU25CH	360	570	840	IPR	0.0024-0.0039	0.0031-0.0059	0.0039-0.0063	0.0043-0.0067
	-DU	WU20PH	WU20PH	290	450	675	IPR	-	-	0.0031-0.0050	0.0034-0.0054
P3	-V34	WU40PH	WPK10CH	360	600	930	IPR	0.0031-0.0059	0.0039-0.0063	0.0043-0.0071	0.0047-0.0079
	-DU	WU20PH	WU20PH	290	480	745	IPR	-	-	0.0034-0.0067	0.0037-0.0063
P4	-V34	WU40PH	WPK10CH	360	570	930	IPR	0.0031-0.0059	0.0039-0.0063	0.0043-0.0071	0.0047-0.0079
	-DU	WU20PH	WU20PH	290	450	745	IPR	-	-	0.0034-0.0067	0.0037-0.0063
P5	-V36	WU40PH	WU25CH	360	540	750	IPR	0.0024-0.0039	0.0031-0.0055	0.0039-0.0059	0.0043-0.0063
	-DU	WU20PH	WU20PH	290	430	600	IPR	-	-	0.0031-0.0047	0.0034-0.0050
P6	-V36	WU40PH	WU25CH	360	480	630	IPR	0.0024-0.0039	0.0031-0.0055	0.0039-0.0059	0.0043-0.0063
	-DU	WU20PH	WU20PH	290	385	500	IPR	-	-	0.0031-0.0047	0.0034-0.0050
M1	-V38	WU40PH	WU40PH	360	480	720	IPR	0.0024-0.0047	0.0028-0.0051	0.0031-0.0059	0.0039-0.0063
	-DU	WU20PH	WU20PH	290	385	575	IPR	-	-	0.0025-0.0047	0.0031-0.0050
M2	-V38	WU40PH	WU40PH	330	420	630	IPR	0.0024-0.0047	0.0028-0.0051	0.0031-0.0059	0.0039-0.0063
	-DU	WU20PH	WU20PH	265	340	500	IPR	-	-	0.0025-0.0047	0.0031-0.0050
M3	-V36	WU40PH	WU40PH	300	360	600	IPR	0.0024-0.0047	0.0028-0.0051	0.0031-0.0059	0.0039-0.0063
	-DU	WU20PH	WU20PH	240	290	480	IPR	-	-	0.0025-0.0047	0.0031-0.0050
K1	-V34	WU25CH	WPK10CH	360	600	840	IPR	0.0031-0.0055	0.0031-0.0063	0.0039-0.0071	0.0047-0.0094
	-DU	WU20PH	WU20PH	290	480	675	IPR	-	-	0.0031-0.0057	0.0038-0.0075
K2	-V34	WU40PH	WPK10CH	300	540	780	IPR	0.0031-0.0055	0.0031-0.0063	0.0039-0.0071	0.0047-0.0094
	-DU	WU20PH	WU20PH	240	430	625	IPR	-	-	0.0031-0.0057	0.0038-0.0075
K3	-V34	WU40PH	WPK10CH	300	510	720	IPR	0.0031-0.0055	0.0031-0.0063	0.0039-0.0071	0.0047-0.0094
	-DU	WU20PH	WU20PH	240	400	575	IPR	-	-	0.0031-0.0057	0.0038-0.0075
N1	-V36	WN10PH	WN10PH	450	900	1350	IPR	0.0024-0.0039	0.0031-0.0055	0.0039-0.0059	0.0043-0.0063
	-V36	WN10PH	WN10PH	450	900	1350	IPR	0.0024-0.0039	0.0031-0.0055	0.0039-0.0059	0.0043-0.0063
N2	-V36	WN10PH	WN10PH	450	900	1350	IPR	0.0024-0.0039	0.0031-0.0055	0.0039-0.0059	0.0043-0.0063
	-V36	WN10PH	WN10PH	240	360	450	IPR	0.0024-0.0039	0.0028-0.0043	0.0031-0.0047	0.0039-0.0055
S3	-V38	WU40PH	WU40PH	60	90	135	IPR	0.0031-0.0047	0.0031-0.0051	0.0039-0.0059	0.0047-0.0075
	-DU	WU20PH	WU20PH	50	70	100	IPR	-	-	0.0031-0.0047	0.0038-0.006
S4	-V38	WU40PH	WU40PH	105	120	195	IPR	0.0031-0.0047	0.0031-0.0051	0.0039-0.0059	0.0047-0.0075
	-DU	WU20PH	WU20PH	85	95	150	IPR	-	-	0.0031-0.0047	0.0038-0.006

Material Group	Geometry	Grade		Cutting Speed – SFM			Tool Diameter	Recommended Feed Rate per Revolution			
								1.188-1.438"	1.469-1.750"	1.813-2.219"	2.250-2.500"
		center	periphery	min	Start	max		Insert Size E	Insert Size F	Insert Size G	Insert Size H
P0	-V38	WU40PH	WU25CH	360	540	780	IPR	0.0051-0.0063	0.0059-0.0071	0.0063-0.0091	0.0067-0.0094
	-DU	WU20PH	WU20PH	290	430	624	IPR	0.0040-0.0050	0.0047-0.0057	-	-
P1	-V38	WU40PH	WU25CH	360	540	780	IPR	0.0051-0.0071	0.0059-0.0079	0.0063-0.0106	0.0067-0.0114
	-DU	WU20PH	WU20PH	290	430	625	IPR	0.0040-0.0057	0.0047-0.0063	-	-
P2	-V34	WU40PH	WU25CH	360	570	840	IPR	0.0051-0.0079	0.0059-0.0083	0.0063-0.0110	0.0067-0.0118
	-DU	WU20PH	WU20PH	290	450	675	IPR	0.0040-0.0063	0.0047-0.0063	-	-
P3	-V34	WU40PH	WPK10CH	360	600	930	IPR	0.0053-0.0094	0.0063-0.0094	0.0071-0.0118	0.0075-0.0126
	-DU	WU20PH	WU20PH	290	480	745	IPR	0.0042-0.0075	0.0050-0.0075	-	-
P4	-V34	WU40PH	WPK10CH	360	570	930	IPR	0.0055-0.0087	0.0063-0.0094	0.0071-0.0118	0.0075-0.0126
	-DU	WU20PH	WU20PH	290	450	745	IPR	0.0044-0.0069	0.0050-0.0075	-	-
P5	-V36	WU40PH	WU25CH	360	540	750	IPR	0.0051-0.0071	0.0059-0.0079	0.0063-0.0110	0.0067-0.0118
	-DU	WU20PH	WU20PH	290	430	600	IPR	0.0040-0.0057	0.0047-0.0063	-	-
P6	-V36	WU40PH	WU25CH	360	480	630	IPR	0.0051-0.0071	0.0059-0.0079	0.0063-0.0110	0.0067-0.0114
	-DU	WU20PH	WU20PH	290	380	500	IPR	0.0040-0.0057	0.0047-0.0063	-	-
M1	-V38	WU40PH	WU40PH	360	480	720	IPR	0.0047-0.0079	0.0055-0.0098	0.0063-0.0110	0.0063-0.0118
	-DU	WU20PH	WU20PH	290	385	575	IPR	0.0038-0.0063	0.0044-0.0078	-	-
M2	-V38	WU40PH	WU40PH	330	420	630	IPR	0.0047-0.0079	0.0055-0.0098	0.0063-0.0110	0.0063-0.0118
	-DU	WU20PH	WU20PH	265	330	500	IPR	0.0038-0.0063	0.0044-0.0078	-	-
M3	-V36	WU40PH	WU40PH	300	360	600	IPR	0.0047-0.0079	0.0055-0.0098	0.0063-0.0110	0.0063-0.0118
	-DU	WU20PH	WU20PH	240	290	480	IPR	0.0038-0.0063	0.0044-0.0098	-	-
K1	-V34	WU25CH	WPK10CH	360	600	840	IPR	0.0055-0.0102	0.0063-0.0118	0.0071-0.0126	0.0079-0.0142
	-DU	WU20PH	WU20PH	290	480	670	IPR	0.0044-0.0081	0.0050-0.0094	-	-
K2	-V34	WU40PH	WPK10CH	300	540	780	IPR	0.0055-0.0102	0.0063-0.0118	0.0071-0.0126	0.0079-0.0142
	-DU	WU20PH	WU20PH	240	430	625	IPR	0.0044-0.0081	0.0050-0.0094	-	-
K3	-V34	WU40PH	WPK10CH	300	510	720	IPR	0.0055-0.0102	0.0063-0.0118	0.0071-0.0126	0.0079-0.0142
	-DU	WU20PH	WU20PH	240	400	575	IPR	0.0044-0.0081	0.0050-0.0094	-	-
N1	-V36	WN10PH	WN10PH	450	900	1350	IPR	0.0051-0.0071	0.0059-0.0079	0.0063-0.0110	0.0067-0.0118
	-V36	WN10PH	WN10PH	450	900	1350	IPR	0.0051-0.0071	0.0059-0.0079	0.0063-0.0110	0.0067-0.0118
N2	-V36	WN10PH	WN10PH	450	900	1350	IPR	0.0051-0.0071	0.0059-0.0079	0.0063-0.0110	0.0067-0.0118
	-V36	WN10PH	WN10PH	240	360	450	IPR	0.0047-0.0067	0.0055-0.0083	0.0063-0.0091	0.0063-0.0094
S3	-V38	WU40PH	WU40PH	60	90	135	IPR	0.0055-0.0083	0.0063-0.0094	0.0071-0.0102	0.0079-0.0118
	-DU	WU20PH	WU20PH	50	70	100	IPR	0.0044-0.0083	0.0050-0.0075	-	-
S4	-V38	WU40PH	WU40PH	105	120	195	IPR	0.0055-0.0083	0.0063-0.0094	0.0071-0.0102	0.0079-0.0118
	-DU	WU20PH	WU20PH	85	95	150	IPR	0.0044-0.0064	0.0050-0.0075	-	-

NOTE: All speed conditions are for stable conditions. For unstable conditions, it is suggested to reduce starting speeds by 10%. For interrupted cuts, reduce speed by 20%.  
 For 4 x D, it is highly recommended to start with feed and speed values reduced by 10% less than above data.  
 For 5 x D, diameter range .473-.938" (insert sizes A to C), it is highly recommended to start with feed and speed values reduced by 20% less than above data.  
 For 5 x D, diameter range .969-2.5" (insert sizes D to H), it is highly recommended to start with feed and speed values reduced by 15% less than above data.  
 For 4 x D and 5 x D, it is recommended to reduce feed rate during entry and exit by 30-50%.

INDEXABLE MILLING

SOLID END MILLING

HOLEMAKING

TAPPING

TURNING

Top Cut 4 • Cutting Data • Metric

Material Group	Geometry	Grade		Cutting Speed – vc			Recommended Feed Rate per Revolution				
				m/min			Tool Diameter	12,00–13,99 Insert Size A	14,00–18,99 Insert Size B	19,00–23,99 Insert Size C	24,00–29,99 Insert Size D
		center	periphery	min	Start	max					
P0	-V38	WU40PH	WU25CH	120	180	260	mm/rev	0,06–0,08	0,08–0,11	0,10–0,13	0,11–0,14
	-DU	WU20PH	WU20PH	90	150	200	mm/rev	–	–	0,07–0,10	0,08–0,10
P1	-V38	WU40PH	WU25CH	120	180	260	mm/rev	0,06–0,10	0,08–0,13	0,10–0,15	0,11–0,16
	-DU	WU20PH	WU20PH	90	150	200	mm/rev	–	–	0,07–0,11	0,08–0,11
P2	-V34	WU40PH	WU25CH	120	190	280	mm/rev	0,06–0,10	0,08–0,15	0,10–0,16	0,11–0,17
	-DU	WU20PH	WU20PH	90	150	220	mm/rev	–	–	0,07–0,12	0,08–0,13
P3	-V34	WU40PH	WPK10CH	120	200	310	mm/rev	0,08–0,15	0,10–0,16	0,11–0,18	0,12–0,20
	-DU	WU20PH	WU20PH	90	160	220	mm/rev	–	–	0,08–0,13	0,09–0,15
P4	-V34	WU40PH	WPK10CH	120	190	310	mm/rev	0,08–0,15	0,10–0,16	0,11–0,18	0,12–0,20
	-DU	WU20PH	WU20PH	90	150	220	mm/rev	–	–	0,08–0,13	0,09–0,15
P5	-V36	WU40PH	WU25CH	120	180	250	mm/rev	0,06–0,10	0,08–0,14	0,10–0,15	0,11–0,16
	-DU	WU20PH	WU20PH	90	150	220	mm/rev	–	–	0,07–0,11	0,08–0,12
P6	-V36	WU40PH	WU25CH	120	160	210	mm/rev	0,06–0,10	0,08–0,14	0,10–0,15	0,11–0,16
	-DU	WU20PH	WU20PH	90	130	165	mm/rev	–	–	0,07–0,11	0,08–0,12
M1	-V38	WU40PH	WU40PH	120	160	240	mm/rev	0,06–0,11	0,07–0,11	0,08–0,12	0,10–0,14
	-DU	WU20PH	WU20PH	90	130	190	mm/rev	–	–	0,06–0,09	0,07–0,10
M2	-V38	WU40PH	WU40PH	110	140	210	mm/rev	0,06–0,10	0,07–0,11	0,08–0,12	0,10–0,14
	-DU	WU20PH	WU20PH	110	140	190	mm/rev	–	–	0,06–0,09	0,07–0,10
M3	-V36	WU40PH	WU40PH	100	120	200	mm/rev	0,06–0,10	0,07–0,11	0,08–0,12	0,10–0,14
	-DU	WU20PH	WU20PH	80	100	160	mm/rev	–	–	0,06–0,09	0,07–0,10
K1	-V34	WU25CH	WPK10CH	120	200	280	mm/rev	0,08–0,14	0,08–0,16	0,10–0,18	0,12–0,24
	-DU	WU20PH	WU20PH	90	160	220	mm/rev	–	–	0,07–0,13	0,09–0,18
K2	-V34	WU40PH	WPK10CH	100	180	260	mm/rev	0,08–0,14	0,08–0,16	0,10–0,18	0,12–0,24
	-DU	WU20PH	WU20PH	80	140	200	mm/rev	–	–	0,07–0,13	0,09–0,18
K3	-V34	WU40PH	WPK10CH	100	170	240	mm/rev	0,08–0,14	0,08–0,16	0,10–0,18	0,12–0,24
	-DU	WU20PH	WU20PH	80	140	190	mm/rev	–	–	0,07–0,13	0,09–0,18
N1	-V36	WN10PH	WN10PH	250	350	500	mm/rev	0,06–0,10	0,08–0,14	0,10–0,15	0,11–0,16
	-V36	WN10PH	WN10PH	150	300	450	mm/rev	0,06–0,10	0,08–0,14	0,10–0,15	0,11–0,16
N3	-V36	WN10PH	WN10PH	80	120	150	mm/rev	0,06–0,10	0,07–0,11	0,08–0,12	0,10–0,14
	-V38	WU40PH	WU40PH	20	30	45	mm/rev	0,08–0,12	0,08–0,13	0,10–0,15	0,12–0,19
S3	-DU	WU20PH	WU20PH	20	30	40	mm/rev	–	–	0,07–0,11	0,09–0,14
	-V38	WU40PH	WU40PH	35	40	65	mm/rev	0,08–0,12	0,08–0,13	0,10–0,15	0,12–0,19
S4	-DU	WU20PH	WU20PH	30	40	60	mm/rev	–	–	0,07–0,11	0,09–0,14

Material Group	Geometry	Grade		Cutting Speed – vc			Tool Diameter	Recommended Feed Rate per Revolution			
				m/min				30,00–36,99 Insert Size E	37,00–45,99 Insert Size F	46,00–56,99 Insert Size G	57,00–68,00 Insert Size H
		center	periphery	min	Start	max					
P0	-V38	WU40PH	WU25CH	120	180	260	mm/rev	0,13–0,16	0,15–0,18	0,16–0,23	0,17–0,24
	-DU	WU20PH	WU20PH	90	140	200	mm/rev	0,09–0,12	0,11–0,13	–	–
P1	-V38	WU40PH	WU25CH	120	180	260	mm/rev	0,13–0,17	0,15–0,19	0,16–0,24	0,17–0,25
	-DU	WU20PH	WU20PH	90	140	200	mm/rev	0,09–0,13	0,11–0,14	–	–
P2	-V34	WU40PH	WU25CH	120	190	280	mm/rev	0,13–0,20	0,15–0,21	0,16–0,28	0,17–0,30
	-DU	WU20PH	WU20PH	90	150	220	mm/rev	0,09–0,15	0,11–0,15	–	–
P3	-V34	WU40PH	WPK10CH	120	200	310	mm/rev	0,16–0,24	0,16–0,24	0,18–0,30	0,19–0,32
	-DU	WU20PH	WU20PH	90	160	250	mm/rev	0,12–0,16	0,12–0,18	–	–
P4	-V34	WU40PH	WPK10CH	120	190	310	mm/rev	0,14–0,22	0,16–0,24	0,18–0,30	0,19–0,32
	-DU	WU20PH	WU20PH	90	150	250	mm/rev	0,12–0,16	0,12–0,18	–	–
P5	-V36	WU40PH	WU25CH	120	180	250	mm/rev	0,13–0,18	0,15–0,20	0,16–0,28	0,17–0,30
	-DU	WU20PH	WU20PH	90	140	200	mm/rev	0,09–0,13	0,11–0,15	–	–
P6	-V36	WU40PH	WU25CH	120	160	210	mm/rev	0,13–0,18	0,15–0,20	0,16–0,28	0,17–0,29
	-DU	WU20PH	WU20PH	90	120	160	mm/rev	0,09–0,13	0,11–0,15	–	–
M1	-V38	WU40PH	WU40PH	120	160	240	mm/rev	0,12–0,17	0,14–0,21	0,16–0,23	0,16–0,24
	-DU	WU20PH	WU20PH	90	120	190	mm/rev	0,09–0,13	0,10–0,15	–	–
M2	-V38	WU40PH	WU40PH	110	140	210	mm/rev	0,12–0,17	0,14–0,21	0,16–0,23	0,16–0,24
	-DU	WU20PH	WU20PH	90	110	160	mm/rev	0,09–0,13	0,10–0,15	–	–
M3	-V36	WU40PH	WU40PH	100	120	200	mm/rev	0,12–0,17	0,14–0,21	0,16–0,23	0,16–0,24
	-DU	WU20PH	WU20PH	80	90	160	mm/rev	0,09–0,13	0,10–0,15	–	–
K1	-V34	WU25CH	WPK10CH	120	200	280	mm/rev	0,14–0,26	0,16–0,30	0,18–0,32	0,20–0,36
	-DU	WU20PH	WU20PH	90	160	220	mm/rev	0,10–0,19	0,12–0,22	–	–
K2	-V34	WU40PH	WPK10CH	100	180	260	mm/rev	0,14–0,26	0,16–0,30	0,18–0,32	0,20–0,36
	-DU	WU20PH	WU20PH	80	140	200	mm/rev	0,10–0,19	0,12–0,22	–	–
K3	-V34	WU40PH	WPK10CH	100	170	240	mm/rev	0,14–0,26	0,16–0,30	0,18–0,32	0,20–0,36
	-DU	WU20PH	WU20PH	80	130	190	mm/rev	0,10–0,19	0,12–0,22	–	–
N1	-V36	WN10PH	WN10PH	250	350	500	mm/rev	0,13–0,18	0,15–0,20	0,16–0,28	0,17–0,30
	-V36	WN10PH	WN10PH	150	300	450	mm/rev	0,13–0,18	0,15–0,20	0,16–0,28	0,17–0,30
N3	-V36	WN10PH	WN10PH	80	120	150	mm/rev	0,12–0,17	0,14–0,21	0,16–0,23	0,16–0,24
	-V38	WU40PH	WU40PH	20	30	45	mm/rev	0,14–0,21	0,16–0,24	0,18–0,26	0,20–0,30
S3	-DU	WU20PH	WU20PH	20	25	40	mm/rev	0,10–0,15	0,12–0,18	–	–
	-V38	WU40PH	WU40PH	35	40	65	mm/rev	0,14–0,21	0,16–0,24	0,18–0,26	0,20–0,30
S4	-DU	WU20PH	WU20PH	30	35	50	mm/rev	0,10–0,15	0,12–0,18	–	–

NOTE: All speed conditions are for stable conditions. For unstable conditions, it is suggested to reduce starting speeds by 10%. For interrupted cuts, reduce speed by 20%.  
 For 4 x D, it is highly recommended to start with feed and speed values reduced by 10% less than above data.  
 For 5 x D, diameter range 12–23,99mm (insert sizes A to C), it is highly recommended to start with feed and speed values reduced by 20% less than above data.  
 For 5 x D, diameter range 25–68mm (insert sizes D to H), it is highly recommended to start with feed and speed values reduced by 15% less than above data.  
 For 4 x D and 5 x D, it is recommended to reduce feed rate during entry and exit by 30–50%.

## Top Cut 4 • Drill Depth • X-Offset Capabilities • Hole Tolerance

Insert size	Diameter range mm (in)	2 x D/3 x D			4 x D			5 x D		
		X-offset value max. in mm (max. in inch)	D1 max value mm (in)	Hole tolerance mm (in)	X-offset value max. in mm (max. in inch)	D1 max value mm (in)	Hole tolerance mm (in)	X-offset value max. in mm (max. in inch)	D1 max value mm (in)	Hole tolerance mm (in)
A	12,00–13,99 (.473–.531)	0,5 (0.020)	D1 + 1mm (D1 + 0.039")	+/- 0,20 (+/- 0.008)	0,5 (0.020)	D1 + 1mm (D1 + 0.039")	+/- 0,35 (+/- 0.014)	—	—	+/- 0,35 (+/- 0.014)
B	14,00–18,99 (.563–.734)	0,5 (0.020)	D1 + 1mm (D1 + 0.039")	+/- 0,20 (+/- 0.008)	0,5 (0.020)	D1 + 1mm (D1 + 0.039")	+/- 0,35 (+/- 0.014)	—	—	+/- 0,35 (+/- 0.014)
C	19,00–23,99 (.750–.938)	0,5 (0.020)	D1 + 1mm (D1 + 0.039")	+/- 0,20 (+/- 0.008)	0,5 (0.020)	D1 + 1mm (D1 + 0.039")	+/- 0,35 (+/- 0.014)	—	—	+/- 0,35 (+/- 0.014)
D	24,00–29,99 (.969–1.156)	0,8 (0.031)	D1 + 1,6mm (D1 + 0.063")	+/- 0,20 (+/- 0.008)	0,8 (0.031)	D1 + 1mm (D1 + 0.039")	+/- 0,35 (+/- 0.014)	—	—	+/- 0,35 (+/- 0.014)
E	30,00–36,99 (1.188–1.438)	0,8 (0.031)	D1 + 1,6mm (D1 + 0.063")	+/- 0,20 (+/- 0.008)	0,8 (0.031)	D1 + 1mm (D1 + 0.039")	+/- 0,35 (+/- 0.014)	—	—	+/- 0,35 (+/- 0.014)
F	37,00–45,99 (1.469–1.750)	0,8 (0.031)	D1 + 1,6mm (D1 + 0.063")	+/- 0,25 (+/- 0.010)	0,8 (0.031)	D1 + 1mm (D1 + 0.039")	+/- 0,38 (+/- 0.015)	—	—	+/- 0,38 (+/- 0.015)
G	46,00–56,99 (1.813–2.219)	1 (0.039)	D1 + 2mm (D1 + 0.079")	+/- 0,25 (+/- 0.010)	0,8 (0.031)	D1 + 1mm (D1 + 0.039")	+/- 0,38 (+/- 0.015)	—	—	+/- 0,38 (+/- 0.015)
H	57,00–68,00 (2.250–2.500)	1 (0.039)	D1 + 2mm (D1 + 0.079")	+/- 0,28 (+/- 0.011)	0,8 (0.031)	D1 + 1mm (D1 + 0.039")	+/- 0,42 (+/- 0.017)	—	—	+/- 0,42 (+/- 0.017)

NOTE: All speed conditions are for stable conditions. For unstable conditions, it is suggested to reduce starting speeds by 10%. For interrupted cuts, reduce speed by 20%. For 4 x D, it is highly recommended to start with feed and speed values reduced by 10% less than above data. For 5 x D, diameter range .473–.938" (insert sizes A to C), it is highly recommended to start with feed and speed values reduced by 20% less than above data. For 5 x D, diameter range .969–2.5" (inserts sizes D to H), it is highly recommended to start with feed and speed values reduced by 15% less than above data. For 4 x D and 5 x D, it is recommended to reduce feed rate during entry and exit by 30–50%.

## Top Cut 4 • Screw Torque

SSC	periphery insert	center insert	Torx size	tightening torque Nm	tightening torque ft. lbs
A	TCF040204AP	TCF040203AC	T5	0,40	.295
B	TCF050204BP	TCF060203BC	T6	0,53	.390
C	TCF070306CP	TCF070304CC	T7	0,90	.663
D	TCF080308DP	TCF090305DC	T8	1,10	.811
E	TCF100408EP	TCF120405EC	T9	2,00	1.475
F	TCF120412FP	TCF150406FC	T15	4,00	2.950
F	TCF120412FP	TCF150406FC	T15	4,00	2.950
G	TCF150512GP	TCF180508GC	T20	6,30	4.646
H	TCF180614HP	TCF210608HC	T25	8,80	6.490
H	TCF180614HP	TCF210608HC	T25	8,80	6.490

Application Data • Top Cut 4™

Top Cut 4 • Drill Depth • 2 x D/3 x D • Hole Tolerance Table

Insert size	Diameter Range (mm)	Hole Tolerance (mm)
A	12,00–13,99	+/- 0,20
B	14,00–18,99	+/- 0,20
C	19,00–23,99	+/- 0,20
D	24,00–29,99	+/- 0,20
E	30,00–36,99	+/- 0,20
F	37,00–45,99	+/- 0,25
G	46,00–56,99	+/- 0,25
H	57,00–68,00	+/- 0,28

Top Cut 4 • Drill Depth • 4 x D/5 x D • Hole Tolerance Table

Insert size	Diameter Range (mm)	Hole Tolerance (mm)
A	12,00–13,99	+/- 0,35
B	14,00–18,99	+/- 0,35
C	19,00–23,99	+/- 0,35
D	24,00–29,99	+/- 0,35
E	30,00–36,99	+/- 0,35
F	37,00–45,99	+/- 0,38
G	46,00–56,99	+/- 0,38
H	57,00–68,00	+/- 0,42

Coolant Requirement/Recommendation

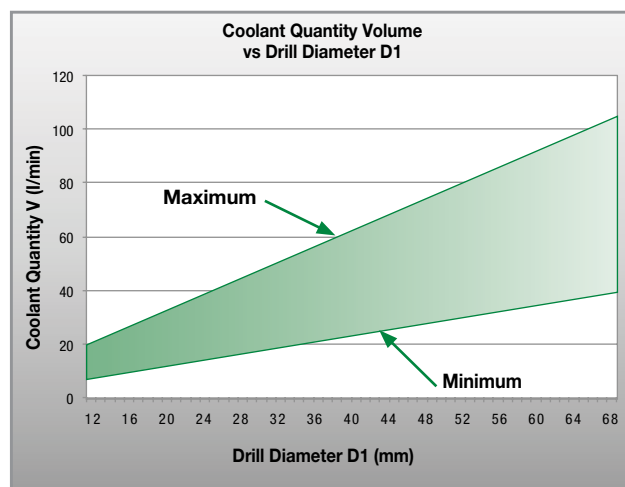
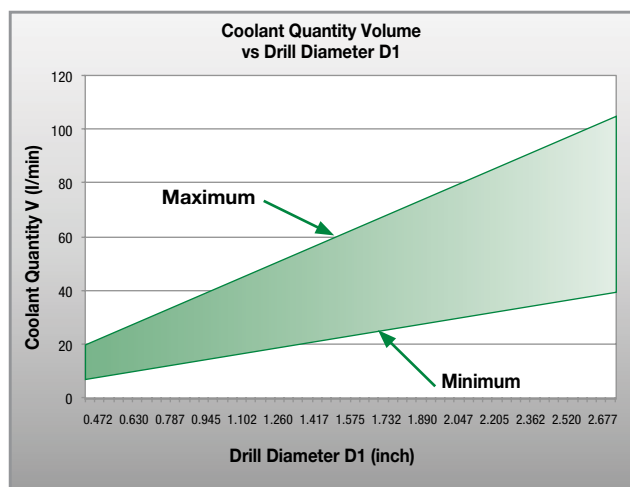

























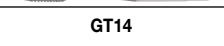
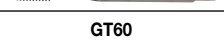
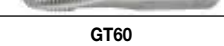

# Tapping

High-Performance Taps Selection Guide .....	D4–D19
General-Purpose Taps .....	D20–D63
Multipurpose Taps • VariTap.....	D64–D88
Aerospace Fastener Taps.....	D90–D95
High-Performance Taps • GT Series .....	D96–D126
Technical Information .....	D127–D133



## Selection Guide

series	hole		thread		coolant		size range min-max	grade/ coating	material				chamfer		helix angle	dimension
	through	blind	cutting	forming	flood	through			carbide	HSS-E-PM	HSS-E	HSS	type	form		
																
<b>Spiral-Point and Left-Hand Spiral-Flute Taps</b>																
 GT20	X		X		X		#2-3/4"	WU32MG, WS34MG	X				plug	D	L15°	ANSI 302A
 GT20	X		X		X		#6-1/2"	WU32MG	X				plug	D	L15°	DIN/ANSI
 GT20	X		X		X		M3-M12	WU32MG, WS34MG	X				plug	D	L15°	ANSI 302A
 GT20	X		X		X		M3-M42	WU32MG, WS34MG	X				plug	D	L15°	DIN 371, 374, 376
 GT20	X		X		X		M24-M42	WU32MG	X				plug	D	L15°	DIN 376, XL
 GT21	X		X			X	M5-M14	WU32MG, WS34MG	X				plug	D	L15°	DIN 371, 376
 GT10	X		X		X		M3-M20	WS32MG	X				plug	D	L8°	DIN 371, 376
 GT90	X		X		X		#2-3/4"	WU32MG, WS39MG	X				plug	D	L15°	ANSI 302A
 GT90	X		X		X		M2.5-M12	WU32MG, WS39MG	X				plug	D	L15°	ANSI 302A
 GT14	X		X		X		M3-M12	WN35MG	X				plug	B	0°	DIN 371, 376
 GT60	X		X		X		#2-1"	WS34MG	X				plug	D	L15°	ANSI 302A
 GT60	X		X		X		M2.5-M12	WS34MG	X				plug	D	L15°	ANSI 302A
 GT70	X		X	X			M3-M16	WN48EG		X			plug	B	0°	DIN 371, 376
 GT72	X		X		X		#2-1/2"	WN44EG		X			plug	D	L15°	DIN/ANSI
 GT72	X		X		X		M3-M12	WN44EG		X			plug	D	L15°	DIN/ANSI
 GT00	X		X		X		M3-M20	WP31MG	X				plug	B	0°	DIN 371, 374, 376
 VTSP050	X		X		X		#2-2"	WP42EG, WP49EG, WU41EG		X			plug	B	0°	ANSI 302A
 VTSP090	X		X		X		#4-3/4"	WP42EG, WP49EG		X			plug	B	0°	DIN/ANSI
 VTSP097	X		X			X	1/4-1"	WP42EG		X			plug	B	0°	DIN/ANSI

INDEXABLE MILLING

SOLID END MILLING

HOLEMAKING

TAPPING

TURNING

Selection Guide

P		M		K		N			S				H		page(s)	recommended cutting parameters	
1, 2, 3, 4, 6, 7	5, 9, 10, 11	12, 13.1	13.2	14.1, 14.2, 14.3, 14.4	15, 16	17, 18, 19, 20	21	22, 23, 24, 25	26, 27, 28	31, 32	33, 34, 35	36	37	38.1, 38.2, 40.1, 40.2, 41.1			39.1, 41.2
Steel <35 HRC	Steel >36-48 HRC	PH and Ferritic Stainless Steel <35 HRC	PH and Ferritic Stainless Steel >35 HRC	Stainless Steel	Gray Cast Iron	Ductile Cast Iron	Wrought Aluminum	Cast Aluminum	Copper, Copper Alloys	Iron Based	Cobalt Based	Nickel Based	Titanium Alloys	Hardened Steels 49-55 HRC	Hardened Steels 56-68 HRC		
<b>Spiral-Point and Left-Hand Spiral-Flute Taps (continued)</b>																	
***		***		***		**	*	*		**						D99	D126
***		***		***		**	*	*		**						-	-
***		***		***		**	*	*		**						D100	D126
***		***		***		**	*	*		**						-	-
***		***		***		**	*	*		**						-	-
***		***		***		**	*	*		**						-	-
											***	***				D97	-
											***	***				D115	D126
											***	***				D114	D126
													***			D97	-
													***			D105	D126
													***			D104	D126
							***	*	*							D97	-
							***	**								D109	D126
							***	**								D108	D126
	***		***	*	*	*					*					D97	D126
**	*	*		**	*	**	*	**	**	*						D67-D69	-
**	*	*		**	*	**	*	**	**	*						D70	-
**	*	*		**	*	**	*	**	**	*						D73	-

INDEXABLE MILLING

SOLID END MILLING

HOLEMAKING

TAPPING

TURNING

## Selection Guide

















INDEXABLE MILLING

SOLID END MILLING

HOLEMAKING

TAPPING

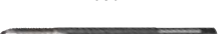
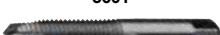
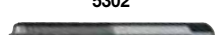
TURNING

series	hole		thread		coolant		size range min-max	grade/ coating	material				chamfer		helix angle	dimension
	through	blind	cutting	forming	flood	through			carbide	HSS-E-PM	HSS-E	HSS	type	form		
																
<b>Spiral-Point and Left-Hand Spiral-Flute Taps (continued)</b>																
 VTSP060	X		X		X		#4-1"	WU41EG, WP49EG			X		plug	B	0°	DIN 371, 376
 VTSP055	X		X		X		M3-M30	WP42EG, WP49EG, WU41EG			X		plug	B	0°	ANSI 302A
 VTSP095	X		X		X		M3-M20	WP42EG, WP49EG			X		plug	B	0°	DIN/ANSI
 VTSP099	X		X			X	M6-M20	WP42EG			X		plug	B	0°	DIN/ANSI
 VTSP065	X		X		X		M2-M36	WP42EG, WP49EG, WU41EG			X		plug	B	0°	DIN 371, 374, 376
 VTSP075	X		X		X		M3-M20	WU41EG			X		plug	B	0°	JIS
 5301/2301	X		X		X		#0-3/4"	TiCN, TiN, Oxide, Uncoated			X		plug	—	0°	ANSI 302
 5301F	X		X		X		1/4-1"	Uncoated			X		plug	—	0°	ANSI 302
 5301	X		X		X		#6-3/8"	Uncoated			X		plug	—	0°	Extend 6"
 5601	X		X		X		#6-3/4"	Oxide/ Nitride			X		plug	—	0°	ANSI 302
 5302		X	X		X		#0-5/16"	Uncoated			X	bottoming	—	0°	ANSI 302	
 5351/2351	X		X		X		M2-M18	TiCN, TiN, Uncoated			X		plug	—	0°	ANSI 302
 7301	X		X		X		#4-3/4"	Uncoated			X		plug	—	0°	ANSI 302

## Selection Guide

	P				M	K		N			S				H		page(s)	recommended cutting parameters
	1, 2, 3, 4, 6, 7	5, 9, 10, 11	12, 13.1	13.2	14.1, 14.2, 14.3, 14.4	15, 16	17, 18, 19, 20	21	22, 23, 24, 25	26, 27, 28	31, 32	33, 34, 35	36	37	38.1, 38.2, 40.1, 40.2, 41.1	39.1, 41.2		
	Steel <35 HRC	Steel >36-48 HRC	PH and Ferritic Stainless Steel <35 HRC	PH and Ferritic Stainless Steel >35 HRC	Stainless Steel	Gray Cast Iron	Ductile Cast Iron	Wrought Aluminum	Cast Aluminum	Copper, Copper Alloys	Iron Based	Cobalt Based	Nickel Based	Titanium Alloys	Hardened Steels 49-55 HRC	Hardened Steels 56-68 HRC		
<b>Spiral-Point and Left-Hand Spiral-Flute Taps (continued)</b>																		
	★★	★	★		★★	★	★★	★	★★	★★	★						-	-
	★★	★	★		★★	★	★★	★	★★	★★	★						D71	-
	★★	★	★		★★	★	★★	★	★★	★★	★						D72	-
	★★	★	★		★★	★	★★	★	★★	★★	★						-	-
	★★	★	★		★★	★	★★	★	★★	★★	★						-	-
	★		★		★		★	★	★	★							D22-D23	-
	★		★		★		★	★	★	★							D26	-
	★		★		★		★	★	★	★							D26	-
	★		★		★		★	★	★	★							D25	-
	★		★		★		★	★	★	★							D28	-
	★		★		★		★	★	★	★							D24	-
	★	★	★	★	★	★	★	★	★	★							D27	-

INDEXABLE MILLING



















SOLID END MILLING

HOLEMAKING

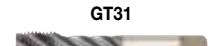
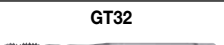
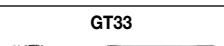
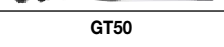
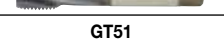
TAPPING

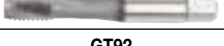
TURNING

## Selection Guide

series	hole		thread		coolant		size range min-max	grade/ coating	material				chamfer		helix angle	dimension
	through	blind	cutting	forming	flood	through			carbide	HSS-E-PM	HSS-E	HSS	type	form		
																
<b>Spiral-Flute Taps</b>																
 GT30		X	X		X		#2-1"	WU32MG, WS34MG	X				semi-bottom	C	45°	ANSI 302A
 GT30		X	X		X		#6-1/2"	WU32MG	X				semi-bottom	C	45°	DIN/ANSI
 GT30		X	X		X		M3-M42	WU32MG, WS34MG	X				semi-bottom	C	45°	DIN 371, 374, 376
 GT30		X	X		X		M24-M42	WU32MG	X				semi-bottom	C	45°	DIN 376, XL
 GT30		X	X		X		M3-M16	WU32MG, WS34MG	X				semi-bottom	C	45°	ANSI 302A
 GT31		X	X			X	1/4-1/2"	WU32MG	X				semi-bottom	C	45°	DIN/ANSI
 GT31		X	X			X	M5-M42	WU32MG, WS34MG	X				semi-bottom	C	45°	DIN 371, 376
 GT31		X	X			X	M24-M42	WU32MG	X				semi-bottom	C	45°	DIN 376, XL
 GT32		X	X		X		M5-M16	WU32MG	X				bottoming	E	45°	DIN 371, 374, 376
 GT33		X	X			X	M5-M16	WU32MG	X				bottoming	E	45°	DIN 371, 374, 376
 GT50		X	X		X		M24-M42	WU32MG	X				semi-bottom	C	15°	DIN 376, XL
 GT51		X	X			X	M24-M42	WU32MG	X				semi-bottom	C	15°	DIN 376, XL
 GT12		X	X		X		M3-M20	WS32MG	X				semi-bottom	C	10°	DIN 371, 376
 GT92		X	X		X		#2-3/4"	WU32MG, WS39MG	X				3-4 pitches	—	11°	ANSI 302A
 GT92		X	X		X		M2.5-M12	WU32MG, WS39MG	X				3-4 pitches	—	11°	ANSI 302A
 GT94		X	X		X		#4-5/8"	WU32MG, WS39MG	X				bottom	E	11°	ANSI 302A
 GT16		X	X		X		M3-M12	WN35MG	X				semi-bottom	C	30°	DIN 371
 GT62		X	X		X		#2-1"	WS34MG	X				semi-bottom	C	10°	ANSI 302A
 GT62		X	X		X		M2.5-M12	WS34MG	X				semi-bottom	C	10°	ANSI 302A

INDEXABLE MILLING

SOLID END MILLING

HOLEMAKING

TAPPING

TURNING

## Selection Guide

	P				M	K		N			S				H		page(s)	recommended cutting parameters
	1, 2, 3, 4, 6, 7	5, 9, 10, 11	12, 13, 1	13.2	14.1, 14.2, 14.3, 14.4	15, 16	17, 18, 19, 20	21	22, 23, 24, 25	26, 27, 28	31, 32	33, 34, 35	36	37	38.1, 38.2, 40.1, 40.2, 41.1	39.1, 41.2		
	Steel <35 HRC	Steel >36-48 HRC	PH and Ferritic Stainless Steel <35 HRC	PH and Ferritic Stainless Steel >35 HRC	Stainless Steel	Gray Cast Iron	Ductile Cast Iron	Wrought Aluminum	Cast Aluminum	Copper, Copper Alloys	Iron Based	Cobalt Based	Nickel Based	Titanium Alloys	Hardened Steels 49-55 HRC	Hardened Steels 56-68 HRC		
<b>Spiral-Flute Taps (continued)</b>																		
	★★★		★★★		★★★		★★	★	★		★★						D101	D126
	★★★		★★★		★★★		★★	★	★		★★						-	-
	★★★		★★★		★★★		★★	★	★		★★						-	-
	★★★		★★★		★★★		★★	★	★		★★						-	-
	★★★		★★★		★★★		★★	★	★		★★						D012	D126
	★★★		★★★		★★★		★★	★	★		★★						-	D126
	★★★		★★★		★★★		★★	★	★		★★						-	D126
	★★★		★★★		★★★		★★	★	★		★★						-	D126
	★★★		★★★		★★★		★★	★	★		★★						-	D126
	★★★		★★★		★★★		★★	★	★		★★						-	D126
												★★★	★★★				D97	-
												★★★	★★★				D117	D126
												★★★	★★★				D116	D126
												★★★	★★★				D118	D126
													★★★				D97	-
													★★★				D107	D126
													★★★				D106	D126

INDEXABLE MILLING





















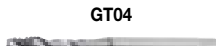

SOLID END MILLING

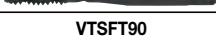
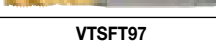
HOLEMAKING

TAPPING

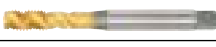
TURNING

## Selection Guide

series	hole		thread		coolant		size range min-max	grade/ coating	material				chamfer		helix angle	dimension
	through	blind	cutting	forming	flood	through			carbide	HSS-E-PM	HSS-E	HSS	type	form		
																
<b>Spiral-Flute Taps (continued)</b>																
 GT80		X	X			X	M3-M20	WN48EG			X		semi-bottom	C	45°	DIN 371, 376
 GT82		X	X			X	#2-1/2"	WN44EG			X		semi-bottom	C	45°	DIN/ANSI
 GT82		X	X			X	M3-M12	WN44EG			X		semi-bottom	C	45°	DIN/ANSI
 GT86		X	X			X	#2-1/2"	WN44EG			X		semi-bottom	C	25°	DIN/ANSI
 GT86		X	X			X	M3-M12	WN44EG			X		semi-bottom	C	25°	DIN/ANSI
 GT02		X	X			X	M3-M20	WP31MG		X			semi-bottom	C	25°	DIN 371, 374, 376
 GT04		X	X			X	M3-M20	WH36MG		X			semi-bottom	C	42°	DIN 371, 374, 376
 VTSFT50		X	X			X	#2-2"	WP42EG, WP49EG, WU41EG			X		semi-bottom	C	45°	ANSI 302A
 VTSFT51		X	X			X	#4-3/4"	WP49EG			X		bottoming	E	45°	ANSI 302A
 VTSFT90		X	X			X	#4-3/4"	WP42EG, WP49EG			X		semi-bottom	C	45°	DIN/ANSI
 VTSFT97		X	X			X	1/4-1"	WP42EG			X		semi-bottom	C	45°	DIN/ANSI
 VTSFT60		X	X			X	#4-1"	WU41EG, WP49EG			X		semi-bottom	C	45°	DIN 371, 376
 VTSFT55		X	X			X	M3-M30	WP42EG, WP49EG, WU41EG			X		semi-bottom	C	45°	ANSI 302A
 VTSFT55		X	X			X	M3-M18	WP49EG			X		bottoming	E	45°	ANSI 302A
 VTSFT65		X	X			X	M2-M33	WP42EG, WP49EG, WU41EG			X		semi-bottom	C	45°	DIN 371, 374, 376
 VTSFT65		X	X			X	M3-M20	WP42EG, WP49EG			X		bottoming	E	45°	DIN 371, 374, 376
 VTSFT95		X	X			X	M3-M20	WP42EG, WP49EG			X		semi-bottom	C	45°	DIN/ANSI
 VTSFT99		X	X			X	M6-M20	WP42EG			X		semi-bottom	C	45°	DIN/ANSI
 VTSFT75		X	X			X	M3-M20	WU41EG			X		semi-bottom	C	45°	JIS

INDEXABLE MILLING

SOLID END MILLING

HOLEMAKING

TAPPING

TURNING

## Selection Guide

	P				M	K		N			S				H		page(s)	recommended cutting parameters
	1, 2, 3, 4, 6, 7	5, 9, 10, 11	12, 13.1	13.2	14.1, 14.2, 14.3, 14.4	15, 16	17, 18, 19, 20	21	22, 23, 24, 25	26, 27, 28	31, 32	33, 34, 35	36	37	38.1, 38.2, 40.1, 40.2, 41.1	39.1, 41.2		
	Steel <35 HRC	Steel >36-48 HRC	PH and Ferritic Stainless Steel <35 HRC	PH and Ferritic Stainless Steel >35 HRC	Stainless Steel	Gray Cast Iron	Ductile Cast Iron	Wrought Aluminum	Cast Aluminum	Copper, Copper Alloys	Iron Based	Cobalt Based	Nickel Based	Titanium Alloys	Hardened Steels 48-55 HRC	Hardened Steels 56-68 HRC		
<b>Spiral-Flute Taps (continued)</b>																		
								***									D97	—
								***	**								D111	D126
								***	**								D110	D126
								***	**								D113	D126
								***	**								D112	D126
		***		***	*	*	*					*					D97	D126
		***		***											***		D97	D126
	**	*	*		**	*	**	*	**	**	*						D78-D79	D126
	**	*	*		**	*	**	*	**	**	*						D79	D126
	**	*	*		**	*	**	*	**	**	*						D74	D126
	**	*	*		**	*	**	*	**	**	*						D77	D126
	**	*	*		**	*	**	*	**	**	*						—	—
	**	*	*		**	*	**	*	**	**	*						D75	—
	**	*	*		**	*	**	*	**	**	*						D80	—
	**	*	*		**	*	**	*	**	**	*						—	—
	**	*	*		**	*	**	*	**	**	*						D76	—
	**	*	*		**	*	**	*	**	**	*						D77	—
	**	*	*		**	*	**	*	**	**	*						—	—

INDEXABLE MILLING

SOLID END MILLING

HOLEMAKING

TAPPING

TURNING



## Selection Guide

















INDEXABLE MILLING

SOLID END MILLING

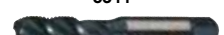
HOLEMAKING

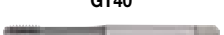
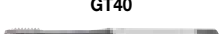
TAPPING

TURNING

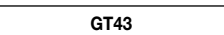
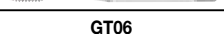
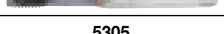
★ ★ ★ ★ ★ ★ Good Better Best	hole		thread		coolant		size range min-max	grade/ coating	material				chamfer		helix angle	dimension
	through	blind	cutting	forming	flood	through			carbide	HSS-E-PM	HSS-E	HSS	type	form		
																
series																
<b>Spiral-Flute Taps (continued)</b>																
	X		X		X		#4-3/4"	TiN, Uncoated			X	plug	—	45°	ANSI 302A	
		X	X		X		#4-3/4"	TiN, Uncoated			X	bottoming	—	45°	ANSI 302A	
	X		X		X		M3-M12	TiN, Uncoated			X	plug	—	45°	ANSI 302A	
		X	X		X		M3-M12	TiN, Uncoated			X	bottom	—	45°	ANSI 302A	
	X		X		X		#10-3/4"	Oxide		X		plug	—	45°	ANSI 302A	
		X	X		X		#6-3/4"	Oxide		X		bottom	—	45°	ANSI 302A	
<b>Straight-Flute Taps</b>																
	X	X	X		X		#10-3/4"	WU32MG	X			semi-bottom	C	0°	ANSI 302A	
	X	X	X		X		#6-1/2"	WU32MG	X			semi-bottom	C	0°	DIN/ANSI	
	X	X	X		X		M3-M16	WU32MG	X			semi-bottom	C	0°	ANSI 302A	
	X	X	X		X		M4-M22	WU32MG	X			semi-bottom	C	0°	DIN 371, 376	
	X	X	X			X	1/4-1/2"	WU32MG	X			semi-bottom	C	0°	DIN/ANSI	
	X	X	X			X	M4-M20	WU32MG	X			semi-bottom	C	0°	DIN 371, 374, 376	
		X	X		X		M5-M20	WU32MG	X			bottoming	E	0°	DIN 371, 374, 376	
		X	X			X	M5-M20	WU32MG	X			bottoming	E	0°	DIN 371, 374, 376	
	X	X	X		X		M6-M16	WS32MG	X			semi-bottom	C	0°	DIN 371, 374, 376	
	X		X		X		#0-12	Oxide, Uncoated		X		taper	—	0°	ANSI 302	

## Selection Guide

	P				M	K		N			S				H		page(s)	recommended cutting parameters
	1, 2, 3, 4, 6, 7	5, 9, 10, 11	12, 13, 1	13.2	14.1, 14.2, 14.3, 14.4	15, 16	17, 18, 19, 20	21	22, 23, 24, 25	26, 27, 28	31, 32	33, 34, 35	36	37	38.1, 38.2, 40.1, 40.2, 41.1	39.1, 41.2		
	Steel <35 HRC	Steel >36-48 HRC	PH and Ferritic Stainless Steel <35 HRC	PH and Ferritic Stainless Steel >35 HRC	Stainless Steel	Gray Cast Iron	Ductile Cast Iron	Wrought Aluminum	Cast Aluminum	Copper, Copper Alloys	Iron Based	Cobalt Based	Nickel Based	Titanium Alloys	Hardened Steels 49-55 HRC	Hardened Steels 56-68 HRC		
<b>Spiral-Flute Taps (continued)</b>																		
	★		★		★		★	★	★	★							D30	—
	★		★		★		★	★	★	★							D31	—
	★		★		★		★	★	★	★							D29	—
	★		★		★		★	★	★	★							D29	—
	★		★		★		★	★	★	★							—	—
	★		★		★		★	★	★	★							D32	—
<b>Straight-Flute Taps (continued)</b>																		
						★★★	★★★		★★★	★★							D103	D126
						★★★	★★★		★★★	★★							—	—
						★★★	★★★		★★★	★★							—	—
						★★★	★★★		★★★	★★							—	—
						★★★	★★★		★★★	★★							—	D126
						★★★	★★★		★★★	★★							—	D126
						★★★	★★★		★★★	★★							—	D126
						★★★	★★★		★★★	★★							—	D126
															★★★		D97	D126
	★		★		★	★	★	★	★	★							D37	—

INDEXABLE MILLING















SOLID END MILLING

HOLEMAKING

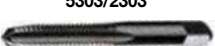
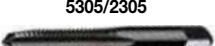
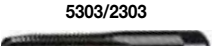
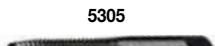
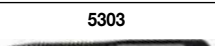
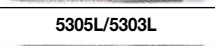
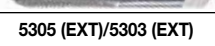
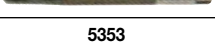
TAPPING

TURNING

## Selection Guide

★ Good ★★ Better ★★★ Best	hole		thread		coolant		size range min-max	grade/ coating	material				chamfer		helix angle	dimension
	through	blind	cutting	forming	flood	through			carbide	HSS-E-PM	HSS-E	HSS	type	form		
																
<b>Straight-Flute Taps (continued)</b>																
	X		X		X		1/4-1-1/2"	Oxide, Uncoated				X	taper	—	0°	ANSI 302
	X		X		X		M2-M36	Uncoated				X	taper	—	0°	ANSI 302
	X		X		X		#0-12	TiCN, TiN, Oxide, Uncoated				X	plug	—	0°	ANSI 302
	X		X		X		1/4-1-1/2"	TiCN, TiN, Oxide, Uncoated				X	plug	—	0°	ANSI 302
		X	X		X		#0-12	TiCN, TiN, Oxide, Uncoated				X	bottom	—	0°	ANSI 302
		X	X		X		1/4-1-1/2"	TiCN, TiN, Oxide, Uncoated				X	bottom	—	0°	ANSI 302
	X	X	X		X		#0-12	Uncoated				X	taper, plug, & bottoming	—	0°	ANSI 302
	X	X	X		X		1/4-1-1/2"	Uncoated				X	taper, plug, & bottoming	—	0°	ANSI 302
	X	X	X		X		1/4-3/4"	Uncoated				X	taper, plug, & bottoming	—	0°	ANSI 302
	X	X	X		X		#6-3/8"	Uncoated				X	bottoming	—	0°	ANSI 302
	X		X		X		M1.6-M36	TiCN, TiN, Uncoated				X	plug	—	0°	ANSI 302
	X	X	X		X		M3-M20	Uncoated				X	taper, plug, & bottoming	—	0°	ANSI 302
		X	X		X		M3-M36	TiCN, TiN, Uncoated				X	bottoming	—	0°	ANSI 302
	X	X	X		X		#4-12	Uncoated				X	taper, plug, & bottoming	—	0°	ANSI 302
	X	X	X		X		1/4-1-1/2"	Uncoated				X	taper, plug, & bottoming	—	0°	ANSI 302
	X	X	X		X		M6-M24	Uncoated				X	taper, plug, & bottoming	—	0°	ANSI 302

INDEXABLE MILLING

SOLID END MILLING

HOLEMAKING

TAPPING

TURNING

## Selection Guide

	P				M	K		N			S				H		page(s)	recommended cutting parameters
	1, 2, 3, 4, 6, 7	5, 9, 10, 11	12, 13.1	13.2	14.1, 14.2, 14.3, 14.4	15, 16	17, 18, 19, 20	21	22, 23, 24, 25	26, 27, 28	31, 32	33, 34, 35	36	37	38.1, 38.2, 40.1, 40.2, 41.1	39.1, 41.2		
	Steel <35 HRC	Steel >36-48 HRC	PH and Ferritic Stainless Steel <35 HRC	PH and Ferritic Stainless Steel >35 HRC	Stainless Steel	Gray Cast Iron	Ductile Cast Iron	Wrought Aluminum	Cast Aluminum	Copper, Copper Alloys	Iron Based	Cobalt Based	Nickel Based	Titanium Alloys	Hardened Steels 48-55 HRC	Hardened Steels 56-68 HRC		
<b>Straight-Flute Taps (continued)</b>																		
	★		★		★	★	★	★	★	★							D33	—
	★		★		★	★	★	★	★	★							D40	—
	★		★		★	★	★	★	★	★							D38	—
	★		★		★	★	★	★	★	★							D34-D35	—
	★		★		★	★	★	★	★	★							D39	—
	★		★		★	★	★	★	★	★							D36	—
	★		★		★	★	★	★	★	★							D48	—
	★		★		★	★	★	★	★	★							D47	—
	★	★	★	★	★	★	★	★	★	★							D49	—
	★	★	★	★	★	★	★	★	★	★							D43	—
	★		★		★	★	★	★	★	★							D42	—
	★		★		★	★	★	★	★	★							D45	—
	★		★		★	★	★	★	★	★							D41	—
	★	★	★	★	★	★	★	★	★	★							D46	—
	★	★	★	★	★	★	★	★	★	★							D44	—
	★	★	★	★	★	★	★	★	★	★							D46	—

INDEXABLE MILLING













SOLID END MILLING

HOLEMAKING

TAPPING

TURNING

## Selection Guide

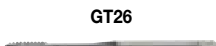
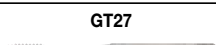
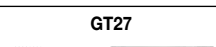
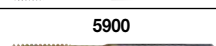
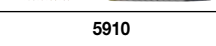
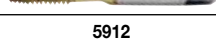
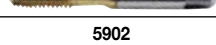
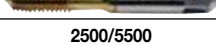
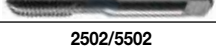
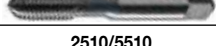
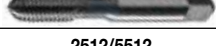
series	hole		thread		coolant		size range min-max	grade/ coating	material				chamfer		helix angle	dimension
	through	blind	cutting	forming	flood	through			carbide	HSS-E-PM	HSS-E	HSS	type	form		
																
<b>Form Taps</b>																
 GT22	X	X		X	X		M3-M16	WP31MG, WN38MG	X				semi- bottom	C	—	DIN 2174
 GT23	X	X		X		X	M5-M16	WP31MG, WN38MG	X				semi- bottom	C	—	DIN 2174
 GT24	X	X		X	X		#6-3/4"	WU32MG	X				semi- bottom	C	—	DIN/ANSI
 GT24	X	X		X	X		M3-M16	WU32MG	X				semi- bottom	C	—	DIN/ANSI
 GT25	X	X		X		X	1/4-3/4"	WU32MG	X				semi- bottom	C	—	DIN/ANSI
 GT25	X	X		X		X	M6-M16	WU32MG	X				semi- bottom	C	—	DIN/ANSI
 GT26		X		X	X		#0-3/4"	WU32MG	X				bottom	E	—	DIN/ANSI
 GT26		X		X	X		M3-M16	WU32MG	X				bottom	E	—	DIN/ANSI
 GT27		X		X		X	1/4-3/4"	WU32MG	X				bottom	E	—	DIN/ANSI
 GT27		X		X		X	M6-M16	WU32MG	X				bottom	E	—	DIN/ANSI
 5900	X			X	X		#6-1/2"	TiCN, TiN, Uncoated				X	plug	D	—	ANSI 302A
 5910	X			X	X		M6-M10	TiCN, TiN, Uncoated				X	plug	D	—	ANSI 302A
 5912		X		X	X		M4-M12	TiCN, TiN, Uncoated				X	bottoming	E	—	ANSI 302A
 5902		X		X	X		#6-1/2"	TiCN, TiN, Uncoated				X	bottoming	E	—	ANSI 302A
 2500/5500	X			X	X		#4-3/4"	TiN, Uncoated				X	plug	D	—	ANSI 302A
 2502/5502		X		X	X		#0-5/8"	TiCN, TiN, Uncoated				X	bottoming	E	—	ANSI 302A
 2510/5510	X			X	X		M3-M12	TiN, Uncoated				X	plug	D	—	ANSI 302A
 2512/5512		X		X	X		M3-M12	TiCN, TiN, Uncoated				X	bottoming	E	—	ANSI 302A

INDEXABLE MILLING

SOLID END MILLING

HOLEMAKING

TAPPING

TURNING

## Selection Guide

	P				M	K		N			S				H		page(s)	recommended cutting parameters
	1, 2, 3, 4, 6, 7	5, 9, 10, 11	12, 13.1	13.2	14.1, 14.2, 14.3, 14.4	15, 16	17, 18, 19, 20	21	22, 23, 24, 25	26, 27, 28	31, 32	33, 34, 35	36	37	38.1, 38.2, 40.1, 40.2, 41.1	39.1, 41.2		
	Steel <35 HRC	Steel >36-48 HRC	PH and Ferritic Stainless Steel <35 HRC	PH and Ferritic Stainless Steel >35 HRC	Stainless Steel	Gray Cast Iron	Ductile Cast Iron	Wrought Aluminum	Cast Aluminum	Copper, Copper Alloys	Iron Based	Cobalt Based	Nickel Based	Titanium Alloys	Hardened Steels 49-55 HRC	Hardened Steels 56-68 HRC		
<b>Form Taps (continued)</b>																		
	***							***	**								-	D126
	***							***	**								-	D126
	***				**												D119	D126
	***				**												D120	D126
	***				**												D121	-
	***				**												D122	-
	***				**												D123	D126
	***				**												D124	D126
	***				**												-	-
	***				**												-	-
	*				*			*	*	*							D58	-
	*				*			*	*	*							D60	-
	*				*			*	*	*							D60	-
	*				*			*	*	*							D59	-
	*				*			*	*	*							D55	-
	*				*			*	*	*							D56	-
	*				*			*	*	*							D57	-
	*				*			*	*	*							D57	-

INDEXABLE MILLING











SOLID END MILLING

HOLEMAKING

TAPPING

TURNING

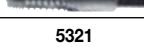
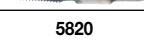
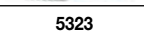
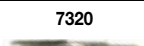
## Selection Guide

series	hole		thread		coolant		size range min-max	grade/ coating	material				chamfer		helix angle	dimension
	through	blind	cutting	forming	flood	through			carbide	HSS-E-PM	HSS-E	HSS	type	form		
																
<b>Good</b>																
<b>Better</b>	★★															
<b>Best</b>	★★★															
<b>Pipe Taps</b>																
<b>VTSFT80</b> 	X	X	X		X		1/16-1"	WU40EG, WP49EG, WU41EG			X		standard	-	-	ANSI
<b>VTSTR</b> 	X	X	X		X		1/8-3/4"	WU40EG			X		standard	-	-	ANSI
<b>2320/5320</b> 	X	X	X		X		1/16-2"	TiN, Oxide, Uncoated			X		standard	-	-	ANSI
<b>5319</b> 	X	X	X		X		#1/8-2"	Oxide, Uncoated			X		standard	-	-	ANSI
<b>5321</b> 	X	X	X		X		1/8-1/2"	Uncoated			X		standard	-	-	ANSI
<b>5820</b> 	X	X	X		X		1/4-1"	Uncoated			X		standard	-	-	ANSI
<b>5323</b> 	X	X	X		X		1/8-1"	Uncoated			X		standard	-	-	ANSI
<b>7320</b> 	X	X	X		X		1/8-2"	Uncoated			X		standard	-	-	ANSI

INDEXABLE MILLING

SOLID END MILLING

HOLEMAKING

TAPPING

TURNING

## Selection Guide

	P				M	K		N			S				H		page(s)	recommended cutting parameters
	1, 2, 3, 4, 6, 7	5, 9, 10, 11	12, 13.1	13.2	14.1, 14.2, 14.3, 14.4	15, 16	17, 18, 19, 20	21	22, 23, 24, 25	26, 27, 28	31, 32	33, 34, 35	36	37	38.1, 38.2, 40.1, 40.2, 41.1	39.1, 41.2		
	Steel <35 HRC	Steel >36-48 HRC	PH and Ferritic Stainless Steel <35 HRC	PH and Ferritic Stainless Steel >35 HRC	Stainless Steel	Gray Cast Iron	Ductile Cast Iron	Wrought Aluminum	Cast Aluminum	Copper, Copper Alloys	Iron Based	Cobalt Based	Nickel Based	Titanium Alloys	Hardened Steels 49-55 HRC	Hardened Steels 56-68 HRC		
<b>Pipe Taps (continued)</b>																		
	★ ★	★	★		★ ★	★	★ ★	★	★ ★	★ ★	★						D86	—
	★ ★					★											D87	—
	★					★	★	★	★	★							D50	—
	★					★	★	★	★	★							D51	—
	★					★	★	★	★	★							—	—
	★							★	★	★							D53	—
	★				★	★	★	★	★	★							D52	—
	★	★	★	★	★	★	★	★	★	★							D54	—

INDEXABLE MILLING

SOLID END MILLING

HOLEMAKING

TAPPING

TURNING



# General-Purpose Taps

HSS

General-Purpose Taps are made of high-speed steel, which provides high toughness by utilizing strong coatings and surface treatments, enhancing the wear resistance and ability to perform in all workpiece materials.

**Spiral point GUN™ taps** shoot chips ahead of the cutting action to reduce overloading and clogging in flutes, protecting the workpiece.

**Multicoating/surface treatment options** to suit customer-specific needs

**HSS**  
Extremely tough material which enables to be used in demanding conditions

**Versatile spiral-flute design** for pulling chips out of the hole

The general-purpose taps are designed as per ANSI standards, offering a complete portfolio of straight-fluted, spiral point gun, spiral-fluted, taper pipe, true-ledge form taps hand and hand tap sets.

## GRADES

TiCN		
	P	●
	M	○
	K	○
	N	○
	S	
	H	

TiN		
	P	●
	M	○
	K	○
	N	○
	S	
	H	

Oxide		
	P	●
	M	●
	K	●
	N	●
	S	
	H	

Uncoated		
	P	●
	M	○
	K	○
	N	○
	S	
	H	

# GENERAL-PURPOSE, VERSATILE, ALL-APPLICATION PRODUCT



## PRODUCT

GP Taps are the go-to product for affordability and versatility

## INDUSTRY



## MATERIALS



## APPLICATIONS



THROUGH HOLE



BLIND HOLE



THREAD



FLOOD COOLANT: TAPPING



ANSI UNC



ANSI UNF



MANUFACTURER'S SPECS: M



HSS

### STYLE

Spiral-Point and Left-Hand Spiral-Flute

Spiral Flute

Forming Taps

Straight-Flute and Spiral-Flute Pipe Taps

### TYPE

Production Gun Taps

Production Taps

TRU-LEDE™ Fe Taps

NPT, ANPT, NPTF, NPS, NPSF

*In sizes Machine Screw and Fractional, Metric ANSI.*

## Shank Style

Ground h9 with square end.



Series 5301/2301 • Spiral Point, Plug Chamfer

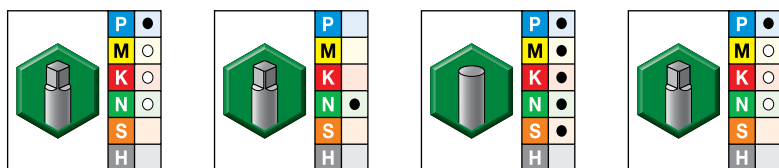
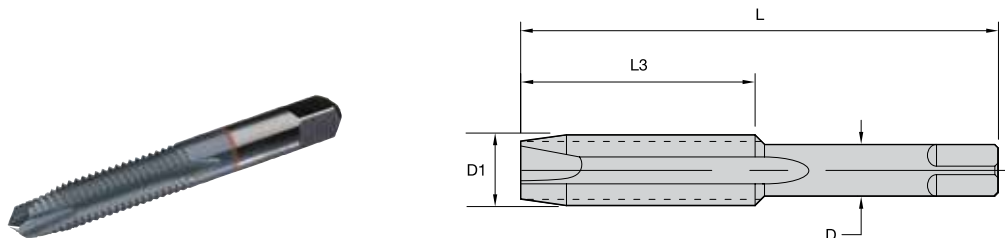

● first choice  
○ alternate choice

TICN		uncoated		oxide		TIN		D1 size	L	L3	D	number of flutes	pitch diameter limit
order #	catalog #	order #	catalog #	order #	catalog #	order #	catalog #						
2746991	19011	2750249	13202	2750325	13111	2747016	19001	0 - 80	1.63	.31	.141	2	H2
-	-	2750246	13204	-	-	-	-	1 - 64	1.69	.38	.141	2	H2
-	-	2750241	13206	2750324	13115	-	-	1 - 72	1.69	.38	.141	2	H2
2746990	19012	2867063	13208	2750321	13117	2747001	19006	2 - 56	1.75	.44	.141	2	H2
-	-	2867066	13207	-	-	-	-	2 - 56	1.75	.44	.141	2	H1
-	-	2750238	13211	-	-	-	-	2 - 64	1.75	.44	.141	2	H2
-	-	2750236	13213	2750319	13119	2746999	19007	3 - 48	1.81	.50	.141	2	H2
-	-	2750231	13215	-	-	-	-	3 - 56	1.81	.50	.141	2	H2
-	-	2750230	13217	2750313	13126	-	-	4 - 36	1.88	.56	.141	2	H2
2746988	19013	2750228	13219	2750316	13123	2746982	19016	4 - 40	1.88	.56	.141	2	H2
-	-	2750225	13223	-	-	-	-	4 - 48	1.88	.56	.141	2	H2
2746986	19014	2750220	13225	2750312	13128	2746972	19021	5 - 40	1.94	.63	.141	2	H2
3171117	19464	2750218	13229	-	-	-	-	5 - 44	1.94	.63	.141	2	H2
-	-	2750210	13232	2750306	13132	2746946	19036	6 - 32	2.00	.69	.141	2	H3
-	-	2750212	13231	2750309	13131	2746954	19031	6 - 32	2.00	.69	.141	2	H2
-	-	2750209	13235	-	-	-	-	6 - 32	2.00	.69	.141	2	H7
2746944	19037	2750206	13237	-	-	2746942	19038	6 - 40	2.00	.69	.141	2	H2
-	-	2750202	13241	2750302	13136	2746941	19039	8 - 32	2.13	.75	.168	2	H2
-	-	2750199	13242	2750300	13137	2746928	19046	8 - 32	2.13	.75	.168	2	H3
-	-	2750204	13240	-	-	-	-	8 - 32	2.13	.75	.168	2	H1
-	-	2750195	13244	-	-	-	-	8 - 32	2.13	.75	.168	2	H7
-	-	2750193	13246	3047408	13139	-	-	8 - 36	2.13	.75	.168	2	H2
2746984	19015	2409831	13251	2750293	13142	2746913	19056	10 - 24	2.38	.88	.194	2	H3
-	-	2750190	13250	2750294	13141	-	-	10 - 24	2.38	.88	.194	2	H2
-	-	2750192	13249	-	-	-	-	10 - 24	2.38	.88	.194	2	H1
-	-	2750177	13256	2750291	13145	2746899	19069	10 - 32	2.38	.88	.194	2	H2
-	-	2750175	13257	2750290	13146	2746897	19071	10 - 32	2.38	.88	.194	2	H3
-	-	2750179	13255	-	-	-	-	10 - 32	2.38	.88	.194	2	H1
-	-	2750165	13260	-	-	-	-	10 - 32	2.38	.88	.194	2	H7
2746980	19017	2750160	13262	2750287	13148	2746889	19076	12 - 24	2.38	.94	.220	2	H3
3171130	19482	2750159	13264	2750286	13149	-	-	12 - 28	2.38	.94	.220	2	H3
-	-	2750154	13269	2750284	13151	2863790	19079	1/4 - 20	2.50	1.00	.255	2	H2
3171133	19485	2750152	13270	2750282	13152	2746879	19086	1/4 - 20	2.50	1.00	.255	2	H3
-	-	2750148	13272	2750280	13154	2746877	19088	1/4 - 20	2.50	1.00	.255	3	H3
-	-	2750156	13268	-	-	-	-	1/4 - 20	2.50	1.00	.255	2	H1
-	-	2750143	13273	-	-	2746869	19096	1/4 - 20	2.50	1.00	.255	2	H5
-	-	2750141	13274	-	-	-	-	1/4 - 20	2.50	1.00	.255	3	H5
-	-	2750128	13280	2750277	13158	2746865	19101	1/4 - 28	2.50	1.00	.255	2	H3
-	-	2750135	13277	-	-	-	-	1/4 - 28	2.50	1.00	.255	2	H1
-	-	2750132	13278	-	-	-	-	1/4 - 28	2.50	1.00	.255	2	H2
2746978	19018	2750129	13279	-	-	-	-	1/4 - 28	2.50	1.00	.255	3	H2
-	-	2750119	13282	-	-	-	-	1/4 - 28	2.50	1.00	.255	2	H4
3171144	19498	2750111	13291	2750276	13164	1916977	19106	5/16 - 18	2.72	1.13	.318	2	H3
2746976	19019	2750109	13293	1830468	13166	3171095	19384	5/16 - 18	2.72	1.13	.318	3	H3
-	-	2750115	13289	-	-	-	-	5/16 - 18	2.72	1.13	.318	2	H1
-	-	2750112	13290	-	-	-	-	5/16 - 18	2.72	1.13	.318	2	H2
-	-	2750105	13294	-	-	-	-	5/16 - 18	2.72	1.13	.318	2	H5
-	-	2750103	13295	-	-	-	-	5/16 - 18	2.72	1.13	.318	3	H5

INDEXABLE MILLING

SOLID END MILLING

HOLEMAKING

TAPPING

TURNING

Series 5301/2301 • Spiral Point, Plug Chamfer

(continued)

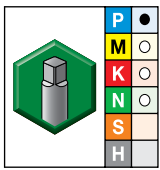
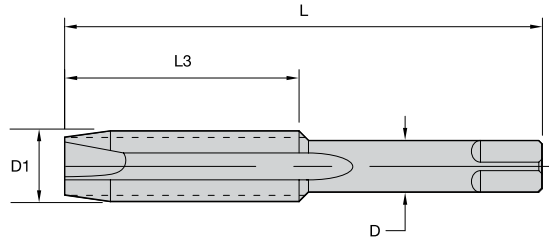

TiCN

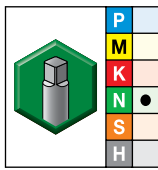

uncoated

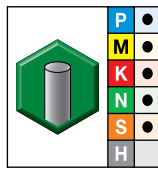

oxide

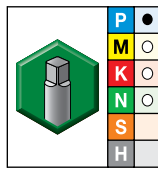

TiN

● first choice  
○ alternate choice

order #	catalog #	order #	catalog #	order #	catalog #	order #	catalog #	D1 size	L	L3	D	number of flutes	pitch diameter limit
-	-	2750088	13300	2750271	13170	2746857	19108	5/16 - 24	2.72	1.13	.318	2	H3
-	-	2750094	13298	-	-	-	-	5/16 - 24	2.72	1.13	.318	2	H2
2746974	19020	2750084	13303	-	-	-	-	5/16 - 24	2.72	1.13	.318	3	H4
2746970	19022	2750078	13307	2750268	13176	2746855	19111	3/8 - 16	2.94	1.25	.381	3	H3
-	-	2750082	13305	-	-	-	-	3/8 - 16	2.94	1.25	.381	3	H1
-	-	2750080	13306	-	-	-	-	3/8 - 16	2.94	1.25	.381	3	H2
3171152	19509	2750075	13309	-	-	-	-	3/8 - 16	2.94	1.25	.381	3	H5
2746968	19023	2750067	13313	2750266	13180	2746853	19112	3/8 - 24	2.94	1.25	.381	3	H3
-	-	2750066	13315	-	-	-	-	3/8 - 24	2.94	1.25	.381	3	H4
2746966	19024	2750060	13319	2750264	13183	1893987	19113	7/16 - 14	3.16	1.44	.323	3	H3
-	-	2750058	13320	-	-	-	-	7/16 - 14	3.16	1.44	.323	3	H5
2746964	19025	2750055	13324	2750262	13185	2746849	19114	7/16 - 20	3.16	1.44	.323	3	H3
-	-	2750054	13325	-	-	-	-	7/16 - 20	3.16	1.44	.323	3	H5
2746962	19026	2750052	13328	2750261	13189	2746847	19116	1/2 - 13	3.38	1.66	.367	3	H3
-	-	2750053	13327	-	-	-	-	1/2 - 13	3.38	1.66	.367	3	H2
-	-	2750047	13330	-	-	-	-	1/2 - 13	3.38	1.66	.367	3	H5
2746960	19027	2750040	13334	2750259	13193	2746845	19117	1/2 - 20	3.38	1.66	.367	3	H3
2746958	19028	2750036	13339	2750257	13195	2746843	19118	5/8 - 11	3.81	1.81	.480	3	H3
-	-	2750032	13340	-	-	-	-	5/8 - 11	3.81	1.81	.480	3	H5
-	-	2750028	13342	2750255	13199	-	-	5/8 - 18	3.81	1.81	.480	3	H3
2746956	19029	2750024	13343	2750256	13197	2746841	19119	3/4 - 10	4.25	2.00	.590	3	H3
-	-	2750023	13344	-	-	-	-	3/4 - 10	4.25	2.00	.590	3	H5

NOTE: GUN taps for 3B class of fit are suitable for UNJ aerospace internal threading applications.

INDEXABLE MILLING

SOLID END MILLING

HOLEMAKING

TAPPING

TURNING

Series 5351/2351 • Metric ANSI • Spiral Point, Plug Chamfer

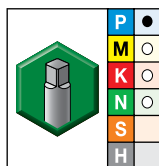
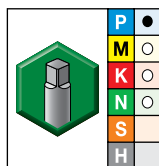
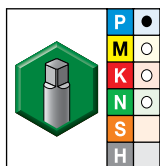
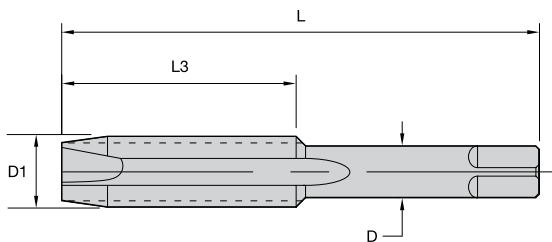

● first choice  
○ alternate choice

TICN		uncoated		TIN		D1 size	L	L3	D	number of flutes	pitch diameter limit
order #	catalog #	order #	catalog #	order #	catalog #						
-	-	2750021	13365	-	-	M1,6 X 0,35	1.63	.31	.141	2	D3
-	-	2750018	13367	-	-	M2 X 0,4	1.75	.44	.141	2	D3
-	-	2750017	13369	-	-	M2,5 X 0,45	1.81	.50	.141	2	D3
2747014	19002	2750015	13371	2746278	19920	M3 X 0,5	1.94	.63	.141	2	D3
-	-	2750013	13373	-	-	M3,5 X 0,6	2.00	.69	.141	2	D4
-	-	2750012	13375	2746276	19921	M4 X 0,7	2.13	.75	.168	2	D4
-	-	2750010	13377	-	-	M4,5 X 0,75	2.38	.88	.194	2	D4
2747010	19004	2750009	13379	2746274	19922	M5 X 0,8	2.38	.88	.194	2	D4
-	-	2750005	13381	2746272	19923	M6 X 1	2.50	1.00	.255	2	D5
-	-	2750002	13382	-	-	M6,3 X 1	2.50	1.00	.255	2	D5
-	-	2750000	13383	-	-	M7 X 1	2.72	1.13	.318	2	D5
2746997	19008	2749995	13385	2746270	19924	M8 X 1,25	2.72	1.13	.318	2	D5
2746995	19009	2749991	13389	2746268	19925	M10 X 1,5	2.94	1.25	.381	3	D6
2746993	19010	2749985	13393	2746266	19926	M12 X 1,75	3.38	1.66	.367	3	D6
-	-	2749982	13397	-	-	M14 X 2	3.59	1.66	.429	3	D7
-	-	2749979	13401	-	-	M16 X 2	3.81	1.81	.480	3	D7
-	-	2749977	13405	-	-	M18 X 2,5	4.03	1.81	.542	3	D7
-	-	2749975	13409	-	-	M20 X 2,5	4.47	2.00	.652	3	D7

NOTE: Metric taps for 6H class of fit are suitable for MJ aerospace internal threading applications.  
Metric taps are manufactured to USCTI specifications and dimensions.  
Metric tap blank dimensions are equivalent to inch taps.  
Metric D limits suitable for ISO 6H tolerance class.  
Refer to tables on page D128 for the recommended pitch diameter limit for 6H class of fit.

INDEXABLE MILLING

SOLID END MILLING

HOLEMAKING

TAPPING

TURNING

Series 5601 • Machine Screw and Fractional Heavy Duty • Spiral Point, Plug Chamfer

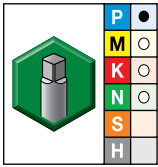
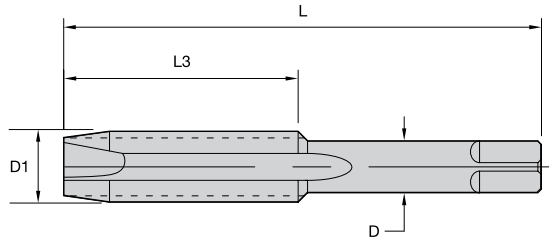

- first choice
- alternate choice

oxide/nitride		D1 size	L	L3	D	number of flutes	pitch diameter limit
order #	catalog #						
2864368	16802	6 - 32	2.00	.69	.141	3	H3
2747975	16805	8 - 32	2.13	.75	.168	3	H3
2864362	16807	10 - 24	2.38	.88	.194	3	H3
2864359	16809	10 - 32	2.38	.88	.194	3	H3
2864356	16810	1/4 - 20	2.50	1.00	.255	3	H3
2747973	16812	1/4 - 28	2.50	1.00	.255	3	H3
2747971	16814	5/16 - 18	2.72	1.13	.318	3	H3
2747967	16818	3/8 - 16	2.94	1.25	.381	3	H3
2747965	16820	3/8 - 24	2.94	1.25	.381	3	H3
2747959	16826	1/2 - 13	3.38	1.66	.367	3	H3

NOTE: GUN™ taps for 3B class of fit are suitable for UNJ aerospace internal threading applications. Refer to tables on pages D127-D128 for the recommended pitch diameter limit for 2B or 3B class of fit.

INDEXABLE MILLING

SOLID END MILLING

HOLE/MAKING

TAPPING

TURNING

Series 5301F • Fractional Sizes • Spiral Point, Plug Chamfer • Oversized

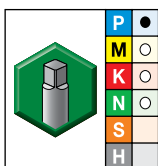
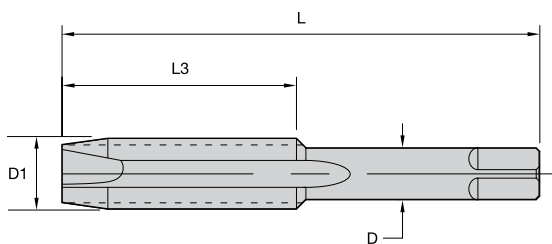

● first choice  
○ alternate choice

uncoated		D1 size	L	L3	D	number of flutes	pitch diameter limit
order #	catalog #						
2750139	13275	1/4 - 20	2.50	1.00	.255	2	H11
2750101	13296	5/16 - 18	2.72	1.13	.318	2	H11
2750074	13310	3/8 - 16	2.94	1.25	.381	3	H11
2750046	13331	1/2 - 13	3.38	1.66	.367	3	H11
2750029	13341	5/8 - 11	3.81	1.81	.480	3	H11

NOTE: Refer to tables on pages D127-D128 for the recommended pitch diameter limit for 2B or 3B class of fit.

Series 5301 • Fractional Sizes • Spiral Point, Plug Chamfer • 6" Extension

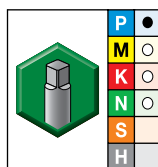
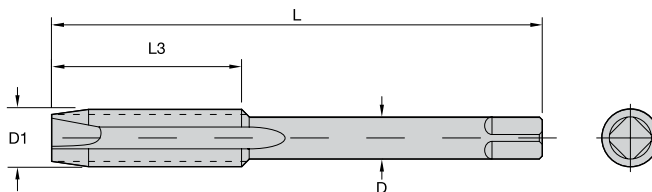

● first choice  
○ alternate choice

uncoated		D1 size	L	L3	D	number of flutes	pitch diameter limit
order #	catalog #						
2747033	18932	8 - 32	6.00	.75	.168	2	H3
2747031	18934	10 - 24	6.00	.88	.194	2	H3
2747029	18935	10 - 32	6.00	.88	.194	2	H3
2747028	18936	1/4 - 20	6.00	1.00	.255	2	H3
2747026	18937	1/4 - 28	6.00	1.00	.255	2	H3
2747024	18938	5/16 - 18	6.00	1.13	.318	2	H3
2747020	18940	3/8 - 16	6.00	1.25	.381	3	H3
2747018	18941	3/8 - 24	6.00	1.25	.381	3	H3

NOTE: Also available in Hand Tap Series 5305 and 5303.  
GUN™ taps for 3B class of fit are suitable for UNJ aerospace internal threading applications.  
Refer to tables on pages D127-D128 for the recommended pitch diameter limit for 2B or 3B class of fit.

Series 7301 • Plug Chamfer

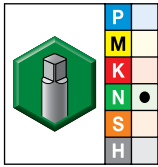
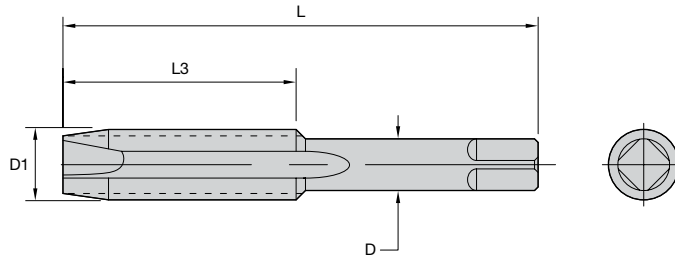

- first choice
- alternate choice

uncoated		D1 size	L	L3	D	class of fit
order #	catalog #					
2750393	12027	4 - 40	1.88	.56	.141	2B
2750387	12032	6 - 32	2.00	.69	.141	2B
2750384	12034	8 - 32	2.15	.75	.168	2B
2750381	12036	10 - 24	2.38	.88	.194	2B
2750379	12037	10 - 32	2.38	.88	.194	2B
2750377	12038	12 - 24	2.38	.94	.220	2B
2750375	12040	1/4 - 20	2.50	1.00	.255	2B
2750374	12041	1/4 - 28	2.50	1.00	.255	2B
2750373	12042	5/16 - 18	2.72	1.13	.318	2B
2750371	12043	5/16 - 24	2.72	1.13	.318	2B
2750370	12044	3/8 - 16	2.94	1.25	.381	2B
2750369	12045	3/8 - 24	2.94	1.25	.381	2B
2750367	12046	7/16 - 14	3.16	1.44	.323	2B
2750364	12047	7/16 - 20	3.16	1.44	.323	2B
2750363	12048	1/2 - 13	3.38	1.66	.367	2B
2750360	12049	1/2 - 20	3.38	1.66	.367	2B
2750359	12050	5/8 - 11	3.81	1.81	.480	2B
2750357	12051	5/8 - 18	3.81	1.81	.480	2B
2750356	12052	3/4 - 10	4.25	1.81	.590	2B

INDEXABLE MILLING

SOLID END MILLING

HOLEMAKING

TAPPING

TURNING



Series 5302 • Machine Screw and Fractional • Spiral Point, Bottoming Chamfer

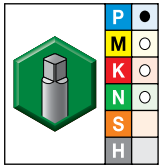
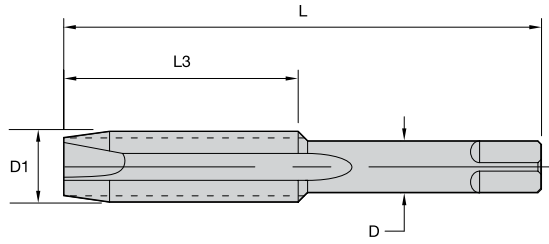

● first choice  
○ alternate choice

uncoated		D1 size	L	L3	D	number of flutes	pitch diameter limit
order #	catalog #						
2749944	13602	0 - 80	1.63	.31	.141	2	H2
2749943	13606	2 - 56	1.75	.44	.141	2	H2
2749939	13614	4 - 40	1.88	.56	.141	2	H2
2749936	13617	5 - 40	1.94	.63	.141	2	H2
2749935	13619	6 - 32	2.00	.69	.141	2	H2
2749932	13620	6 - 32	2.00	.69	.141	2	H3
2749931	13623	6 - 40	2.00	.69	.141	2	H2
2749926	13625	8 - 32	2.13	.75	.168	2	H2
2749924	13626	8 - 32	2.13	.75	.168	2	H3
2866734	13629	10 - 24	2.38	.88	.194	2	H2
2749920	13630	10 - 24	2.38	.88	.194	2	H3
2749919	13633	10 - 32	2.38	.88	.194	2	H2
2866726	13634	10 - 32	2.38	.88	.194	2	H3
2749916	13636	12 - 24	2.38	.94	.220	2	H3
2749915	13638	1/4 - 20	2.50	1.00	.255	2	H3
2749914	13639	1/4 - 28	2.50	1.00	.255	2	H3
2749912	13641	5/16 - 18	2.72	1.13	.318	2	H3
2749909	13642	5/16 - 24	2.72	1.13	.318	2	H3

NOTE: Refer to tables on pages D127-D128 for the recommended pitch diameter limit for 2B or 3B class of fit.

INDEXABLE MILLING

SOLID END MILLING

HOLEMAKING

TAPPING

TURNING

Series 2364/5364 • Metric ANSI • Plug Chamfer

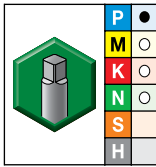
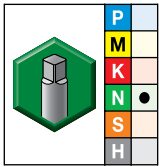
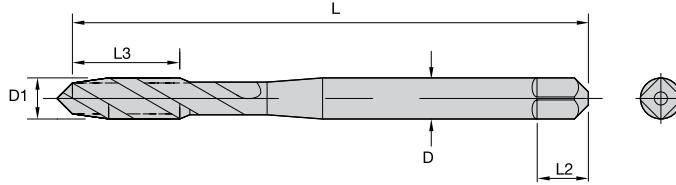

- first choice
- alternate choice

uncoated		TiN		D1 size	L	L2	L3	D	number of flutes	pitch diameter limit
order #	catalog #	order #	catalog #							
2748302	16053	2746264	19927	M3 X 0,5	1.94	—	.31	.141	2	D3
2748297	16057	2746260	19929	M4 X 0,7	2.13	.75	.38	.168	3	D4
2748295	16061	—	—	M5 X 0,8	2.38	.88	.50	.194	3	D4
2748291	16063	2746252	19933	M6 X 1	2.50	1.00	.63	.255	3	D5
2748285	16069	2746248	19935	M8 X 1,25	2.72	1.12	.69	.318	3	D5
2748281	16071	2746244	19937	M10 X 1,5	2.94	1.25	.75	.381	3	D6
2748273	16073	2746240	19939	M12 X 1,75	3.38	—	.94	.367	3	D6

NOTE: Metric D limits are suitable for ISO 6H tolerance class.  
 Metric taps are manufactured to USCTI specifications and dimensions.  
 Metric tap blank dimensions are equivalent to inch taps.  
 Refer to tables on pages D128 for the recommended pitch diameter limit for 6H class of fit.

Series 2364/5364 • Metric ANSI • Bottoming Chamfer

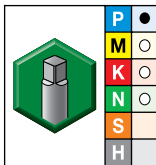
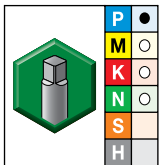
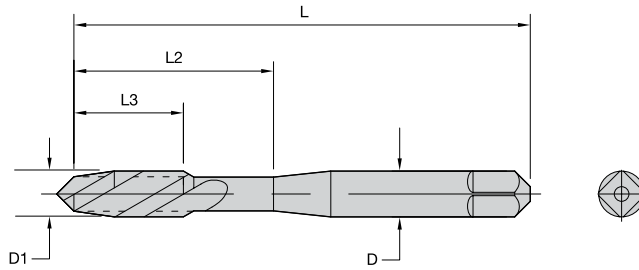

- first choice
- alternate choice

uncoated		TiN		D1 size	L	L2	L3	D	number of flutes	pitch diameter limit
order #	catalog #	order #	catalog #							
2748300	16054	2746262	19928	M3 X 0,5	1.94	—	.31	.141	2	D3
2748296	16058	2746258	19930	M4 X 0,7	2.13	.75	.38	.168	3	D4
2748293	16062	2746254	19932	M5 X 0,8	2.38	.88	.50	.194	3	D4
2748288	16064	2746250	19934	M6 X 1	2.50	.75	.38	.255	3	D5
2748284	16070	2746246	19936	M8 X 1,25	2.72	1.12	.69	.318	3	D5
2748275	16072	2746242	19938	M10 X 1,5	2.94	1.25	.75	.381	3	D6
2748271	16074	2746238	19940	M12 X 1,75	3.38	—	.94	.367	3	D6

NOTE: Metric D limits are suitable for ISO 6H tolerance class.  
 Metric taps are manufactured to USCTI specifications and dimensions.  
 Metric tap blank dimensions are equivalent to inch taps.

Series 2314/5314 • Machine Screw and Fractional • Plug Chamfer

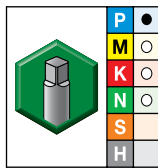
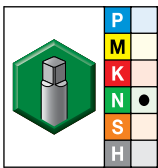
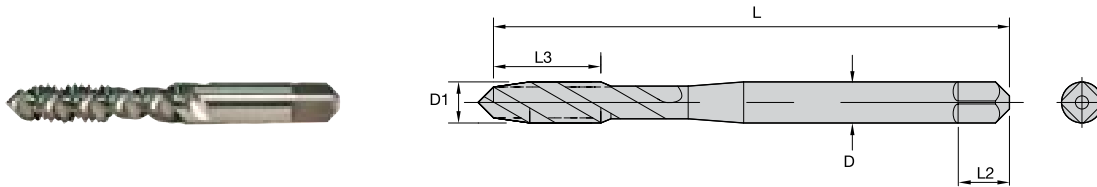

● first choice  
○ alternate choice

uncoated		TiN		D1 size	L	L3	L2	D	number of flutes	pitch diameter limit
order #	catalog #	order #	catalog #							
2748377	16003	2746484	19619	4 - 40	1.88	.56	—	.141	2	H2
2748372	16005	—	—	5 - 40	1.94	.63	—	.141	2	H2
2748369	16007	2746480	19622	6 - 32	2.00	.38	.69	.141	2	H3
2748366	16009	2746474	19626	8 - 32	2.13	.38	.75	.168	3	H3
2748363	16011	2746470	19628	10 - 24	2.38	.50	.88	.194	3	H3
2748360	16013	2746476	19624	10 - 32	2.38	.50	.88	.194	3	H3
2748355	16015	—	—	12 - 24	2.38	.50	.94	.220	3	H3
2748352	16017	2746464	19632	1/4 - 20	2.50	.63	1.00	.255	3	H3
2748348	16021	2746460	19634	1/4 - 28	2.50	.63	1.00	.255	3	H3
2748342	16023	2746458	19636	5/16 - 18	2.72	.69	1.12	.318	3	H3
2748336	16027	2746454	19638	5/16 - 24	2.72	.69	1.12	.318	3	H3
2748335	16029	2746450	19641	3/8 - 16	2.94	.75	1.25	.381	3	H3
2748332	16033	2746447	19643	3/8 - 24	2.94	.75	1.25	.381	3	H3
2748328	16035	2746437	19646	7/16 - 14	3.16	.88	—	.323	3	H3
2748318	16039	2746433	19648	1/2 - 13	3.38	.94	—	.367	3	H3
2748311	16047	—	—	5/8 - 11	3.81	1.09	—	.480	4	H3
2748307	16051	—	—	3/4 - 10	4.25	1.22	—	.590	4	H3

INDEXABLE MILLING

SOLID END MILLING

HOLEMAKING

TAPPING

TURNING

Series 2314/5314 • Machine Screw and Fractional • Bottoming Chamfer

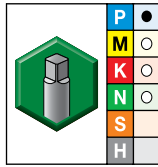
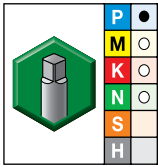
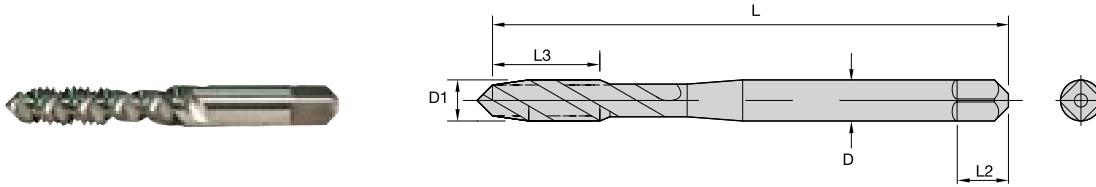

● first choice  
○ alternate choice

uncoated		TiN		D1 size	L	L3	L2	D	number of flutes	pitch diameter limit
order #	catalog #	order #	catalog #							
2748375	16004	2746482	19621	4 - 40	1.88	.56	—	.141	2	H2
2748370	16006	—	—	5 - 40	1.94	.56	—	.141	2	H2
2748367	16008	2746478	19623	6 - 32	2.00	.38	.69	.141	2	H3
3083563	16010	2746472	19627	8 - 32	2.13	.38	.75	.168	3	H3
2748361	16012	2746468	19629	10 - 24	2.38	.50	.88	.194	3	H3
2748356	16014	2746466	19631	10 - 32	2.38	.50	.88	.194	3	H3
2748353	16016	—	—	12 - 24	2.38	.50	.94	.220	3	H3
2748351	16018	2746462	19633	1/4 - 20	2.50	.63	1.00	.255	3	H3
1775500	16022	2746427	19651	1/4 - 28	2.50	.63	1.00	.255	3	H3
2748339	16024	2746456	19637	5/16 - 18	2.72	.69	1.12	.318	3	H3
3012779	16028	2746452	19639	5/16 - 24	2.72	.69	1.12	.318	3	H3
3083460	16030	2746448	19642	3/8 - 16	2.94	.75	1.25	.381	3	H3
2748329	16034	2746439	19644	3/8 - 24	2.94	.75	1.25	.381	3	H3
2748325	16036	2746435	19647	7/16 - 14	3.16	.88	—	.323	3	H3
2748321	16038	—	—	7/16 - 20	3.16	.88	—	.323	3	H3
2748317	16040	2746431	19649	1/2 - 13	3.38	.94	—	.367	3	H3
2748309	16048	—	—	5/8 - 11	3.81	1.09	—	.480	4	H3
3083458	16052	—	—	3/4 - 10	4.25	1.22	—	.590	4	H3

NOTE: Refer to tables on pages D127–D128 for the recommended pitch diameter limit for 2B or 3B class of fit.

INDEXABLE MILLING

SOLID END MILLING

HOLEMAKING

TAPPING

TURNING

Series 5344 • Machine Screw and Fractional • Bottoming Chamfer • Heavy Duty

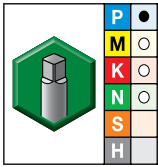
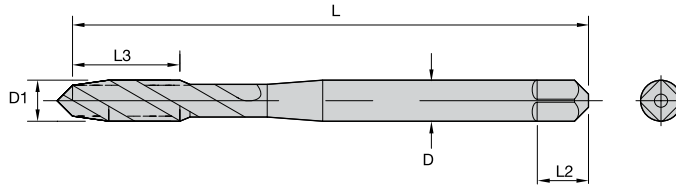

● first choice  
○ alternate choice

oxide		D1 size	L	L2	L3	D	number of flutes	pitch diameter limit
2748054	16502	6 - 32	2.00	—	.38	.141	3	H3
2748050	16504	8 - 32	2.13	—	.38	.168	3	H3
2748046	16506	10 - 24	2.38	—	.50	.194	3	H3
2748042	16508	10 - 32	2.38	—	.50	.194	3	H3
2748038	16510	1/4 - 20	2.50	—	.63	.255	3	H3
2748030	16514	5/16 - 18	2.72	—	.69	.318	3	H3
2748026	16516	5/16 - 24	2.72	—	.69	.318	3	H3
2748022	16518	3/8 - 16	2.94	—	.75	.381	3	H3
2748018	16520	3/8 - 24	2.94	1.25	.75	.381	3	H3
2748014	16522	7/16 - 14	3.16	—	.88	.323	3	H3
2748006	16526	1/2 - 13	3.38	—	.94	.367	3	H3
2748002	16528	1/2 - 20	3.38	—	1.66	.367	3	H3
2747995	16538	3/4 - 10	4.25	—	1.22	.590	4	H3

NOTE: Refer to tables on pages D127-D128 for the recommended pitch diameter limit for 2B or 3B class of fit.

INDEXABLE MILLING

SOLID END MILLING

HOLEMAKING

TAPPING

TURNING

Series 5303 • Fractional Sizes • Taper Chamfer • Hand Taps

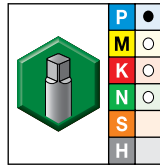
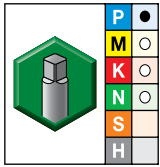
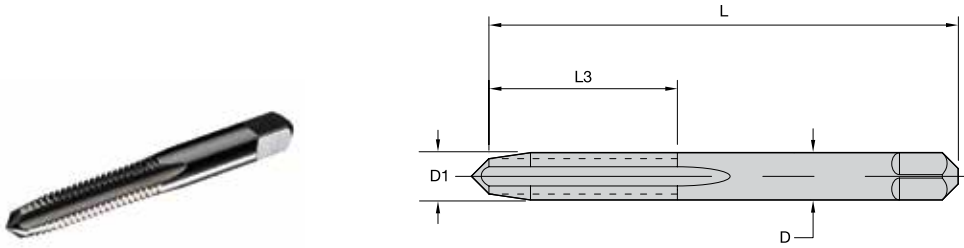

- first choice
- alternate choice

uncoated		oxide		D1 size	L	L3	D	number of flutes	pitch diameter limit
order #	catalog #	order #	catalog #						
2749838	14010	-	-	1/4 - 20	2.50	1.00	.255	4	H1
2749832	14015	-	-	1/4 - 20	2.50	1.00	.255	4	H2
3139335	14022	2709949	19167	1/4 - 20	2.50	1.00	.255	4	H3
2749775	14055	2709942	19208	1/4 - 28	2.50	1.00	.255	4	H3
2749737	14092	2709937	19237	5/16 - 18	2.72	1.13	.318	4	H3
2749689	14122	-	-	5/16 - 24	2.72	1.13	.318	4	H3
2749651	14157	2709923	19278	3/8 - 16	2.94	1.25	.381	4	H3
2749611	14190	-	-	3/8 - 24	2.94	1.25	.381	4	H3
2749586	14221	-	-	7/16 - 14	3.16	1.44	.323	4	H3
2749568	14246	-	-	7/16 - 20	3.16	1.44	.323	4	H3
2749543	14281	2709916	19354	1/2 - 13	3.38	1.66	.367	4	H3
2749514	14308	-	-	1/2 - 20	3.38	1.66	.367	4	H3
3139336	14338	-	-	9/16 - 12	3.59	1.66	.429	4	H3
2749476	14356	-	-	9/16 - 18	3.59	1.66	.429	4	H3
2749460	14379	2709902	19407	5/8 - 11	3.81	1.81	.480	4	H3
2749432	14402	-	-	5/8 - 18	3.81	1.81	.480	4	H3
2749394	14448	-	-	3/4 - 10	4.25	2.00	.590	4	H3
2749374	14471	-	-	3/4 - 16	4.25	2.00	.590	4	H3
2749356	14499	-	-	7/8 - 9	4.69	2.22	.697	4	H4
2749340	14516	-	-	7/8 - 14	4.69	2.22	.697	4	H4
2749327	14544	-	-	1 - 8	5.13	2.50	.800	4	H4
2749308	14557	-	-	1 - 12	5.13	2.50	.800	4	H4
2749294	14568	-	-	1 - 14	5.13	2.50	.800	4	H4
2749281	14594	-	-	1 1/8 - 7	5.44	2.56	.896	4	H4
2749274	14603	-	-	1 1/8 - 12	5.44	2.56	.896	4	H4
2749265	14612	-	-	1 1/4 - 7	5.75	2.56	1.021	4	H4
3171056	14620	-	-	1 1/4 - 12	5.75	2.56	1.021	6	H4
3012774	14632	-	-	1 3/8 - 6	6.06	3.00	1.108	4	H4
3171057	14640	-	-	1 3/8 - 12	6.06	3.00	1.108	6	H4
2749241	14645	-	-	1 1/2 - 6	6.38	3.00	1.233	4	H4
3012776	14653	-	-	1 1/2 - 12	6.38	3.00	1.233	6	H4

NOTE: Hand taps for 3B class of fit are suitable for UNJ aerospace internal threading applications.  
Refer to tables on pages D127-D128 for the recommended pitch diameter limit for 2B or 3B class of fit.

INDEXABLE MILLING

SOLID END MILLING

HOLEMAKING

TAPPING

TURNING

Series 5303/2303 • Fractional Sizes • Plug Chamfer • Hand Taps

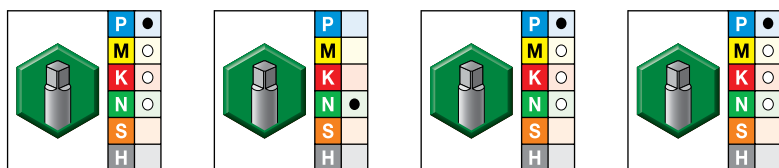
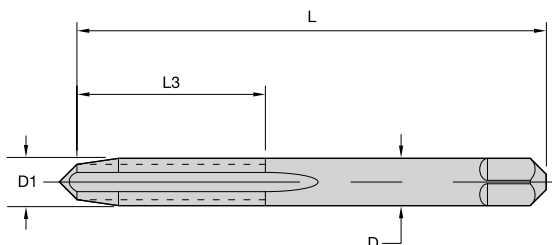

● first choice  
○ alternate choice

TICN		uncoated		oxide		TiN		D1 size	L	L3	D	number of flutes	pitch diameter limit
order #	catalog #	order #	catalog #	order #	catalog #	order #	catalog #						
2749839	14009	2957247	14023	2863727	19170	2463627	19247	1/4 - 20	2.50	1.00	.255	4	H3
-	-	2749837	14011	-	-	-	-	1/4 - 20	2.50	1.00	.255	4	H1
-	-	2749830	14016	-	-	-	-	1/4 - 20	2.50	1.00	.255	4	H2
-	-	3180806	14020	-	-	-	-	1/4 - 20	2.50	1.00	.255	3	H2
-	-	3102009	14030	-	-	2748577	15453	1/4 - 20	2.50	1.00	.255	2	H3
-	-	2749802	14032	-	-	3171060	15454	1/4 - 20	2.50	1.00	.255	3	H3
-	-	2749780	14052	-	-	-	-	1/4 - 28	2.50	1.00	.255	4	H2
-	-	2749777	14053	-	-	-	-	1/4 - 28	2.50	1.00	.255	4	H2
2746827	19128	2749772	14056	2746703	19210	2463629	19253	1/4 - 28	2.50	1.00	.255	4	H3
-	-	2749759	14063	-	-	-	-	1/4 - 28	2.50	1.00	.255	2	H3
-	-	2749757	14065	-	-	2748574	15456	1/4 - 28	2.50	1.00	.255	3	H3
-	-	2749751	14067	-	-	-	-	1/4 - 28	2.50	1.00	.255	4	H4
2746826	19129	2749734	14093	2746665	19240	2746637	19258	5/16 - 18	2.72	1.13	.318	4	H3
-	-	3102021	14100	-	-	-	-	5/16 - 18	2.72	1.13	.318	2	H3
-	-	-	-	-	-	2748569	15459	5/16 - 18	2.72	1.13	.318	2	H3
-	-	-	-	-	-	2710689	15460	5/16 - 18	2.72	1.13	.318	3	H3
-	-	2749714	14102	-	-	-	-	5/16 - 18	2.72	1.13	.318	3	H3
-	-	2749694	14113	-	-	-	-	5/16 - 24	2.72	1.13	.318	4	H1
2746824	19131	2749686	14123	-	-	-	-	5/16 - 24	2.72	1.13	.318	4	H3
-	-	1295391	14130	-	-	2748566	15462	5/16 - 24	2.72	1.13	.318	3	H3
2746822	19132	2749649	14158	2746615	19280	2746625	19268	3/8 - 16	2.94	1.25	.381	4	H3
-	-	2749635	14165	-	-	2748563	15464	3/8 - 16	2.94	1.25	.381	3	H3
-	-	2749629	14169	-	-	-	-	3/8 - 16	2.94	1.25	.381	4	H5
-	-	2749655	14152	-	-	-	-	3/8 - 16	2.94	1.25	.381	4	H2
-	-	2749595	14198	-	-	2748560	15466	3/8 - 24	2.94	1.25	.381	3	H3
-	-	2749591	14201	-	-	-	-	3/8 - 24	2.94	1.25	.381	4	H4
2746820	19134	2749609	14191	-	-	2746621	19273	3/8 - 24	2.94	1.25	.381	4	H3
2746818	19135	2749584	14222	-	-	2746617	19277	7/16 - 14	3.16	1.44	.323	4	H3
-	-	2749573	14229	-	-	2748558	15467	7/16 - 14	3.16	1.44	.323	3	H3
2746816	19136	1951473	14247	-	-	-	-	7/16 - 20	3.16	1.44	.323	4	H3
-	-	2749530	14289	-	-	2748552	15469	1/2 - 13	3.38	1.66	.367	3	H3
-	-	2957246	14293	-	-	-	-	1/2 - 13	3.38	1.66	.367	4	H5
2746814	19137	2415661	14282	2746576	19360	2746605	19291	1/2 - 13	3.38	1.66	.367	4	H3
-	-	2749493	14316	-	-	2748550	15470	1/2 - 20	3.38	1.66	.367	3	H3
2746812	19138	2749513	14309	2746568	19375	2746595	19297	1/2 - 20	3.38	1.66	.367	4	H3
-	-	2866187	14339	-	-	-	-	9/16 - 12	3.59	1.66	.429	4	H3
-	-	2749475	14357	-	-	-	-	9/16 - 18	3.59	1.66	.429	4	H3
2746810	19139	2749458	14380	2746564	19410	2863589	19307	5/8 - 11	3.81	1.81	.480	4	H3
2746808	19140	2749431	14403	-	-	2746592	19317	5/8 - 18	3.81	1.81	.480	4	H3
-	-	-	-	2746560	19445	-	-	3/4 - 10	4.25	2.00	.590	4	H3
-	-	-	-	-	-	2746588	19327	3/4 - 10	4.25	2.00	.590	4	H3
2746806	19141	-	-	-	-	-	-	3/4 - 10	4.25	2.00	.590	4	H3
-	-	2749392	14449	-	-	-	-	3/4 - 10	4.25	2.00	.590	4	H3
-	-	1825322	14472	-	-	-	-	3/4 - 16	4.25	2.00	.590	4	H3

INDEXABLE MILLING

SOLID END MILLING

HOLEMAKING

TAPPING

TURNING

Series 5303/2303 • Fractional Sizes • Plug Chamfer • Hand Taps

(continued)

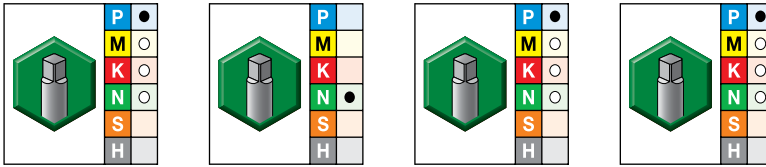
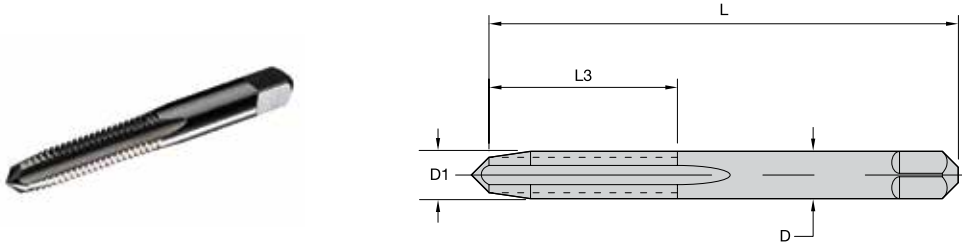

● first choice  
○ alternate choice

TiCN		uncoated		oxide		TiN		D1 size	L	L3	D	number of flutes	pitch diameter limit
order #	catalog #	order #	catalog #	order #	catalog #	order #	catalog #						
-	-	-	-	2746556	19455	-	-	3/4 - 16	4.25	2.00	.590	4	H3
-	-	-	-	-	-	2746584	19337	3/4 - 16	4.25	2.00	.590	4	H3
2746804	19142	-	-	-	-	-	-	3/4 - 16	4.25	2.00	.590	4	H3
-	-	-	-	2709889	19465	-	-	7/8 - 9	4.69	2.22	.697	4	H4
-	-	2749354	14500	-	-	-	-	7/8 - 9	4.69	2.22	.697	4	H4
-	-	-	-	-	-	2863567	19347	7/8 - 9	4.69	2.22	.697	4	H4
-	-	2749338	14517	-	-	-	-	7/8 - 14	4.69	2.22	.697	4	H4
-	-	-	-	2709874	19475	-	-	1 - 8	5.13	2.50	.800	4	H4
-	-	-	-	-	-	2746572	19367	1 - 8	5.13	2.50	.800	4	H4
-	-	2749326	14545	-	-	-	-	1 - 8	5.13	2.50	.800	4	H4
-	-	2749305	14558	-	-	-	-	1 - 12	5.13	2.50	.800	4	H4
-	-	2749292	14569	-	-	-	-	1 - 14	5.13	2.50	.800	4	H4
-	-	2749280	14595	-	-	-	-	1 1/8 - 7	5.44	2.56	.896	4	H4
-	-	2749271	14604	-	-	-	-	1 1/8 - 12	5.44	2.56	.896	4	H4
-	-	2749263	14613	-	-	-	-	1 1/4 - 7	5.75	2.56	1.021	4	H4
-	-	2749258	14621	-	-	-	-	1 1/4 - 12	5.75	2.56	1.021	6	H4
-	-	2749252	14633	-	-	-	-	1 3/8 - 6	6.06	3.00	1.108	4	H4
-	-	2749247	14641	-	-	-	-	1 3/8 - 12	6.06	3.00	1.108	6	H4
-	-	3012775	14646	-	-	-	-	1 1/2 - 6	6.38	3.00	1.233	4	H4
-	-	2749234	14654	-	-	-	-	1 1/2 - 12	6.38	3.00	1.233	6	H4

NOTE: Hand taps for 3B class of fit are suitable for UNJ aerospace internal threading applications.  
Refer to table on pages D127-D128 for the recommended pitch diameter limit for 2B or 3B class of fit.

INDEXABLE MILLING

SOLID END MILLING

HOLEMAKING

TAPPING

TURNING



Series 5303/2303 • Fractional Sizes • Bottoming Chamfer • Hand Taps

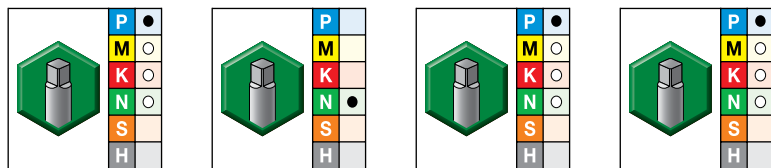
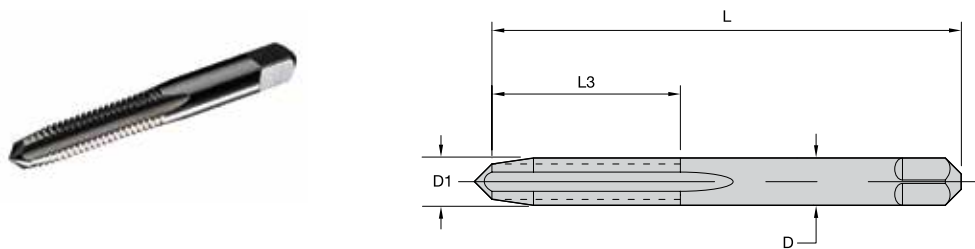

● first choice  
○ alternate choice

TiCN		uncoated		oxide		TiN		D1 size	L	L3	D	number of flutes	pitch diameter limit
order #	catalog #	order #	catalog #	order #	catalog #	order #	catalog #						
-	-	2749836	14012	-	-	-	-	1/4 - 20	2.50	1.00	.255	4	H1
-	-	2749826	14017	-	-	-	-	1/4 - 20	2.50	1.00	.255	4	H2
2746741	19184	2749818	14024	2746748	19180	2463628	19251	1/4 - 20	2.50	1.00	.255	4	H3
-	-	2749805	14031	-	-	-	-	1/4 - 20	2.50	1.00	.255	2	H3
-	-	2749800	14033	-	-	-	-	1/4 - 20	2.50	1.00	.255	3	H3
-	-	2749793	14037	-	-	-	-	1/4 - 20	2.50	1.00	.255	4	H5
2746739	19185	2749766	14057	2746691	19220	2463630	19256	1/4 - 28	2.50	1.00	.255	4	H3
-	-	2749758	14064	-	-	-	-	1/4 - 28	2.50	1.00	.255	2	H3
-	-	2749755	14066	-	-	2748576	15455	1/4 - 28	2.50	1.00	.255	3	H3
-	-	1854370	14068	-	-	-	-	1/4 - 28	2.50	1.00	.255	4	H4
-	-	2749742	14083	-	-	-	-	5/16 - 18	2.72	1.13	.318	4	H1
-	-	2749739	14088	-	-	-	-	5/16 - 18	2.72	1.13	.318	4	H2
2746737	19186	2749732	14094	2746657	19245	2746633	19261	5/16 - 18	2.72	1.13	.318	4	H3
-	-	2749716	14101	-	-	2748573	15457	5/16 - 18	2.72	1.13	.318	2	H3
-	-	2749712	14103	-	-	2748571	15458	5/16 - 18	2.72	1.13	.318	3	H3
-	-	2749706	14105	-	-	-	-	5/16 - 18	2.72	1.13	.318	4	H5
2746735	19187	2038474	14124	2746629	19265	2746627	19266	5/16 - 24	2.72	1.13	.318	4	H3
-	-	2749669	14131	-	-	2748568	15461	5/16 - 24	2.72	1.13	.318	3	H3
-	-	2749656	14148	-	-	-	-	3/8 - 16	2.94	1.25	.381	4	H1
-	-	2749652	14153	-	-	-	-	3/8 - 16	2.94	1.25	.381	4	H2
2746733	19188	2749647	14159	2746609	19285	2746623	19271	3/8 - 16	2.94	1.25	.381	4	H3
-	-	2749633	14166	-	-	2748565	15463	3/8 - 16	2.94	1.25	.381	3	H3
-	-	2749625	14170	-	-	-	-	3/8 - 16	2.94	1.25	.381	4	H5
2746731	19189	1951472	14192	2746593	19310	2746619	19275	3/8 - 24	2.94	1.25	.381	4	H3
-	-	2749593	14199	-	-	2748561	15465	3/8 - 24	2.94	1.25	.381	3	H3
2746729	19191	2749582	14223	-	-	2746613	19281	7/16 - 14	3.16	1.44	.323	4	H3
-	-	2749570	14233	-	-	-	-	7/16 - 14	3.16	1.44	.323	4	H5
2746727	19192	2038865	14248	-	-	2746607	19287	7/16 - 20	3.16	1.44	.323	4	H3
-	-	2749548	14257	-	-	-	-	7/16 - 20	3.16	1.44	.323	4	H5
2746725	19193	2749540	14283	2746580	19355	2746601	19293	1/2 - 13	3.38	1.66	.367	4	H3
-	-	2749526	14290	-	-	2748556	15468	1/2 - 13	3.38	1.66	.367	3	H3
-	-	2749520	14294	-	-	-	-	1/2 - 13	3.38	1.66	.367	4	H5
2746723	19194	1951476	14310	2746566	19380	3113801	19303	1/2 - 20	3.38	1.66	.367	4	H3
-	-	2866184	14340	-	-	-	-	9/16 - 12	3.59	1.66	.429	4	H3
-	-	2749474	14358	-	-	-	-	9/16 - 18	3.59	1.66	.429	4	H3
2746721	19197	2749456	14381	2746562	19415	2863585	19313	5/8 - 11	3.81	1.81	.480	4	H3
-	-	2749441	14389	-	-	-	-	5/8 - 11	3.81	1.81	.480	4	H5
2746719	19198	2749428	14404	-	-	2746590	19323	5/8 - 18	3.81	1.81	.480	4	H3
-	-	2749403	14425	-	-	-	-	11/16 - 11	4.03	1.06	.542	4	H3
2746717	19199	3180808	14450	2746558	19450	2746586	19333	3/4 - 10	4.25	2.00	.590	4	H3
-	-	2749370	14473	2746553	19460	2863572	19343	3/4 - 16	4.25	2.00	.590	4	H3
-	-	2749358	14483	-	-	-	-	3/4 - 16	4.25	2.00	.590	4	H5
-	-	2749352	14501	2709881	19470	2746582	19353	7/8 - 9	4.69	2.22	.697	4	H4
-	-	2749336	14518	-	-	-	-	7/8 - 14	4.69	2.22	.697	4	H4
-	-	2749324	14546	2709867	19480	2746570	19373	1 - 8	5.13	2.50	.800	4	H4
-	-	3006761	14559	-	-	-	-	1 - 12	5.13	2.50	.800	4	H4
-	-	3180807	14570	-	-	-	-	1 - 14	5.13	2.50	.800	4	H4
-	-	2749278	14596	-	-	-	-	1 1/8 - 7	5.44	2.56	.896	4	H4
-	-	2749269	14605	-	-	-	-	1 1/8 - 12	5.44	2.56	.896	4	H4
-	-	2749261	14614	-	-	-	-	1 1/4 - 7	5.75	2.56	1.021	4	H4
-	-	2749256	14622	-	-	-	-	1 1/4 - 12	5.75	2.56	1.021	6	H4
-	-	2749251	14634	-	-	-	-	1 3/8 - 6	6.06	3.00	1.108	4	H4
-	-	2749246	14642	-	-	-	-	1 3/8 - 12	6.06	3.00	1.108	6	H4
-	-	2749240	14647	-	-	-	-	1 1/2 - 6	6.38	3.00	1.233	4	H4
-	-	2749233	14655	-	-	-	-	1 1/2 - 12	6.38	3.00	1.233	6	H4

NOTE: Hand taps for 3B class of fit are suitable for UNJ aerospace internal threading applications. Refer to tables on pages D127-D128 for the recommended pitch diameter limit for 2B or 3B class of fit.

INDEXABLE MILLING

SOLID END MILLING

HOLEMAKING

TAPPING

TURNING

Series 5305 • Machine Screw Sizes • Taper Chamfer • Hand Taps

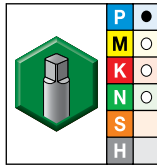
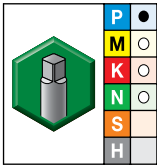
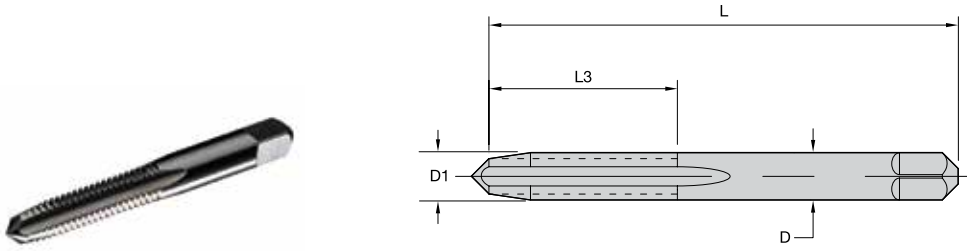

● first choice  
○ alternate choice

uncoated		oxide		D1 size	L	L3	D	number of flutes	pitch diameter limit
order #	catalog #	order #	catalog #						
2748991	15102	-	-	0 - 80	1.63	.31	.141	2	H1
2748975	15114	-	-	1 - 64	1.69	.38	.141	2	H1
2748964	15120	-	-	1 - 72	1.69	.38	.141	2	H1
2748951	15134	-	-	2 - 56	1.75	.44	.141	3	H2
2748935	15144	-	-	2 - 64	1.75	.44	.141	3	H2
2748925	15156	-	-	3 - 48	1.81	.50	.141	3	H2
2748913	15166	-	-	3 - 56	1.81	.50	.141	3	H2
2748887	15184	2709836	19563	4 - 40	1.88	.56	.141	3	H2
2748869	15196	-	-	4 - 48	1.88	.56	.141	3	H2
2865323	15209	-	-	5 - 40	1.94	.63	.141	3	H2
2748858	15220	-	-	5 - 44	1.94	.63	.141	3	H2
2865295	15225	-	-	6 - 32	2.00	.69	.141	3	H1
2748845	15231	-	-	6 - 32	2.00	.69	.141	3	H2
2865268	15237	2709816	19573	6 - 32	2.00	.69	.141	3	H3
2748827	15257	-	-	6 - 40	2.00	.69	.141	3	H2
2748806	15275	-	-	8 - 32	2.13	.75	.168	4	H2
2748787	15283	2709810	19583	8 - 32	2.13	.75	.168	4	H3
2748764	15301	-	-	8 - 36	2.13	.75	.168	4	H2
2748747	15320	-	-	10 - 24	2.38	.88	.194	4	H2
2748738	15327	-	-	10 - 24	2.38	.88	.194	4	H3
2748708	15344	-	-	10 - 32	2.38	.88	.194	4	H1
2748694	15352	-	-	10 - 32	2.38	.88	.194	4	H2
2748679	15360	2709796	19613	10 - 32	2.38	.88	.194	4	H3
2748645	15383	-	-	12 - 24	2.38	.94	.220	4	H3
2748631	15390	-	-	12 - 28	2.38	.94	.220	4	H3

NOTE: Hand taps for 3B class of fit are suitable for UNJ aerospace internal threading applications. Refer to tables on pages D127-D128 for the recommended pitch diameter limit for 2B or 3B class of fit.

INDEXABLE MILLING

SOLID END MILLING

HOLE/MAKING

TAPPING

TURNING

Series 5305/2305 • Machine Screw Sizes • Plug Chamfer • Hand Taps

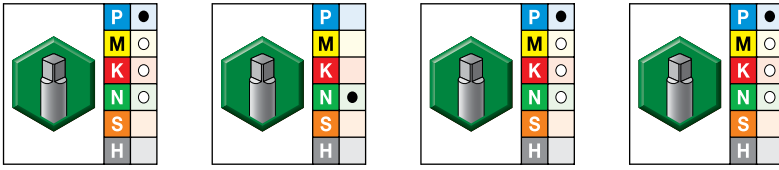
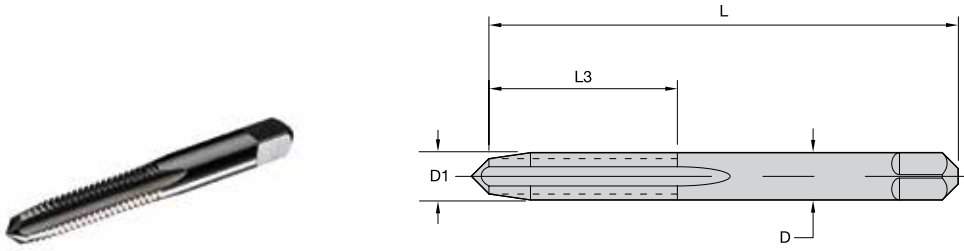

● first choice  
○ alternate choice

TiCN		uncoated		oxide		TiN		D1 size	L	L3	D	number of flutes	pitch diameter limit
order #	catalog #	order #	catalog #	order #	catalog #	order #	catalog #						
-	-	2748988	15103	-	-	-	-	0 - 80	1.63	.31	.141	2	H1
2746839	19121	2748979	15107	-	-	-	-	0 - 80	1.63	.31	.141	2	H2
-	-	2748972	15115	-	-	-	-	1 - 64	1.69	.38	.141	2	H1
-	-	2748963	15121	-	-	-	-	1 - 72	1.69	.38	.141	2	H1
2746837	19122	2748950	15135	-	-	-	-	2 - 56	1.75	.44	.141	3	H2
-	-	2748943	15138	-	-	-	-	2 - 56	1.75	.44	.141	2	H2
-	-	2748933	15145	-	-	-	-	2 - 64	1.75	.44	.141	3	H2
-	-	2748924	15157	-	-	-	-	3 - 48	1.81	.50	.141	3	H2
-	-	2748916	15160	-	-	2748614	15433	3 - 48	1.81	.50	.141	2	H2
-	-	2748911	15167	-	-	3 - 56	1.81	.50	.141	.50	.141	3	H2
2746835	19123	2748885	15185	2709830	19565	2041049	19211	4 - 40	1.88	.56	.141	3	H2
-	-	2748878	15189	-	-	-	-	4 - 40	1.88	.56	.141	2	H2
-	-	2748867	15197	-	-	4 - 48	1.88	.56	.141	.56	.141	3	H2
2746833	19124	2865319	15210	-	-	2746697	19216	5 - 40	1.94	.63	.141	3	H2
-	-	2865310	15214	-	-	2748606	15437	5 - 40	1.94	.63	.141	2	H2
-	-	2748855	15221	-	-	-	-	5 - 44	1.94	.63	.141	3	H2
2748850	15224	2748843	15238	2746500	19575	-	-	6 - 32	2.00	.69	.141	3	H3
-	-	2865279	15232	-	-	2041051	19221	6 - 32	2.00	.69	.141	3	H2
-	-	2748836	15245	-	-	-	-	6 - 32	2.00	.69	.141	2	H3
-	-	2748825	15258	-	-	-	-	6 - 40	2.00	.69	.141	3	H2
-	-	2748816	15262	-	-	-	-	6 - 40	2.00	.69	.141	2	H2
2748810	15270	2748785	15284	2746492	19585	-	-	8 - 32	2.13	.75	.168	4	H3
-	-	2748804	15276	-	-	2463623	19226	8 - 32	2.13	.75	.168	4	H2
-	-	2748774	15291	-	-	-	-	8 - 32	2.13	.75	.168	2	H3
-	-	2748768	15293	-	-	2748598	15442	8 - 32	2.13	.75	.168	3	H3
-	-	2748761	15302	-	-	-	-	8 - 36	2.13	.75	.168	4	H2
-	-	2748746	15321	-	-	-	-	10 - 24	2.38	.88	.194	4	H2
2746831	19126	2748736	15328	2746490	19600	2603956	19231	10 - 24	2.38	.88	.194	4	H3
-	-	2748730	15335	-	-	-	-	10 - 24	2.38	.88	.194	2	H3
-	-	2748726	15337	-	-	2748595	15444	10 - 24	2.38	.88	.194	3	H3
2748697	15348	2748678	15361	2746486	19615	2622811	19236	10 - 32	2.38	.88	.194	4	H3
-	-	2748692	15353	-	-	-	-	10 - 32	2.38	.88	.194	4	H2
-	-	2748666	15368	-	-	-	-	10 - 32	2.38	.88	.194	2	H3
-	-	2748662	15370	-	-	-	-	10 - 32	2.38	.88	.194	3	H3
2746830	19127	2748643	15384	-	-	-	-	12 - 24	2.38	.94	.220	4	H3
-	-	2748628	15391	-	-	-	-	12 - 28	2.38	.94	.220	4	H3

NOTE: Hand taps for 3B class of fit are suitable for UNJ aerospace internal threading applications. Refer to tables on pages D127-D128 for the recommended pitch diameter limit for 2B or 3B class of fit.

INDEXABLE MILLING

SOLID END MILLING

HOLEMAKING

TAPPING

TURNING

Series 5305/2305 • Machine Screw Sizes • Bottoming Chamfer • Hand Taps

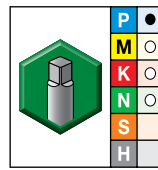
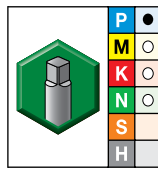
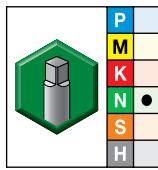
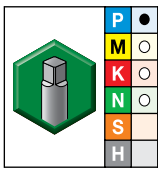
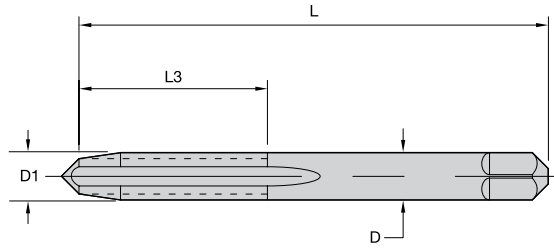

● first choice  
○ alternate choice

TiCN		uncoated		oxide		TiN		D1 size	L	L3	D	number of flutes	pitch diameter limit
order #	catalog #	order #	catalog #	order #	catalog #	order #	catalog #						
-	-	2748985	15104	-	-	-	-	0 - 80	1.63	.31	.141	2	H1
2863721	19174	2748977	15108	-	-	-	-	0 - 80	1.63	.31	.141	2	H2
-	-	2748970	15116	-	-	-	-	1 - 64	1.69	.38	.141	2	H1
-	-	2748962	15122	-	-	-	-	1 - 72	1.69	.38	.141	2	H1
3171079	19175	2748947	15136	-	-	-	-	2 - 56	1.75	.44	.141	3	H2
-	-	2748942	15139	-	-	-	-	2 - 56	1.75	.44	.141	2	H2
-	-	2748930	15146	-	-	-	-	2 - 64	1.75	.44	.141	3	H2
-	-	2748920	15158	-	-	-	-	3 - 48	1.81	.50	.141	3	H2
-	-	2748914	15161	-	-	2748616	15432	3 - 48	1.81	.50	.141	2	H2
-	-	2748906	15168	-	-	-	-	3 - 56	1.81	.50	.141	3	H2
2746756	19176	2748882	15186	2709823	19570	-	-	4 - 40	1.88	.56	.141	3	H2
-	-	2748876	15190	-	-	2748612	15434	4 - 40	1.88	.56	.141	2	H2
-	-	2748864	15198	-	-	-	-	4 - 48	1.88	.56	.141	3	H2
2746754	19177	2865316	15211	-	-	-	-	5 - 40	1.94	.63	.141	3	H2
-	-	3177073	15215	-	-	2748607	15436	5 - 40	1.94	.63	.141	2	H2
-	-	2748852	15222	-	-	-	-	5 - 44	1.94	.63	.141	3	H2
-	-	2865289	15227	-	-	-	-	6 - 32	2.00	.69	.141	3	H1
-	-	2865277	15233	-	-	2041052	19223	6 - 32	2.00	.69	.141	3	H2
-	-	2891496	15236	-	-	-	-	6 - 32	2.00	.69	.141	2	H2
2746752	19178	2748840	15239	2746494	19580	-	-	6 - 32	2.00	.69	.141	3	H3
-	-	2748835	15246	-	-	2748604	15438	6 - 32	2.00	.69	.141	2	H3
-	-	2748820	15259	-	-	-	-	6 - 40	2.00	.69	.141	3	H2
-	-	2748811	15269	-	-	-	-	8 - 32	2.13	.75	.168	4	H1
-	-	2748803	15277	-	-	1773455	19228	8 - 32	2.13	.75	.168	4	H2
-	-	2748795	15280	-	-	-	-	8 - 32	2.13	.75	.168	2	H2
2709451	19860	2748781	15285	2863495	19590	-	-	8 - 32	2.13	.75	.168	4	H3
-	-	2748773	15292	-	-	-	-	8 - 32	2.13	.75	.168	2	H3
-	-	2969917	15294	-	-	-	-	8 - 32	2.13	.75	.168	3	H3
-	-	2748758	15303	-	-	-	-	8 - 36	2.13	.75	.168	4	H2
-	-	2748744	15322	-	-	-	-	10 - 24	2.38	.88	.194	4	H2
2746747	19181	2748733	15329	2746488	19605	2603957	19233	10 - 24	2.38	.88	.194	4	H3
-	-	2748728	15336	-	-	-	-	10 - 24	2.38	.88	.194	2	H3
-	-	2748722	15338	-	-	2748597	15443	10 - 24	2.38	.88	.194	3	H3
-	-	2748689	15354	-	-	-	-	10 - 32	2.38	.88	.194	4	H2
-	-	2748682	15357	-	-	-	-	10 - 32	2.38	.88	.194	2	H2
2746745	19182	2748675	15362	2863477	19620	2622812	19238	10 - 32	2.38	.88	.194	4	H3
-	-	2748663	15369	-	-	2748593	15445	10 - 32	2.38	.88	.194	2	H3
-	-	2748661	15371	-	-	-	-	10 - 32	2.38	.88	.194	3	H3
2746743	19183	2748641	15385	-	-	2746661	19243	12 - 24	2.38	.94	.220	4	H3
-	-	2748624	15392	-	-	-	-	12 - 28	2.38	.94	.220	4	H3

NOTE: Hand taps for 3B class of fit are suitable for UNJ aerospace internal threading applications. Refer to tables on pages D127-D128 for the recommended pitch diameter limit for 2B or 3B class of fit.

INDEXABLE MILLING

SOLID END MILLING

HOLEMAKING

TAPPING

TURNING

## Series 5353 • Metric ANSI • Taper Chamfer • Hand Taps

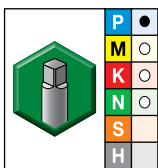
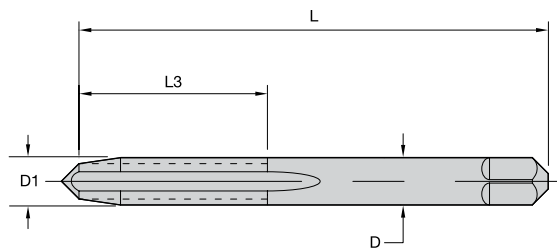

● first choice  
○ alternate choice

uncoated		D1 size	L	L3	D	number of flutes	pitch diameter limit
2749221	14725	M2 X 0,4	1.75	.44	.141	3	D3
2749207	14741	M3 X 0,5	1.94	.63	.141	3	D3
2749197	14757	M4 X 0,7	2.13	.75	.168	4	D4
2749189	14773	M5 X 0,8	2.38	.88	.194	4	D4
2749161	14797	M8 X 1,25	2.72	1.13	.318	4	D5
2749152	14813	M10 X 1,5	2.94	1.25	.381	4	D6
2749144	14829	M12 X 1,75	3.38	1.66	.367	4	D6
2749134	14845	M14 X 2	3.59	1.66	.429	4	D7
2749123	14861	M16 X 2	3.81	1.81	.480	4	D7
2749117	14877	M18 X 2,5	4.03	1.06	.542	4	D7
2749106	14893	M20 X 2,5	4.47	2.00	.652	4	D7
2749096	14909	M24 X 3	4.91	2.22	.760	4	D8
2749086	14925	M30 X 3,5	5.44	2.56	1.021	4	D9
2749077	14941	M36 X 4	6.06	3.00	1.233	4	D9

NOTE: Metric taps for 6H class of fit are suitable for MJ aerospace internal threading applications.  
Metric taps are manufactured to USCTI specifications and dimensions.  
Metric tap blank dimensions are equivalent to inch taps.  
Refer to tables on pages D128 for the recommended pitch diameter limit for 6H class of fit.

INDEXABLE MILLING

SOLID END MILLING

HOLEMAKING

TAPPING

TURNING

Series 5353 • Metric ANSI • Bottoming Chamfer • Hand Taps

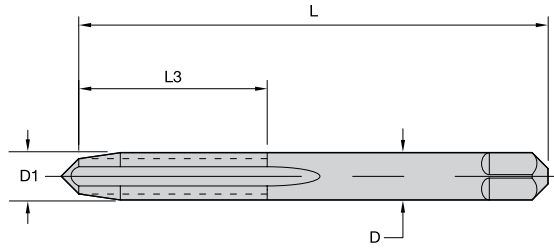

- first choice
- alternate choice

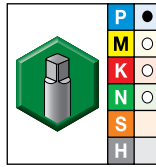
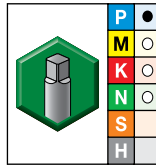
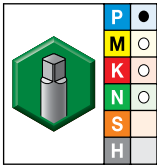

- first choice
- alternate choice

TICN		uncoated		TIN		D1 size	L	L3	D	number of flutes	pitch diameter limit
order #	catalog #	order #	catalog #	order #	catalog #						
2896313	19201	2749204	14743	-	-	M3 X 0,5	1.94	.63	.141	3	D3
2746713	19203	-	-	2978979	15474	M4 X 0,7	2.13	.75	.168	4	D4
2746709	19205	2749182	14775	2746294	19907	M5 X 0,8	2.38	.88	.194	4	D4
2746707	19206	-	-	-	-	M6 X 1	2.50	1.00	.255	4	D5
2746701	19212	-	-	-	-	M8 X 1,25	2.72	1.13	.318	4	D5
2746699	19214	-	-	2746282	19916	M10 X 1,5	2.94	1.25	.381	4	D6
3171080	19215	-	-	-	-	M12 X 1,75	3.38	1.66	.367	4	D6
-	-	2749127	14847	-	-	M14 X 2	3.59	1.66	.429	4	D7
-	-	2749122	14863	-	-	M16 X 2	3.81	1.81	.480	4	D7
-	-	2749102	14895	-	-	M20 X 2,5	4.47	2.00	.652	4	D7
-	-	2749093	14911	-	-	M24 X 3	4.91	2.22	.760	4	D8
-	-	2749081	14927	-	-	M30 X 3,5	5.44	2.56	1.021	4	D9
-	-	2749073	14943	-	-	M36 X 4	6.06	3.00	1.233	4	D9

NOTE: Metric taps for 6H class of fit are suitable for MJ aerospace internal threading applications.  
 Metric taps are manufactured to USCTI specifications and dimensions.  
 Metric tap blank dimensions are equivalent to inch taps.  
 Refer to tables on pages D128 for the recommended pitch diameter limit for 6H class of fit.

INDEXABLE MILLING

SOLID END MILLING

HOLEMAKING

TAPPING

TURNING

## Series 5353 • Metric ANSI • Plug Chamfer • Hand Taps

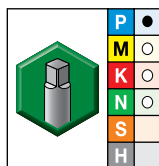
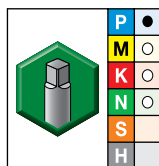
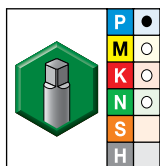
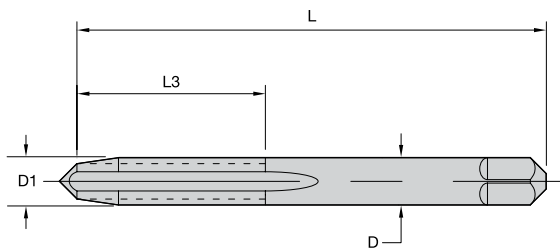

● first choice  
○ alternate choice

TICN		uncoated		TIN		D1 size	L	L3	D	number of flutes	pitch diameter limit
order #	catalog #	order #	catalog #	order #	catalog #						
-	-	2749224	14718	-	-	M1,6 X 0,35	1.63	.31	.141	2	D3
-	-	2749219	14726	-	-	M2 X 0,4	1.75	.44	.141	3	D3
-	-	2749210	14734	-	-	M2,5 X 0,45	1.81	.50	.141	3	D3
3171081	19217	2749205	14742	-	-	M3 X 0,5	1.94	.63	.141	3	D3
-	-	2749199	14750	-	-	M3,5 X 0,6	2.00	.69	.141	3	D4
2746693	19219	2749194	14758	2748549	15473	M4 X 0,7	2.13	.75	.168	4	D4
-	-	2749191	14766	-	-	M4,5 X 0,75	2.38	.88	.194	4	D4
2746687	19222	2749186	14774	2863245	19906	M5 X 0,8	2.38	.88	.194	4	D4
2746683	19224	2749177	14782	-	-	M6 X 1	2.50	1.00	.255	4	D5
-	-	2749167	14790	-	-	M7 X 1	2.72	1.13	.318	4	D5
2746681	19225	2749160	14798	2746288	19912	M8 X 1,25	2.72	1.13	.318	4	D5
2746677	19227	2749151	14814	2746284	19915	M10 X 1,5	2.94	1.25	.381	4	D6
3005011	19229	2749141	14830	2746209	19955	M12 X 1,75	3.38	1.66	.367	4	D6
-	-	2749284	14586	-	-	M14 X 1,25	3.59	1.66	.429	4	H4
-	-	2749131	14846	-	-	M14 X 2	3.59	1.66	.429	4	D7
-	-	3012777	14862	-	-	M16 X 2	3.81	1.81	.480	4	D7
-	-	2749282	14590	-	-	M18 X 1,5	4.03	1.81	.542	4	H4
-	-	2749113	14878	-	-	M18 X 2,5	4.03	1.06	.542	4	D7
-	-	2749104	14894	-	-	M20 X 2,5	4.47	2.00	.652	4	D7
-	-	2749094	14910	-	-	M24 X 3	4.91	2.22	.760	4	D8
-	-	2749084	14926	-	-	M30 X 3,5	5.44	2.56	1.021	4	D9
-	-	2749076	14942	-	-	M36 X 4	6.06	3.00	1.233	4	D9

NOTE: Metric taps for 6H class of fit are suitable for MJ aerospace internal threading applications.  
Metric taps are manufactured to USCTI specifications and dimensions.  
Metric tap blank dimensions are equivalent to inch taps.  
Refer to tables on pages D128 for the recommended pitch diameter limit for 6H class of fit.

INDEXABLE MILLING

SOLID END MILLING

HOLEMAKING

TAPPING

TURNING

Series 5305(EXT)/5303(EXT) • Machine Screw and Fractional • Plug Chamfer • Hand Taps 6" Extension

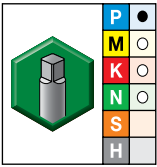
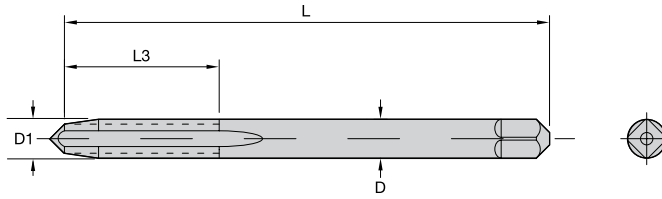

● first choice  
○ alternate choice

uncoated		D1 TPI	L	L3	D	number of flutes	pitch diameter limit
order #	catalog #						
2747078	18827	6 - 32	6.00	.69	.141	3	H3
2747039	18891	8 - 32	6.00	.75	.168	4	H3
2747074	18833	10 - 24	6.00	.88	.194	4	H3
2747070	18836	10 - 32	6.00	.88	.194	4	H3
2747067	18839	1/4 - 20	6.00	1.00	.255	4	H3
2747063	18842	1/4 - 28	6.00	1.00	.255	4	H3
2747059	18845	5/16 - 18	6.00	.67	.318	4	H3
2747051	18851	3/8 - 16	6.00	1.25	.381	4	H3

NOTE: See pages D127-D128 for the recommended pitch diameter limit for 2B or 3B class of fit.

INDEXABLE MILLING

SOLID END MILLING

HOLE/MAKING

TAPPING

TURNING



Series 7303 • Fractional • Taper, Plug, Bottoming Chamfer, and Tap Sets

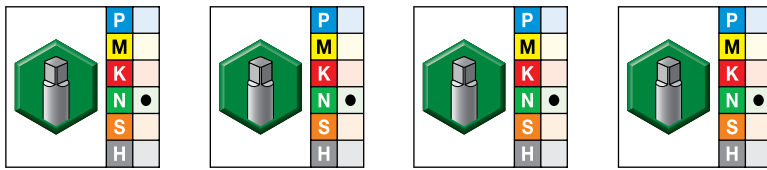
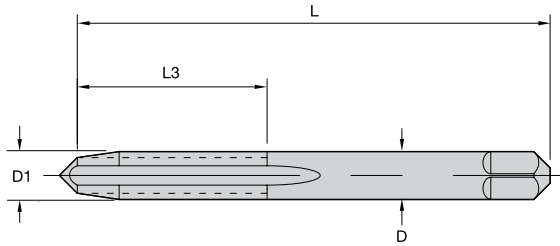

● first choice  
○ alternate choice

taper chamfer 7-10 pitch		plug chamfer 3-5 pitch		full bottom 1-2 pitch		taper and plug bottoming set		D1 size	L	L3	D	class of fit
order #	catalog #	order #	catalog #	order #	catalog #	order #	catalog #					
2751033	11584	-	-	2751031	11586	2751030	11587	3/16 - 24	2	.88	.194	2B
2751027	11596	2751025	11597	2751023	11598	2751020	11599	1/4 - 20	3	1.00	.255	2B
2751019	11600	2751015	11601	2751013	11602	2751011	11603	1/4 - 28	3	1.00	.255	2B
2751010	11604	2751008	11605	2751007	11606	2751004	11607	5/16 - 18	3	1.13	.318	2B
2751002	11608	2751001	11609	2750999	11610	2750998	11611	5/16 - 24	3	1.13	.318	2B
2750996	11612	2750995	11613	2750993	11614	2750991	11615	3/8 - 16	3	1.25	.381	2B
2750990	11616	2750988	11617	2750986	11618	2750985	11619	3/8 - 24	3	1.25	.381	2B
2750984	11620	2750983	11621	2750980	11622	2750975	11623	7/16 - 14	3	1.44	.323	2B
2750972	11624	2750969	11625	2750967	11626	2750965	11627	7/16 - 20	3	1.44	.323	2B
2750962	11628	2750959	11629	2750957	11630	2750953	11631	1/2 - 13	3	1.66	.367	2B
2750951	11632	2750948	11633	2750946	11634	2750945	11635	1/2 - 20	3	1.66	.367	2B
2750943	11636	2750941	11637	2750940	11638	2750939	11639	9/16 - 12	4	1.66	.429	2B
2750937	11640	2750935	11641	2750933	11642	2750932	11643	9/16 - 18	4	1.66	.429	2B
2750928	11644	2750926	11645	2750923	11646	2750920	11647	5/8 - 11	4	1.81	.480	2B
2750918	11648	2750917	11649	2750916	11650	-	-	5/8 - 18	3	1.25	.381	2B
-	-	-	-	-	-	2750915	11651	5/8 - 18	4	1.81	.480	2B
2750912	11652	2750910	11653	2750907	11654	2750906	11655	3/4 - 10	4	2.00	.590	2B
2750904	11656	2750902	11657	2750901	11658	2750900	11659	3/4 - 16	4	2.00	.590	2B
2750898	11660	2750896	11661	2750895	11662	2750893	11663	7/8 - 9	5	2.22	.697	2B
2750892	11664	2750888	11665	2750886	11666	2750885	11667	7/8 - 14	5	2.22	.697	2B
2750883	11668	2750882	11669	2750880	11670	2750879	11671	1 - 8	5	2.50	.800	2B
2750878	11672	-	-	2750875	11674	2750873	11675	1 - 12	5	2.50	.800	2B
2750871	11676	2750868	11677	2750867	11678	-	-	1 - 14	5	2.50	.800	2B
2750862	11680	2750857	11681	2750856	11682	2750854	11683	1 1/8 - 7	5	2.56	.896	2B
-	-	2750852	11685	2750848	11686	-	-	1 1/8 - 8	5	2.56	.896	2B
2750843	11688	2750841	11689	2750838	11690	-	-	1 1/8 - 12	5	2.56	.896	2B
2750835	11692	2750834	11693	2750832	11694	2750831	11695	1 1/4 - 7	6	2.56	1.021	2B
2750827	11696	2750824	11697	2750822	11698	-	-	1 1/4 - 8	6	2.56	1.021	2B
2750812	11700	2750809	11701	2750807	11702	-	-	1 1/4 - 12	6	2.56	1.021	2B
2750780	11716	2750778	11717	2750777	11718	2750776	11719	1 1/2 - 6	6	3.00	1.233	2B
-	-	2750770	11721	2750667	11722	-	-	1 1/2 - 8	6	3.00	1.233	2B
2750621	11724	-	-	2750617	11726	-	-	1 1/2 - 12	6	3.00	1.233	2B

INDEXABLE MILLING

SOLID END MILLING

HOLEMAKING

TAPPING

TURNING

Series 5353 • Metric ANSI • Sets of One Each, Taper, Plug, Bottoming Chamfer • Tap Sets

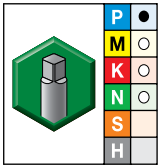
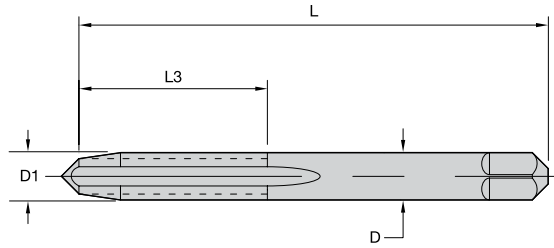

● first choice  
○ alternate choice

uncoated		D1 size	L	L3	D	number of flutes	pitch diameter limit
2749202	14744	M3 X 0,5	1.94	.63	.141	3	D3
2749192	14760	M4 X 0,7	2.13	.75	.168	4	D4
2749181	14777	M5 X 0,8	2.38	.88	.194	4	D4
2749171	14784	M6 X 1	2.50	1.00	.255	4	D5
2749153	14800	M8 X 1,25	2.72	1.13	.318	4	D5
2749145	14816	M10 X 1,5	2.94	1.25	.381	4	D6
2749136	14832	M12 X 1,75	3.38	1.66	.367	4	D6
2749125	14848	M14 X 2	3.59	1.66	.429	4	D7
2749119	14864	M16 X 2	3.81	1.81	.480	4	D7
2749099	14896	M20 X 2,5	4.47	2.00	.652	4	D7

NOTE: Metric taps for 6H class of fit are suitable for MJ aerospace internal threading applications.  
Metric taps are manufactured to USCTI specifications and dimensions.  
Metric tap blank dimensions are equivalent to inch taps.  
Refer to tables on pages D128 for the recommended pitch diameter limit for 6H class of fit.

INDEXABLE MILLING

SOLID END MILLING

HOLE/MAKING

TAPPING

TURNING

## Series 7305 • Machine Screw • Taper, Plug, Bottoming Chamfer, and Tap Sets

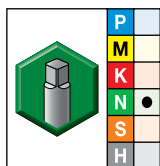
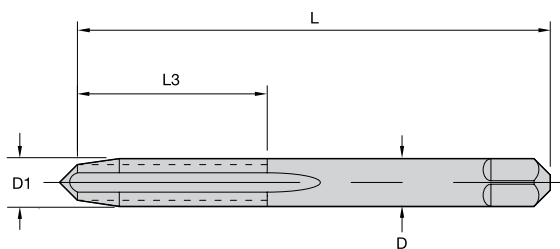

- first choice
- alternate choice

taper chamfer 7-10 pitch		plug chamfer 3-5 pitch		full bottom 1-2 pitch		taper and plug bottoming set		D1 size	L	L3	D	class of fit
order #	catalog #	order #	catalog #	order #	catalog #	order #	catalog #					
2751095	11516	2751092	11517	2751090	11518	2751086	11519	4 - 40	2	.56	.141	2B
2751081	11524	2751080	11525	2751079	11526	2751077	11527	5 - 40	2	.63	.141	2B
2751075	11528	2751073	11529	2751071	11530	2751070	11531	6 - 32	2	.69	.141	2B
-	-	2751068	11537	-	-	-	-	6 - 40	2	.69	.141	2B
2751066	11540	2751064	11541	2751060	11542	2751058	11543	8 - 32	2	.75	.168	2B
-	-	2751056	11545	-	-	-	-	8 - 36	2	.75	.168	2B
2751055	11548	2751053	11549	2751051	11550	2751048	11551	10 - 24	2	.88	.194	2B
2751047	11552	2751045	11553	2751043	11554	2885052	11555	10 - 32	2	.88	.194	2B
2751041	11556	2751040	11557	2751037	11558	2751036	11559	12 - 24	2	.94	.220	2B

## Series 7353 • Metric ANSI • Plug Chamfer • Hand Taps

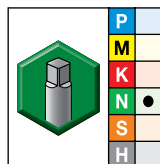
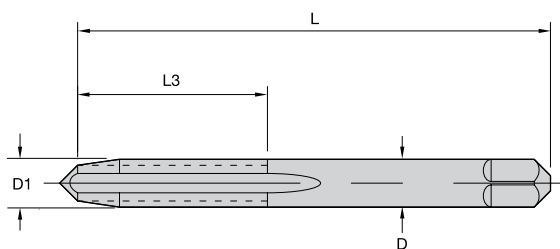

- first choice
- alternate choice

uncoated		D1 size	L	L3	D	number of flutes
order #	catalog #					
2750421	11900	M6 X 1	2.50	1.00	.255	6H
2750420	11901	M8 X 1,25	2.72	1.13	.318	6H
2750418	11902	M10 X 1,5	2.94	1.25	.381	6H
2750415	11903	M12 X 1,75	3.38	1.66	.367	6H
2750412	11904	M14 X 1,25	3.59	1.66	.429	6H
2750410	11905	M14 X 2	3.59	1.66	.429	6H
2750409	11906	M16 X 2	3.81	1.81	.480	6H
2750407	11907	M18 X 1,5	4.03	1.59	.542	6H
2750406	11908	M18 X 2,5	4.03	1.59	.542	6H
2750402	11909	M20 X 2,5	4.47	2.00	.652	6H
2750400	11910	M22 X 2,5	4.69	2.22	.697	6H
2750397	11911	M24 X 3	4.91	2.22	.760	6H

NOTE: Metric taps are manufactured to USCTI specifications and dimensions.  
Metric tap blank dimensions are equivalent to inch taps.

Series 5303 • Fractional Sizes • Taper, Plug, and Bottoming Chamfer • Tap Sets

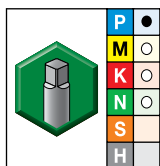
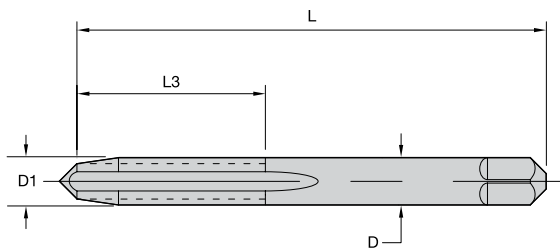

● first choice  
○ alternate choice

uncoated		D1 size	L	L3	D	number of flutes	pitch diameter limit
order #	catalog #						
2749824	14018	1/4 - 20	2.50	1.00	.255	4	H2
2749815	14025	1/4 - 20	2.50	1.00	.255	4	H3
2749764	14058	1/4 - 28	2.50	1.00	.255	4	H3
2749729	14095	5/16 - 18	2.72	1.13	.318	4	H3
2749680	14125	5/16 - 24	2.72	1.13	.318	4	H3
2749644	14160	3/8 - 16	2.94	1.25	.381	4	H3
2749605	14193	3/8 - 24	2.94	1.25	.381	4	H3
2749581	14224	7/16 - 14	3.16	1.44	.323	4	H3
2749560	14249	7/16 - 20	3.16	1.44	.323	4	H3
2749538	14284	1/2 - 13	3.38	1.66	.367	4	H3
2749503	14311	1/2 - 20	3.38	1.66	.367	4	H3
2749488	14341	9/16 - 12	3.59	1.66	.429	4	H3
2749472	14359	9/16 - 18	3.59	1.66	.429	4	H3
2749454	14382	5/8 - 11	3.81	1.81	.480	4	H3
2749426	14405	5/8 - 18	3.81	1.81	.480	4	H3
2749388	14451	3/4 - 10	4.25	2.00	.590	4	H3
2749368	14474	3/4 - 16	4.25	2.00	.590	4	H3
2749350	14502	7/8 - 9	4.69	2.22	.697	4	H4
2749335	14519	7/8 - 14	4.69	2.22	.697	4	H4
2749320	14547	1 - 8	5.13	2.50	.800	4	H4
3303777	14560	1 - 12	5.13	2.50	.800	4	H4
2749288	14571	1 - 14	5.13	2.50	.800	4	H4
2749275	14597	1 1/8 - 7	5.44	2.56	.896	4	H4
2749267	14606	1 1/8 - 12	5.44	2.56	.896	4	H4
2749260	14615	1 1/4 - 7	5.75	2.56	1.021	4	H4
2749254	14623	1 1/4 - 12	5.75	2.56	1.021	6	H4
2749249	14635	1 3/8 - 6	6.06	3.00	1.108	4	H4
2749243	14643	1 3/8 - 12	6.06	3.00	1.108	6	H4
2749237	14648	1 1/2 - 6	6.38	3.00	1.233	4	H4
2749231	14656	1 1/2 - 12	6.38	3.00	1.233	6	H4

NOTE: Hand taps for 3B class of fit are suitable for UNJ aerospace internal threading applications.  
Tap sets include one of each: taper, plug, and bottoming chamfer.  
Refer to tables on pages D127-D128 for the recommended pitch diameter limit for 2B or 3B class of fit.

Series 5305 • Machine Screw Sizes • Taper, Plug, and Bottoming Chamfer • Tap Sets

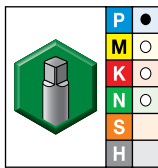
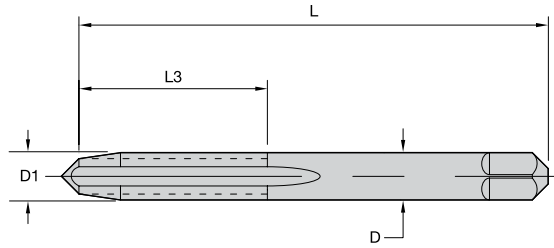

● first choice  
○ alternate choice

uncoated		D1 size	L	L3	D	number of flutes	pitch diameter limit
2748981	15105	0 - 80	1.63	.31	.141	2	H1
2748968	15117	1 - 64	1.69	.38	.141	2	H1
2748961	15123	1 - 72	1.69	.38	.141	2	H1
2748945	15137	2 - 56	1.75	.44	.141	3	H2
2748928	15147	2 - 64	1.75	.44	.141	3	H2
2748918	15159	3 - 48	1.81	.50	.141	3	H2
2748902	15169	3 - 56	1.81	.50	.141	3	H2
2748880	15187	4 - 40	1.88	.56	.141	3	H2
2748863	15199	4 - 48	1.88	.56	.141	3	H2
2865313	15212	5 - 40	1.94	.63	.141	3	H2
2748851	15223	5 - 44	1.94	.63	.141	3	H2
2865286	15228	6 - 32	2.00	.69	.141	3	H1
2865274	15234	6 - 32	2.00	.69	.141	3	H2
2748838	15240	6 - 32	2.00	.69	.141	3	H3
2748818	15260	6 - 40	2.00	.69	.141	3	H2
2748801	15278	8 - 32	2.13	.75	.168	4	H2
2865185	15286	8 - 32	2.13	.75	.168	4	H3
2748756	15304	8 - 36	2.13	.75	.168	4	H2
2748743	15323	10 - 24	2.38	.88	.194	4	H2
2748731	15330	10 - 24	2.38	.88	.194	4	H3
2748685	15355	10 - 32	2.38	.88	.194	4	H2
2748670	15363	10 - 32	2.38	.88	.194	4	H3
2748637	15386	12 - 24	2.38	.94	.220	4	H3
2748623	15393	12 - 28	2.38	.94	.220	4	H3

NOTE: Hand taps for 3B class of fit are suitable for UNJ aerospace internal threading applications.  
Tap sets include one of each: taper, plug, and bottoming chamfer.  
Refer to tables on pages D127-D128 for the recommended pitch diameter limit for 2B or 3B class of fit.

INDEXABLE MILLING

SOLID END MILLING

HOLEMAKING

TAPPING

TURNING

Series 5305L/5303L • Fractional Sizes • Taper, Plug, and Bottoming Chamfer • LH Threads & LH Tap Sets

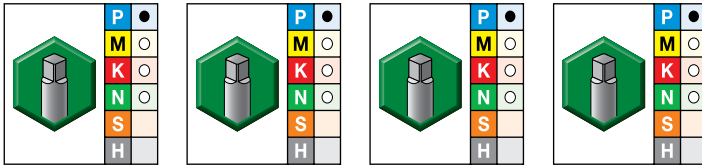
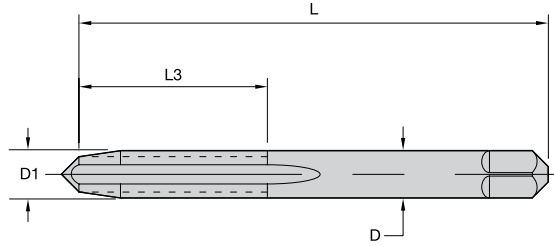

● first choice  
○ alternate choice

taper chamfer 7-10 pitch		plug chamfer 3-5 pitch		full bottom 1-2 pitch		taper and plug bottoming set		D1 TPI	L	L3	D	number of flutes	pitch diameter limit
order #	catalog #	order #	catalog #	order #	catalog #	order #	catalog #						
2749814	14026	2749813	14027	2749811	14028	2749810	14029	1/4 - 20	2.50	1.00	.255	4	H3
-	-	3171054	14060	-	-	-	-	1/4 - 28	2.50	1.00	.255	4	H3
2749727	14096	2749724	14097	2749721	14098	2749719	14099	5/16 - 18	2.72	1.13	.318	4	H3
2749679	14126	2749677	14127	2749675	14128	2749674	14129	5/16 - 24	2.72	1.13	.318	4	H3
2749642	14161	2749639	14162	2749637	14163	2749636	14164	3/8 - 16	2.94	1.25	.381	4	H3
2749603	14194	2749601	14195	2749599	14196	2749597	14197	3/8 - 24	2.94	1.25	.381	4	H3
2749580	14225	-	-	-	-	-	-	7/16 - 14	3.16	1.44	.323	4	H3
3171055	14250	2749557	14251	2749554	14252	-	-	7/16 - 20	3.16	1.44	.323	4	H3
2866246	14285	2749535	14286	2749533	14287	2749531	14288	1/2 - 13	3.38	1.66	.367	4	H3
2749502	14312	2749499	14313	2749497	14314	2749495	14315	1/2 - 20	3.38	1.66	.367	4	H3
2749470	14360	-	-	-	-	-	-	9/16 - 18	3.59	1.66	.429	4	H3
2749451	14383	2749449	14384	2749447	14385	-	-	5/8 - 11	3.81	1.81	.480	4	H3
2749424	14406	2749421	14407	2749420	14408	-	-	5/8 - 18	3.81	1.81	.480	4	H3
2749386	14452	2749384	14453	2749382	14454	-	-	3/4 - 10	4.25	2.00	.590	4	H3
2749367	14475	2749365	14476	2749363	14477	-	-	3/4 - 16	4.25	2.00	.590	4	H3

NOTE: Refer to table on page D127-D128 for the recommended pitch diameter limit for 2B or 3B class of fit.

INDEXABLE MILLING

SOLID END MILLING

HOLEMAKING

TAPPING

TURNING

## Series 2320/5320 • Standard Chamfer • Standard Projection • NPT/ANPT, NPTF

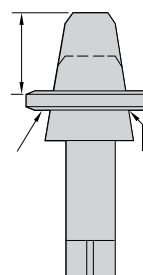
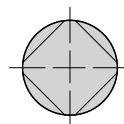
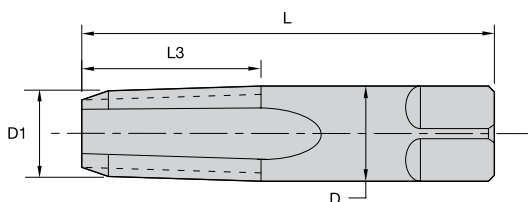

\*\*Standard Projection  
Shortest Projection  
L1 Ring Gage  
Basic Size

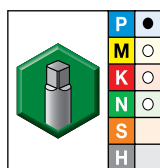
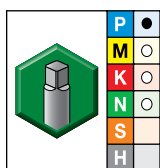
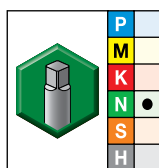

- first choice
- alternate choice

uncoated		oxide		TiN		D1 size	L	L3	D	number of flutes	thread series
order #	catalog #	order #	catalog #	order #	catalog #						
3139338	16201	2746417	19690	2746411	19698	1/16 - 27	2.13	.69	.313	4	NPT/ANPT
2748216	16203	-	-	-	-	1/16 - 27	2.13	.69	.313	4	NPTF
2873746	16204	-	-	2603958	19707	1/8 - 27	2.13	.75	.313	4	NPT/ANPT
2748210	16205	2746413	19695	2746397	19712	1/8 - 27	2.13	.75	.438	4	NPT/ANPT
2748206	16209	-	-	2746407	19701	1/8 - 27	2.13	.75	.313	4	NPTF
2748203	16210	-	-	2746405	19702	1/8 - 27	2.13	.75	.438	4	NPTF
2748199	16212	2746399	19710	2622810	19728	1/4 - 18	2.44	1.06	.563	4	NPT/ANPT
2748193	16215	-	-	2746393	19721	1/4 - 18	2.44	1.06	.563	4	NPTF
2748189	16217	2746386	19730	2746380	19738	3/8 - 18	2.56	1.06	.700	4	NPT/ANPT
2748185	16220	-	-	-	-	3/8 - 18	2.56	1.06	.700	4	NPTF
-	-	-	-	2746382	19736	3/8 - 18	2.56	1.25	.700	4	NPTF
2748177	16225	-	-	2746373	19746	1/2 - 14	3.13	1.66	.687	4	NPTF
2748181	16222	2746378	19740	2603959	19748	1/2 - 14	3.13	1.66	.687	4	NPT/ANPT
2748169	16230	-	-	2746361	19766	3/4 - 14	3.25	1.38	.906	5	NPTF
2748173	16227	2746366	19760	2746359	19768	3/4 - 14	3.25	1.38	.906	5	NPT/ANPT
2748159	16235	-	-	2746357	19776	1 - 11 1/2	3.75	1.75	1.125	5	NPTF
2748165	16232	-	-	2746355	19778	1 - 11 1/2	3.75	1.75	1.125	5	NPT/ANPT
2748153	16239	-	-	-	-	1 1/4 - 11 1/2	4.00	1.75	1.313	5	NPTF
2748155	16237	-	-	-	-	1 1/4 - 11 1/2	4.00	1.75	1.313	5	NPT/ANPT
2748147	16242	-	-	-	-	1 1/2 - 11 1/2	4.25	3.00	1.500	7	NPTF
2748151	16240	-	-	-	-	1 1/2 - 11 1/2	4.25	3.00	1.500	7	NPT/ANPT
2748143	16245	-	-	-	-	2 - 11 1/2	4.25	1.75	1.875	7	NPTF
2748145	16243	-	-	-	-	2 - 11 1/2	4.25	1.75	1.875	7	NPT/ANPT

\*\* Pipe tap projection is the distance the small end of the tap projects through an American National Standard NPTF Thin Ring Gage.  
NOTE: ANPT Taps marked NPT may be used for NPT and ANPT applications.  
For gage measurement projection, see technical page D133.

INDEXABLE MILLING

SOLID END MILLING

HOLEMAKING

TAPPING

TURNING

Series 5319 • Standard Pipe Chamfer • Standard Projection • NPT/ANPT, NPTF Interrupted

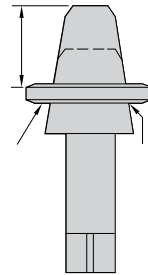
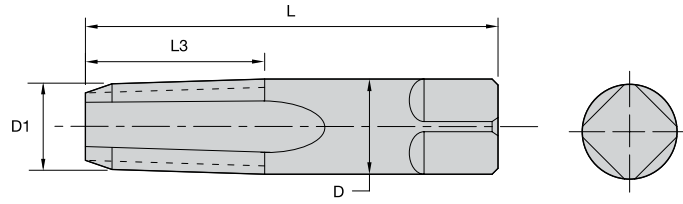

\*\*Standard Projection  
Shortest Projection  
L1 Ring Gage  
Basic Size

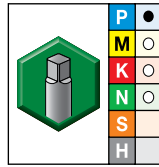
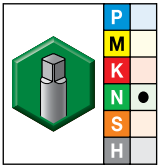

- first choice
- alternate choice

uncoated		oxide		D1 size	L	L3	D	number of flutes	thread series
order #	catalog #	order #	catalog #						
2748270	16101	-	-	1/8 - 27	2.13	.75	.313	5	NPT/ANPT
1854963	16102	2746429	19650	1/8 - 27	2.13	.75	.438	5	NPT/ANPT
2748264	16103	-	-	1/8 - 27	2.13	.75	.313	5	NPTF
2748262	16104	-	-	1/8 - 27	2.13	.75	.438	5	NPTF
2748259	16105	2746425	19655	1/4 - 18	2.44	1.06	.563	5	NPT/ANPT
2748257	16106	-	-	1/4 - 18	2.44	1.06	.563	5	NPTF
2748255	16107	2746423	19656	3/8 - 18	2.56	1.06	.700	5	NPT/ANPT
3175997	16108	-	-	3/8 - 18	2.56	1.06	.700	5	NPTF
2748250	16109	2746421	19665	1/2 - 14	3.13	1.66	.688	5	NPT/ANPT
2748247	16110	-	-	1/2 - 14	3.13	1.66	.688	5	NPTF
2748244	16111	2746419	19675	3/4 - 14	3.25	1.38	.906	5	NPT/ANPT
2748238	16112	-	-	3/4 - 14	3.25	1.38	.906	5	NPTF
2748237	16113	-	-	1 - 11 1/2	3.75	1.75	1.125	5	NPT/ANPT
2748234	16114	-	-	1 - 11 1/2	3.75	1.75	1.125	5	NPTF
2864744	16115	-	-	1 1/4 - 11 1/2	4.00	1.75	1.313	5	NPT/ANPT
2748230	16117	-	-	1 1/2 - 11 1/2	4.25	3.00	1.500	7	NPT/ANPT
2748225	16118	-	-	2 - 11 1/2	4.25	1.75	1.875	7	NPT/ANPT

\*\* Pipe tap projection is the distance the small end of the tap projects through an American National Standard NPTF Thin Ring Gage.

NOTE: NPT taps may be used for ANPT applications.

For gage measurement projection, see technical page D133.

INDEXABLE MILLING

SOLID END MILLING

HOLEMAKING

TAPPING

TURNING



## Series 5323 • Modified Bottoming Chamfer • NPS, NPSF

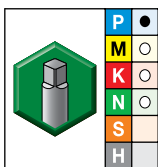
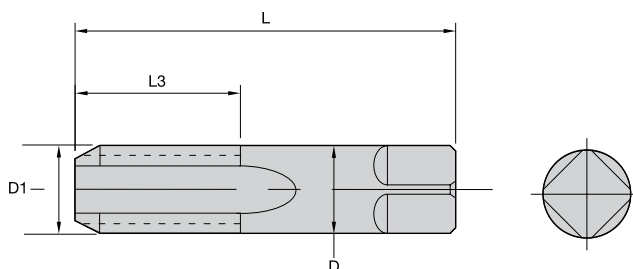

● first choice  
○ alternate choice

uncoated

order #	catalog #	D1 size	L	L3	D	number of flutes	thread series
2748090	16351	1/8 - 27	2.13	.75	.313	4	NPS
2748088	16352	1/8 - 27	2.13	.75	.438	4	NPS
2748086	16353	1/8 - 27	2.13	.75	.313	4	NPSF
2748084	16354	1/8 - 27	2.13	.75	.438	4	NPSF
2748082	16355	1/4 - 18	2.44	1.06	.563	4	NPS
2748080	16356	1/4 - 18	2.44	1.06	.563	4	NPSF
2748078	16357	3/8 - 18	2.56	1.06	.700	4	NPS
2748076	16358	3/8 - 18	2.56	1.06	.700	4	NPSF
2748074	16359	1/2 - 14	3.13	1.66	.688	4	NPS
2748072	16360	1/2 - 14	3.13	1.66	.688	4	NPSF
2748070	16361	3/4 - 14	3.25	1.38	.906	5	NPS
2748068	16362	3/4 - 14	3.25	1.38	.906	5	NPSF
2748066	16363	1 - 11 1/2	3.75	1.75	1.125	5	NPS

INDEXABLE MILLING

SOLID END MILLING

HOLEMAKING

TAPPING

TURNING

Series 5820 • Standard Pipe Chamfer • Standard Projection • NPT/ANPT, NPTF High Hook

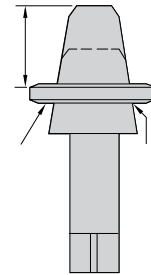
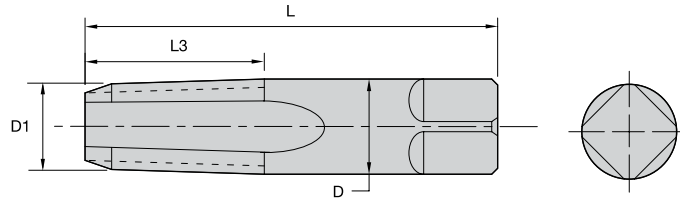

\*\*Standard Projection  
Shortest Projection  
L1 Ring Gage  
Basic Size

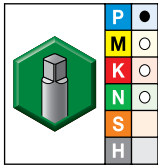

- first choice
- alternate choice

uncoated		D1 size	L	L3	D	number of flutes	thread series
order #	catalog #						
2748196	16213	1/4 - 18	2.44	1.06	.563	4	NPT/ANPT
2748187	16218	3/8 - 18	2.56	1.06	.700	4	NPT/ANPT
2748179	16223	1/2 - 14	3.13	1.66	.688	4	NPT/ANPT
2748171	16228	3/4 - 14	3.25	1.38	.906	5	NPT/ANPT
2748163	16233	1 - 11 1/2	3.75	1.75	1.125	5	NPT/ANPT

\*\* Pipe tap projection is the distance the small end of the tap projects through an American National Standard NPTF Thin Ring Gage.  
NOTE: NPT taps may be used for ANPT applications.  
For gage measurement projection, see technical page D133.

INDEXABLE MILLING

SOLID END MILLING

HOLE/MAKING

TAPPING

TURNING

Series 7320 • Standard Chamfer 2-1/2-3-1/2 Pitches • Pipe Taps

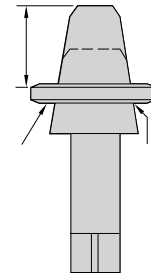
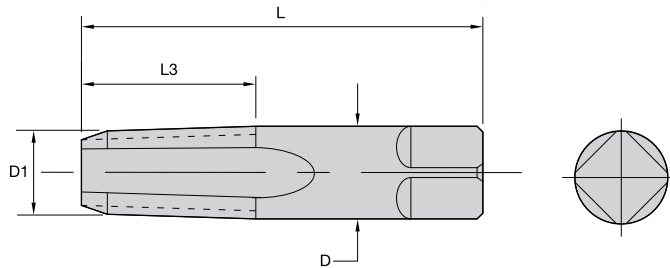

\*\*Standard Projection  
Shortest Projection  
L1 Ring Gage  
Basic Size

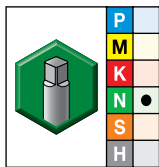

- first choice
- alternate choice

uncoated

order #	catalog #	D1 size	L	L3	D	thread series
2750443	11800	1/8 - 27	2.13	.75	.313	NPT
2750441	11801	1/8 - 27	2.13	.75	.438	NPT
2750437	11802	1/4 - 18	2.44	1.06	.563	NPT
2750435	11803	3/8 - 18	2.56	1.06	.700	NPT
2750431	11804	1/2 - 14	3.13	1.38	.688	NPT
2750430	11805	3/4 - 14	3.25	1.38	.906	NPT
2750428	11806	1 - 11 1/2	3.75	1.75	1.125	NPT
2750426	11807	1 1/4 - 11 1/2	4.00	1.75	1.313	NPT
2750425	11808	1 1/2 - 11 1/2	4.25	1.75	1.500	NPT
2750423	11809	2 - 11 1/2	4.50	1.75	1.875	NPT

INDEXABLE MILLING

SOLID END MILLING

HOLE/MAKING

TAPPING

TURNING

Series 2500/5500 • Machine Screw and Fractional • Plug Entry Taper • Form Taps

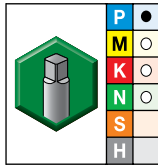
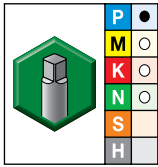
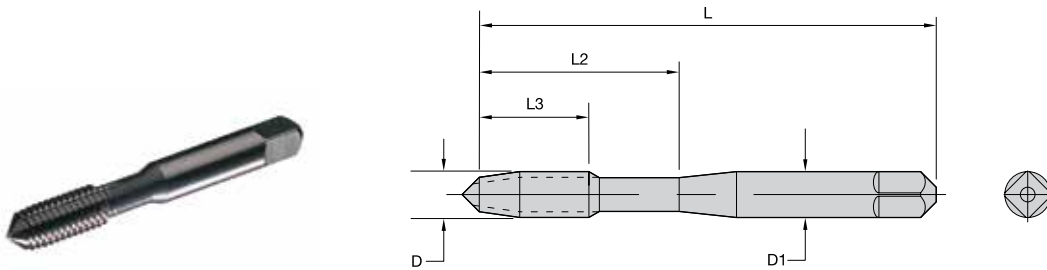

● first choice  
○ alternate choice

uncoated		TiN		D1 size	L	L3	L2	D	number of lube grooves	pitch diameter limit
order #	catalog #	order #	catalog #							
2864322	17000	2746344	19821	4 - 40	1.88	.31	.56	.141	—	H3
2864313	17004	—	—	5 - 40	1.94	.31	.63	.141	4	H3
2864310	17008	2746342	19822	6 - 32	2.00	.38	.69	.141	4	H3
2864307	17009	—	—	6 - 32	2.00	.38	.69	.141	4	H5
2864298	17013	2746338	19824	8 - 32	2.13	.38	.75	.168	4	H3
1295731	17018	2746333	19827	10 - 24	2.38	.50	.88	.194	4	H4
1295732	17020	2746331	19828	10 - 32	2.38	.50	.88	.194	4	H4
2747916	17027	2746327	19841	1/4 - 20	2.50	.63	1.00	.255	4	H4
2747910	17030	2746325	19842	1/4 - 28	2.50	.63	1.00	.255	4	H4
—	—	2746324	19846	5/16 - 18	2.72	.69	1.13	.318	4	H5
2747904	17033	—	—	5/16 - 18	2.72	.69	1.13	.318	4	H5
2747898	17036	—	—	5/16 - 24	2.72	.69	1.13	.318	4	H5
2747892	17039	2746322	19847	3/8 - 16	2.94	.75	1.25	.381	4	H5
2747886	17042	—	—	3/8 - 24	2.94	.75	—	.323	4	H8
2747882	17049	—	—	1/2 - 13	3.38	.94	—	.367	4	H5
2747878	17051	—	—	1/2 - 20	3.38	.94	—	.367	4	H5
2747876	17053	—	—	5/8 - 11	3.81	1.09	—	.480	6	H7
2747872	17057	—	—	3/4 - 10	4.25	1.22	—	.590	6	H7

NOTE: Form taps require a larger drilled hole size prior to tapping than corresponding cutting taps.  
Refer to tables on pages D127–D128 for the recommended pitch diameter limit for 2B or 3B class of fit.

INDEXABLE MILLING

SOLID END MILLING

HOLEMAKING

TAPPING

TURNING

## Series 2502/5502 • Machine Screw and Fractional • Bottoming Chamfer • Form Taps

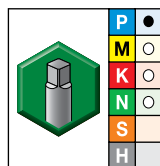
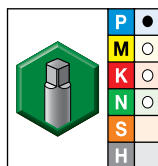
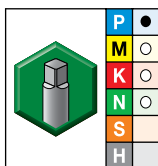
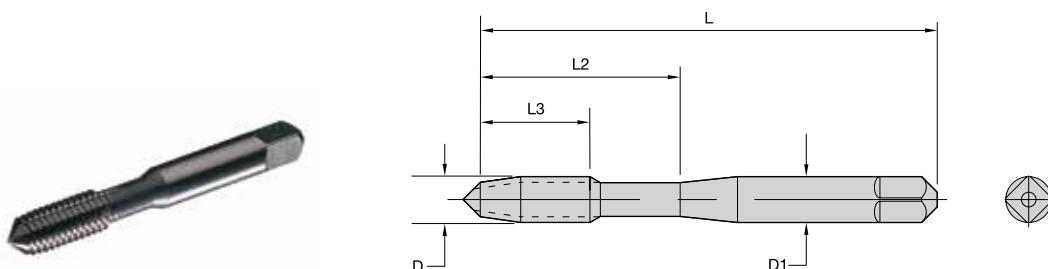

● first choice  
○ alternate choice

TiCN		uncoated		TiN		D1 size	L	L3	L2	D	number of lube grooves	pitch diameter limit
order #	catalog #	order #	catalog #	order #	catalog #							
-	-	2747635	17200	-	-	0 - 80	1.63	.31	-	.141	0	H2
-	-	2747623	17206	-	-	2 - 56	1.75	.44	-	.141	0	H2
-	-	2747621	17207	-	-	2 - 56	1.75	.44	-	.141	0	H3
-	-	2747609	17214	2746320	19849	4 - 40	1.88	.31	.56	.141	0	H3
-	-	2747607	17215	-	-	4 - 40	1.88	.31	.56	.141	0	H5
-	-	2747601	17218	-	-	5 - 40	1.94	.31	.63	.141	4	H3
2746535	19522	2747598	17222	2746315	19852	6 - 32	2.00	.38	.69	.141	4	H3
-	-	2747595	17223	-	-	6 - 32	2.00	.38	.69	.141	4	H5
2746531	19527	2747588	17227	2746311	19857	8 - 32	2.13	.38	.75	.168	4	H3
-	-	2747584	17228	-	-	8 - 32	2.13	.38	.75	.168	4	H5
-	-	2747576	17232	2746307	19862	10 - 24	2.38	.50	.88	.194	4	H4
2746526	19535	2747569	17235	2746305	19866	10 - 32	2.38	.50	.88	.194	4	H4
-	-	2747568	17236	-	-	10 - 32	2.38	.50	.88	.194	4	H6
-	-	2747566	17238	-	-	12 - 24	2.38	.50	.94	.220	4	H4
2746524	19542	2747561	17242	2746304	19869	1/4 - 20	2.50	.63	1.00	.255	4	H4
-	-	2747559	17243	-	-	1/4 - 20	2.50	.63	1.00	.255	4	H6
-	-	2747554	17245	2746302	19871	1/4 - 28	2.50	.63	1.00	.255	4	H4
-	-	-	-	2746300	19872	5/16 - 18	2.72	.69	1.13	.318	4	H5
-	-	2747547	17249	-	-	5/16 - 18	2.72	.69	1.13	.318	4	H7
-	-	2747549	17248	-	-	5/16 - 18	2.72	.69	1.13	.318	4	H5
2746516	19554	2747537	17254	2746298	19873	3/8 - 16	2.94	.75	1.25	.381	4	H5
-	-	2747534	17257	-	-	3/8 - 24	2.94	.75	1.25	.381	4	H5
-	-	2747528	17265	-	-	1/2 - 13	3.38	.94	-	.367	4	H8
-	-	2747530	17264	-	-	1/2 - 13	3.38	.94	-	.367	4	H5
-	-	2747524	17266	-	-	1/2 - 20	3.38	.94	-	.367	4	H5
-	-	2747499	17280	-	-	5/8 - 11	3.81	1.09	-	.480	6	H7

NOTE: Form taps require a larger drilled hole size prior to tapping than corresponding cutting taps.  
Refer to tables on pages D127-D128 for the recommended pitch diameter limit for 2B or 3B class of fit.

INDEXABLE MILLING

SOLID END MILLING

HOLEMAKING

TAPPING

TURNING

Series 2510/5510 • Metric ANSI • Plug Entry Taper • Form Taps

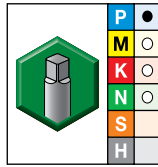
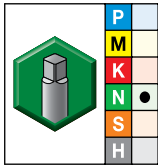
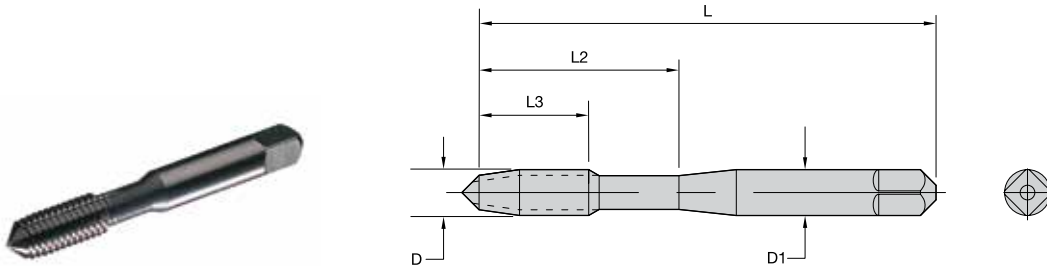

● first choice  
○ alternate choice

uncoated		TiN		D1 size	L	L3	L2	D	number of lube grooves	pitch diameter limit
order #	catalog #	order #	catalog #							
2747866	17082	2746236	19941	M3 X 0,5	1.94	.31	.63	.141	4	D5
2747864	17084	2746234	19942	M4 X 0,7	2.13	.38	.75	.168	4	D6
2747862	17086	2746232	19943	M5 X 0,8	2.38	.50	.88	.194	4	D7
2747860	17087	2746231	19944	M6 X 1	2.50	.63	1.00	.255	4	D8
2747858	17090	2746229	19945	M8 X 1,25	2.72	.69	1.13	.318	4	D9
-	-	2746227	19946	M10 X 1,5	2.94	.75	1.25	.381	4	D10
-	-	2746225	19947	M12 X 1,75	3.38	.94	-	.367	4	D11

NOTE: Metric taps are manufactured to USCTI specifications and dimensions.  
Metric tap blank dimensions are equivalent to inch taps.  
Form taps require a larger drilled hole size prior to tapping than corresponding cutting taps.  
Refer to tables on page D128 for the recommended pitch diameter limit for 6H class of fit.

Series 2512/5512 • Metric ANSI • Bottom Entry Taper • Form Taps

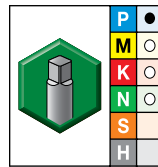
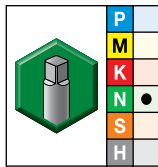
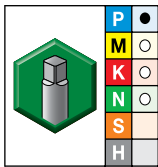
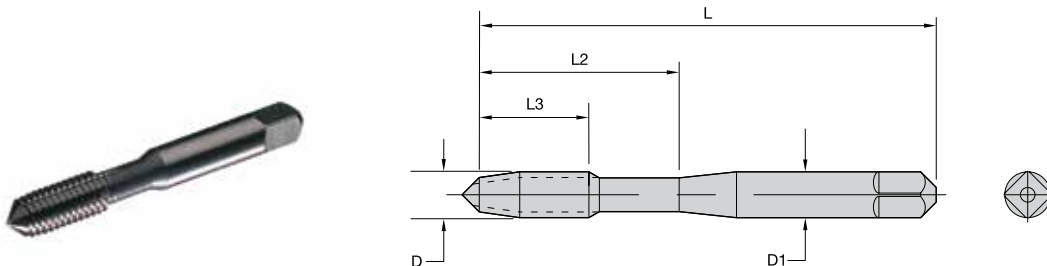

● first choice  
○ alternate choice

TiCN		uncoated		TiN		D1 size	L	L3	L2	D	number of lube grooves	pitch diameter limit
order #	catalog #	order #	catalog #	order #	catalog #							
2746510	19567	2747522	17267	2746223	19948	M3 X 0,5	1.94	.31	.63	.141	4	D5
-	-	2747518	17269	2746221	19949	M4 X 0,7	2.13	.38	.75	.168	4	D6
-	-	2747515	17271	2746219	19950	M5 X 0,8	2.38	.50	.88	.194	4	D7
2746504	19572	2747513	17272	2746217	19951	M6 X 1	2.50	.63	1.00	.255	4	D8
2746502	19574	2747509	17275	2746215	19952	M8 X 1,25	2.72	.69	1.13	.318	4	D9
-	-	2747505	17276	2746213	19953	M10 X 1,5	2.94	.75	1.25	.381	4	D10
-	-	-	-	2746211	19954	M12 X 1,75	3.38	.94	-	.367	4	D11

NOTE: Metric taps are manufactured to USCTI specifications and dimensions.  
Metric tap blank dimensions are equivalent to inch taps.  
Form taps require a larger drilled hole size prior to tapping than corresponding cutting taps.  
Refer to tables on page D128 for the recommended pitch diameter limit for 6H class of fit.

Series 5900 • Machine Screw and Fractional • Plug Entry Taper • Form Taps

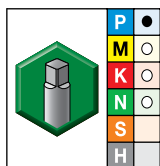
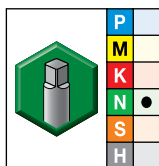
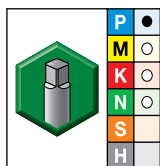
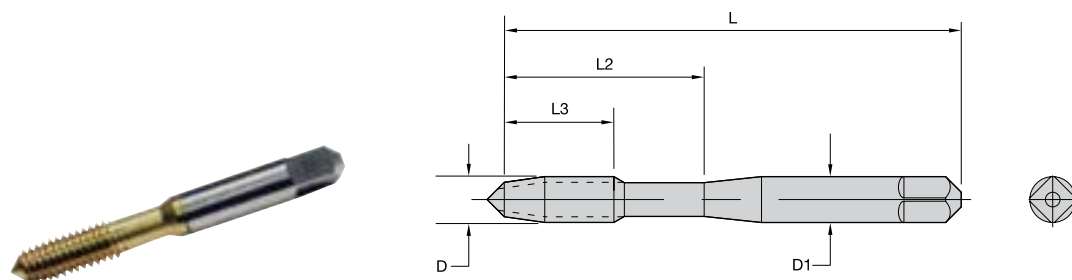

● first choice  
○ alternate choice

TiCN		uncoated		TiN		D1 size	L	L3	L2	D	number of lube grooves	pitch diameter limit
order #	catalog #	order #	catalog #	order #	catalog #							
—	—	2747479	18202	—	—	6 - 32	2.00	.38	.69	.141	4	H5
—	—	2747477	18203	2747338	18303	6 - 32	2.00	.38	.69	.141	4	H3
—	—	2747461	18210	—	—	8 - 32	2.13	.38	.75	.168	4	H5
—	—	2747459	18211	2747322	18311	8 - 32	2.13	.38	.75	.168	4	H3
—	—	2747447	18217	2747311	18317	10 - 24	2.38	.50	.88	.194	4	H4
—	—	2747441	18220	—	—	10 - 32	2.38	.50	.88	.194	4	H6
2747180	18721	2747439	18221	3171069	18321	10 - 32	2.38	.50	.88	.194	4	H4
—	—	2747437	18224	—	—	12 - 24	2.38	.50	.94	.220	4	H4
—	—	2747427	18228	2747296	18328	1/4 - 20	2.50	.63	1.00	.255	4	H6
—	—	2747425	18229	2747293	18329	1/4 - 20	2.50	.63	1.00	.255	4	H4
—	—	2747419	18232	2747288	18332	1/4 - 28	2.50	.63	1.00	.255	4	H6
2747165	18733	2747417	18233	—	—	1/4 - 28	2.50	.63	1.00	.255	4	H4
2747156	18737	2747409	18237	2747277	18337	5/16 - 18	2.72	.69	1.13	.318	4	H5
—	—	2747401	18241	—	—	5/16 - 24	2.72	.69	1.13	.318	4	H5
2747141	18745	2747391	18245	2747265	18345	3/8 - 16	2.94	.75	1.25	.381	4	H5
—	—	2747378	18252	—	—	1/2 - 13	3.38	.94	—	.367	4	H5

NOTE: Form taps require a larger drilled hole size prior to tapping than corresponding cutting taps. Refer to tables on pages D127–D128 for the recommended pitch diameter limit for 2B or 3B class of fit.

INDEXABLE MILLING

SOLID END MILLING

HOLEMAKING

TAPPING

TURNING

Series 5902 • Machine Screw and Fractional • Bottom Entry Taper • Form Taps

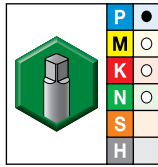
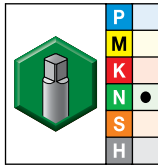
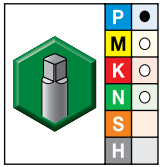
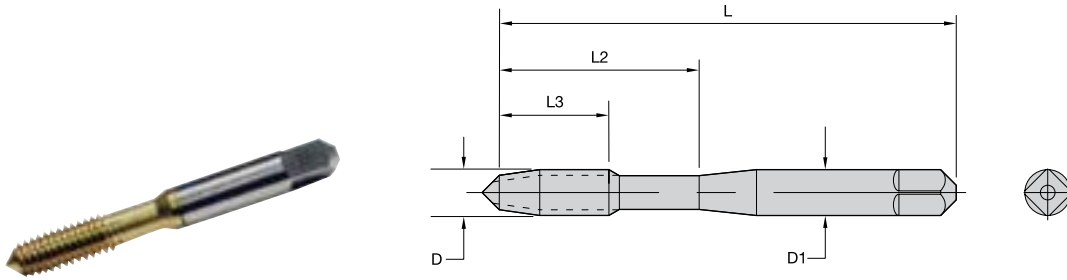

● first choice  
○ alternate choice

TiCN		uncoated		TiN		D1 size	L	L3	L2	D	number of lube grooves	pitch diameter limit
order #	catalog #	order #	catalog #	order #	catalog #							
—	—	2747485	18200	2747344	18300	6 - 32	2.00	.38	.69	.141	4	H3
2747220	18701	2747483	18201	—	—	6 - 32	2.00	.38	.69	.141	4	H5
—	—	2747467	18208	2747328	18308	8 - 32	2.13	.38	.75	.168	4	H5
2747204	18709	2747463	18209	2747326	18309	8 - 32	2.13	.38	.75	.168	4	H3
2747194	18714	2747453	18214	—	—	10 - 24	2.38	.50	.88	.194	4	H6
2747192	18715	2747451	18215	3171068	18315	10 - 24	2.38	.50	.88	.194	4	H4
2747186	18718	2747445	18218	2747310	18318	10 - 32	2.38	.50	.88	.194	4	H6
2747184	18719	2747443	18219	2747308	18319	10 - 32	2.38	.50	.88	.194	4	H4
—	—	3324580	18223	—	—	12 - 24	2.38	.50	.94	.220	4	H4
2747179	18726	2747433	18226	2747300	18326	1/4 - 20	2.50	.63	1.00	.255	4	H4
2747177	18727	2747431	18227	2747298	18327	1/4 - 20	2.50	.63	1.00	.255	4	H6
2747169	18731	2747421	18231	2747289	18331	1/4 - 28	2.50	.63	1.00	.255	4	H4
2747162	18734	2747415	18234	—	—	5/16 - 18	2.72	.69	1.13	.318	4	H5
—	—	2747413	18235	—	—	5/16 - 18	2.72	.69	1.13	.318	4	H7
2747145	18743	2747397	18243	—	—	3/8 - 16	2.94	.75	1.25	.381	4	H7
—	—	2747383	18249	2747257	18349	1/2 - 13	3.38	.94	—	.367	4	H7
2747131	18750	2747381	18250	—	—	1/2 - 13	3.38	.94	—	.367	4	H5
—	—	—	—	2747271	18342	3/8 - 16	2.94	.75	1.25	.381	4	H5

NOTE: Form taps require a larger drilled hole size prior to tapping than corresponding cutting taps. Refer to tables on pages D127-D128 for the recommended pitch diameter limit for 2B or 3B class of fit.

INDEXABLE MILLING

SOLID END MILLING

HOLEMAKING

TAPPING

TURNING



INDEXABLE MILLING

SOLID END MILLING

HOLEMAKING

TAPPING

TURNING

Series 5910 • Metric ANSI • Plug Entry Taper • Form Taps

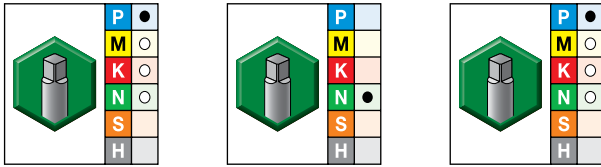
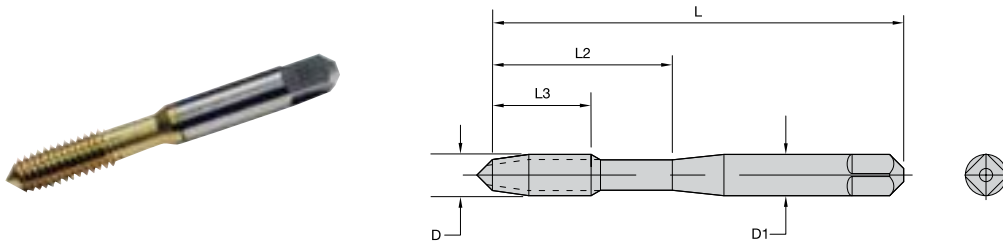

● first choice  
○ alternate choice

TiCN		uncoated		TiN		D1 size	L	L3	L2	D	number of lube grooves	pitch diameter limit
order #	catalog #	order #	catalog #	order #	catalog #							
2747101	18760	2747360	18260	2747236	18360	M6 X 1	64	16	25	6,5	4	D8
2747096	18762	2747355	18262	2747232	18362	M8 X 1,25	69	17	29	8,1	4	D9
2747092	18764	2747351	18264	2747228	18364	M10 X 1,5	75	19	32	9,7	4	D10

NOTE: Series 5910TC • TiCN Coated  
Series 5910T • TiN Coated  
Series 5910 • Uncoated

NOTE: Metric taps are manufactured to USCTI specifications and dimensions.  
Metric tap blank dimensions are equivalent to inch taps.  
Form taps require a larger drilled hole size prior to tapping than corresponding cutting taps.  
Refer to table on page D128 for the recommended pitch diameter limit for 6H class of fit.

Series 5912 • Metric ANSI • Bottom Entry Taper • Form Taps

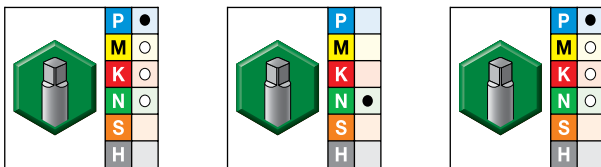
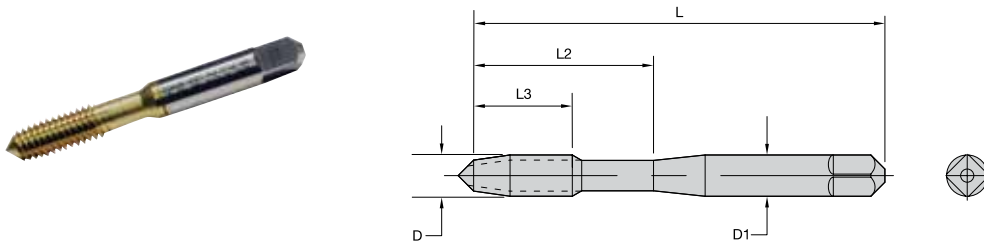

● first choice  
○ alternate choice

TiCN		uncoated		TiN		D1 size	L	L3	L2	D	number of lube grooves	pitch diameter limit
order #	catalog #	order #	catalog #	order #	catalog #							
2747120	18755	—	—	2747246	18355	M4 X 0,7	54	10	19	4,3	4	D6
2747117	18757	2747367	18257	2747241	18357	M5 X 0,8	60	13	22	4,9	4	D7
2747113	18759	2747364	18259	2747238	18359	M6 X 1	64	16	25	6,5	4	D8
—	—	2747357	18261	—	—	M8 X 1,25	69	17	28	8,1	4	D9
2747099	18761	—	—	—	—	M8 X 1,25	69	17	29	8,1	4	D9
2747090	18765	2747347	18265	—	—	M12 X 1,75	86	24	—	9,3	4	D11

NOTE: Series 5912TC • TiCN Coated  
Series 5912T • TiN Coated  
Series 5912 • Uncoated

NOTE: Metric taps are manufactured to USCTI specifications and dimensions.  
Metric tap blank dimensions are equivalent to inch taps.  
Form taps require a larger drilled hole size prior to tapping than corresponding cutting taps.  
See pages D128 for the recommended pitch diameter limit for 6H class of fit.

## Tapping Guide

INDEXABLE MILLING

SOLID END MILLING

HOLEMAKING

TAPPING

TURNING

coating	properties and application	precautions
<b>Titanium Nitride (TiN)</b>	Proprietary TiN coating (hardness 2300 Vickers) offers significantly improved wear life and thread finish, often at higher tapping speeds, in a broad range of materials, especially steels, irons, and plastics. Golden color.	Use with caution in non-ferrous materials such as aluminum because of tendency to gall.
<b>Titanium Carbonitride (TiCN)</b>	Proprietary TiCN coating (hardness 3000 Vickers) is harder, tougher, and more wear resistant than TiN under conditions of moderate cutting temperatures. Like TiN, TiCN may be used at higher cutting speeds in a broad range of materials, especially steels and irons. Blue-gray color.	Use with caution in non-ferrous materials such as aluminum because of tendency to gall. TiAlN is a better choice when used at extreme temperatures.
<b>Titanium Nitride + Chromium Carbide Carbon (TiN + CrC/C)</b>	Proprietary coating (hardness 2300 Vickers) that combines the wear resistance of smooth TiN coating with a lubricous top layer of chromium carbide carbon. Effective in stainless steel and non-ferrous materials including aluminum and titanium. Ideal choice for 300 series stainless steels, wrought, and die cast aluminums. Black/gray color.	Effective in both ferrous and non-ferrous materials.
<b>Titanium Aluminum Nitride (TiAlN)</b>	Nanolayer TiAlN coating (hardness 3300 Vickers) offers improved wear life and thread finish, especially in conditions where high temperatures can be generated. Use for PH stainless steels and nickel-based alloys like INCONEL®. Violet/gray color.	Use with caution in non-ferrous materials because of tendency to gall.
<b>Chromium Nitride (CrN)</b>	CrN is medium hard (hardness 1800 Vickers) and has a lower wear resistance than TiN, TiCN, and TiAlN. However, unlike these coatings, CrN does not gall when used in some non-ferrous work materials. Use for brass, bronze, zinc alloys, and magnesium alloys. Silver color.	Ineffective in ferrous materials.
<b>Nitride</b>	Hardened case extends wear life in abrasive materials. Use for aluminum and other non-ferrous materials.	Avoid on taper pipe, fast spiral, and small diameter (<#6) or fine pitch taps due to tendency for thread chipping.
<b>Oxide</b>	Helps prevent galling in ferrous (iron-based) materials. For free machining steel. Use for steels, stainless steels, and irons.	Has a tendency to cause galling in non-ferrous materials such as aluminum.
<b>Nitride and Oxide</b>	Combines the benefits of nitride and oxide surface treatments. For steels, stainless steels, and nickel alloys.	See precautions for nitride and oxide surface treatments.

## Tapping Speeds

### Factors when trying to determine the best tapping speeds:

- Material to be tapped
- Length of chamfer on tap
- Percentage of full thread to be cut
- Length of hole (depth of thread)
- Pitch of thread
- Cutting fluids
- Machine equipment
- Horizontal or vertical tapping

The best and most efficient operating speeds for taps cannot be calculated with the same certainty, as for many other metalcutting tools.

With other tools, the feed per revolution can be set at any desired point and can be varied as conditions demand. Taps, on the other hand, must always be advanced at a rate equal to one pitch for every revolution. The style of tap may vary the conditions.

For example, with a bottoming tap, the first thread on each land cuts the full height of thread, while, with a taper or starting tap, a number of threads do their share of the cutting before the full height of thread is reached.

The depth of thread also varies, depending on the pitch. The coarser the thread, the greater the advance of the tap per revolution and the greater the amount of material removed.

The method of feeding the tap, and the type of equipment for driving, also influences the permissible speeds. If taps are mechanically fed at the proper rate of advance, they can be operated at higher speeds than if they are required to feed themselves and pull some part of the machine along with them.

### Speeds may be modified to take into account any or all of these factors:

- Speeds must be lowered as length of thread increases because, in deep thread holes, the accumulated chips increase friction and interfere with lubrication.
- Bottoming taps must be run slower than plug taps.
- Tapping full height of thread calls for slower speed than if the commercial 75% height only is required.
- Coarse-thread taps in the larger diameters should be run more slowly than fine-thread taps of the same diameters.
- The quantity and quality of cutting fluid may affect the permissible speeds as much as 100%.
- Taper threaded taps, such as pipe taps, should be operated from 1/2–3/4 the speed of a straight thread tap of comparable major diameter.

### RPM Formulas

SFM = Surface Feet per Minute

RPM = Revolutions per Minute

IPM = Inches per Minute

TPI = Threads per Inch

S m/min = Surface Meters per Minute

$\pi = 3.1416$

mm/min = millimeters per minute

P = Pitch (1/number of threads per inch)

### Inch Sizes

$$\begin{array}{lcl} \text{SFM} & = & \frac{\text{RPM} \times \text{tool diameter}}{3.82} \quad \text{or} \quad 0.26 \times \text{RPM} \times \text{tool diameter} \\ \text{RPM} & = & \frac{3.82 \times \text{SFM}}{\text{tool diameter}} \\ \text{IPM} & = & \frac{\text{RPM}}{\text{TPI}^*} \quad \text{or} \quad *P \times \text{RPM} \end{array}$$

### Metric Sizes

$$\begin{array}{lcl} \text{S m/min} & = & \frac{\pi \times \text{tool diameter} \times \text{RPM}}{1000} \\ \text{RPM} & = & \frac{\text{mm/min} \times 1000}{\pi \times \text{tool diameter}} \\ \text{mm/min} & = & \text{mm } \pi \times \text{RPM} \end{array}$$

General-Purpose Table of Speeds

UNC/UNF and NPT/NPTF

tap size	taper pipe taps	surface feet per minute (SFM)																	
		5'	10'	15'	20'	25'	30'	40'	50'	60'	70'	80'	90'	100'	110'	120'	130'	140'	150'
		revolutions per minute (RPM)																	
0	—	318	637	955	1273	1592	1910	2546	3183	3820	4456	5093	5729	6366	7003	7639	8276	8913	9549
1	—	273	546	819	1046	1308	1570	2093	2617	3140	3663	4186	4710	5233	5756	6279	6805	7326	1849
2	—	212	424	637	888	1110	1333	1777	2221	2665	3109	3554	3999	4442	4886	5330	5774	6218	6662
3	—	191	382	573	772	964	1157	1543	1929	2315	2701	3086	3472	3858	4244	4629	5015	5401	5787
4	—	174	347	521	682	853	1023	1364	1705	2046	2387	2728	3069	3411	3751	4092	4434	4775	5115
5	—	147	294	441	611	764	917	1222	1528	1833	2139	2445	2750	3056	3361	3667	3973	4278	4584
6	—	136	273	409	553	691	829	1106	1382	1659	1935	2212	2488	2766	3042	3318	3595	3871	4148
8	—	119	239	358	466	583	699	932	1165	1398	1631	1864	2097	2330	2563	2796	3029	3262	3495
10	—	101	201	302	402	502	603	804	1005	1205	1406	1607	1808	2009	2210	2411	2612	2813	3014
12	—	87	174	260	354	442	531	707	884	1061	1238	1415	1592	1769	1945	2122	2300	2476	2653
1/4	—	76	153	229	306	382	458	611	764	917	1070	1222	1375	1528	1681	1833	1986	2139	2292
5/16	—	62	123	185	245	306	367	489	611	733	856	978	1100	1222	1345	1467	1589	1711	1833
3/8	—	50	101	151	204	255	305	407	509	611	713	815	917	1019	1120	1222	1324	1426	1528
7/16	1/8	43	87	130	175	219	262	349	437	524	611	698	786	873	960	1048	1135	1222	1310
1/2	—	38	76	115	153	191	229	305	382	458	535	611	688	764	840	917	993	1070	1146
9/16	1/4	34	68	102	137	172	206	274	342	410	478	547	616	683	752	820	888	952	1020
5/8	—	32	64	96	122	153	183	244	306	367	428	489	550	611	672	733	794	856	917
11/16	3/8	28	55	83	111	138	167	222	278	333	389	444	500	556	611	667	722	778	833
3/4	—	25	51	76	102	128	153	203	255	305	357	407	458	509	560	611	662	713	764
7/8	1/2	22	43	65	87	109	131	175	218	262	306	350	392	437	480	524	568	611	655
1	—	19	38	57	76	96	115	153	191	230	268	305	344	382	420	458	497	535	573
1-1/8	3/4	17	34	51	68	84	102	136	170	204	238	272	306	340	373	407	441	475	509
1-1/4	—	15	31	46	61	76	92	122	153	183	214	244	275	305	336	367	397	428	458
1-3/8	1	14	28	42	56	69	83	111	139	167	194	222	250	278	306	333	361	389	417
1-1/2	—	13	25	38	51	63	76	102	127	153	178	204	229	255	280	305	331	356	382
1-5/8	—	12	23	35	47	59	71	94	118	141	165	188	212	235	259	282	306	329	353
1-3/4	—	11	22	33	44	55	65	87	109	131	153	175	196	218	240	262	284	306	327
1-7/8	—	10	20	30	41	51	61	81	102	122	143	163	183	204	224	244	265	285	306
2	—	9	19	29	38	48	57	76	96	115	134	153	172	191	210	229	248	267	287

Metric

metric taps	vc = meters per minute (m/min)																	
	1,5	3	4,5	6	7,5	10	12	15	18	21	24	27	30	33	36	39	42	45
	revolutions per minute (RPM)																	
M1	490	979	1469	1959	2449	2938	3918	4897	5877	6856	7836	8815	9795	10774	11754	12733	13713	14692
M2	242	484	725	967	1209	1451	1934	2418	2901	3385	3868	4352	4835	5319	5803	6286	6770	7253
M3	162	324	486	647	809	971	1295	1619	1942	2266	2590	2914	3237	3561	3885	4208	4532	4856
M3.5	138	277	415	554	692	830	1107	1384	1661	1938	2214	2491	2768	3045	3322	3599	3875	4152
M4	122	243	365	487	608	730	973	1217	1460	1703	1946	2190	2433	2676	2920	3163	3406	3650
M5	97	194	291	388	485	582	776	970	1163	1357	1551	1745	1939	2133	2327	2521	2715	2905
M6	81	162	243	324	405	486	647	809	971	1133	1295	1457	1619	1781	1942	2104	2266	2428
M7	69	138	208	277	346	415	554	692	830	969	1107	1246	1384	1522	1661	1799	1938	2076
M8	61	121	182	243	303	364	485	606	728	849	970	1091	1213	1334	1455	1577	1698	1819
M10	48	97	145	194	242	291	388	485	582	679	776	873	970	1067	1163	1260	1357	1454
M12	40	81	121	162	202	243	324	405	486	567	647	728	809	890	971	1052	1133	1214
M14	35	69	104	139	173	208	277	347	416	485	555	624	693	763	832	901	971	1040
M16	30	61	91	121	152	182	243	303	364	424	485	546	606	667	728	788	849	910
M18	27	54	81	108	135	162	216	269	323	377	431	485	539	593	647	700	754	808
M20	24	49	73	97	121	146	194	243	291	340	388	437	485	534	582	631	680	728
M22	22	44	66	88	110	132	176	221	265	309	353	397	441	485	529	573	618	662
M24	20	40	61	81	101	121	162	202	243	283	323	364	404	445	485	526	566	606
M27	18	36	54	72	90	108	144	180	216	252	287	323	359	395	431	467	503	539
M30	16	32	49	65	81	97	129	162	194	226	259	291	323	356	388	420	453	485

VariTap has optimized geometries capable of working in a wide variety of ductile materials – including carbon and alloy steels, stainless steels, ductile iron, and cast aluminum.

**Advanced spiral-flute design**  
Smooth ejection of chip to reduce or eliminate bird-nesting

**Multiple tap dimension options**  
ANSI, DIN, JIS, & DIN/ANSI

**High-vanadium HSS-E**  
Improved wear characteristics, longer tool life

The VariTap platform is designed with a positive rake face and a flute optimized for tapping multiple materials

## GRADES

WP42EG	TiCN	WU41EG	TiN	WP49EG	Oxide	WU40EG	Bright
	P ●		P ○		P ○		P ○
	M ●		M ○		M ○		M ○
	K ●		K ○		K ○		K ○
	N ●		N ○		N ○		N ○
	S		S		S		S
	H		H		H		H

# VERSATILE MULTI-MATERIAL TAPS



## PRODUCT

VariTap™ taps deliver performance for value in multi-material tapping applications.

## INDUSTRY



## MATERIALS



## APPLICATIONS



BLIND HOLE



THROUGH HOLE



HSS-E



FORM E



FORM C



FORM B



ANSI UNC



ANSI UNF



ANSI M



ANSI MF



FLOOD COOLANT: TAPPING



CLASS OF FIT: 2B



CLASS OF FIT: 3B



CLASS OF FIT: 6H

## SPIRAL POINT WITH ANSI DIMENSIONS

SIZE RANGE	CHAMFER STYLE	GRADE
2-56 to 1-12"	Plug (Form B)	WP49EG } All H Limits WP42EG } WU41EG } 3B Only
1-1/8-8" to 2-4-1/2"	Plug (Form B)	WP49EG
M3 x 0.50 to M12 x 1.75	Plug (Form B)	WP49EG } 6H D Limits WP42EG } WU41EG } WP49EG } D11 WP42EG }
M14 x 1.5 to M20 x 2.5	Plug (Form B)	WP49EG WP42EG
M22 x 1.5 to M30 x 3.5	Plug (Form B)	WP49EG

## SPIRAL FLUTE WITH ANSI DIMENSIONS

SIZE RANGE	CHAMFER STYLE	GRADE
2-56 to 1-12"	Semi-Bottom (Form C)	WP49EG } All H Limits WP42EG }
1-1/8-8" to 2-4-1/2"	Semi-Bottom (Form C)	WP49EG
4-40 to 3/4-16	Bottom (Form E)	WP49EG
M3 x 0.50 to M12 x 1.75	Semi-Bottom (Form C)	WP49EG } 6H D Limits WP42EG } WU41EG } WP49EG } D11 WP42EG }
M14 x 1.5 to M20 x 2.5	Semi-Bottom (Form C)	WP49EG WP42EG
M22 x 1.5 to M30 x 3.5	Semi-Bottom (Form C)	WP49EG
M3 x 0.50 to M18 x 1.5	Bottom (Form E)	WP49EG

## Shank Style

ANSI, DIN, JIS, & DIN/ANSI precision ground to h9 tolerance

## Grades and Grade Descriptions

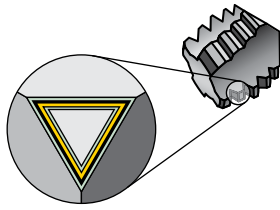

Coatings are designed for optimized tapping performance in specific materials.

P	Steel
M	Stainless Steel
K	Cast Iron
N	Non-Ferrous
S	High-Temp Alloys
H	Hardened Materials

wear resistance ← toughness

Grade	Coating	Grade Description	Material Hardness																				
			05	10	15	20	25	30	35	40	45												
WP42EG		Coated HSS-E substrate with TiCN PVD layer. Use in multiple applications, including steel, stainless steel, ductile cast iron, and cast aluminum. WP42EG is more abrasion-resistant than WU41EG.	P																				
			M																				
			K																				
			N																				
WU41EG		Coated HSS-E substrate with TiN PVD layer. Use in multiple applications, including steel, stainless steel, ductile cast iron, and cast aluminum.	P																				
			M																				
			K																				
			N																				
WP49EG		HSS-E substrate with black oxide surface treatment. Use in a variety of materials, including steel, stainless steel, and ductile iron. Not recommended for non-ferrous materials.	P																				
			M																				
			K																				
WU40EG		Uncoated HSS-E grade with bright surface. Use in easy-to-machine, general-purpose applications.	P																				
			M																				
			K																				
			N																				

VT-SPO • Form B Plug Chamfer • Machine Screw and Fractional • ANSI

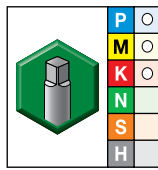
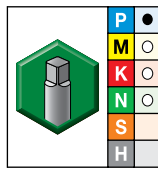
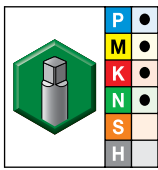
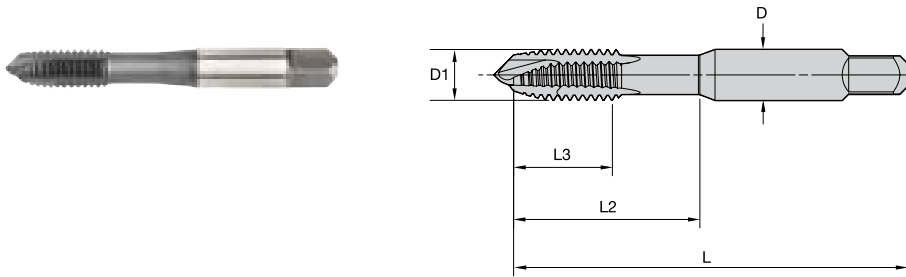

● first choice  
○ alternate choice

grade WP42EG TiCN		grade WU41EG TiN		grade WP49EG Oxide		D1 TPI	L	L3	L2	D	number of flutes	pitch diameter limit
order #	catalog #	order #	catalog #	order #	catalog #							
5365807	VTSP05045	5365808	VTSP05045	5365806	VTSP05045	1/4 - 20	2.50	.63	1.00	.255	3	H3
5365821	VTSP05046	-	-	5365820	VTSP05046	1/4 - 20	2.50	.63	1.00	.255	3	H5
5365825	VTSP05047	-	-	5365823	VTSP05047	1/4 - 20	2.50	.63	1.00	.255	3	H7
5365827	VTSP05048	-	-	5365826	VTSP05048	1/4 - 20	2.50	.63	1.00	.255	3	H11
5365840	VTSP05049	5365841	VTSP05049	5365829	VTSP05049	1/4 - 28	2.50	.63	1.00	.255	3	H3
5365844	VTSP05050	-	-	-	-	1/4 - 28	2.50	.63	1.00	.255	3	H4
5365849	VTSP05051	-	-	5365848	VTSP05051	1/4 - 28	2.50	.63	1.01	.255	3	H5
5365922	VTSP05052	-	-	-	-	1/4 - 28	2.50	.63	1.01	.255	3	H6
5365925	VTSP05053	-	-	5365924	VTSP05053	1/4 - 28	2.50	.63	1.01	.255	3	H7
-	-	-	-	5365928	VTSP05054	1/4 - 28	2.50	.63	1.01	.255	3	H11
5365932	VTSP05055	5365933	VTSP05055	5365931	VTSP05055	5/16 - 18	2.72	.69	1.14	.318	3	H3
5365936	VTSP05056	-	-	5365935	VTSP05056	5/16 - 18	2.72	.69	1.14	.318	3	H5
5365939	VTSP05057	-	-	5365938	VTSP05057	5/16 - 18	2.72	.69	1.14	.318	3	H7
5365942	VTSP05058	-	-	5365941	VTSP05058	5/16 - 18	2.72	.69	1.14	.318	3	H11
5365946	VTSP05059	5365947	VTSP05059	5365945	VTSP05059	5/16 - 24	2.72	.69	1.14	.318	3	H3
5365960	VTSP05060	-	-	5365949	VTSP05060	5/16 - 24	2.72	.69	1.14	.318	3	H4
5365963	VTSP05061	-	-	5365962	VTSP05061	5/16 - 24	2.72	.69	1.14	.318	3	H5
-	-	-	-	5365965	VTSP05062	5/16 - 24	2.72	.69	1.14	.318	3	H6
5365972	VTSP05064	-	-	5365971	VTSP05064	5/16 - 24	2.72	.69	1.14	.318	3	H11
5365975	VTSP05065	5365976	VTSP05065	5365974	VTSP05065	3/8 - 16	2.94	.75	1.27	.381	3	H3
5366898	VTSP05066	-	-	5366897	VTSP05066	3/8 - 16	2.94	.75	1.27	.381	3	H5
5366941	VTSP05067	-	-	5366940	VTSP05067	3/8 - 16	2.94	.75	1.27	.381	3	H7
5366944	VTSP05068	-	-	5366943	VTSP05068	3/8 - 16	2.94	.75	1.27	.381	3	H11
5366947	VTSP05069	5366948	VTSP05069	5366946	VTSP05069	3/8 - 24	2.94	.75	1.27	.381	3	H3
-	-	-	-	5366950	VTSP05070	3/8 - 24	2.94	.75	1.27	.381	3	H4
5366954	VTSP05071	-	-	5366953	VTSP05071	3/8 - 24	2.94	.75	1.27	.381	3	H5
-	-	-	-	5366956	VTSP05072	3/8 - 24	2.94	.75	1.27	.381	3	H6
5366960	VTSP05073	-	-	5366959	VTSP05073	3/8 - 24	2.94	.75	1.27	.381	3	H7
5366966	VTSP05075	5366967	VTSP05075	5366965	VTSP05075	7/16 - 14	3.16	.88	1.49	.323	3	H3
5366970	VTSP05076	-	-	5366969	VTSP05076	7/16 - 14	3.16	.88	1.49	.323	3	H5
5366976	VTSP05078	-	-	-	-	7/16 - 14	3.16	.88	1.49	.323	3	H11
5366979	VTSP05079	5366980	VTSP05079	5366978	VTSP05079	7/16 - 20	3.16	.88	1.49	.323	3	H3
5366983	VTSP05080	-	-	5366982	VTSP05080	7/16 - 20	3.16	.88	1.49	.323	3	H5
-	-	-	-	5366036	VTSP05081	7/16 - 20	3.16	.88	1.49	.323	3	H6
5366075	VTSP05084	5366076	VTSP05084	5366074	VTSP05084	1/2 - 13	3.38	.94	1.74	.367	3	H3
5366079	VTSP05085	-	-	5366078	VTSP05085	1/2 - 13	3.38	.94	1.74	.367	3	H5
5366083	VTSP05086	-	-	5366081	VTSP05086	1/2 - 13	3.38	.94	1.74	.367	3	H7
5366086	VTSP05087	-	-	5366085	VTSP05087	1/2 - 13	3.38	.94	1.74	.367	3	H11
5366089	VTSP05088	5366110	VTSP05088	5366088	VTSP05088	1/2 - 20	3.38	.94	1.74	.367	3	H3
5366113	VTSP05089	-	-	5366112	VTSP05089	1/2 - 20	3.38	.94	1.74	.367	3	H5
-	-	-	-	5366115	VTSP05090	1/2 - 20	3.38	.94	1.74	.367	3	H6
5366117	VTSP05091	-	-	5366116	VTSP05091	1/2 - 20	3.38	.94	1.74	.367	3	H7
-	-	-	-	5366119	VTSP05092	1/2 - 20	3.38	.94	1.74	.367	3	H11
5366133	VTSP05093	5366134	VTSP05093	5366132	VTSP05093	9/16 - 12	3.59	1.00	1.74	.429	3	H3
5366137	VTSP05094	5366138	VTSP05094	5366136	VTSP05094	9/16 - 18	3.59	1.00	1.74	.429	3	H3
5366141	VTSP05095	5366142	VTSP05095	5366140	VTSP05095	5/8 - 11	3.81	1.09	1.89	.480	3	H3
5366145	VTSP05096	-	-	5366144	VTSP05096	5/8 - 11	3.81	1.09	1.89	.480	3	H5
-	-	-	-	5367003	VTSP05097	5/8 - 11	3.81	1.09	1.89	.480	3	H7
5367005	VTSP05098	-	-	5367004	VTSP05098	5/8 - 18	3.81	1.09	1.89	.480	3	H3
5367008	VTSP05099	-	-	5367007	VTSP05099	5/8 - 18	3.81	1.09	1.89	.480	3	H5
5367032	VTSP05101	-	-	5367031	VTSP05101	5/8 - 18	3.81	1.09	1.89	.480	3	H7
5367035	VTSP05102	5367036	VTSP05102	5367034	VTSP05102	3/4 - 10	4.25	1.22	2.08	.590	3	H3



VT-SPO • Form B Plug Chamfer • Machine Screw and Fractional • ANSI

(continued)

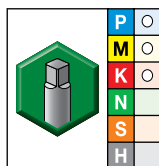
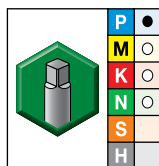
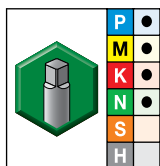
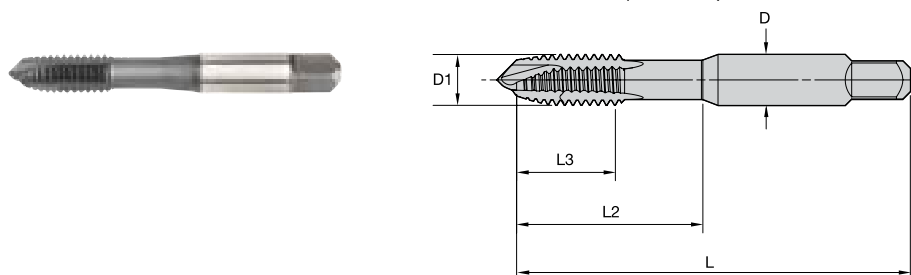

● first choice  
○ alternate choice

grade WP42EG TiCN		grade WU41EG TiN		grade WP49EG Oxide		D1 TPI	L	L3	L2	D	number of flutes	pitch diameter limit
order #	catalog #	order #	catalog #	order #	catalog #							
5367039	VTSP05103	-	-	5367038	VTSP05103	3/4 - 10	4.25	1.22	2.08	.590	3	H5
5367062	VTSP05104	5367063	VTSP05104	5367061	VTSP05104	3/4 - 16	4.25	1.22	2.08	.590	3	H3
5367066	VTSP05105	-	-	5367065	VTSP05105	3/4 - 16	4.25	1.22	2.08	.590	3	H5
5367069	VTSP05106	5367070	VTSP05106	5367068	VTSP05106	7/8 - 9	4.69	1.34	2.30	.697	3	H4
5367073	VTSP05107	-	-	5367072	VTSP05107	7/8 - 9	4.69	1.34	2.30	.697	3	H5
5367076	VTSP05108	-	-	5367075	VTSP05108	7/8 - 14	4.69	1.34	2.30	.697	3	H4
5366406	VTSP05109	5366407	VTSP05109	5366404	VTSP05109	1 - 8	5.13	1.50	2.58	.800	3	H5
5366440	VTSP05110	-	-	5366409	VTSP05110	1 - 12	5.13	1.50	2.58	.800	3	H4
-	-	-	-	5366442	VTSP05111	1 1/8 - 7	5.44	1.71	2.56	.896	4	H6
-	-	-	-	5366443	VTSP05112	1 1/8 - 8	5.44	1.71	2.56	.896	4	H6
-	-	-	-	5366444	VTSP05113	1 1/8 - 12	5.44	1.71	2.56	.896	4	H5
-	-	-	-	5366445	VTSP05114	1 1/4 - 7	5.75	1.71	2.56	1.021	4	H6
-	-	-	-	5366446	VTSP05115	1 1/4 - 8	5.75	1.71	2.56	1.020	4	H6
-	-	-	-	5366447	VTSP05116	1 1/4 - 12	5.75	1.71	2.56	1.021	4	H5
-	-	-	-	5366448	VTSP05117	1 3/8 - 6	6.07	2.00	3.00	1.108	4	H6
-	-	-	-	5366449	VTSP05118	1 3/8 - 8	6.07	2.00	3.00	1.108	4	H6
-	-	-	-	5366450	VTSP05119	1 3/8 - 12	6.07	2.00	3.00	1.108	4	H5
-	-	-	-	5366451	VTSP05120	1 1/2 - 6	6.38	2.00	3.00	1.233	4	H6
-	-	-	-	5366452	VTSP05121	1 1/2 - 8	6.38	2.00	3.00	1.233	4	H6
-	-	-	-	5366453	VTSP05122	1 1/2 - 12	6.38	2.00	3.00	1.233	4	H5
5357242	VTSP05001	-	-	5357241	VTSP05001	2 - 56	1.75	.39	.50	.141	2	H2
-	-	-	-	5357244	VTSP05002	2 - 56	1.75	.39	.50	.141	2	H3
-	-	-	-	5357245	VTSP05003	2 - 56	1.75	.39	.50	.141	2	H4
-	-	-	-	5366454	VTSP05123	2 - 4 1/2	7.63	2.67	3.56	1.643	4	H7
5357247	VTSP05004	-	-	5357246	VTSP05004	3 - 48	1.82	.45	.57	.141	2	H2
5357260	VTSP05005	5357261	VTSP05005	5357249	VTSP05005	4 - 40	1.88	.51	.69	.141	2	H2
5357264	VTSP05006	-	-	5357263	VTSP05006	4 - 40	1.88	.51	.69	.141	2	H3
-	-	-	-	5357266	VTSP05007	4 - 40	1.88	.51	.69	.141	2	H4
5357272	VTSP05008	-	-	5357271	VTSP05008	4 - 40	1.88	.51	.69	.141	2	H5
-	-	-	-	5357274	VTSP05009	4 - 40	1.88	.51	.69	.141	2	H6
5357276	VTSP05010	-	-	5357275	VTSP05010	4 - 48	1.88	.51	.69	.141	2	H2
5357280	VTSP05012	-	-	5357279	VTSP05012	5 - 40	1.94	.58	.75	.141	2	H2
5631491	VTSP05365	-	-	5631490	VTSP05365	5 - 40	1.94	.58	.75	.141	3	H2
5357283	VTSP05013	-	-	5357282	VTSP05013	6 - 32	1.99	.38	.71	.141	2	H2
5357286	VTSP05014	5357287	VTSP05014	5357285	VTSP05014	6 - 32	1.99	.38	.71	.141	2	H3
-	-	-	-	5357289	VTSP05015	6 - 32	1.99	.38	.71	.141	2	H4
5357293	VTSP05016	-	-	5357292	VTSP05016	6 - 32	1.99	.38	.71	.141	2	H5
5357296	VTSP05017	-	-	-	-	6 - 32	1.99	.38	.71	.141	2	H6
5357299	VTSP05018	-	-	5357298	VTSP05018	6 - 32	1.99	.38	.71	.141	2	H7
5365704	VTSP05019	-	-	-	-	6 - 32	1.99	.38	.71	.141	2	H11
-	-	-	-	5365706	VTSP05020	6 - 40	1.99	.38	.71	.141	2	H2
-	-	-	-	5365709	VTSP05021	6 - 40	1.99	.38	.71	.141	2	H3
-	-	-	-	5631506	VTSP05364	6 - 32	1.99	.38	.71	.141	3	H6
5631494	VTSP05366	-	-	5631493	VTSP05366	6 - 32	1.99	.38	.71	.141	3	H2
5631497	VTSP05367	-	-	-	-	6 - 32	1.99	.38	.71	.141	3	H3
-	-	-	-	5631500	VTSP05368	6 - 32	1.99	.38	.71	.141	3	H4
-	-	-	-	5631503	VTSP05369	6 - 32	1.99	.38	.71	.141	3	H5
-	-	-	-	5631509	VTSP05370	6 - 32	1.99	.38	.71	.141	3	H7
-	-	-	-	5631512	VTSP05371	6 - 32	1.99	.38	.71	.141	3	H11
5365771	VTSP05029	-	-	5365769	VTSP05029	8 - 36	2.11	.38	.76	.168	2	H2
5365741	VTSP05022	-	-	5365740	VTSP05022	8 - 32	2.12	.38	.76	.168	2	H2
5365744	VTSP05023	5365745	VTSP05023	5365743	VTSP05023	8 - 32	2.12	.38	.76	.168	2	H3

INDEXABLE MILLING

SOLID END MILLING

HOLEMAKING

TAPPING

TURNING

VT-SPO • Form B Plug Chamfer • Machine Screw and Fractional • ANSI

(continued)

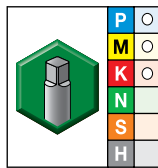
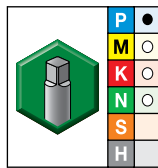
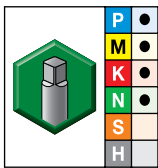
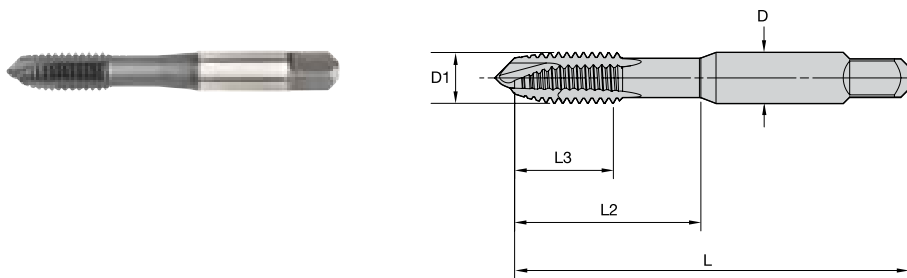

● first choice  
○ alternate choice

grade WP42EG TiCN		grade WU41EG TiN		grade WP49EG Oxide		D1 TPI	L	L3	L2	D	number of flutes	pitch diameter limit
order #	catalog #	order #	catalog #	order #	catalog #							
5365751	VTSP05025	-	-	5365747	VTSP05024	8 - 32	2.12	.38	.76	.168	2	H4
-	-	-	-	5365750	VTSP05025	8 - 32	2.12	.38	.76	.168	2	H5
5365758	VTSP05027	-	-	5365753	VTSP05026	8 - 32	2.12	.38	.76	.168	2	H6
-	-	-	-	5365757	VTSP05027	8 - 32	2.12	.38	.76	.168	2	H7
5631523	VTSP05375	-	-	5365762	VTSP05028	8 - 32	2.12	.38	.76	.168	2	H11
-	-	-	-	5631522	VTSP05375	8 - 32	2.12	.38	.76	.168	3	H3
-	-	-	-	5631526	VTSP05376	8 - 32	2.12	.38	.76	.168	3	H4
-	-	-	-	5631529	VTSP05377	8 - 32	2.12	.38	.76	.168	3	H5
-	-	-	-	5631532	VTSP05378	8 - 32	2.12	.38	.76	.168	3	H6
-	-	-	-	5631538	VTSP05379	8 - 32	2.12	.38	.76	.168	3	H7
-	-	-	-	5631544	VTSP05380	8 - 32	2.12	.38	.76	.168	3	H11
5365785	VTSP05040	-	-	5365783	VTSP05040	10 - 32	2.36	.50	.91	.194	2	H6
5365791	VTSP05041	-	-	5365789	VTSP05041	10 - 32	2.36	.50	.91	.194	2	H7
5365797	VTSP05042	-	-	5365795	VTSP05042	10 - 32	2.36	.50	.91	.194	2	H11
5365779	VTSP05039	-	-	5365777	VTSP05039	10 - 32	2.36	.50	.91	.194	2	H5
5365759	VTSP05036	-	-	5365756	VTSP05036	10 - 32	2.36	.50	.91	.194	2	H2
5365764	VTSP05037	5365766	VTSP05037	5365763	VTSP05037	10 - 32	2.36	.50	.91	.194	2	H3
5365772	VTSP05038	-	-	5365770	VTSP05038	10 - 32	2.36	.50	.91	.194	2	H4
5631600	VTSP05389	5631602	VTSP05389	5631598	VTSP05389	10 - 32	2.36	.50	.91	.194	3	H3
-	-	-	-	5631606	VTSP05390	10 - 32	2.36	.50	.91	.194	3	H4
5631614	VTSP05391	-	-	-	-	10 - 32	2.36	.50	.91	.194	3	H5
-	-	-	-	5365782	VTSP05031	10 - 24	2.37	.50	.91	.194	2	H4
5365796	VTSP05035	-	-	-	-	10 - 24	2.37	.50	.91	.194	2	H11
5365776	VTSP05030	5365778	VTSP05030	5365774	VTSP05030	10 - 24	2.37	.50	.91	.194	2	H3
5631558	VTSP05382	5631560	VTSP05382	5631556	VTSP05382	10 - 24	2.37	.50	.91	.194	3	H3
-	-	-	-	5631563	VTSP05383	10 - 24	2.37	.50	.91	.194	3	H4
-	-	-	-	5631572	VTSP05385	10 - 24	2.37	.50	.91	.194	3	H6
-	-	-	-	5631575	VTSP05387	10 - 24	2.37	.50	.91	.194	3	H11
5365786	VTSP05032	-	-	5365784	VTSP05032	10 - 24	2.37	.50	.91	.194	2	H5
-	-	-	-	5365790	VTSP05033	10 - 24	2.37	.50	.91	.194	2	H6
-	-	-	-	5365792	VTSP05034	10 - 24	2.37	.50	.91	.194	2	H7
5365801	VTSP05043	-	-	5365800	VTSP05043	12 - 24	2.37	.50	.96	.220	2	H3
5365804	VTSP05044	-	-	5365803	VTSP05044	12 - 28	2.37	.50	.96	.220	2	H3
5631635	VTSP05395	-	-	5631634	VTSP05395	12 - 24	2.37	.50	.96	.220	3	H3
5631638	VTSP05396	-	-	-	-	12 - 28	2.37	.50	.96	.220	3	H3

NOTE: VariTap for 3B class of fit is suitable for UNJ aerospace internal threading applications.

VT-SPO • Form B Plug Chamfer • Machine Screw and Fractional • DIN Length ANSI Shank

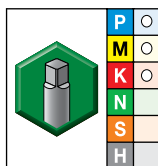
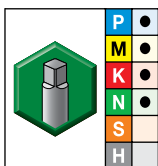
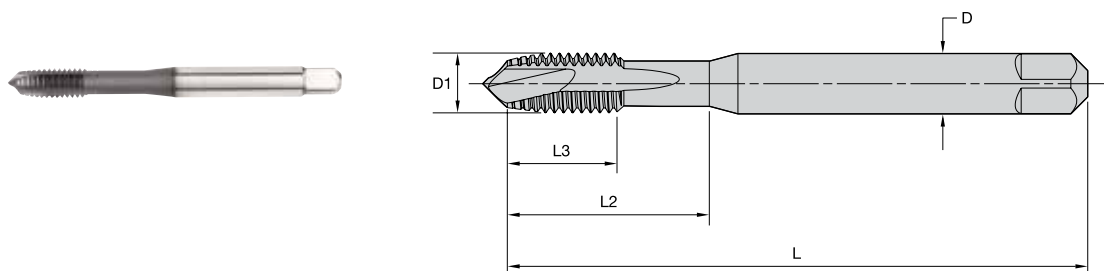

● first choice  
○ alternate choice

grade WP42EG TiCN		grade WP49EG Oxide		D1 TPI	L	L3	L2	D	number of flutes	dimension standard	class of fit
order #	catalog #	order #	catalog #								
5366572	VTSP09004	5366571	VTSP09004	4 - 40	2.20	.31	.71	.141	2	DIN-ANSI	2B
-	-	5366573	VTSP09005	6 - 32	2.20	.35	.79	.141	2	DIN-ANSI	2B
5366576	VTSP09006	5366575	VTSP09006	8 - 32	2.48	.43	.83	.168	2	DIN-ANSI	2B
5366578	VTSP09007	5366577	VTSP09007	10 - 24	2.76	.47	.98	.194	2	DIN-ANSI	2B
5366580	VTSP09008	5366579	VTSP09008	10 - 32	2.75	.47	.98	.194	2	DIN-ANSI	2B
5366582	VTSP09009	5366581	VTSP09009	1/4 - 20	3.15	.59	1.18	.255	3	DIN-ANSI	2B
5366584	VTSP09010	-	-	1/4 - 28	3.14	.58	1.17	.255	3	DIN-ANSI	2B
5366586	VTSP09011	5366585	VTSP09011	5/16 - 18	3.54	.59	1.38	.318	3	DIN-ANSI	2B
5366588	VTSP09012	5366587	VTSP09012	5/16 - 24	3.54	.59	1.38	.318	3	DIN-ANSI	2B
5366590	VTSP09013	5366589	VTSP09013	3/8 - 16	3.94	.75	1.54	.381	3	DIN-ANSI	2B
-	-	5366591	VTSP09014	3/8 - 24	3.94	.75	1.54	.381	3	DIN-ANSI	2B
5366594	VTSP09015	5366593	VTSP09015	7/16 - 14	3.94	.71	1.61	.323	3	DIN-ANSI	2B
5366596	VTSP09016	5366595	VTSP09016	7/16 - 20	3.94	.71	1.61	.323	3	DIN-ANSI	2B
5366598	VTSP09017	5366597	VTSP09017	1/2 - 13	4.33	.91	1.85	.367	3	DIN-ANSI	2B
5366602	VTSP09019	5366601	VTSP09019	5/8 - 11	4.33	.94	2.01	.480	3	DIN-ANSI	2B
-	-	5366603	VTSP09020	5/8 - 18	4.33	.94	2.01	.480	3	DIN-ANSI	2B
5366606	VTSP09021	5366605	VTSP09021	3/4 - 10	4.92	1.18	2.52	.590	3	DIN-ANSI	2B
-	-	5366607	VTSP09022	3/4 - 16	4.92	1.18	2.52	.590	3	DIN-ANSI	2B

INDEXABLE MILLING

SOLID END MILLING

HOLEMAKING

TAPPING

TURNING

VT-SPO • Form B Plug Chamfer • Metric • ANSI

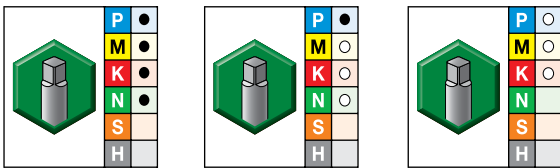
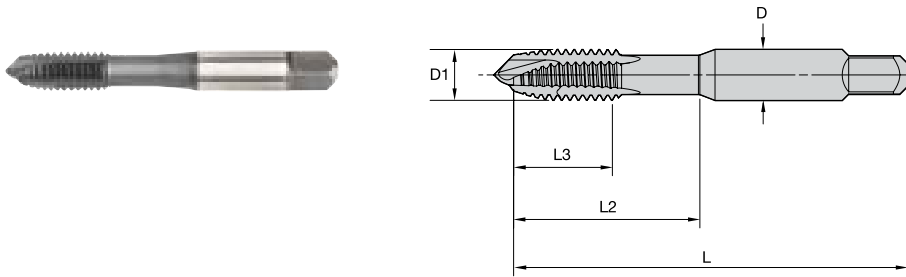

● first choice  
○ alternate choice

grade WP42EG TiCN		grade WU41EG TiN		grade WP49EG Oxide		L		L3		L2		D		number of flutes	pitch diameter limit	
order #	catalog #	order #	catalog #	order #	catalog #	D1 size	mm	in	mm	in	mm	in	mm			in
5362670	VTSP05505	5362671	VTSP05505	5362589	VTSP05505	M3 X 0,5	49,30	1.94	14,80	.58	19,10	.75	3,581	.141	2	D3
-	-	-	-	5362673	VTSP05506	M3 X 0,5	49,30	1.94	14,80	.58	19,10	.75	3,581	.141	2	D11
5631641	VTSP05613	-	-	5631640	VTSP05613	M3 X 0,5	49,30	1.94	14,80	.58	19,10	.75	3,581	.141	3	D3
5631645	VTSP05614	-	-	5631644	VTSP05614	M3 X 0,5	49,30	1.94	14,80	.58	19,10	.75	3,581	.141	3	D11
5362677	VTSP05507	-	-	5362676	VTSP05507	M3,5 X 0,6	50,50	1.99	9,70	.38	18,00	.71	3,581	.141	2	D4
-	-	-	-	5631646	VTSP05615	M3,5 X 0,6	50,50	1.99	9,70	.38	18,00	.71	3,581	.141	3	D4
-	-	-	-	5362695	VTSP05510	M4 X 0,7	53,80	2.12	9,70	.38	19,40	.76	4,267	.168	2	D11
5362692	VTSP05509	5362693	VTSP05509	5362691	VTSP05509	M4 X 0,7	53,80	2.12	9,70	.38	19,40	.76	4,267	.168	2	D4
5631652	VTSP05617	5631653	VTSP05617	5631651	VTSP05617	M4 X 0,7	53,80	2.12	9,70	.38	19,40	.76	4,267	.168	3	D4
-	-	-	-	5631655	VTSP05618	M4 X 0,7	53,80	2.12	9,70	.38	19,40	.76	4,267	.168	3	D11
5362702	VTSP05512	-	-	5362701	VTSP05512	M5 X 0,8	60,30	2.37	12,70	.50	23,20	.91	4,928	.194	2	D11
5362698	VTSP05511	5362699	VTSP05511	5362697	VTSP05511	M5 X 0,8	60,30	2.37	12,70	.50	23,20	.91	4,928	.194	2	D4
5631659	VTSP05619	5631670	VTSP05619	5631658	VTSP05619	M5 X 0,8	60,30	2.37	12,70	.50	23,20	.91	4,928	.194	3	D4
5362704	VTSP05513	5362705	VTSP05513	5362703	VTSP05513	M6 X 1	63,50	2.50	16,00	.63	25,40	1.00	6,477	.255	3	D5
5362708	VTSP05514	-	-	5362707	VTSP05514	M6 X 1	63,50	2.50	16,00	.63	25,40	1.00	6,477	.255	3	D11
5362710	VTSP05515	-	-	5362709	VTSP05515	M7 X 1	69,20	2.72	17,50	.69	29,30	1.15	8,077	.318	3	D5
5362715	VTSP05517	-	-	5362714	VTSP05517	M8 X 1	68,70	2.71	17,50	.69	28,50	1.12	8,077	.318	3	D5
5362722	VTSP05519	5362723	VTSP05519	5362720	VTSP05519	M8 X 1,25	68,90	2.71	17,50	.69	28,60	1.13	8,077	.318	3	D5
5362728	VTSP05520	-	-	5362727	VTSP05520	M8 X 1,25	68,90	2.71	17,50	.69	28,60	1.13	8,077	.318	3	D11
5362730	VTSP05521	-	-	5362729	VTSP05521	M10 X 1	74,00	2.91	19,10	.75	31,60	1.24	9,677	.381	3	D5
5362733	VTSP05522	-	-	5362732	VTSP05522	M10 X 1	74,00	2.91	19,10	.75	31,60	1.24	9,677	.381	3	D11
-	-	-	-	5367307	VTSP05524	M10 X 1,25	74,10	2.92	18,90	.74	31,80	1.25	9,677	.381	3	D11
5367305	VTSP05523	-	-	5367304	VTSP05523	M10 X 1,25	74,10	2.92	18,90	.74	31,80	1.25	9,677	.381	3	D5
5367340	VTSP05525	5367341	VTSP05525	5367309	VTSP05525	M10 X 1,5	74,30	2.92	19,10	.75	31,90	1.26	9,677	.381	3	D6
5367344	VTSP05526	-	-	5367343	VTSP05526	M10 X 1,5	74,30	2.92	19,10	.75	31,90	1.26	9,677	.381	3	D11
5367346	VTSP05527	-	-	5367345	VTSP05527	M12 X 1,25	85,80	3.38	23,90	.94	44,20	1.74	9,322	.367	3	D6
-	-	-	-	5367353	VTSP05530	M12 X 1,5	85,90	3.38	23,90	.94	44,20	1.74	9,322	.367	3	D11
5367351	VTSP05529	-	-	5367350	VTSP05529	M12 X 1,5	85,90	3.38	23,90	.94	44,20	1.74	9,322	.367	3	D6
5367360	VTSP05532	-	-	-	-	M12 X 1,75	85,90	3.38	23,90	.94	44,20	1.74	9,322	.367	3	D11
5367356	VTSP05531	5367357	VTSP05531	5367355	VTSP05531	M12 X 1,75	85,90	3.38	23,90	.94	44,20	1.74	9,322	.367	3	D6
5367362	VTSP05533	-	-	5367361	VTSP05533	M14 X 1,5	91,20	3.59	25,40	1.00	44,20	1.74	10,897	.429	3	D6
5367365	VTSP05534	-	-	5367364	VTSP05534	M14 X 2	91,20	3.59	25,40	1.00	44,20	1.74	10,897	.429	3	D7
5366476	VTSP05535	-	-	5366475	VTSP05535	M16 X 1,5	96,80	3.81	27,70	1.09	48,00	1.89	12,192	.480	3	D6
5366480	VTSP05536	5366481	VTSP05536	5366479	VTSP05536	M16 X 2	96,80	3.81	27,70	1.09	48,00	1.89	12,192	.480	3	D7
5366485	VTSP05537	-	-	5366483	VTSP05537	M18 X 1,5	102,40	4.03	27,70	1.09	48,00	1.89	13,767	.542	3	D6
5366488	VTSP05538	-	-	5366487	VTSP05538	M18 X 2,5	102,40	4.03	31,00	1.22	48,00	1.89	13,767	.542	3	D7
5366491	VTSP05539	-	-	5366490	VTSP05539	M20 X 1,5	113,50	4.47	31,00	1.22	52,80	2.08	16,561	.652	3	D6
5366493	VTSP05540	-	-	5366492	VTSP05540	M20 X 2,5	113,50	4.47	31,00	1.22	52,80	2.08	16,561	.652	3	D7
-	-	-	-	5366494	VTSP05541	M22 X 1,5	119,10	4.69	31,00	1.22	58,40	2.30	17,704	.697	3	D6
-	-	-	-	5366495	VTSP05542	M22 X 2,5	119,10	4.69	31,00	1.22	58,40	2.30	17,704	.697	3	D7
-	-	-	-	5366496	VTSP05543	M24 X 2	124,70	4.91	31,00	1.22	58,40	2.30	19,314	.760	3	D7
-	-	-	-	5366497	VTSP05544	M24 X 3	124,70	4.91	31,00	1.22	58,40	2.30	19,314	.760	3	D8
-	-	-	-	5366498	VTSP05545	M27 X 1,5	130,30	5.13	31,00	1.22	63,50	2.50	22,758	.896	4	D7
-	-	-	-	5366499	VTSP05546	M27 X 3	130,30	5.13	31,00	1.22	63,50	2.50	22,758	.896	4	D8
-	-	-	-	5366510	VTSP05547	M30 X 1,5	138,20	5.44	31,00	1.22	65,00	2.56	25,933	1.021	4	D6
-	-	-	-	5366511	VTSP05548	M30 X 3,5	138,20	5.44	31,00	1.22	65,00	2.56	25,933	1.021	4	D9

INDEXABLE MILLING

SOLID END MILLING

HOLEMAKING

TAPPING

TURNING

VT-SPO • Form B Plug Chamfer • Metric • DIN Length ANSI Shank

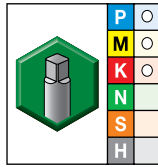
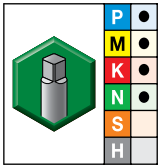
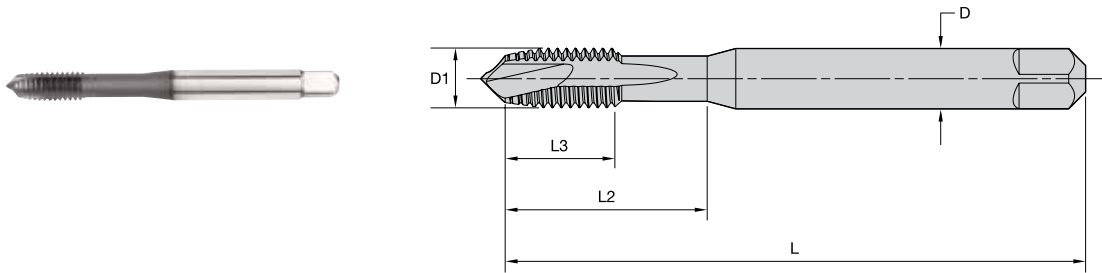

● first choice  
○ alternate choice

grade WP42EG TiCN		grade WP49EG Oxide		D1 size	L	L3	L2	D	number of flutes	dimension standard	class of fit
order #	catalog #	order #	catalog #								
5368174	VTSP09507	5368173	VTSP09507	M4 X 0,7	2.48	.43	.83	.168	2	DIN-ANSI	6H
5368176	VTSP09508	5368175	VTSP09508	M5 X 0,8	2.75	.47	.97	.194	2	DIN-ANSI	6H
5368178	VTSP09509	5368177	VTSP09509	M6 X 1	3.15	.47	1.18	.255	3	DIN-ANSI	6H
5368180	VTSP09510	5368179	VTSP09510	M8 X 1,25	3.54	.59	1.37	.318	3	DIN-ANSI	6H
5368184	VTSP09512	5368183	VTSP09512	M10 X 1,5	3.94	.71	1.53	.381	3	DIN-ANSI	6H
-	-	5368187	VTSP09514	M12 X 1,5	4.33	.83	1.73	.367	3	DIN-ANSI	6H
5368190	VTSP09515	5368189	VTSP09515	M12 X 1,75	4.33	.83	1.73	.367	3	DIN-ANSI	6H
5368197	VTSP09518	5368196	VTSP09518	M16 X 1,5	4.33	.94	2.01	.480	3	DIN-ANSI	6H
5368199	VTSP09519	5368198	VTSP09519	M16 X 2	4.33	.94	2.01	.480	3	DIN-ANSI	6H
-	-	5368200	VTSP09520	M18 X 1,5	4.92	1.18	2.28	.542	3	DIN-ANSI	6H
-	-	5368202	VTSP09521	M18 X 2,5	4.92	1.18	2.28	.542	3	DIN-ANSI	6H
5368207	VTSP09523	-	-	M20 X 2,5	5.51	1.18	2.52	.652	3	DIN-ANSI	6H

INDEXABLE MILLING

SOLID END MILLING

HOLEMAKING

TAPPING

TURNING

VT-SPO • Form B Plug Chamfer • Through Coolant • Fractional • DIN Length ANSI Shank

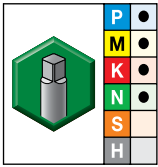
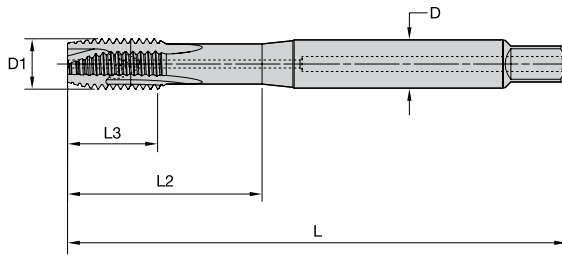

● first choice  
○ alternate choice

grade WP42EG  
TiCN

order #	catalog #	D1 TPI	L	L3	L2	D	number of flutes	dimension standard	class of fit
5368496	VTSP09709	3/8 - 16	3.94	.75	1.54	.381	3	DIN-ANSI	2B
5368501	VTSP09713	1/2 - 13	4.33	.91	1.85	.367	3	DIN-ANSI	2B
5368503	VTSP09715	9/16 - 18	4.33	.98	2.09	.429	3	DIN-ANSI	2B
5368508	VTSP09719	3/4 - 16	4.92	1.18	2.52	.590	3	DIN-ANSI	2B

INDEXABLE MILLING

SOLID END MILLING

HOLE/MAKING

TAPPING

TURNING

VT-SFT • Form C Semi-Bottoming Chamfer • Machine Screw and Fractional • DIN Length ANSI Shank

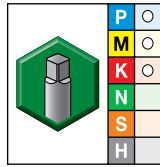
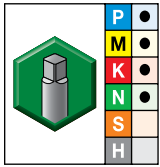
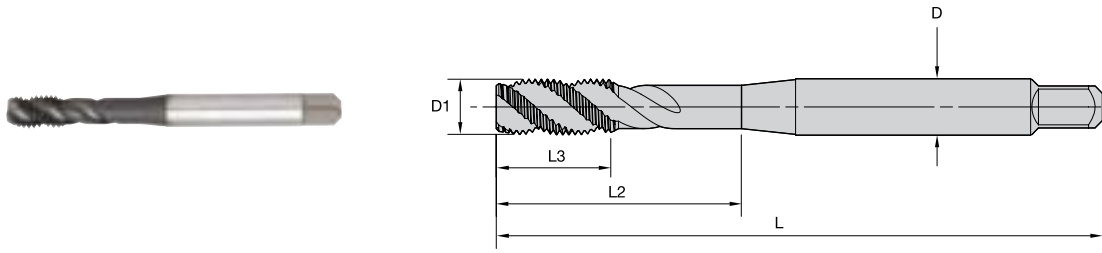

● first choice  
○ alternate choice

grade WP42EG TiCN		grade WP49EG Oxide		D1 size	L	L3	L2	D	number of flutes	dimension standard	class of fit
order #	catalog #	order #	catalog #								
5436673	VTSFT9008	-	-	4 - 40	2.20	.31	.71	.141	2	DIN-ANSI	2B
5436675	VTSFT9009	5436674	VTSFT9009	6 - 32	2.20	.35	.79	.141	2	DIN-ANSI	2B
5436677	VTSFT9010	-	-	8 - 32	2.48	.43	.83	.168	3	DIN-ANSI	2B
5436679	VTSFT9011	-	-	10 - 24	2.76	.47	.99	.194	3	DIN-ANSI	2B
5436701	VTSFT9012	-	-	10 - 32	2.75	.47	.98	.194	3	DIN-ANSI	2B
5436703	VTSFT9013	5436702	VTSFT9013	1/4 - 20	3.15	.59	1.18	.255	3	DIN-ANSI	2B
5436705	VTSFT9014	5436704	VTSFT9014	1/4 - 28	3.14	.58	1.17	.255	3	DIN-ANSI	2B
5436707	VTSFT9015	5436706	VTSFT9015	5/16 - 18	3.54	.59	1.38	.318	3	DIN-ANSI	2B
5436709	VTSFT9016	-	-	5/16 - 24	3.53	.58	1.37	.318	3	DIN-ANSI	2B
5436721	VTSFT9017	5436720	VTSFT9017	3/8 - 16	3.94	.75	1.54	.381	3	DIN-ANSI	2B
5436723	VTSFT9018	-	-	3/8 - 24	3.92	.73	1.52	.381	3	DIN-ANSI	2B
-	-	5436724	VTSFT9019	7/16 - 14	3.94	.71	1.61	.323	3	DIN-ANSI	2B
5436727	VTSFT9020	-	-	7/16 - 20	3.94	.71	1.61	.323	3	DIN-ANSI	2B
5436729	VTSFT9021	5436728	VTSFT9021	1/2 - 13	4.33	.91	1.85	.367	3	DIN-ANSI	2B
5436733	VTSFT9023	5436732	VTSFT9023	5/8 - 11	4.33	.94	2.01	.480	3	DIN-ANSI	2B
5436735	VTSFT9024	-	-	5/8 - 18	4.33	.94	2.01	.480	3	DIN-ANSI	2B
5436737	VTSFT9025	-	-	3/4 - 10	4.92	1.18	2.52	.590	4	DIN-ANSI	2B
-	-	5436736	VTSFT9025	3/4 - 10	4.92	1.18	2.52	.590	3	DIN-ANSI	2B

NOTE: Suggested for use in rigid and synchronous holders.

INDEXABLE MILLING

SOLID END MILLING

HOLEMAKING

TAPPING

TURNING

VT-SFT • Form C Semi-Bottoming Chamfer • Metric • ANSI

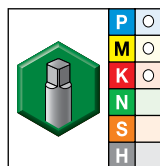
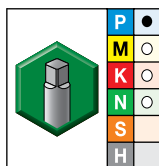
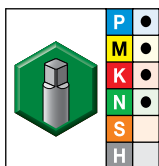
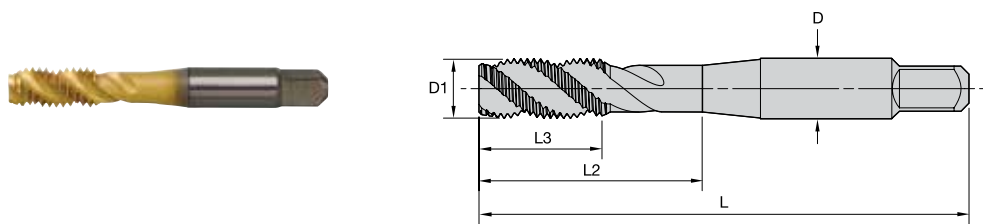

● first choice  
○ alternate choice

grade WP42EG TiCN		grade WU41EG TiN		grade WP49EG Oxide		L		L3		L2		D		number of flutes	pitch diameter limit	
order #	catalog #	order #	catalog #	order #	catalog #	D1 size	mm	in	mm	in	mm	in	mm			in
5357039	VTSFT5507	-	-	5357031	VTSFT5505	M3 X 0,5	49,20	1.94	14,80	.58	19,10	.75	3,581	.141	2	D3
-	-	-	-	5357038	VTSFT5507	M3,5 X 0,6	50,50	1.99	9,70	.38	18,00	.71	3,581	.141	2	D4
-	-	5357056	VTSFT5509	5357054	VTSFT5509	M4 X 0,7	53,80	2.12	9,70	.38	19,40	.76	4,267	.168	3	D4
-	-	-	-	5357060	VTSFT5511	M5 X 0,8	60,30	2.37	12,70	.50	23,20	.91	4,928	.194	3	D4
5357066	VTSFT5512	-	-	-	-	M5 X 0,8	60,30	2.37	12,70	.50	23,20	.91	4,928	.194	3	D11
-	-	5357069	VTSFT5513	5357067	VTSFT5513	M6 X 1	63,50	2.50	16,00	.63	25,50	1.01	6,477	.255	3	D5
5357083	VTSFT5514	-	-	-	-	M6 X 1	63,50	2.50	16,00	.63	25,50	1.01	6,477	.255	3	D11
-	-	-	-	5357084	VTSFT5515	M7 X 1	69,20	2.73	17,50	.69	29,30	1.15	8,077	.318	3	D5
5357101	VTSFT5517	5357102	VTSFT5517	5357100	VTSFT5517	M8 X 1	68,70	2.71	17,50	.69	28,50	1.12	8,077	.318	3	D5
-	-	-	-	5357106	VTSFT5519	M8 X 1,25	68,70	2.71	17,50	.69	28,50	1.12	8,077	.318	3	D5
5357123	VTSFT5520	-	-	5357121	VTSFT5520	M8 X 1,25	68,70	2.71	17,50	.69	28,50	1.12	8,077	.318	3	D11
5365567	VTSFT5521	-	-	5365566	VTSFT5521	M10 X 1	74,00	2.91	18,70	.74	31,60	1.24	9,677	.381	3	D5
5365590	VTSFT5522	-	-	-	-	M10 X 1	73,90	2.91	18,70	.74	31,60	1.24	9,677	.381	3	D11
5365592	VTSFT5523	-	-	5365591	VTSFT5523	M10 X 1,25	74,10	2.92	18,90	.74	31,80	1.25	9,677	.381	3	D5
5365598	VTSFT5525	-	-	5365597	VTSFT5525	M10 X 1,5	74,30	2.92	19,00	.75	31,90	1.26	9,677	.381	3	D6
5365612	VTSFT5526	-	-	-	-	M10 X 1,5	74,20	2.92	19,00	.75	31,90	1.25	9,677	.381	3	D11
5365614	VTSFT5527	-	-	5365613	VTSFT5527	M12 X 1,25	85,90	3.38	23,90	.94	44,20	1.74	9,322	.367	3	D5
5365621	VTSFT5529	-	-	-	-	M12 X 1,5	85,90	3.38	23,90	.94	44,20	1.74	9,322	.367	3	D6
5365624	VTSFT5530	-	-	-	-	M12 X 1,5	85,90	3.38	23,90	.94	44,20	1.74	9,322	.367	3	D11
-	-	-	-	5365625	VTSFT5531	M12 X 1,75	85,90	3.38	23,90	.94	44,20	1.74	9,322	.367	3	D6
-	-	-	-	5365629	VTSFT5532	M12 X 1,75	85,90	3.38	23,90	.94	44,20	1.74	9,322	.367	3	D11
-	-	-	-	5365635	VTSFT5535	M14 X 2	91,20	3.59	25,40	1.00	44,20	1.74	10,897	.429	3	D7
-	-	-	-	5365637	VTSFT5536	M16 X 1,5	96,80	3.81	27,70	1.09	48,00	1.89	12,192	.480	3	D6
-	-	-	-	5365640	VTSFT5537	M16 X 2	96,80	3.81	27,70	1.09	48,00	1.89	12,192	.480	3	D7
5365650	VTSFT5540	-	-	-	-	M20 X 1,5	113,50	4.47	31,00	1.22	52,80	2.08	16,561	.652	4	D6
-	-	-	-	5365651	VTSFT5541	M20 X 2,5	113,50	4.47	31,00	1.22	52,80	2.08	16,561	.652	4	D7
-	-	-	-	5365656	VTSFT5545	M24 X 3	124,70	4.91	34,00	1.34	58,40	2.30	19,304	.760	4	D8
-	-	-	-	5365660	VTSFT5549	M30 X 3,5	138,20	5.44	43,50	1.71	65,00	2.56	25,933	1.021	4	D9

NOTE: Refer to tables on page D128 for the recommended pitch diameter limit for 6H class of fit.  
VariTap for 6H class of fit is suitable for MJ aerospace internal threading applications.



VT-SFT • Form C Semi-Bottoming Chamfer • Metric • DIN Length ANSI Shank

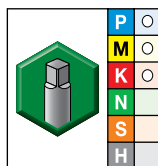
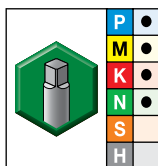
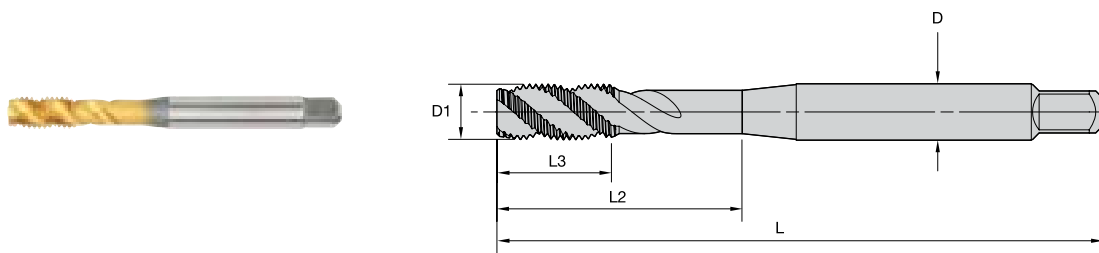

● first choice  
○ alternate choice

grade WP42EG TiCN		grade WP49EG Oxide		D1 size	L	L3	L2	D	number of flutes	dimension standard	class of fit
order #	catalog #	order #	catalog #								
5436528	VTSFT9507	5436527	VTSFT9507	M6 X 1	3.15	.47	1.18	.255	3	DIN-ANSI	6H
5436540	VTSFT9508	-	-	M8 X 1,25	3.54	.58	1.37	.318	3	DIN-ANSI	6H
5436544	VTSFT9510	-	-	M10 X 1,5	3.94	.71	1.53	.381	3	DIN-ANSI	6H
5436546	VTSFT9511	-	-	M12 X 1,25	4.33	.83	1.73	.367	3	DIN-ANSI	6H
5436550	VTSFT9513	-	-	M12 X 1,75	4.33	.83	1.73	.367	3	DIN-ANSI	6H

NOTE: Suggested for use in rigid and synchronous holders.

INDEXABLE MILLING

SOLID END MILLING

HOLEMAKING

TAPPING

TURNING

VT-SFT • Form C Semi-Bottoming Chamfer • Through Coolant • Fractional • DIN Length ANSI Shank

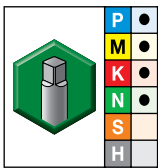
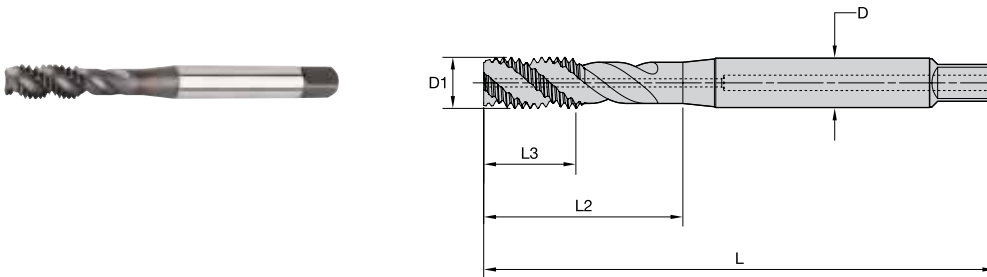

- first choice
- alternate choice

grade WP42EG  
TiCN

order #	catalog #	D1 TPI	L	L3	L2	D	number of flutes	dimension standard	class of fit
5436357	VTSFT9762	1/4 - 20	3.15	.59	1.18	.255	3	DIN-ANSI	2B
5436359	VTSFT9764	5/16 - 18	3.54	.59	1.38	.318	3	DIN-ANSI	2B
5436461	VTSFT9766	3/8 - 16	3.94	.75	1.54	.381	3	DIN-ANSI	2B
5436462	VTSFT9767	3/8 - 24	3.94	.75	1.54	.381	3	DIN-ANSI	2B
5436463	VTSFT9768	7/16 - 14	3.94	.71	1.61	.323	3	DIN-ANSI	2B
5436465	VTSFT9770	1/2 - 13	3.94	.91	1.85	.367	3	DIN-ANSI	2B
5436468	VTSFT9773	5/8 - 11	4.33	.94	2.01	.480	3	DIN-ANSI	2B
5436473	VTSFT9778	7/8 - 14	5.51	1.34	2.80	.697	4	DIN-ANSI	2B

NOTE: Suggested for use in rigid and synchronous holders.

VT-SFT • Form C Semi-Bottoming Chamfer • Through Coolant • Metric • DIN Length ANSI Shank

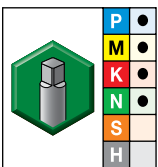
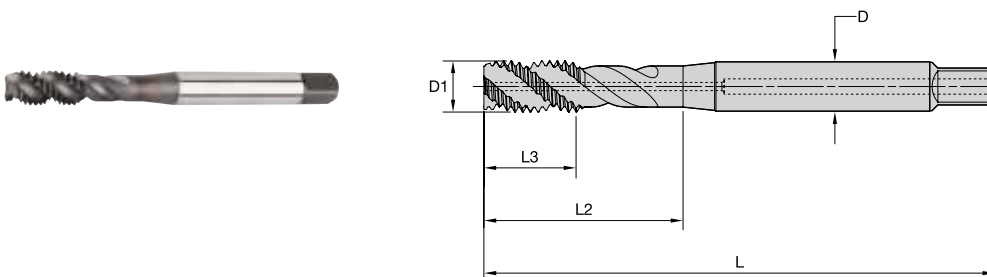

- first choice
- alternate choice

grade WP42EG  
TiCN

order #	catalog #	D1 size	L	L3	L2	D	number of flutes	dimension standard	class of fit
5436475	VTSFT9925	M6 X 1	3.15	.47	1.18	.255	3	DIN-ANSI	6H
5436476	VTSFT9926	M8 X 1,25	3.54	.59	1.38	.318	3	DIN-ANSI	6H
5436478	VTSFT9928	M10 X 1,5	3.94	.71	1.53	.381	3	DIN-ANSI	6H
5436481	VTSFT9931	M12 X 1,75	4.33	.83	1.73	.367	3	DIN-ANSI	6H

NOTE: Suggested for use in rigid and synchronous holders.

VT-SFT • Form E Bottoming Chamfer • Machine Screw and Fractional • ANSI

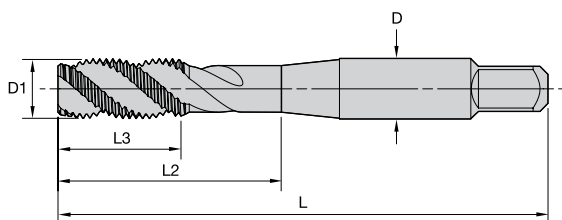
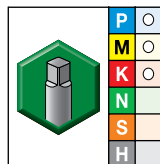

● first choice  
○ alternate choice

grade WP49EG Oxide								
order #	catalog #	D1 TPI	L	L3	L2	D	number of flutes	pitch diameter limit
5356668	VTSFT5001	2 - 56	1.76	.40	.50	.141	2	H2
5356731	VTSFT5002	3 - 48	1.82	.46	.57	.141	2	H2
5356734	VTSFT5003	4 - 40	1.88	.52	.70	.141	2	H2
5356738	VTSFT5004	4 - 40	1.88	.52	.70	.141	2	H3
5356748	VTSFT5008	4 - 48	1.88	.53	.70	.141	2	H2
5356751	VTSFT5009	5 - 40	1.95	.59	.76	.141	2	H2
5356755	VTSFT5010	6 - 32	2.00	.39	.72	.141	2	H2
5356758	VTSFT5011	6 - 32	2.00	.39	.72	.141	2	H3
5356763	VTSFT5013	6 - 32	2.00	.39	.72	.141	2	H5
5356775	VTSFT5017	6 - 40	2.00	.39	.72	.141	2	H3
5357303	VTSFT5018	8 - 32	2.13	.38	.77	.168	3	H2
5357306	VTSFT5019	8 - 32	2.13	.38	.77	.168	3	H3
5357370	VTSFT5020	8 - 32	2.13	.38	.77	.168	3	H4
5357371	VTSFT5021	8 - 32	2.13	.38	.77	.168	3	H5
5357375	VTSFT5023	8 - 32	2.13	.38	.77	.168	3	H7
5357381	VTSFT5025	8 - 36	2.13	.38	.77	.168	3	H3
5357382	VTSFT5026	10 - 24	2.38	.50	.92	.194	3	H2
5357383	VTSFT5027	10 - 24	2.38	.50	.92	.194	3	H3
5357388	VTSFT5029	10 - 24	2.38	.50	.92	.194	3	H5
5357391	VTSFT5030	10 - 24	2.38	.50	.92	.194	3	H7
5357395	VTSFT5032	10 - 32	2.38	.50	.92	.194	3	H2
5357398	VTSFT5033	10 - 32	2.38	.50	.92	.194	3	H3
5357402	VTSFT5034	10 - 32	2.38	.50	.92	.194	3	H4
5357403	VTSFT5035	10 - 32	2.37	.50	.91	.194	3	H5
5357406	VTSFT5036	10 - 32	2.38	.50	.92	.194	3	H6
5357407	VTSFT5037	10 - 32	2.38	.50	.92	.194	3	H7
5364105	VTSFT5039	12 - 24	2.43	.50	.96	.220	3	H3
5364108	VTSFT5040	12 - 28	2.43	.50	.96	.220	3	H3
5364451	VTSFT5041	1/4 - 20	2.50	.63	1.00	.255	3	H3
5364455	VTSFT5042	1/4 - 20	2.50	.63	1.00	.255	3	H5
5364458	VTSFT5043	1/4 - 20	2.50	.63	1.00	.255	3	H7
5364484	VTSFT5045	1/4 - 28	2.49	.62	1.00	.255	3	H3
5364488	VTSFT5046	1/4 - 28	2.49	.62	1.00	.255	3	H4
5364491	VTSFT5047	1/4 - 28	2.49	.62	1.00	.255	3	H5
5364495	VTSFT5049	1/4 - 28	2.49	.62	1.00	.255	3	H7
5364502	VTSFT5051	5/16 - 18	2.72	.69	1.13	.318	3	H3
5364506	VTSFT5052	5/16 - 18	2.72	.69	1.13	.318	3	H5
5364509	VTSFT5053	5/16 - 18	2.72	.69	1.13	.318	3	H7
5364512	VTSFT5054	5/16 - 18	2.72	.69	1.13	.318	3	H11
5364515	VTSFT5055	5/16 - 24	2.71	.68	1.13	.318	3	H3
5364519	VTSFT5056	5/16 - 24	2.71	.68	1.13	.318	3	H4
5364532	VTSFT5057	5/16 - 24	2.71	.68	1.13	.318	3	H5
5364538	VTSFT5059	5/16 - 24	2.71	.68	1.12	.318	3	H7
5364544	VTSFT5061	3/8 - 16	2.94	.75	1.27	.381	3	H3
5364549	VTSFT5062	3/8 - 16	2.94	.75	1.27	.381	3	H5
5364553	VTSFT5063	3/8 - 16	2.94	.75	1.27	.381	3	H7
5364556	VTSFT5064	3/8 - 16	2.93	.75	1.27	.381	3	H11
5364559	VTSFT5065	3/8 - 24	2.92	.74	1.25	.381	3	H3
5364566	VTSFT5067	3/8 - 24	2.92	.74	1.25	.381	3	H5
5364577	VTSFT5071	7/16 - 14	3.16	.88	1.42	.323	3	H3
5364601	VTSFT5072	7/16 - 14	3.16	.88	1.42	.323	3	H5
5364610	VTSFT5075	7/16 - 20	3.16	.88	1.42	.323	3	H3
5364614	VTSFT5076	7/16 - 20	3.16	.88	1.42	.323	3	H5
5364624	VTSFT5080	1/2 - 13	3.38	.94	1.65	.367	3	H3
5364628	VTSFT5081	1/2 - 13	3.38	.94	1.65	.367	3	H5
5364631	VTSFT5082	1/2 - 13	3.38	.94	1.65	.367	3	H7
5364634	VTSFT5083	1/2 - 13	3.38	.94	1.65	.367	3	H11
5364637	VTSFT5084	1/2 - 20	3.38	.94	1.65	.367	3	H3
5364641	VTSFT5085	1/2 - 20	3.38	.94	1.65	.367	3	H5
5364644	VTSFT5086	1/2 - 20	3.38	.94	1.65	.367	3	H6
5364645	VTSFT5087	1/2 - 20	3.38	.94	1.74	.367	3	H7
5364671	VTSFT5089	9/16 - 12	3.59	1.00	1.74	.429	3	H3
5364677	VTSFT5091	9/16 - 18	3.59	1.00	1.74	.429	3	H3
5364681	VTSFT5092	9/16 - 18	3.59	1.00	1.74	.429	3	H5

INDEXABLE MILLING

SOLID END MILLING

HOLEMAKING

TAPPING

TURNING

VT-SFT • Form E Bottoming Chamfer • Machine Screw and Fractional • ANSI

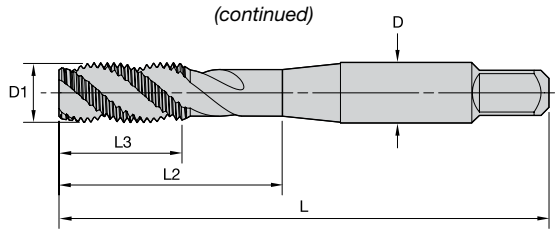
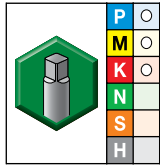

- first choice
- alternate choice

grade WP49EG Oxide		D1	L	L3	L2	D	number of flutes	pitch diameter limit
5364683	VTSFT5093	5/8 - 11	3.81	2.00	1.89	.480	3	H3
5364687	VTSFT5094	5/8 - 11	3.81	1.09	1.89	.480	3	H5
5364690	VTSFT5095	5/8 - 11	3.81	1.09	1.89	.480	3	H7
5364691	VTSFT5096	5/8 - 18	3.81	1.09	1.89	.480	3	H3
5364695	VTSFT5097	5/8 - 18	3.81	1.09	1.89	.480	3	H5
5364698	VTSFT5099	5/8 - 18	3.81	1.09	1.89	.480	3	H7
5364699	VTSFT5100	3/4 - 10	4.25	1.22	2.08	.590	4	H3
5364703	VTSFT5101	3/4 - 10	4.25	1.22	2.08	.590	4	H5
5364706	VTSFT5102	3/4 - 16	4.25	1.22	2.08	.590	4	H3
5364710	VTSFT5103	3/4 - 16	4.25	1.22	2.08	.590	4	H5
5364713	VTSFT5104	3/4 - 16	4.25	1.22	2.08	.590	4	H7
5364714	VTSFT5105	7/8 - 9	4.69	1.34	2.30	.697	4	H4
5364721	VTSFT5107	7/8 - 14	4.69	1.34	2.30	.697	4	H4
5364726	VTSFT5108	1 - 8	5.13	1.50	2.58	.800	4	H5
5364729	VTSFT5109	1 - 12	5.13	1.50	2.58	.800	4	H4
5364742	VTSFT5110	1 1/8 - 7	5.44	1.71	2.56	.896	4	H6
5364744	VTSFT5111	1 1/8 - 8	5.44	1.71	2.56	.896	4	H6
5364743	VTSFT5112	1 1/8 - 12	5.44	1.71	2.56	.896	4	H5
5364746	VTSFT5113	1 1/4 - 7	5.75	1.71	2.56	1.021	4	H6
5364747	VTSFT5114	1 1/4 - 12	5.75	1.71	2.56	1.021	4	H5
5364748	VTSFT5115	1 1/4 - 8	5.75	1.71	2.56	1.021	4	H6
5364751	VTSFT5118	1 3/8 - 8	6.06	2.00	3.00	1.108	5	H6
5364752	VTSFT5119	1 1/2 - 6	6.38	2.00	3.00	1.233	5	H6
5364754	VTSFT5120	1 1/2 - 8	6.38	2.00	3.00	1.233	5	H6
5364753	VTSFT5121	1 1/2 - 12	6.38	2.00	3.00	1.233	5	H5
5364755	VTSFT5122	1 3/4 - 5	7.00	2.40	3.19	1.429	5	H7
5390146	VTSFT5131	4 - 40	1.88	.51	.69	.141	2	H3
5390148	VTSFT5133	5 - 40	1.94	.58	.75	.141	2	H2
5390220	VTSFT5135	6 - 32	1.99	.38	.71	.141	2	H3
5390223	VTSFT5138	6 - 40	1.99	.37	.71	.141	2	H3
5390224	VTSFT5139	8 - 32	2.12	.38	.76	.168	3	H2
5390225	VTSFT5140	8 - 32	2.12	.38	.76	.168	3	H3
5390226	VTSFT5141	8 - 32	2.12	.38	.76	.168	3	H5
5390227	VTSFT5142	10 - 24	2.37	.50	.91	.194	3	H3
5390228	VTSFT5143	10 - 24	2.37	.50	.91	.194	3	H5
5390229	VTSFT5144	10 - 32	2.36	.49	.91	.194	3	H3
5390230	VTSFT5145	10 - 32	2.36	.49	.91	.194	3	H5
5390231	VTSFT5146	1/4 - 20	2.50	.63	1.00	.255	3	H3
5390232	VTSFT5147	1/4 - 20	2.50	.63	1.00	.255	3	H5
5390233	VTSFT5148	1/4 - 28	2.49	.62	1.00	.255	3	H3
5390234	VTSFT5149	1/4 - 28	2.49	.62	1.00	.255	3	H5
5390235	VTSFT5150	5/16 - 18	2.72	.69	1.13	.318	3	H3
5390236	VTSFT5151	5/16 - 18	2.72	.69	1.13	.318	3	H5
5390237	VTSFT5152	5/16 - 24	2.71	.68	1.13	.318	3	H3
5390238	VTSFT5153	5/16 - 24	2.71	.68	1.12	.318	3	H5
5390239	VTSFT5154	3/8 - 16	2.94	.75	1.27	.381	3	H5
5390240	VTSFT5155	3/8 - 16	2.94	.75	1.27	.381	3	H3
5390241	VTSFT5156	3/8 - 24	2.92	.74	1.25	.381	3	H5
5390243	VTSFT5158	3/8 - 24	2.92	.74	1.25	.381	3	H3
5390244	VTSFT5159	7/16 - 14	3.16	.88	1.49	.323	3	H3
5390245	VTSFT5160	7/16 - 14	3.16	.88	1.49	.323	3	H5
5390246	VTSFT5161	7/16 - 20	3.16	.88	1.49	.323	3	H3
5390247	VTSFT5162	7/16 - 20	3.16	.88	1.49	.323	3	H5
5390248	VTSFT5163	1/2 - 13	3.38	.94	1.74	.367	3	H3
5390249	VTSFT5164	1/2 - 13	3.38	.94	1.74	.367	3	H5
5390260	VTSFT5165	1/2 - 20	3.38	.94	1.74	.367	3	H3
5390262	VTSFT5167	9/16 - 18	3.59	1.00	1.74	.429	3	H3
5390263	VTSFT5168	5/8 - 11	3.81	1.09	1.89	.480	3	H3
5390264	VTSFT5169	5/8 - 11	3.81	1.09	1.89	.480	3	H5
5390265	VTSFT5170	5/8 - 18	3.81	1.09	1.89	.480	3	H3
5390266	VTSFT5171	5/8 - 18	3.81	1.09	1.89	.480	3	H5
5390267	VTSFT5172	3/4 - 10	4.25	1.22	2.08	.590	4	H3
5390268	VTSFT5173	3/4 - 16	4.25	1.22	2.08	.590	4	H3

VT-SFT • Form E Bottoming Chamfer • Metric • ANSI

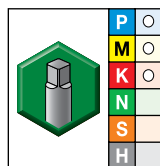
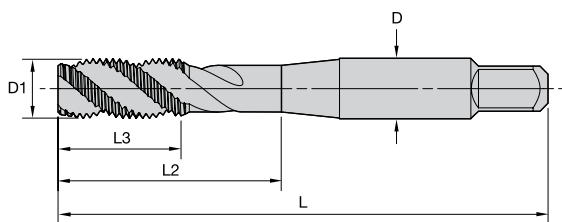

- first choice
- alternate choice

grade WP49EG Oxide		D1 size	L	L3	L2	D	number of flutes	pitch diameter limit
5400155	VTSFT5550	M3 X 0,5	1.94	.58	.75	.141	2	D3
5400157	VTSFT5552	M4 X 0,7	2.13	.38	.76	.168	3	D4
5400158	VTSFT5553	M5 X 0,8	2.38	.50	.91	.194	3	D4
5400159	VTSFT5554	M6 X 1	2.50	.63	1.00	.255	3	D5
5400231	VTSFT5556	M8 X 1,25	2.72	.69	1.12	.318	3	D5
5400233	VTSFT5558	M10 X 1,5	2.94	.75	1.26	.381	3	D6
5400235	VTSFT5560	M12 X 1,75	3.38	.94	1.74	.367	3	D6
5400239	VTSFT5564	M14 X 1,5	3.59	1.00	1.74	.429	3	D6
5400241	VTSFT5566	M16 X 1,5	3.81	1.09	1.89	.480	3	D6
5400240	VTSFT5565	M16 X 2	3.81	1.09	1.89	.480	3	D7

NOTE: Refer to tables on page D128 for the recommended pitch diameter limit for 6H class of fit.  
VariTap for 6H class of fit is suitable for MJ aerospace internal threading applications.

INDEXABLE MILLING

SOLID END MILLING

HOLEMAKING

TAPPING

TURNING

VT-SFT TC • Form C Semi-Bottoming Chamfer • Machine Screw and Fractional • ANSI • Tension/Compression Holders

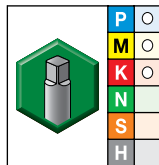
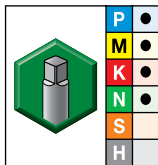
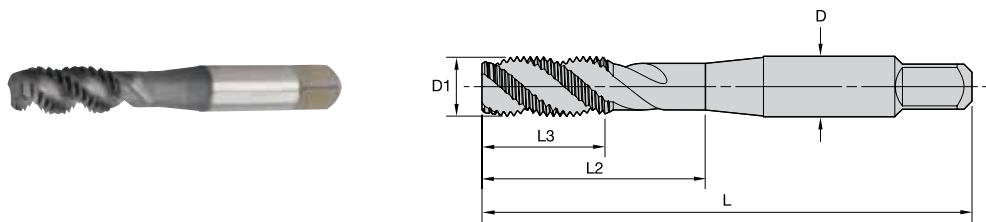

● first choice  
○ alternate choice

grade WP42EG TiCN		grade WP49EG Oxide		D1 TPI	L	L3	L2	D	number of flutes	pitch diameter limit
6140248	VTSFT-TC5001	6140249	VTSFT-TC5001	2 - 56	1.76	.39	.50	.141	2	H2
6140250	VTSFT-TC5002	6140271	VTSFT-TC5002	3 - 48	1.82	.46	.57	.141	2	H2
6140272	VTSFT-TC5003	6140273	VTSFT-TC5003	4 - 40	1.88	.52	.70	.141	2	H2
6140274	VTSFT-TC5004	6140275	VTSFT-TC5004	4 - 40	1.88	.52	.70	.141	2	H3
-	-	6140279	VTSFT-TC5006	4 - 40	1.88	.52	.70	.141	2	H5
-	-	6140280	VTSFT-TC5007	4 - 40	1.88	.52	.70	.141	2	H6
-	-	6140282	VTSFT-TC5008	4 - 48	1.88	.53	.70	.141	2	H2
6140283	VTSFT-TC5009	6140284	VTSFT-TC5009	5 - 40	1.95	.59	.76	.141	2	H2
6140285	VTSFT-TC5010	6140286	VTSFT-TC5010	6 - 32	2.00	.39	.72	.141	2	H2
5886705	VTSFT-TC5011	5886704	VTSFT-TC5011	6 - 32	2.00	.38	.72	.141	3	H3
-	-	6140287	VTSFT-TC5012	6 - 32	2.00	.39	.72	.141	2	H4
6140288	VTSFT-TC5013	-	-	6 - 32	2.00	.38	.71	.141	2	H5
-	-	5886706	VTSFT-TC5013	6 - 32	2.00	.38	.71	.141	3	H5
-	-	6140292	VTSFT-TC5015	6 - 32	2.00	.39	.72	.141	2	H11
6140293	VTSFT-TC5016	6140294	VTSFT-TC5016	6 - 40	2.00	.39	.72	.141	2	H2
-	-	6140295	VTSFT-TC5017	6 - 40	2.00	.39	.72	.141	2	H3
6140296	VTSFT-TC5018	6140297	VTSFT-TC5018	8 - 32	2.13	.38	.77	.168	3	H2
5886708	VTSFT-TC5019	5886707	VTSFT-TC5019	8 - 32	2.13	.38	.77	.168	3	H3
-	-	6140298	VTSFT-TC5020	8 - 32	2.13	.38	.77	.168	3	H4
6140299	VTSFT-TC5021	5886709	VTSFT-TC5021	8 - 32	2.13	.38	.77	.168	3	H5
-	-	6140302	VTSFT-TC5023	8 - 32	2.13	.38	.77	.168	3	H7
-	-	6140305	VTSFT-TC5025	8 - 36	2.13	.38	.77	.168	3	H3
-	-	6140306	VTSFT-TC5026	10 - 24	2.38	.50	.92	.194	3	H2
5887031	VTSFT-TC5027	5886710	VTSFT-TC5027	10 - 24	2.38	.50	.92	.194	3	H3
-	-	6140307	VTSFT-TC5028	10 - 24	2.38	.50	.92	.194	3	H4
-	-	5887032	VTSFT-TC5029	10 - 24	2.38	.50	.92	.194	3	H5
-	-	6140309	VTSFT-TC5030	10 - 24	2.38	.50	.92	.194	3	H7
6140310	VTSFT-TC5031	-	-	10 - 24	2.38	.50	.92	.194	3	H11
6140312	VTSFT-TC5032	6140313	VTSFT-TC5032	10 - 32	2.38	.50	.92	.194	3	H2
5887034	VTSFT-TC5033	5887033	VTSFT-TC5033	10 - 32	2.38	.50	.92	.194	3	H3
-	-	6140314	VTSFT-TC5034	10 - 32	2.38	.50	.92	.194	3	H4
6140315	VTSFT-TC5035	-	-	10 - 32	2.38	.50	.91	.194	3	H5
-	-	5887035	VTSFT-TC5035	10 - 32	2.37	.50	.91	.194	3	H5
-	-	6140316	VTSFT-TC5036	10 - 32	2.38	.50	.92	.194	3	H6
-	-	6140318	VTSFT-TC5037	10 - 32	2.38	.50	.92	.194	3	H7
5887037	VTSFT-TC5039	5887036	VTSFT-TC5039	12 - 24	2.43	.50	.96	.220	3	H3
6140321	VTSFT-TC5040	6140322	VTSFT-TC5040	12 - 28	2.43	.50	.96	.220	3	H3
5887039	VTSFT-TC5041	5887038	VTSFT-TC5041	1/4 - 20	2.50	.63	1.00	.255	3	H3
6140183	VTSFT-TC5042	5887040	VTSFT-TC5042	1/4 - 20	2.50	.63	1.00	.255	3	H5
6140184	VTSFT-TC5043	6140185	VTSFT-TC5043	1/4 - 20	2.50	.63	1.00	.255	3	H7
6140186	VTSFT-TC5044	6140187	VTSFT-TC5044	1/4 - 20	2.50	.63	1.00	.255	3	H11
5887042	VTSFT-TC5045	5887041	VTSFT-TC5045	1/4 - 28	2.49	.62	1.00	.255	3	H3
6140188	VTSFT-TC5046	6140190	VTSFT-TC5046	1/4 - 28	2.50	.63	1.00	.255	3	H4
6140191	VTSFT-TC5047	-	-	1/4 - 28	2.50	.63	1.00	.255	3	H5
-	-	5887043	VTSFT-TC5047	1/4 - 28	2.49	.62	1.00	.255	3	H5
-	-	6140192	VTSFT-TC5048	1/4 - 28	2.50	.63	1.00	.255	3	H6
6140193	VTSFT-TC5049	6140195	VTSFT-TC5049	1/4 - 28	2.50	.63	1.00	.255	3	H7
5887045	VTSFT-TC5051	5887044	VTSFT-TC5051	5/16 - 18	2.72	.69	1.13	.318	3	H3
6140198	VTSFT-TC5052	5887046	VTSFT-TC5052	5/16 - 18	2.72	.69	1.13	.318	3	H5
6140200	VTSFT-TC5053	6140201	VTSFT-TC5053	5/16 - 18	2.72	.69	1.13	.318	3	H7
6140202	VTSFT-TC5054	6140203	VTSFT-TC5054	5/16 - 18	2.72	.69	1.13	.318	3	H11
5887048	VTSFT-TC5055	5887047	VTSFT-TC5055	5/16 - 24	2.71	.68	1.13	.318	3	H3
-	-	5887049	VTSFT-TC5057	5/16 - 24	2.71	.68	1.12	.318	3	H5
-	-	6140216	VTSFT-TC5058	5/16 - 24	2.72	.69	1.12	.318	3	H6
-	-	6140219	VTSFT-TC5059	5/16 - 24	2.72	.69	1.12	.318	3	H7
5887051	VTSFT-TC5061	5887050	VTSFT-TC5061	3/8 - 16	2.94	.75	1.27	.381	3	H3

VT-SFT TC • Form C Semi-Bottoming Chamfer • Machine Screw and Fractional • ANSI • Tension/Compression Holders

(continued)

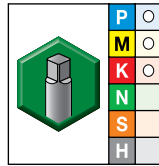
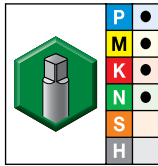
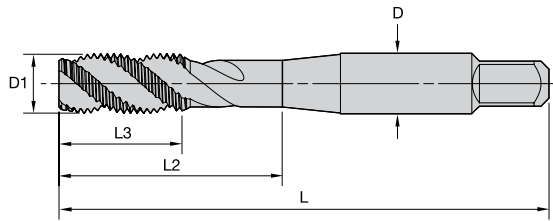

● first choice  
○ alternate choice

grade WP42EG TiN		grade WP49EG Oxide		D1 TPI	L	L3	L2	D	number of flutes	pitch diameter limit
6140222	VTSFT-TC5062	5887052	VTSFT-TC5062	3/8 - 16	2.94	.75	1.27	.381	3	H5
-	-	6140224	VTSFT-TC5063	3/8 - 16	2.94	.75	1.27	.381	3	H7
-	-	6140226	VTSFT-TC5064	3/8 - 16	2.93	.75	1.27	.381	3	H11
5887054	VTSFT-TC5065	5887053	VTSFT-TC5065	3/8 - 24	2.92	.74	1.25	.381	3	H3
6140227	VTSFT-TC5066	6140228	VTSFT-TC5066	3/8 - 24	2.94	.75	1.27	.381	3	H4
6140229	VTSFT-TC5067	-	-	3/8 - 24	2.94	.75	1.27	.381	3	H5
-	-	5887055	VTSFT-TC5067	3/8 - 24	2.92	.74	1.25	.381	3	H5
-	-	6140230	VTSFT-TC5068	3/8 - 24	2.94	.75	1.27	.381	3	H6
6140233	VTSFT-TC5070	-	-	3/8 - 24	2.94	.75	1.27	.381	3	H11
5887057	VTSFT-TC5071	5887056	VTSFT-TC5071	7/16 - 14	3.16	.88	1.49	.323	3	H3
6140235	VTSFT-TC5072	5887058	VTSFT-TC5072	7/16 - 14	3.16	.88	1.49	.323	3	H5
-	-	6140237	VTSFT-TC5073	7/16 - 14	3.16	.88	1.49	.323	3	H7
5887061	VTSFT-TC5075	5887059	VTSFT-TC5075	7/16 - 20	3.16	.88	1.49	.323	3	H3
6140240	VTSFT-TC5076	5887062	VTSFT-TC5076	7/16 - 20	3.16	.88	1.49	.323	3	H5
-	-	6140243	VTSFT-TC5078	7/16 - 20	3.16	.88	1.49	.323	3	H7
-	-	6140245	VTSFT-TC5079	7/16 - 20	3.16	.88	1.49	.323	3	H11
5887064	VTSFT-TC5080	5887063	VTSFT-TC5080	1/2 - 13	3.38	.94	1.74	.367	3	H3
6140422	VTSFT-TC5081	5887065	VTSFT-TC5081	1/2 - 13	3.38	.94	1.74	.367	3	H5
-	-	6140424	VTSFT-TC5082	1/2 - 13	3.38	.94	1.74	.367	3	H7
6140425	VTSFT-TC5083	6140426	VTSFT-TC5083	1/2 - 13	3.38	.94	1.74	.367	3	H11
5887068	VTSFT-TC5084	5887067	VTSFT-TC5084	1/2 - 20	3.38	.94	1.74	.367	3	H3
6140427	VTSFT-TC5085	5887069	VTSFT-TC5085	1/2 - 20	3.38	.94	1.74	.367	3	H5
-	-	6140430	VTSFT-TC5087	1/2 - 20	3.38	.94	1.74	.367	3	H7
-	-	6140432	VTSFT-TC5088	1/2 - 20	3.38	.94	1.74	.367	3	H11
6140434	VTSFT-TC5089	6140436	VTSFT-TC5089	9/16 - 12	3.59	1.00	1.74	.429	3	H3
6140440	VTSFT-TC5091	6140452	VTSFT-TC5091	9/16 - 18	3.59	1.00	1.74	.429	3	H3
-	-	6140454	VTSFT-TC5092	9/16 - 18	3.59	1.00	1.74	.429	3	H5
5887071	VTSFT-TC5093	5887070	VTSFT-TC5093	5/8 - 11	3.81	1.09	1.89	.480	3	H3
6140456	VTSFT-TC5094	5887072	VTSFT-TC5094	5/8 - 11	3.81	1.09	1.89	.480	3	H5
-	-	6140458	VTSFT-TC5095	5/8 - 11	3.81	1.09	1.89	.480	3	H7
5887074	VTSFT-TC5096	5887073	VTSFT-TC5096	5/8 - 18	3.81	1.09	1.89	.480	3	H3
-	-	5887075	VTSFT-TC5097	5/8 - 18	3.81	1.09	1.89	.480	3	H5
-	-	6140460	VTSFT-TC5098	5/8 - 18	3.81	1.09	1.89	.480	3	H6
5887077	VTSFT-TC5100	5887076	VTSFT-TC5100	3/4 - 10	4.25	1.22	2.08	.590	4	H3
6140465	VTSFT-TC5101	5887078	VTSFT-TC5101	3/4 - 10	4.25	1.22	2.08	.590	4	H5
5887080	VTSFT-TC5102	5887079	VTSFT-TC5102	3/4 - 16	4.25	1.22	2.08	.590	4	H3
6140467	VTSFT-TC5103	5887081	VTSFT-TC5103	3/4 - 16	4.25	1.22	2.08	.590	4	H5
-	-	6140469	VTSFT-TC5104	3/4 - 16	4.25	1.22	2.08	.590	4	H7
-	-	5887082	VTSFT-TC5105	7/8 - 9	4.69	1.34	2.30	.697	4	H4
6140471	VTSFT-TC5106	6140473	VTSFT-TC5106	7/8 - 9	4.69	1.34	2.30	.697	4	H5
6140475	VTSFT-TC5107	6140477	VTSFT-TC5107	7/8 - 14	4.69	1.34	2.30	.697	4	H4
-	-	5887083	VTSFT-TC5108	1 - 8	5.13	1.50	2.58	.800	4	H5
6140479	VTSFT-TC5109	6140481	VTSFT-TC5109	1 - 12	5.13	1.50	2.58	.800	4	H4
-	-	6140483	VTSFT-TC5110	1 1/8 - 7	5.44	1.71	2.56	.896	4	H6
-	-	6140484	VTSFT-TC5111	1 1/8 - 8	5.44	1.71	2.56	.896	4	H6
-	-	6140486	VTSFT-TC5112	1 1/8 - 12	5.44	1.71	2.56	.896	4	H5
-	-	6140488	VTSFT-TC5113	1 1/4 - 7	5.75	1.71	2.56	1.021	4	H6
-	-	6140490	VTSFT-TC5114	1 1/4 - 12	5.75	1.71	2.56	1.021	4	H5
-	-	6140492	VTSFT-TC5115	1 1/4 - 8	5.75	1.71	2.56	1.021	4	H6
-	-	6140494	VTSFT-TC5116	1 3/8 - 6	6.06	2.00	3.00	1.108	5	H6
-	-	6140496	VTSFT-TC5117	1 3/8 - 12	6.06	2.00	3.00	1.108	5	H5
-	-	6140498	VTSFT-TC5118	1 3/8 - 8	6.06	2.00	3.00	1.108	5	H6
-	-	6140500	VTSFT-TC5119	1 1/2 - 6	6.38	2.00	3.00	1.233	5	H6
-	-	6140502	VTSFT-TC5120	1 1/2 - 8	6.38	2.00	3.00	1.233	5	H6
-	-	6140504	VTSFT-TC5121	1 1/2 - 12	6.38	2.00	3.00	1.258	5	H5
-	-	6140506	VTSFT-TC5122	1 3/4 - 5	7.00	2.40	3.19	1.430	5	H7

INDEXABLE MILLING

SOLID END MILLING

HOLEMAKING

TAPPING

TURNING



VT-SFT TC • Form C Semi-Bottoming Chamfer • Metric • ANSI • Tension/Compression Holders

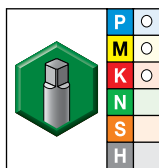
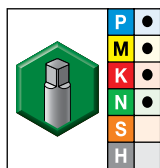
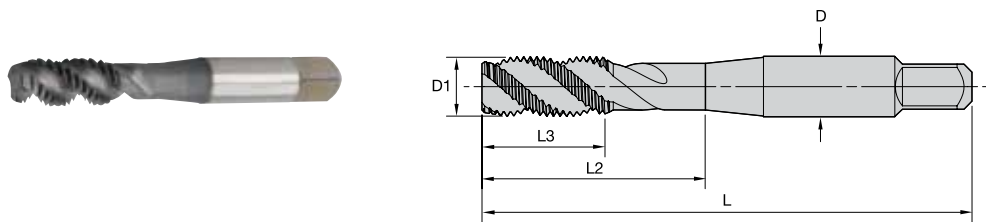

● first choice  
○ alternate choice

grade WP42EG TiCN		grade WP49EG Oxide		L		L3		L2		D		number of flutes	pitch diameter limit	
order #	catalog #	order #	catalog #	D1 TPI	mm	in	mm	in	mm	in	mm			in
5887085	VTSFT-TC5505	5887084	VTSFT-TC5505	M3 X 0,5	49,40	1.94	14,80	.58	19,30	.76	3,581	.141	3	D3
6141630	VTSFT-TC5507	6141781	VTSFT-TC5507	M3,5 X 0,6	50,50	1.99	9,70	.38	18,00	.71	3,582	.141	2	D4
5887087	VTSFT-TC5509	5887086	VTSFT-TC5509	M4 X 0,7	53,80	2.12	9,70	.38	19,40	.76	4,267	.168	3	D4
5887089	VTSFT-TC5511	5887088	VTSFT-TC5511	M5 X 0,8	60,30	2.37	12,70	.50	23,20	.91	4,928	.194	3	D4
5887091	VTSFT-TC5513	5887090	VTSFT-TC5513	M6 X 1	63,50	2.50	16,00	.63	25,50	1.01	6,477	.255	3	D5
-	-	6141790	VTSFT-TC5514	M6 X 1	63,50	2.50	16,00	.63	25,50	1.00	6,477	.255	3	D11
-	-	6141792	VTSFT-TC5515	M7 X 1	69,20	2.73	17,50	.69	29,30	1.15	8,077	.318	3	D5
6141796	VTSFT-TC5517	6141797	VTSFT-TC5517	M8 X 1	68,70	2.71	17,50	.69	28,50	1.12	8,077	.318	3	D5
-	-	6141799	VTSFT-TC5518	M8 X 1	68,70	2.71	17,50	.69	28,50	1.12	8,077	.318	3	D11
5887093	VTSFT-TC5519	5887092	VTSFT-TC5519	M8 X 1,25	68,70	2.71	17,50	.69	28,50	1.12	8,077	.318	3	D5
-	-	6141801	VTSFT-TC5520	M8 X 1,25	68,70	2.71	17,50	.69	28,50	1.12	8,077	.318	3	D11
-	-	6141803	VTSFT-TC5522	M10 X 1	73,90	2.91	18,70	.74	31,60	1.24	9,678	.381	3	D11
-	-	6141805	VTSFT-TC5523	M10 X 1,25	74,10	2.92	18,90	.74	31,80	1.25	9,678	.381	3	D5
6141808	VTSFT-TC5525	6141809	VTSFT-TC5525	M10 X 1,5	74,30	2.92	19,00	.75	31,90	1.26	9,678	.381	3	D6
-	-	6141811	VTSFT-TC5526	M10 X 1,5	74,20	2.92	19,00	.75	31,60	1.24	9,678	.381	3	D11
-	-	6140508	VTSFT-TC5527	M12 X 1,25	85,90	3.38	23,90	.94	44,20	1.74	9,322	.367	3	D5
-	-	6140512	VTSFT-TC5529	M12 X 1,5	85,90	3.38	23,90	.94	44,20	1.74	9,322	.367	3	D6
5887097	VTSFT-TC5531	5887096	VTSFT-TC5531	M12 X 1,75	85,90	3.38	23,90	.94	44,20	1.74	9,322	.367	3	D6
6140515	VTSFT-TC5532	6140516	VTSFT-TC5532	M12 X 1,75	85,90	3.38	23,90	.94	44,20	1.74	9,322	.367	3	D11
-	-	6140518	VTSFT-TC5533	M14 X 1,5	91,20	3.59	25,40	1.00	44,20	1.74	10,897	.429	3	D6
-	-	6140520	VTSFT-TC5535	M14 X 2	91,20	3.59	25,40	1.00	44,20	1.74	10,897	.429	3	D7
6140521	VTSFT-TC5536	6140522	VTSFT-TC5536	M16 X 1,5	96,80	3.81	27,70	1.09	48,00	1.89	12,192	.480	3	D6
5887099	VTSFT-TC5537	5887098	VTSFT-TC5537	M16 X 2	96,80	3.81	27,70	1.09	48,00	1.89	12,192	.480	3	D7
6140523	VTSFT-TC5538	6140524	VTSFT-TC5538	M18 X 1,5	102,40	4.03	27,70	1.09	48,00	1.89	13,767	.542	4	D6
6140525	VTSFT-TC5539	6140526	VTSFT-TC5539	M18 X 2,5	102,40	4.03	31,00	1.22	48,00	1.89	13,767	.542	4	D7
6140527	VTSFT-TC5540	6140528	VTSFT-TC5540	M20 X 1,5	113,50	4.47	31,00	1.22	52,80	2.08	16,561	.652	4	D6
6140529	VTSFT-TC5541	6140530	VTSFT-TC5541	M20 X 2,5	113,50	4.47	34,00	1.34	58,40	2.30	16,561	.652	4	D7
-	-	6140531	VTSFT-TC5542	M22 X 1,5	119,10	4.69	34,00	1.34	58,40	2.30	17,704	.697	4	D6
-	-	6140532	VTSFT-TC5543	M22 X 2,5	119,10	4.69	34,00	1.34	58,40	2.30	17,704	.697	4	D7
-	-	6140533	VTSFT-TC5544	M24 X 1,5	124,70	4.91	34,00	1.34	58,40	2.30	19,304	.760	4	D6
-	-	6140534	VTSFT-TC5545	M24 X 3	124,70	4.91	34,00	1.34	58,40	2.30	19,304	.760	4	D8
-	-	6140535	VTSFT-TC5546	M27 X 1,5	130,30	5.13	38,10	1.50	63,50	2.50	22,758	.896	4	D7
-	-	6140536	VTSFT-TC5547	M27 X 3	130,30	5.13	38,10	1.50	63,50	2.50	22,758	.896	4	D8
-	-	6140537	VTSFT-TC5548	M30 X 1,5	138,20	5.44	43,50	1.71	65,00	2.56	25,933	1.021	4	D6
-	-	6140538	VTSFT-TC5549	M30 X 3,5	138,20	5.44	43,50	1.71	65,00	2.56	25,933	1.021	4	D9



INDEXABLE MILLING

SOLID END MILLING

HOLEMAKING

TAPPING

TURNING

**VT-SFT TC • Form E Bottoming Chamfer • Machine Screw and Fractional • ANSI • Tension/Compression Holders**

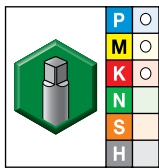
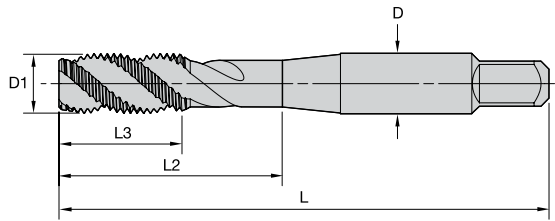

● first choice  
○ alternate choice

grade WP49EG Oxide							number of flutes	pitch diameter limit
order #	catalog #	D1 TPI	L	L3	L2	D		
6140539	VTSFT-TC5130	4 - 40	1.88	.51	.69	.141	2	H2
6140540	VTSFT-TC5131	4 - 40	1.88	.51	.69	.141	2	H3
6140541	VTSFT-TC5132	4 - 40	1.88	.51	.69	.141	2	H5
6140543	VTSFT-TC5134	6 - 32	1.99	.38	.71	.141	2	H2
6140544	VTSFT-TC5135	6 - 32	1.99	.38	.71	.141	2	H3
6140545	VTSFT-TC5136	6 - 32	1.99	.38	.71	.141	2	H5
6140546	VTSFT-TC5137	6 - 40	2.00	.38	.71	.141	2	H2
6140547	VTSFT-TC5138	6 - 40	2.00	.38	.71	.141	2	H3
6140548	VTSFT-TC5139	8 - 32	2.12	.38	.76	.168	3	H2
6140549	VTSFT-TC5140	8 - 32	2.12	.38	.76	.168	3	H3
6140550	VTSFT-TC5141	8 - 32	2.12	.38	.76	.168	3	H5
6140561	VTSFT-TC5142	10 - 24	2.37	.50	.91	.194	3	H3
6140562	VTSFT-TC5143	10 - 24	2.37	.50	.91	.194	3	H5
6140563	VTSFT-TC5144	10 - 32	2.38	.50	.91	.194	3	H3
6140564	VTSFT-TC5145	10 - 32	2.38	.50	.91	.194	3	H5
6140565	VTSFT-TC5146	1/4 - 20	2.50	.63	1.00	.255	3	H3
6140566	VTSFT-TC5147	1/4 - 20	2.50	.63	1.00	.255	3	H5
6140567	VTSFT-TC5148	1/4 - 28	2.50	.63	1.00	.255	3	H3
6140568	VTSFT-TC5149	1/4 - 28	2.50	.63	1.00	.255	3	H5
6140569	VTSFT-TC5150	5/16 - 18	2.72	.69	1.13	.318	3	H3
6140570	VTSFT-TC5151	5/16 - 18	2.72	.69	1.13	.318	3	H5
6140571	VTSFT-TC5152	5/16 - 24	2.72	.69	1.13	.318	3	H3
6140572	VTSFT-TC5153	5/16 - 24	2.72	.69	1.12	.318	3	H5
6140573	VTSFT-TC5154	3/8 - 16	2.94	.75	1.27	.381	3	H5
6140574	VTSFT-TC5155	3/8 - 16	2.94	.75	1.27	.381	3	H3
6140579	VTSFT-TC5156	3/8 - 24	2.94	.75	1.27	.381	3	H3
6140580	VTSFT-TC5157	3/8 - 24	2.94	.75	1.27	.381	3	H4
6140581	VTSFT-TC5158	3/8 - 24	2.94	.75	1.27	.381	3	H5
6140582	VTSFT-TC5159	7/16 - 14	3.16	.88	1.49	.323	3	H3
6140583	VTSFT-TC5160	7/16 - 14	3.16	.88	1.49	.323	3	H5
6140584	VTSFT-TC5161	7/16 - 20	3.16	.88	1.49	.323	3	H3
6140585	VTSFT-TC5162	7/16 - 20	3.16	.88	1.49	.323	3	H5
6140586	VTSFT-TC5163	1/2 - 13	3.38	.94	1.74	.367	3	H3
6140587	VTSFT-TC5164	1/2 - 13	3.38	.94	1.74	.367	3	H5
6140588	VTSFT-TC5165	1/2 - 20	3.38	.94	1.74	.367	3	H3
6140589	VTSFT-TC5166	9/16 - 12	3.59	1.00	1.74	.429	3	H3
6140590	VTSFT-TC5167	9/16 - 18	3.59	1.00	1.74	.429	3	H3
6140591	VTSFT-TC5168	5/8 - 11	3.81	1.09	1.89	.480	3	H3
6140592	VTSFT-TC5169	5/8 - 11	3.81	1.09	1.89	.480	3	H5
6140593	VTSFT-TC5170	5/8 - 18	3.81	1.09	1.89	.480	3	H3
6140595	VTSFT-TC5171	5/8 - 18	3.81	1.09	1.89	.480	3	H5
6140597	VTSFT-TC5172	3/4 - 10	4.25	1.22	2.08	.590	4	H3
6140599	VTSFT-TC5173	3/4 - 16	4.25	1.22	2.08	.590	4	H3

VT-SFT TC • Form E Bottoming Chamfer • Metric • ANSI • Tension/Compression Holders

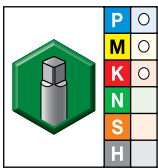
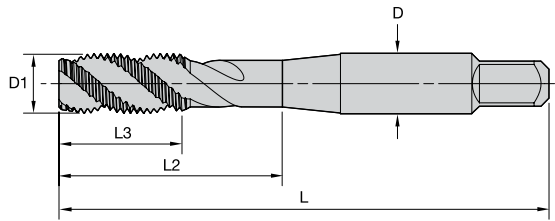

● first choice  
○ alternate choice

grade WP49EG Oxide		L		L3		L2		D		number of flutes	pitch diameter limit	
order #	catalog #	D1 TPI	mm	in	mm	in	mm	in	mm			in
6140343	VTSFT-TC5550	M3 X 0,5	49,30	1,94	14,80	—	19,10	.75	3,582	0,141	2	D3
6140344	VTSFT-TC5551	M3,5 X 0,6	50,80	2,00	9,70	.38	—	.71	3,582	0,141	2	D4
6140345	VTSFT-TC5552	M4 X 0,7	54,10	2,13	9,70	.38	19,40	.76	4,267	0,168	3	D4
6140346	VTSFT-TC5553	M5 X 0,8	60,50	2,38	12,70	.50	23,20	.91	4,928	0,194	3	D4
6140347	VTSFT-TC5554	M6 X 1	63,50	2,50	16,00	.63	25,50	1,00	6,477	0,255	3	D5
6140348	VTSFT-TC5555	M7 X 1	69,10	2,72	17,50	.69	—	1,15	8,077	0,318	3	D5
6140349	VTSFT-TC5556	M8 X 1,25	69,10	2,72	17,50	.69	28,50	1,12	8,077	0,318	3	D5
6140350	VTSFT-TC5557	M8 X 1	69,10	2,72	17,50	.69	28,50	1,12	8,077	0,318	3	D5
6140391	VTSFT-TC5558	M10 X 1,5	74,70	2,94	19,10	.75	31,90	1,26	9,678	0,381	3	D6
6140392	VTSFT-TC5559	M10 X 1,25	74,70	2,94	19,10	.75	31,90	1,26	9,677	0,381	3	D5
6140393	VTSFT-TC5560	M12 X 1,75	85,90	3,38	23,90	.94	—	1,74	9,322	0,367	3	D6
6140394	VTSFT-TC5561	M12 X 1,5	85,90	3,38	23,90	.94	44,20	1,74	9,322	0,367	3	D5
6140395	VTSFT-TC5562	M12 X 1,25	85,90	3,38	23,90	.94	44,20	1,74	9,322	0,367	3	D5
6140396	VTSFT-TC5563	M14 X 2	91,20	3,59	25,40	1,00	44,20	1,74	10,897	0,429	3	D7
6140397	VTSFT-TC5564	M14 X 1,5	91,20	3,59	25,40	1,00	44,20	1,74	10,897	0,429	3	D6
6140398	VTSFT-TC5565	M16 X 2	96,80	3,81	27,70	1,09	48,00	1,89	12,192	0,480	3	D7
6140399	VTSFT-TC5566	M16 X 1,5	96,80	3,81	27,70	1,09	48,00	1,89	12,192	0,480	3	D6

INDEXABLE MILLING

SOLID END MILLING

HOLEMAKING

TAPPING

TURNING

VT-SFT • Standard Chamfer • Pipe Taps

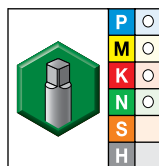
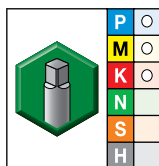
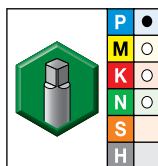
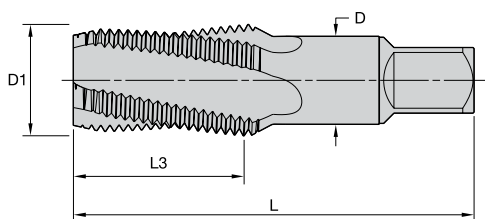

● first choice  
○ alternate choice

grade WU41EG TiN		grade WP49EG Oxide		grade WU40EG Bright		D1 TPI	L	L3	D	number of flutes	thread type
5629600	VTSFT8001	5629359	VTSFT8001	-	-	1/16 - 27	2.13	.69	.313	4	NPT
5629603	VTSFT8002	5629602	VTSFT8002	5629604	VTSFT8002	1/8 - 27	2.13	.75	.313	4	NPT
5629621	VTSFT8502	5629620	VTSFT8502	-	-	1/8 - 27	2.13	.75	.313	4	NPTF
5629606	VTSFT8003	5629605	VTSFT8003	-	-	1/8 - 27	2.13	.75	.438	4	NPT
5629624	VTSFT8503	5629623	VTSFT8503	-	-	1/8 - 27	2.13	.75	.438	4	NPTF
5629609	VTSFT8004	5629608	VTSFT8004	5629610	VTSFT8004	1/4 - 18	2.44	1.03	.563	4	NPT
5629627	VTSFT8504	5629626	VTSFT8504	5629628	VTSFT8504	1/4 - 18	2.44	1.03	.563	4	NPTF
5629612	VTSFT8005	5629611	VTSFT8005	-	-	3/8 - 18	2.56	1.03	.700	4	NPT
5629640	VTSFT8505	-	-	-	-	3/8 - 18	2.56	1.03	.700	4	NPTF
5629615	VTSFT8006	5629614	VTSFT8006	-	-	1/2 - 14	3.13	1.38	.688	4	NPT
5629643	VTSFT8506	5629642	VTSFT8506	-	-	1/2 - 14	3.13	1.38	.688	4	NPTF
5629836	VTSFT8007	5629835	VTSFT8007	-	-	3/4 - 14	3.25	1.38	.906	4	NPT
5629871	VTSFT8507	5629861	VTSFT8507	-	-	3/4 - 14	3.25	1.38	.906	4	NPTF
5629839	VTSFT8008	-	-	-	-	1 - 11 1/2	3.75	1.75	1.125	4	NPT
5629890	VTSFT8508	5629889	VTSFT8508	-	-	1 - 11 1/2	3.75	1.75	1.125	4	NPTF

VT-STR • NPT • Standard Chamfer • Pipe Taps

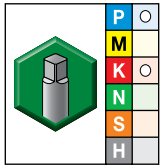
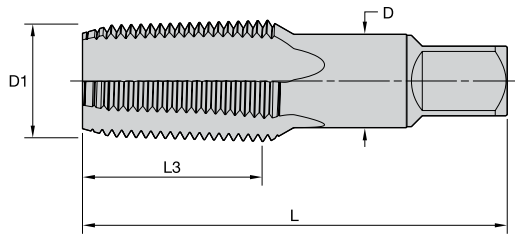

grade WU40EG  
Bright

● first choice  
○ alternate choice

order #	catalog #	D1 TPI	L	L3	D	number of flutes	thread type
5629646	VTSTR8001	1/8 - 27	2.13	.75	.313	4	NPT
5629647	VTSTR8002	1/4 - 18	2.44	1.03	.563	4	NPT
5629648	VTSTR8003	3/8 - 18	2.56	1.03	.700	4	NPT
5629649	VTSTR8004	1/2 - 14	3.13	1.38	.688	4	NPT
5629904	VTSTR8005	3/4 - 14	3.25	1.38	.906	5	NPT

INDEXABLE MILLING

SOLID END MILLING

HOLE/MAKING

TAPPING

TURNING

### Application Data • VariTap • HSS-E • Inch

Material Group		Through Holes					Blind Holes				
		Tap Style	Grade	Range – SFM			Tap Style	Grade	Range – SFM		
				min	Starting Value	max			min	Starting Value	max
P	1	VT-SPO	WP42EG, WU41EG	70	90	110	VT-SFT	WP42EG, WU41EG	40	60	90
		VT-SPO	WP49EG, WU40EG	30	45	60	VT-SFT	WP49EG, WU40EG	20	30	40
	2,3,4,5	VT-SPO	WP42EG, WU41EG	50	70	90	VT-SFT	WP42EG, WU41EG	40	50	70
		VT-SPO	WP49EG, WU40EG	30	35	40	VT-SFT	WP49EG, WU40EG	10	20	30
		VT-SPO	WP42EG, WU41EG	30	40	50	VT-SFT	WP42EG, WU41EG	20	30	40
		VT-SPO	WP49EG, WU40EG	20	20	30	VT-SFT	WP49EG, WU40EG	10	10	10
M	14.1, 14.3	VT-SPO	WP42EG, WU41EG	30	40	50	VT-SFT	WP42EG, WU41EG	20	30	40
		VT-SPO	WP49EG, WU40EG	20	20	30	VT-SFT	WP49EG, WU40EG	10	10	10
		VT-SFT NPT	WU41EG	20	20	30	VT-SFT NPT	WU41EG	20	20	30
	14.2	VT-SPO	WP42EG, WU41EG	10	10	10	VT-SFT NPT	WP49EG, WU40EG	10	10	10
		VT-SPO	WP42EG, WU41EG	20	30	40	VT-SFT	WP42EG, WU41EG	10	20	30
		VT-SPO	WP49EG, WU40EG	10	15	20	VT-SFT	WP49EG, WU40EG	7	10	10
K	15,16	VT-STR NPT	WU41EG	30	45	60	VT-STR NPT	WU41EG	30	45	60
		VT-STR NPT	WU40EG	20	25	30	VT-STR NPT	WU40EG	20	25	30
	17,18,19	VT-SPO	WP42EG, WU41EG	70	90	110	VT-SFT	WP42EG, WU41EG	40	60	90
VT-SPO		WP49EG, WU40EG	30	45	60	VT-SFT	WP49EG, WU40EG	20	30	40	
N	21,22	VT-SPO	WP42EG, WU41EG	110	150	190	VT-SFT	WP42EG, WU41EG	80	110	160
		VT-SPO	WU40EG	60	75	90	VT-SFT	WU40EG	40	50	72
	23,24	VT-SPO	WP42EG, WU41EG	100	130	160	VT-SFT	WP42EG, WU41EG	60	90	130
		VT-SPO	WU40EG	50	65	80	VT-SFT	WU40EG	40	50	70
26,27,28	VT-SPO	WP42EG, WU41EG	23	30	40	VT-SFT	WP42EG, WU41EG	10	20	30	
	VT-SPO	WU40EG	10	15	20	VT-SFT	WU40EG	10	10	10	

\* Grades: WP42EG = TiCN  
 WU41EG = TiN  
 WP49EG = oxide  
 WU40EG = bright

### Application Data • VariTap • HSS-E • Metric

Material Group		Through Holes					Blind Holes				
		Tap Style	Grade	Range – m/min			Tap Style	Grade	Range – m/min		
				min	Starting Value	max			min	Starting Value	max
P	P1	VT-SPO	WP42EG, WU41EG	21	27	34	VT-SFT	WP42EG, WU41EG	13	18	26
		VT-SPO	WP49EG	10	14	17	VT-SFT	WP49EG	6	9	13
	P2	VT-SPO	WP42EG, WU41EG	16	21	27	VT-SFT	WP42EG, WU41EG	11	15	22
		VT-SPO	WP49EG	8	11	13	VT-SFT	WP49EG	4	6	9
	P3	VT-SPO	WP42EG, WU41EG	9	12	15	VT-SFT	WP42EG, WU41EG	6	9	13
		VT-SPO	WP49EG	5	6	8	VT-SFT	WP49EG	2	3	4
M	M1	VT-STR NPT	WU41EG	5	6	8	VT-STR NPT	WU41EG	5	6	8
		VT-SPO	WP42EG, WU41EG	9	12	15	VT-SFT	WP42EG, WU41EG	6	9	13
		VT-SPO	WP49EG	5	6	8	VT-SFT	WP49EG	2	3	4
	M3	VT-SFT NPT	WU41EG	5	6	8	VT-SFT NPT	WU41EG	5	6	8
		VT-SFT NPT	WP49EG	2	3	4	VT-SFT NPT	WP49EG	2	3	4
		VT-SPO	WP42EG, WU41EG	7	9	11	VT-SFT	WP42EG, WU41EG	4	6	9
K	K1	VT-SPO	WP49EG	3	5	6	VT-SFT	WP49EG	2	3	4
		VT-STR NPT	WU41EG	10	14	17	VT-STR NPT	WU41EG	10	14	17
N	N1	VT-SPO	WP42EG, WU41EG	21	27	34	VT-SFT	WP42EG, WU41EG	13	18	26
		VT-SPO	WP49EG	10	14	17	VT-SFT	WP49EG	6	9	13
N2	N2	VT-SPO	WP42EG, WU41EG	34	46	57	VT-SFT	WP42EG, WU41EG	23	34	48
		VT-SPO	WP42EG, WU41EG	30	40	50	VT-SFT	WP42EG, WU41EG	19	27	39
N4	N4	VT-SPO	WP42EG, WU41EG	7	9	11	VT-SFT	WP42EG, WU41EG	4	6	9
		VT-SPO	WP42EG, WU41EG	7	9	11	VT-SFT	WP42EG, WU41EG	4	6	9

\* Grades: WP42EG = TiCN  
 WU41EG = TiN  
 WP49EG = oxide

**1872**

Wiley & Russell  
started to  
produce taps

**1912**

Greenfield Tap & Die  
(GTD) is formed

**1915**

GTD GUN™ tap patented

**1982**

Launched first PVD TiN  
coated taps (VTD)

**1991**

Greenfield acquires VTD  
and Lyndonville plant

**1993**

EM series tap launched

**2005**

Launched new  
generation HP carbide  
tap line (GX series)

**2009**

GTD brand becomes  
part of WIDIA™ Products  
Group

**2011**

WIDIA-GTD launches  
the new GT series of HP  
HSS-E-PM taps

**2013**

New VariTap™ series  
launched

**2015**

Launched new  
generation HPP HSS-E-  
PM taps for Ni, Ti, & Al  
(GT series)

**2016**

VariTap line expands  
(MTSFT-TC)



## PRIMED FOR PRODUCTIVITY

THE MOST POWERFUL TAPS IN THE BUSINESS PROUDLY BEAR OUR NAME.

WIDIA-GTD™ delivers a complete range of solid carbide, high performance, multipurpose, and general purpose tapping solutions for short-run to high-volume production needs. And with over 145 years of hands-on experience, consistent quality, and relentless innovation, you can count on WIDIA-GTD to deliver a fast, competitive tap solution for each customer, every time.

Speed, power, and precision: there's never been a better time to put WIDIA-GTD taps to the test.

**WIDIA™ GTD** 

# VT-AFT

## Aerospace Fastener Taps

The VT-AFT tap will face solution-treated high-temp alloys like A286, 300 series stainless steel, and titanium aerospace fastener applications.

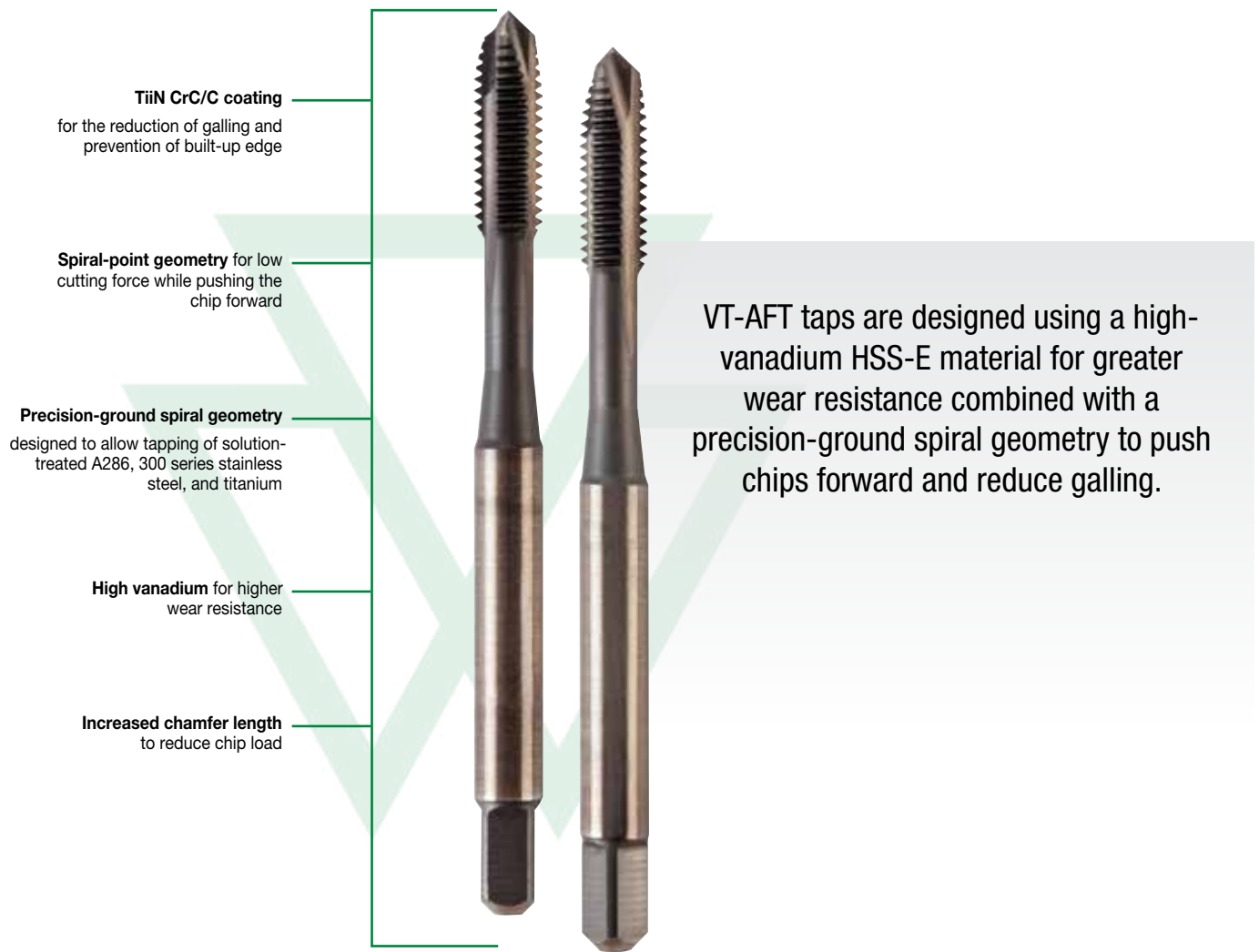

### GRADES

WN44EG TiN+CrC/C		
	P	○
	M	●
	K	
	N	
	S	●
	H	

# HIGH-PERFORMANCE TAPS FOR AEROSPACE FASTENERS

**WIDIA GTD** 

## PRODUCT

Form B

VTAFT

## INDUSTRY



## MATERIALS



## DIAMETER RANGE

Thread Size  
4-40 to 1/2-20

## APPLICATIONS



TAPPING:  
THROUGH  
HOLE

## TAP PITCH DIAMETER LIMIT

**H3  
-  
H9**

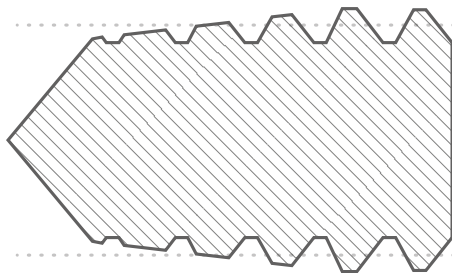

+0.0015	+0.0020	+0.0025	+0.0030	+0.0035	+0.0040	+0.0045
<b>H3</b>	<b>H4</b>	<b>H5</b>	<b>H6</b>	<b>H7</b>	<b>H8</b>	<b>H9</b>
+0.0015	+0.0020	+0.0025	+0.0030	+0.0035	+0.0040	+0.0045





## Grades and Grade Descriptions

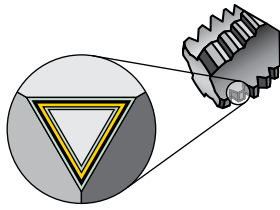

Coatings are designed for optimized tapping performance in specific materials.

<b>P</b>	Steel
<b>M</b>	Stainless Steel
<b>K</b>	Cast Iron
<b>N</b>	Non-Ferrous
<b>S</b>	High-Temp Alloys
<b>H</b>	Hardened Materials

Grade	Coating	Grade Description	wear resistance ← → toughness																			
			05	10	15	20	25	30	35	40	45											
WN44EG		High vanadium HSS-E substrate with a coating consists of low friction CrC/C over wear-resistant TiN base layer. Use for tapping stainless steel, high-temp alloys and steels.	<b>P</b>																			
			<b>M</b>																			
			<b>K</b>																			
			<b>N</b>																			
			<b>S</b>																			

VT-AFT • Inch

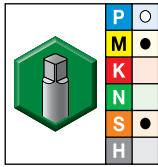
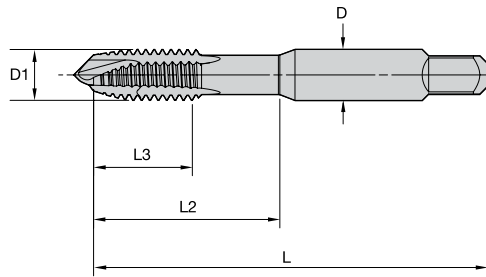

● first choice  
○ alternate choice

grade WN44EG TiN+CrC/C		D1 size	L	L3	L2	D	number of flutes	pitch diameter limit
6474960	VTAF5040	4 - 40	1.88	.51	.69	0.141	3	H3
6474971	VTAF5041	4 - 40	1.88	.51	.69	0.141	3	H4
6474972	VTAF5042	4 - 40	1.88	.51	.69	0.141	3	H5
6474973	VTAF5043	4 - 40	1.88	.51	.69	0.141	3	H6
6474974	VTAF5044	4 - 40	1.88	.51	.69	0.141	3	H7
6474975	VTAF5050	4 - 48	1.88	.51	.69	0.141	3	H3
6474976	VTAF5051	4 - 48	1.88	.51	.69	0.141	3	H4
6474977	VTAF5052	4 - 48	1.88	.51	.69	0.141	3	H5
6474978	VTAF5053	4 - 48	1.88	.51	.69	0.141	3	H6
6474979	VTAF5054	4 - 48	1.88	.51	.69	0.141	3	H7
6474986	VTAF5072	6 - 40	2.02	.38	.71	0.141	3	H5
6474987	VTAF5073	6 - 40	2.02	.38	.71	0.141	3	H6
6474988	VTAF5074	6 - 40	2.02	.38	.71	0.141	3	H7
6474983	VTAF5063	6 - 32	2.03	.38	.71	0.141	3	H6
6474984	VTAF5064	6 - 32	2.03	.38	.71	0.141	3	H7
6474985	VTAF5065	6 - 32	2.03	.38	.71	0.141	3	H8
6474980	VTAF5060	6 - 32	2.03	.38	.71	0.141	3	H3
6474981	VTAF5061	6 - 32	2.03	.38	.71	0.141	3	H4
6474982	VTAF5062	6 - 32	2.03	.38	.71	0.141	3	H5
6274214	VTAF5081	8 - 32	2.12	.38	.76	0.168	3	H4
6274215	VTAF5082	8 - 32	2.12	.38	.76	0.168	3	H5
6274216	VTAF5083	8 - 32	2.12	.38	.76	0.168	3	H6
6474989	VTAF5080	8 - 32	2.16	.38	.76	0.168	3	H3
6474990	VTAF5084	8 - 32	2.16	.38	.76	0.168	3	H7
6474991	VTAF5085	8 - 32	2.16	.38	.76	0.168	3	H8
6474992	VTAF5092	8 - 36	2.16	.38	.76	0.168	3	H5
6474993	VTAF5093	8 - 36	2.16	.38	.76	0.168	3	H6
6474994	VTAF5094	8 - 36	2.16	.38	.76	0.168	3	H7
6087704	VTAF5110	10 - 32	2.36	.50	.91	0.194	3	H4
6087705	VTAF5111	10 - 32	2.36	.50	.91	0.194	3	H5
6496038	VTAF5109	10 - 32	2.41	.50	.91	0.194	3	H3
6496039	VTAF5112	10 - 32	2.41	.50	.91	0.194	3	H6
6496040	VTAF5113	10 - 32	2.41	.50	.91	0.194	3	H7
6496081	VTAF5114	10 - 32	2.41	.50	.91	0.194	3	H8
6496033	VTAF5100	10 - 24	2.42	.50	.91	0.194	3	H3
6496034	VTAF5101	10 - 24	2.42	.50	.91	0.194	3	H4
6496036	VTAF5103	10 - 24	2.42	.50	.91	0.194	3	H6
6496037	VTAF5104	10 - 24	2.42	.50	.91	0.194	3	H7
6496035	VTAF5102	10 - 24	2.42	.50	.91	0.194	3	H5
6496089	VTAF5140	1/4 - 28	2.49	.62	1.00	0.255	3	H3
6496090	VTAF5141	1/4 - 28	2.49	.62	1.00	0.255	3	H4
6496091	VTAF5142	1/4 - 28	2.49	.62	1.00	0.255	3	H5
6496092	VTAF5143	1/4 - 28	2.49	.62	1.00	0.255	3	H6
6496093	VTAF5144	1/4 - 28	2.49	.62	1.00	0.255	3	H7
6496095	VTAF5145	1/4 - 28	2.49	.62	1.00	0.255	3	H8
6496096	VTAF5146	1/4 - 28	2.49	.62	1.00	0.255	3	H9
6496083	VTAF5131	1/4 - 20	2.50	.63	1.00	0.255	3	H4
6496084	VTAF5132	1/4 - 20	2.50	.63	1.00	0.255	3	H5

## VT-AFT • Inch

(continued)

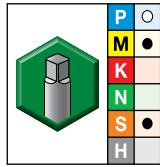
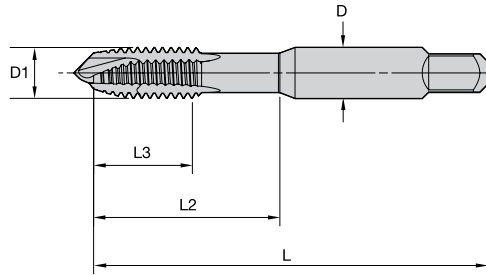

● first choice  
○ alternate choice

grade WN44EG TiN+CrC/C		D1 size	L	L3	L2	D	number of flutes	pitch diameter limit
6496086	VTAF5133	1/4 - 20	2.50	.63	1.00	0.255	3	H6
6496087	VTAF5134	1/4 - 20	2.50	.63	1.00	0.255	3	H7
6496088	VTAF5135	1/4 - 20	2.50	.63	1.00	0.255	3	H8
6496082	VTAF5130	1/4 - 20	2.50	.63	1.00	0.255	3	H3
6496097	VTAF5160	5/16 - 24	2.71	.69	1.12	0.318	3	H3
6496098	VTAF5161	5/16 - 24	2.71	.69	1.12	0.318	3	H4
6496099	VTAF5162	5/16 - 24	2.71	.69	1.12	0.318	3	H5
6496100	VTAF5163	5/16 - 24	2.71	.69	1.12	0.318	3	H6
6496111	VTAF5164	5/16 - 24	2.71	.69	1.12	0.318	3	H7
6496112	VTAF5165	5/16 - 24	2.71	.69	1.12	0.318	3	H8
6496113	VTAF5166	5/16 - 24	2.71	.69	1.12	0.318	3	H9
6496114	VTAF5180	3/8 - 24	2.92	.75	1.25	0.381	3	H3
6496115	VTAF5181	3/8 - 24	2.92	.75	1.25	0.381	3	H4
6496116	VTAF5183	3/8 - 24	2.92	.75	1.25	0.381	3	H6
6496117	VTAF5185	3/8 - 24	2.92	.75	1.25	0.381	3	H8
6496118	VTAF5186	3/8 - 24	2.92	.75	1.25	0.381	3	H9
6445486	VTAF5182	3/8 - 24	2.94	.75	1.27	0.381	3	H5
6445487	VTAF5184	3/8 - 24	2.94	.75	1.27	0.381	3	H7
6496119	VTAF5222	1/2 - 20	3.38	.94	1.74	0.367	3	H5
6496120	VTAF5223	1/2 - 20	3.38	.94	1.74	0.367	3	H6
6439284	VTAF5224	1/2 - 20	3.38	.94	1.74	0.367	3	H7
6439283	VTAF5225	1/2 - 20	3.38	.94	1.74	0.367	3	H8
6496121	VTAF5226	1/2 - 20	3.38	.94	1.74	0.367	3	H9

Application Data • VT-AFT • Inch



Aerospace Fastener Taps VT-AFT

Cutting Speed – Vc  
SFM

Range

Material Group		min	Starting Value	max
P	1	30	40	50
	2	25	30	40
	3	20	30	35
M	1	30	40	50
	2	13	16	23
S	1	20	26	40
	4	13	16	20

INDEXABLE MILLING

SOLID END MILLING

HOLEMAKING

TAPPING

TURNING

# Victory™ Tap

HSS-E-PM • VICTORY TAPS

Victory HSS-E-PM Taps feature material-specific geometries and grades capable of working in a wider application range than solid carbide taps.

**Optimized flute designs**  
Better chip evacuation

**Application-specific coatings**  
Extremely high wear resistance, longer tool life

**HSS-E-PM powder metallurgy substrate**  
Improved wear characteristics, longer tool life

Optimum choice for customers seeking consistency and optimal performance in a wide variety of applications and materials.

## GRADES

	WP31MG	WS32MG	WN35MG	WU32MG	WS34MG	WH36MG	WS39MG	WN48MG	WN44EG
 P	•			•		•			○
M				○	•				•
K				•					
N				•	○			•	•
S	○	•	•	•	•	○	•		
H		•							

# RELIABLE AND CONSISTENT

# WIDIA™ GTD

## PRODUCT

Victory™ HSS-E-PM Taps deliver reliability and consistent performance on a wide range of applications

## INDUSTRY



## MATERIALS



## APPLICATIONS



BLIND HOLE



THROUGH HOLE



HSS-E-PM



DIN 371



DIN 374



DIN 376



ANSI



FLOOD COOLANT: TAPPING



THROUGH COOLANT: RADIAL: TAPPING



THROUGH COOLANT: AXIAL: TAPPING

SERIES	SIZE RANGE	DIMENSIONS
GT00, GT14, GT16	M and MF: M3 to M12	DIN
GT02, GT04, GT10, GT12, GT80	M and MF: M3 to M20	DIN
GT06	M and MF: M6 to M16	DIN
	M and MF: M3 to M42	ANSI & DIN
GT2X	UNC and UNF: #2 to 3/4"	ANSI
	UNC and UNF: #6 to 1/2"	DIN/ANSI
	M and MF: M3 to M42	ANSI & DIN
GT3X	UNC and UNF: #2 to 1"	ANSI
	UNC and UNF: #6 to 1/2"	DIN/ANSI
	M and MF: M4 to M22	DIN
GT4X	UNC and UNF: #10 to 3/4"	ANSI
	UNC and UNF: #6 to 1/2"	DIN/ANSI
GT5X	M: M24 to M42	DIN
GT6X	M and MF: M2.5 to M12	ANSI
	UNC and UNF: #2 to 1"	ANSI
GT9X	M and MF: M2.5 to M12	ANSI
	UNC and UNF: #2 to 3/4"	ANSI
GT70	M and MF: M3 to M16	DIN/ANSI
GT7X & GT8X	M and MF: M3 to M12	DIN/ANSI
	UNC and UNF: #2 to 1/2"	DIN/ANSI



## Shank Style

ANSI, DIN, JIS & DIN/ANSI precision ground

## Grades and Grade Descriptions

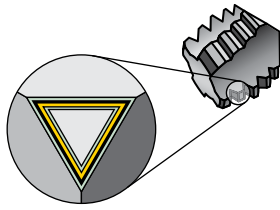

Coatings are designed for optimized tapping performance in specific materials.

P	Steel
M	Stainless Steel
K	Cast Iron
N	Non-Ferrous
S	High-Temp Alloys
H	Hardened Materials

wear resistance ← → toughness

Grade	Coating	Grade Description	Performance Matrix																					
			05	10	15	20	25	30	35	40	45													
WU32MG		Coated HSS-E-PM, PVD heat- and wear-resistant high-vanadium cobalt powder metal. HSS substrate coated with wear-resistant TiCN base layer. Use in steel, cast iron, cast aluminum with silicon and super alloys.	P																					
			M																					
			K																					
			S																					
WS34MG		Coated HSS-E-PM, PVD heat and wear-resistant high-vanadium, high-cobalt powder metal HSS-E-PM substrate. Coating consists of low-friction CrC/C over wear-resistant TiN base layer. Used for tapping titanium, titanium alloys, stainless steel, and non-ferrous materials.	M																					
			N																					
			S																					
			H																					
WS39MG		Surface-treated HSS-E-PM powder metal HSS-E substrate with oxide/nitride surface treatment that provides wear resistance in nickel alloys.	P																					
			M																					
			K																					
			S																					
WN44EG		High-vanadium HSS-E substrate with a coating consists of low-friction CrC/C over wear-resistant TiN base layer. Use for tapping stainless steel and non-ferrous materials.	P																					
			M																					
			K																					
			N																					

GT20 • Machine Screw and Fractional • Form B Plug Chamfer • Steel and Stainless Steel

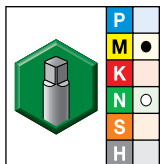
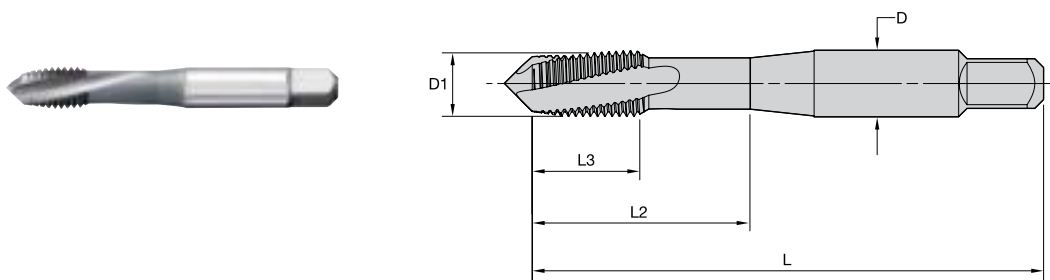

grade WS34MG  
TiN+CrC/C

- first choice
- alternate choice

order #	catalog #	D1 TPI	L	L3	L2	D	number of flutes
3955273	GT205001	2 - 56	1.75	.44	.49	.141	2
3955274	GT205002	2 - 56	1.75	.44	.49	.141	2
3955275	GT205003	4 - 40	1.88	.56	.68	.141	2
3955276	GT205004	4 - 40	1.88	.56	.68	.141	2
3955278	GT205006	6 - 32	2.00	.36	.71	.141	2
3955280	GT205008	8 - 32	2.13	.31	.76	.168	2
3955281	GT205009	8 - 32	2.13	.31	.76	.168	2
3955294	GT205022	8 - 36	2.13	.31	.76	.168	2
3955282	GT205010	10 - 24	2.38	.47	.91	.194	3
3955295	GT205023	10 - 32	2.38	.47	.91	.194	3
3955296	GT205024	10 - 32	2.38	.47	.91	.194	3
3955284	GT205012	1/4 - 20	2.50	.44	1.00	.255	3
3955285	GT205013	1/4 - 20	2.50	.44	1.00	.255	3
3955298	GT205026	1/4 - 28	2.50	.44	1.00	.255	3
3955287	GT205015	5/16 - 18	2.72	.49	1.13	.318	3
3955286	GT205014	5/16 - 18	2.72	.49	1.13	.318	3
3955299	GT205027	5/16 - 24	2.72	.49	1.13	.318	3
3955288	GT205016	3/8 - 16	2.94	.60	1.27	.381	3
3955289	GT205017	3/8 - 16	2.94	.60	1.27	.381	3
3955291	GT205019	1/2 - 13	3.38	.77	1.74	.367	3
3955292	GT205020	5/8 - 11	3.81	.91	1.89	.480	4
3955293	GT205021	3/4 - 10	4.25	1.00	2.08	.590	4



## GT20 • Metric ANSI • Form D Plug Chamfer • Steel and Stainless Steel

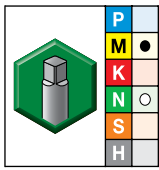
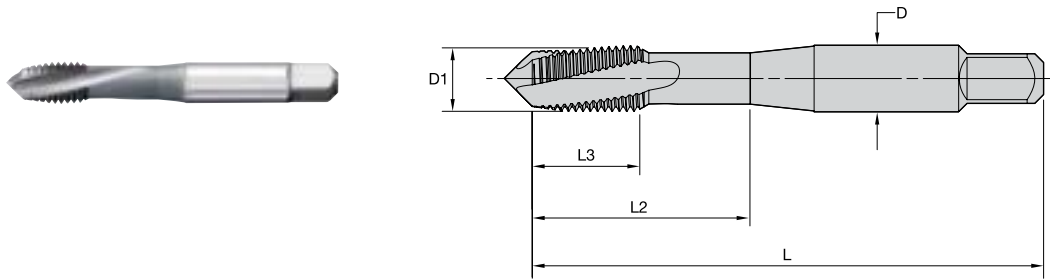

WS34MG

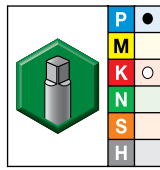

WU32MG

● first choice  
○ alternate choice

WS34MG		WU32MG		D1 TPI	L	L3	L2	D	number of flutes	class of fit
order #	catalog #	order #	catalog #							
3955010	GT205061	3955018	GT205069	M3 X 0,5	1.94	.63	.75	.141	2	6HX
3955011	GT205062	-	-	M4 X 0,7	2.13	.32	.76	.168	2	6HX
-	-	3955019	GT205070	M4 X 0,7	2.12	.32	.76	.168	2	6HX
3955012	GT205063	3955020	GT205071	M5 X 0,8	2.38	.47	.91	.194	2	6HX
3955013	GT205064	3955021	GT205072	M6 X 1	2.50	.46	1.01	.255	3	6HX
3955014	GT205065	-	-	M8 X 1	2.72	.48	1.12	.318	3	6HX
3955015	GT205066	-	-	M8 X 1,25	2.72	.48	1.12	.318	3	6HX
-	-	3955044	GT205074	M8 X 1,25	2.71	.48	1.13	.318	3	6HX
3955016	GT205067	-	-	M10 X 1,5	2.94	.53	1.26	.381	3	6HX
-	-	3955045	GT205075	M10 X 1,5	2.92	.53	1.26	.381	3	6HX
3955017	GT205068	-	-	M12 X 1,75	3.38	.77	1.74	.367	3	6HX

INDEXABLE MILLING

SOLID END MILLING

HOLEMAKING

TAPPING

TURNING

GT30 • Machine Screw and Fractional • Form C Semi-Bottoming Chamfer • Stainless Steel

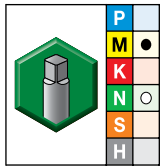
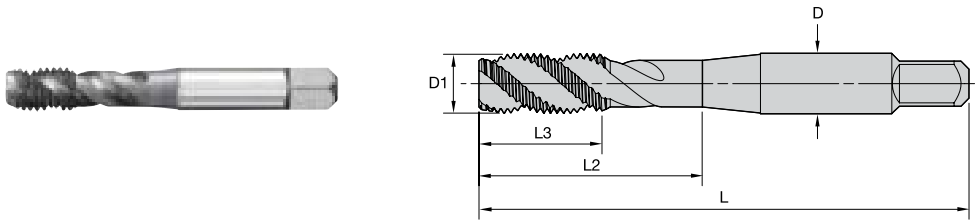

- first choice
- alternate choice

WS34MG

order #	catalog #	D1 size	L	L3	L2	D	number of flutes
3955131	GT305001	2 - 56	1.75	.44	.49	.141	2
3955132	GT305002	4 - 40	1.88	.56	.68	.141	2
3955133	GT305003	4 - 40	1.88	.56	.68	.141	2
3955134	GT305004	6 - 32	1.99	.36	.71	.141	3
3955135	GT305005	6 - 32	1.99	.36	.71	.141	3
3955136	GT305006	8 - 32	2.12	.31	.76	.168	3
3955137	GT305007	10 - 24	2.37	.47	.91	.194	3
3955152	GT305022	10 - 32	2.37	.47	.91	.194	3
3955153	GT305023	10 - 32	2.37	.47	.91	.194	3
3955138	GT305008	1/4 - 20	2.50	.44	1.01	.255	3
3955139	GT305009	1/4 - 20	2.50	.44	1.01	.255	3
3955154	GT305024	1/4 - 28	2.50	.44	1.00	.255	3
3955155	GT305025	1/4 - 28	2.50	.44	1.00	.255	3
3955140	GT305010	5/16 - 18	2.72	.49	1.13	.318	3
3955141	GT305011	5/16 - 18	2.72	.49	1.13	.318	3
3955156	GT305026	5/16 - 24	2.72	.49	1.13	.318	3
3955157	GT305027	5/16 - 24	2.72	.49	1.13	.318	3
3955142	GT305012	3/8 - 16	2.94	.60	1.27	.381	3
3955143	GT305013	3/8 - 16	2.94	.60	1.27	.381	3
3955158	GT305028	3/8 - 24	2.93	.59	1.26	.381	3
3955144	GT305014	7/16 - 14	3.16	.71	1.49	.323	5
3955159	GT305029	7/16 - 20	3.16	.71	1.49	.323	4
3955146	GT305016	1/2 - 13	3.38	.77	1.74	.367	4
3955145	GT305015	1/2 - 13	3.38	.77	1.74	.367	4
3955160	GT305030	1/2 - 20	3.38	.77	1.74	.367	4
3955147	GT305017	5/8 - 11	3.81	.91	1.89	.480	4
3955148	GT305018	5/8 - 11	3.81	.91	1.89	.480	4
3955149	GT305019	3/4 - 10	4.25	1.00	2.08	.590	4
3955150	GT305020	3/4 - 10	4.25	1.00	2.08	.590	4

INDEXABLE MILLING

SOLID END MILLING

HOLE/MAKING

TAPPING

TURNING

## GT30 • Metric ANSI • Form C Semi-Bottoming Chamfer • Steel and Stainless Steel

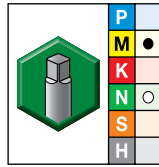
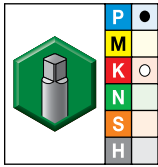
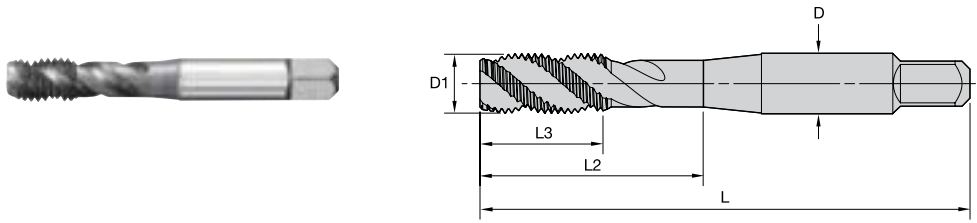

● first choice  
○ alternate choice

WS34MG		WU32MG		D1 size	L	L3	L2	D	number of flutes	class of fit
order #	catalog #	order #	catalog #							
3955060	GT305061	-	-	M3 X 0,5	1.94	.63	.75	.141	2	6HX
3955061	GT305062	-	-	M4 X 0,7	2.12	.32	.76	.168	3	6HX
3955062	GT305063	-	-	M5 X 0,8	2.37	.47	.91	.194	3	6HX
3955063	GT305064	3955072	GT305073	M6 X 1	2.50	.46	1.01	.255	3	6HX
3955064	GT305065	3955093	GT305074	M8 X 1,25	2.71	.48	1.12	.318	3	6HX
3955065	GT305066	-	-	M10 X 1,5	2.92	.53	1.26	.381	3	6HX
3955066	GT305067	-	-	M12 X 1,75	3.38	.77	1.74	.367	5	6HX
3955067	GT305068	-	-	M14 X 2	3.59	.83	1.74	.429	5	6HX
3955068	GT305069	-	-	M16 X 2	3.81	.91	1.89	.480	5	6HX

INDEXABLE MILLING

SOLID END MILLING

HOLEMAKING

TAPPING

TURNING

**GT40 • Machine Screw and Fractional • Form C Semi-Bottoming Chamfer • ANSI • Blind Hole Applications • Cast Iron and Cast Aluminum**

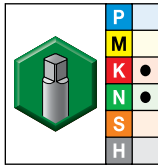
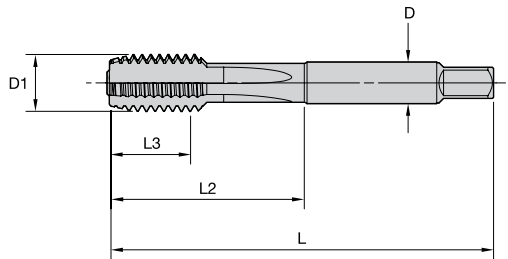

● first choice  
○ alternate choice

**WU32MG**

order #	catalog #	D1 size	L	L3	L2	D	number of flutes	class of fit
4035535	GT405012	10 - 24	2.37	.47	.91	.194	4	3BX
4035536	GT405013	10 - 32	2.36	.47	.91	.194	4	3BX
4035537	GT405014	1/4 - 20	2.50	.44	1.01	.255	4	2BX
4035541	GT405018	5/16 - 18	2.72	.49	1.13	.318	4	2BX
4035563	GT405020	5/16 - 24	2.71	.48	1.13	.318	4	3BX
4035564	GT405021	3/8 - 16	2.94	.60	1.27	.381	4	2BX
4035566	GT405023	3/8 - 24	2.92	.58	1.25	.381	4	3BX
4035567	GT405024	7/16 - 14	3.16	.71	1.49	.323	4	3BX
4035569	GT405026	1/2 - 13	3.38	.77	1.74	.367	4	3BX
4035571	GT405028	5/8 - 11	3.81	.91	1.89	.480	4	3BX
4035572	GT405029	3/4 - 10	4.25	1.00	2.08	.590	4	3BX

INDEXABLE MILLING

SOLID END MILLING

HOLE/MAKING

TAPPING

TURNING

INDEXABLE MILLING

SOLID END MILLING

HOLEMAKING

TAPPING

TURNING

**GT60 • Form B Plug Chamfer • Metric ANSI • Titanium and Titanium Alloys**

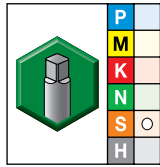
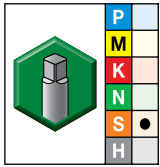
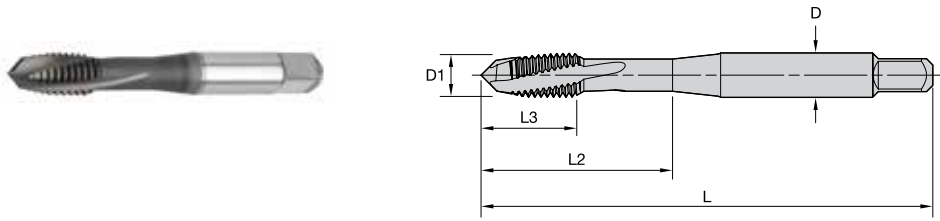

- first choice
- alternate choice

grade WS34MG TiN+CrC/C		grade WS30MG Nitride		D1 TPI	L	L3	L2	D	number of flutes	pitch diameter limit
order #	catalog #	order #	catalog #							
-	-	5563021	GT605503	M2,5 X 0,45	1.81	.49	.56	.141	3	D3
-	-	5563023	GT605505	M3 X 0,5	1.94	.63	.75	.141	3	D3
-	-	5563025	GT605507	M4 X 0,7	2.12	.32	.76	.168	3	D4
-	-	5563027	GT605509	M5 X 0,8	2.37	.47	.91	.194	3	D4
-	-	5563029	GT605511	M6 X 1	2.50	.16	1.00	.255	3	D5
5563042	GT605514	-	-	M7 X 1	2.73	.52	1.15	.318	3	D5
5563044	GT605516	-	-	M8 X 1,25	2.71	.48	1.12	.318	3	D5

**GT60 • Machine Screw and Fractional • Form B Plug Chamfer • Titanium and Titanium Alloys**

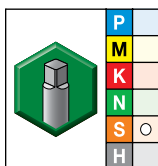
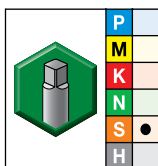
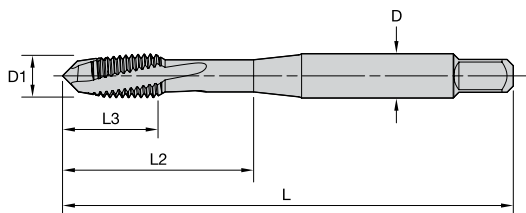

● first choice  
○ alternate choice

grade WS34MG TiN+CrC/C		grade WS30MG Nitride		D1 TPI	L	L3	L2	D	number of flutes	pitch diameter limit
order #	catalog #	order #	catalog #							
5562739	GT605006	-	-	2 - 56	1.75	.44	.50	.141	2	H2
5562941	GT605008	-	-	4 - 40	1.88	.56	.69	.141	3	H2
5562943	GT605010	-	-	6 - 32	1.99	.36	.71	.141	3	H2
5562945	GT605012	5562944	GT605011	6 - 32	1.99	.36	.71	.141	3	H3
5562947	GT605014	-	-	6 - 40	1.99	.36	.71	.141	3	H2
5562949	GT605016	-	-	8 - 32	2.12	.31	.76	.168	3	H2
5562951	GT605018	-	-	8 - 32	2.12	.31	.76	.168	3	H3
5562953	GT605020	-	-	8 - 36	2.12	.31	.76	.168	3	H2
5562955	GT605022	-	-	10 - 24	2.37	.47	.91	.194	3	H3
5562957	GT605024	-	-	10 - 32	2.37	.47	.91	.194	3	H2
5562959	GT605026	-	-	10 - 32	2.37	.47	.91	.194	3	H3
5562961	GT605028	-	-	1/4 - 20	2.50	.44	1.00	.255	3	H3
5562963	GT605030	-	-	1/4 - 20	2.50	.44	1.00	.255	3	H5
5562965	GT605032	-	-	1/4 - 28	2.50	.44	1.00	.255	3	H3
5562969	GT605036	-	-	5/16 - 18	2.72	.49	1.13	.318	3	H3
5562983	GT605040	-	-	5/16 - 24	2.72	.49	1.13	.318	3	H3
5562987	GT605044	-	-	3/8 - 16	2.93	.59	1.26	.381	3	H3
5562991	GT605048	-	-	3/8 - 24	2.93	.59	1.26	.381	3	H3
5562995	GT605052	-	-	7/16 - 14	3.16	.71	1.49	.323	3	H3
5562997	GT605054	-	-	7/16 - 20	3.16	.71	1.49	.323	3	H3
5562999	GT605056	-	-	1/2 - 13	3.38	.77	1.74	.367	3	H3
5563011	GT605058	-	-	1/2 - 20	3.38	.77	1.74	.367	3	H3
5563012	GT605059	-	-	9/16 - 18	3.59	.83	1.74	.429	4	H3
5563014	GT605061	-	-	5/8 - 11	3.81	.91	1.89	.480	4	H3
5563015	GT605062	-	-	5/8 - 18	3.81	.91	1.89	.480	4	H3
5563017	GT605064	-	-	3/4 - 10	4.25	1.00	2.08	.590	4	H5
5563018	GT605065	-	-	3/4 - 16	4.25	1.00	2.08	.590	4	H3
5563020	GT605067	-	-	1 - 8	5.13	1.25	2.58	.800	5	H5

GT62 • Form C Semi-Bottoming Chamfer • Metric ANSI • Titanium and Titanium Alloys

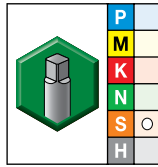
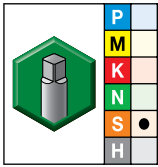
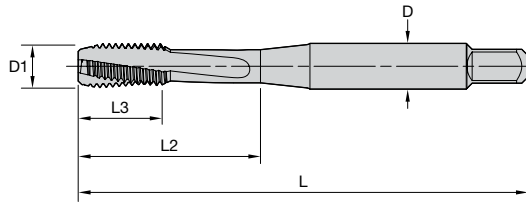

- first choice
- alternate choice

grade WS34MG TiN+CrC/C		grade WS30MG Nitride		D1 size	L	L3	L2	D	number of flutes	pitch diameter limit
order #	catalog #	order #	catalog #							
5565220	GT625504	-	-	M2,5 X 0,45	1.81	.50	.56	.141	3	D3
5565222	GT625506	-	-	M3 X 0,5	1.94	.63	.75	.141	3	D3
5565224	GT625508	-	-	M4 X 0,7	2.12	.32	.76	.168	3	D4
5565226	GT625510	-	-	M5 X 0,8	2.37	.46	.91	.194	3	D4
5565228	GT625512	5565227	GT625511	M6 X 1	2.50	.46	1.00	.255	3	D5
5565230	GT625514	-	-	M7 X 1	2.72	.52	1.15	.318	3	D5
5565232	GT625516	5565231	GT625515	M8 X 1,25	2.70	.48	1.12	.318	3	D5
5565234	GT625518	-	-	M10 X 1,25	2.93	.53	1.26	.381	3	D5
5565236	GT625520	-	-	M10 X 1,5	2.93	.53	1.26	.381	3	D6
5565238	GT625522	-	-	M12 X 1,75	3.38	.77	1.74	.367	3	D6

INDEXABLE MILLING

SOLID END MILLING

HOLEMAKING

TAPPING

TURNING

GT62 • Machine Screw and Fractional • Form C Semi-Bottoming Chamfer • Titanium and Titanium Alloys

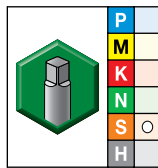
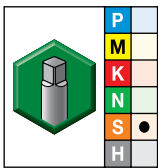
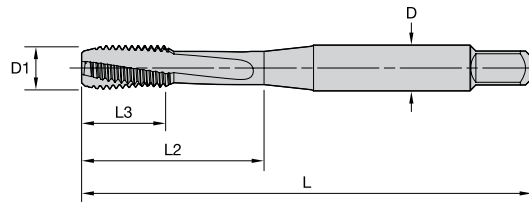

- first choice
- alternate choice

grade WS34MG TIN+CrC/C		grade WS30MG Nitride		D1 TPI	L	L3	L2	D	number of flutes	pitch diameter limit
order #	catalog #	order #	catalog #							
5565064	GT625006	-	-	2 - 56	1.75	.44	.50	.141	3	H2
5565067	GT625008	-	-	4 - 40	1.88	.56	.69	.142	3	H2
5565069	GT625010	-	-	6 - 32	1.99	.36	.71	.141	3	H2
5565133	GT625014	-	-	6 - 40	1.99	.36	.71	.141	3	H2
5565138	GT625018	-	-	8 - 32	2.12	.31	.77	.168	3	H3
5565140	GT625020	-	-	8 - 36	2.12	.31	.77	.168	3	H2
5565142	GT625022	-	-	10 - 24	2.37	.47	.92	.194	3	H3
5565146	GT625026	-	-	10 - 32	2.37	.47	.91	.194	3	H3
5565148	GT625028	5565147	GT625027	1/4 - 20	2.50	.44	1.01	.255	3	H3
5565152	GT625032	5565151	GT625031	1/4 - 28	2.50	.44	1.01	.255	3	H3
5565158	GT625038	-	-	5/16 - 18	2.72	.49	1.13	.318	3	H3
5565163	GT625042	-	-	5/16 - 24	2.72	.49	1.13	.318	3	H3
5565167	GT625046	-	-	3/8 - 16	2.93	.59	1.26	.381	3	H3
5565191	GT625050	-	-	3/8 - 24	2.93	.59	1.26	.381	3	H3
5565195	GT625054	-	-	7/16 - 14	3.16	.71	1.49	.323	3	H3
5565199	GT625058	-	-	7/16 - 20	3.16	.71	1.49	.323	3	H3
5565203	GT625062	-	-	1/2 - 13	3.38	.77	1.74	.367	3	H3
5565207	GT625066	-	-	1/2 - 20	3.38	.77	1.74	.367	3	H3
5565210	GT625069	-	-	9/16 - 18	3.59	.83	1.74	.429	4	H3
5565212	GT625071	-	-	5/8 - 11	3.81	.91	1.89	.480	4	H3
5565213	GT625072	-	-	5/8 - 18	3.81	.91	1.89	.480	4	H3
5565215	GT625074	-	-	3/4 - 10	4.25	1.00	2.08	.590	4	H5
5565216	GT625075	-	-	3/4 - 16	4.25	1.00	2.08	.590	4	H3
5565218	GT625077	-	-	1 - 8	5.12	1.25	2.58	.800	4	H5

INDEXABLE MILLING

SOLID END MILLING

HOLEMAKING

TAPPING

TURNING



## GT72 • Form B Plug Chamfer • Metric • DIN Length ANSI Shank • Wrought and Cast Aluminum

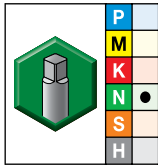
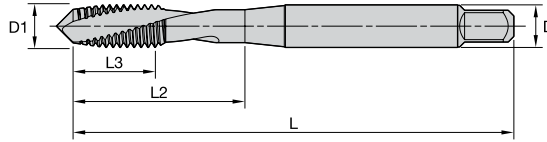

- first choice
- alternate choice

grade WN44EG  
TiN+CrC/C

order #	catalog #	D1 TPI	L	L3	L2	D	number of flutes	pitch diameter limit
5690933	GT725037	M3 X 0,5	2.20	.31	.71	.141	2	D3
5690934	GT725038	M3,5 X 0,6	2.20	.35	.79	.141	2	D4
5690935	GT725039	M4 X 0,7	2.48	.43	.83	.168	2	D4
5690936	GT725040	M5 X 0,8	2.76	.47	.98	.194	2	D4
5690937	GT725041	M6 X 1	3.15	.47	1.18	.255	2	D5
5690938	GT725042	M7 X 1	3.54	.59	1.38	.318	2	D5
5690940	GT725044	M8 X 1,25	3.54	.59	1.38	.318	2	D5
5690941	GT725045	M10 X 1,25	3.94	.71	1.54	.381	2	D5
5690942	GT725046	M10 X 1,5	3.94	.71	1.54	.381	2	D6
5690943	GT725047	M12 X 1,25	4.33	.83	1.73	.367	3	D6
5690944	GT725048	M12 X 1,5	4.33	.83	1.73	.367	3	D6
5690945	GT725049	M12 X 1,75	4.33	.83	1.73	.367	3	D6

INDEXABLE MILLING

SOLID END MILLING

HOLEMAKING

TAPPING

TURNING

**GT72 • Machine Screw and Fractional • Form B Plug Chamfer • DIN Length ANSI Shank • Wrought and Cast Aluminum**

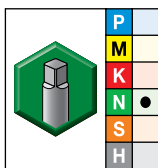
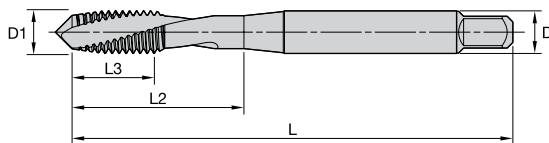

● first choice  
○ alternate choice

grade WN44EG TiN+CrC/C							number of flutes	pitch diameter limit
order #	catalog #	D1 TPI	L	L3	L2	D		
5690893	GT725010	2 - 56	1.77	.31	.71	.141	2	H2
5690894	GT725011	4 - 40	2.20	.31	.71	.141	2	H2
5690896	GT725012	5 - 40	2.20	.31	.71	.141	2	H2
5690897	GT725013	6 - 32	2.20	.35	.79	.141	2	H3
5690898	GT725014	8 - 32	2.48	.43	.83	.168	2	H3
5690899	GT725015	10 - 24	2.76	.47	.98	.194	2	H3
5690910	GT725016	10 - 32	2.76	.47	.98	.194	2	H3
5690911	GT725017	1/4 - 20	3.15	.59	1.18	.255	2	H3
5690913	GT725019	1/4 - 28	3.15	.59	1.18	.255	2	H3
5690915	GT725021	5/16 - 18	3.54	.59	1.38	.318	2	H3
5690918	GT725023	5/16 - 24	3.54	.59	1.38	.318	2	H3
5690920	GT725025	3/8 - 16	3.94	.75	1.54	.381	2	H3
5690924	GT725029	7/16 - 14	3.94	.71	1.61	.323	3	H3
5690926	GT725031	7/16 - 20	3.94	.71	1.61	.323	3	H3
5690928	GT725033	1/2 - 13	4.33	.91	1.85	.367	3	H4
5690930	GT725035	1/2 - 20	4.33	.91	1.85	.367	3	H3

INDEXABLE MILLING

## GT82 • Form C Semi-Bottom Chamfer • Metric • DIN Length ANSI Shank • Wrought and Cast Aluminum

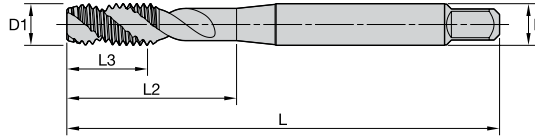

SOLID END MILLING

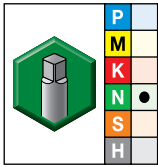

- first choice
- alternate choice

HOLEMAKING

grade WN44EG TiN+CrC/C								
order #	catalog #	D1 TPI	L	L3	L2	D	number of flutes	pitch diameter limit
5690801	GT825037	M3 X 0,5	2.20	.31	.71	.141	2	D3
5690803	GT825039	M4 X 0,7	2.48	.43	.83	.168	2	D4
5690804	GT825040	M5 X 0,8	2.76	.47	.98	.194	2	D4
5690805	GT825041	M6 X 1	3.15	.47	1.18	.255	2	D5
5690808	GT825044	M8 X 1,25	3.54	.59	1.38	.318	2	D5
5690810	GT825046	M10 X 1,5	3.94	.71	1.54	.381	2	D6
5690811	GT825047	M12 X 1,25	4.33	.83	1.73	.367	3	D6
5690813	GT825049	M12 X 1,75	4.33	.83	1.73	.367	3	D6

TAPPING

TURNING

**GT82 • Machine Screw and Fractional • Form C Semi-Bottom Chamfer •  
DIN Length ANSI Shank • Wrought and Cast Aluminum**

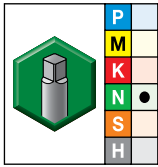
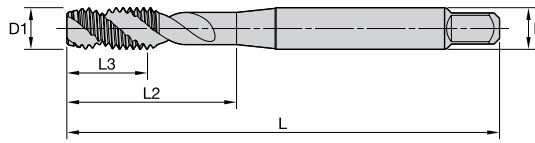

● first choice  
○ alternate choice

grade WN44EG TiN+CrC/C		D1	TPI	L	L3	L2	D	number of flutes	pitch diameter limit
5690761	GT825010	2 - 56		1.77	.31	.71	.141	2	H2
5690762	GT825011	4 - 40		2.20	.31	.71	.141	2	H2
5690765	GT825012	5 - 40		2.20	.31	.71	.141	2	H2
5690766	GT825013	6 - 32		2.20	.35	.79	.141	2	H3
5690767	GT825014	8 - 32		2.48	.43	.83	.168	2	H3
5690768	GT825015	10 - 24		2.76	.47	.98	.194	2	H3
5690769	GT825016	10 - 32		2.76	.47	.98	.194	2	H3
5690780	GT825017	1/4 - 20		3.15	.59	1.18	.255	2	H3
5690781	GT825018	1/4 - 20		3.15	.59	1.18	.255	2	H5
5690782	GT825019	1/4 - 28		3.15	.59	1.18	.255	2	H3
5690784	GT825021	5/16 - 18		3.54	.59	1.38	.318	2	H3
5690785	GT825022	5/16 - 18		3.54	.59	1.38	.318	2	H5
5690786	GT825023	5/16 - 24		3.54	.59	1.38	.318	2	H3
5690788	GT825025	3/8 - 16		3.94	.75	1.54	.381	2	H3
5690789	GT825026	3/8 - 16		3.94	.75	1.54	.381	2	H5
5690792	GT825029	7/16 - 14		3.94	.71	1.61	.323	3	H3
5690795	GT825031	7/16 - 20		3.94	.71	1.61	.323	3	H3
5690797	GT825033	1/2 - 13		4.33	.91	1.85	.367	3	H4
5690798	GT825034	1/2 - 13		4.33	.91	1.85	.367	3	H5
5690799	GT825035	1/2 - 20		4.33	.91	1.85	.367	3	H3

INDEXABLE MILLING

**GT86 • Form C Semi-Bottom Chamfer • Metric • DIN Length ANSI Shank • Wrought and Cast Aluminum**

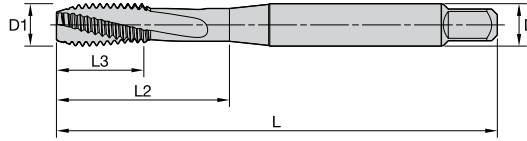

SOLID END MILLING

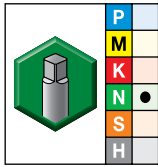

- first choice
- alternate choice

HOLEMAKING

grade WN44EG  
TiN+CrC/C

order #	catalog #	D1 TPI	L	L3	L2	D	number of flutes	pitch diameter limit
5690865	GT865037	M3 X 0,5	2.20	.31	.71	.141	3	D3
5690867	GT865039	M4 X 0,7	2.48	.43	.83	.168	3	D4
5690868	GT865040	M5 X 0,8	2.76	.47	.98	.194	3	D4
5690869	GT865041	M6 X 1	3.15	.47	1.18	.255	3	D5
5690882	GT865044	M8 X 1,25	3.54	.59	1.38	.318	3	D5
5690884	GT865046	M10 X 1,5	3.94	.71	1.54	.381	3	D6
5690886	GT865048	M12 X 1,5	4.33	.83	1.73	.367	3	D6
5690887	GT865049	M12 X 1,75	4.33	.83	1.73	.367	3	D6

TAPPING

TURNING

**GT86 • Machine Screw and Fractional • Form C Semi-Bottom Chamfer • DIN Length ANSI Shank • Wrought and Cast Aluminum**

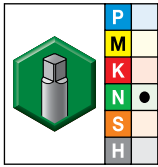
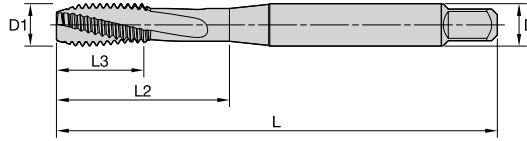

- first choice
- alternate choice

grade WN44EG  
TiN+CrC/C

order #	catalog #	D1 TPI	L	L3	L2	D	number of flutes	pitch diameter limit
5690817	GT865010	2 - 56	1.77	.31	.71	.141	3	H2
5690818	GT865011	4 - 40	2.20	.31	.71	.141	3	H2
5690819	GT865012	5 - 40	2.20	.31	.71	.141	3	H2
5690840	GT865013	6 - 32	2.20	.35	.79	.141	3	H3
5690841	GT865014	8 - 32	2.48	.43	.83	.168	3	H3
5690842	GT865015	10 - 24	2.76	.47	.98	.194	3	H3
5690843	GT865016	10 - 32	2.76	.47	.98	.194	3	H3
5690844	GT865017	1/4 - 20	3.15	.59	1.18	.255	3	H3
5690846	GT865019	1/4 - 28	3.15	.59	1.18	.255	3	H3
5690847	GT865020	1/4 - 28	3.15	.59	1.18	.255	3	H4
5690849	GT865021	5/16 - 18	3.54	.59	1.38	.318	3	H3
5690853	GT865025	3/8 - 16	3.94	.75	1.54	.381	3	H3
5690854	GT865026	3/8 - 16	3.94	.75	1.54	.381	3	H5
5690861	GT865033	1/2 - 13	4.33	.91	1.85	.367	3	H4

## GT90 • Form D Plug Chamfer • Metric ANSI • Nickel- and Cobalt-Based Alloys

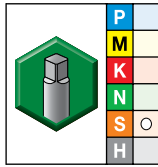
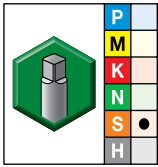
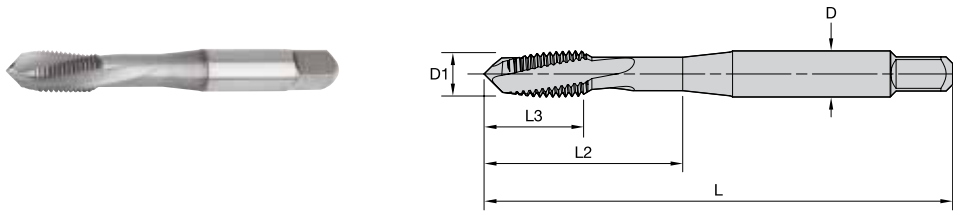

- first choice
- alternate choice

grade WU32MG TiCN		grade WS39MG Nitride/Oxide		D1 TPI	L	L3	L2	D	number of flutes	pitch diameter limit
order #	catalog #	order #	catalog #							
5705660	GT905146	5705073	GT905133	M2,5 X 0,45	1.81	.50	.56	.141	2	D3
5705071	GT905147	5705662	GT905134	M3 X 0,5	1.94	.63	.75	.141	3	D3
-	-	5705072	GT905135	M3,5 X 0,6	1.99	.36	.72	.141	3	D4
-	-	5705663	GT905136	M4 X 0,7	2.12	.32	.77	.168	3	D4
5705070	GT905149	-	-	M4 X 0,7	2.12	.36	.77	.168	3	D4
-	-	5705069	GT905137	M5 X 0,8	2.38	.47	.92	.194	3	D4
5705067	GT905151	5705664	GT905138	M6 X 1	2.51	.46	1.01	.255	3	D5
-	-	5705665	GT905139	M7 X 1	2.73	.52	1.16	.318	3	D5
-	-	5705666	GT905140	M8 X 1	2.72	.48	1.14	.318	3	D5
5705066	GT905154	5705668	GT905141	M8 X 1,25	2.72	.48	1.14	.318	3	D5
-	-	5705653	GT905142	M10 X 1,25	2.94	.53	1.27	.381	3	D5
-	-	5705656	GT905143	M10 X 1,5	2.94	.53	1.27	.381	3	D6
-	-	5705657	GT905144	M12 X 1,25	3.38	.77	1.74	.367	3	D5
-	-	5705659	GT905145	M12 X 1,75	3.38	.77	1.74	.367	3	D6

INDEXABLE MILLING

SOLID END MILLING

HOLEMAKING

TAPPING

TURNING

GT90 • Machine Screw and Fractional • Form D Plug Chamfer • Nickel- and Cobalt-Based Alloys

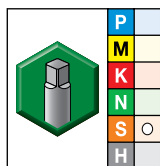
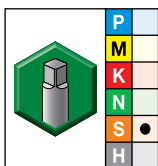
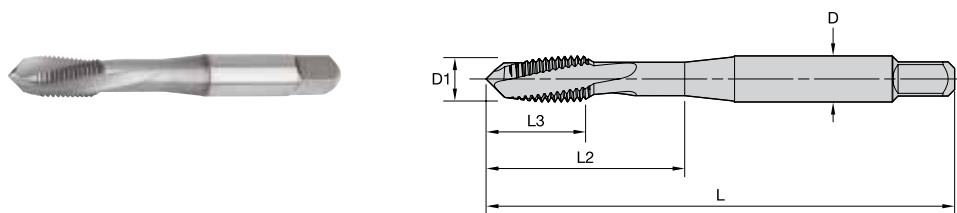

● first choice  
○ alternate choice

grade WU32MG TiCN		grade WS39MG Nitride/Oxide		D1 TPI	L	L3	L2	D	number of flutes	pitch diameter limit
order #	catalog #	order #	catalog #							
-	-	5705546	GT905001	2 - 56	1.75	.44	.50	.141	2	H2
-	-	5705549	GT905003	4 - 40	1.88	.56	.69	.141	2	H3
-	-	5705553	GT905005	4 - 48	1.88	.56	.69	.141	2	H2
-	-	5705555	GT905006	5 - 40	1.94	.63	.75	.141	3	H2
5705025	GT905074	5705559	GT905008	6 - 32	2.00	.36	.72	.141	3	H3
-	-	5705564	GT905012	6 - 40	2.00	.36	.72	.141	3	H2
5705024	GT905080	5705568	GT905014	8 - 32	2.13	.31	.77	.168	3	H3
5705572	GT905082	-	-	8 - 32	2.13	.31	.77	.168	3	H5
5705501	GT905085	5705059	GT905019	10 - 24	2.38	.47	.92	.194	3	H3
-	-	5705540	GT905025	10 - 32	2.38	.47	.92	.194	3	H5
-	-	5705542	GT905026	10 - 32	2.38	.47	.92	.194	3	H6
5705058	GT905089	5705507	GT905023	10 - 32	2.38	.47	.92	.194	3	H3
5705062	GT905094	5705584	GT905028	1/4 - 20	2.51	.44	1.02	.255	3	H3
-	-	5705060	GT905031	1/4 - 28	2.51	.44	1.02	.255	3	H3
-	-	5705629	GT905036	5/16 - 18	2.73	.49	1.15	.318	3	H3
-	-	5705634	GT905039	5/16 - 24	2.73	.49	1.15	.318	3	H3
5705615	GT905110	5705057	GT905044	3/8 - 16	2.95	.60	1.28	.381	3	H3
-	-	5705620	GT905047	3/8 - 24	2.95	.60	1.28	.381	3	H3
-	-	5705646	GT905052	7/16 - 14	3.16	.71	1.49	.323	3	H3
-	-	5705649	GT905054	7/16 - 20	3.16	.71	1.49	.323	3	H3
-	-	5705575	GT905056	1/2 - 13	3.38	.77	1.74	.367	3	H3
-	-	5705580	GT905059	1/2 - 20	3.38	.77	1.74	.367	3	H3
-	-	5705026	GT905062	5/8 - 11	3.81	.91	1.89	.480	3	H3
-	-	5705644	GT905063	5/8 - 18	3.81	.91	1.89	.480	3	H3
-	-	5705599	GT905064	3/4 - 10	4.25	1.00	2.08	.590	3	H3
-	-	5705613	GT905066	3/4 - 16	4.25	1.00	2.08	.590	3	H3



GT92 • 3-4 Pitches Chamfer • Metric ANSI • Nickel- and Cobalt-Based Alloys

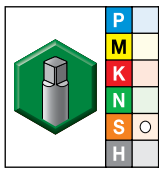
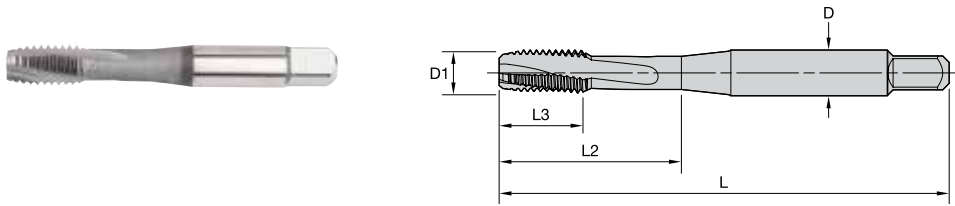

- first choice
- alternate choice

grade WS39MG Nitride/Oxide								
order #	catalog #	D1 TPI	L	L3	L2	D	number of flutes	pitch diameter limit
5708329	GT925137	M2,5 X 0,45	1.81	.50	.56	.141	3	D3
5708335	GT925138	M3 X 0,5	1.94	.63	.75	.141	3	D3
5708333	GT925139	M3,5 X 0,6	1.99	.36	.71	.141	3	D4
5708337	GT925140	M4 X 0,7	2.12	.32	.76	.168	3	D4
5708339	GT925141	M5 X 0,8	2.37	.47	.91	.194	3	D4
5708341	GT925142	M6 X 1	2.50	.46	1.00	.255	3	D5
5708343	GT925143	M7 X 1	2.72	.52	1.15	.318	3	D5
5708347	GT925144	M8 X 1	2.70	.48	1.12	.318	3	D5
5708349	GT925145	M8 X 1,25	2.70	.48	1.12	.318	3	D5
5708319	GT925146	M10 X 1,25	2.92	.53	1.26	.381	3	D5
5708323	GT925147	M10 X 1,5	2.92	.53	1.26	.381	3	D6
5708325	GT925148	M12 X 1,25	3.38	.77	1.74	.367	3	D5
5708327	GT925149	M12 X 1,75	3.38	.77	1.74	.367	3	D6

INDEXABLE MILLING

SOLID END MILLING

HOLEMAKING

TAPPING

TURNING

GT92 • Machine Screw and Fractional • 3-4 Pitches Chamfer • Nickel- and Cobalt-Based Alloys

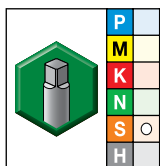
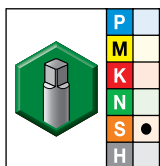
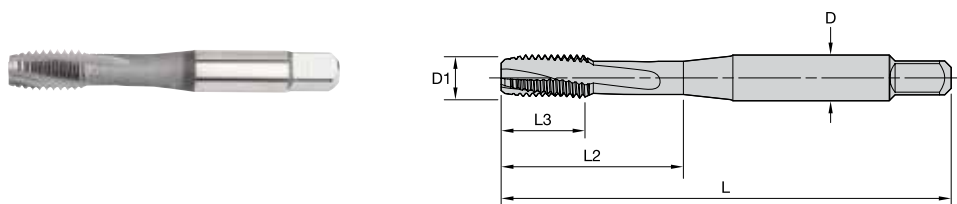

● first choice  
○ alternate choice

grade WU32MG TiCN		grade WS39MG Nitride/Oxide		D1 TPI	L	L3	L2	D	number of flutes	pitch diameter limit
order #	catalog #	order #	catalog #							
-	-	5708144	GT925001	2 - 56	1.75	.44	.50	.141	3	H2
-	-	5708148	GT925003	4 - 40	1.88	.56	.69	.141	3	H2
-	-	5705219	GT925004	4 - 40	1.88	.56	.69	.141	3	H3
-	-	5708161	GT925006	4 - 48	1.88	.56	.69	.141	3	H2
-	-	5708163	GT925007	5 - 40	1.95	.63	.76	.141	3	H2
-	-	5708166	GT925009	6 - 32	1.99	.36	.71	.141	3	H3
-	-	5708172	GT925013	6 - 40	2.03	.36	.71	.141	3	H2
-	-	5708175	GT925015	8 - 32	2.12	.31	.76	.168	3	H3
-	-	5708178	GT925018	8 - 32	2.16	.31	.76	.168	3	H6
5705277	GT925088	5708014	GT925020	10 - 24	2.37	.47	.91	.194	3	H3
5705276	GT925091	5708018	GT925023	10 - 32	2.37	.47	.91	.194	3	H3
5705275	GT925096	5708201	GT925028	1/4 - 20	2.50	.44	1.00	.255	3	H3
5705274	GT925099	5708209	GT925031	1/4 - 28	2.50	.44	1.00	.255	3	H3
5705273	GT925104	5708261	GT925036	5/16 - 18	2.72	.49	1.13	.318	3	H3
-	-	5708269	GT925039	5/16 - 24	2.72	.49	1.13	.318	3	H3
-	-	5708273	GT925040	5/16 - 24	2.72	.49	1.13	.318	3	H4
5705272	GT925112	5708227	GT925044	3/8 - 16	2.94	.60	1.27	.381	3	H3
-	-	5708229	GT925045	3/8 - 16	2.94	.60	1.27	.381	3	H5
5708253	GT925117	5705218	GT925047	3/8 - 24	2.40	.60	1.27	.381	3	H3
-	-	-	-	3/8 - 24	2.94	.60	1.27	.381	3	H5
-	-	5708305	GT925052	7/16 - 14	3.16	.71	1.49	.323	3	H3
-	-	5708315	GT925055	7/16 - 20	3.16	.71	1.49	.323	3	H5
-	-	5708311	GT925054	7/16 - 20	3.16	.71	1.49	.323	3	H3
5705282	GT925124	5708190	GT925056	1/2 - 13	3.38	.77	1.74	.367	3	H3
-	-	5708194	GT925059	1/2 - 20	3.38	.77	1.74	.367	3	H3
-	-	5708283	GT925062	5/8 - 11	3.81	.91	1.89	.480	3	H3
-	-	5708301	GT925064	5/8 - 18	3.81	1.31	1.89	.480	3	H3
-	-	5708217	GT925065	3/4 - 10	4.25	1.59	2.08	.590	3	H3
-	-	5708223	GT925067	3/4 - 16	4.25	1.00	2.08	.590	3	H3

## GT94 • Machine Screw and Fractional • Form E Bottoming Chamfer • Nickel- and Cobalt-Based Alloys

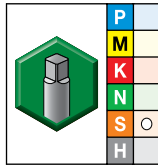
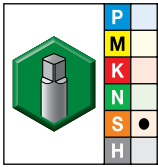
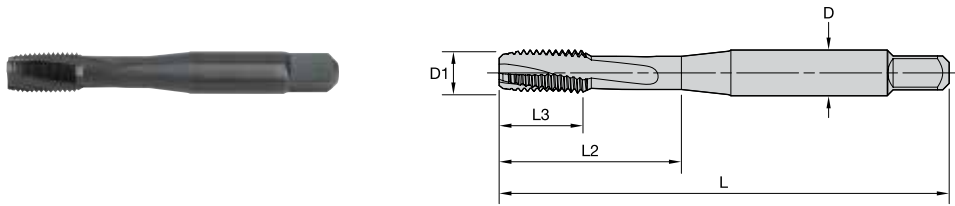

- first choice
- alternate choice

grade WU32MG TiCN		grade WS39MG Nitride/Oxide		D1 TPI	L	L3	L2	D	number of flutes	pitch diameter limit
order #	catalog #	order #	catalog #							
5705981	GT945038	-	-	4 - 40	1.88	.56	.69	.141	3	H3
-	-	5705982	GT945003	5 - 40	1.95	.63	.76	.141	3	H2
-	-	5705984	GT945005	6 - 32	1.99	.36	.71	.141	3	H3
5705989	GT945044	-	-	8 - 32	2.12	.31	.76	.168	3	H3
-	-	5705932	GT945010	10 - 24	2.42	.47	.91	.194	3	H3
-	-	5705935	GT945012	10 - 32	2.37	.47	.91	.194	3	H3
-	-	5705995	GT945014	1/4 - 20	2.50	.44	1.00	.255	3	H3
-	-	5703871	GT945016	1/4 - 28	2.50	.44	1.00	.255	3	H3
5706020	GT945055	-	-	5/16 - 18	2.72	.49	1.13	.318	3	H3
-	-	5706023	GT945021	5/16 - 24	2.72	.49	1.13	.318	3	H3
5706013	GT945060	5706012	GT945024	3/8 - 16	2.94	.60	1.27	.381	3	H3
-	-	5706014	GT945025	3/8 - 16	2.94	.60	1.27	.381	3	H5
-	-	5706016	GT945026	3/8 - 24	2.94	.60	1.27	.381	3	H3
-	-	5706034	GT945028	7/16 - 14	3.16	.71	1.49	.323	3	H3
-	-	5706036	GT945030	7/16 - 20	3.16	.71	1.49	.323	3	H3
-	-	5705993	GT945032	1/2 - 13	3.38	.77	1.74	.367	3	H5
-	-	5705994	GT945033	1/2 - 20	3.38	.77	1.74	.367	3	H3
-	-	5706032	GT945036	5/8 - 18	3.81	.91	1.89	.480	3	H3

INDEXABLE MILLING

SOLID END MILLING

HOLEMAKING

TAPPING

TURNING

**GT24 • DIN Length ANSI Shank • Form C Semi-Bottoming Entry Taper • Machine Screw and Fractional • Roll Form Taps • Steel and Stainless Steel**

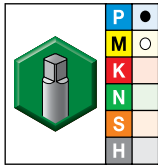
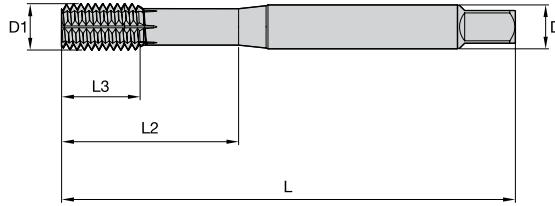

● first choice  
○ alternate choice

grade WU32MG TiCN							number of lube grooves	pitch diameter limit
order #	catalog #	D1 TPI	L	L3	L2	D		
5944876	GT245001	6 - 32	2.22	.41	.81	.141	2	H3
5944878	GT245003	8 - 32	2.48	.39	.83	.168	4	H3
5944880	GT245005	10 - 24	2.78	.39	1.01	.194	4	H4
5944972	GT245007	10 - 32	2.77	.39	1.00	.194	4	H4
5944974	GT245009	1/4 - 20	3.18	.51	1.22	.255	4	H4
5944975	GT245010	1/4 - 20	3.18	.51	1.21	.255	4	H6
5944976	GT245011	1/4 - 28	3.16	.51	1.20	.255	4	H4
5944978	GT245013	5/16 - 18	3.58	.55	1.42	.318	4	H5
5944980	GT245015	5/16 - 24	3.56	.55	1.40	.318	4	H5
5944982	GT245017	3/8 - 16	3.98	.63	1.54	.381	6	H5
5944984	GT245019	3/8 - 24	3.95	.63	1.54	.381	6	H5
5944990	GT245025	1/2 - 13	4.33	.79	1.85	.367	6	H5
5945002	GT245027	1/2 - 20	4.33	.79	1.85	.367	6	H5

## GT24 • Metric • DIN Length ANSI Shank • Form C Semi-Bottoming Entry Taper • Roll Form Taps • Steel and Stainless Steel

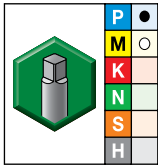
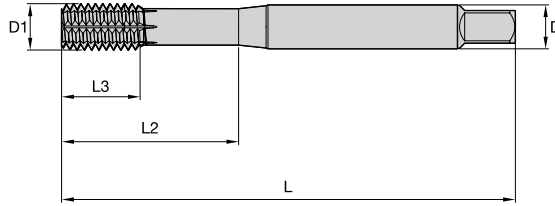

● first choice  
○ alternate choice

grade WU32MG  
TiCN

order #	catalog #	D1 TPI	L	L3	L2	D	number of lube grooves	pitch diameter limit
5945012	GT245037	M3 X 0,5	2.20	.39	.79	.141	2	D5
5945014	GT245039	M4 X 0,7	2.48	.39	.83	.168	4	D6
5945015	GT245040	M5 X 0,8	2.76	.39	.98	.194	4	D7
5945016	GT245041	M6 X 1	3.15	.51	1.18	.255	4	D8
5945019	GT245044	M8 X 1,25	3.54	.55	1.38	.318	6	D9
5945020	GT245045	M10 X 1,25	3.94	.63	1.53	.381	6	D9
5945021	GT245046	M10 X 1,5	3.94	.63	1.54	.381	6	D10
5945023	GT245048	M12 X 1,5	4.33	.71	1.73	.367	6	D9
5945024	GT245049	M12 X 1,75	4.33	.71	1.73	.367	6	D11

INDEXABLE MILLING

SOLID END MILLING

HOLEMAKING

TAPPING

TURNING

GT25 • DIN Length ANSI Shank • Form C Semi-Bottoming Entry Taper • Through Coolant • Fractional • Roll Form Taps • Steel and Stainless Steel

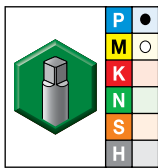
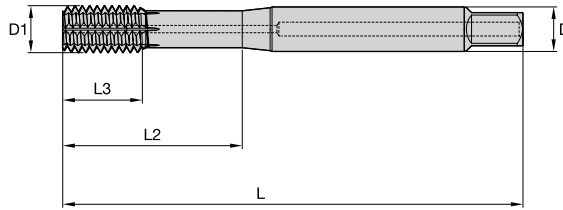

● first choice  
○ alternate choice

grade WU32MG  
TiCN

order #	catalog #	D1 TPI	L	L3	L2	D	number of lube grooves	pitch diameter limit
5945029	GT255001	1/4 - 20	3.15	.51	1.18	.255	4	H4
5945033	GT255005	5/16 - 18	3.54	.55	1.38	.318	6	H5
5945037	GT255009	3/8 - 16	3.94	.63	1.54	.381	6	H5
5945038	GT255010	3/8 - 16	3.94	.63	1.54	.381	6	H7
5945039	GT255011	3/8 - 24	3.94	.63	1.54	.381	6	H5
5945045	GT255017	1/2 - 13	4.33	.79	1.85	.367	6	H5
5945047	GT255019	1/2 - 20	4.33	.79	1.85	.367	6	H5
5945049	GT255021	5/8 - 11	4.33	.79	2.01	.480	6	H7

INDEXABLE MILLING

SOLID END MILLING

HOLE/MAKING

TAPPING

TURNING

INDEXABLE MILLING

SOLID END MILLING

HOLEMAKING

TAPPING

TURNING

**GT25 • Metric • DIN Length ANSI Shank • Form C Semi-Bottoming Entry Taper • Through Coolant  
• Roll Form Taps • Steel and Stainless Steel**

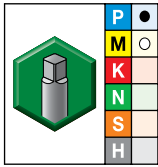
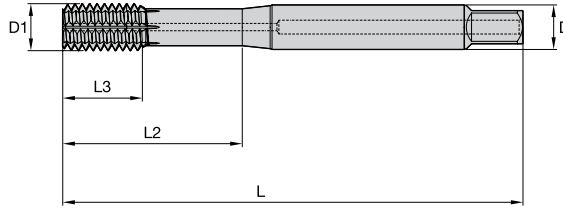

● first choice  
○ alternate choice

grade WU32MG TiCN							number of lube grooves	pitch diameter limit
order #	catalog #	D1 TPI	L	L3	L2	D		
5945057	GT255029	M6 X 1	3.15	.51	1.18	.255	4	D8
5945060	GT255032	M8 X 1,25	3.54	.55	1.38	.318	6	D9
5945072	GT255034	M10 X 1,5	3.94	.63	1.54	.381	6	D10
5945078	GT255040	M16 X 1,5	4.33	.79	2.01	.480	6	D11
5945079	GT255041	M16 X 2	4.33	.79	2.01	.480	6	D12

GT26 • DIN Length ANSI Shank • Form E Bottoming Entry Taper • Machine Screw and Fractional • Roll Form Taps • Steel and Stainless Steel

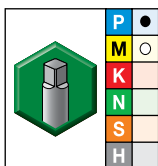
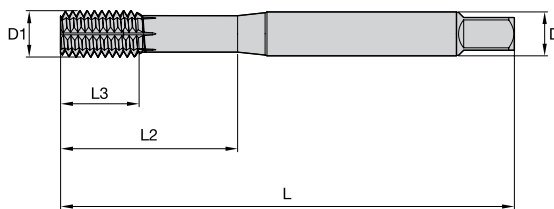

● first choice  
○ alternate choice

grade WU32MG TiCN							number of lube grooves	pitch diameter limit
order #	catalog #	D1 TPI	L	L3	L2	D		
5945091	GT265002	2 - 56	1.75	.44	.50	.141	0	H3
5945094	GT265005	4 - 40	2.20	.39	.71	.141	0	H3
5945095	GT265006	4 - 40	2.20	.39	.71	.141	0	H5
5945098	GT265009	5 - 40	2.20	.39	.79	.141	2	H5
5945099	GT265010	6 - 32	2.21	.39	.79	.141	2	H3
5945100	GT265011	6 - 32	2.21	.39	.79	.141	2	H5
5945101	GT265012	8 - 32	2.48	.39	.83	.168	4	H3
5945103	GT265014	10 - 24	2.76	.39	.98	.194	4	H4
5945105	GT265016	10 - 32	2.76	.39	.98	.194	4	H4
5945106	GT265017	10 - 32	2.76	.39	.98	.194	4	H6
5945107	GT265018	1/4 - 20	3.15	.51	1.18	.255	4	H4
5945108	GT265019	1/4 - 20	3.15	.51	1.18	.255	4	H6
5945109	GT265020	1/4 - 28	3.15	.51	1.18	.255	4	H4
5945111	GT265022	5/16 - 18	3.54	.55	1.38	.318	6	H5
5945113	GT265024	5/16 - 24	3.54	.55	1.38	.318	6	H5
5945114	GT265025	5/16 - 24	3.54	.55	1.38	.318	6	H7
5945115	GT265026	3/8 - 16	3.94	.63	1.54	.381	6	H5
5945117	GT265028	3/8 - 24	3.94	.63	1.54	.381	6	H5
5945123	GT265034	1/2 - 13	4.33	.79	1.85	.367	6	H5
5945129	GT265040	5/8 - 18	4.33	.79	2.01	.480	6	H7
5945133	GT265044	3/4 - 16	4.92	.98	2.52	.590	6	H7



INDEXABLE MILLING

SOLID END MILLING

HOLEMAKING

TAPPING

TURNING

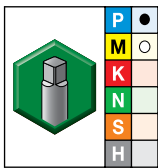
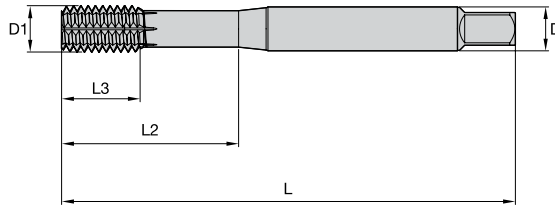

**GT26 • Metric • DIN Length ANSI Shank • Form E Bottoming Entry Taper • Roll Form Taps • Steel and Stainless Steel**





● first choice  
○ alternate choice

grade WU32MG TiCN							number of lube grooves	pitch diameter limit
order #	catalog #	D1 TPI	L	L3	L2	D		
5945135	GT265046	M3 X 0,5	2.20	.39	.79	.141	2	D5
5945137	GT265048	M4 X 0,7	2.48	.39	.83	.168	4	D6
5945138	GT265049	M5 X 0,8	2.76	.39	.98	.194	4	D7
5945139	GT265050	M6 X 1	3.15	.51	1.18	.255	4	D8
5945142	GT265053	M8 X 1,25	3.54	.55	1.38	.318	6	D9
5945143	GT265054	M10 X 1,25	3.94	.63	1.53	.381	6	D9
5945144	GT265055	M10 X 1,5	3.94	.63	1.54	.381	6	D10
5945145	GT265056	M12 X 1,25	4.33	.71	1.73	.367	6	D9



## Application Data • High-Performance Carbide Taps • Metric

Material Group	 Through Holes						 Blind Holes				
	Tap Style	Grade	Range – m/min			Tap Style	Grade	Range – m/min			
			min	Starting Value	max			min	Starting Value	max	
P	P0	GX32, GX38	WP35MG	60	100	130	GX33, GX39	WP35MG	50	70	90
	P1	GX32, GX38	WP35MG	60	90	120	GX33, GX39	WP35MG	40	60	80
	P2	GX32, GX38	WP35MG	50	85	110	GX33, GX39	WP35MG	40	60	80
	P3	GX32, GX38	WP35MG	50	80	100	GX33, GX39	WP35MG	40	60	80
K	K1	GX34, GX50	WK12PG	70	105	140	GX35, GX50	WK12PG	50	70	90
	K2	GX34, GX50	WK12PG	60	100	130	GX35, GX50	WK12PG	50	70	90
	K3	GX34, GX50	WK12PG	60	90	120	GX35, GX50	WK12PG	40	60	80
N	N2	GX46, GX48	WN14PG	80	120	160	GX47, GX49	WN14PG	60	80	100
	N3	GX46, GX48	WN14PG	60	100	130	GX47, GX49	WN14PG	50	70	90
	N4	GX46, GX48	WN14PG	60	90	120	GX47, GX49	WN14PG	40	60	80
	H3	GX10	WH16PG	1,2	1,5	2,0	GX10	WH16PG	0,8	1,1	1,4
H	H4	GX10	WH16PG	0,6	0,8	1,0	GX10	WH16PG	0,4	0,5	0,7

## Application Data • High-Performance Carbide Taps • Inch



Material Group	 Through Holes						 Blind Holes				
	Tap Style	Grade	Range – SFM			Tap Style	Grade	Range – SFM			
			min	Starting Value	max			min	Starting Value	max	
P	P0	GX32, GX38	WP35MG	200	330	430	GX33, GX39	WP35MG	160	230	300
	P1	GX32, GX38	WP35MG	200	300	390	GX33, GX39	WP35MG	130	200	260
	P2	GX32, GX38	WP35MG	160	280	360	GX33, GX39	WP35MG	130	200	260
	P3	GX32, GX38	WP35MG	160	260	330	GX33, GX39	WP35MG	130	200	260
K	K1	GX34, GX50	WK12PG	230	340	460	GX35, GX50	WK12PG	160	230	300
	K2	GX34, GX50	WK12PG	200	330	430	GX35, GX50	WK12PG	160	230	300
	K3	GX34, GX50	WK12PG	200	300	390	GX35, GX50	WK12PG	130	200	260
N	N2	GX46, GX48	WN14PG	260	390	520	GX47, GX49	WN14PG	200	260	330
	N3	GX46, GX48	WN14PG	200	330	430	GX47, GX49	WN14PG	160	230	300
	N4	GX46, GX48	WN14PG	200	300	390	GX47, GX49	WN14PG	130	200	260
	H3	GX10	WH16PG	3.8	4.9	6.4	GX10	WH16PG	2.6	3.4	4.5
H	H4	GX10	WH16PG	1.9	2.5	3.2	GX10	WH16PG	1.3	1.7	2.2

## Application Data • HSS-E-PM Taps • Metric

Material Group	 Through Holes					 Blind Holes					
	Tap Style	Grade	Range – m/min			Tap Style	Grade	Range – m/min			
			min	Starting Value	max			min	Starting Value	max	
P	P1	GT20	WU32MG	20	30	45	GT30, GT32, GT50	WU32MG	14	21	32
		GT24	WU32MG	20	30	45	GT24, GT26	WU32MG	14	21	32
	P2	GT20	WU32MG	17	25	38	GT30, GT32, GT50	WU32MG	12	18	26
		GT24	WU32MG	17	25	38	GT24, GT26	WU32MG	12	18	26
	P3	GT20	WU32MG	12	15	20	GT30, GT32, GT50	WU32MG	8	11	14
	P4	GT00	WP31MG	5	6	8	GT02, GT04	WP31MG	3	4	5
P5	GT20	WU32MG	12	15	20	GT30, GT32, GT50	WU32MG	8	11	14	
P6	GT00	WP31MG	6	8	10	GT02, GT04	WP31MG	4	6	7	
M	M1	GT20	WS34MG	12	15	20	GT30, GT32, GT50	WS34MG	8	11	14
		GT24	WU32MG	5	8	12	GT24, GT26	WU32MG	4	6	8
	M2	GT20	WS34MG	9	12	16	GT30, GT32, GT50	WS34MG	6	8	11
M3	GT00	WP31MG	4	5	7	GT02, GT04	WP31MG	3	4	5	
K	K1	GT40	WU32MG	27	35	46	GT40, GT42	WU32MG	19	25	32
	K2	GT40	WU32MG	23	30	39	GT40, GT42	WU32MG	16	21	27
N	N1	GT72	WN44EG	33	50	65	GT82, GT86	WN44EG	23	35	46
		GT22	WN48EG	37	55	72	GT22	WN48EG	26	39	50
	N2	GT40	WU32MG	30	45	59	GT40, GT42	WU32MG	21	32	41
		GT72	WN44EG	30	45	59	GT82, GT86	WN44EG	21	32	41
N4	GT40	WU32MG	7	10	15	GT40, GT42	WU32MG	5	7	11	
S	S1	GT20	WU32MG	8	12	18	GT30, GT32	WU32MG	6	8	13
	S2	GT90	WU32MG	3,3	5,0	7,5	GT92, GT94	WU32MG	2,3	3,5	5,3
	S3	GT90	WS39MG	1,7	2,5	3,8	GT92, GT94	WS39MG	1,2	1,8	2,6
	S4	GT60	WS34MG	2,7	4,0	6,0	GT62	WS34MG	1,9	2,8	4,2
H	H1	GT06	WN35MG	1,3	2,0	3,0	GT06	WN35MG	0,9	1,4	2,1
	H2	GT06	WN35MG	1,0	1,5	2,3	GT06	WN35MG	0,7	1,1	1,6

NOTE: Increase speed by up to 25% when using coolant taps (GT21, GT23, GT31, GT33, GT41, GT43, and GT51). Use grade GP6505™ in steels. Use 50% of the recommended speed listed for grade GP6520™.

## Application Data • HSS-E-PM Taps • Inch

Material Group	 Through Holes					 Blind Holes					
	Tap Style	Grade	Range – SFM			Tap Style	Grade	Range – SFM			
			min	Starting Value	max			min	Starting Value	max	
P	P1	GT20	WU32MG	70	100	150	GT30, GT32, GT50	WU32MG	50	70	100
		GT24	WU32MG	70	100	150	GT24, GT26	WU32MG	50	70	100
	P2	GT20	WU32MG	50	80	120	GT30, GT32, GT50	WU32MG	40	60	90
		GT24	WU32MG	50	80	120	GT24, GT26	WU32MG	40	60	90
	P3	GT20	WU32MG	40	50	60	GT30, GT32, GT50	WU32MG	30	30	40
	P4	GT00	WP31MG	15	20	26	GT02, GT04	WP31MG	11	14	18
P5	GT20	WU32MG	40	50	60	GT30, GT32, GT50	WU32MG	30	30	40	
P6	GT00	WP31MG	20	30	30	GT02, GT04	WP31MG	10	20	20	
M	M1	GT20	WS34MG	40	50	60	GT30, GT32, GT50	WS34MG	30	30	40
		GT24	WU32MG	20	30	40	GT24, GT26	WU32MG	10	20	30
	M2	GT20	WS34MG	30	40	50	GT30, GT32, GT50	WS34MG	20	30	40
M3	GT00	WP31MG	10	20	20	GT02, GT04	WP31MG	10	10	10	
K	K1	GT40	WU32MG	90	110	150	GT40, GT42	WU32MG	60	80	100
	K2	GT40	WU32MG	80	100	130	GT40, GT42	WU32MG	50	70	90
N	N1	GT72	WN44EG	110	160	210	GT82, GT86	WN44EG	80	110	150
		GT22	WN48EG	120	180	230	GT22	WN48EG	80	130	160
	N2	GT40	WU32MG	100	150	190	GT40, GT42	WU32MG	70	100	130
		GT72	WN44EG	100	150	190	GT82, GT86	WN44EG	70	100	130
N4	GT40	WU32MG	22	30	49	GT40, GT42	WU32MG	15	23	34	
S	S1	GT20	WU32MG	30	40	60	GT30, GT32	WU32MG	18	28	41
	S2	GT90	WU32MG	11	16	25	GT92, GT94	WU32MG	8	11	17
	S3	GT90	WS39MG	5	10	12	GT92, GT94	WS39MG	4	6	9
	S4	GT60	WS34MG	9	13	20	GT62	WS34MG	6	9	14
H	H1	GT06	WN35MG	4,4	6,6	9,8	GT06	WN35MG	3,1	4,6	6,9
	H2	GT06	WN35MG	3,3	4,9	7,4	GT06	WN35MG	2,3	3,4	5,2

NOTE: Increase speed by up to 25% when using coolant taps (GT21, GT23, GT31, GT33, GT41, GT43, and GT51). Use grade GP6505™ in steels. Use 50% of the recommended speed listed for grade GP6520™.

Tap Recommendations for Classes 2B and 3B

Unified Inch Screw Threads

thread size/pitch	recommended tap limits <sup>1</sup>		internal thread pitch diameter limits		
	class 2B	class 3B	min all classes (Basic)	max class 2B	max class 3B
0 - 80	H2	H2	0.0519	0.0542	0.0536
1 - 64	H2	H2	0.0629	0.0655	0.0648
1 - 72	H2	H2	0.0640	0.0665	0.0659
2 - 56	H2	H2	0.0744	0.0772	0.0765
2 - 64	H2	H2	0.0759	0.0786	0.0779
3 - 48	H3	H2	0.0855	0.0885	0.0877
3 - 56	H2	H2	0.0874	0.0902	0.0895
4 - 40	H3	H2	0.0958	0.0991	0.0982
4 - 48	H3	H2	0.0985	0.1016	0.1008
5 - 40	H3	H2	0.1088	0.1121	0.1113
5 - 44	H3	H2	0.1102	0.1134	0.1126
6 - 32	H3	H2	0.1177	0.1214	0.1204
6 - 40	H3	H2	0.1218	0.1252	0.1243
8 - 32	H3	H3	0.1437	0.1475	0.1465
8 - 36	H3	H3	0.1460	0.1496	0.1487
10 - 24	H3	H3	0.1629	0.1672	0.1661
10 - 32	H3	H3	0.1697	0.1736	0.1726
12 - 24	H3	H3	0.1889	0.1933	0.1922
12 - 28	H3	H3	0.1928	0.1970	0.1959
1/4 - 20	H5	H3	0.2175	0.2224	0.2211
1/4 - 28	H4	H3	0.2268	0.2311	0.2300
5/16 - 18	H5	H3	0.2764	0.2817	0.2803
5/16 - 24	H4	H3	0.2854	0.2902	0.2890
3/8 - 16	H5	H3	0.3344	0.3401	0.3387
3/8 - 24	H4	H3	0.3479	0.3528	0.3516
7/16 - 14	H5	H3	0.3911	0.3972	0.3957
7/16 - 20	H5	H3	0.4050	0.4104	0.4091
1/2 - 13	H5	H4	0.4500	0.4565	0.4548
1/2 - 20	H5	H3	0.4675	0.4731	0.4717
9/16 - 12	H5	H4	0.5084	0.5152	0.5135
9/16 - 18	H5	H3	0.5264	0.5323	0.5308
5/8 - 11	H5	H4	0.5660	0.5732	0.5714
5/8 - 18	H5	H3	0.5889	0.5949	0.5934
3/4 - 10	H5	H4	0.6850	0.6927	0.6907

<sup>1</sup>Tap H limit selected for 3B will also produce thread to 2B.

NOTE: The above recommended taps normally produce the class of thread indicated in average materials when used with reasonable care. However, if the specified tap does not provide a satisfactory gage fit, choose an alternate tap limit.

INDEXABLE MILLING

SOLID END MILLING

HOLE/MAKING

TAPPING

TURNING

## Tap Recommendations for Classes 2B and 3B

### Unified Inch Screw Threads

thread size/pitch	recommended tap limits		internal thread pitch diameter limits		
	class 2B	class 3B	min all classes (Basic)	max class 2B	max class 3B
3/4 - 16	H5	H4	0.7094	0.7159	0.7143
7/8 - 9	H6	H4	0.8028	0.8110	0.8089
7/8 - 14	H6	H4	0.8286	0.8356	0.8339
1" - 8	H6	H5	0.9188	0.9276	0.9254
1" - 12	H6	H4	0.9459	0.9535	0.9516
1-1/8 - 7	H8	H6	1.0322	1.0416	1.0393
1-1/8 - 8	H8	H6	1.0438	1.0528	1.0505
1-1/8 - 12	H6	H5	1.0709	1.0787	1.0768
1-1/4 - 7	H8	H6	1.1572	1.1668	1.1644
1-1/4 - 8	H8	H6	1.1688	1.1780	1.1757
1-1/4 - 12	H6	H5	1.1959	1.2039	1.2019
1-3/8 - 6	H8	H6	1.2667	1.2771	1.2745
1-3/8 - 8	H8	H6	1.2938	1.3031	1.3008
1-3/8 - 12	H6	H5	1.3209	1.3291	1.3270
1-1/2 - 6	H8	H6	1.3917	1.4022	1.3996
1-1/2 - 8	H8	H6	1.4188	1.4283	1.4259
1-1/2 - 12	H6	H5	1.4459	1.4542	1.4522
1-3/4 - 5	H8	H7	1.6201	1.6317	1.6288
2 - 4 1/2	H8	H7	1.8557	1.8681	1.8650

\*Tap H limit selected for 3B will also produce thread to 2B.

### Tap Recommendations for Class 6H Metric Screw Threads

thread size		recommended tap limit number	internal thread product limits — class 6H			
nominal diameter (mm)	pitch (mm)		pitch diameter (mm)		pitch diameter (in)	
			min	max	min	max
1,6	0,35	D3	1,373	1,458	.05406	.05740
2	0,4	D3	1,740	1,830	.06850	.07205
2,5	0,45	D3	2,208	2,303	.08693	.09067
3	0,5	D3	2,675	2,775	.10531	.10925
3,5	0,6	D4	3,110	3,222	.12244	.12685
4	0,7	D4	3,545	3,663	.13957	.14421
4,5	0,75	D4	4,013	4,131	.15789	.16264
5	0,8	D4	4,480	4,605	.17638	.18130
6	1	D5	5,350	5,500	.21063	.21654
7	1	D5	6,350	6,500	.25000	.25591
8	1,25	D5	7,188	7,348	.28299	.28929
10	1,5	D6	9,026	9,206	.35535	.36244
12	1,75	D6	10,863	11,063	.42768	.43555
14	2	D7	12,701	12,913	.50004	.50839
16	2	D7	14,701	14,913	.57878	.58713
20	2,5	D7	18,376	18,600	.72346	.73228
24	3	D8	22,051	22,316	.86815	.87858
30	3,5	D9	27,727	28,007	1.09161	1.10264
36	4	D9	33,402	33,702	1.31504	1.32685

Decimal Equivalents

drill size	decimal (in)	drill size	decimal (in)	drill size	decimal (in)	drill size	decimal (in)	drill size	decimal (in)	drill size	decimal (in)
0,30mm	.0118	54	.0550	3,10mm	.1220	5,50mm	.2165	8,50mm	.3346	9/16	.5625
0,32mm	.0126	1,40mm	.0551	1/18	.1250	7/32	.2188	8,60mm	.3386	14,50mm	.5709
80	.0135	1,45mm	.0571	3,20mm	.1260	5,60mm	.2205	R	.3390	37/64	.5781
0,35mm	.0138	1,50mm	.0591	30	.1285	2	.2210	8,70mm	.3425	14,75mm	.5807
79	.0145	53	.0595	3,30mm	.1299	5,70mm	.2244	11/32	.3438	15,00mm	.5906
0,38mm	.0150	1,55mm	.0610	3,40mm	.1339	1	.2280	8,80mm	.3465	19/32	.5938
1/64	.0156	1/16	.0625	29	.1360	5,80mm	.2283	S	.3480	15,25mm	.6004
0,40mm	.0157	1,60mm	.0630	3,50mm	.1378	5,90mm	.2323	8,90mm	.3504	39/64	.6094
78	.0160	52	.0635	28	.1405	A	.2340	9,00mm	.3543	15,50mm	.6102
0,42mm	.0165	1,65mm	.0650	9/64	.1406	15/64	.2344	T	.3580	15,75mm	.6201
0,45mm	.0177	1,70mm	.0669	3,60mm	.1417	6,00mm	.2362	9,10mm	.3583	5/8	.6250
77	.0180	51	.0670	27	.1440	B	.2380	23/64	.3594	16,00mm	.6299
0,48mm	.0189	1,75mm	.0689	3,70mm	.1457	6,10mm	.2402	9,20mm	.3622	16,25mm	.6398
0,50mm	.0197	50	.0700	26	.1470	C	.2420	9,30mm	.3661	41/64	.6406
76	.0200	1,80mm	.0709	25	.1495	6,20mm	.2441	U	.3680	16,50mm	.6496
75	.0210	1,85mm	.0728	3,80mm	.1496	D	.2460	9,40mm	.3701	21/32	.6562
0,55mm	.0217	49	.0730	24	.1520	6,30mm	.2480	9,50mm	.3740	16,75mm	.6594
74	.0225	1,90mm	.0748	3,90mm	.1535	1/4, E	.2500	3/8	.3750	17,00mm	.6693
0,60mm	.0236	48	.0760	23	.1540	6,40mm	.2520	V	.3770	43/64	.6719
73	.0240	1,95mm	.0768	5/32	.1562	6,50mm	.2559	9,60mm	.3780	17,25mm	.6791
0,62mm	.0244	5/64	.0781	22	.1570	F	.2570	9,70mm	.3819	11/16	.6875
72	.0250	47	.0785	4,00mm	.1575	6,60mm	.2598	9,80mm	.3858	17,50mm	.6890
0,65mm	.0256	2,00mm	.0787	21	.1590	G	.2610	W	.3860	45/64	.7031
71	.0260	2,05mm	.0807	20	.1610	6,70mm	.2638	9,90mm	.3898	18,00mm	.7087
0,70mm	.0276	46	.0810	4,10mm	.1614	17/64	.2656	25/64	.3906	23/32	.7188
70	.0280	45	.0820	4,20mm	.1654	H	.2660	10,00mm	.3937	18,50mm	.7283
69	.0292	2,10mm	.0827	19	.1660	6,80mm	.2677	X	.3970	47/64	.7344
0,75mm	.0295	2,15mm	.0846	4,30mm	.1693	6,90mm	.2717	10,20mm	.4016	19,00mm	.7480
68	.0310	44	.0860	18	.1695	I	.2720	Y	.4040	3/4	.7500
1/32	.0312	2,20mm	.0866	11/64	.1719	7,00mm	.2756	13/32	.4062	49/64	.7656
0,80mm	.0315	2,25mm	.0886	17	.1730	J	.2770	Z	.4130	19,50mm	.7677
67	.0320	43	.0890	4,40mm	.1732	7,10mm	.2795	10,50mm	.4134	25/32	.7812
66	.0330	2,30mm	.0906	16	.1770	K	.2810	27/64	.4219	20,00mm	.7874
0,85mm	.0335	2,35mm	.0925	4,50mm	.1772	9/32	.2812	10,80mm	.4252	51/64	.7969
65	.0350	42	.0935	15	.1800	7,20mm	.2835	11,00mm	.4331	20,50mm	.8071
0,90mm	.0354	3/32	.0938	4,60mm	.1811	7,30mm	.2874	7/16	.4375	13/16	.8125
64	.0360	2,40mm	.0945	14	.1820	L	.2900	11,20mm	.4409	21,00mm	.8268
63	.0370	41	.0960	4,70mm, 13	.1850	7,40mm	.2913	11,50mm	.4528	53/64	.8281
0,95mm	.0374	2,45mm	.0965	3/16	.1875	M	.2950	29/64	.4531	27/32	.8438
62	.0380	40	.0980	4,80mm, 12	.1890	7,50mm	.2953	11,80mm	.4646	21,50mm	.8465
61	.0390	2,50mm	.0984	11	.1910	19/64	.2969	15/32	.4688	55/64	.8594
1,00mm	.0394	39	.0995	4,90mm	.1929	7,60mm	.2992	12,00mm	.4724	22,00mm	.8661
60	.0400	38	.1015	10	.1935	N	.3020	12,20mm	.4803	7/8	.8750
59	.0410	2,60mm	.1024	9	.1960	7,70mm	.3031	31/64	.4844	22,50mm	.8858
1,05mm	.0413	37	.1040	5,00mm	.1969	7,80mm	.3071	12,50mm	.4921	57/64	.8906
58	.0420	2,70mm	.1063	8	.1990	7,90mm	.3110	1/2	.5000	23,00mm	.9055
57	.0430	36	.1065	5,10mm	.2008	5/16	.3125	12,80mm	.5039	29/32	.9062
1,10mm	.0433	7/64	.1094	7	.2010	8,00mm	.3150	13,00mm	.5118	59/64	.9219
1,15mm	.0453	35	.1100	13/64	.2031	O	.3160	33/64	.5156	23,50mm	.9252
56	.0465	2,80mm	.1102	6	.2040	8,10mm	.3189	13,20mm	.5197	15/16	.9375
3/64	.0469	34	.1110	5,20mm	.2047	8,20mm	.3228	17/32	.5312	24,00mm	.9449
1,20mm	.0472	33	.1130	5	.2055	P	.3230	13,50mm	.5315	61/64	.9531
1,25mm	.0492	2,90mm	.1142	5,30mm	.2087	8,30mm	.3268	13,80mm	.5433	24,50mm	.9646
1,30mm	.0512	32	.1160	4	.2090	21/64	.3281	35/64	.5469	31/32	.9688
55	.0520	3,00mm	.1181	5,40mm	.2126	8,40mm	.3307	14,00mm	.5512	25,00mm	.9843
1,35mm	.0531	31	.1200	3	.2130	Q	.3320	14,25mm	.5610	63/64	.9844
-	-	-	-	-	-	-	-	-	-	1"	1.0000

■ Metric     
 ■ Fractional     
 ■ Wire gage     
 ■ Letter size

INDEXABLE MILLING  
 SOLID END MILLING  
 HOLEMAKING  
 TAPPING  
 TURNING

## Standard Tap Dimensions • Ground Thread • Reference USCTI Table 302

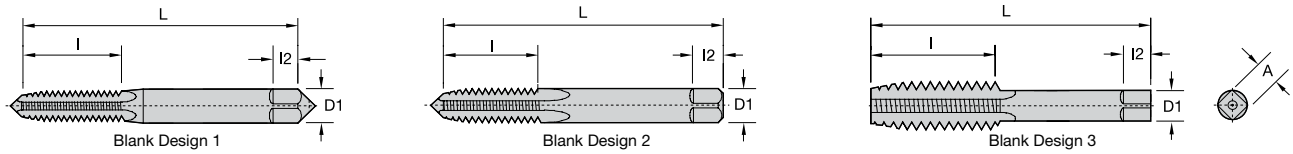

nominal diameter range (in)	machine screw size number (in)	nominal fractional diameter (in)	nominal metric diameter mm (in)	blank design number	overall length L	thread length l	square length l2	shank diameter D1	square size A
.052-.065	0 (.0600)	—	M1.6 (.0630)	1	1.63	.31	.19	.1410	.110
.065-.078	1 (.0730)	—	M1.8 (.0709)	1	1.69	.38	.19	.1410	.110
.078-.091	2 (.0860)	—	M2 (0.787), M2.2 (.0866)	1	1.75	.44	.19	.1410	.110
.091-.104	3 (.0990)	—	M2.5 (.0984)	1	1.81	.50	.19	.1410	.110
.104-.117	4 (.1120)	—	—	1	1.88	.56	.19	.1410	.110
.117-.130	5 (.1250)	—	M3 (.1181)	1	1.94	.63	.19	.1410	.110
.130-.145	6 (.1380)	—	M3.5 (.1378)	1	2.00	.69	.19	.1410	.110
.145-.171	8 (.1640)	—	M4 (.1575)	1	2.13	.75	.25	.1680	.131
.171-.197	10 (.1900)	—	M4.5 (.1772), M5 (.1969)	1	2.38	.88	.25	.1940	.152
.197-.223	12 (.2160)	—	—	1	2.38	.94	.28	.2200	.165
.223-.260	—	1/4 (.2500)	M6 (.2362)	2	2.50	1.00	.31	.2550	.191
.260-.323	—	5/16 (.3125)	M7 (.2756), M8 (.3150)	2	2.72	1.13	.38	.3180	.238
.323-.395	—	3/8 (.3750)	M10 (.3937)	2	2.94	1.25	.44	.3810	.286
.395-.448	—	7/16 (.4375)	—	3	3.16	1.44	.41	.3230	.242
.448-.510	—	1/2 (.5000)	M12 (.4724)	3	3.38	1.66	.44	.3670	.275
.510-.573	—	9/16 (.5625)	M14 (.5512)	3	3.59	1.66	.50	.4290	.322
.573-.635	—	5/8 (.6250)	M16 (.6299)	3	3.81	1.81	.56	.4800	.360
.635-.709	—	11/16 (.6875)	M18 (.7087)	3	4.03	1.81	.63	.5420	.406
.709-.760	—	3/4 (.7500)	—	3	4.25	2.00	.69	.5900	.442
.760-.823	—	13/16 (.8125)	M20 (.7874)	3	4.47	2.00	.69	.6520	.489
.823-.885	—	7/8 (.8750)	M22 (.8661)	3	4.69	2.22	.75	.6970	.523
.885-.948	—	15/16 (.9375)	M24 (.9449)	3	4.91	2.22	.75	.7600	.570
.948-1.010	—	1 (1.0000)	M25 (.9843)	3	5.13	2.50	.81	.8000	.600
1.010-1.073	—	1-1/16 (1.0625)	M27 (1.0630)	3	5.13	2.50	.88	.8960	.672
1.073-1.135	—	1-1/8 (1.1250)	—	3	5.44	2.56	.88	.8960	.672
1.135-1.198	—	1-3/16 (1.1875)	M30 (1.1811)	3	5.44	2.56	1.00	1.0210	.766
1.198-1.260	—	1-1/4 (1.2500)	—	3	5.75	2.56	1.00	1.0210	.766
1.260-1.323	—	1-5/16 (1.3125)	M33 (1.2992)	3	5.75	2.56	1.06	1.1080	.831
1.323-1.385	—	1-3/8 (1.3750)	—	3	6.06	3.00	1.06	1.1080	.831
1.358-1.448	—	1-7/16 (1.4375)	M36 (1.4173)	3	6.06	3.00	1.13	1.2330	.925
1.448-1.510	—	1-1/2 (1.5000)	—	3	6.38	3.00	1.13	1.2330	.925
1.510-1.635	—	1-5/8 (1.6250)	M39 (1.5354)	3	6.69	3.19	1.13	1.3050	.979
1.635-1.760	—	1-3/4 (1.7500)	M42 (1.6535)	3	7.00	3.19	1.25	1.4300	1.072
1.760-1.885	—	1-7/8 (1.8750)	—	3	7.31	3.56	1.25	1.5190	1.139
1.885-2.010	—	2 (2.0000)	M48 (1.8898)	3	7.63	3.56	1.38	1.6440	1.233
2.010-2.135	—	2-1/8 (2.1250)	—	3	8.00	3.56	1.38	1.7690	1.327
2.135-2.260	—	2-1/4 (2.2500)	M56 (2.2047)	3	8.25	3.56	1.44	1.8940	1.420
2.260-2.385	—	2-3/8 (2.3750)	—	3	8.50	4.00	1.44	2.0190	1.514
2.385-2.510	—	2-1/2 (2.5000)	—	3	8.75	4.00	1.50	2.1000	1.575
2.510-2.635	—	2-5/8 (2.6250)	M64 (2.5197)	3	8.75	4.00	1.50	2.2250	1.669
2.635-2.760	—	2-3/4 (2.7500)	—	3	9.25	4.00	1.56	2.3500	1.762
2.760-2.885	—	2-7/8 (2.8750)	M72 (2.8346)	3	9.25	4.00	1.56	2.4750	1.856
2.885-3.010	—	3 (3.0000)	—	3	9.75	4.56	1.63	2.5430	1.907
3.010-3.135	—	3-1/8 (3.1250)	—	3	9.75	4.56	1.63	2.6680	2.001
3.135-3.260	—	3-1/4 (3.2500)	M80 (3.1496)	3	10.00	4.56	1.75	2.7930	2.095
3.260-3.385	—	3-3/8 (3.3750)	—	3	10.00	4.56	1.75	2.8830	2.162
3.385-3.510	—	3-1/2 (3.5000)	—	3	10.25	4.94	2.00	3.0080	2.256
3.510-3.635	—	3-5/8 (3.6250)	M90 (3.5433)	3	10.25	4.94	2.00	3.1330	2.350
3.635-3.760	—	3-3/4 (3.7500)	—	3	10.50	5.31	2.13	3.2170	2.413
3.760-3.885	—	3-7/8 (3.8750)	—	3	10.50	5.31	2.13	3.3420	2.506
3.885-4.010	—	4 (4.0000)	M100 (3.9370)	3	10.75	5.31	2.25	3.4670	2.600

Reprinted with permission from United States Cutting Tool Institute (USCTI). Published by Kennametal Inc. © 2014. All rights reserved.

Optional Neck and Shortened Thread Length Dimensions • Reference USCTI Table 302A

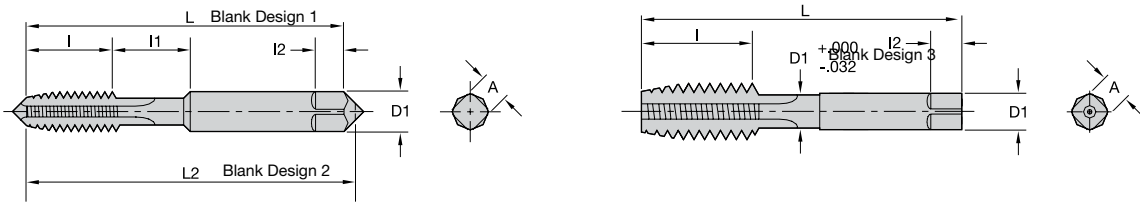

General Dimensions

Tap Dimensions – Inches

nominal diameter range (in)	machine screw size number (in)	nominal fractional diameter (in)	nominal metric diameter mm (in)	blank design number	overall length L	thread length l	neck length l1	square length l2	shank diameter D1	square size A
.104 .117	4 (.1120)	—	—	1	1.88	.31	.25	.19	.1410	.110
.117 .130	5 (.1250)	—	M3 (.1181)	1	1.94	.31	.31	.19	.1410	.110
.130 .145	6 (.1380)	—	M3.5 (.1378)	1	2.00	.38	.31	.19	.1410	.110
.145 .171	8 (.1640)	—	M4 (.1575)	1	2.13	.38	.38	.25	.1680	.131
.171 .197	10 (.1900)	—	M4.5 (.1772)	1	2.38	.50	.38	.25	.1940	.152
— —	— —	—	M5 (.1969)	—	—	—	—	—	—	—
.197 .223	12 (.2160)	—	—	1	2.38	.50	.44	.28	.2200	.165
.223 .260	—	1/4 (.2500)	M6 (.2362)	2	2.50	.63	.38	.31	.2550	.191
.260 .323	—	5/16 (.3125)	M7, M8 (.2756), (.3150)	2	2.72	.69	.44	.38	.3180	.238
.323 .395	—	3/8 (.3750)	M10 (.3937)	2	2.94	.75	.50	.44	.3810	.286
.395 .448	—	7/16 (.4375)	—	3	3.16	.88	—	.41	.3230	.242
.448 .510	—	1/2 (.5000)	M12 (.4724)	3	3.38	.94	—	.44	.3670	.275
.510 .573	—	9/16 (.5625)	M14 (.5541)	3	3.59	1.00	—	.50	.4290	.322
.573 .635	—	5/8 (.6250)	M16 (.6299)	3	3.81	1.09	—	.56	.4800	.360
.635 .709	—	11/16 (.6875)	M18 (.7087)	3	4.03	1.09	—	.63	.5420	.406
.709 .760	—	3/4 (.7500)	—	3	4.25	1.22	—	.69	.5900	.442
.760 .823	—	13/16 (.8125)	M20 (.7874)	3	4.47	1.22	—	.69	.6520	.489
.823 .885	—	7/8 (.8750)	M22 (.8661)	3	4.69	1.34	—	.75	.3670	.523
.885 .948	—	15/16 (.9375)	M24 (.9449)	3	4.91	1.34	—	.75	.7600	.570
.948 1.010	—	1 (1.0000)	M25 (.9843)	3	5.13	1.50	—	.81	.8000	.600

Reprinted with permission from United States Cutting Tool Institute (USCTI).  
Published by Kennametal Inc. © 2014. All rights reserved.

NOTE: Thread length l is based on a length of 12 pitches of the UNC thread series. Thread length "l" is a minimum value and has no tolerance. When thread length "l" is added to neck length "l1", the total shall be no less than the minimum USCTI Table 302 thread length "l". Unless otherwise specified, all tolerances are in accordance with USCTI Table 302. For eccentricity tolerances, see USCTI Table 317. Table 302 is provided for reference only. The Kennametal tap dimensions may differ.

Tolerances

element	nominal diameter range (in)	direction	tolerance (in)
length overall — L	.0520–1.0100	plus or minus	.031
	1.0100–4.0100	plus or minus	.063
length of thread — l	.0520–.2230	plus or minus	.047
	.2230–.5100	plus or minus	.063
	.5100–1.5100	plus or minus	.094
	1.5100–4.0100	plus or minus	.125
length of square — l2	.0520–1.0100	plus or minus	.031
	1.0100–4.0100	plus or minus	.063
diameter of shank — d1	.0520–.2230	minus	.0015
	.2230–.6350	minus	.0015
	.6350–1.0100	minus	.0020
	1.0100–1.5100	minus	.0020
	1.5100–2.0100	minus	.0030
	2.0100–4.0100	minus	.0030
size of square — a	.0520–.5100	minus	.004
	.5100–1.0100	minus	.006
	1.0100–2.0100	minus	.008
	2.0100–4.0100	minus	.010

Reprinted with permission from United States Cutting Tool Institute (USCTI).  
Published by Kennametal Inc. © 2014. All rights reserved.

Special Taps

Unless otherwise specified: Special taps over 1.010–1.510" diameter inclusive, having 14 or more threads per inch or 1,75mm pitch and finer, and sizes over 1.510" diameter with 10 or more threads per inch or 2,5mm pitch and finer, are made to general dimensions shown in USCTI Table 303. Special tap thread limits are determined using the formulas shown in USCTI Table 331 for Unified Inch Screw Threads and USCTI Table 341 for metric m-profile screw threads.

NOTE: Tap sizes .395" and smaller have an external center on the thread end (may be removed on bottoming taps). Sizes .125" and smaller have an external center on the shank end. Sizes .224–.395" have truncated partial cone centers on the shank end (length of cone approximately 1/4 of diameter of shank). Sizes over .395" have internal centers on both the thread and shank ends. For standard thread limits and tolerances for Unified Inch Screw Threads, see USCTI Table 327, and for metric threads, see USCTI Table 337. For eccentricity tolerances of tap elements, see USCTI Table 317.



## Standard Pipe Tap Dimensions • Straight and Taper • Ground Thread • Reference USCTI Table 311

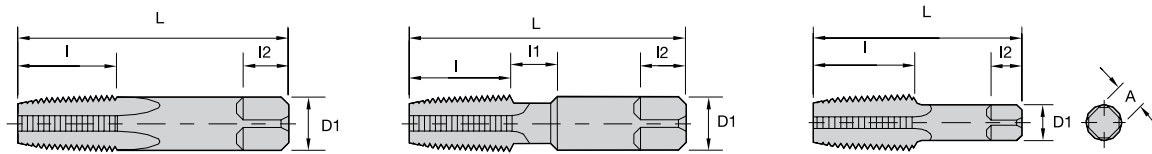

### General Dimensions

dimensions (in)						
nominal size (in)	overall length L	thread length l	square length l2	shank diameter D1	square size A	optional neck length l1
1/16	2.13	.69	.38	.3125	.234	.375
1/8	2.13	.75	.38	.3125	.234	—
1/8	2.13	.75	.38	.4375	.328	.375
1/4	2.44	1.06	.44	.5625	.421	.375
3/8	2.56	1.06	.50	.7000	.531	.375
1/2	3.13	1.38	.63	.6875	.515	—
3/4	3.25	1.38	.69	.9063	.679	—
1	3.75	1.75	.81	1.1250	.843	—
1-1/4	4.00	1.75	.94	1.3125	.984	—
1-1/2	4.25	1.75	1.00	1.5000	1.125	—
2	4.25	1.75	1.13	1.8750	1.406	—
2-1/2	5.50	2.56	1.25	2.2500	1.687	—
3	6.00	2.63	1.38	2.6250	1.968	—
3-1/2	6.50	2.69	1.50	2.8125	2.108	—
4	6.75	2.75	1.56	3.0000	2.250	—

### Tolerances

element	range	direction	tolerance
length overall — L	1/16–3/4 inc.	plus/minus	.031
	1–4 inc.	plus/minus	.063
length of thread — l	1/16–3/4 inc.	plus/minus	.063
	1–1-1/4 inc.	plus/minus	.094
length of square — l2	1-1/2–4	plus/minus	.125
	1/16–3/4 inc.	plus/minus	.031
diameter of shank — d1	1–4 inc.	plus/minus	.063
	1/16–1/8	minus	.0015
size of square — a	1/4–1 inc.	minus	.0020
	1-1/4–4 inc.	minus	.0030
size of square — a	1/16–1/8	minus	.004
	1/4–3/4 inc.	minus	.006
	1–4 inc.	minus	.008

Reprinted with permission from United States Cutting Tool Institute (USCTI). Published by Kennametal Inc. © 2014. All rights reserved.

Taper Pipe Tap Thread Limits • Ground Thread • Reference USCTI Table 338

- American National Standard Taper Pipe Thread Form (NPT)
- Aeronautical National Taper Pipe Thread Form (ANPT)
- Dryseal American National Standard Taper Pipe Thread Form (NPTF)

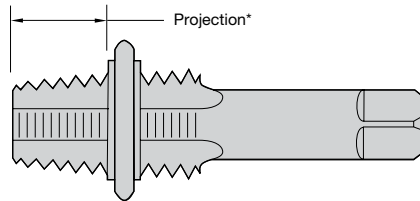

taper per foot limits

nominal size (in)	threads per inch	projection* (in)	projection tolerance + / -	min	max	length L1	tap drill size** NPT, ANPT, NPTF
1/16	27	.312	.063	.719	.781	.160	C
1/8	27	.312	.063	.719	.781	.1615	Q
1/4	18	.459	.063	.719	.781	.2278	7/16
3/8	18	.454	.063	.719	.781	.240	9/16
1/2	14	.579	.063	.719	.781	.320	45/64
3/4	14	.565	.063	.719	.781	.339	29/32
1	11-1/2	.678	.094	.719	.781	.400	1-9/64
1-1/4	11-1/2	.686	.094	.719	.781	.420	1-31/64
1-1/2	11-1/2	.699	.094	.719	.781	.420	1-23/32
2	11-1/2	.667	.094	.719	.781	.436	2-3/16
2-1/2	8	.925	.094	.734	.781	.682	2-39/64
3	8	.925	.094	.734	.781	.766	3-15/64
3-1/2	8	.938	.125	.734	.781	.821	—
4	8	.950	.125	.734	.781	.844	—

\*Distance from small end of tap projects through L1 taper thread ring gage.

\*\*Recommended size given permits direct tapping without reaming the hole, but only gives a full thread for approximately the L1 length. Reprinted with permission from United States Cutting Tool Institute (USCTI). Published by Kennametal Inc. © 2014. All rights reserved.

Pipe Taps

General-purpose pipe taps are appropriate for threading a wide variety of materials, both ferrous and non-ferrous.

Ground thread pipe taps are standard in American Standard Pipe Form (NPT) and American Standard Dryseal Pipe Form (NPTF). NPT threads require the use of a sealer, like Teflon™ tape or pipe compound. Dryseal taps are used to tap fittings, which will give a pressure-tight joint without the use of a sealer.

The nominal size of a pipe tap is that of the pipe fitting to be tapped, not the actual size of the tap. The thread tapers 3/4" per foot. All pipe taps are furnished with 2-1/2-3-1/2 thread chamfer.

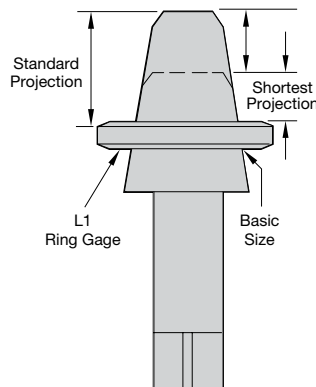

Short projection pipe taps are made with a projection shorter than standard for taper pipe tapping where the depth of tapping is limited.

Special short projection taper pipe taps can be furnished with American National Standard Taper Pipe thread (ANPT) or Dryseal American National Standard Taper Pipe thread (NPTF, PTF-SAE Short, or PTF-SPL Extra Short).

For information on short projection pipe taps and hole preparation for NPT, NPTF, and ANPT internal pipe threads, consult Kennametal Technical Bulletins.



# Turning

<b>External Turning and and Internal Boring .....</b>	<b>E4–E300</b>
High-Performance Inserts • WIDIA Victory .....	E4–E117
High-Performance Inserts for Machining Aluminum.....	E118–E125
Advanced Materials Inserts • CBN, Ceramics and PCD .....	E126–E180
Toolholders for External Turning.....	E182–E204
Toolholders for Internal Boring .....	E206–E222
Cartridges for Internal Boring.....	E224–E233
Railway Wheel Reprofilng/Wheelset Turning/Bar Peeling.....	E234–E243
Small Hole Boring .....	E244–E300
<b>Grooving and Cut-Off.....</b>	<b>E302–E439</b>
WGC .....	E302–E349
WMT.....	E350–E382
TopGroove .....	E384–E434
LG Grooving.....	E436–E439
<b>Threading .....</b>	<b>E440–E520</b>
TopThread.....	E440–E467
Laydown .....	E468–E498
Technical Information.....	E499–E520

# WIDIA™ Victory™ Turning Inserts

## Turning

The Victory ISO turning portfolio offers a comprehensive range of ISO Turning Inserts with advanced substrates and coating technologies for high productivity, long tool life, and reliability in rough to finish-turning applications. Inserts in this portfolio can be applied across a wide range of applications with effective chip control and smooth surface finish at a strong cost performance ratio.

### NEGATIVE INSERTS

- Negative-style inserts are first choice for general machining of materials in medium to large lathes
- Negative-style inserts are available in flat-top and chip-control chip breakers in both molded and ground peripheries suitable for all workpiece materials



### POSITIVE INSERTS

- Screw-on inserts are the first choice for I.D. turning of all materials and O.D. turning on small to medium lathes suitable for all workpiece materials



### PCBN AND PCD INSERTS

- PcBN can be used for machining steels with a hardness higher than 48 HRC
- PcBN inserts can also be used for productivity improvements in machining cast irons and high-temp alloys
- PCD inserts are used to machine non-ferrous materials



### CERAMIC INSERTS

- Ceramic inserts are a great choice for productive machining of high-temp alloys
- Negative rake inserts are also recommended for the machining of hardened materials and cast irons available in flat-top chip breakers with molded and ground peripheries

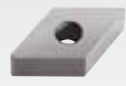

## WIDIA VICTORY TURNING INSERTS

### VERSATILITY

Specialty engineering substrate with wear-resistant, multi-layer coating makes it suitable for wide range of applications.

### STABILITY

Pre- and post-coat treatment along with post-coat grinding improves edge toughness, provides secure seating leading to consistent performance.

### PRODUCTIVITY

Multi-layer CVD coating with alpha-alumina layer provides higher productivity and tool life with reliability at elevated speeds and feeds.

### SIMPLICITY

Outer layer bronze colored for easy wear identification. Easy to select and apply grades and chip breakers for roughing to finishing applications in variety of workpiece materials.

# STEEL, STAINLESS STEEL, CAST IRON, AND HIGH-TEMP ALLOY INSERTS

## VICTORY™ Turning

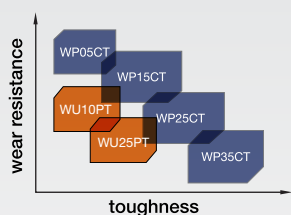

### WP GRADES FOR STEEL

- Four grades for use in roughing to finishing operations
- Increase cutting speed and/or feed rate to gain productivity

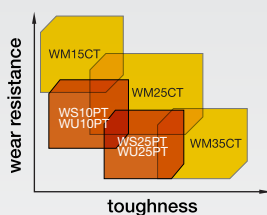

### WM GRADES FOR STAINLESS STEEL

- Three grades in suitable chip breakers for use in roughing to finishing operations
- Very good balance of wear resistance and toughness for long, predictable tool life

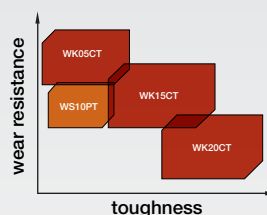

### WK GRADES FOR CAST IRON

- Three grades to cover all of your cast iron turning operations
- Increase cutting speed and/or feed rate by up to 30% over similar competitive grades
- WK15CT is the first choice for cast iron turning

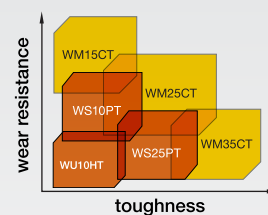

### WS GRADES FOR HIGH-TEMP ALLOYS

- Two grades for use in roughing to finishing operations
- Very good wear resistance for longer tool life

## INDUSTRY



### Catalog Numbering System

Each character in our catalog number signifies a specific trait of that product. Use the following key columns and corresponding images to easily identify which attributes apply.

C		N		M		G		4																																																																																																																																																																																																																																		
Insert Shape		Insert Clearance Angle		Tolerance Class		Insert Features		Size																																																																																																																																																																																																																																		
<b>H</b>	Hexagon 120°	<b>A</b>	3°	Tolerances apply prior to edge prep and coating  		<b>N</b>		<table border="1"> <thead> <tr> <th colspan="2"></th> <th colspan="7">Code for inch cutting edge length "L10"</th> </tr> <tr> <th>inch</th> <th>"D"</th> <th>C</th> <th>D</th> <th>R</th> <th>S</th> <th>T</th> <th>V</th> <th>W</th> </tr> </thead> <tbody> <tr> <td>1.2 (5)</td> <td>5/32</td> <td>S4</td> <td>04</td> <td>03</td> <td>03</td> <td>06</td> <td>—</td> <td>—</td> </tr> <tr> <td>1.5 (6)</td> <td>3/16</td> <td>04</td> <td>05</td> <td>04</td> <td>04</td> <td>08</td> <td>08</td> <td>S3</td> </tr> <tr> <td>1.8 (7)</td> <td>7/32</td> <td>05</td> <td>06</td> <td>05</td> <td>05</td> <td>09</td> <td>09</td> <td>03</td> </tr> <tr> <td>—</td> <td>.236</td> <td>—</td> <td>—</td> <td>06</td> <td>—</td> <td>—</td> <td>—</td> <td>—</td> </tr> <tr> <td>2</td> <td>1/4</td> <td>06</td> <td>07</td> <td>06</td> <td>06</td> <td>11</td> <td>11</td> <td>04</td> </tr> <tr> <td>2.5</td> <td>5/16</td> <td>08</td> <td>09</td> <td>07</td> <td>07</td> <td>13</td> <td>13</td> <td>05</td> </tr> <tr> <td>—</td> <td>.315</td> <td>—</td> <td>—</td> <td>08</td> <td>—</td> <td>—</td> <td>—</td> <td>—</td> </tr> <tr> <td>3</td> <td>3/8</td> <td>09</td> <td>11</td> <td>09</td> <td>09</td> <td>16</td> <td>16</td> <td>06</td> </tr> <tr> <td>—</td> <td>.394</td> <td>—</td> <td>—</td> <td>10</td> <td>—</td> <td>—</td> <td>—</td> <td>—</td> </tr> <tr> <td>3.5</td> <td>7/16</td> <td>11</td> <td>13</td> <td>11</td> <td>11</td> <td>19</td> <td>19</td> <td>07</td> </tr> <tr> <td>—</td> <td>.472</td> <td>—</td> <td>—</td> <td>12</td> <td>—</td> <td>—</td> <td>—</td> <td>—</td> </tr> <tr> <td>4</td> <td>1/2</td> <td>12</td> <td>15</td> <td>12</td> <td>12</td> <td>22</td> <td>22</td> <td>08</td> </tr> <tr> <td>4.5</td> <td>9/16</td> <td>14</td> <td>17</td> <td>14</td> <td>14</td> <td>24</td> <td>24</td> <td>09</td> </tr> <tr> <td>5</td> <td>5/8</td> <td>16</td> <td>19</td> <td>15</td> <td>15</td> <td>27</td> <td>27</td> <td>10</td> </tr> <tr> <td>—</td> <td>.630</td> <td>—</td> <td>—</td> <td>16</td> <td>—</td> <td>—</td> <td>—</td> <td>—</td> </tr> <tr> <td>5.5</td> <td>11/16</td> <td>17</td> <td>21</td> <td>17</td> <td>17</td> <td>30</td> <td>30</td> <td>11</td> </tr> <tr> <td>6</td> <td>3/4</td> <td>19</td> <td>23</td> <td>19</td> <td>19</td> <td>33</td> <td>33</td> <td>13</td> </tr> <tr> <td>—</td> <td>.787</td> <td>—</td> <td>—</td> <td>20</td> <td>—</td> <td>—</td> <td>—</td> <td>—</td> </tr> <tr> <td>7</td> <td>7/8</td> <td>22</td> <td>27</td> <td>22</td> <td>22</td> <td>38</td> <td>38</td> <td>15</td> </tr> <tr> <td>—</td> <td>.984</td> <td>—</td> <td>—</td> <td>25</td> <td>—</td> <td>—</td> <td>—</td> <td>—</td> </tr> <tr> <td>8</td> <td>1</td> <td>25</td> <td>31</td> <td>25</td> <td>25</td> <td>44</td> <td>44</td> <td>17</td> </tr> <tr> <td>10</td> <td>1-1/4</td> <td>32</td> <td>38</td> <td>31</td> <td>31</td> <td>54</td> <td>54</td> <td>21</td> </tr> <tr> <td>—</td> <td>1.260</td> <td>—</td> <td>—</td> <td>32</td> <td>—</td> <td>—</td> <td>—</td> <td>—</td> </tr> </tbody> </table>				Code for inch cutting edge length "L10"							inch	"D"	C	D	R	S	T	V	W	1.2 (5)	5/32	S4	04	03	03	06	—	—	1.5 (6)	3/16	04	05	04	04	08	08	S3	1.8 (7)	7/32	05	06	05	05	09	09	03	—	.236	—	—	06	—	—	—	—	2	1/4	06	07	06	06	11	11	04	2.5	5/16	08	09	07	07	13	13	05	—	.315	—	—	08	—	—	—	—	3	3/8	09	11	09	09	16	16	06	—	.394	—	—	10	—	—	—	—	3.5	7/16	11	13	11	11	19	19	07	—	.472	—	—	12	—	—	—	—	4	1/2	12	15	12	12	22	22	08	4.5	9/16	14	17	14	14	24	24	09	5	5/8	16	19	15	15	27	27	10	—	.630	—	—	16	—	—	—	—	5.5	11/16	17	21	17	17	30	30	11	6	3/4	19	23	19	19	33	33	13	—	.787	—	—	20	—	—	—	—	7	7/8	22	27	22	22	38	38	15	—	.984	—	—	25	—	—	—	—	8	1	25	31	25	25	44	44	17	10	1-1/4	32	38	31	31	54	54	21	—	1.260	—	—	32	—	—	—	—
		Code for inch cutting edge length "L10"																																																																																																																																																																																																																																								
inch	"D"	C	D	R	S	T	V			W																																																																																																																																																																																																																																
1.2 (5)	5/32	S4	04	03	03	06	—			—																																																																																																																																																																																																																																
1.5 (6)	3/16	04	05	04	04	08	08			S3																																																																																																																																																																																																																																
1.8 (7)	7/32	05	06	05	05	09	09			03																																																																																																																																																																																																																																
—	.236	—	—	06	—	—	—			—																																																																																																																																																																																																																																
2	1/4	06	07	06	06	11	11			04																																																																																																																																																																																																																																
2.5	5/16	08	09	07	07	13	13			05																																																																																																																																																																																																																																
—	.315	—	—	08	—	—	—			—																																																																																																																																																																																																																																
3	3/8	09	11	09	09	16	16			06																																																																																																																																																																																																																																
—	.394	—	—	10	—	—	—			—																																																																																																																																																																																																																																
3.5	7/16	11	13	11	11	19	19	07																																																																																																																																																																																																																																		
—	.472	—	—	12	—	—	—	—																																																																																																																																																																																																																																		
4	1/2	12	15	12	12	22	22	08																																																																																																																																																																																																																																		
4.5	9/16	14	17	14	14	24	24	09																																																																																																																																																																																																																																		
5	5/8	16	19	15	15	27	27	10																																																																																																																																																																																																																																		
—	.630	—	—	16	—	—	—	—																																																																																																																																																																																																																																		
5.5	11/16	17	21	17	17	30	30	11																																																																																																																																																																																																																																		
6	3/4	19	23	19	19	33	33	13																																																																																																																																																																																																																																		
—	.787	—	—	20	—	—	—	—																																																																																																																																																																																																																																		
7	7/8	22	27	22	22	38	38	15																																																																																																																																																																																																																																		
—	.984	—	—	25	—	—	—	—																																																																																																																																																																																																																																		
8	1	25	31	25	25	44	44	17																																																																																																																																																																																																																																		
10	1-1/4	32	38	31	31	54	54	21																																																																																																																																																																																																																																		
—	1.260	—	—	32	—	—	—	—																																																																																																																																																																																																																																		
<b>O</b>	Octagon 135°	<b>B</b>	5°			<b>R</b>																																																																																																																																																																																																																																				
<b>P</b>	Pentagon 108°	<b>C</b>	7°			<b>M</b>																																																																																																																																																																																																																																				
<b>R</b>	Round	<b>D</b>	15°			<b>A</b>																																																																																																																																																																																																																																				
<b>S</b>	Square 90°	<b>E</b>	20°			<b>G</b>																																																																																																																																																																																																																																				
<b>T</b>	Triangular 60°	<b>F</b>	25°	<p><b>D</b> = Theoretical diameter of the insert inscribed circle <b>S</b> = Thickness <b>B</b> = See figures below</p>		<b>W</b>																																																																																																																																																																																																																																				
<b>C</b>	Rhomboid 80°	<b>G</b>	30°			<b>T</b>																																																																																																																																																																																																																																				
<b>D</b>	55°	<b>N</b>	0°	<p><b>D</b> = Theoretical diameter of the insert inscribed circle <b>S</b> = Thickness <b>B</b> = See figures below</p>		<b>Q</b>																																																																																																																																																																																																																																				
<b>E</b>	75°	<b>P</b>	11°			<b>U</b>																																																																																																																																																																																																																																				
<b>M</b>	86°	<b>W</b>	Trigon 80° with enlarged corner angles	<p><b>D</b> = Theoretical diameter of the insert inscribed circle <b>S</b> = Thickness <b>B</b> = See figures below</p>		<b>B</b>																																																																																																																																																																																																																																				
<b>V</b>	35°	<b>L</b>	Rectangular 90°			<b>H</b>																																																																																																																																																																																																																																				
<b>A</b>	Parallelogram 85°	<b>A</b>	3°	<p><b>D</b> = Theoretical diameter of the insert inscribed circle <b>S</b> = Thickness <b>B</b> = See figures below</p>		<b>C</b>																																																																																																																																																																																																																																				
<b>B</b>	82°	<b>O</b>	Indicated for other clearance angles requiring descriptions.			<b>J</b>																																																																																																																																																																																																																																				
<b>N/K</b>	55°	<b>X</b>		<p><b>D</b> = Theoretical diameter of the insert inscribed circle <b>S</b> = Thickness <b>B</b> = See figures below</p>		<b>V</b>	Special Design																																																																																																																																																																																																																																			

tolerance class	tolerance on "D"	tolerance on "B"	tolerance on "S"
C	±.0010"	±.0005"	±.001"
H	±.0005"	±.0005"	±.001"
E	±.0010"	±.0010"	±.001"
G	±.0010"	±.0010"	±.005"
M	See tables on next page		±.005"
U	See tables on next page		±.005"



### Catalog Numbering System

(continued)

INDEXABLE MILLING

SOLID END MILLING

HOLEMAKING

TAPPING

TURNING

#### 3

Thickness  
S

symbol	thickness
inch	inch
.5 (1)	1/32
.6	.040
1 (2)	1/16
1.2	5.64
1.5	3/32
2	1/8
2.5	5/32
3	3/16
3.5	7/32
4	1/4
5	5/16
6	3/8
7	7/16
18	1/2

#### 2

Corner  
Radius "Rε"

symbol	corner radius
inch	inch
X0	.0015
0	.004
.5	.008
1	1/64
2	1/32
3	3/64
4	1/16
5	5/64
6	3/32
7	7/64
8	1/8
—	round insert
—	

#### 3

Hand of Insert  
(optional)

R = Right hand  
L = Left hand  
N = Neutral

#### 2

Cutting Edge  
(optional)

F		Sharp
E		Rounded
T		Chamfered
S		Chamfered and Rounded
K		Double-Chamfered
P		Double-Chamfered and Rounded

#### UR

Chipbreaker  
(optional)

13	=	Railroad Light
CT	=	Copy Turning
FF	=	Fine Finishing
FP	=	Finish Positive
FW	=	Finish Wiper
ML	=	Medium Light
MR	=	Medium Roughing
MW	=	Medium Wiper
RH	=	Roughing Heavy
T	=	Negative Land
UF	=	Universal Finishing
UM	=	Universal Medium
UR	=	Universal Roughing
.NMP	=	Sharp Medium
MP	=	Medium Positive
FS	=	Finishing High-Temp(S)
MS	=	Medium High-Temp(S)
MU	=	Medium Universal
SR	=	Super Roughing
65	=	Heavy Roughing
8	=	Heavy Roughing
.NGP	=	Sharp Medium

"D"	± Tolerance on "D"				"D"	± Tolerance on "B"			
	Class M Tolerance			Class U Tolerance		Class M Tolerance			Class U Tolerance
	Shapes S, T, C, R, & W	Shape D	Shape V	Shapes S, T, & C		Shapes S, T, C, R, & W	Shape D	Shape V	Shapes S, T, & C
inch	inch	inch	inch	inch	inch	inch	inch	inch	
5/32	.002	—	—	—	5/32	.003	—	—	—
3/16	.002	—	—	.003	3/16	.003	—	—	.005
7/32	.002	.002	.002	.003	7/32	.003	.004	—	.005
1/4	.002	.002	.002	.003	1/4	.003	.004	—	.005
5/16	.002	.002	.002	.003	5/16	.003	.004	—	.005
3/8	.002	.002	.002	.003	3/8	.003	.004	.007	.005
7/16	.003	.003	.003	.005	7/16	.005	.006	—	—
1/2	.003	.003	.003	.005	1/2	.005	.006	.010	.008
9/16	.003	.003	.003	.005	9/16	.005	.006	—	—
5/8	.004	.004	.004	.007	5/8	.006	.007	—	.011
11/16	.004	.004	.004	.007	11/16	.006	.007	—	.011
3/4	.004	.004	.004	.007	3/4	.006	.007	—	.011
7/8	.005	—	—	.010	7/8	.006	—	—	.015
1	.005	—	—	.010	1	.007	—	—	.015
1 1/4	.006	—	—	.010	1 1/4	.008	—	—	.015

"D"	± Tolerance on "D"				"D"	± Tolerance on "B"			
	Class M Tolerance			Class U Tolerance		Class M Tolerance			Class U Tolerance
	Shapes S, T, C, R, & W	Shape D	Shape V	Shapes S, T, & C		Shapes S, T, C, R, & W	Shape D	Shape V	Shapes S, T, & C
inch	inch	inch	inch	inch	inch	inch	inch	inch	
5/32	.002	—	—	—	5/32	.003	—	—	—
3/16	.002	—	—	.003	3/16	.003	—	—	.005
7/32	.002	.002	.002	.003	7/32	.003	.004	—	.005
1/4	.002	.002	.002	.003	1/4	.003	.004	—	.005
5/16	.002	.002	.002	.003	5/16	.003	.004	—	.005
3/8	.002	.002	.002	.003	3/8	.003	.004	.007	.005
7/16	.003	.003	.003	.005	7/16	.005	.006	—	—
1/2	.003	.003	.003	.005	1/2	.005	.006	.010	.008
9/16	.003	.003	.003	.005	9/16	.005	.006	—	—
5/8	.004	.004	.004	.007	5/8	.006	.007	—	.011
11/16	.004	.004	.004	.007	11/16	.006	.007	—	.011
3/4	.004	.004	.004	.007	3/4	.006	.007	—	.011
7/8	.005	—	—	.010	7/8	.006	—	—	.015
1	.005	—	—	.010	1	.007	—	—	.015
1 1/4	.006	—	—	.010	1 1/4	.008	—	—	.015



## Victory Grade Naming System

ISO turning products featured in the All-Star program provide solutions for applications in steel, stainless steel, cast iron, and high-temp alloys. WIDIA™ Victory turning grades and geometries deliver higher productivity through reduced cycle time, long tool life, and improved chip control.

W	P	15	C	T
Brand	Workpiece Material	Application Range	Insert Material	Application
<p><b>W</b> = WIDIA</p>	<p><b>P</b> = Steel  <b>M</b> = Stainless Steel  <b>K</b> = Cast Iron  <b>N</b> = Non Ferrous  <b>S</b> = High-Temp Alloys  <b>H</b> = Hardened Materials  <b>U</b> = Universal Application</p>	<p><b>05</b> = Fine Finishing  <b>10</b> = Finishing  <b>15</b> = }  <b>20</b> = } Medium to Roughing  <b>25</b> = }  <b>30</b> = } Roughing  <b>35</b> = }  <b>40</b> = }  <b>45</b> = } Heavy Roughing  <b>50</b> = }</p>	<p><b>H</b> = Carbide (Uncoated)  <b>C</b> = Carbide + CVD  <b>P</b> = Carbide + PVD  <b>T</b> = Cermet  <b>Y</b> = Ceramics  <b>D</b> = Diamond  <b>B</b> = PCBN  <b>S</b> = HSS  <b>E</b> = HSS-E  <b>M</b> = HSS-E-PM</p>	<p><b>T</b> = Turning  <b>M</b> = Milling  <b>H</b> = Holemaking  <b>D</b> = Solid Drills  <b>E</b> = Solid End Mills  <b>G</b> = Taps  <b>R</b> = Reamers  <b>V</b> = Thread Mills</p>

## Cutting Speed Recommendation • P • Inch

**Low-Carbon (<0.3% C) and Free-Machining Steel** Starting Conditions

material group	grade	speed – m/min (SFM)									m/min	SFM
		135 (450)	180 (600)	225 (800)	275 (900)	320 (1050)	360 (1200)	410 (1350)	455 (1500)	495 (1650)		
P0/P1	WP05CT										435	1450
	WP15CT										395	1320
	WP25CT										275	925
	WP35CT										210	700
	WS10PT/WU10PT										280	925

**Medium- and High-Carbon Steels (>0.3% C)** Starting Conditions

material group	grade	speed – m/min (SFM)									m/min	SFM
		135 (450)	180 (600)	225 (800)	275 (900)	320 (1050)	360 (1200)	410 (1350)	455 (1500)	495 (1650)		
P2	WP05CT										240	800
	WP15CT										265	880
	WP25CT										195	650
	WP35CT										150	500
	WS10PT/WU10PT										200	650

**Alloy Steels and Tool Steels (≤330 HB) (≤35 HRC)** Starting Conditions

material group	grade	speed – m/min (SFM)									m/min	SFM
		135 (450)	180 (600)	225 (800)	275 (900)	320 (1050)	360 (1200)	410 (1350)	455 (1500)	495 (1650)		
P3	WP05CT										205	680
	WP15CT										190	630
	WP25CT										155	510
	WP35CT										120	400
	WS10PT/WU10PT										155	510

**Alloy Steels and Tool Steels (340–450 HB) (36–48 HRC)** Starting Conditions

material group	grade	speed – m/min (SFM)									m/min	SFM
		60 (200)	90 (300)	120 (400)	150 (500)	180 (600)	210 (700)	240 (800)	270 (900)	300 (1000)		
P4	WP05CT										160	530
	WP15CT										145	480
	WP25CT										105	360
	WP35CT										95	325
	WS10PT/WU10PT										110	360

**Ferritic, Martensitic, and PH Stainless Steels (≤330 HB) (≤35 HRC)** Starting Conditions

material group	grade	speed – m/min (SFM)									m/min	SFM
		120 (400)	150 (500)	180 (600)	210 (700)	240 (800)	270 (900)	300 (1000)	330 (1100)	360 (1200)		
P5	WP05CT										240	800
	WP15CT										215	720
	WP25CT										195	650
	WP35CT										135	450
	WS10PT/WU10PT										200	660

**Ferritic, Martensitic, and PH Stainless Steels (340–450 HB) (36–48 HRC)** Starting Conditions

material group	grade	speed – m/min (SFM)									m/min	SFM
		105 (350)	135 (450)	165 (550)	195 (650)	225 (750)	255 (850)	285 (950)	315 (1050)	345 (1150)		
P6	WP05CT										200	660
	WP15CT										180	600
	WP25CT										150	500
	WP35CT										105	350
	WS10PT/WU10PT										150	500

## Cutting Speed Recommendation • M • Inch

**Austenitic Stainless Steel** Starting Conditions

material group	grade	speed – m/min (SFM)										m/min	SFM
		90 (300)	135 (450)	180 (600)	225 (800)	270 (900)	315 (1050)	360 (1200)	405 (1350)	450 (1500)			
<b>M1</b>	WM15CT											180	600
	WM25CT											150	500
	WM35CT											120	400
	WS10PT											215	700
	WS25PT											180	550

**Austenitic Stainless Steel** Starting Conditions

material group	grade	speed – m/min (SFM)										m/min	SFM
		90 (300)	135 (450)	180 (600)	225 (800)	270 (900)	315 (1050)	360 (1200)	405 (1350)	450 (1500)			
<b>M2</b>	WM15CT											165	550
	WM25CT											140	450
	WM35CT											105	350
	WS10PT											200	650
	WS25PT											165	500

**Austenitic Stainless Steel: Duplex (Ferritic and Austenitic Mixture)** Starting Conditions

material group	grade	speed – m/min (SFM)										m/min	SFM
		90 (300)	135 (450)	180 (600)	225 (800)	270 (900)	315 (1050)	360 (1200)	405 (1350)	450 (1500)			
<b>M3</b>	WM15CT											150	500
	WM25CT											120	400
	WM35CT											90	300
	WS10PT											185	600
	WS10PT/WU25PT											150	450

## Cutting Speed Recommendation • K • Inch

**Gray Cast Iron** Starting Conditions

material group	grade	speed – m/min (SFM)										m/min	SFM
		60 (200)	180 (600)	305 (1000)	430 (1400)	550 (1800)	675 (2200)	800 (2600)	920 (3000)	1040 (3400)	1160 (3800)		
<b>K1</b>	WK05CT											450	1500
	WK15CT											360	1200
	WK20CT											300	1000

**Ductile, Compacted Graphite, and Malleable Cast Irons (<600 MPa tensile strength)** Starting Conditions

material group	grade	speed – m/min (SFM)										m/min	SFM
		90 (300)	135 (450)	180 (600)	225 (750)	275 (900)	320 (1050)	360 (1200)	410 (1350)	460 (1500)	500 (1650)		
<b>K2</b>	WS10PT/WU10PT											200	650
	WK05CT											360	1200
	WK15CT											270	900
	WK20CT											240	800

**Ductile, Malleable, and Austempered Cast Irons (>600 MPa tensile strength)** Starting Conditions

material group	grade	speed – m/min (SFM)										m/min	SFM
		90 (300)	135 (450)	180 (600)	225 (750)	275 (900)	320 (1050)	360 (1200)	410 (1350)	460 (1500)	500 (1650)		
<b>K3</b>	WS10PT/WU10PT											150	500
	WK05CT											240	800
	WK15CT											215	725
	WK20CT											210	700

## CUTTING SPEED RECOMMENDATION • N • INCH

### Low-Silicon Aluminum Alloys (hypoeutectic <12,2% Si) and Magnesium Alloys

material group	grade	Speed – m/min (SFM)										Starting Conditions	
		250 (800)	500 (1600)	750 (2400)	1000 (3200)	1250 (4000)	1500 (4800)	1750 (5600)	2000 (6400)	2250 (7200)	2500 (8000)	m/min	SFM
N1	WU10HT	◊										488	1597

### Low-Silicon Aluminum Alloys (hypoeutectic <12,2% Si) and Magnesium Alloys

material group	grade	Speed – m/min (SFM)										Starting Conditions	
		250 (800)	500 (1600)	750 (2400)	1000 (3200)	1250 (4000)	1500 (4800)	1750 (5600)	2000 (6400)	2250 (7200)	2500 (8000)	m/min	SFM
N2	WU10HT	◊										488	1597

### High-Silicon Aluminum Alloys (hypereutectic >12,2% Si) and Magnesium Alloys

material group	grade	Speed – m/min (SFM)										Starting Conditions	
		250 (800)	500 (1600)	750 (2400)	1000 (3200)	1250 (4000)	1500 (4800)	1750 (5600)	2000 (6400)	2250 (7200)	2500 (8000)	m/min	SFM
N3	WU10HT	◊										488	1597
	WU05PT	◊										550	1800

### Copper-, Brass-, Zinc-Based on a Machinability Index Range of 70–100

material group	grade	Speed – m/min (SFM)				Starting Conditions	
		250 (800)	500 (1600)	750 (2400)	1000 (3200)	m/min	SFM
N4	WU10HT	◊				259	847
	WU05PT	◊				275	900

### Nylon, Plastics, Rubbers, Phenolics, Resins, Fiberglass, and Glass

material group	grade	Speed – m/min (SFM)				Starting Conditions	
		250 (800)	500 (1600)	750 (2400)	1000 (3200)	m/min	m/min
N5	WU10HT	◊				170	550
	WU05PT	◊				170	550

### Carbon and Graphite Composites: Brush Alloys, Kevlar, and Graphite (280–400 HB) (30–43 HRC)

material group	grade	Speed – m/min (SFM)				Starting Conditions	
		250 (800)	500 (1600)	750 (2400)	1000 (3200)	m/min	m/min
N6	WU05PT	◊				200	650

### MMCs (Aluminum-Based Metal Matrix Composites)

material group	grade	Speed – m/min (SFM)				Starting Conditions	
		250 (800)	500 (1600)	750 (2400)	1000 (3200)	m/min	SFM
N7	WU10HT	◊				180	589

### Tin Alloys, Cast: ASTM 823, Alloys 1, 2, 3, 11

material group	grade	Speed – m/min (SFM)				Starting Conditions	
		250 (800)	500 (1600)	750 (2400)	1000 (3200)	m/min	SFM
N8	WU05PT	◊				215	700

## Cutting Speed Recommendation • S • Inch

### Iron-Based, Heat-Resistant Alloys (135–320 HB) (≤34 HRC)

material group	grade	speed – m/min (SFM)										Starting Conditions	
		15 (50)	45 (150)	75 (250)	105 (350)	140 (450)	170 (550)	200 (650)	230 (750)	290 (950)	310 (1050)	m/min	SFM
S1	WU10HT	◊										30	100
	WS10PT/WU10PT	◊										55	180
	WS25PT/WU25PT	◊										40	125
	WM15CT	◊										55	180
	WM25CT/WM35CT	◊										40	125

### Cobalt-Based, Heat-Resistant Alloys (150–425 HB) (≤45 HRC)

material group	grade	speed – m/min (SFM)										Starting Conditions	
		15 (50)	45 (150)	75 (250)	105 (350)	140 (450)	170 (550)	200 (650)	230 (750)	290 (950)	310 (1050)	m/min	SFM
S2	WU10HT	◊										35	110
	WS10PT/WU10PT	◊										60	195
	WS25PT/WU25PT	◊										30	100
	WM15CT	◊										60	195
	WM25CT/WM35CT	◊										30	100

### Nickel-Based, Heat-Resistant Alloys (140–475 HB) (≤48 HRC)

material group	grade	speed – m/min (SFM)										Starting Conditions	
		15 (50)	45 (150)	75 (250)	105 (350)	140 (450)	170 (550)	200 (650)	230 (750)	290 (950)	310 (1050)	m/min	SFM
S3	WU10HT	◊										40	125
	WS10PT/WU10PT	◊										70	225
	WS25PT/WU25PT	◊										40	125
	WM15CT	◊										70	225
	WM25CT/WM35CT	◊										40	125

### Titanium and Titanium Alloys (110–450 HB) (≤48 HRC)

material group	grade	speed – m/min (SFM)										Starting Conditions	
		15 (50)	45 (150)	75 (250)	105 (350)	140 (450)	170 (550)	200 (650)	230 (750)	290 (950)	310 (1050)	m/min	SFM
S4	WU10HT	◊										45	150
	WM15CT	◊										70	225
	WM25CT/WM35CT	◊										55	175

Negative Inserts

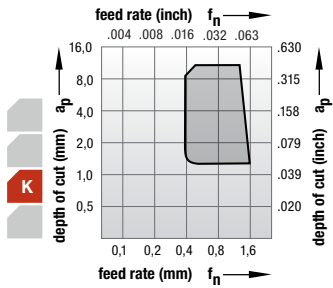

**..MA**

Flat-top geometry for machining cast iron. For finishing to roughing applications.

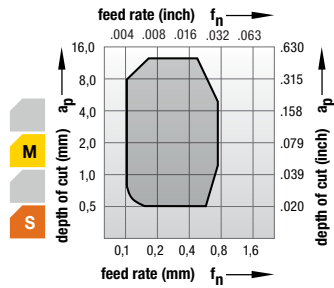

**.NMP**

For medium-duty machining of tough work materials, such as chrome- and nickel-based alloys. Minimizes tendency for materials to adhere to insert.

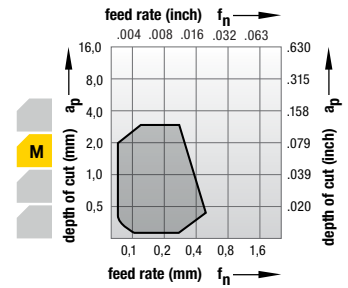

**CT**

Designed for outward copy turning. Where other geometries produce long chips, the unique distribution of the cut results in good chip control.

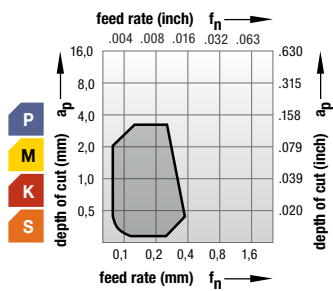

**FF**

For finish turning, producing smooth, accurate surfaces. Very good chip control, especially at low depths of cut.

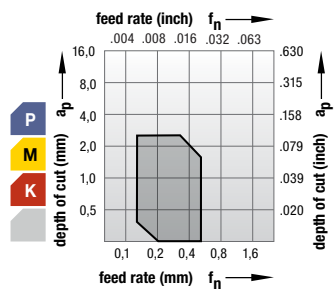

**FW**

Wiper geometry for finishing when good surface finish is needed using high feed rates. First choice for high-performance finishing.

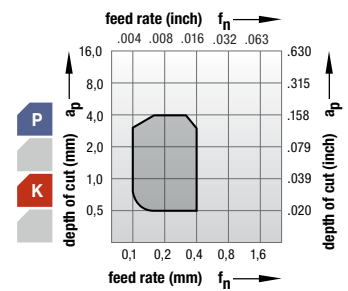

**ML**

For finishing to medium machining with a negative, stable cutting edge.

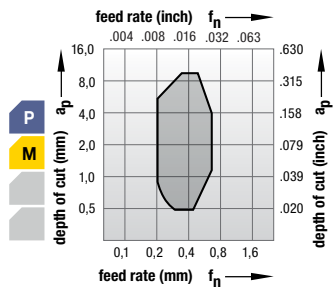

**MR**

For medium to light roughing of steels, difficult-to-machine high-alloy titanium, and aluminum materials. High strength to deal with heavy chip deformation.

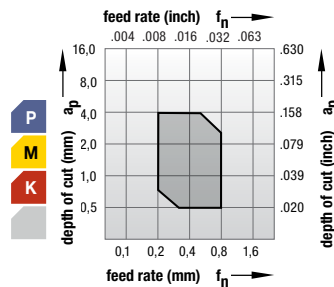

**MW**

Wiper geometry for light to medium turning with high feed rates. Feed twice as high as with edges with full corner radii to produce same surface finish.

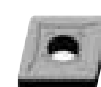
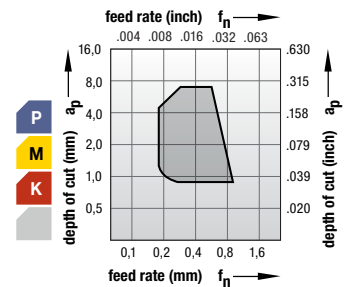

**RH**

For medium-duty to roughing. Outstanding chip control. High edge strength for interrupted cuts, forging skin, or scale. Preferred for all cast iron, such as gray, malleable, and nodular.

INDEXABLE MILLING

SOLID END MILLING

HOLEMAKING

TAPPING

TURNING

## Negative Inserts

INDEXABLE MILLING

SOLID END MILLING

HOLEMAKING

TAPPING

TURNING

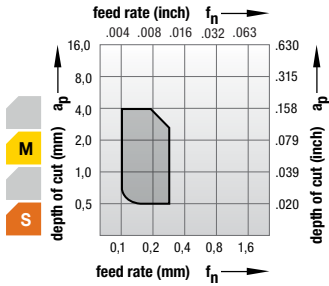

**UF**

For finishing with a positive cutting edge for reduced cutting forces and superior surface quality.

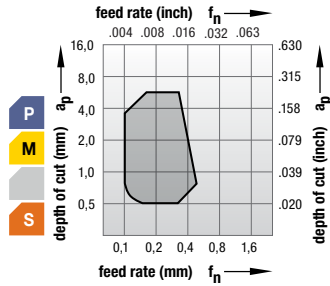

**UM**

For medium-duty turning operations. Soft-cutting chipbreaker. Used in applications producing varying chip sections, such as profile or copy turning. Good dimensional accuracy. For soft steel materials and stainless steels.

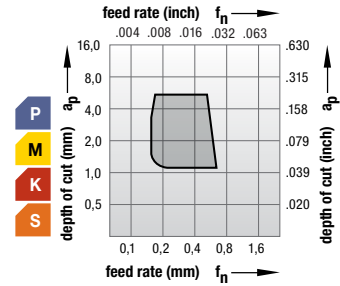

**UR**

Roughing geometry with smooth chip forming and improved coolant flow for increased tool life. Positive geometry reduces cutting forces and improves depth-of-cut notching resistance. Ideally suitable for stainless steel applications and for smooth machining of steel.

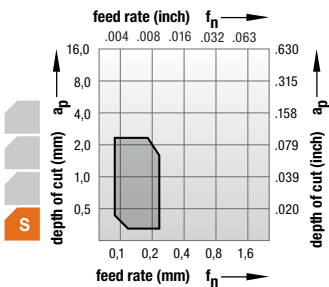

**FS**

For finishing applications. Ground periphery with positive cutting edge ideally suited for high-temp alloys. Micro-finished edge on the ground periphery adds just a slight hone for improved edge integrity and reliability.

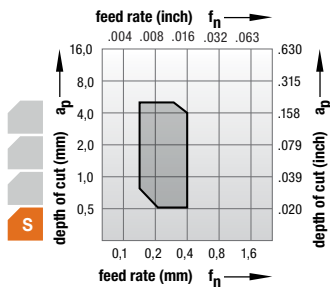

**MS**

For medium machining in high-temp materials. Utilizes a micro-finished edge preparation to increase edge toughness.

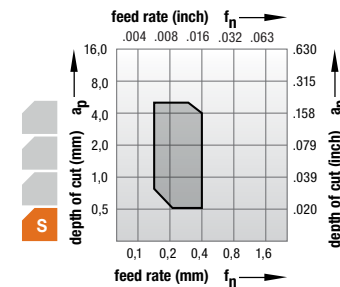

**.NGP**

For medium-duty machining of tough work materials, such as chrome- and nickel-based alloys. Minimizes tendency for materials to adhere to insert.

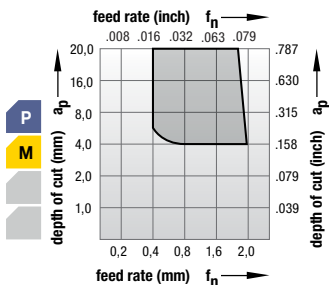

**SR**

A super-roughing geometry. The -SR has a strong cutting edge to support high cutting loads in roughing applications. Can produce high metal removal rates.

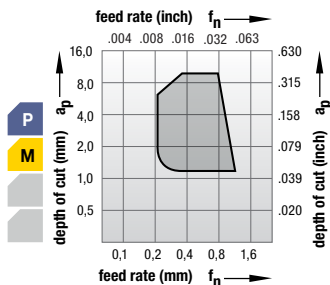

**65**

Rough-turning geometry with chip control extending to the medium-duty range. Positive rake angle lowers cutting forces, reducing power requirements. Used on low-tensile and stainless steels.

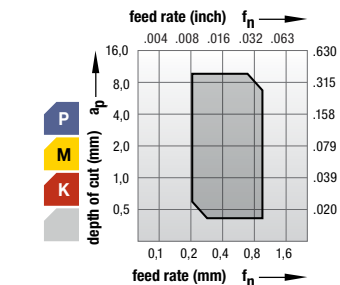

**-RU**

Positive geometry for smooth cutting. Positive T-land with rake angle to lower cutting forces and improve DOCN resistance. Post-coat grinding of seating surface for secure seating surface. Good edge strength for interrupted cuts, forging skin, and casting surfaces.

Positive Inserts

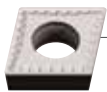
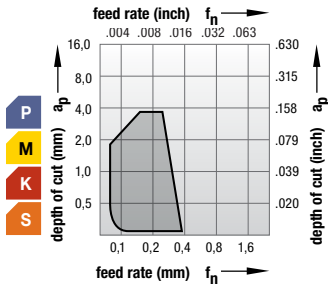

**MU**

A medium universal geometry with a soft cutting action due to its positive geometry. Has a versatile application range and is suited for turning unstable components and for boring applications.

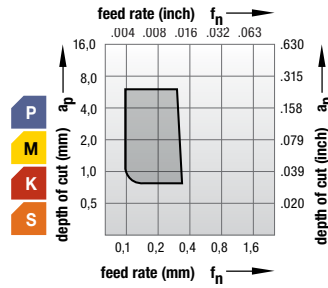

**MP**

For medium to rough turning with reduced cutting forces and improved chip control for high feed rates. Suitable for high metal removal rates and spindling applications.

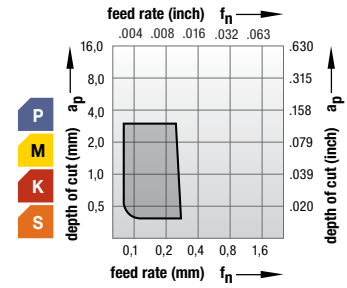

**FP**

For finishing to medium turning operations with optimal chip control over a wide range of cutting conditions and workpiece materials.

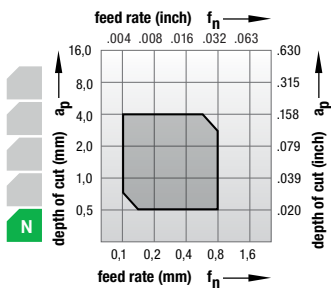

**-AL**

For cost-effective machining of aluminum, non-ferrous metals, and plastics. Extremely sharp cutting edges result in optimum part finishes with low cutting forces and short chips.

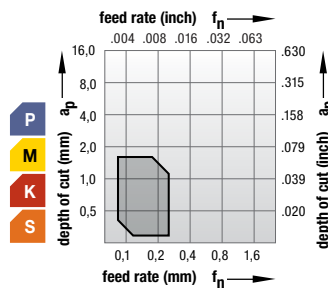

**1P**

Preferred for light finishing. Low cutting forces and reduced power requirements due to positive rake angle. Good chip control over a wide range.

INDEXABLE MILLING

SOLID END MILLING

HOLEMAKING

TAPPING

TURNING



## **P** Steel Turning



**Crankshaft/Camshaft**  
*Roughing and Finishing*



**Connecting Rods**  
*Boring*



**Gears**  
*Roughing and Finishing*



**Input/Output Shafts**

## **M** Stainless Steel Turning



**Turbo Charger**  
*Roughing and Finishing*



**Flanges**  
*Roughing and Finishing*



**Bearing Housing**  
*Roughing and Finishing*



**Valve Body**  
*Roughing and Finishing*

## **K** Cast Iron Turning



**Cylinder Liner**  
*Roughing and Finishing*



**Engine Block**



**Brake Drum and Disc**



**Hub**  
*Roughing and Finishing*

## Grades and Grade Descriptions

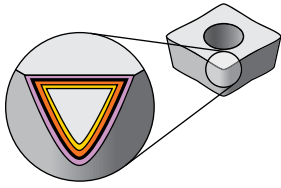

Coatings provide high-speed capability and are engineered for finishing to heavy roughing.

P	Steel
M	Stainless Steel
K	Cast Iron
N	Non-Ferrous
S	High-Temp Alloys
H	Hardened Materials

Grade	Coating	Grade Description	wear resistance ← toughness												
			05	10	15	20	25	30	35	40	45				
TTR		Uncoated carbide. Tough grade for medium to rough turning applications in steel. Suitable for interrupted cuts and unfavorable conditions.	P												
	HW-P35														
WP20TT		Uncoated cermet. Highly wear-resistant grade suitable for finish turning applications in steel in continuous cuts. Gives excellent surface finish.	P												
	HT-P05														
WP05CT		<p><b>Composition:</b> A deformation-resistant, cobalt-enriched substrate combined with thick MTCVD TiCN-Al<sub>2</sub>O<sub>3</sub> coating.</p> <p><b>Application:</b> For high productivity turning of steels and PH stainless steels in continuous to lightly interrupted cuts. This grade provides excellent combination of toughness and high-speed wear resistance allowing the fastest steel part production. Its unique combination of substrate and coating also makes it an ideal roughing grade for cast iron where chipping resistance is required.</p>	P												
	HC-P10		K												
WP15CT		Coated carbide. MT-CVD/CVD — TiN-TiCN-Al <sub>2</sub> O <sub>3</sub> -ZrCN. Good balance of wear resistance and toughness properties. High-productivity machining on smooth to lightly interrupted cuts. For steels.	P												
	HC-P15		K												
WP25CT		Coated carbide. MT-CVD/CVD — TiN-TiCN-Al <sub>2</sub> O <sub>3</sub> -ZrCN. Good toughness properties. Excellent first choice for steel machining, high-productivity metal removal for all but the harshest interrupted cuts.	P												
	HC-P25		K												
WP35CT		Coated carbide. MT-CVD/CVD — TiN-TiCN-Al <sub>2</sub> O <sub>3</sub> -TiOCN. Proven on all roughing and heavy roughing operations, wet or dry, on interrupted and uninterrupted cuts.	P												
	HC-P35		M												

INDEXABLE MILLING

SOLID END MILLING

HOLEMAKING

TAPPING

TURNING

## Grades and Grade Descriptions

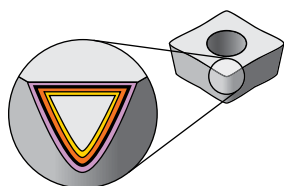

Coatings provide high-speed capability and are engineered for finishing to heavy roughing.

P	Steel
M	Stainless Steel
K	Cast Iron
N	Non-Ferrous
S	High-Temp Alloys
H	Hardened Materials

Grade	Coating	Grade Description	wear resistance ← → toughness																			
			05	10	15	20	25	30	35	40	45											
WM15CT	HC-M15	Coated carbide. MT-CVD/CVD – TiN-TiCN-Al <sub>2</sub> O <sub>3</sub> -TiOCN. High degree of wear resistance and good resistance to depth-of-cut notching for long tool life in finishing to medium turning applications.	P																			
			M																			
WM20CT	HC-K15	A multilayer CVD coated carbide grade with TiN-TiCN-Al <sub>2</sub> O <sub>3</sub> coating over a wear-resistant substrate. Suitable for general-purpose/medium machining applications in stainless steels at moderate speeds and feeds. The substrate offers very good toughness and the coating provides high wear resistance, ensuring performance even in interrupted cuts with long tool life.	P																			
			M																			
WM25CT	HC-M25	Coated carbide. MT-CVD/CVD – TiN-TiCN-Al <sub>2</sub> O <sub>3</sub> -TiOCN. Good balance of wear resistance and toughness properties. Light and medium machining. For austenitic stainless steel AISI series.	P																			
			M																			
WM35CT	HC-M35	Coated carbide. MT-CVD/CVD – TiN-TiCN-Al <sub>2</sub> O <sub>3</sub> -TiOCN. Good toughness and wear resistance balance. For medium to roughing operations with light and heavily interrupted cuts.	P																			
			M																			
THM	HW-K15	Uncoated carbide. Extraordinary balance of toughness, wear resistance, edge stability. Suitable for light to medium turning applications in continuous and light interrupted cuts in materials like cast iron and non-ferrous metals.	K																			
			N																			
WK05CT	HC-K05	Coated carbide. MT-CVD/CVD – TiN-TiCN-Al <sub>2</sub> O <sub>3</sub> . Increased wear resistance for long tool life at high cutting speeds. Enhanced edge strength against depth-of-cut notching in interrupted cuts. Maximum wear resistance for long tool life at high cutting speeds in finish to medium machining.	P																			
			K																			

## Grades and Grade Descriptions

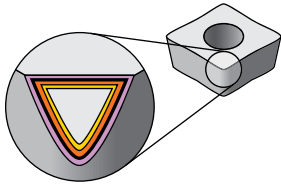

Coatings provide high-speed capability and are engineered for finishing to heavy roughing.

P	Steel
M	Stainless Steel
K	Cast Iron
N	Non-Ferrous
S	High-Temp Alloys
H	Hardened Materials

Grade	Coating	Grade Description	wear resistance ← → toughness																			
			05	10	15	20	25	30	35	40	45											
WK15CT		Composition: A multilayered coating with moderately thick MTCVD TiCN-Al <sub>2</sub> O <sub>3</sub> layers over a highly deformation-resistant carbide substrate. Application: Designed for high-speed machining of gray and ductile irons. The substrate and coating architecture together with post-coat treatment ensure a tremendous tool life advantage, especially when cutting higher tensile strength ductile and gray irons where workpiece size consistency and reliability of tool life are critical. Excellent both in continuous cuts and varied depths of cut.	P																			
	HC-M20		K																			
WK20CT		Coated carbide. MT-CVD/CVD – TiN-TiCN-Al <sub>2</sub> O <sub>3</sub> . First choice for a wide range of machining on all gray and ductile irons, light to heavy machining, smooth or interrupted cuts, and wet or dry.	P																			
	HC-K20		K																			
WS10PT		An advanced multilayer PVD coating over a very deformation-resistant unalloyed carbide substrate. The new and improved coating improves edge stability with wide range speed and feed capabilities. WS10PT™ is ideal for finishing to general machining of most workpiece materials at a wide range of speed and feed capabilities. Excellent for machining most steels, stainless steels, cast irons, non-ferrous materials, and super alloys with improved edge toughness and higher cutting speed and feed capabilities.	P																			
			M																			
			K																			
			N																			
			S																			
WS25PT		An advanced PVD grade with hard AlTiN coating and fine-grain unalloyed substrate. The new and improved coating improves edge stability with wide range speed and feed capabilities. WS25PT™ is ideal for general machining of most steels, stainless steels, high-temp alloys, titanium, irons, and non-ferrous materials at moderate speeds and over a wide range of feeds, with improved edge toughness for interrupted cut and high feed rates.	P																			
			M																			
			K																			
			N																			
			S																			
WU10HT		Uncoated carbide. Highly wear-resistant microfine substrate. Suitable for finish turning applications in aluminum and all types of non-ferrous materials, stainless steel, and high-temp alloys with suitable edge preparation. Mainly applied in continuous cuts.	M																			
			N																			
			S																			
WU05PT		Coated carbide. PVD AlTiN-coated grade with microfine substrate and highly wear-resistant coating. Suitable for finish turning in aluminum and other non-ferrous materials and also steels, stainless steel, and high-temp alloys with reliability in continuous cuts with suitable edge preparation.	P																			
			M																			
			K																			
			N																			

INDEXABLE MILLING

SOLID END MILLING

HOLE/MAKING

TAPPING

TURNING

## Grades and Grade Descriptions

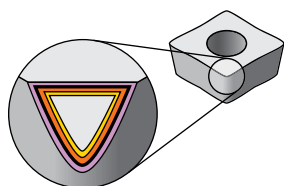

Coatings provide high-speed capability and are engineered for finishing to heavy roughing.

P	Steel
M	Stainless Steel
K	Cast Iron
N	Non-Ferrous
S	High-Temp Alloys
H	Hardened Materials

Grade	Coating	Grade Description	wear resistance ← → toughness																					
			05	10	15	20	25	30	35	40	45													
WU10PT	HC-P10	The WU10PT grade is ideal for finishing to general machining of most workpiece materials at higher speeds. Excellent for machining most steels, stainless steels, cast irons, and super alloys under stable conditions.	P																					
			M																					
			K																					
			N																					
			S																					
			H																					
WU25PT	HC-P25	An advanced PVD-Al TiN-coated grade with a tough, ultra-fine-grain, unalloyed substrate. For general-purpose machining of most steels, stainless steels, high-temperature alloys, titanium alloys, and cast irons.	P																					
			M																					
			K																					
			N																					
			S																					
			H																					



INDEXABLE MILLING

SOLID END MILLING

HOLEMAKING

TAPPING

TURNING

## CCMT • Medium Machining

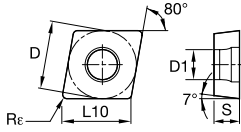
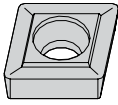

● first choice  
○ alternate choice

P	●	●	●	○	○	○	○	○	○	○	○	○	○	○	○	○	○	○	○	○
M	○	○	○	○	○	○	○	○	○	○	○	○	○	○	○	○	○	○	○	○
K	○	○	○	○	○	○	○	○	○	○	○	○	○	○	○	○	○	○	○	○
N	○	○	○	○	○	○	○	○	○	○	○	○	○	○	○	○	○	○	○	○
S	○	○	○	○	○	○	○	○	○	○	○	○	○	○	○	○	○	○	○	○
H	○	○	○	○	○	○	○	○	○	○	○	○	○	○	○	○	○	○	○	○

ISO catalog number	ANSI catalog number	D		L10		S		Re		D1																																
		mm	in	mm	in	mm	in	mm	in	mm	in	WP05CT	WP15CT	WP25CT	WP35CT	WM15CT	WM25CT	WM35CT	WK05CT	WK15CT	WK20CT	WS10PT	WS25PT	WU10HT	WU05PT	WP20TT	THM	TTR	WM20CT	WU10PT	WU25PT											
CCMT060202	CCMT21505	6,35	1/4	6,45	.254	2,38	3/32	0,2	.008	2,80	.110	●	●	●	○	○	○	○	○	○	○	○	○	○	○	○	○	○	○	○	○	○	○	○	○	○	○	○	○	○		
CCMT060204	CCMT2151	6,35	1/4	6,45	.254	2,38	3/32	0,4	1/64	2,80	.110	○	○	○	○	○	○	○	○	○	○	○	○	○	○	○	○	○	○	○	○	○	○	○	○	○	○	○	○			
CCMT090304	CCMT321	9,53	3/8	9,67	.381	3,18	1/8	0,4	1/64	4,40	.173	○	○	○	○	○	○	○	○	○	○	○	○	○	○	○	○	○	○	○	○	○	○	○	○	○	○	○	○	○		
CCMT090308	CCMT322	9,53	3/8	9,67	.381	3,18	1/8	0,8	1/32	4,40	.173	○	○	○	○	○	○	○	○	○	○	○	○	○	○	○	○	○	○	○	○	○	○	○	○	○	○	○	○	○	○	
CCMT09T304	CCMT3251	9,53	3/8	9,67	.381	3,97	5/32	0,4	1/64	4,40	.173	○	○	○	○	○	○	○	○	○	○	○	○	○	○	○	○	○	○	○	○	○	○	○	○	○	○	○	○	○	○	
CCMT09T308	CCMT09T308	9,53	3/8	9,67	.381	3,97	5/32	0,8	1/32	4,40	.173	○	○	○	○	○	○	○	○	○	○	○	○	○	○	○	○	○	○	○	○	○	○	○	○	○	○	○	○	○	○	
CCMT09T308	CCMT3252	9,53	3/8	9,67	.381	3,97	5/32	0,8	1/32	4,40	.173	○	○	○	○	○	○	○	○	○	○	○	○	○	○	○	○	○	○	○	○	○	○	○	○	○	○	○	○	○	○	
CCMT120408	CCMT432	12,70	1/2	12,90	.508	4,76	3/16	0,8	1/32	5,50	.217	○	○	○	○	○	○	○	○	○	○	○	○	○	○	○	○	○	○	○	○	○	○	○	○	○	○	○	○	○	○	○

CCMT-FP • Finishing Positive

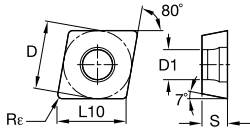

● first choice  
○ alternate choice

P	●	●	●	○	○	○	○	○	○	○	○	○	○	○	○	○	○	○	○	○	○
M	●	○	○	○	○	○	○	○	○	○	○	○	○	○	○	○	○	○	○	○	○
K	○	○	○	○	○	○	○	○	○	○	○	○	○	○	○	○	○	○	○	○	○
N	○	○	○	○	○	○	○	○	○	○	○	○	○	○	○	○	○	○	○	○	○
S	○	○	○	○	○	○	○	○	○	○	○	○	○	○	○	○	○	○	○	○	○
H	○	○	○	○	○	○	○	○	○	○	○	○	○	○	○	○	○	○	○	○	○

ISO catalog number	ANSI catalog number	D		L10		S		Re		D1																														
		mm	in	mm	in	mm	in	mm	in	mm	in	WP05CT	WP15CT	WP25CT	WP35CT	WM15CT	WM25CT	WM35CT	WK05CT	WK15CT	WK20CT	WS10PT	WS25PT	WU10HT	WU05PT	WP20TT	THM	TTR	WM20CT	WU10PT	WU25PT									
CCMT060202FP	CCMT21505FP	6,35	1/4	6,45	.254	2,38	3/32	0,2	.008	2,80	.110	○	○	○	○	○	○	○	○	○	○	○	○	○	○	○	○	○	○	○	○	○	○	○	○	○				
CCMT060204FP	CCMT2151FP	6,35	1/4	6,45	.254	2,38	3/32	0,4	1/64	2,80	.110	○	○	○	○	○	○	○	○	○	○	○	○	○	○	○	○	○	○	○	○	○	○	○	○	○				
CCMT060208FP	CCMT2152FP	6,35	1/4	6,45	.254	2,38	3/32	0,8	1/32	2,80	.110	○	○	○	○	○	○	○	○	○	○	○	○	○	○	○	○	○	○	○	○	○	○	○	○	○	○			
CCMT09T302FP	CCMT32505FP	9,53	3/8	9,67	.381	3,97	5/32	0,2	.008	4,40	.173	○	○	○	○	○	○	○	○	○	○	○	○	○	○	○	○	○	○	○	○	○	○	○	○	○	○			
CCMT09T304FP	CCMT3251FP	9,53	3/8	9,67	.381	3,97	5/32	0,4	1/64	4,40	.173	○	○	○	○	○	○	○	○	○	○	○	○	○	○	○	○	○	○	○	○	○	○	○	○	○	○	○		
CCMT09T308FP	CCMT3252FP	9,53	3/8	9,67	.381	3,97	5/32	0,8	1/32	4,40	.173	○	○	○	○	○	○	○	○	○	○	○	○	○	○	○	○	○	○	○	○	○	○	○	○	○	○	○	○	
CCMT120404FP	CCMT431FP	12,70	1/2	12,90	.508	4,76	3/16	0,4	1/64	5,50	.217	○	○	○	○	○	○	○	○	○	○	○	○	○	○	○	○	○	○	○	○	○	○	○	○	○	○	○	○	
CCMT120408FP	CCMT432FP	12,70	1/2	12,90	.508	4,76	3/16	0,8	1/32	5,50	.217	○	○	○	○	○	○	○	○	○	○	○	○	○	○	○	○	○	○	○	○	○	○	○	○	○	○	○	○	○

INDEXABLE MILLING

SOLID END MILLING

HOLE/MAKING

TAPPING

TURNING



CCMT-MP • Medium Positive

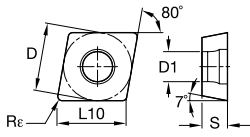

● first choice  
○ alternate choice

P	M	K	N	S	H	WP05CT	WP15CT	WP25CT	WP35CT	WM15CT	WM25CT	WM35CT	WK05CT	WK15CT	WK20CT	WS10PT	WS25PT	WU10HT	WU05PT	WP20TT	THM	TTR	WM20CT	WU10PT	WU25PT	
●	●	●	●	●	●	○	○	○	○	○	○	○	○	○	○	○	○	○	○	○	○	○	○	○	○	○
●	●	○	○	○	○	○	○	○	○	○	○	○	○	○	○	○	○	○	○	○	○	○	○	○	○	○
○	○	○	○	○	○	○	○	○	○	○	○	○	○	○	○	○	○	○	○	○	○	○	○	○	○	○
○	○	○	○	○	○	○	○	○	○	○	○	○	○	○	○	○	○	○	○	○	○	○	○	○	○	○
○	○	○	○	○	○	○	○	○	○	○	○	○	○	○	○	○	○	○	○	○	○	○	○	○	○	○

ISO catalog number	ANSI catalog number	D		L10		S		Re		D1		WP05CT	WP15CT	WP25CT	WP35CT	WM15CT	WM25CT	WM35CT	WK05CT	WK15CT	WK20CT	WS10PT	WS25PT	WU10HT	WU05PT	WP20TT	THM	TTR	WM20CT	WU10PT	WU25PT
		mm	in	mm	in	mm	in	mm	in	mm	in																				
CCMT060204MP	CCMT2151MP	6,35	1/4	6,45	.254	2,38	3/32	0,4	1/64	2,80	.110	1	4170197	4170217	1	1	1	1	1	1	1	1	1	1	1	1	1	1	1	1	1
CCMT09T304MP	CCMT3251MP	9,53	3/8	9,67	.381	3,97	5/32	0,4	1/64	4,40	.173	1	4170198	4170218	1	1	1	1	1	1	1	1	1	1	1	1	1	1	1	1	1
CCMT09T308MP	CCMT3252MP	9,53	3/8	9,67	.381	3,97	5/32	0,8	1/32	4,40	.173	1	4170199	4170219	1	1	1	1	1	1	1	1	1	1	1	1	1	1	1	1	1
CCMT09T312MP	CCMT3253MP	9,53	3/8	9,67	.381	3,97	5/32	1,2	3/64	4,40	.173	1	4170220	4170221	1	1	1	1	1	1	1	1	1	1	1	1	1	1	1	1	1
CCMT120408MP	CCMT432MP	12,70	1/2	12,90	.508	4,76	3/16	0,8	1/32	5,50	.217	1	4170200	4170221	1	1	1	1	1	1	1	1	1	1	1	1	1	1	1	1	1
CCMT120412MP	CCMT433MP	12,70	1/2	12,90	.508	4,76	3/16	1,2	3/64	5,50	.217	1	4170222	4170221	1	1	1	1	1	1	1	1	1	1	1	1	1	1	1	1	1

INDEXABLE MILLING

SOLID END MILLING

HOLE MAKING

TAPPING

TURNING

CCMT-MU • Medium Universal

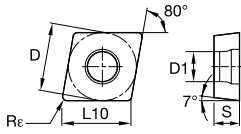

● first choice  
○ alternate choice

P	●	●	●	●	●	○	○	○	○	○	○	○	○	○	○	○	○	○	○	○	○	○
M	○	○	○	○	○	○	○	○	○	○	○	○	○	○	○	○	○	○	○	○	○	○
K	○	○	○	○	○	○	○	○	○	○	○	○	○	○	○	○	○	○	○	○	○	○
N	○	○	○	○	○	○	○	○	○	○	○	○	○	○	○	○	○	○	○	○	○	○
S	○	○	○	○	○	○	○	○	○	○	○	○	○	○	○	○	○	○	○	○	○	○
H	○	○	○	○	○	○	○	○	○	○	○	○	○	○	○	○	○	○	○	○	○	○

ISO catalog number	ANSI catalog number	D		L10		S		Re		D1																															
		mm	in	mm	in	mm	in	mm	in	mm	in	WP05CT	WP15CT	WP25CT	WP35CT	WM15CT	WM25CT	WM35CT	WK05CT	WK15CT	WK20CT	WS10PT	WS25PT	WU10HT	WU05PT	WP20TT	THM	TTR	WM20CT	WU10PT	WU25PT										
CCMT060208MU	CCMT2152MU	6,35	1/4	6,45	.254	2,38	3/32	0,8	1/32	2,80	.110																														
CCMT090304MU	CCMT321MU	9,53	3/8	9,67	.381	3,18	1/8	0,4	1/64	4,40	.173			5623420																											
CCMT090308MU	CCMT322MU	9,53	3/8	9,67	.381	3,18	1/8	0,8	.315	4,40	.173	5623425		5623424																											
CCMT09T3041P	CCMT32511P	9,53	3/8	9,67	.381	3,97	5/32	0,4	1/64	4,40	.173																												6869663		
CCMT09T304MU	CCMT3251MU	9,53	3/8	9,67	.381	3,97	5/32	0,4	1/64	4,40	.173		5623431	5623430			5623427		5623429		5623432	5623428	5623426															6942280	6868873		
CCMT09T3081P	CCMT32521P	9,53	3/8	9,67	.381	3,97	5/32	0,8	1/32	4,40	.173																										6869664				
CCMT09T308MU	CCMT3252MU	9,53	3/8	9,67	.381	3,97	5/32	0,8	1/32	4,40	.173		5623434	5623436	5623439																							6942341		6868874	
CCMT120404MU	CCMT431MU	12,70	1/2	12,90	.508	4,76	3/16	0,4	1/64	5,50	.217		6128256										6128258																		
CCMT120408MU	CCMT432MU	12,70	1/2	12,90	.508	4,76	3/16	0,8	1/32	5,50	.217		5623440	5623443			5623442						5623441		5623444																

INDEXABLE MILLING

SOLID END MILLING

HOLEMAKING

TAPPING

TURNING

INDEXABLE MILLING

## CCMT-1P • Finishing

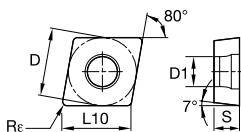
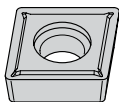

● first choice

○ alternate choice

P	●	●	●	●	○	○	○	○	○	○	○	○	○	○	○	○	○	○	○	○	○	○	○	○	○
M	●	●	○	○	○	○	○	○	○	○	○	○	○	○	○	○	○	○	○	○	○	○	○	○	○
K	○	○	○	○	○	○	○	○	○	○	○	○	○	○	○	○	○	○	○	○	○	○	○	○	○
N	○	○	○	○	○	○	○	○	○	○	○	○	○	○	○	○	○	○	○	○	○	○	○	○	○
S	○	○	○	○	○	○	○	○	○	○	○	○	○	○	○	○	○	○	○	○	○	○	○	○	○
H	○	○	○	○	○	○	○	○	○	○	○	○	○	○	○	○	○	○	○	○	○	○	○	○	○

ISO catalog number	ANSI catalog number	D		L10		S		Re		D1		WP05CT	WP15CT	WP25CT	WP35CT	WM15CT	WM25CT	WM35CT	WK05CT	WK15CT	WK20CT	WS10PT	WS25PT	WU10HT	WU05PT	WP20TT	THM	TTR	WM20CT	WU10PT	WU25PT			
		mm	in	mm	in	mm	in	mm	in	mm	in																							
CCMT0602041P	CCMT21511P	6,35	1/4	6,45	.254	2,38	3/32	0,4	1/64	2,80	.110																							
CCMT0602081P	CCMT21521P	6,35	1/4	6,45	.254	2,38	3/32	0,8	1/32	2,80	.110																							
CCMT09T3041P	CCMT32511P	9,53	3/8	9,67	.381	3,97	5/32	0,4	1/64	4,40	.173																							
CCMT09T3081P	CCMT32521P	9,53	3/8	9,67	.381	3,97	5/32	0,8	1/32	4,40	.173																							

SOLID END MILLING

HOLE/MAKEING

TAPPING

TURNING

CCMW • Medium Machining

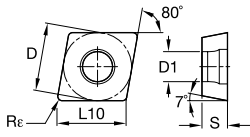
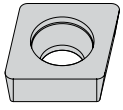

● first choice  
○ alternate choice

P		●	●	●	○	○	○	○	○	○	○	○	○	○	○	○	○	○	○	○	○	○	○	○
M																								
K		○	○	○																				
N																								
S																								
H																								

ISO catalog number	ANSI catalog number	D		L10		S		Re		D1																																
		mm	in	mm	in	mm	in	mm	in	mm	in	WP05CT	WP15CT	WP25CT	WP35CT	WM15CT	WM25CT	WM35CT	WK05CT	WK15CT	WK20CT	WS10PT	WS25PT	WU10HT	WU05PT	WP20TT	THM	TTR	WM20CT	WU10PT	WU25PT											
CCMW060202	CCMW21505	6,35	1/4	6,45	.254	2,38	3/32	0,2	.008	2,80	.110																															
CCMW060204	CCMW060204	6,35	1/4	6,45	.236	2,38	3/32	0,4	1/64	2,84	.112																															
CCMW060204	CCMW2151	6,35	1/4	6,45	.236	2,38	3/32	0,4	1/64	2,84	.112											4170368																				
CCMW090302	CCMW3205	9,53	3/8	9,67	.381	3,18	1/8	0,2	.00787	4,40	.173																															
CCMW090304	CCMW321	9,53	3/8	9,67	.381	3,18	1/8	0,4	1/64	4,45	.175												4170369																			
CCMW090308	CCMW090308	9,53	3/8	9,67	.381	3,18	1/8	0,8	1/32	4,45	.175																															
CCMW090308	CCMW322	9,53	3/8	9,67	.381	3,18	1/8	0,8	1/32	4,45	.175												4170466																			
CCMW09T304	CCMW3251	9,53	3/8	9,67	.381	3,97	5/32	0,4	1/64	4,45	.175											4170467																				
CCMW09T308	CCMW3252	9,53	3/8	9,67	.381	3,97	5/32	0,8	1/32	4,40	.173																															
CCMW120404	CCMW431	12,70	1/2	12,90	.508	4,76	3/16	0,4	1/64	5,50	.217																															
CCMW120408	CCMW120408	12,70	1/2	12,90	.508	4,76	3/16	0,8	1/32	5,50	.217																															
CCMW120408	CCMW432	12,70	1/2	12,90	.508	4,76	3/16	0,8	1/32	5,50	.217																															

INDEXABLE MILLING  
SOLID END MILLING  
HOLEMAKING  
TAPPING  
TURNING

INDEXABLE MILLING

SOLID END MILLING

HOLEMAKING

TAPPING

TURNING

## CNGG-FS • Finishing Sharp

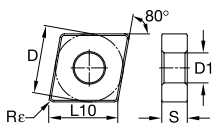
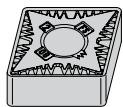

● first choice

○ alternate choice

P	M	K	N	S	H	WP05CT	WP15CT	WP25CT	WP35CT	WM15CT	WM25CT	WM35CT	WK05CT	WK15CT	WK20CT	WS10PT	WS25PT	WU10HT	WU05PT	WP20TT	THM	TTR	WM20CT	WU10PT	WU25PT	
●	●	●	●	●	●	○	○	○	○	○	○	○	○	○	○	○	○	○	○	○	○	○	○	○	○	○
●	●	○	○	○	○	○	○	○	○	○	○	○	○	○	○	○	○	○	○	○	○	○	○	○	○	○
○	○	○	○	○	○	○	○	○	○	○	○	○	○	○	○	○	○	○	○	○	○	○	○	○	○	○
○	○	○	○	○	○	○	○	○	○	○	○	○	○	○	○	○	○	○	○	○	○	○	○	○	○	○
○	○	○	○	○	○	○	○	○	○	○	○	○	○	○	○	○	○	○	○	○	○	○	○	○	○	○

ISO catalog number	ANSI catalog number	D		L10		S		Re		D1		WP05CT	WP15CT	WP25CT	WP35CT	WM15CT	WM25CT	WM35CT	WK05CT	WK15CT	WK20CT	WS10PT	WS25PT	WU10HT	WU05PT	WP20TT	THM	TTR	WM20CT	WU10PT	WU25PT		
		mm	in	mm	in	mm	in	mm	in	mm	in																						
CNGG120401FS	CNGG430FS	12,70	1/2	12,90	.508	4,76	3/16	0,1	.004	5,16	.203	●	●	●	●	○	○	○	○	○	○	○	○	○	○	○	○	○	○	○	○	○	
CNGG120402FS	CNGG4305FS	12,70	1/2	12,90	.508	4,76	3/16	0,2	.008	5,16	.203	●	●	●	●	○	○	○	○	○	○	○	○	○	○	○	○	○	○	○	○	○	
CNGG120404FS	CNGG431FS	12,70	1/2	12,90	.508	4,76	3/16	0,4	1/64	5,16	.203	●	●	●	●	○	○	○	○	○	○	○	○	○	○	○	○	○	○	○	○	○	○
CNGG120408FS	CNGG432FS	12,70	1/2	12,90	.508	4,76	3/16	0,8	1/32	5,16	.203	●	●	●	●	○	○	○	○	○	○	○	○	○	○	○	○	○	○	○	○	○	○
CNGG120412FS	CNGG433FS	12,70	1/2	12,90	.508	4,76	3/16	1,2	3/64	5,16	.203	●	●	●	●	○	○	○	○	○	○	○	○	○	○	○	○	○	○	○	○	○	○

CNGP • Medium Machining

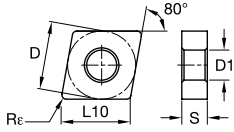
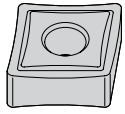

● first choice  
○ alternate choice

P	●	●	●	○	○	○	○	○	○	○	○	○	○	○	○	○	○	○	○	○
M	○	○	○	○	○	○	○	○	○	○	○	○	○	○	○	○	○	○	○	○
K	○	○	○	○	○	○	○	○	○	○	○	○	○	○	○	○	○	○	○	○
N	○	○	○	○	○	○	○	○	○	○	○	○	○	○	○	○	○	○	○	○
S	○	○	○	○	○	○	○	○	○	○	○	○	○	○	○	○	○	○	○	○
H	○	○	○	○	○	○	○	○	○	○	○	○	○	○	○	○	○	○	○	○

ISO catalog number	ANSI catalog number	D		L10		S		Re		D1																							
		mm	in	mm	in	mm	in	mm	in	mm	in	WP05CT	WP15CT	WP25CT	WP35CT	WM15CT	WM25CT	WM35CT	WK05CT	WK15CT	WK20CT	WS10PT	WS25PT	WU10HT	WU05PT	WP20TT	THM	TTR	WM20CT	WU10PT	WU25PT		
CNGP120401	CNGP430	12,70	1/2	12,90	.508	4,76	3/16	0,1	.004	5,16	.203											5549137											
CNGP120402	CNGP4305	12,70	1/2	12,90	.508	4,76	3/16	0,2	.008	5,16	.203											5549138	5549206										
CNGP120404	CNGP431	12,70	1/2	12,90	.508	4,76	3/16	0,4	1/64	5,16	.203										5549139	5549207											
CNGP120408	CNGP432	12,70	1/2	12,90	.508	4,76	3/16	0,8	1/32	5,16	.203										5549190	5549208											

INDEXABLE MILLING

SOLID END MILLING

HOLEMAKING

TAPPING

TURNING

## CNMA • Roughing

INDEXABLE MILLING

SOLID END MILLING

HOLEMAKING

TAPPING

TURNING

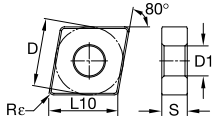
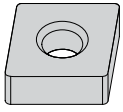

- first choice
- alternate choice

	P	M	K	N	S	H
WP05CT	●	●	○	○	○	○
WP15CT	○	○	○	○	○	○
WP25CT	○	○	○	○	○	○
WP35CT	○	○	○	○	○	○
WM15CT	○	○	○	○	○	○
WM25CT	○	○	○	○	○	○
WM35CT	○	○	○	○	○	○
WK05CT	○	○	○	○	○	○
WK15CT	○	○	○	○	○	○
WK20CT	○	○	○	○	○	○
WS10PT	○	○	○	○	○	○
WS25PT	○	○	○	○	○	○
WU10HT	○	○	○	○	○	○
WU05PT	○	○	○	○	○	○
WP20TT	○	○	○	○	○	○
TTHM	○	○	○	○	○	○
TTR	○	○	○	○	○	○
WM20CT	○	○	○	○	○	○
WU10PT	○	○	○	○	○	○
WU25PT	○	○	○	○	○	○

ISO catalog number	ANSI catalog number	D		L10		S		Re		D1		WP05CT	WP15CT	WP25CT	WP35CT	WM15CT	WM25CT	WM35CT	WK05CT	WK15CT	WK20CT	WS10PT	WS25PT	WU10HT	WU05PT	WP20TT	TTHM	TTR	WM20CT	WU10PT	WU25PT								
		mm	in	mm	in	mm	in	mm	in	mm	in	mm	in	mm	in	mm	in	mm	in	mm	in	mm	in	mm	in	mm	in	mm	in	mm	in	mm	in						
CNMA120404	CNMA431	12,70	1/2	12,90	.508	4,76	3/16	0,4	1/64	5,16	.203	○	○	○	○	○	○	○	○	○	○	○	○	○	○	○	○	○	○	○	○	○	○	○					
CNMA120408	CNMA432	12,70	1/2	12,90	.508	4,76	3/16	0,8	1/32	5,16	.203	○	○	○	○	○	○	○	○	○	○	○	○	○	○	○	○	○	○	○	○	○	○	○	○				
CNMA120412	CNMA433	12,70	1/2	12,90	.508	4,76	3/16	1,2	3/64	5,16	.203	○	○	○	○	○	○	○	○	○	○	○	○	○	○	○	○	○	○	○	○	○	○	○	○	○			
CNMA120416	CNMA434	12,70	1/2	12,90	.508	4,76	3/16	1,6	1/16	5,16	.203	○	○	○	○	○	○	○	○	○	○	○	○	○	○	○	○	○	○	○	○	○	○	○	○	○			
CNMA160612	CNMA543	15,88	5/8	16,12	.635	6,35	1/4	1,2	3/64	6,35	.250	○	○	○	○	○	○	○	○	○	○	○	○	○	○	○	○	○	○	○	○	○	○	○	○	○			
CNMA160616	CNMA544	15,88	5/8	16,12	.635	6,35	1/4	1,6	1/16	6,35	.250	○	○	○	○	○	○	○	○	○	○	○	○	○	○	○	○	○	○	○	○	○	○	○	○	○			
CNMA190608	CNMA642	19,05	3/4	19,34	.762	6,35	1/4	0,8	1/32	7,93	.313	○	○	○	○	○	○	○	○	○	○	○	○	○	○	○	○	○	○	○	○	○	○	○	○	○	○		
CNMA190612	CNMA643	19,05	3/4	19,34	.762	6,35	1/4	1,2	3/64	7,93	.313	○	○	○	○	○	○	○	○	○	○	○	○	○	○	○	○	○	○	○	○	○	○	○	○	○	○	○	
CNMA190616	CNMA644	19,05	3/4	19,34	.762	6,35	1/4	1,6	1/16	7,93	.313	○	○	○	○	○	○	○	○	○	○	○	○	○	○	○	○	○	○	○	○	○	○	○	○	○	○	○	○

## CNMG • Roughing

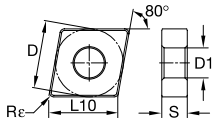
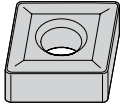

● first choice  
○ alternate choice

	P	M	K	N	S	H																	
P	●	●	●	●	○	○	○	○	○	○	○	○	○	○	○	○	○	○	○	○	○	○	○
M	●	●	○	○	○	○	○	○	○	○	○	○	○	○	○	○	○	○	○	○	○	○	○
K	○	○	○	○	○	○	○	○	○	○	○	○	○	○	○	○	○	○	○	○	○	○	○
N	○	○	○	○	○	○	○	○	○	○	○	○	○	○	○	○	○	○	○	○	○	○	○
S	○	○	○	○	○	○	○	○	○	○	○	○	○	○	○	○	○	○	○	○	○	○	○
H	○	○	○	○	○	○	○	○	○	○	○	○	○	○	○	○	○	○	○	○	○	○	○

ISO catalog number	ANSI catalog number	D		L10		S		Re		D1		WP05CT	WP15CT	WP25CT	WP35CT	WM15CT	WM25CT	WM35CT	WK05CT	WK15CT	WK20CT	WS10PT	WS25PT	WU10HT	WU05PT	WP20TT	THM	TTR	WM20CT	WU10PT	WU25PT
		mm	in	mm	in	mm	in	mm	in	mm	in																				
CNMG120404	CNMG431	12,70	1/2	12,90	.508	4,76	3/16	0,4	1/64	5,16	.203																				
CNMG120408	CNMG432	12,70	1/2	12,90	.508	4,76	3/16	0,8	1/32	5,16	.203																				
CNMG190612	CNMG643	19,05	3/4	19,34	.762	6,35	1/4	1,2	3/64	7,93	.313																				

## CNMG-5 • Roughing

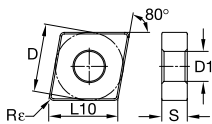
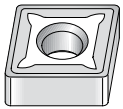

● first choice  
○ alternate choice

	P	M	K	N	S	H																											
P	●	●	●	○	○	○	○	○	○	○	○	○	○	○	○	○	○	○	○	○	○	○	○	○	○	○	○	○	○	○	○	○	○
M	●	●	○	○	○	○	○	○	○	○	○	○	○	○	○	○	○	○	○	○	○	○	○	○	○	○	○	○	○	○	○	○	○
K	○	○	○	○	○	○	○	○	○	○	○	○	○	○	○	○	○	○	○	○	○	○	○	○	○	○	○	○	○	○	○	○	○
N	○	○	○	○	○	○	○	○	○	○	○	○	○	○	○	○	○	○	○	○	○	○	○	○	○	○	○	○	○	○	○	○	○
S	○	○	○	○	○	○	○	○	○	○	○	○	○	○	○	○	○	○	○	○	○	○	○	○	○	○	○	○	○	○	○	○	○
H	○	○	○	○	○	○	○	○	○	○	○	○	○	○	○	○	○	○	○	○	○	○	○	○	○	○	○	○	○	○	○	○	○

ISO catalog number	ANSI catalog number	D		L10		S		Re		D1		WP05CT	WP15CT	WP25CT	WP35CT	WM15CT	WM25CT	WM35CT	WK05CT	WK15CT	WK20CT	WS10PT	WS25PT	WU10HT	WU05PT	WP20TT	THM	TTR	WM20CT	WU10PT	WU25PT	
		mm	in	mm	in	mm	in	mm	in	mm	in																					
CNMG120408-5	CNMG4325	12,70	1/2	12,90	.508	4,76	3/16	0,8	1/32	5,16	.203																					
CNMG120412-5	CNMG4335	12,70	1/2	12,90	.508	4,76	3/16	1,2	3/64	5,16	.203																					



INDEXABLE MILLING

## CNMG-FF • Fine Finishing

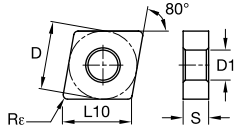
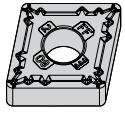

● first choice  
○ alternate choice

ISO catalog number	ANSI catalog number	D		L10		S		Rε		D1		WP05CT	WP15CT	WP25CT	WP35CT	WM15CT	WM25CT	WM35CT	WK05CT	WK15CT	WK20CT	WS10PT	WS25PT	WU10HT	WU05PT	WP20TT	THM	TTR	WM20CT	WU10PT	WU25PT
		mm	in	mm	in	mm	in	mm	in	mm	in																				
CNMG120404FF	CNMG431FF	12,70	1/2	12,90	.508	4,76	3/16	0,4	1/64	5,16	.203	●	●	●	●	○	○	○	○	○	○	○	○	○	○	○	○	○	○	○	○
CNMG120408FF	CNMG432FF	12,70	1/2	12,90	.508	4,76	3/16	0,8	1/32	5,16	.203	○	○	○	○	○	○	○	○	○	○	○	○	○	○	○	○	○	○	○	
CNMG120412FF	CNMG433FF	12,70	1/2	12,90	.508	4,76	3/16	1,2	3/64	5,16	.203	○	○	○	○	○	○	○	○	○	○	○	○	○	○	○	○	○	○	○	

SOLID END MILLING

HOLEMAKING

TAPPING

## CNMG-FW • Finishing Wiper

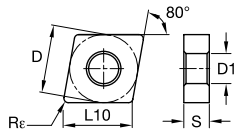
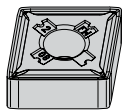

● first choice  
○ alternate choice

ISO catalog number	ANSI catalog number	D		L10		S		Rε		D1		WP05CT	WP15CT	WP25CT	WP35CT	WM15CT	WM25CT	WM35CT	WK05CT	WK15CT	WK20CT	WS10PT	WS25PT	WU10HT	WU05PT	WP20TT	THM	TTR	WM20CT	WU10PT	WU25PT
		mm	in	mm	in	mm	in	mm	in	mm	in																				
CNMG120408FW	CNMG432FW	12,70	1/2	12,90	.508	4,76	3/16	0,8	1/32	5,16	.203	○	○	○	○	○	○	○	○	○	○	○	○	○	○	○	○	○	○	○	○

TURNING

**CNMG-ML • Medium Machining**

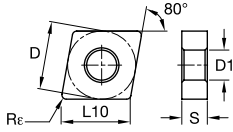

● first choice  
○ alternate choice

P	M	K	N	S	H	WP05CT	WP15CT	WP25CT	WP35CT	WM15CT	WM25CT	WM35CT	WK05CT	WK15CT	WK20CT	WS10PT	WS25PT	WU10HT	WU05PT	WP20TT	THM	TTR	WM20CT	WU10PT	WU25PT	
●	●	●	●	●	●	○	○	○	○	○	○	○	○	○	○	○	○	○	○	○	○	○	○	○	○	○
○	○	○	○	○	○	○	○	○	○	○	○	○	○	○	○	○	○	○	○	○	○	○	○	○	○	○
○	○	○	○	○	○	○	○	○	○	○	○	○	○	○	○	○	○	○	○	○	○	○	○	○	○	○
○	○	○	○	○	○	○	○	○	○	○	○	○	○	○	○	○	○	○	○	○	○	○	○	○	○	○
○	○	○	○	○	○	○	○	○	○	○	○	○	○	○	○	○	○	○	○	○	○	○	○	○	○	○

ISO catalog number	ANSI catalog number	D		L10		S		Re		D1		WP05CT	WP15CT	WP25CT	WP35CT	WM15CT	WM25CT	WM35CT	WK05CT	WK15CT	WK20CT	WS10PT	WS25PT	WU10HT	WU05PT	WP20TT	THM	TTR	WM20CT	WU10PT	WU25PT		
		mm	in	mm	in	mm	in	mm	in	mm	in																						
CNMG120404ML	CNMG431ML	12,70	1/2	12,90	.508	4,76	3/16	0,4	1/64	5,16	.203	4171059	4171059	4170458							4171390												
CNMG120408ML	CNMG432ML	12,70	1/2	12,90	.508	4,76	3/16	0,8	1/32	5,16	.203	4171060	4170459						4171658		4171391												
CNMG120412ML	CNMG433ML	12,70	1/2	12,90	.508	4,76	3/16	1,2	3/64	5,16	.203	4170460									4171392												

INDEXABLE MILLING

SOLID END MILLING

HOLE MAKING

TAPPING

TURNING

INDEXABLE MILLING

SOLID END MILLING

HOLEMAKING

TAPPING

TURNING

## CNMG-MR • Medium Roughing

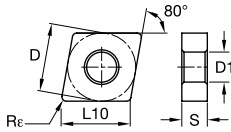

● first choice  
○ alternate choice

P	M	K	N	S	H	WP05CT	WP15CT	WP25CT	WP35CT	WM15CT	WM25CT	WM35CT	WK05CT	WK15CT	WK20CT	WS10PT	WS25PT	WU10HT	WU05PT	WP20TT	THM	TTR	WM20CT	WU10PT	WU25PT
●	●	●	●	●	●	○	○	○	○	○	○	○	○	○	○	○	○	○	○	○	○	○	○	○	○
○	○	○	○	○	○	○	○	○	○	○	○	○	○	○	○	○	○	○	○	○	○	○	○	○	○
○	○	○	○	○	○	○	○	○	○	○	○	○	○	○	○	○	○	○	○	○	○	○	○	○	○
○	○	○	○	○	○	○	○	○	○	○	○	○	○	○	○	○	○	○	○	○	○	○	○	○	○
○	○	○	○	○	○	○	○	○	○	○	○	○	○	○	○	○	○	○	○	○	○	○	○	○	○

ISO catalog number	ANSI catalog number	D		L10		S		Re		D1		WP05CT	WP15CT	WP25CT	WP35CT	WM15CT	WM25CT	WM35CT	WK05CT	WK15CT	WK20CT	WS10PT	WS25PT	WU10HT	WU05PT	WP20TT	THM	TTR	WM20CT	WU10PT	WU25PT
		mm	in	mm	in	mm	in	mm	in	mm	in																				
CNMG120404MR	CNMG431MR	12,70	1/2	12,90	.508	4,76	3/16	0,4	1/64	5,16	.203			4171130	4170546																
CNMG120408MR	CNMG432MR	12,70	1/2	12,90	.508	4,76	3/16	0,8	1/32	5,16	.203		4171131	4170547	4170044		4172955														
CNMG120412MR	CNMG433MR	12,70	1/2	12,90	.508	4,76	3/16	1,2	3/64	5,16	.203		4171132	4170548	4170045																
CNMG120416MR	CNMG434MR	12,70	1/2	12,90	.508	4,76	3/16	1,6	1/16	5,16	.203		5684353																		
CNMG160608MR	CNMG542MR	15,88	5/8	16,12	.635	6,35	1/4	0,8	1/32	6,35	.250		4171134	4170549																	
CNMG160612MR	CNMG543MR	15,88	5/8	16,12	.635	6,35	1/4	1,2	3/64	6,35	.250		4171135	4170550	4170046																
CNMG160616MR	CNMG544MR	15,88	5/8	16,12	.635	6,35	1/4	1,6	1/16	6,35	.250		4171136	4170551																	
CNMG190612MR	CNMG643MR	19,05	3/4	19,34	.762	6,35	1/4	1,2	3/64	7,93	.313		4171137	4170552			4172961	4173136													
CNMG190616MR	CNMG644MR	19,05	3/4	19,34	.762	6,35	1/4	1,6	1/16	7,93	.313		4171138	4170563			4172962														

CNMG-MS • Medium Sharp

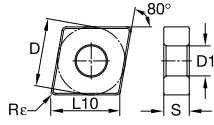

● first choice

○ alternate choice

P	●	●	●	○	○	○	○	○	○	○	○	○	○	○	○	○	○	○	○	○	○	○	○	○	○	○	○	○	○	○	○	○	○	○	○	○	○	○	○	
M	●	●	○	○	○	○	○	○	○	○	○	○	○	○	○	○	○	○	○	○	○	○	○	○	○	○	○	○	○	○	○	○	○	○	○	○	○	○	○	
K	○	○	○	○	○	○	○	○	○	○	○	○	○	○	○	○	○	○	○	○	○	○	○	○	○	○	○	○	○	○	○	○	○	○	○	○	○	○	○	○
N	○	○	○	○	○	○	○	○	○	○	○	○	○	○	○	○	○	○	○	○	○	○	○	○	○	○	○	○	○	○	○	○	○	○	○	○	○	○	○	○
S	○	○	○	○	○	○	○	○	○	○	○	○	○	○	○	○	○	○	○	○	○	○	○	○	○	○	○	○	○	○	○	○	○	○	○	○	○	○	○	○
H	○	○	○	○	○	○	○	○	○	○	○	○	○	○	○	○	○	○	○	○	○	○	○	○	○	○	○	○	○	○	○	○	○	○	○	○	○	○	○	○

ISO catalog number	ANSI catalog number	D		L10		S		Re		D1		WP05CT	WP15CT	WP25CT	WP35CT	WM15CT	WM25CT	WM35CT	WK05CT	WK15CT	WK20CT	WS10PT	WS25PT	WU10HT	WU05PT	WP20TT	THM	TTR	WM20CT	WU10PT	WU25PT						
		mm	in	mm	in	mm	in	mm	in	mm	in																										
CNMG120404MS	CNMG431MS	12,70	1/2	12,90	.508	4,76	3/16	0,4	1/64	5,16	.203																										
CNMG120408MS	CNMG432MS	12,70	1/2	12,90	.508	4,76	3/16	0,8	1/32	5,16	.203																										
CNMG120412MS	CNMG433MS	12,70	1/2	12,90	.508	4,76	3/16	1,2	3/64	5,16	.203																										
CNMG120416MS	CNMG434MS	12,70	1/2	12,90	.508	4,76	3/16	1,6	1/16	5,16	.203																										
CNMG160608MS	CNMG542MS	15,88	5/8	16,12	.635	6,35	1/4	0,8	1/32	6,35	.250																										
CNMG160612MS	CNMG543MS	15,88	5/8	16,12	.635	6,35	1/4	1,2	3/64	6,35	.250																										
CNMG190608MS	CNMG642MS	19,05	3/4	19,34	.762	6,35	1/4	0,8	1/32	7,93	.313																										
CNMG190612MS	CNMG643MS	19,05	3/4	19,34	.762	6,35	1/4	1,2	3/64	7,93	.313																										
CNMG190616MS	CNMG644MS	19,05	3/4	19,34	.762	6,35	1/4	1,6	1/16	7,92	.312																										

INDEXABLE MILLING

SOLID END MILLING

HOLE/REAMING

TAPPING

TURNING







CNMG-UM • Medium Machining

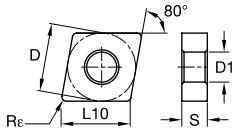
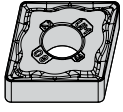

● first choice  
○ alternate choice

P	●	●	●	●	○	○	○	○	○	○	○	○	○	○	○	○	○	○	○	○	○	○	○	○
M	●	●	○	○	○	○	○	○	○	○	○	○	○	○	○	○	○	○	○	○	○	○	○	○
K	○	○	○	○	○	○	○	○	○	○	○	○	○	○	○	○	○	○	○	○	○	○	○	○
N	○	○	○	○	○	○	○	○	○	○	○	○	○	○	○	○	○	○	○	○	○	○	○	○
S	○	○	○	○	○	○	○	○	○	○	○	○	○	○	○	○	○	○	○	○	○	○	○	○
H	○	○	○	○	○	○	○	○	○	○	○	○	○	○	○	○	○	○	○	○	○	○	○	○

ISO catalog number	ANSI catalog number	D		L10		S		Re		D1		WP05CT	WP15CT	WP25CT	WP35CT	WM15CT	WM25CT	WM35CT	WK05CT	WK15CT	WK20CT	WS10PT	WS25PT	WU10HT	WU05PT	WP20TT	THM	TTR	WM20CT	WU10PT	WU25PT	
		mm	in	mm	in	mm	in	mm	in	mm	in																					
CNMG120404UM	CNMG431UM	12,70	1/2	12,90	.508	4,76	3/16	0,4	1/64	5,16	.203	●	●	●	○	○	○	○	○	○	○	○	○	○	○	○	○	○	○	○	○	○
CNMG120408UM	CNMG432UM	12,70	1/2	12,90	.508	4,76	3/16	0,8	1/32	5,16	.203	○	○	○	○	○	○	○	○	○	○	○	○	○	○	○	○	○	○	○	○	○
CNMG120412UM	CNMG433UM	12,70	1/2	12,90	.508	4,76	3/16	1,2	3/64	5,16	.203	○	○	○	○	○	○	○	○	○	○	○	○	○	○	○	○	○	○	○	○	○

INDEXABLE MILLING

SOLID END MILLING

HOLEMAKING

TAPPING

TURNING





### CNMM-8 • Heavy Roughing

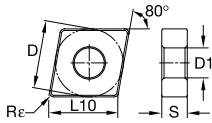
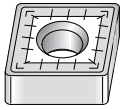

● first choice  
○ alternate choice

ISO catalog number	ANSI catalog number	D		L10		S		Rε		D1																									
		mm	in	mm	in	mm	in	mm	in	mm	in	WP05CT	WP15CT	WP25CT	WP35CT	WM15CT	WM25CT	WM35CT	WK05CT	WK15CT	WK20CT	WS10PT	WS25PT	WU10HT	WU05PT	WP20TT	THM	TTR	WM20CT	WU10PT	WU25PT				
CNMM1906168	CNMM6448	19,05	3/4	19,34	.762	6,35	1/4	1,6	1/16	7,93	.313	●	●	●	●	○	○	○	○	○	○	○	○	○	○	○	○	○	○	○	○	○	○	○	○

### CNMM-65 • Heavy Roughing

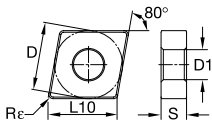
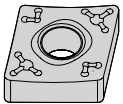

● first choice  
○ alternate choice

ISO catalog number	ANSI catalog number	D		L10		S		Rε		D1																									
		mm	in	mm	in	mm	in	mm	in	mm	in	WP05CT	WP15CT	WP25CT	WP35CT	WM15CT	WM25CT	WM35CT	WK05CT	WK15CT	WK20CT	WS10PT	WS25PT	WU10HT	WU05PT	WP20TT	THM	TTR	WM20CT	WU10PT	WU25PT				
CNMM12040865	CNMM43265	12,70	1/2	12,90	.508	4,76	3/16	0,8	1/32	5,16	.203	●	●	●	●	○	○	○	○	○	○	○	○	○	○	○	○	○	○	○	○	○	○	○	
CNMM12041265	CNMM43365	12,70	1/2	12,90	.508	4,76	3/16	1,2	3/64	5,16	.203	●	●	●	●	○	○	○	○	○	○	○	○	○	○	○	○	○	○	○	○	○	○	○	
CNMM16060865	CNMM54265	15,88	5/8	16,12	.635	6,35	1/4	0,8	1/32	6,35	.250	●	●	●	●	○	○	○	○	○	○	○	○	○	○	○	○	○	○	○	○	○	○	○	
CNMM16061265	CNMM54365	15,88	5/8	16,12	.635	6,35	1/4	1,2	3/64	6,35	.250	●	●	●	●	○	○	○	○	○	○	○	○	○	○	○	○	○	○	○	○	○	○	○	○
CNMM16061665	CNMM54465	15,88	5/8	16,12	.635	6,35	1/4	1,6	1/16	6,35	.250	●	●	●	●	○	○	○	○	○	○	○	○	○	○	○	○	○	○	○	○	○	○	○	○
CNMM19061265	CNMM64365	19,05	3/4	19,34	.762	6,35	1/4	1,2	3/64	7,93	.313	●	●	●	●	○	○	○	○	○	○	○	○	○	○	○	○	○	○	○	○	○	○	○	○
CNMM19061665	CNMM64465	19,05	3/4	19,34	.762	6,35	1/4	1,6	1/16	7,93	.313	●	●	●	●	○	○	○	○	○	○	○	○	○	○	○	○	○	○	○	○	○	○	○	○
CNMM19062465	CNMM64665	19,05	3/4	19,34	.762	6,35	1/4	2,4	3/32	7,93	.313	●	●	●	●	○	○	○	○	○	○	○	○	○	○	○	○	○	○	○	○	○	○	○	○





## DCMT • Medium Machining

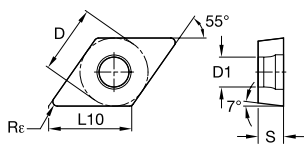
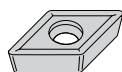

● first choice

○ alternate choice

P	●	●	●	●	○	○	○	○	○	○	○	○	○	○	○	○	○	○	○	○
M	●	●	○	○	○	○	○	○	○	○	○	○	○	○	○	○	○	○	○	○
K	○	○	○	○	○	○	○	○	○	○	○	○	○	○	○	○	○	○	○	○
N	○	○	○	○	○	○	○	○	○	○	○	○	○	○	○	○	○	○	○	○
S	○	○	○	○	○	○	○	○	○	○	○	○	○	○	○	○	○	○	○	○
H	○	○	○	○	○	○	○	○	○	○	○	○	○	○	○	○	○	○	○	○

ISO catalog number	ANSI catalog number	D		L10		S		Rε		D1		WP05CT	WP15CT	WP25CT	WP35CT	WM15CT	WM25CT	WM35CT	WK05CT	WK15CT	WK20CT	WS10PT	WS25PT	WU10HT	WU05PT	WP20TT	THM	TTR	WM20CT	WU10PT	WU25PT	
		mm	in	mm	in	mm	in	mm	in	mm	in	mm	in	mm	in	mm	in	mm	in	mm	in	mm	in	mm	in	mm	in	mm	in	mm	in	
DCMT070204	DCMT2151	6,35	1/4	7,75	.305	2,38	3/32	0,4	1/64	2,80	.110	●	●	●	○	○	○	○	○	○	○	○	○	○	○	○	○	○	○	○	○	○
DCMT11T304	DCMT11T304	9,53	3/8	11,63	.458	3,97	5/32	0,4	1/64	4,40	.173	●	●	●	○	○	○	○	○	○	○	○	○	○	○	○	○	○	○	○	○	○
DCMT11T304	DCMT3251	9,53	3/8	11,63	.458	3,97	5/32	0,4	1/64	4,40	.173	●	●	●	○	○	○	○	○	○	○	○	○	○	○	○	○	○	○	○	○	○
DCMT11T308	DCMT11T308	9,53	3/8	11,63	.458	3,97	5/32	0,8	1/32	4,45	.175	●	●	●	○	○	○	○	○	○	○	○	○	○	○	○	○	○	○	○	○	○
DCMT11T308	DCMT3252	9,53	3/8	11,63	.458	3,97	5/32	0,8	1/32	4,45	.175	●	●	●	○	○	○	○	○	○	○	○	○	○	○	○	○	○	○	○	○	○
DCMT11T312	DCMT3253	9,53	3/8	11,63	.458	3,97	5/32	1,2	3/64	4,45	.175	●	●	●	○	○	○	○	○	○	○	○	○	○	○	○	○	○	○	○	○	○
DCMT150408	DCMT432	12,70	1/2	15,50	.610	4,76	3/16	0,8	1/32	5,55	.218	●	●	●	○	○	○	○	○	○	○	○	○	○	○	○	○	○	○	○	○	○
DCMT150412	DCMT433	12,70	1/2	15,50	.610	4,76	3/16	1,2	3/64	5,55	.218	●	●	●	○	○	○	○	○	○	○	○	○	○	○	○	○	○	○	○	○	○

INDEXABLE MILLING

SOLID END MILLING

HOLEMAKING

TAPPING

TURNING



## DCMT-MP • Medium Positive

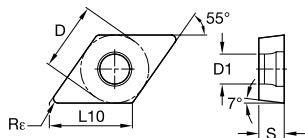
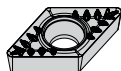

● first choice  
○ alternate choice

P	M	K	N	S	H	WP05CT	WP15CT	WP25CT	WP35CT	WM15CT	WM25CT	WM35CT	WK05CT	WK15CT	WK20CT	WS10PT	WS25PT	WU10HT	WU05PT	WP20TT	THM	TTR	WM20CT	WU10PT	WU25PT
●	●	●	●	○	○	●	○	○	○	○	○	○	○	○	○	○	○	○	○	○	○	○	○	○	○
○	○	○	○	○	○	○	○	○	○	○	○	○	○	○	○	○	○	○	○	○	○	○	○	○	
○	○	○	○	○	○	○	○	○	○	○	○	○	○	○	○	○	○	○	○	○	○	○	○	○	
○	○	○	○	○	○	○	○	○	○	○	○	○	○	○	○	○	○	○	○	○	○	○	○	○	
○	○	○	○	○	○	○	○	○	○	○	○	○	○	○	○	○	○	○	○	○	○	○	○	○	

ISO catalog number	ANSI catalog number	D		L10		S		R <sub>c</sub>		D1		WP05CT	WP15CT	WP25CT	WP35CT	WM15CT	WM25CT	WM35CT	WK05CT	WK15CT	WK20CT	WS10PT	WS25PT	WU10HT	WU05PT	WP20TT	THM	TTR	WM20CT	WU10PT	WU25PT
		mm	in	mm	in	mm	in	mm	in	mm	in	mm	in	mm	in	mm	in	mm	in	mm	in	mm	in	mm	in	mm	in	mm	in	mm	in
DCMT11T304MP	DCMT3251MP	9,53	3/8	11,63	.458	3,97	5/32	0,4	1/64	4,40	.173	○	○	○	○	○	○	○	○	○	○	○	○	○	○	○	○	○	○	○	○
DCMT11T308MP	DCMT3252MP	9,53	3/8	11,63	.458	3,97	5/32	0,8	1/32	4,40	.173	○	○	○	○	○	○	○	○	○	○	○	○	○	○	○	○	○	○	○	○
DCMT11T312MP	DCMT3253MP	9,53	3/8	11,63	.458	3,97	5/32	1,2	3/64	4,40	.173	○	○	○	○	○	○	○	○	○	○	○	○	○	○	○	○	○	○	○	○

### DCMT-MU • Medium Universal

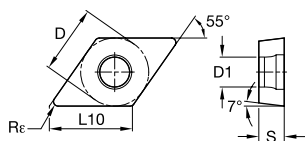
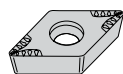

● first choice  
○ alternate choice

	P	M	K	N	S	H
WP05CT	●	●	○	○	○	○
WP15CT	○	○	○	○	○	○
WP25CT	○	○	○	○	○	○
WP35CT	○	○	○	○	○	○
WM15CT	○	○	○	○	○	○
WM25CT	○	○	○	○	○	○
WM35CT	○	○	○	○	○	○
WK05CT	○	○	○	○	○	○
WK15CT	○	○	○	○	○	○
WK20CT	○	○	○	○	○	○
WS10PT	○	○	○	○	○	○
WS25PT	○	○	○	○	○	○
WU10HT	○	○	○	○	○	○
WU05PT	○	○	○	○	○	○
WP20TT	○	○	○	○	○	○
THM	○	○	○	○	○	○
TTR	○	○	○	○	○	○
WM20CT	○	○	○	○	○	○
WU10PT	○	○	○	○	○	○
WU25PT	○	○	○	○	○	○

ISO catalog number	ANSI catalog number	D		L10		S		Rε		D1																										
		mm	in	mm	in	mm	in	mm	in	mm	in	WP05CT	WP15CT	WP25CT	WP35CT	WM15CT	WM25CT	WM35CT	WK05CT	WK15CT	WK20CT	WS10PT	WS25PT	WU10HT	WU05PT	WP20TT	THM	TTR	WM20CT	WU10PT	WU25PT					
DCMT070204MU	DCMT2151MU	6,35	1/4	7,75	.305	2,38	3/32	0,4	1/64	2,80	.110	●	●	○	○	○	○	○	○	○	○	○	○	○	○	○	○	○	○	○	○	○	○	○		
DCMT070208MU	DCMT2152MU	6,35	1/4	7,75	.305	2,38	3/32	0,8	1/32	3,75	.148	○	○	○	○	○	○	○	○	○	○	○	○	○	○	○	○	○	○	○	○	○	○	○		
DCMT111308MU	DCMT3252MU	9,52	3/8	11,63	.458	3,97	5/32	0,8	1/32	4,40	.173	○	○	○	○	○	○	○	○	○	○	○	○	○	○	○	○	○	○	○	○	○	○	○	○	
DCMT111304MU	DCMT3251MU	9,53	3/8	11,63	.458	3,97	5/32	0,4	1/64	4,40	.173	○	○	○	○	○	○	○	○	○	○	○	○	○	○	○	○	○	○	○	○	○	○	○	○	
DCMT150404MU	DCMT431MU	12,70	1/2	15,50	.610	4,76	3/16	0,4	1/64	5,50	.217	○	○	○	○	○	○	○	○	○	○	○	○	○	○	○	○	○	○	○	○	○	○	○	○	
DCMT150408MU	DCMT432MU	12,70	1/2	15,50	.610	4,76	3/16	0,8	1/32	5,50	.217	○	○	○	○	○	○	○	○	○	○	○	○	○	○	○	○	○	○	○	○	○	○	○	○	○
DCMT150412MU	DCMT433MU	12,70	1/2	15,50	.610	4,76	3/16	1,2	3/64	5,55	.214	○	○	○	○	○	○	○	○	○	○	○	○	○	○	○	○	○	○	○	○	○	○	○	○	○

INDEXABLE MILLING

SOLID END MILLING

HOLEMAKING

TAPPING

TURNING





**DNGG-FS • Finishing Sharp**

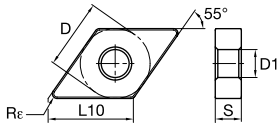

● first choice  
○ alternate choice

P	M	K	N	S	H	WP05CT	WP15CT	WP25CT	WP35CT	WM15CT	WM25CT	WM35CT	WK05CT	WK15CT	WK20CT	WS10PT	WS25PT	WU10HT	WU05PT	WP20TT	THM	TTR	WM20CT	WU10PT	WU25PT	
●	●	●	●	○	○	○	○	○	○	○	○	○	○	○	○	○	○	○	○	○	○	○	○	○	○	○
○	○	○	○	○	○	○	○	○	○	○	○	○	○	○	○	○	○	○	○	○	○	○	○	○	○	○
○	○	○	○	○	○	○	○	○	○	○	○	○	○	○	○	○	○	○	○	○	○	○	○	○	○	○
○	○	○	○	○	○	○	○	○	○	○	○	○	○	○	○	○	○	○	○	○	○	○	○	○	○	○

ISO catalog number	ANSI catalog number	D		L10		S		Rε		D1																						
		mm	in	mm	in	mm	in	mm	in	mm	in	WP05CT	WP15CT	WP25CT	WP35CT	WM15CT	WM25CT	WM35CT	WK05CT	WK15CT	WK20CT	WS10PT	WS25PT	WU10HT	WU05PT	WP20TT	THM	TTR	WM20CT	WU10PT	WU25PT	
DNGG110402FS	DNGG3305FS	9,53	3/8	11,63	.458	4,76	3/16	0,2	.008	3,81	.150																					
DNGG110404FS	DNGG331FS	9,53	3/8	11,63	.458	4,76	3/16	0,4	1/64	3,81	.150																					
DNGG110408FS	DNGG332FS	9,53	3/8	11,63	.458	4,76	3/16	0,8	1/32	3,81	.150																					
DNGG150401FS	DNGG430FS	12,70	1/2	15,50	.610	4,76	3/16	0,1	.004	5,16	.203																					
DNGG150402FS	DNGG4305FS	12,70	1/2	15,50	.610	4,76	3/16	0,2	.008	5,16	.203																					
DNGG150404FS	DNGG431FS	12,70	1/2	15,50	.610	4,76	3/16	0,4	1/64	5,16	.203																					
DNGG150408FS	DNGG432FS	12,70	1/2	15,50	.610	4,76	3/16	0,8	1/32	5,16	.203																					
DNGG150412FS	DNGG433FS	12,70	1/2	15,50	.610	4,76	3/16	1,2	3/64	5,16	.203																					
DNGG150604FS	DNGG441FS	12,70	1/2	15,50	.610	6,35	1/2	0,4	1/64	5,16	.203																					
DNGG150608FS	DNGG442FS	12,70	1/2	15,50	.610	6,35	1/4	0,8	1/32	5,16	.203																					

INDEXABLE MILLING

SOLID END MILLING

HOLE/MAKING

TAPPING

TURNING

## DNGP • Medium Machining

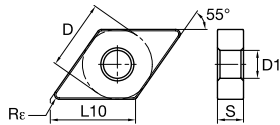
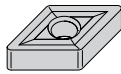

● first choice  
○ alternate choice

ISO catalog number	ANSI catalog number	D		L10		S		Rε		D1																								
		mm	in	mm	in	mm	in	mm	in	mm	in	WP05CT	WP15CT	WP25CT	WP35CT	WM15CT	WM25CT	WM35CT	WK05CT	WK15CT	WK20CT	WS10PT	WS25PT	WU10HT	WU05PT	WP20TT	THM	TTR	WM20CT	WU10PT	WU25PT			
<b>DNGP150404</b>	<b>DNGP431</b>	12,70	1/2	15,50	.610	4,76	3/16	0,4	1/64	5,16	.203	•	•	•	•	•	•	•	•	•	•	•	•	•	•	•	•	•	•	•	•	•	•	•

NOTE: Single sided

## DNMA • Roughing

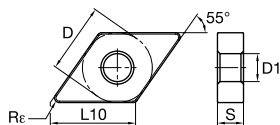
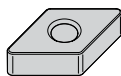

● first choice  
○ alternate choice

ISO catalog number	ANSI catalog number	D		L10		S		Rε		D1																							
		mm	in	mm	in	mm	in	mm	in	mm	in	WP05CT	WP15CT	WP25CT	WP35CT	WM15CT	WM25CT	WM35CT	WK05CT	WK15CT	WK20CT	WS10PT	WS25PT	WU10HT	WU05PT	WP20TT	THM	TTR	WM20CT	WU10PT	WU25PT		
<b>DNMA110408</b>	<b>DNMA332</b>	9,53	3/8	11,63	.458	4,76	3/16	0,8	1/32	3,81	.150	•	•	•	•	•	•	•	•	•	•	•	•	•	•	•	•	•	•	•	•	•	•
<b>DNMA150408</b>	<b>DNMA432</b>	12,70	1/2	15,50	.610	4,76	3/16	0,8	1/32	5,16	.203	•	•	•	•	•	•	•	•	•	•	•	•	•	•	•	•	•	•	•	•	•	•
<b>DNMA150412</b>	<b>DNMA433</b>	12,70	1/2	15,50	.610	4,76	3/16	1,2	3/64	5,16	.203	•	•	•	•	•	•	•	•	•	•	•	•	•	•	•	•	•	•	•	•	•	•
<b>DNMA150608</b>	<b>DNMA442</b>	12,70	1/2	15,50	.610	6,35	1/4	0,8	1/32	5,16	.203	•	•	•	•	•	•	•	•	•	•	•	•	•	•	•	•	•	•	•	•	•	•
<b>DNMA150612</b>	<b>DNMA443</b>	12,70	1/2	15,50	.610	6,35	1/4	1,2	3/64	5,16	.203	•	•	•	•	•	•	•	•	•	•	•	•	•	•	•	•	•	•	•	•	•	•
<b>DNMA150616</b>	<b>DNMA444</b>	12,70	1/2	15,50	.610	6,35	1/4	1,6	1/16	5,16	.203	•	•	•	•	•	•	•	•	•	•	•	•	•	•	•	•	•	•	•	•	•	•

## DNMG • Roughing

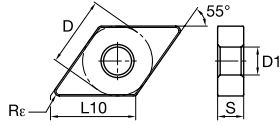
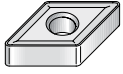

● first choice  
○ alternate choice

ISO catalog number	ANSI catalog number	D		L10		S		Re		D1																												
		mm	in	mm	in	mm	in	mm	in	mm	in	mm	in	WP05CT	WP15CT	WP25CT	WP35CT	WM15CT	WM25CT	WM35CT	WK05CT	WK15CT	WK20CT	WS10PT	WS25PT	WU10HT	WU05PT	WP20TT	THM	TTR	WM20CT	WU10PT	WU25PT					
DNMG150608	DNMG442	12,70	1/2	15,50	.610	6,35	1/4	0,8	1/32	5,16	.203																											

P	●	●	●	●	●	○	○	○	○	○	○	○	○	○	○	○	○	○	○	○	○	○	○	○	○	○	○	○	○	○	○	○	○	○	○	○	
M	●	●	●	●	●	○	○	○	○	○	○	○	○	○	○	○	○	○	○	○	○	○	○	○	○	○	○	○	○	○	○	○	○	○	○	○	○
K	○	○	○	○	○	○	○	○	○	○	○	○	○	○	○	○	○	○	○	○	○	○	○	○	○	○	○	○	○	○	○	○	○	○	○	○	○
N	○	○	○	○	○	○	○	○	○	○	○	○	○	○	○	○	○	○	○	○	○	○	○	○	○	○	○	○	○	○	○	○	○	○	○	○	○
S	○	○	○	○	○	○	○	○	○	○	○	○	○	○	○	○	○	○	○	○	○	○	○	○	○	○	○	○	○	○	○	○	○	○	○	○	○
H	○	○	○	○	○	○	○	○	○	○	○	○	○	○	○	○	○	○	○	○	○	○	○	○	○	○	○	○	○	○	○	○	○	○	○	○	○

## DNMG-CT

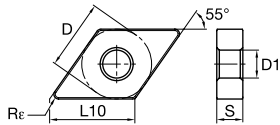
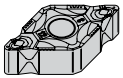

● first choice  
○ alternate choice

ISO catalog number	ANSI catalog number	D		L10		S		Re		D1																											
		mm	in	mm	in	mm	in	mm	in	mm	in	WP05CT	WP15CT	WP25CT	WP35CT	WM15CT	WM25CT	WM35CT	WK05CT	WK15CT	WK20CT	WS10PT	WS25PT	WU10HT	WU05PT	WP20TT	THM	TTR	WM20CT	WU10PT	WU25PT						
DNMG150608CT	DNMG442CT	12,70	1/2	15,50	.610	6,35	1/4	0,8	1/32	5,16	.203																										

P	●	●	●	●	●	○	○	○	○	○	○	○	○	○	○	○	○	○	○	○	○	○	○	○	○	○	○	○	○	○	○	○	○	○	○	○	○	
M	○	○	○	○	○	○	○	○	○	○	○	○	○	○	○	○	○	○	○	○	○	○	○	○	○	○	○	○	○	○	○	○	○	○	○	○	○	○
K	○	○	○	○	○	○	○	○	○	○	○	○	○	○	○	○	○	○	○	○	○	○	○	○	○	○	○	○	○	○	○	○	○	○	○	○	○	○
N	○	○	○	○	○	○	○	○	○	○	○	○	○	○	○	○	○	○	○	○	○	○	○	○	○	○	○	○	○	○	○	○	○	○	○	○	○	○
S	○	○	○	○	○	○	○	○	○	○	○	○	○	○	○	○	○	○	○	○	○	○	○	○	○	○	○	○	○	○	○	○	○	○	○	○	○	○
H	○	○	○	○	○	○	○	○	○	○	○	○	○	○	○	○	○	○	○	○	○	○	○	○	○	○	○	○	○	○	○	○	○	○	○	○	○	○

## DNMG-FF • Fine Finishing

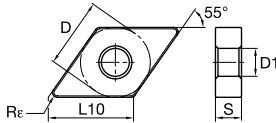
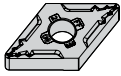

● first choice

○ alternate choice

P	●	●	●	●	○	○	○	○	○	○	○	○	○	○	○	○	○	○	○	○	○	○	○	○	○	○	○	○	
M	●	○	○	○	○	○	○	○	○	○	○	○	○	○	○	○	○	○	○	○	○	○	○	○	○	○	○	○	○
K	○	○	○	○	○	○	○	○	○	○	○	○	○	○	○	○	○	○	○	○	○	○	○	○	○	○	○	○	○
N	○	○	○	○	○	○	○	○	○	○	○	○	○	○	○	○	○	○	○	○	○	○	○	○	○	○	○	○	○
S	○	○	○	○	○	○	○	○	○	○	○	○	○	○	○	○	○	○	○	○	○	○	○	○	○	○	○	○	○
H	○	○	○	○	○	○	○	○	○	○	○	○	○	○	○	○	○	○	○	○	○	○	○	○	○	○	○	○	○

ISO catalog number	ANSI catalog number	D		L10		S		Rε		D1		WP05CT 4171028	WP15CT 4171029	WP25CT 4171030	WP35CT 4171031	WM15CT 4171032	WM25CT 4171033	WM35CT 4171034	WK05CT 4171035	WK15CT 4171036	WK20CT 4171037	WS10PT 4171038	WS25PT 4171039	WU10HT 4171040	WU05PT 4171041	WP20TT 4171042	THM 4171043	TTR 4171044	WM20CT 4171045	WU10PT 4171046	WU25PT 4171047						
		mm	in	mm	in	mm	in	mm	in	mm	in																										
DNMG110404FF	DNMG331FF	9,53	3/8	11,63	.458	4,76	3/16	0,4	1/64	3,81	.150																										
DNMG110408FF	DNMG332FF	9,53	3/8	11,63	.458	4,76	3/16	0,8	1/32	3,81	.150																										
DNMG150404FF	DNMG431FF	12,70	1/2	15,50	.610	4,76	3/16	0,4	1/64	5,16	.203																										
DNMG150408FF	DNMG432FF	12,70	1/2	15,50	.610	4,76	3/16	0,8	1/32	5,16	.203																										
DNMG150604FF	DNMG441FF	12,70	1/2	15,50	.610	6,35	1/4	0,4	1/64	5,16	.203																										
DNMG150608FF	DNMG442FF	12,70	1/2	15,50	.610	6,35	1/4	0,8	1/32	5,16	.203																										
DNMG150612FF	DNMG443FF	12,70	1/2	15,50	.610	6,35	1/4	1,2	3/64	5,16	.203																										

## DNMG-ML • Medium Machining

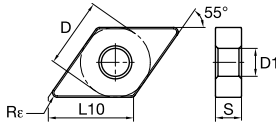

● first choice  
○ alternate choice

P	M	K	N	S	H																
●	●	●	○	○	○	○	○	○	○	○	○	○	○	○	○	○	○	○	○	○	○
●	●	○	○	○	○	○	○	○	○	○	○	○	○	○	○	○	○	○	○	○	○
○	○	○	○	○	○	○	○	○	○	○	○	○	○	○	○	○	○	○	○	○	○
○	○	○	○	○	○	○	○	○	○	○	○	○	○	○	○	○	○	○	○	○	○
○	○	○	○	○	○	○	○	○	○	○	○	○	○	○	○	○	○	○	○	○	○
○	○	○	○	○	○	○	○	○	○	○	○	○	○	○	○	○	○	○	○	○	○

ISO catalog number	ANSI catalog number	D		L10		S		Re		D1		WP05CT	WP15CT	WP25CT	WP35CT	WM15CT	WM25CT	WM35CT	WK05CT	WK15CT	WK20CT	WS10PT	WS25PT	WU10HT	WU05PT	WP20TT	THM	TTR	WM20CT	WU10PT	WU25PT	
		mm	in	mm	in	mm	in	mm	in	mm	in	mm	in																			
<b>DNMG110404ML</b>	<b>DNMG331ML</b>	9,53	3/8	11,63	.458	4,76	3/16	0,4	1/64	3,81	.150		4171062	4170461						4171660	4171394											
<b>DNMG110408ML</b>	<b>DNMG332ML</b>	9,53	3/8	11,63	.458	4,76	3/16	0,8	1/32	3,81	.150		4171063	4170462																		
<b>DNMG110412ML</b>	<b>DNMG333ML</b>	9,53	3/8	11,63	.458	4,76	3/16	1,2	3/64	3,81	.150		4171064	4171064																		
<b>DNMG150404ML</b>	<b>DNMG431ML</b>	12,70	1/2	15,50	.610	4,76	3/16	0,4	1/64	5,16	.203		4171065	4170483																		
<b>DNMG150408ML</b>	<b>DNMG432ML</b>	12,70	1/2	15,50	.610	4,76	3/16	0,8	1/32	5,16	.203		4171066	4170484																		
<b>DNMG150412ML</b>	<b>DNMG433ML</b>	12,70	1/2	15,50	.610	4,76	3/16	1,2	3/64	5,16	.203		4171067	4170485																		
<b>DNMG150604ML</b>	<b>DNMG441ML</b>	12,70	1/2	15,50	.610	6,35	1/4	0,4	1/64	5,16	.203		4171068	4170485																		
<b>DNMG150608ML</b>	<b>DNMG442ML</b>	12,70	1/2	15,50	.610	6,35	1/4	0,8	1/32	5,16	.203		4171069	4170486							4171400											
<b>DNMG150612ML</b>	<b>DNMG443ML</b>	12,70	1/2	15,50	.610	6,35	1/4	1,2	3/64	5,16	.203		4171070	4170487																		

INDEXABLE MILLING

SOLID END MILLING

HOLEMAKING

TAPPING

TURNING



DNMG-MS • Medium Sharp

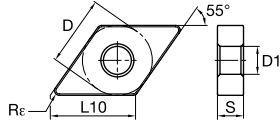

● first choice

○ alternate choice

P	●	●	●	●	○	○	○	○	○	○	○	○	○	○	○	○	○	○	○	○	○	○	○	○	○	○
M	●	●	○	○	○	○	○	○	○	○	○	○	○	○	○	○	○	○	○	○	○	○	○	○	○	○
K	○	○	○	○	○	○	○	○	○	○	○	○	○	○	○	○	○	○	○	○	○	○	○	○	○	○
N	○	○	○	○	○	○	○	○	○	○	○	○	○	○	○	○	○	○	○	○	○	○	○	○	○	○
S	○	○	○	○	○	○	○	○	○	○	○	○	○	○	○	○	○	○	○	○	○	○	○	○	○	○
H	○	○	○	○	○	○	○	○	○	○	○	○	○	○	○	○	○	○	○	○	○	○	○	○	○	○

ISO catalog number	ANSI catalog number	D		L10		S		Re		D1		WP05CT	WP15CT	WP25CT	WP35CT	WPM15CT	WPM25CT	WPM35CT	WPM05CT	WPM15CT	WPM20CT	WS10PT	WS25PT	WU10HT	WU05PT	WP20TT	THM	TTR	WM20CT	WU10PT	WU25PT		
		mm	in	mm	in	mm	in	mm	in	mm	in																						
DNMG110408MS	DNMG332MS	9,53	3/8	11,63	.458	4,76	3/16	0,8	1/32	3,81	.150	■	■	■	■	■	■	■	■	■	■	■	■	■	■	■	■	■	■	■	■	■	
DNMG150404MS	DNMG431MS	12,70	1/2	15,50	.610	4,76	3/16	0,4	1/64	5,16	.203	■	■	■	■	■	■	■	■	■	■	■	■	■	■	■	■	■	■	■	■	■	
DNMG150408MS	DNMG432MS	12,70	1/2	15,50	.610	4,76	3/16	0,8	1/32	5,16	.203	■	■	■	■	■	■	■	■	■	■	■	■	■	■	■	■	■	■	■	■	■	
DNMG150412MS	DNMG433MS	12,70	1/2	15,50	.610	4,76	3/16	1,2	3/64	5,16	.203	■	■	■	■	■	■	■	■	■	■	■	■	■	■	■	■	■	■	■	■	■	
DNMG150604MS	DNMG441MS	12,70	1/2	15,50	.610	6,35	1/4	0,4	1/64	5,16	.203	■	■	■	■	■	■	■	■	■	■	■	■	■	■	■	■	■	■	■	■	■	■
DNMG150608MS	DNMG442MS	12,70	1/2	15,50	.610	6,35	1/4	0,8	1/32	5,16	.203	■	■	■	■	■	■	■	■	■	■	■	■	■	■	■	■	■	■	■	■	■	■
DNMG150612MS	DNMG443MS	12,70	1/2	15,50	.610	6,35	1/4	1,2	3/64	5,16	.203	■	■	■	■	■	■	■	■	■	■	■	■	■	■	■	■	■	■	■	■	■	■

INDEXABLE MILLING

SOLID END MILLING

HOLEMAKING

TAPPING

TURNING



INDEXABLE MILLING

SOLID END MILLING

HOLEMAKING

TAPPING

TURNING

## DNMG-MW • Medium Wiper

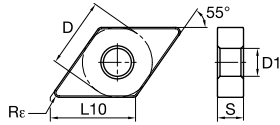
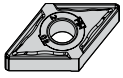

- first choice
- alternate choice

ISO catalog number	ANSI catalog number	D		L10		S		R <sub>e</sub>		D1																						
		mm	in	mm	in	mm	in	mm	in	mm	in	WP05CT	WP15CT	WP25CT	WP35CT	WM15CT	WM25CT	WM35CT	WK05CT	WK15CT	WK20CT	WS10PT	WS25PT	WU10HT	WU05PT	WP20TT	TTHM	TTR	WM20CT	WU10PT	WU25PT	
DNMG150408MW	DNMG432MW	12,70	1/2	15,50	.610	4,76	3/16	0,8	1/32	5,16	.203	●	●	●	●	○	○	○	○	○	○	○	○	○	○	○	○	○	○	○	○	○
DNMG150608MW	DNMG442MW	12,70	1/2	15,50	.610	6,35	1/4	0,8	1/32	5,16	.203	●	●	●	●	○	○	○	○	○	○	○	○	○	○	○	○	○	○	○	○	○

## DNMG-RH • Roughing

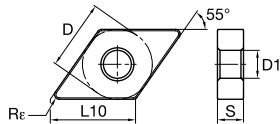
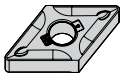

- first choice
- alternate choice

ISO catalog number	ANSI catalog number	D		L10		S		R <sub>e</sub>		D1																					
		mm	in	mm	in	mm	in	mm	in	mm	in	WP05CT	WP15CT	WP25CT	WP35CT	WM15CT	WM25CT	WM35CT	WK05CT	WK15CT	WK20CT	WS10PT	WS25PT	WU10HT	WU05PT	WP20TT	TTHM	TTR	WM20CT	WU10PT	WU25PT
DNMG150408RH	DNMG432RH	12,70	1/2	15,50	.610	4,76	3/16	0,8	1/32	5,16	.203	●	●	●	●	○	○	○	○	○	○	○	○	○	○	○	○	○	○	○	○
DNMG150608RH	DNMG442RH	12,70	1/2	15,50	.610	6,35	1/4	0,8	1/32	5,16	.203	●	●	●	●	○	○	○	○	○	○	○	○	○	○	○	○	○	○	○	○
DNMG150612RH	DNMG443RH	12,70	1/2	15,50	.610	6,35	1/4	1,2	3/64	5,16	.203	●	●	●	●	○	○	○	○	○	○	○	○	○	○	○	○	○	○	○	○
DNMG150616RH	DNMG444RH	12,70	1/2	15,50	.610	6,35	1/4	1,6	1/16	5,16	.203	●	●	●	●	○	○	○	○	○	○	○	○	○	○	○	○	○	○	○	○
DNMG190612RH	DNMG543RH	15,88	5/8	19,38	.763	6,35	1/4	1,2	3/64	6,35	.250	●	●	●	●	○	○	○	○	○	○	○	○	○	○	○	○	○	○	○	○

## DNMG-UF • Fine Finishing

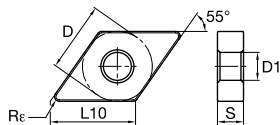
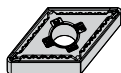

● first choice

○ alternate choice

	P	M	K	N	S	H																		
P	●	●	○	○	○	○	○	○	○	○	○	○	○	○	○	○	○	○	○	○	○	○	○	○
M	○	○	○	○	○	○	○	○	○	○	○	○	○	○	○	○	○	○	○	○	○	○	○	○
K	○	○	○	○	○	○	○	○	○	○	○	○	○	○	○	○	○	○	○	○	○	○	○	○
N	○	○	○	○	○	○	○	○	○	○	○	○	○	○	○	○	○	○	○	○	○	○	○	○
S	○	○	○	○	○	○	○	○	○	○	○	○	○	○	○	○	○	○	○	○	○	○	○	○
H	○	○	○	○	○	○	○	○	○	○	○	○	○	○	○	○	○	○	○	○	○	○	○	○

ISO catalog number	ANSI catalog number	D		L10		S		R $\epsilon$		D1		WP05CT	WP15CT	WP25CT	WP35CT	WM15CT	WM25CT	WM35CT	WK05CT	WK15CT	WK20CT	WS10PT	WS25PT	WU10HT	WU05PT	WP20TT	THM	TTR	WM20CT	WU10PT	WU25PT
		mm	in	mm	in	mm	in	mm	in	mm	in																				
DNMG110404UF	DNMG331UF	9,53	3/8	11,63	.458	4,76	3/16	0,4	1/64	3,81	.150	●	●	●	○	○	○	○	○	○	○	○	○	○	○	○	○	○	○	○	○
DNMG110408UF	DNMG332UF	9,53	3/8	11,63	.458	4,76	3/16	0,8	1/32	3,81	.150	●	●	●	○	○	○	○	○	○	○	○	○	○	○	○	○	○	○	○	○
DNMG150404UF	DNMG431UF	12,70	1/2	15,50	.610	4,76	3/16	0,4	1/64	5,16	.203	●	●	●	○	○	○	○	○	○	○	○	○	○	○	○	○	○	○	○	○
DNMG150408UF	DNMG432UF	12,70	1/2	15,50	.610	4,76	3/16	0,8	1/32	5,16	.203	●	●	●	○	○	○	○	○	○	○	○	○	○	○	○	○	○	○	○	○
DNMG150604UF	DNMG441UF	12,70	1/2	15,50	.610	6,35	1/4	0,4	1/64	5,16	.203	●	●	●	○	○	○	○	○	○	○	○	○	○	○	○	○	○	○	○	○
DNMG150608UF	DNMG442UF	12,70	1/2	15,50	.610	6,35	1/4	0,8	1/32	5,16	.203	●	●	●	○	○	○	○	○	○	○	○	○	○	○	○	○	○	○	○	○
DNMG150612UF	DNMG443UF	12,70	1/2	15,50	.610	6,35	1/4	1,2	3/64	5,16	.203	●	●	●	○	○	○	○	○	○	○	○	○	○	○	○	○	○	○	○	○

INDEXABLE MILLING

SOLID END MILLING

HOLE MAKING

TAPPING

TURNING

## DNMG-UM • Medium Machining

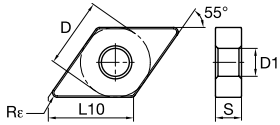
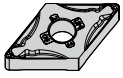

● first choice  
○ alternate choice

P	●		●		●		○		○		○		○		○		○		○		○		○		○		○		○		○		○		○		○		○										
	M	K	N	S	H																																												
ISO catalog number	ANSI catalog number		D		L10		S		Rε		D1		WP05CT	WP15CT	WP25CT	WP35CT	WM15CT	WM25CT	WM35CT	WK05CT	WK15CT	WK20CT	WS10PT	WS25PT	WU10HT	WU05PT	WU15PT	WP20TT	THM	TTR	WM20CT	WU10PT	WU25PT																
DNMG110404UM	DNMG331UM		9,53	3/8	11,63	.458	4,76	3/16	0,4	1/64	3,81	.150																																					
DNMG110408UM	DNMG332UM		9,53	3/8	11,63	.458	4,76	3/16	0,8	1/32	3,81	.150																																					
DNMG150404UM	DNMG431UM		12,70	1/2	15,50	.610	4,76	3/16	0,4	1/64	5,16	.203																																					
DNMG150408UM	DNMG432UM		12,70	1/2	15,50	.610	4,76	3/16	0,8	1/32	5,16	.203																																					
DNMG150604UM	DNMG441UM		12,70	1/2	15,50	.610	6,35	1/4	0,4	1/64	5,16	.203																																					
DNMG150608UM	DNMG442UM		12,70	1/2	15,50	.610	6,35	1/4	0,8	1/32	5,16	.203																																					
DNMG150612UM	DNMG443UM		12,70	1/2	15,50	.610	6,35	1/4	1,2	3/64	5,16	.203																																					
DNMG150616UM	DNMG444UM		12,70	1/2	15,50	.610	6,35	1/4	1,6	1/16	5,16	.203																																					



INDEXABLE MILLING

SOLID END MILLING

HOLEMAKING

TAPPING

TURNING

### DNMM-65 • Heavy Roughing

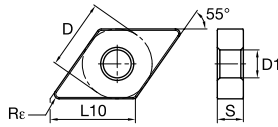
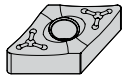

● first choice  
○ alternate choice

ISO catalog number	ANSI catalog number	D		L10		S		Rε		D1		Material Compatibility																																
		mm	in	mm	in	mm	in	mm	in	mm	in	mm	in	WP05CT	WP15CT	WP25CT	WP35CT	WM15CT	WM25CT	WM35CT	WK05CT	WK15CT	WK20CT	WS10PT	WS25PT	WU10HT	WU05PT	WP20TT	THM	TTR	WM20CT	WU10PT	WU25PT											
DNMM15060865	DNMM44265	12,70	1/2	15,50	.610	6,35	1/4	0,8	1/32	5,16	.203	●	●	●	●	○	○	○	○	○	○	○	○	○	○	○	○	○	○	○	○	○	○	○	○	○	○	○	○	○	○			
DNMM15061265	DNMM44365	12,70	1/2	15,50	.610	6,35	1/4	1,2	3/64	5,16	.203	●	●	●	●	○	○	○	○	○	○	○	○	○	○	○	○	○	○	○	○	○	○	○	○	○	○	○	○	○	○	○	○	
DNMM15061665	DNMM44465	12,70	1/2	15,50	.610	6,35	1/4	1,6	1/16	5,16	.203	●	●	●	●	○	○	○	○	○	○	○	○	○	○	○	○	○	○	○	○	○	○	○	○	○	○	○	○	○	○	○	○	○

### DNMP • Medium Machining

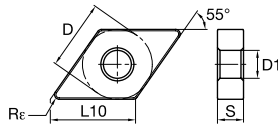
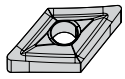

● first choice  
○ alternate choice

ISO catalog number	ANSI catalog number	D		L10		S		Rε		D1		Material Compatibility																																			
		mm	in	mm	in	mm	in	mm	in	mm	in	WP05CT	WP15CT	WP25CT	WP35CT	WM15CT	WM25CT	WM35CT	WK05CT	WK15CT	WK20CT	WS10PT	WS25PT	WU10HT	WU05PT	WP20TT	THM	TTR	WM20CT	WU10PT	WU25PT																
DNMP150404	DNMP431	12,70	1/2	15,50	.610	4,76	3/16	0,4	1/64	5,16	.203	●	●	●	●	○	○	○	○	○	○	○	○	○	○	○	○	○	○	○	○	○	○	○	○	○	○	○	○	○	○	○					
DNMP150408	DNMP432	12,70	1/2	15,50	.610	4,76	3/16	0,8	1/32	5,16	.203	●	●	●	●	○	○	○	○	○	○	○	○	○	○	○	○	○	○	○	○	○	○	○	○	○	○	○	○	○	○	○	○	○			
DNMP150604	DNMP441	12,70	1/2	15,50	.610	6,35	1/4	0,4	1/64	5,16	.203	●	●	●	●	○	○	○	○	○	○	○	○	○	○	○	○	○	○	○	○	○	○	○	○	○	○	○	○	○	○	○	○	○	○		
DNMP150608	DNMP442	12,70	1/2	15,50	.610	6,35	1/4	0,8	1/32	5,16	.203	●	●	●	●	○	○	○	○	○	○	○	○	○	○	○	○	○	○	○	○	○	○	○	○	○	○	○	○	○	○	○	○	○	○	○	
DNMP150612	DNMP443	12,70	1/2	15,50	.610	6,35	1/4	1,2	3/64	5,16	.203	●	●	●	●	○	○	○	○	○	○	○	○	○	○	○	○	○	○	○	○	○	○	○	○	○	○	○	○	○	○	○	○	○	○	○	○

RCMT • Medium Machining

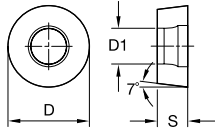
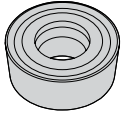

● first choice  
○ alternate choice

P	●	●	●	●	○	○	○	○	○	○	○	○	○	○	○	○	○	○
M	●	●	●	●	○	○	○	○	○	○	○	○	○	○	○	○	○	○
K	○	○	○	○	●	●	●	●	●	●	●	●	●	●	●	●	●	●
N	○	○	○	○	○	○	○	○	○	○	○	○	○	○	○	○	○	○
S	○	○	○	○	○	○	○	○	○	○	○	○	○	○	○	○	○	○
H	○	○	○	○	○	○	○	○	○	○	○	○	○	○	○	○	○	○

ISO catalog number	ANSI catalog number	D		S		D1		WP05CT	WP15CT	WP25CT	WP35CT	WM15CT	WM25CT	WM35CT	WK05CT	WK15CT	WK20CT	WS10PT	WS25PT	WU10HT	WU05PT	WP20TT	THM	TTR	WM20CT	WU10PT	WU25PT	
		mm	in	mm	in	mm	in																					
RCMT0602M0	RCMT0602M0	6,00	.236	2,38	3/32	2,80	.110	●	●	●	○	○	○	○	○	○	○	○	○	○	○	○	○	○	○	○	○	○
RCMT0803M0	RCMT0803M0	8,00	.315	3,18	1/8	3,40	.134	○	○	○	○	○	○	○	○	○	○	○	○	○	○	○	○	○	○	○	○	○
RCMT10T3M0	RCMT10T3M0	10,00	.394	3,97	5/32	4,40	.173	○	○	○	○	○	○	○	○	○	○	○	○	○	○	○	○	○	○	○	○	○
RCMT1204M0	RCMT1204M0	12,00	.472	4,76	3/16	4,40	.173	○	○	○	○	○	○	○	○	○	○	○	○	○	○	○	○	○	○	○	○	○
RCMT1606M0	RCMT1606M0	16,00	.630	6,35	1/4	5,50	.217	○	○	○	○	○	○	○	○	○	○	○	○	○	○	○	○	○	○	○	○	○

INDEXABLE MILLING

SOLID END MILLING

HOLE/MAKING

TAPPING

TURNING







## SCMT • Medium Machining

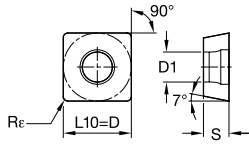

● first choice

○ alternate choice

P	M	K	N	S	H	WP05CT	WP15CT	WP25CT	WP35CT	WM15CT	WM25CT	WM35CT	WK05CT	WK15CT	WK20CT	WS10PT	WS25PT	WU10HT	WU05PT	WP20TT	THM	TTR	WM20CT	WU10PT	WU25PT	
●	●	○	○	○	○	○	○	○	○	○	○	○	○	○	○	○	○	○	○	○	○	○	○	○	○	○
●	●	○	○	○	○	○	○	○	○	○	○	○	○	○	○	○	○	○	○	○	○	○	○	○	○	○
○	○	○	○	○	○	○	○	○	○	○	○	○	○	○	○	○	○	○	○	○	○	○	○	○	○	○
○	○	○	○	○	○	○	○	○	○	○	○	○	○	○	○	○	○	○	○	○	○	○	○	○	○	○
○	○	○	○	○	○	○	○	○	○	○	○	○	○	○	○	○	○	○	○	○	○	○	○	○	○	○

ISO catalog number	ANSI catalog number	D		L10		S		Rε		D1		WP05CT	WP15CT	WP25CT	WP35CT	WM15CT	WM25CT	WM35CT	WK05CT	WK15CT	WK20CT	WS10PT	WS25PT	WU10HT	WU05PT	WP20TT	THM	TTR	WM20CT	WU10PT	WU25PT	
		mm	in	mm	in	mm	in	mm	in	mm	in																					
SCMT090304	SCMT321	9,53	3/8	9,53	.375	3,18	1/8	0,4	1/64	4,45	.175	○	○	○	○	○	○	○	○	○	○	○	○	○	○	○	○	○	○	○	○	○
SCMT090308	SCMT322	9,53	3/8	9,53	.375	3,18	1/8	0,8	1/32	4,40	.173	○	○	○	○	○	○	○	○	○	○	○	○	○	○	○	○	○	○	○	○	○
SCMT09T304	SCMT3251	9,53	3/8	9,53	.375	3,97	5/32	0,4	1/64	4,45	.175	○	○	○	○	○	○	○	○	○	○	○	○	○	○	○	○	○	○	○	○	○
SCMT09T308	SCMT3252	9,53	3/8	9,53	.375	3,97	5/32	0,8	1/32	4,40	.173	○	○	○	○	○	○	○	○	○	○	○	○	○	○	○	○	○	○	○	○	○
SCMT120408	SCMT432	12,70	1/2	12,70	.500	4,76	3/16	0,8	1/32	5,50	.217	○	○	○	○	○	○	○	○	○	○	○	○	○	○	○	○	○	○	○	○	○
SCMT150512	SCMT5353	15,88	5/8	15,88	.625	5,56	7/32	1,2	3/64	5,50	.217	○	○	○	○	○	○	○	○	○	○	○	○	○	○	○	○	○	○	○	○	○

### SCMT-FP • Finishing Positive

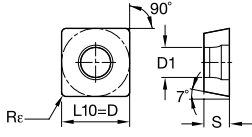
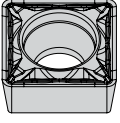

● first choice  
○ alternate choice

ISO catalog number	ANSI catalog number	D		L10		S		Re		D1																								
		mm	in	mm	in	mm	in	mm	in	mm	in	WP05CT	WP15CT	WP25CT	WP35CT	WM15CT	WM25CT	WM35CT	WK05CT	WK15CT	WK20CT	WS10PT	WS25PT	WU10HT	WU05PT	WP20TT	THM	TTR	WM20CT	WU10PT	WU25PT			
SCMT09T308FP	SCMT3252FP	9,53	3/8	9,53	.375	3,97	5/32	0,8	1/32	4,40	.173																							
SCMT120408FP	SCMT432FP	12,70	1/2	12,70	.500	4,76	3/16	0,8	1/32	5,50	.217																							

### SCMT-MP • Medium Positive

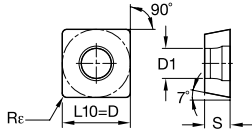
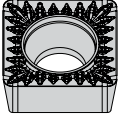

● first choice  
○ alternate choice

ISO catalog number	ANSI catalog number	D		L10		S		Re		D1																								
		mm	in	mm	in	mm	in	mm	in	mm	in	WP05CT	WP15CT	WP25CT	WP35CT	WM15CT	WM25CT	WM35CT	WK05CT	WK15CT	WK20CT	WS10PT	WS25PT	WU10HT	WU05PT	WP20TT	THM	TTR	WM20CT	WU10PT	WU25PT			
SCMT09T304MP	SCMT3251MP	9,53	3/8	9,53	.375	3,97	5/32	0,4	1/64	4,40	.173																							
SCMT09T308MP	SCMT3252MP	9,53	3/8	9,53	.375	3,97	5/32	0,8	1/32	4,40	.173																							
SCMT120404MP	SCMT431MP	12,70	1/2	12,70	.500	4,76	3/16	0,4	1/64	5,50	.217																							
SCMT120408MP	SCMT432MP	12,70	1/2	12,70	.500	4,76	3/16	0,8	1/32	5,50	.217																							
SCMT120412MP	SCMT433MP	12,70	1/2	12,70	.500	4,76	3/16	1,2	3/64	5,50	.217																							

## SCMT-MU • Medium Universal

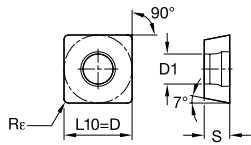
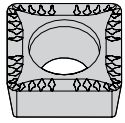

● first choice  
○ alternate choice

ISO catalog number	ANSI catalog number	D		L10		S		Rε		D1		WP05CT	WP15CT	WP25CT	WP35CT	WM15CT	WM25CT	WM35CT	WK05CT	WK15CT	WK20CT	WS10PT	WS25PT	WU10HT	WU05PT	WP20TT	THM	TTR	WM20CT	WU10PT	WU25PT	
		mm	in	mm	in	mm	in	mm	in	mm	in																					
SCMT090308MU	SCMT322MU	9,53	3/8	9,53	.375	3,18	1/8	0,8	1/32	4,40	.173	●	●	●	●	○	○	○	○	○	○	○	○	○	○	○	○	○	○	○	○	○
SCMT09T304MU	SCMT3251MU	9,53	3/8	9,53	.375	3,97	5/32	0,4	1/64	4,40	.173	○	○	○	○	○	○	○	○	○	○	○	○	○	○	○	○	○	○	○	○	
SCMT09T308MU	SCMT3252MU	9,53	3/8	9,53	.375	3,97	5/32	0,8	1/32	4,40	.173	○	○	○	○	○	○	○	○	○	○	○	○	○	○	○	○	○	○	○	○	
SCMT120408MU	SCMT432MU	12,70	1/2	12,70	.500	4,76	3/16	0,8	1/32	5,50	.217	○	○	○	○	○	○	○	○	○	○	○	○	○	○	○	○	○	○	○	○	
SCMT120412MU	SCMT433MU	12,70	1/2	12,70	.500	4,76	3/16	1,2	3/64	5,50	.217	○	○	○	○	○	○	○	○	○	○	○	○	○	○	○	○	○	○	○	○	

## SCMT-1P • Finishing

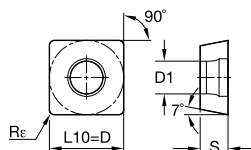
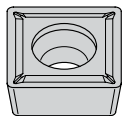

● first choice  
○ alternate choice

ISO catalog number	ANSI catalog number	D		L10		S		Rε		D1		WP05CT	WP15CT	WP25CT	WP35CT	WM15CT	WM25CT	WM35CT	WK05CT	WK15CT	WK20CT	WS10PT	WS25PT	WU10HT	WU05PT	WP20TT	THM	TTR	WM20CT	WU10PT	WU25PT	
		mm	in	mm	in	mm	in	mm	in	mm	in																					
SCMT1204081P	SCMT4321P	12,70	1/2	12,70	.500	4,76	3/16	0,8	1/32	5,50	.217	○	○	○	○	○	○	○	○	○	○	○	○	○	○	○	○	○	○	○	○	○

## SCMW • Medium Machining

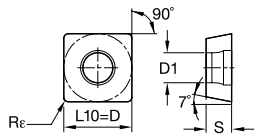
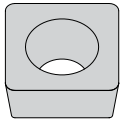

● first choice  
○ alternate choice

P	M	K	N	S	H	WP05CT	WP15CT	WP25CT	WP35CT	WM15CT	WM25CT	WM35CT	WK05CT	WK15CT	WK20CT	WS10PT	WS25PT	WU10HT	WU05PT	WP20TT	THM	TTR	WM20CT	WU10PT	WU25PT
●	●	●	○	○	○	●	●	○	○	○	○	○	○	○	○	○	○	○	○	○	○	○	○	○	○
●	●	○	○	○	○	●	●	○	○	○	○	○	○	○	○	○	○	○	○	○	○	○	○	○	○
○	○	○	○	○	○	○	○	○	○	○	○	○	○	○	○	○	○	○	○	○	○	○	○	○	○
○	○	○	○	○	○	○	○	○	○	○	○	○	○	○	○	○	○	○	○	○	○	○	○	○	○
○	○	○	○	○	○	○	○	○	○	○	○	○	○	○	○	○	○	○	○	○	○	○	○	○	○

ISO catalog number	ANSI catalog number	D		L10		S		Rε		D1	
		mm	in	mm	in	mm	in	mm	in	mm	in
SCMW090304	SCMW321	9,53	3/8	9,53	.375	3,18	1/8	0,4	1/64	4,40	.173
SCMW09T308	SCMW3252	9,53	3/8	9,53	.375	3,97	5/32	0,8	1/32	4,40	.173
SCMW120408	SCMW432	12,70	1/2	12,70	.500	4,76	3/16	0,8	1/32	5,50	.217

## SNGG-FS • Finishing Sharp

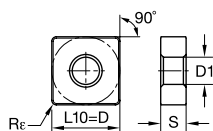
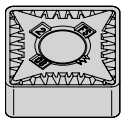

● first choice  
○ alternate choice

P	M	K	N	S	H	WP05CT	WP15CT	WP25CT	WP35CT	WM15CT	WM25CT	WM35CT	WK05CT	WK15CT	WK20CT	WS10PT	WS25PT	WU10HT	WU05PT	WP20TT	THM	TTR	WM20CT	WU10PT	WU25PT
●	●	●	○	○	○	●	●	○	○	○	○	○	○	○	○	○	○	○	○	○	○	○	○	○	○
○	○	○	○	○	○	○	○	○	○	○	○	○	○	○	○	○	○	○	○	○	○	○	○	○	○
○	○	○	○	○	○	○	○	○	○	○	○	○	○	○	○	○	○	○	○	○	○	○	○	○	○
○	○	○	○	○	○	○	○	○	○	○	○	○	○	○	○	○	○	○	○	○	○	○	○	○	○

ISO catalog number	ANSI catalog number	D		L10		S		Rε		D1	
		mm	in	mm	in	mm	in	mm	in	mm	in
SNGG120408FS	SNGG432FS	12,70	1/2	12,70	.500	4,76	3/16	0,8	1/32	5,16	.203

## SNMA • Roughing

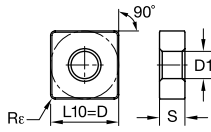
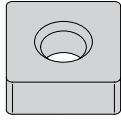

● first choice

○ alternate choice

	P	M	K	N	S	H
WP05CT	●	●	●	○	○	○
WP15CT	○	○	○	○	○	○
WP25CT	○	○	○	○	○	○
WP35CT	○	○	○	○	○	○
WM15CT	○	○	○	○	○	○
WM25CT	○	○	○	○	○	○
WM35CT	○	○	○	○	○	○
WK05CT	○	○	○	○	○	○
WK15CT	○	○	○	○	○	○
WK20CT	○	○	○	○	○	○
WS10PT	○	○	○	○	○	○
WS25PT	○	○	○	○	○	○
WU10HT	○	○	○	○	○	○
WU05PT	○	○	○	○	○	○
WP20TT	○	○	○	○	○	○
THM	○	○	○	○	○	○
TTR	○	○	○	○	○	○
WM20CT	○	○	○	○	○	○
WU10PT	○	○	○	○	○	○
WU25PT	○	○	○	○	○	○

ISO catalog number	ANSI catalog number	D mm	D in	L10 mm	L10 in	S mm	S in	Re mm	Re in	D1 mm	D1 in	WP05CT	WP15CT	WP25CT	WP35CT	WM15CT	WM25CT	WM35CT	WK05CT	WK15CT	WK20CT	WS10PT	WS25PT	WU10HT	WU05PT	WP20TT	THM	TTR	WM20CT	WU10PT	WU25PT				
SNMA120408	SNMA120408	12,70	1/2	12,70	.500	4,76	3/16	0,8	1/32	5,16	.203																								
SNMA120408	SNMA432	12,70	1/2	12,70	.500	4,76	3/16	0,8	1/32	5,16	.203								4171640	6287926	4171882							2028371	2560030						
SNMA120412	SNMA433	12,70	1/2	12,70	.500	4,76	3/16	1,2	3/64	5,16	.203								4171641	6287927	4171883														
SNMA120416	SNMA434	12,70	1/2	12,70	.500	4,76	3/16	1,6	1/16	5,16	.203									4171884	4171883														
SNMA150608	SNMA542	15,88	5/8	15,88	.625	6,35	1/4	0,8	1/32	6,35	.250										4171885	4171885													
SNMA150612	SNMA543	15,88	5/8	15,88	.625	6,35	1/4	1,2	3/64	6,35	.250										4171886	4171886													
SNMA150616	SNMA544	15,88	5/8	15,88	.625	6,35	1/4	1,6	1/16	6,35	.250								4171644	4171644	4171887	4171887													
SNMA190612	SNMA643	19,05	3/4	19,05	.750	6,35	1/4	1,2	3/64	7,93	.313								4171645	4171645	4171888	4171888													
SNMA190616	SNMA644	19,05	3/4	19,05	.750	6,35	1/4	1,6	1/16	7,93	.313								4171646	4171646	4171889	4171889													
SNMA250724	SNMA250724	25,40	1	25,40	1.000	7,94	5/16	2,4	3/32	9,12	.359																				2559949				
SNMA250724	SNMA856	25,40	1	25,40	1.000	7,94	5/16	2,4	3/32	9,12	.359																			2559959					

## SNMG • Roughing

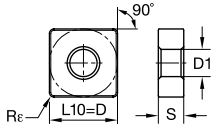
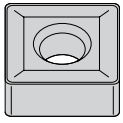

● first choice  
○ alternate choice

P	M	K	N	S	H	WP05CT	WP15CT	WP25CT	WP35CT	WM15CT	WM25CT	WM35CT	WK05CT	WK15CT	WK20CT	WS10PT	WS25PT	WU10HT	WU05PT	WP20TT	THM	TTR	WM20CT	WU10PT	WU25PT	
●	●	○	○	○	○	○	○	○	○	○	○	○	○	○	○	○	○	○	○	○	○	○	○	○	○	○
●	●	○	○	○	○	○	○	○	○	○	○	○	○	○	○	○	○	○	○	○	○	○	○	○	○	
○	○	○	○	○	○	○	○	○	○	○	○	○	○	○	○	○	○	○	○	○	○	○	○	○	○	
○	○	○	○	○	○	○	○	○	○	○	○	○	○	○	○	○	○	○	○	○	○	○	○	○	○	
○	○	○	○	○	○	○	○	○	○	○	○	○	○	○	○	○	○	○	○	○	○	○	○	○	○	

ISO catalog number	ANSI catalog number	D		L10		S		Rε		D1		WP05CT	WP15CT	WP25CT	WP35CT	WM15CT	WM25CT	WM35CT	WK05CT	WK15CT	WK20CT	WS10PT	WS25PT	WU10HT	WU05PT	WP20TT	THM	TTR	WM20CT	WU10PT	WU25PT
		mm	in	mm	in	mm	in	mm	in	mm	in																				
SNMG120408	SNMG120408	12,70	1/2	12,70	.500	4,76	3/16	0,8	1/32	5,16	.203	●	●	●	●	○	○	○	○	○	○	○	○	○	○	○	○	○	○	○	○
SNMG190612	SNMG190612	19,05	3/4	19,05	.750	6,35	1/4	1,2	3/64	7,93	.313	●	●	●	●	○	○	○	○	○	○	○	○	○	○	○	○	○	○	○	○
SNMG120408	SNMG432	12,70	1/2	12,70	.500	4,76	3/16	0,8	1/32	5,16	.203	●	●	●	●	○	○	○	○	○	○	○	○	○	○	○	○	○	○	○	○
SNMG250724	SNMG856	25,40	1	25,40	1.000	7,94	5/16	2,4	3/32	9,12	.359	●	●	●	●	○	○	○	○	○	○	○	○	○	○	○	○	○	○	○	○
SNMG250924	SNMG866	25,40	1	25,40	1.000	9,53	3/8	2,4	3/32	9,12	.359	●	●	●	●	○	○	○	○	○	○	○	○	○	○	○	○	○	○	○	○

INDEXABLE MILLING

SOLID END MILLING

HOLE/MAKING

TAPPING

TURNING

## SNMG-FF • Fine Finishing

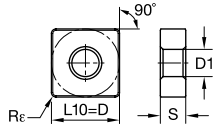
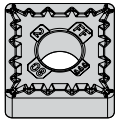

● first choice  
○ alternate choice

	P	M	K	N	S	H																
P	●	●	●	○	○	○	○	○	○	○	○	○	○	○	○	○	○	○	○	○	○	○
M	●	●	○	○	○	○	○	○	○	○	○	○	○	○	○	○	○	○	○	○	○	○
K	○	○	○	○	○	○	○	○	○	○	○	○	○	○	○	○	○	○	○	○	○	○
N	○	○	○	○	○	○	○	○	○	○	○	○	○	○	○	○	○	○	○	○	○	○
S	○	○	○	○	○	○	○	○	○	○	○	○	○	○	○	○	○	○	○	○	○	○
H	○	○	○	○	○	○	○	○	○	○	○	○	○	○	○	○	○	○	○	○	○	○

ISO catalog number	ANSI catalog number	D		L10		S		Rε		D1		WP05CT	WP15CT	WP25CT	WP35CT	WM15CT	WM25CT	WM35CT	WK05CT	WK15CT	WK20CT	WS10PT	WS25PT	WU10HT	WU05PT	WP20TT	THM	TTR	WM20CT	WU10PT	WU25PT	
		mm	in	mm	in	mm	in	mm	in	mm	in																					
SNMG090308FF	SNMG322FF	9,53	3/8	9,53	.375	3,18	1/8	0,8	1/32	3,81	.150	✓	✓	✓	✓	✓	✓	✓	✓	✓	✓	✓	○	○	○	○	○	○	○	○	○	
SNMG120404FF	SNMG431FF	12,70	1/2	12,70	.500	4,76	3/16	0,4	1/64	5,16	.203	✓	✓	✓	✓	✓	✓	✓	✓	✓	✓	✓	✓	✓	✓	✓	✓	✓	✓	✓	✓	
SNMG120408FF	SNMG432FF	12,70	1/2	12,70	.500	4,76	3/16	0,8	1/32	5,16	.203	✓	✓	✓	✓	✓	✓	✓	✓	✓	✓	✓	✓	✓	✓	✓	✓	✓	✓	✓	✓	✓
SNMG120412FF	SNMG433FF	12,70	1/2	12,70	.500	4,76	3/16	1,2	3/64	5,16	.203	✓	✓	✓	✓	✓	✓	✓	✓	✓	✓	✓	✓	✓	✓	✓	✓	✓	✓	✓	✓	✓

## SNMG-ML • Medium Machining

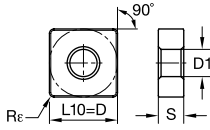
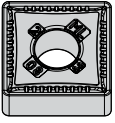

● first choice  
○ alternate choice

P	●	●	●	●	○	○	○	○	○	○	○	○	○	○	○	○	○	○	○	○	○	○	○
M	○	○	○	○	○	○	○	○	○	○	○	○	○	○	○	○	○	○	○	○	○	○	○
K	○	○	○	○	○	○	○	○	○	○	○	○	○	○	○	○	○	○	○	○	○	○	○
N	○	○	○	○	○	○	○	○	○	○	○	○	○	○	○	○	○	○	○	○	○	○	○
S	○	○	○	○	○	○	○	○	○	○	○	○	○	○	○	○	○	○	○	○	○	○	○
H	○	○	○	○	○	○	○	○	○	○	○	○	○	○	○	○	○	○	○	○	○	○	○

ISO catalog number	ANSI catalog number	D		L10		S		Rε		D1		WP05CT	WP15CT	WP25CT	WP35CT	WM15CT	WM25CT	WM35CT	WK05CT	WK15CT	WK20CT	WS10PT	WS25PT	WU10HT	WU05PT	WP20TT	THM	TTR	WM20CT	WU10PT	WU25PT		
		mm	in	mm	in	mm	in	mm	in	mm	in																						
SNMG090304ML	SNMG321ML	9,53	3/8	9,53	.375	3,18	1/8	0,4	1/64	3,81	.150																						
SNMG090308ML	SNMG322ML	9,53	3/8	9,53	.375	3,18	1/8	0,8	1/32	3,81	.150		4171072	4170488																			
SNMG120404ML	SNMG431ML	12,70	1/2	12,70	.500	4,76	3/16	0,4	1/64	5,16	.203																						
SNMG120408ML	SNMG432ML	12,70	1/2	12,70	.500	4,76	3/16	0,8	1/32	5,16	.203		4171073	4170489																			
SNMG120412ML	SNMG433ML	12,70	1/2	12,70	.500	4,76	3/16	1,2	3/64	5,16	.203		4171074	4170490																			

INDEXABLE MILLING

SOLID END MILLING

HOLEMAKING

TAPPING

TURNING





### SNMG-MS • Medium Sharp

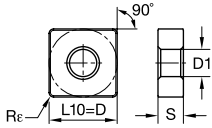

● first choice  
○ alternate choice

P	●	●	●	●	○	○	○	○	○	○	○	○	○	○	○	○	○	○	○	○	○	○	○	○	○
M	●	●	○	○	○	○	○	○	○	○	○	○	○	○	○	○	○	○	○	○	○	○	○	○	○
K	○	○	○	○	○	○	○	○	○	○	○	○	○	○	○	○	○	○	○	○	○	○	○	○	○
N	○	○	○	○	○	○	○	○	○	○	○	○	○	○	○	○	○	○	○	○	○	○	○	○	○
S	○	○	○	○	○	○	○	○	○	○	○	○	○	○	○	○	○	○	○	○	○	○	○	○	○
H	○	○	○	○	○	○	○	○	○	○	○	○	○	○	○	○	○	○	○	○	○	○	○	○	○

ISO catalog number	ANSI catalog number	D		L10		S		Rc		D1		WP05CT	WP15CT	WP25CT	WP35CT	WM15CT	WM25CT	WM35CT	WK05CT	WK15CT	WK20CT	WS10PT	WS25PT	WU10HT	WU05PT	WP20TT	THM	TTR	WM20CT	WU10PT	WU25PT	
		mm	in	mm	in	mm	in	mm	in	mm	in																					
SNMG120408MS	SNMG432MS	12,70	1/2	12,70	.500	4,76	3/16	0,8	1/32	5,16	.203	•	•	•	•	•	•	•	•	•	•	•	•	•	•	•	•	•	•	•	•	
SNMG120412MS	SNMG433MS	12,70	1/2	12,70	.500	4,76	3/16	1,2	3/64	5,16	.203	•	•	•	•	•	•	•	•	•	•	•	•	•	•	•	•	•	•	•	•	
SNMG120416MS	SNMG434MS	12,70	1/2	12,70	.500	4,76	3/16	1,6	1/16	5,16	.203	•	•	•	•	•	•	•	•	•	•	•	•	•	•	•	•	•	•	•	•	
SNMG150612MS	SNMG543MS	15,88	5/8	15,88	.625	6,35	1/4	1,2	3/64	6,35	.250	•	•	•	•	•	•	•	•	•	•	•	•	•	•	•	•	•	•	•	•	
SNMG190612MS	SNMG643MS	19,05	3/4	19,05	.750	6,35	1/4	1,2	3/64	7,93	.313	•	•	•	•	•	•	•	•	•	•	•	•	•	•	•	•	•	•	•	•	
SNMG190616MS	SNMG644MS	19,05	3/4	19,05	.750	6,35	1/4	1,6	1/16	7,94	.312	•	•	•	•	•	•	•	•	•	•	•	•	•	•	•	•	•	•	•	•	•

INDEXABLE MILLING

SOLID END MILLING

HOLEMAKING

TAPPING

TURNING

## SNMG-RH • Roughing

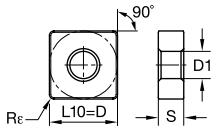
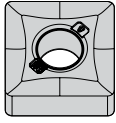

● first choice

○ alternate choice

P	●	●	●	●	●	●	●	●	●	●	●	●	●	●	●	●	●	●	●
M	●	●	●	●	●	●	●	●	●	●	●	●	●	●	●	●	●	●	●
K	○	○	○	○	○	○	○	○	○	○	○	○	○	○	○	○	○	○	○
N	○	○	○	○	○	○	○	○	○	○	○	○	○	○	○	○	○	○	○
S	○	○	○	○	○	○	○	○	○	○	○	○	○	○	○	○	○	○	○
H	○	○	○	○	○	○	○	○	○	○	○	○	○	○	○	○	○	○	○

ISO catalog number	ANSI catalog number	D		L10		S		Re		D1																															
		mm	in	mm	in	mm	in	mm	in	mm	in	WP05CT	WP15CT	WP25CT	WP35CT	WM15CT	WM25CT	WM35CT	WK05CT	WK15CT	WK20CT	WS10PT	WS25PT	WU10HT	WU05PT	WP20TT	THM	TTR	WM20CT	WU10PT	WU25PT										
SNMG120408RH	SNMG432RH	12,70	1/2	12,70	.500	4,76	3/16	0,8	1/32	5,16	.203	●	●	●	○	○	○	○	○	○	○	○	○	○	○	○	○	○	○	○	○	○	○	○							
SNMG120412RH	SNMG433RH	12,70	1/2	12,70	.500	4,76	3/16	1,2	3/64	5,16	.203	●	●	●	○	○	○	○	○	○	○	○	○	○	○	○	○	○	○	○	○	○	○	○	○						
SNMG120416RH	SNMG434RH	12,70	1/2	12,70	.500	4,76	3/16	1,6	1/16	5,16	.203	●	●	●	○	○	○	○	○	○	○	○	○	○	○	○	○	○	○	○	○	○	○	○	○	○					
SNMG150608RH	SNMG542RH	15,88	5/8	15,88	.625	6,35	1/4	0,8	1/32	6,35	.250	●	●	●	○	○	○	○	○	○	○	○	○	○	○	○	○	○	○	○	○	○	○	○	○	○	○				
SNMG150612RH	SNMG543RH	15,88	5/8	15,88	.625	6,35	1/4	1,2	3/64	6,35	.250	●	●	●	○	○	○	○	○	○	○	○	○	○	○	○	○	○	○	○	○	○	○	○	○	○	○	○			
SNMG150616RH	SNMG544RH	15,88	5/8	15,88	.625	6,35	1/4	1,6	1/16	6,35	.250	●	●	●	○	○	○	○	○	○	○	○	○	○	○	○	○	○	○	○	○	○	○	○	○	○	○	○	○		
SNMG190608RH	SNMG642RH	19,05	3/4	19,05	.750	6,35	1/4	0,8	1/32	7,93	.313	●	●	●	○	○	○	○	○	○	○	○	○	○	○	○	○	○	○	○	○	○	○	○	○	○	○	○	○		
SNMG190612RH	SNMG643RH	19,05	3/4	19,05	.750	6,35	1/4	1,2	3/64	7,93	.313	●	●	●	○	○	○	○	○	○	○	○	○	○	○	○	○	○	○	○	○	○	○	○	○	○	○	○	○	○	
SNMG190616RH	SNMG644RH	19,05	3/4	19,05	.750	6,35	1/4	1,6	1/16	7,93	.313	●	●	●	○	○	○	○	○	○	○	○	○	○	○	○	○	○	○	○	○	○	○	○	○	○	○	○	○	○	○

### SNMG-UF • Fine Finishing

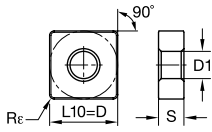
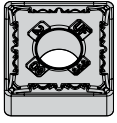

● first choice  
○ alternate choice

ISO catalog number	ANSI catalog number	D		L10		S		Rr		D1		WP05CT	WP15CT	WP25CT	WP35CT	WM15CT	WM25CT	WM35CT	WK05CT	WK15CT	WK20CT	WS10PT	WS25PT	WU10HT	WU05PT	WP20TT	THM	TTR	WM20CT	WU10PT	WU25PT	
		mm	in	mm	in	mm	in	mm	in	mm	in																					
SNMG120404UF	SNMG431UF	12,70	1/2	12,70	.500	4,76	3/16	0,4	1/64	5,16	.203																					
SNMG120408UF	SNMG432UF	12,70	1/2	12,70	.500	4,76	3/16	0,8	1/32	5,16	.203																					

P	●	●	●	●	○	○	○	○	○	○	○	○	○	○	○	○	○	○	○	○	○	○	○	○	○	○	○	○	○	○	○
M	●	●	●	●	○	○	○	○	○	○	○	○	○	○	○	○	○	○	○	○	○	○	○	○	○	○	○	○	○	○	○
K	○	○	○	○	○	○	○	○	○	○	○	○	○	○	○	○	○	○	○	○	○	○	○	○	○	○	○	○	○	○	○
N	○	○	○	○	○	○	○	○	○	○	○	○	○	○	○	○	○	○	○	○	○	○	○	○	○	○	○	○	○	○	○
S	○	○	○	○	○	○	○	○	○	○	○	○	○	○	○	○	○	○	○	○	○	○	○	○	○	○	○	○	○	○	○
H	○	○	○	○	○	○	○	○	○	○	○	○	○	○	○	○	○	○	○	○	○	○	○	○	○	○	○	○	○	○	○

### SNMG-UM • Medium Machining

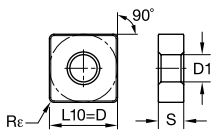
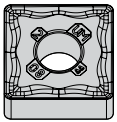

● first choice  
○ alternate choice

ISO catalog number	ANSI catalog number	D		L10		S		Rr		D1		WP05CT	WP15CT	WP25CT	WP35CT	WM15CT	WM25CT	WM35CT	WK05CT	WK15CT	WK20CT	WS10PT	WS25PT	WU10HT	WU05PT	WP20TT	THM	TTR	WM20CT	WU10PT	WU25PT	
		mm	in	mm	in	mm	in	mm	in	mm	in																					
SNMG120404UM	SNMG431UM	12,70	1/2	12,70	.500	4,76	3/16	0,4	1/64	5,16	.203																					
SNMG120408UM	SNMG432UM	12,70	1/2	12,70	.500	4,76	3/16	0,8	1/32	5,16	.203																					
SNMG120412UM	SNMG433UM	12,70	1/2	12,70	.500	4,76	3/16	1,2	3/64	5,16	.203																					

P	●	●	●	●	○	○	○	○	○	○	○	○	○	○	○	○	○	○	○	○	○	○	○	○	○	○	○	○	○	○	○
M	●	●	●	●	○	○	○	○	○	○	○	○	○	○	○	○	○	○	○	○	○	○	○	○	○	○	○	○	○	○	○
K	○	○	○	○	○	○	○	○	○	○	○	○	○	○	○	○	○	○	○	○	○	○	○	○	○	○	○	○	○	○	○
N	○	○	○	○	○	○	○	○	○	○	○	○	○	○	○	○	○	○	○	○	○	○	○	○	○	○	○	○	○	○	○
S	○	○	○	○	○	○	○	○	○	○	○	○	○	○	○	○	○	○	○	○	○	○	○	○	○	○	○	○	○	○	○
H	○	○	○	○	○	○	○	○	○	○	○	○	○	○	○	○	○	○	○	○	○	○	○	○	○	○	○	○	○	○	○

## SNMG-UR • Universal Roughing

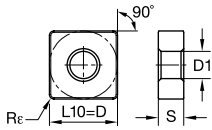
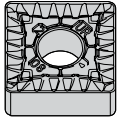

● first choice  
○ alternate choice

P	M	K	N	S	H	WP05CT	WP15CT	WP25CT	WP35CT	WM15CT	WM25CT	WM35CT	WK05CT	WK15CT	WK20CT	WS10PT	WS25PT	WU10HT	WU05PT	WP20TT	THM	TTR	WM20CT	WU10PT	WU25PT	
●	●	●	●	●	●	○	○	○	○	○	○	○	○	○	○	○	○	○	○	○	○	○	○	○	○	○
○	○	○	○	○	○	○	○	○	○	○	○	○	○	○	○	○	○	○	○	○	○	○	○	○	○	○
○	○	○	○	○	○	○	○	○	○	○	○	○	○	○	○	○	○	○	○	○	○	○	○	○	○	○
○	○	○	○	○	○	○	○	○	○	○	○	○	○	○	○	○	○	○	○	○	○	○	○	○	○	○
○	○	○	○	○	○	○	○	○	○	○	○	○	○	○	○	○	○	○	○	○	○	○	○	○	○	○

ISO catalog number	ANSI catalog number	D		L10		S		Rr		D1		WP05CT	WP15CT	WP25CT	WP35CT	WM15CT	WM25CT	WM35CT	WK05CT	WK15CT	WK20CT	WS10PT	WS25PT	WU10HT	WU05PT	WP20TT	THM	TTR	WM20CT	WU10PT	WU25PT	
		mm	in	mm	in	mm	in	mm	in	mm	in																					
SNMG120408UR	SNMG432UR	12,70	1/2	12,70	.500	4,76	3/16	0,8	1/32	5,16	.203	○	○	○	○	○	○	○	○	○	○	○	○	○	○	○	○	○	○	○	○	
SNMG120412UR	SNMG433UR	12,70	1/2	12,70	.500	4,76	3/16	1,2	3/64	5,16	.203	○	○	○	○	○	○	○	○	○	○	○	○	○	○	○	○	○	○	○	○	
SNMG120416UR	SNMG434UR	12,70	1/2	12,70	.500	4,76	3/16	1,6	1/16	5,16	.203	○	○	○	○	○	○	○	○	○	○	○	○	○	○	○	○	○	○	○	○	○
SNMG150612UR	SNMG543UR	15,88	5/8	15,88	.625	6,35	1/4	1,2	3/64	6,35	.250	○	○	○	○	○	○	○	○	○	○	○	○	○	○	○	○	○	○	○	○	○
SNMG150616UR	SNMG544UR	15,88	5/8	15,88	.625	6,35	1/4	1,6	1/16	6,35	.250	○	○	○	○	○	○	○	○	○	○	○	○	○	○	○	○	○	○	○	○	○
SNMG190612UR	SNMG643UR	19,05	3/4	19,05	.750	6,35	1/4	1,2	3/64	7,93	.313	○	○	○	○	○	○	○	○	○	○	○	○	○	○	○	○	○	○	○	○	○
SNMG190616UR	SNMG644UR	19,05	3/4	19,05	.750	6,35	1/4	1,6	1/16	7,93	.313	○	○	○	○	○	○	○	○	○	○	○	○	○	○	○	○	○	○	○	○	○

**SNMM-8 • Heavy Roughing**

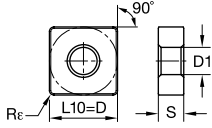

● first choice  
○ alternate choice

P	M	K	N	S	H	WP05CT	WP15CT	WP25CT	WP35CT	WM15CT	WM25CT	WM35CT	WK05CT	WK15CT	WK20CT	WS10PT	WS25PT	WU10HT	WU05PT	WP20TT	THM	TTR	WM20CT	WU10PT	WU25PT	
●	●	●	●	●	●	●	●	●	●	●	●	●	○	○	○	○	○	○	○	○	○	○	○	○	○	○
●	●	○	○	○	○	○	○	○	○	○	○	○	○	○	○	○	○	○	○	○	○	○	○	○	○	○
○	○	○	○	○	○	○	○	○	○	○	○	○	○	○	○	○	○	○	○	○	○	○	○	○	○	○
○	○	○	○	○	○	○	○	○	○	○	○	○	○	○	○	○	○	○	○	○	○	○	○	○	○	○
○	○	○	○	○	○	○	○	○	○	○	○	○	○	○	○	○	○	○	○	○	○	○	○	○	○	○
○	○	○	○	○	○	○	○	○	○	○	○	○	○	○	○	○	○	○	○	○	○	○	○	○	○	○

ISO catalog number	ANSI catalog number	D		L10		S		Rε		D1		WP05CT	WP15CT	WP25CT	WP35CT	WM15CT	WM25CT	WM35CT	WK05CT	WK15CT	WK20CT	WS10PT	WS25PT	WU10HT	WU05PT	WP20TT	THM	TTR	WM20CT	WU10PT	WU25PT
mm	in	mm	in	mm	in	mm	in	mm	in	mm	in																				
SNMM2507248	SNMM8568	25,40	1	25,40	1.000	7,94	5/16	2,4	3/32	9,12	.359	○	○	○	○	○	○	○	○	○	○	○	○	○	○	○	○	○	○	○	○

**SNMM-65 • Heavy Roughing**

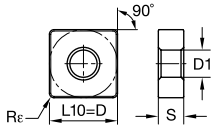
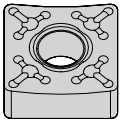

● first choice  
○ alternate choice

P	M	K	N	S	H	WP05CT	WP15CT	WP25CT	WP35CT	WM15CT	WM25CT	WM35CT	WK05CT	WK15CT	WK20CT	WS10PT	WS25PT	WU10HT	WU05PT	WP20TT	THM	TTR	WM20CT	WU10PT	WU25PT	
●	●	○	○	○	○	○	○	○	○	○	○	○	○	○	○	○	○	○	○	○	○	○	○	○	○	○
○	○	○	○	○	○	○	○	○	○	○	○	○	○	○	○	○	○	○	○	○	○	○	○	○	○	○
○	○	○	○	○	○	○	○	○	○	○	○	○	○	○	○	○	○	○	○	○	○	○	○	○	○	○
○	○	○	○	○	○	○	○	○	○	○	○	○	○	○	○	○	○	○	○	○	○	○	○	○	○	○
○	○	○	○	○	○	○	○	○	○	○	○	○	○	○	○	○	○	○	○	○	○	○	○	○	○	○
○	○	○	○	○	○	○	○	○	○	○	○	○	○	○	○	○	○	○	○	○	○	○	○	○	○	○
○	○	○	○	○	○	○	○	○	○	○	○	○	○	○	○	○	○	○	○	○	○	○	○	○	○	○

ISO catalog number	ANSI catalog number	D		L10		S		Rε		D1		WP05CT	WP15CT	WP25CT	WP35CT	WM15CT	WM25CT	WM35CT	WK05CT	WK15CT	WK20CT	WS10PT	WS25PT	WU10HT	WU05PT	WP20TT	THM	TTR	WM20CT	WU10PT	WU25PT		
mm	in	mm	in	mm	in	mm	in	mm	in	mm	in																						
SNMM12040865	SNMM43265	12,70	1/2	12,70	.500	4,76	3/16	0,8	1/32	5,16	.203	○	○	○	○	○	○	○	○	○	○	○	○	○	○	○	○	○	○	○	○		
SNMM12041265	SNMM43365	12,70	1/2	12,70	.500	4,76	3/16	1,2	3/64	5,16	.203	○	○	○	○	○	○	○	○	○	○	○	○	○	○	○	○	○	○	○	○	○	
SNMM15061665	SNMM54465	15,88	5/8	15,88	.625	6,35	1/4	1,6	1/16	6,35	.250	○	○	○	○	○	○	○	○	○	○	○	○	○	○	○	○	○	○	○	○	○	
SNMM19061265	SNMM64365	19,05	3/4	19,05	.750	6,35	1/4	1,2	3/64	7,93	.313	○	○	○	○	○	○	○	○	○	○	○	○	○	○	○	○	○	○	○	○	○	
SNMM19061665	SNMM64465	19,05	3/4	19,05	.750	6,35	1/4	1,6	1/16	7,93	.313	○	○	○	○	○	○	○	○	○	○	○	○	○	○	○	○	○	○	○	○	○	○
SNMM19062465	SNMM64665	19,05	3/4	19,05	.750	6,35	1/4	2,4	3/32	7,93	.313	○	○	○	○	○	○	○	○	○	○	○	○	○	○	○	○	○	○	○	○	○	○

### SNMM-SR • Heavy Roughing

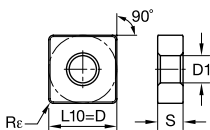
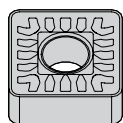

● first choice  
○ alternate choice

ISO catalog number	ANSI catalog number	D		L10		S		Rε		D1		WP05CT	WP15CT	WP25CT	WP35CT	WM15CT	WM25CT	WM35CT	WK05CT	WK15CT	WK20CT	WS10PT	WS25PT	WU10HT	WU05PT	WP20TT	THM	TTR	WM20CT	WU10PT	WU25PT
		mm	in	mm	in	mm	in	mm	in	mm	in																				
<b>SNMM190616SR</b>	<b>SNMM644SR</b>	19,05	3/4	19,05	.750	6,35	1/4	1,6	1/16	7,93	.313	•	•	•	•	•	•	•	•	•	•	•	•	•	•	•	•	•	•	•	•
<b>SNMM190624SR</b>	<b>SNMM646SR</b>	19,05	3/4	19,05	.750	6,35	1/4	2,4	3/32	7,93	.313	•	•	•	•	•	•	•	•	•	•	•	•	•	•	•	•	•	•	•	
<b>SNMM250724SR</b>	<b>SNMM856SR</b>	25,40	1	25,40	1.000	7,94	5/16	2,4	3/32	9,12	.359	•	•	•	•	•	•	•	•	•	•	•	•	•	•	•	•	•	•	•	•
<b>SNMM250924SR</b>	<b>SNMM866SR</b>	25,40	1	25,40	1.000	9,53	3/8	2,4	3/32	9,12	.359	•	•	•	•	•	•	•	•	•	•	•	•	•	•	•	•	•	•	•	•

### SNMP • Medium Machining

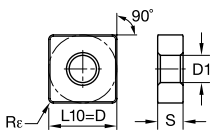
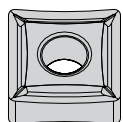

● first choice  
○ alternate choice

ISO catalog number	ANSI catalog number	D		L10		S		Rε		D1		WP05CT	WP15CT	WP25CT	WP35CT	WM15CT	WM25CT	WM35CT	WK05CT	WK15CT	WK20CT	WS10PT	WS25PT	WU10HT	WU05PT	WP20TT	THM	TTR	WM20CT	WU10PT	WU25PT
		mm	in	mm	in	mm	in	mm	in	mm	in																				
<b>SNMP120408</b>	<b>SNMP432</b>	12,70	1/2	12,70	.500	4,76	3/16	0,8	1/32	5,16	.203	•	•	•	•	•	•	•	•	•	•	•	•	•	•	•	•	•	•	•	•
<b>SNMP120412</b>	<b>SNMP433</b>	12,70	1/2	12,70	.500	4,76	3/16	1,2	3/64	5,16	.203	•	•	•	•	•	•	•	•	•	•	•	•	•	•	•	•	•	•	•	•
<b>SNMP150612</b>	<b>SNMP543</b>	15,88	5/8	15,88	.625	6,35	1/4	1,2	3/64	6,35	.250	•	•	•	•	•	•	•	•	•	•	•	•	•	•	•	•	•	•	•	•

## SPGN/SPG • Medium Machining

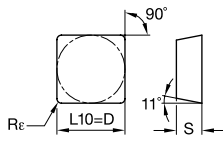
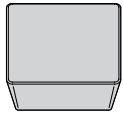

● first choice  
○ alternate choice

	P	M	K	N	S	H																
P	●	●	●	○	○	○	○	○	○	○	○	○	○	○	○	○	○	○	○	○	○	○
M	●	●	○	○	○	○	○	○	○	○	○	○	○	○	○	○	○	○	○	○	○	○
K	○	○	○	○	○	○	○	○	○	○	○	○	○	○	○	○	○	○	○	○	○	○
N	○	○	○	○	○	○	○	○	○	○	○	○	○	○	○	○	○	○	○	○	○	○
S	○	○	○	○	○	○	○	○	○	○	○	○	○	○	○	○	○	○	○	○	○	○
H	○	○	○	○	○	○	○	○	○	○	○	○	○	○	○	○	○	○	○	○	○	○

ISO catalog number	ANSI catalog number	D		L10		S		R <sub>e</sub>		WP05CT	WP15CT	WP25CT	WP35CT	WM15CT	WM25CT	WM35CT	WK05CT	WK15CT	WK20CT	WS10PT	WS25PT	WU10HT	WU05PT	WP20TT	THM	TTR	WM20CT	WU10PT	WU25PT
		mm	in	mm	in	mm	in	mm	in																				
SPGN090308	SPG322	9,53	3/8	9,53	.375	3,18	1/8	0,8	1/32																				

## SPMR • Medium Machining

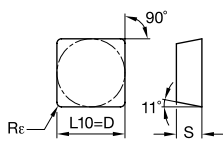
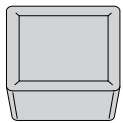

● first choice  
○ alternate choice

	P	M	K	N	S	H																									
P	●	●	○	○	○	○	○	○	○	○	○	○	○	○	○	○	○	○	○	○	○	○	○	○	○	○	○	○	○	○	○
M	●	●	○	○	○	○	○	○	○	○	○	○	○	○	○	○	○	○	○	○	○	○	○	○	○	○	○	○	○	○	○
K	○	○	○	○	○	○	○	○	○	○	○	○	○	○	○	○	○	○	○	○	○	○	○	○	○	○	○	○	○	○	○
N	○	○	○	○	○	○	○	○	○	○	○	○	○	○	○	○	○	○	○	○	○	○	○	○	○	○	○	○	○	○	○
S	○	○	○	○	○	○	○	○	○	○	○	○	○	○	○	○	○	○	○	○	○	○	○	○	○	○	○	○	○	○	○
H	○	○	○	○	○	○	○	○	○	○	○	○	○	○	○	○	○	○	○	○	○	○	○	○	○	○	○	○	○	○	○

ISO catalog number	ANSI catalog number	D		L10		S		R <sub>e</sub>		WP05CT	WP15CT	WP25CT	WP35CT	WM15CT	WM25CT	WM35CT	WK05CT	WK15CT	WK20CT	WS10PT	WS25PT	WU10HT	WU05PT	WP20TT	THM	TTR	WM20CT	WU10PT	WU25PT
		mm	in	mm	in	mm	in	mm	in																				
SPMR120308	SPMR422	12,70	1/2	12,70	.500	3,18	1/8	0,8	1/32		4170854		4170652																



INDEXABLE MILLING

SOLID END MILLING

HOLEMAKING

TAPPING

TURNING

## SPMT-FP • Finishing Positive

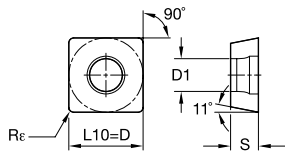
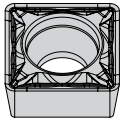

● first choice  
○ alternate choice

ISO catalog number	ANSI catalog number	D		L10		S		Rε		D1		WP05CT	WP15CT	WP25CT	WP35CT	WM15CT	WM25CT	WM35CT	WK05CT	WK15CT	WK20CT	WS10PT	WS25PT	WU10HT	WU05PT	WP20TT	THM	TTR	WM20CT	WU10PT	WU25PT	
		mm	in	mm	in	mm	in	mm	in	mm	in																					
SPMT09T308FP	SPMT3252FP	9,53	3/8	9,53	.375	3,97	5/32	0,8	1/32	4,40	.173	●	●	●	●	○	○	○	○	○	○	○	○	○	○	○	○	○	○	○	○	○

## SPMT-MP • Medium Positive

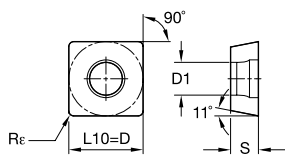

● first choice  
○ alternate choice

ISO catalog number	ANSI catalog number	D		L10		S		Rε		D1		WP05CT	WP15CT	WP25CT	WP35CT	WM15CT	WM25CT	WM35CT	WK05CT	WK15CT	WK20CT	WS10PT	WS25PT	WU10HT	WU05PT	WP20TT	THM	TTR	WM20CT	WU10PT	WU25PT
		mm	in	mm	in	mm	in	mm	in	mm	in																				
SPMT09T308MP	SPMT3252MP	9,53	3/8	9,53	.375	3,97	5/32	0,8	1/32	4,40	.173	●	●	●	●	○	○	○	○	○	○	○	○	○	○	○	○	○	○	○	○
SPMT120408MP	SPMT432MP	12,70	1/2	12,70	.500	4,76	3/16	0,8	1/32	5,50	.217	○	○	○	○	○	○	○	○	○	○	○	○	○	○	○	○	○	○	○	○

SPUN/SPU • Medium Machining

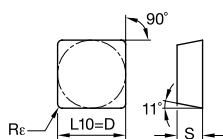
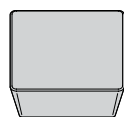

● first choice  
○ alternate choice

P	●	●	●	○	○	○	○	○	○	○	○	○	○	○	○	○	○	○	○	○	○
M	●	●	●	○	○	○	○	○	○	○	○	○	○	○	○	○	○	○	○	○	○
K	○	○	○	○	○	○	○	○	○	○	○	○	○	○	○	○	○	○	○	○	○
N	○	○	○	○	○	○	○	○	○	○	○	○	○	○	○	○	○	○	○	○	○
S	○	○	○	○	○	○	○	○	○	○	○	○	○	○	○	○	○	○	○	○	○
H	○	○	○	○	○	○	○	○	○	○	○	○	○	○	○	○	○	○	○	○	○

ISO catalog number	ANSI catalog number	D		L10		S		Rε																																		
		mm	in	mm	in	mm	in	mm	in	WP05CT	WP15CT	WP25CT	WP35CT	WM15CT	WM25CT	WM35CT	WK05CT	WK15CT	WK20CT	WS10PT	WS25PT	WU10HT	WU05PT	WP20TT	THM	TTR	WM20CT	WU10PT	WU25PT													
SPUN090308	SPU322	9,53	3/8	9,53	.375	3,18	1/8	0,8	1/32	●	●	●	○	○	○	○	○	○	○	○	○	○	○	○	○	○	○	○	○	○	○	○	○	○	○							
SPUN120304	SPU421	12,70	1/2	12,70	.500	3,18	1/8	0,4	1/64	○	○	○	○	○	○	○	○	○	○	○	○	○	○	○	○	○	○	○	○	○	○	○	○	○	○	○						
SPUN120308	SPU422	12,70	1/2	12,70	.500	3,18	1/8	0,8	1/32	○	4170857	○	○	○	○	○	○	○	○	○	○	○	○	○	○	○	○	○	○	○	○	○	○	○	○	○	○					
SPUN120308	SPUN120308	12,70	1/2	12,70	.500	3,18	1/8	0,8	1/32	○	○	○	○	○	○	○	○	○	○	○	○	○	○	○	○	○	○	○	○	○	○	○	○	○	○	○	○	○				
SPUN120312	SPU423	12,70	1/2	12,70	.500	3,18	1/8	1,2	3/64	○	○	○	○	○	○	○	○	○	○	○	○	○	○	○	○	○	○	○	○	○	○	○	○	○	○	○	○	○	○			
SPUN120312	SPUN120312	12,70	1/2	12,70	.500	3,18	1/8	1,2	3/64	○	○	○	○	○	○	○	○	○	○	○	○	○	○	○	○	○	○	○	○	○	○	○	○	○	○	○	○	○	○	○		
SPUN120412	SPU433	12,70	1/2	12,70	.500	4,76	3/16	1,2	3/64	○	○	○	○	○	○	○	○	○	○	○	○	○	○	○	○	○	○	○	○	○	○	○	○	○	○	○	○	○	○	○		
SPUN150412	SPUN533	15,88	5/8	15,88	.625	4,76	3/16	1,2	3/64	○	○	○	○	○	○	○	○	○	○	○	○	○	○	○	○	○	○	○	○	○	○	○	○	○	○	○	○	○	○	○	○	
SPUN190412	SPUN633	19,05	3/4	19,05	.750	4,76	3/16	1,2	3/64	○	○	○	○	○	○	○	○	○	○	○	○	○	○	○	○	○	○	○	○	○	○	○	○	○	○	○	○	○	○	○	○	
SPUN190416	SPU634	19,05	3/4	19,05	.750	4,76	3/16	1,6	1/16	○	○	○	○	○	○	○	○	○	○	○	○	○	○	○	○	○	○	○	○	○	○	○	○	○	○	○	○	○	○	○	○	○

INDEXABLE MILLING

SOLID END MILLING

HOLEMAKING

TAPPING

TURNING

INDEXABLE MILLING

## SPUN-T/SPU-T • Medium Machining

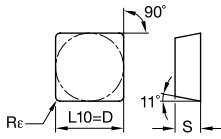
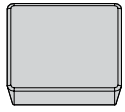

● first choice  
○ alternate choice

ISO catalog number	ANSI catalog number	D		L10		S		R <sub>e</sub>		Material/Grade Selection																										
		mm	in	mm	in	mm	in	mm	in	WP05CT	WP15CT	WP25CT	WP35CT	WM15CT	WM25CT	WM35CT	WK05CT	WK15CT	WK20CT	WS10PT	WS25PT	WU10HT	WU05PT	WP20TT	THM	TTR	WM20CT	WU10PT	WU25PT							
SPUN250620T	SPU845T	25,40	1	25,40	1.000	6,35	1/4	2,0	5/64	•	•	•	•	•	•	•	•	•	•	•	•	•	•	•	•	•	•	•	•	•	•	•	•	•	•	•

SOLID END MILLING

HOLE/REAMING

TAPPING

TURNING

## TCMT • Medium Machining

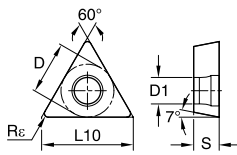
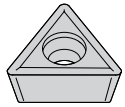

● first choice  
○ alternate choice

ISO catalog number	ANSI catalog number	D		L10		S		R <sub>e</sub>		D1		Material/Grade Selection																								
		mm	in	mm	in	mm	in	mm	in	mm	in	WP05CT	WP15CT	WP25CT	WP35CT	WM15CT	WM25CT	WM35CT	WK05CT	WK15CT	WK20CT	WS10PT	WS25PT	WU10HT	WU05PT	WP20TT	THM	TTR	WM20CT	WU10PT	WU25PT					
TCMT110202	TCMT21505	6,35	1/4	11,00	.433	2,38	3/32	0,2	.008	2,80	.110	•	•	•	•	•	•	•	•	•	•	•	•	•	•	•	•	•	•	•	•	•	•	•		
TCMT110204	TCMT2151	6,35	1/4	11,00	.433	2,38	3/32	0,4	1/64	2,80	.110	•	•	•	•	•	•	•	•	•	•	•	•	•	•	•	•	•	•	•	•	•	•	•	•	
TCMT16T304	TCMT3251	9,53	3/8	16,50	.650	3,97	5/32	0,4	1/64	4,40	.173	•	•	•	•	•	•	•	•	•	•	•	•	•	•	•	•	•	•	•	•	•	•	•	•	
TCMT16T308	TCMT3252	9,53	3/8	16,50	.650	3,97	5/32	0,8	1/32	4,40	.173	•	•	•	•	•	•	•	•	•	•	•	•	•	•	•	•	•	•	•	•	•	•	•	•	•
TCMT220408	TCMT432	12,70	1/2	22,00	.866	4,76	3/16	0,8	1/32	5,50	.217	•	•	•	•	•	•	•	•	•	•	•	•	•	•	•	•	•	•	•	•	•	•	•	•	•





## TCMT-1P • Finishing

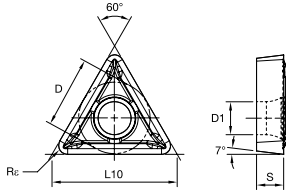
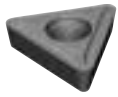

● first choice  
○ alternate choice

	P	M	K	N	S	H																			
P	●	●	●	○	○	○	○	○	○	○	○	○	○	○	○	○	○	○	○	○	○	○	○	○	○
M	●	●	●	○	○	○	○	○	○	○	○	○	○	○	○	○	○	○	○	○	○	○	○	○	○
K	○	○	○	○	○	○	○	○	○	○	○	○	○	○	○	○	○	○	○	○	○	○	○	○	○
N	○	○	○	○	○	○	○	○	○	○	○	○	○	○	○	○	○	○	○	○	○	○	○	○	○
S	○	○	○	○	○	○	○	○	○	○	○	○	○	○	○	○	○	○	○	○	○	○	○	○	○
H	○	○	○	○	○	○	○	○	○	○	○	○	○	○	○	○	○	○	○	○	○	○	○	○	○

ISO catalog number	ANSI catalog number	D		L10		S		Re		D1		WP05CT	WP15CT	WP25CT	WP35CT	WM15CT	WM25CT	WM35CT	WK05CT	WK15CT	WK20CT	WS10PT	WS25PT	WU10HT	WU05PT	WP20TT	THM	TTR	WM20CT	WU10PT	WU25PT	
		mm	in	mm	in	mm	in	mm	in	mm	in																					
TCMT1102041P	TCMT21511P	6,35	1/4	11,00	.433	2,38	3/32	0,4	1/64	2,80	.110	●	●	●	○	○	○	○	○	○	○	○	○	○	○	○	○	○	○	○	○	○
TCMT1102081P	TCMT21521P	6,35	1/4	11,00	.433	2,38	3/32	0,8	1/32	2,80	.110	●	●	●	○	○	○	○	○	○	○	○	○	○	○	○	○	○	○	○	○	○
TCMT16T3041P	TCMT32511P	9,53	3/8	16,50	.650	3,97	5/32	0,4	1/64	4,40	.173	●	●	●	○	○	○	○	○	○	○	○	○	○	○	○	○	○	○	○	○	

## TCMW • Medium Machining

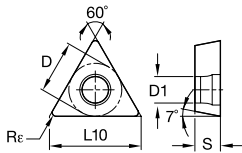
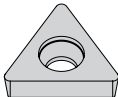

● first choice  
○ alternate choice

	P	M	K	N	S	H																											
P	●	●	●	○	○	○	○	○	○	○	○	○	○	○	○	○	○	○	○	○	○	○	○	○	○	○	○	○	○	○	○	○	○
M	●	●	●	○	○	○	○	○	○	○	○	○	○	○	○	○	○	○	○	○	○	○	○	○	○	○	○	○	○	○	○	○	○
K	○	○	○	○	○	○	○	○	○	○	○	○	○	○	○	○	○	○	○	○	○	○	○	○	○	○	○	○	○	○	○	○	○
N	○	○	○	○	○	○	○	○	○	○	○	○	○	○	○	○	○	○	○	○	○	○	○	○	○	○	○	○	○	○	○	○	○
S	○	○	○	○	○	○	○	○	○	○	○	○	○	○	○	○	○	○	○	○	○	○	○	○	○	○	○	○	○	○	○	○	○
H	○	○	○	○	○	○	○	○	○	○	○	○	○	○	○	○	○	○	○	○	○	○	○	○	○	○	○	○	○	○	○	○	○

ISO catalog number	ANSI catalog number	D		L10		S		Re		D1		WP05CT	WP15CT	WP25CT	WP35CT	WM15CT	WM25CT	WM35CT	WK05CT	WK15CT	WK20CT	WS10PT	WS25PT	WU10HT	WU05PT	WP20TT	THM	TTR	WM20CT	WU10PT	WU25PT
		mm	in	mm	in	mm	in	mm	in	mm	in																				
TCMW110204	TCMW2151	6,35	1/4	11,00	.433	2,38	3/32	0,4	1/64	2,85	.112	●	●	●	○	○	○	○	○	○	○	○	○	○	○	○	○	○	○	○	○
TCMW16T304	TCMW3251	9,53	3/8	16,50	.650	3,97	5/32	0,4	1/64	4,45	.175	●	●	●	○	○	○	○	○	○	○	○	○	○	○	○	○	○	○	○	○

## TNGG-FS • Finishing Sharp

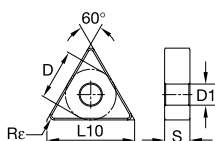
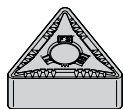

● first choice

○ alternate choice

P	M	K	N	S	H	WP05CT	WP15CT	WP25CT	WP35CT	WM15CT	WM25CT	WM35CT	WK05CT	WK15CT	WK20CT	WS10PT	WS25PT	WU10HT	WU05PT	WP20TT	THM	TTR	WM20CT	WU10PT	WU25PT
●	●	●	●	●	●	●	●	●	●	○	○	○	○	○	○	○	○	○	○	○	○	○	○	○	○
●	○	○	○	○	○	○	○	○	○	○	○	○	○	○	○	○	○	○	○	○	○	○	○	○	○
○	○	○	○	○	○	○	○	○	○	○	○	○	○	○	○	○	○	○	○	○	○	○	○	○	○
○	○	○	○	○	○	○	○	○	○	○	○	○	○	○	○	○	○	○	○	○	○	○	○	○	○
○	○	○	○	○	○	○	○	○	○	○	○	○	○	○	○	○	○	○	○	○	○	○	○	○	○

ISO catalog number	ANSI catalog number	D		L10		S		Re		D1		WP05CT	WP15CT	WP25CT	WP35CT	WM15CT	WM25CT	WM35CT	WK05CT	WK15CT	WK20CT	WS10PT	WS25PT	WU10HT	WU05PT	WP20TT	THM	TTR	WM20CT	WU10PT	WU25PT	
		mm	in	mm	in	mm	in	mm	in	mm	in																					
TNGG160404FS	TNGG331FS	9,53	3/8	16,50	.620	4,76	3/16	0,4	1/64	3,81	.150	●	●	●	●	○	○	○	○	○	○	○	○	○	○	○	○	○	○	○	○	
TNGG220408FS	TNGG432FS	12,70	1/2	22,00	.866	4,76	3/16	0,8	1/32	5,16	.203	●	●	●	●	○	○	○	○	○	○	○	○	○	○	○	○	○	○	○	○	○

## TNMA • Roughing

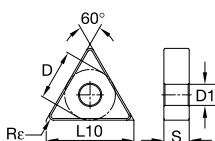
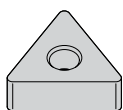

● first choice

○ alternate choice

P	M	K	N	S	H	WP05CT	WP15CT	WP25CT	WP35CT	WM15CT	WM25CT	WM35CT	WK05CT	WK15CT	WK20CT	WS10PT	WS25PT	WU10HT	WU05PT	WP20TT	THM	TTR	WM20CT	WU10PT	WU25PT
●	●	●	●	●	●	●	●	●	●	○	○	○	○	○	○	○	○	○	○	○	○	○	○	○	○
●	○	○	○	○	○	○	○	○	○	○	○	○	○	○	○	○	○	○	○	○	○	○	○	○	○
○	○	○	○	○	○	○	○	○	○	○	○	○	○	○	○	○	○	○	○	○	○	○	○	○	○
○	○	○	○	○	○	○	○	○	○	○	○	○	○	○	○	○	○	○	○	○	○	○	○	○	○
○	○	○	○	○	○	○	○	○	○	○	○	○	○	○	○	○	○	○	○	○	○	○	○	○	○

ISO catalog number	ANSI catalog number	D		L10		S		Re		D1		WP05CT	WP15CT	WP25CT	WP35CT	WM15CT	WM25CT	WM35CT	WK05CT	WK15CT	WK20CT	WS10PT	WS25PT	WU10HT	WU05PT	WP20TT	THM	TTR	WM20CT	WU10PT	WU25PT	
		mm	in	mm	in	mm	in	mm	in	mm	in																					
TNMA160408	TNMA160408	9,53	3/8	16,50	.650	4,76	3/16	0,8	1/32	3,81	.150	●	●	●	●	○	○	○	○	○	○	○	○	○	○	○	○	○	○	○	○	
TNMA160408	TNMA332	9,53	3/8	16,50	.650	4,76	3/16	0,8	1/32	3,81	.150	●	●	●	●	○	○	○	○	○	○	○	○	○	○	○	○	○	○	○	○	
TNMA160412	TNMA333	9,53	3/8	16,50	.650	4,76	3/16	1,2	3/64	3,81	.150	●	●	●	●	○	○	○	○	○	○	○	○	○	○	○	○	○	○	○	○	
TNMA220408	TNMA432	12,70	1/2	22,00	.866	4,76	3/16	0,8	1/32	5,16	.203	●	●	●	●	○	○	○	○	○	○	○	○	○	○	○	○	○	○	○	○	○
TNMA220412	TNMA433	12,70	1/2	22,00	.866	4,76	3/16	1,2	3/64	5,16	.203	●	●	●	●	○	○	○	○	○	○	○	○	○	○	○	○	○	○	○	○	○
TNMA220416	TNMA434	12,70	1/2	22,00	.866	4,76	3/16	1,6	1/16	5,16	.203	●	●	●	●	○	○	○	○	○	○	○	○	○	○	○	○	○	○	○	○	○
TNMA270616	TNMA544	15,88	5/8	27,50	1.083	6,35	1/4	1,6	1/16	6,35	.250	●	●	●	●	○	○	○	○	○	○	○	○	○	○	○	○	○	○	○	○	○

### TNMG • Roughing

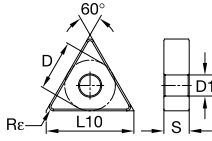
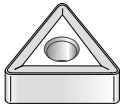

● first choice  
○ alternate choice

ISO catalog number	ANSI catalog number	D		L10		S		Rε		D1		Material Groups																					
		mm	in	mm	in	mm	in	mm	in	mm	in	WP05CT	WP15CT	WP25CT	WP35CT	WM15CT	WM25CT	WM35CT	WK05CT	WK15CT	WK20CT	WS10PT	WS25PT	WU10HT	WU05PT	WP20TT	THM	TTR	WM20CT	WU10PT	WU25PT		
TNMG160404	TNMG160404	9,53	3/8	16,50	.650	4,76	3/16	0,4	1/64	3,81	.150	■	■	■	○	○	○	○	○	○	○	○	○	○	○	○	○	○	○	○	○	○	○
TNMG160408	TNMG160408	9,53	3/8	16,50	.650	4,76	3/16	0,8	1/32	3,81	.150	■	■	■	○	○	○	○	○	○	○	○	○	○	○	○	○	○	○	○	○	○	○
TNMG160404	TNMG331	9,53	3/8	16,50	.650	4,76	3/16	0,4	1/64	3,81	.150	■	■	■	○	○	○	○	○	6671911	■	■	■	○	○	○	○	○	○	○	○	○	
TNMG160408	TNMG332	9,53	3/8	16,50	.650	4,76	3/16	0,8	1/32	3,81	.150	■	■	■	○	○	○	○	○	6671924	■	■	■	○	○	○	○	○	○	○	○	○	
TNMG160412	TNMG333	9,53	3/8	16,50	.650	4,76	3/16	1,2	3/64	3,81	.150	■	■	■	○	○	○	○	○	6671880	■	■	■	○	○	○	○	○	○	○	○	○	

### TNMG-FF • Fine Finishing

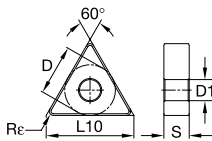
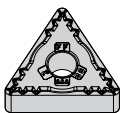

● first choice  
○ alternate choice

ISO catalog number	ANSI catalog number	D		L10		S		Rε		D1		Material Groups																				
		mm	in	mm	in	mm	in	mm	in	mm	in	WP05CT	WP15CT	WP25CT	WP35CT	WM15CT	WM25CT	WM35CT	WK05CT	WK15CT	WK20CT	WS10PT	WS25PT	WU10HT	WU05PT	WP20TT	THM	TTR	WM20CT	WU10PT	WU25PT	
TNMG160404FF	TNMG331FF	9,53	3/8	16,50	.650	4,76	3/16	0,4	1/64	3,81	.150	■	4171050	■	○	○	○	○	○	○	○	○	○	○	○	○	○	○	○	○	○	○
TNMG160408FF	TNMG332FF	9,53	3/8	16,50	.650	4,76	3/16	0,8	1/32	3,81	.150	■	4171051	■	○	○	○	○	○	○	4171385	■	■	■	○	○	○	○	○	○	○	○
TNMG160412FF	TNMG333FF	9,53	3/8	16,50	.650	4,76	3/16	1,2	3/64	3,81	.150	■	4171052	■	○	○	○	○	○	○	4171386	■	■	■	○	○	○	○	○	○	○	○



## TNMG-ML • Medium Machining

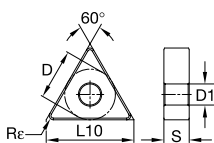
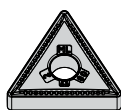

● first choice

○ alternate choice

	P	M	K	N	S	H																				
	●	○	○	○																						
			○	○	○	○																				

ISO catalog number	ANSI catalog number	D		L10		S		Re		D1		WP05CT	WP15CT	WP25CT	WP35CT	WM15CT	WM25CT	WM35CT	WK05CT	WK15CT	WK20CT	WS10PT	WS25PT	WU10HT	WU05PT	WP20TT	THM	TTR	WM20CT	WU10PT	WU25PT		
		mm	in	mm	in	mm	in	mm	in	mm	in																						
TNMG160404ML	TNMG331ML	9,53	3/8	16,50	.650	4,76	3/16	0,4	1/64	3,81	.150																						
TNMG160408ML	TNMG332ML	9,53	3/8	16,50	.650	4,76	3/16	0,8	1/32	3,81	.150																						
TNMG160412ML	TNMG333ML	9,53	3/8	16,50	.650	4,76	3/16	1,2	3/64	3,81	.150																						
TNMG220404ML	TNMG431ML	12,70	1/2	22,00	.866	4,76	3/16	0,4	1/64	5,16	.203																						
TNMG220408ML	TNMG432ML	12,70	1/2	22,00	.866	4,76	3/16	0,8	1/32	5,16	.203																						

### TNMG-MR • Medium Roughing

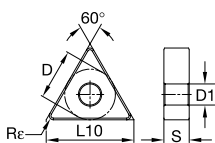

● first choice

○ alternate choice

P	●	●	●	●	○	○	○	○	○	○	○	○	○	○	○	○	○	○	○	○	○	○	○
M	●	●	●	●	○	○	○	○	○	○	○	○	○	○	○	○	○	○	○	○	○	○	○
K	○	○	○	○	○	○	○	○	○	○	○	○	○	○	○	○	○	○	○	○	○	○	○
N	○	○	○	○	○	○	○	○	○	○	○	○	○	○	○	○	○	○	○	○	○	○	○
S	○	○	○	○	○	○	○	○	○	○	○	○	○	○	○	○	○	○	○	○	○	○	○
H	○	○	○	○	○	○	○	○	○	○	○	○	○	○	○	○	○	○	○	○	○	○	○

ISO catalog number	ANSI catalog number	D		L10		S		Rε		D1		WP05CT	WP15CT	WP25CT	WP35CT	WM15CT	WM25CT	WM35CT	WK05CT	WK15CT	WK20CT	WS10PT	WS25PT	WU10HT	WU05PT	WP20TT	THM	TTR	WM20CT	WU10PT	WU25PT	
		mm	in	mm	in	mm	in	mm	in	mm	in																					
TNMG160404MR	TNMG331MR	9,53	3/8	16,50	.650	4,76	3/16	0,4	1/64	3,81	.150	●	○	○	○	○	○	○	○	○	○	○	○	○	○	○	○	○	○	○	○	○
TNMG160408MR	TNMG332MR	9,53	3/8	16,50	.650	4,76	3/16	0,8	1/32	3,81	.150	○	○	○	○	○	○	○	○	○	○	○	○	○	○	○	○	○	○	○	○	○
TNMG160412MR	TNMG333MR	9,53	3/8	16,50	.650	4,76	3/16	1,2	3/64	3,81	.150	○	○	○	○	○	○	○	○	○	○	○	○	○	○	○	○	○	○	○	○	○
TNMG220404MR	TNMG431MR	12,70	1/2	22,00	.866	4,76	3/16	0,4	1/64	5,16	.203	○	○	○	○	○	○	○	○	○	○	○	○	○	○	○	○	○	○	○	○	○
TNMG220408MR	TNMG432MR	12,70	1/2	22,00	.866	4,76	3/16	0,8	1/32	5,16	.203	○	○	○	○	○	○	○	○	○	○	○	○	○	○	○	○	○	○	○	○	○
TNMG220412MR	TNMG433MR	12,70	1/2	22,00	.866	4,76	3/16	1,2	3/64	5,16	.203	○	○	○	○	○	○	○	○	○	○	○	○	○	○	○	○	○	○	○	○	○
TNMG220416MR	TNMG434MR	12,70	1/2	22,00	.866	4,76	3/16	1,6	1/16	5,16	.203	○	○	○	○	○	○	○	○	○	○	○	○	○	○	○	○	○	○	○	○	○

INDEXABLE MILLING

SOLID END MILLING

HOLEMAKING

TAPPING

TURNING



TNMG-RH • Roughing

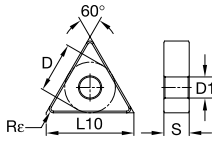

● first choice  
○ alternate choice

P	●	●	●	●	●	○	○	○	○	○	○	○	○	○	○	○	○	○	○	○
M	●	○	○	○	○	○	○	○	○	○	○	○	○	○	○	○	○	○	○	○
K	○	○	○	○	○	○	○	○	○	○	○	○	○	○	○	○	○	○	○	○
N	○	○	○	○	○	○	○	○	○	○	○	○	○	○	○	○	○	○	○	○
S	○	○	○	○	○	○	○	○	○	○	○	○	○	○	○	○	○	○	○	○
H	○	○	○	○	○	○	○	○	○	○	○	○	○	○	○	○	○	○	○	○

ISO catalog number	ANSI catalog number	D		L10		S		Re		D1		WP05CT	WP15CT	WP25CT	WP35CT	WM15CT	WM25CT	WM35CT	WK05CT	WK15CT	WK20CT	WS10PT	WS25PT	WU10HT	WU05PT	WP20TT	THM	TTR	WM20CT	WU10PT	WU25PT
		mm	in	mm	in	mm	in	mm	in	mm	in																				
TNMG160408RH	TNMG332RH	9,53	3/8	16,50	.650	4,76	3/16	0,8	1/32	3,81	.150	•	•	•	•	•	•	•	•	•	•	•	•	•	•	•	•	•	•	•	•
TNMG160412RH	TNMG333RH	9,53	3/8	16,50	.650	4,76	3/16	1,2	3/64	3,81	.150	•	•	•	•	•	•	•	•	•	•	•	•	•	•	•	•	•	•	•	
TNMG220408RH	TNMG432RH	12,70	1/2	22,00	.866	4,76	3/16	0,8	1/32	5,16	.203	•	•	•	•	•	•	•	•	•	•	•	•	•	•	•	•	•	•	•	•
TNMG220412RH	TNMG433RH	12,70	1/2	22,00	.866	4,76	3/16	1,2	3/64	5,16	.203	•	•	•	•	•	•	•	•	•	•	•	•	•	•	•	•	•	•	•	•
TNMG220416RH	TNMG434RH	12,70	1/2	22,00	.866	4,76	3/16	1,6	1/16	5,16	.203	•	•	•	•	•	•	•	•	•	•	•	•	•	•	•	•	•	•	•	•
TNMG270612RH	TNMG543RH	15,88	5/8	27,50	1.083	6,35	1/4	1,2	3/64	6,35	.250	•	•	•	•	•	•	•	•	•	•	•	•	•	•	•	•	•	•	•	•
TNMG270616RH	TNMG544RH	15,88	5/8	27,50	1.083	6,35	1/4	1,6	1/16	6,35	.250	•	•	•	•	•	•	•	•	•	•	•	•	•	•	•	•	•	•	•	•
TNMG330924RH	TNMG666RH	19,05	3/4	33,00	1.299	9,53	3/8	2,4	3/32	7,93	.313	•	•	•	•	•	•	•	•	•	•	•	•	•	•	•	•	•	•	•	•

INDEXABLE MILLING

SOLID END MILLING

HOLE/MAKING

TAPPING

TURNING

## TNMG-RU • Roughing Universal

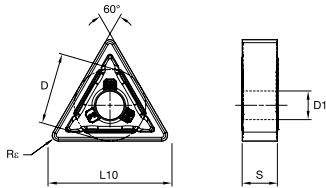
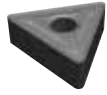

● first choice  
○ alternate choice

ISO catalog number	ANSI catalog number	D		L10		S		Rε		D1		WP05CT	WP15CT	WP25CT	WP35CT	WM15CT	WM25CT	WM35CT	WK05CT	WK15CT	WK20CT	WS10PT	WS25PT	WU10HT	WU05PT	WP20TT	THM	TTR	WM20CT	WU10PT	WU25PT	
		mm	in	mm	in	mm	in	mm	in	mm	in																					
TNMG160408RU	TNMG332RU	9,53	3/8	16,50	.650	4,76	3/16	0,8	1/32	3,81	.150	●	●	●	○	○	○	○	○	○	○	○	○	○	○	○	○	○	○	○	○	○
TNMG160412RU	TNMG333RU	9,53	3/8	16,50	.650	4,76	3/16	1,2	3/64	3,81	.150	○	○	○	○	○	○	○	○	○	○	○	○	○	○	○	○	○	○	○	○	

## TNMG-UF • Fine Finishing

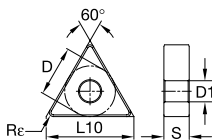
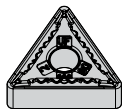

● first choice  
○ alternate choice

ISO catalog number	ANSI catalog number	D		L10		S		Rε		D1		WP05CT	WP15CT	WP25CT	WP35CT	WM15CT	WM25CT	WM35CT	WK05CT	WK15CT	WK20CT	WS10PT	WS25PT	WU10HT	WU05PT	WP20TT	THM	TTR	WM20CT	WU10PT	WU25PT
		mm	in	mm	in	mm	in	mm	in	mm	in																				
TNMG160404UF	TNMG331UF	9,53	3/8	16,50	.650	4,76	3/16	0,4	1/64	3,81	.150	○	○	○	○	○	○	○	○	○	○	○	○	○	○	○	○	○	○	○	○
TNMG160408UF	TNMG332UF	9,53	3/8	16,50	.650	4,76	3/16	0,8	1/32	3,81	.150	○	○	○	○	○	○	○	○	○	○	○	○	○	○	○	○	○	○	○	○
TNMG220404UF	TNMG431UF	12,70	1/2	22,00	.866	4,76	3/16	0,4	1/64	5,16	.203	○	○	○	○	○	○	○	○	○	○	○	○	○	○	○	○	○	○	○	○
TNMG220408UF	TNMG432UF	12,70	1/2	22,00	.866	4,76	3/16	0,8	1/32	5,16	.203	○	○	○	○	○	○	○	○	○	○	○	○	○	○	○	○	○	○	○	○



INDEXABLE MILLING

SOLID END MILLING

HOLEMAKING

TAPPING

TURNING

## TNMG-UR • Universal Roughing

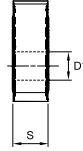
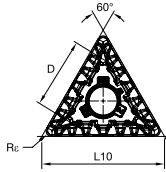
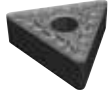

● first choice  
○ alternate choice

ISO catalog number	ANSI catalog number	D		L10		S		R <sub>ε</sub>		D1		WP05CT	WP15CT	WP25CT	WP35CT	WM15CT	WM25CT	WM35CT	WK05CT	WK15CT	WK20CT	WS10PT	WS25PT	WU10HT	WU05PT	WP20TT	T-HM	T-TR	WM20CT	WU10PT	WU25PT	
		mm	in	mm	in	mm	in	mm	in	mm	in																					
TNMG160408UR	TNMG332UR	9,53	3/8	16,50	.650	4,76	3/16	0,8	1/32	3,81	.150	●	●	●	○	○	○	○	○	○	○	○	○	○	○	○	○	○	○	○	○	○
TNMG160412UR	TNMG333UR	9,53	3/8	16,50	.650	4,76	3/16	1,2	3/64	3,81	.150	○	○	○	○	○	○	○	○	○	○	○	○	○	○	○	○	○	○	○	○	
TNMG160416UR	TNMG334UR	9,53	3/8	16,50	.650	4,76	3/16	1,6	1/16	3,81	.150	○	○	○	○	○	○	○	○	○	○	○	○	○	○	○	○	○	○	○	○	
TNMG220408UR	TNMG432UR	12,70	1/2	22,00	.866	4,76	3/16	0,8	1/32	5,16	.203	○	○	○	○	○	○	○	○	○	○	○	○	○	○	○	○	○	○	○	○	
TNMG220412UR	TNMG433UR	12,70	1/2	22,00	.866	4,76	3/16	1,2	3/64	5,16	.203	○	○	○	○	○	○	○	○	○	○	○	○	○	○	○	○	○	○	○	○	
TNMG220416UR	TNMG434UR	12,70	1/2	22,00	.866	4,76	3/16	1,6	1/16	5,16	.203	○	○	○	○	○	○	○	○	○	○	○	○	○	○	○	○	○	○	○	○	
TNMG270612UR	TNMG543UR	15,88	5/8	27,50	1.083	6,35	1/4	1,2	3/64	6,35	.250	○	○	○	○	○	○	○	○	○	○	○	○	○	○	○	○	○	○	○	○	
TNMG270616UR	TNMG544UR	15,88	5/8	27,50	1.083	6,35	1/4	1,6	1/16	6,35	.250	○	○	○	○	○	○	○	○	○	○	○	○	○	○	○	○	○	○	○	○	

### TNMM-65 • Heavy Roughing

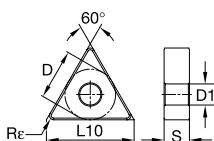
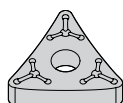

● first choice  
○ alternate choice

P	●	●	●	●	○	○	○	○	○	○	○	○	○	○	○	○	○	○	○	○	○	○	○	○	○	○
M	●	●	○	○	○	○	○	○	○	○	○	○	○	○	○	○	○	○	○	○	○	○	○	○	○	○
K	○	○	○	○	○	○	○	○	○	○	○	○	○	○	○	○	○	○	○	○	○	○	○	○	○	○
N	○	○	○	○	○	○	○	○	○	○	○	○	○	○	○	○	○	○	○	○	○	○	○	○	○	○
S	○	○	○	○	○	○	○	○	○	○	○	○	○	○	○	○	○	○	○	○	○	○	○	○	○	○
H	○	○	○	○	○	○	○	○	○	○	○	○	○	○	○	○	○	○	○	○	○	○	○	○	○	○

ISO catalog number	ANSI catalog number	D		L10		S		Rε		D1		Material																																
		mm	in	mm	in	mm	in	mm	in	mm	in	mm	in	WP05CT	WP15CT	WP25CT	WP35CT	WM15CT	WM25CT	WM35CT	WK05CT	WK15CT	WK20CT	WS10PT	WS25PT	WU10HT	WU05PT	WP20TT	THM	TTR	WM20CT	WU10PT	WU25PT											
TNMM16040865	TNMM33265	9,53	3/8	16,50	.650	4,76	3/16	0,8	1/32	3,81	.150	○	○	○	○	○	○	○	○	○	○	○	○	○	○	○	○	○	○	○	○	○	○	○	○	○	○	○	○	○				
TNMM22040865	TNMM43265	12,70	1/2	22,00	.866	4,76	3/16	0,8	1/32	5,16	.203	○	○	○	○	○	○	○	○	○	○	○	○	○	○	○	○	○	○	○	○	○	○	○	○	○	○	○	○	○	○	○	○	
TNMM22041265	TNMM43365	12,70	1/2	22,00	.866	4,76	3/16	1,2	3/64	5,16	.203	○	○	○	○	○	○	○	○	○	○	○	○	○	○	○	○	○	○	○	○	○	○	○	○	○	○	○	○	○	○	○	○	○

### TNMP • Medium Machining

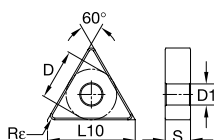
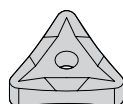

● first choice  
○ alternate choice

P	●	●	○	○	○	○	○	○	○	○	○	○	○	○	○	○	○	○	○	○	○	○	○	○	○	○
M	●	●	○	○	○	○	○	○	○	○	○	○	○	○	○	○	○	○	○	○	○	○	○	○	○	○
K	○	○	○	○	○	○	○	○	○	○	○	○	○	○	○	○	○	○	○	○	○	○	○	○	○	
N	○	○	○	○	○	○	○	○	○	○	○	○	○	○	○	○	○	○	○	○	○	○	○	○	○	
S	○	○	○	○	○	○	○	○	○	○	○	○	○	○	○	○	○	○	○	○	○	○	○	○	○	
H	○	○	○	○	○	○	○	○	○	○	○	○	○	○	○	○	○	○	○	○	○	○	○	○	○	

ISO catalog number	ANSI catalog number	D		L10		S		Rε		D1		Material																																
		mm	in	mm	in	mm	in	mm	in	mm	in	mm	in	WP05CT	WP15CT	WP25CT	WP35CT	WM15CT	WM25CT	WM35CT	WK05CT	WK15CT	WK20CT	WS10PT	WS25PT	WU10HT	WU05PT	WP20TT	THM	TTR	WM20CT	WU10PT	WU25PT											
TNMP160404	TNMP331	9,53	3/8	16,50	.650	4,76	3/16	0,4	1/64	3,81	.150	○	○	○	○	○	○	○	○	○	○	○	○	○	○	○	○	○	○	○	○	○	○	○	○	○	○	○	○	○	○			
TNMP160408	TNMP332	9,53	3/8	16,50	.650	4,76	3/16	0,8	1/32	3,81	.150	○	○	○	○	○	○	○	○	○	○	○	○	○	○	○	○	○	○	○	○	○	○	○	○	○	○	○	○	○	○	○	○	
TNMP160412	TNMP333	9,53	3/8	16,50	.650	4,76	3/16	1,2	3/64	3,81	.150	○	○	○	○	○	○	○	○	○	○	○	○	○	○	○	○	○	○	○	○	○	○	○	○	○	○	○	○	○	○	○	○	
TNMP220404	TNMP431	12,70	1/2	22,00	.866	4,76	3/16	0,4	1/64	5,16	.203	○	○	○	○	○	○	○	○	○	○	○	○	○	○	○	○	○	○	○	○	○	○	○	○	○	○	○	○	○	○	○	○	○
TNMP220408	TNMP432	12,70	1/2	22,00	.866	4,76	3/16	0,8	1/32	5,16	.203	○	○	○	○	○	○	○	○	○	○	○	○	○	○	○	○	○	○	○	○	○	○	○	○	○	○	○	○	○	○	○	○	○



## TPGN • Medium Machining

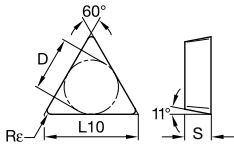
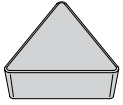

● first choice  
○ alternate choice

	P	M	K	N	S	H	WP05CT	WP15CT	WP25CT	WP35CT	WM15CT	WM25CT	WM35CT	WK05CT	WK15CT	WK20CT	WS10PT	WS25PT	WU10HT	WU05PT	WP20TT	THM	TTR	WM20CT	WU10PT	WU25PT	
TPGN110304	TPG221	6,35	1/4	11,00	.433	3,18	1/8	0,4	1/64																		
TPGN110308	TPG222	6,35	1/4	11,00	.433	3,18	1/8	0,8	1/32																		
TPGN160308	TPG322	9,53	3/8	16,50	.650	3,18	1/8	0,8	1/32																		

## TPGA • Medium Machining

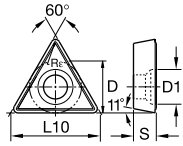
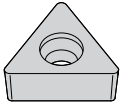

● first choice  
○ alternate choice

	P	M	K	N	S	H	WP05CT	WP15CT	WP25CT	WP35CT	WM15CT	WM25CT	WM35CT	WK05CT	WK15CT	WK20CT	WS10PT	WS25PT	WU10HT	WU05PT	WP20TT	THM	TTR	WM20CT	WU10PT	WU25PT	
TPGA110204	TPGA2151	6,35	1/4	11,00	.433	2,38	3/32	0,4	1/64	3,40	.134																
TPGA110208	TPGA2152	6,35	1/4	11,00	.433	2,38	3/32	0,8	1/32	3,40	.134																

## TPMR • Medium Machining

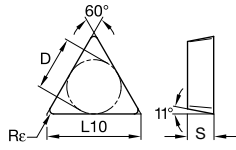
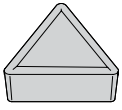

- first choice
- alternate choice

ISO catalog number	ANSI catalog number	D		L10		S		Re		Material Compatibility																													
		mm	in	mm	in	mm	in	mm	in	P	M	K	N	S	H	WP05CT	WP15CT	WP25CT	WP35CT	WM15CT	WM25CT	WM35CT	WK05CT	WK15CT	WK20CT	WS10PT	WS25PT	WU10HT	WU05PT	WP20TT	THM	TTR	WM20CT	WU10PT	WU25PT				
TPMR110304	TPMR221	6,35	1/4	11,00	.433	3,18	1/8	0,4	1/64	●	●	●	●	●	●	○	○	○	○	○	○	○	○	○	○	○	○	○	○	○	○	○	○	○	○	○	○	○	
TPMR110308	TPMR222	6,35	1/4	11,00	.433	3,18	1/8	0,8	1/32	●	●	●	●	●	●	○	○	○	○	○	○	○	○	○	○	○	○	○	○	○	○	○	○	○	○	○	○	○	
TPMR160304	TPMR321	9,53	3/8	16,50	.650	3,18	1/8	0,4	1/64	●	●	●	●	●	●	○	○	○	○	○	○	○	○	○	○	○	○	○	○	○	○	○	○	○	○	○	○	○	
TPMR160308	TPMR322	9,53	3/8	16,50	.650	3,18	1/8	0,8	1/32	●	●	●	●	●	●	○	○	○	○	○	○	○	○	○	○	○	○	○	○	○	○	○	○	○	○	○	○	○	○
TPMR160312	TPMR323	9,53	3/8	16,50	.650	3,18	1/8	1,2	3/64	●	●	●	●	●	●	○	○	○	○	○	○	○	○	○	○	○	○	○	○	○	○	○	○	○	○	○	○	○	○

## TPMT-FP • Finishing Positive

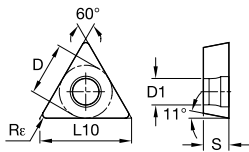
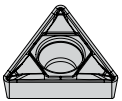

- first choice
- alternate choice

ISO catalog number	ANSI catalog number	D		L10		S		Re		D1		Material Compatibility																												
		mm	in	mm	in	mm	in	mm	in	mm	in	P	M	K	N	S	H	WP05CT	WP15CT	WP25CT	WP35CT	WM15CT	WM25CT	WM35CT	WK05CT	WK15CT	WK20CT	WS10PT	WS25PT	WU10HT	WU05PT	WP20TT	THM	TTR	WM20CT	WU10PT	WU25PT			
TPMT110204FP	TPMT2151FP	6,35	1/4	11,00	.433	2,38	3/32	0,4	1/64	2,80	.110	●	●	●	●	●	●	○	○	○	○	○	○	○	○	○	○	○	○	○	○	○	○	○	○	○	○	○	○	
TPMT16T308FP	TPMT3252FP	9,53	3/8	16,50	.650	3,97	5/32	0,8	1/32	4,40	.173	●	●	●	●	●	●	○	○	○	○	○	○	○	○	○	○	○	○	○	○	○	○	○	○	○	○	○	○	○
TPMT220408FP	TPMT432FP	12,70	1/2	22,00	.866	4,76	3/16	0,8	1/32	5,50	.217	●	●	●	●	●	●	○	○	○	○	○	○	○	○	○	○	○	○	○	○	○	○	○	○	○	○	○	○	○

TPUN/TPU • Medium Machining

INDEXABLE MILLING

SOLID END MILLING

HOLEMAKING

TAPPING

TURNING

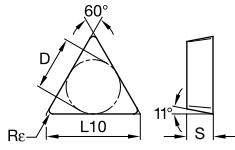
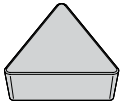

● first choice  
○ alternate choice

	P	M	K	N	S	H
WP05CT	●	○	○	○	○	○
WP15CT	●	○	○	○	○	○
WP25CT	○	○	○	○	○	○
WP35CT	○	○	○	○	○	○
WM15CT	○	○	○	○	○	○
WM25CT	○	○	○	○	○	○
WM35CT	○	○	○	○	○	○
WK05CT	○	○	○	○	○	○
WK15CT	○	○	○	○	○	○
WK20CT	○	○	○	○	○	○
WS10PT	○	○	○	○	○	○
WS25PT	○	○	○	○	○	○
WU10HT	○	○	○	○	○	○
WU05PT	○	○	○	○	○	○
WP20TT	○	○	○	○	○	○
THM	○	○	○	○	○	○
TTR	○	○	○	○	○	○
WM20CT	○	○	○	○	○	○
WU10PT	○	○	○	○	○	○
WU25PT	○	○	○	○	○	○

ISO catalog number	ANSI catalog number	D		L10		S		Rε		WP05CT	WP15CT	WP25CT	WP35CT	WM15CT	WM25CT	WM35CT	WK05CT	WK15CT	WK20CT	WS10PT	WS25PT	WU10HT	WU05PT	WP20TT	THM	TTR	WM20CT	WU10PT	WU25PT
		mm	in	mm	in	mm	in	mm	in																				
TPUN110304	TPU221	6,35	1/4	11,00	.433	3,18	1/8	0,4	1/64																				
TPUN110308	TPU222	6,35	1/4	11,00	.433	3,18	1/8	0,8	1/32																				
TPUN160304	TPU321	9,53	3/8	16,50	.650	3,18	1/8	0,4	1/64																				
TPUN160308	TPU322	9,53	3/8	16,50	.650	3,18	1/8	0,8	1/32																				
TPUN160312	TPU323	9,53	3/8	16,50	.650	3,18	1/8	1,2	3/64																				
TPUN220408	TPU432	12,70	1/2	22,00	.866	4,76	3/16	0,8	1/32																				
TPUN220408	TPUN 432	12,70	1/2	22,00	.866	4,76	3/16	0,8	1/32																				
TPUN220412	TPU433	12,70	1/2	22,00	.866	4,76	3/16	1,2	3/64																				



INDEXABLE MILLING

SOLID END MILLING

HOLEMAKING

TAPPING

TURNING

## VBMT-FP • Finishing Positive

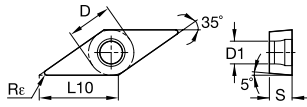
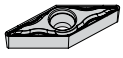

● first choice  
○ alternate choice

ISO catalog number	ANSI catalog number	D		L10		S		Rε		D1		Material																								
		mm	in	mm	in	mm	in	mm	in	mm	in	WP05CT	WP15CT	WP25CT	WP35CT	WM15CT	WM25CT	WM35CT	WK06CT	WK15CT	WK20CT	WS10PT	WS25PT	WU10HT	WU05PT	WP20TT	THM	TTR	WM20CT	WU10PT	WU25PT					
VBMT110302FP	VBMT2205FP	6,35	1/4	11,07	.436	3,18	1/8	0,2	.008	2,80	.110	●	●	●	●	○	○	○	○	○	○	○	○	○	○	○	○	○	○	○	○	○	○	○	○	
VBMT110304FP	VBMT221FP	6,35	1/4	11,07	.436	3,18	1/8	0,4	1/64	2,80	.110	○	○	○	○	○	○	○	○	○	○	○	○	○	○	○	○	○	○	○	○	○	○	○	○	
VBMT110308FP	VBMT222FP	6,35	1/4	11,07	.436	3,18	1/8	0,8	1/32	2,80	.110	○	○	○	○	○	○	○	○	○	○	○	○	○	○	○	○	○	○	○	○	○	○	○	○	○
VBMT160402FP	VBMT3305FP	9,53	3/8	16,61	.654	4,76	3/16	0,2	.008	4,40	.173	○	○	○	○	○	○	○	○	○	○	○	○	○	○	○	○	○	○	○	○	○	○	○	○	○
VBMT160404FP	VBMT331FP	9,53	3/8	16,61	.654	4,76	3/16	0,4	1/64	4,40	.173	○	○	○	○	○	○	○	○	○	○	○	○	○	○	○	○	○	○	○	○	○	○	○	○	○
VBMT160408FP	VBMT332FP	9,53	3/8	16,61	.654	4,76	3/16	0,8	1/32	4,40	.173	○	○	○	○	○	○	○	○	○	○	○	○	○	○	○	○	○	○	○	○	○	○	○	○	○

### VBMT-MP • Medium Positive

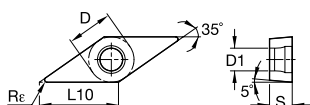

● first choice

○ alternate choice

ISO catalog number	ANSI catalog number	D		L10		S		Rε		D1		Material Compatibility Matrix																							
		mm	in	mm	in	mm	in	mm	in	mm	in	WP05CT	WP15CT	WP25CT	WP35CT	WM15CT	WM25CT	WM35CT	WK05CT	WK15CT	WK20CT	WS10PT	WS25PT	WU10HT	WU05PT	WP20TT	THM	TTR	WM20CT	WU10PT	WU25PT				
<b>VBMT160404MP</b>	<b>VBMT331MP</b>	9,53	3/8	16,61	.654	4,76	3/16	0,4	1/64	4,40	.173																								
<b>VBMT160408MP</b>	<b>VBMT332MP</b>	9,53	3/8	16,61	.654	4,76	3/16	0,8	1/32	4,40	.173			4170236																					

### VBMT-1P • Finishing

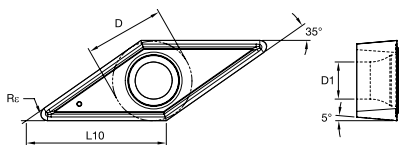

● first choice

○ alternate choice

ISO catalog number	ANSI catalog number	D		L10		S		Rε		D1		Material Compatibility Matrix																							
		mm	in	mm	in	mm	in	mm	in	mm	in	WP05CT	WP15CT	WP25CT	WP35CT	WM15CT	WM25CT	WM35CT	WK05CT	WK15CT	WK20CT	WS10PT	WS25PT	WU10HT	WU05PT	WP20TT	THM	TTR	WM20CT	WU10PT	WU25PT				
<b>VBMT1604041P</b>	<b>VBMT3311P</b>	9,53	3/8	16,61	.654	4,76	3/16	0,4	1/64	4,40	.173																								
<b>VBMT1604081P</b>	<b>VBMT3321P</b>	9,53	3/8	16,61	.654	4,76	3/16	0,8	1/32	4,40	.173																								



## VNGP • Medium Machining

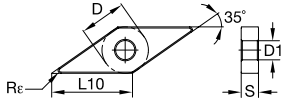
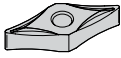

● first choice  
○ alternate choice

ISO catalog number	ANSI catalog number	D		L10		S		Rε		D1		Material Compatibility																				
		mm	in	mm	in	mm	in	mm	in	mm	in	WP05CT	WP15CT	WP25CT	WP35CT	WM15CT	WM25CT	WM35CT	WK05CT	WK15CT	WK20CT	WS10PT	WS25PT	WU10HT	WU05PT	WP20TT	THM	TTR	WM20CT	WU10PT	WU25PT	
VNGP160402	VNGP3305	9,53	3/8	16,61	.654	4,76	3/16	0,2	.008	3,81	.150	•	•	•	•	•	•	•	•	•	•	•	•	•	•	•	•	•	•	•	•	•
VNGP160401	VNGP330	9,53	3/8	16,61	.654	4,76	3/16	0,1	.004	3,81	.150	•	•	•	•	•	•	•	•	•	•	•	•	•	•	•	•	•	•	•	•	•
VNGP220408	VNGP432	12,70	1/2	22,14	.872	4,76	3/16	0,8	1/32	5,16	.203	•	•	•	•	•	•	•	•	•	•	•	•	•	•	•	•	•	•	•	•	•

## VNMA • Roughing

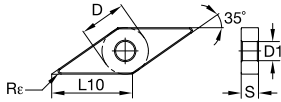

● first choice  
○ alternate choice

ISO catalog number	ANSI catalog number	D		L10		S		Rε		D1		Material Compatibility																				
		mm	in	mm	in	mm	in	mm	in	mm	in	WP05CT	WP15CT	WP25CT	WP35CT	WM15CT	WM25CT	WM35CT	WK05CT	WK15CT	WK20CT	WS10PT	WS25PT	WU10HT	WU05PT	WP20TT	THM	TTR	WM20CT	WU10PT	WU25PT	
VNMA160408	VNMA332	9,53	3/8	16,61	.654	4,76	3/16	0,8	1/32	3,81	.150	•	•	•	•	•	•	•	•	•	•	•	•	•	•	•	•	•	•	•	•	•



## VNMG • Medium Machining

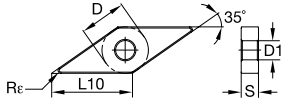

● first choice  
○ alternate choice

ISO catalog number	ANSI catalog number	D		L10		S		Rε		D1		WP05CT	WP15CT	WP25CT	WP35CT	WM15CT	WM25CT	WM35CT	WK05CT	WK15CT	WK20CT	WS10PT	WS25PT	WU10HT	WU05PT	WP20TT	THM	TTR	WM20CT	WU10PT	WU25PT	
		mm	in	mm	in	mm	in	mm	in	mm	in																					
VNMG12T304	VNMG12T304	7,14	9/32	12,45	.490	3,97	5/32	0,4	.016	3,60	.142	●	●	●	●	○	○	○	○	○	○	○	○	○	○	○	○	○	○	○	○	○
VNMG12T308	VNMG12T308	7,14	9/32	12,45	.490	3,97	5/32	0,8	.031	3,60	.142	●	●	●	●	○	○	○	○	○	○	○	○	○	○	○	○	○	○	○	○	

## VNMG-FF • Fine Finishing

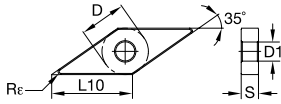
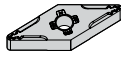

● first choice  
○ alternate choice

ISO catalog number	ANSI catalog number	D		L10		S		Rε		D1		WP05CT	WP15CT	WP25CT	WP35CT	WM15CT	WM25CT	WM35CT	WK05CT	WK15CT	WK20CT	WS10PT	WS25PT	WU10HT	WU05PT	WP20TT	THM	TTR	WM20CT	WU10PT	WU25PT
		mm	in	mm	in	mm	in	mm	in	mm	in																				
VNMG160404FF	VNMG331FF	9,53	3/8	16,61	.654	4,76	3/16	0,4	1/64	3,81	.150	●	●	●	●	○	○	○	○	○	○	○	○	○	○	○	○	○	○	○	○
VNMG160408FF	VNMG332FF	9,53	3/8	16,61	.654	4,76	3/16	0,8	1/32	3,81	.150	●	●	●	●	○	○	○	○	○	○	○	○	○	○	○	○	○	○	○	○

VNMG-ML • Medium Machining

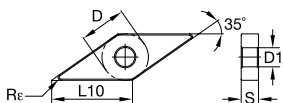

● first choice

○ alternate choice

ISO catalog number	ANSI catalog number	D		L10		S		Rε		D1		WP05CT	WP15CT	WP25CT	WP35CT	WM15CT	WM25CT	WM35CT	WK05CT	WK15CT	WK20CT	WS10PT	WS25PT	WU10HT	WU05PT	WP20TT	THM	TTR	WM20CT	WU10PT	WU25PT	
		mm	in	mm	in	mm	in	mm	in	mm	in																					
VNMG160404ML	VNMG331ML	9,53	3/8	16,61	.654	4,76	3/16	0,4	1/64	3,81	.150	●	●	●	●	○	○	○	○	○	○	○	○	○	○	○	○	○	○	○	○	○
VNMG160408ML	VNMG332ML	9,53	3/8	16,61	.654	4,76	3/16	0,8	1/32	3,81	.150	○	○	○	○	○	○	○	○	○	○	○	○	○	○	○	○	○	○	○	○	

VNMG-MR • Medium Roughing

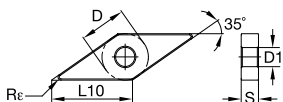
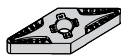

● first choice

○ alternate choice

ISO catalog number	ANSI catalog number	D		L10		S		Rε		D1		WP05CT	WP15CT	WP25CT	WP35CT	WM15CT	WM25CT	WM35CT	WK05CT	WK15CT	WK20CT	WS10PT	WS25PT	WU10HT	WU05PT	WP20TT	THM	TTR	WM20CT	WU10PT	WU25PT
		mm	in	mm	in	mm	in	mm	in	mm	in																				
VNMG160408MR	VNMG332MR	9,53	3/8	16,61	.654	4,76	3/16	0,8	1/32	3,81	.150	○	○	○	○	○	○	○	○	○	○	○	○	○	○	○	○	○	○	○	○

VNMG-MS • Medium Sharp

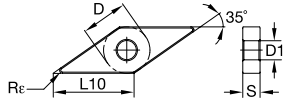

● first choice

○ alternate choice

ISO catalog number	ANSI catalog number	D		L10		S		Re		D1																									
		mm	in	mm	in	mm	in	mm	in	mm	in	WP05CT	WP15CT	WP25CT	WP35CT	WM15CT	WM25CT	WM35CT	WK05CT	WK15CT	WK20CT	WS10PT	WS25PT	WU10HT	WU05PT	WP20TT	THM	TTR	WM20CT	WU10PT	WU25PT				
VNMG160404MS	VNMG331MS	9,53	3/8	16,61	.654	4,76	3/16	0,4	1/64	3,81	.150	●	●	●	○	○	○	○	○	○	○	○	○	○	○	○	○	○	○	○	○	○	○	○	
VNMG160408MS	VNMG332MS	9,53	3/8	16,61	.654	4,76	3/16	0,8	1/32	3,81	.150	●	●	●	○	○	○	○	○	○	○	○	○	○	○	○	○	○	○	○	○	○	○	○	
VNMG220404MS	VNMG431MS	12,70	1/2	22,14	.872	4,76	3/16	0,4	1/64	5,16	.203	●	●	●	○	○	○	○	○	○	○	○	○	○	○	○	○	○	○	○	○	○	○	○	
VNMG220408MS	VNMG432MS	12,70	1/2	22,14	.872	4,76	3/16	0,8	1/32	5,16	.203	●	●	●	○	○	○	○	○	○	○	○	○	○	○	○	○	○	○	○	○	○	○	○	○

VNMG-RH • Roughing

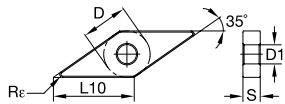

● first choice

○ alternate choice

ISO catalog number	ANSI catalog number	D		L10		S		Re		D1																									
		mm	in	mm	in	mm	in	mm	in	mm	in	WP05CT	WP15CT	WP25CT	WP35CT	WM15CT	WM25CT	WM35CT	WK05CT	WK15CT	WK20CT	WS10PT	WS25PT	WU10HT	WU05PT	WP20TT	THM	TTR	WM20CT	WU10PT	WU25PT				
VNMG160408RH	VNMG332RH	9,53	3/8	16,61	.654	4,76	3/16	0,8	1/32	3,81	.150	●	●	●	○	○	○	○	○	○	○	○	○	○	○	○	○	○	○	○	○	○	○	○	
VNMG220408RH	VNMG432RH	12,70	1/2	22,14	.872	4,76	3/16	0,8	1/32	5,16	.203	●	●	●	○	○	○	○	○	○	○	○	○	○	○	○	○	○	○	○	○	○	○	○	○
VNMG220412RH	VNMG433RH	12,70	1/2	22,14	.872	4,76	3/16	1,2	3/64	5,16	.203	●	●	●	○	○	○	○	○	○	○	○	○	○	○	○	○	○	○	○	○	○	○	○	○

VNMG-UF • Fine Finishing

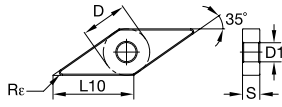

● first choice  
○ alternate choice

P	●	●	●	●	○	○	○	○	○	○	○	○	○	○	○	○	○	○	○	○	○	○	○	○	○	○	○
M	●	●	●	●	○	○	○	○	○	○	○	○	○	○	○	○	○	○	○	○	○	○	○	○	○	○	○
K	○	○	○	○	○	○	○	○	○	○	○	○	○	○	○	○	○	○	○	○	○	○	○	○	○	○	○
N	○	○	○	○	○	○	○	○	○	○	○	○	○	○	○	○	○	○	○	○	○	○	○	○	○	○	○
S	○	○	○	○	○	○	○	○	○	○	○	○	○	○	○	○	○	○	○	○	○	○	○	○	○	○	○
H	○	○	○	○	○	○	○	○	○	○	○	○	○	○	○	○	○	○	○	○	○	○	○	○	○	○	○

ISO catalog number	ANSI catalog number	D		L10		S		Rε		D1		WP05CT	WP15CT	WP25CT	WP35CT	WM15CT	WM25CT	WM35CT	WK05CT	WK15CT	WK20CT	WS10PT	WS25PT	WU10HT	WU05PT	WP20TT	THM	TTR	WM20CT	WU10PT	WU25PT	
		mm	in	mm	in	mm	in	mm	in	mm	in																					
VNMG160404UF	VNMG331UF	9,53	3/8	16,61	.654	4,76	3/16	0,4	1/64	3,81	.150	○	○	○	○	○	○	○	○	○	○	○	○	○	○	○	○	○	○	○	○	
VNMG160408UF	VNMG332UF	9,53	3/8	16,61	.654	4,76	3/16	0,8	1/32	3,81	.150	○	5645618	○	○	4169373	4169398	○	○	○	○	5645616	○	○	○	○	○	○	○	○	○	○

VNMG-UR • Universal Roughing

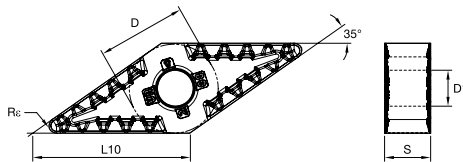

● first choice  
○ alternate choice

P	●	●	●	●	○	○	○	○	○	○	○	○	○	○	○	○	○	○	○	○	○	○	○	○	○	○	○	○	○	○	○	○	
M	●	●	●	●	○	○	○	○	○	○	○	○	○	○	○	○	○	○	○	○	○	○	○	○	○	○	○	○	○	○	○	○	○
K	○	○	○	○	○	○	○	○	○	○	○	○	○	○	○	○	○	○	○	○	○	○	○	○	○	○	○	○	○	○	○	○	○
N	○	○	○	○	○	○	○	○	○	○	○	○	○	○	○	○	○	○	○	○	○	○	○	○	○	○	○	○	○	○	○	○	○
S	○	○	○	○	○	○	○	○	○	○	○	○	○	○	○	○	○	○	○	○	○	○	○	○	○	○	○	○	○	○	○	○	○
H	○	○	○	○	○	○	○	○	○	○	○	○	○	○	○	○	○	○	○	○	○	○	○	○	○	○	○	○	○	○	○	○	○

ISO catalog number	ANSI catalog number	D		L10		S		Rε		D1		WP05CT	WP15CT	WP25CT	WP35CT	WM15CT	WM25CT	WM35CT	WK05CT	WK15CT	WK20CT	WS10PT	WS25PT	WU10HT	WU05PT	WP20TT	THM	TTR	WM20CT	WU10PT	WU25PT	
		mm	in	mm	in	mm	in	mm	in	mm	in																					
VNMG160408UR	VNMG332UR	9,53	3/8	16,61	.654	4,76	3/16	0,8	1/32	3,81	.150	○	4171123	4170529	○	4169439	4169473	○	○	○	○	○	○	○	○	○	○	○	○	○	○	
VNMG160412UR	VNMG333UR	9,53	3/8	16,61	.654	4,76	3/16	1,2	3/64	3,81	.150	○	4171124	4170530	○	4169474	○	○	○	○	4171450	5680176	○	○	○	○	○	○	○	6942350	6867894	6867893

## VNMP • Medium Machining

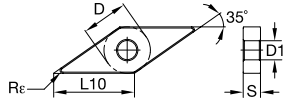
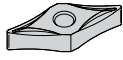

● first choice  
○ alternate choice

ISO catalog number	ANSI catalog number	D		L10		S		Rε		D1		WP05CT	WP15CT	WP25CT	WP35CT	WM15CT	WM25CT	WM35CT	WK05CT	WK15CT	WK20CT	WS10PT	WS25PT	WU10HT	WU05PT	WP20TT	THM	TTR	WM20CT	WU10PT	WU25PT	
		mm	in	mm	in	mm	in	mm	in	mm	in																					
VNMP160404	VNMP331	9,53	3/8	16,61	.654	4,76	3/16	0,4	1/64	3,81	.150	●	●	●	●	○	○	○	○	○	○	○	○	○	○	○	○	○	○	○	○	○
VNMP160408	VNMP332	9,53	3/8	16,61	.654	4,76	3/16	0,8	1/32	3,81	.150	●	●	●	●	○	○	○	○	○	○	○	○	○	○	○	○	○	○	○	○	○

## WNGG-FS • Finishing Sharp

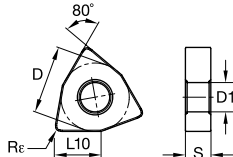
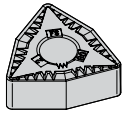

● first choice  
○ alternate choice

ISO catalog number	ANSI catalog number	D		L10		S		Rε		D1		WP05CT	WP15CT	WP25CT	WP35CT	WM15CT	WM25CT	WM35CT	WK05CT	WK15CT	WK20CT	WS10PT	WS25PT	WU10HT	WU05PT	WP20TT	THM	TTR	WM20CT	WU10PT	WU25PT	
		mm	in	mm	in	mm	in	mm	in	mm	in																					
WNGG080404FS	WNGG431FS	12,70	1/2	8,69	.342	4,76	3/16	0,4	1/64	5,16	.203	●	●	●	●	○	○	○	○	○	○	○	○	○	○	○	○	○	○	○	○	
WNGG080408FS	WNGG432FS	12,70	1/2	8,69	.342	4,76	3/16	0,8	1/32	5,16	.203	●	●	●	●	○	○	○	○	○	○	○	○	○	○	○	○	○	○	○	○	○

### WNMA • Roughing

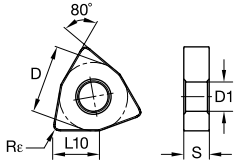
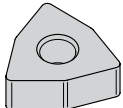

● first choice  
○ alternate choice

P	M	K	N	S	H	WP05CT	WP15CT	WP25CT	WP35CT	WM15CT	WM25CT	WM35CT	WK05CT	WK15CT	WK20CT	WS10PT	WS25PT	WU10HT	WU05PT	WP20TT	THM	TTR	WM20CT	WU10PT	WU25PT	
●	●	●	○	○						○	○	○	○	○	○	○	○	○	○	○	○	○	○	○	○	
●	●	○	○	○						○	○	○	○	○	○	○	○	○	○	○	○	○	○	○	○	
○	○	○	○	○						○	○	○	○	○	○	○	○	○	○	○	○	○	○	○	○	
○	○	○	○	○						○	○	○	○	○	○	○	○	○	○	○	○	○	○	○	○	
○	○	○	○	○						○	○	○	○	○	○	○	○	○	○	○	○	○	○	○	○	

ISO catalog number	ANSI catalog number	D		L10		S		Re		D1	
		mm	in	mm	in	mm	in	mm	in	mm	in
WNMA060408	WNMA332	9,53	3/8	6,52	.257	4,76	3/16	0,8	1/32	3,81	.150
WNMA060412	WNMA333	9,53	3/8	6,52	.257	4,76	3/16	1,2	3/64	3,81	.150
WNMA080408	WNMA432	12,70	1/2	8,69	.342	4,76	3/16	0,8	1/32	5,16	.203
WNMA080412	WNMA433	12,70	1/2	8,69	.342	4,76	3/16	1,2	3/64	5,16	.203
WNMA080416	WNMA434	12,70	1/2	8,69	.342	4,76	3/16	0,6	1/16	5,16	.203

### WNMG-5 • Roughing

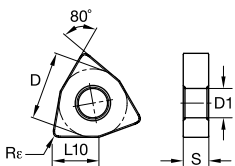
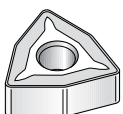

● first choice  
○ alternate choice

P	M	K	N	S	H	WP05CT	WP15CT	WP25CT	WP35CT	WM15CT	WM25CT	WM35CT	WK05CT	WK15CT	WK20CT	WS10PT	WS25PT	WU10HT	WU05PT	WP20TT	THM	TTR	WM20CT	WU10PT	WU25PT	
●	●	○	○	○						○	○	○	○	○	○	○	○	○	○	○	○	○	○	○	○	
●	●	○	○	○						○	○	○	○	○	○	○	○	○	○	○	○	○	○	○	○	
○	○	○	○	○						○	○	○	○	○	○	○	○	○	○	○	○	○	○	○	○	
○	○	○	○	○						○	○	○	○	○	○	○	○	○	○	○	○	○	○	○	○	
○	○	○	○	○						○	○	○	○	○	○	○	○	○	○	○	○	○	○	○	○	

ISO catalog number	ANSI catalog number	D		L10		S		Re		D1	
		mm	in	mm	in	mm	in	mm	in	mm	in
WNMG080408-5	WNMG4325	12,70	1/2	8,69	.342	4,76	3/16	0,8	1/32	5,16	.203











INDEXABLE MILLING

SOLID END MILLING

HOLEMAKING

TAPPING

TURNING

WNMG-UF • Fine Finishing

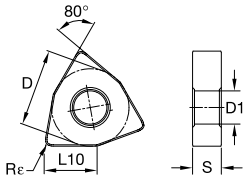

● first choice

○ alternate choice

P	●	●	●	●	○	○	○	○	○	○	○	○	○	○	○	○	○	○	○	○	○
M	○	○	○	○	○	○	○	○	○	○	○	○	○	○	○	○	○	○	○	○	○
K	○	○	○	○	○	○	○	○	○	○	○	○	○	○	○	○	○	○	○	○	○
N	○	○	○	○	○	○	○	○	○	○	○	○	○	○	○	○	○	○	○	○	○
S	○	○	○	○	○	○	○	○	○	○	○	○	○	○	○	○	○	○	○	○	○
H	○	○	○	○	○	○	○	○	○	○	○	○	○	○	○	○	○	○	○	○	○

ISO catalog number	ANSI catalog number	D		L10		S		Re		D1		WP05CT	WP15CT	WP25CT	WP35CT	WM15CT	WM25CT	WM35CT	WK05CT	WK15CT	WK20CT	WS10PT	WS25PT	WU10HT	WU05PT	WP20TT	THM	TTR	WM20CT	WU10PT	WU25PT
		mm	in	mm	in	mm	in	mm	in	mm	in																				
WNMG060404UF	WNMG331UF	9,53	3/8	6,52	.257	4,76	3/16	0,4	1/64	3,81	.150	●	●	●	○	○	○	○	○	○	○	○	○	○	○	○	○	○	○	○	
WNMG060408UF	WNMG332UF	9,53	3/8	6,52	.257	4,76	3/16	0,8	1/32	3,81	.150	●	●	●	○	○	○	○	○	○	○	○	○	○	○	○	○	○	○	○	
WNMG080404UF	WNMG431UF	12,70	1/2	8,69	.342	4,76	3/16	0,4	1/64	5,16	.203	●	●	●	○	○	○	○	○	○	○	○	○	○	○	○	○	○	○	○	
WNMG080408UF	WNMG432UF	12,70	1/2	8,69	.342	4,76	3/16	0,8	1/32	5,16	.203	●	●	●	○	○	○	○	○	○	○	○	○	○	○	○	○	○	○	○	
WNMG080412UF	WNMG433UF	12,70	1/2	8,69	.342	4,76	3/16	1,2	3/64	5,16	.203	●	●	●	○	○	○	○	○	○	○	○	○	○	○	○	○	○	○	○	



## WNMG-UR • Universal Roughing

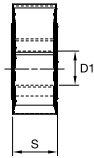
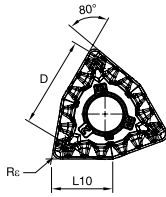
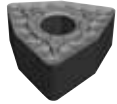

● first choice  
○ alternate choice

ISO catalog number	ANSI catalog number	D		L10		S		R <sub>ε</sub>		D1																								
		mm	in	mm	in	mm	in	mm	in	mm	in	WP05CT	WP15CT	WP25CT	WP35CT	WM15CT	WM25CT	WM35CT	WK05CT	WK15CT	WK20CT	WS10PT	WS25PT	WU10HT	WU05PT	WP20TT	THM	TTR	WM20CT	WU10PT	WU25PT			
WNMG060408UR	WNMG332UR	9,53	3/8	6,52	.257	4,76	3/16	0,8	1/32	3,81	.150	●	●	●	○	○	○	○	○	○	○	○	○	○	○	○	○	○	○	○	○	○	○	○
												●	●	●	○	○	○	○	○	○	○	○	○	○	○	○	○	○	○	○	○	○	○	○
WNMG060412UR	WNMG333UR	9,53	3/8	6,52	.257	4,76	3/16	1,2	3/64	3,81	.150	○	○	○	○	○	○	○	○	○	○	○	○	○	○	○	○	○	○	○	○	○	○	○
												○	○	○	○	○	○	○	○	○	○	○	○	○	○	○	○	○	○	○	○	○	○	○
WNMG080408UR	WNMG432UR	12,70	1/2	8,69	.342	4,76	3/16	0,8	1/32	5,16	.203	○	○	○	○	○	○	○	○	○	○	○	○	○	○	○	○	○	○	○	○	○	○	○
												○	○	○	○	○	○	○	○	○	○	○	○	○	○	○	○	○	○	○	○	○	○	○
WNMG080412UR	WNMG433UR	12,70	1/2	8,69	.342	4,76	3/16	1,2	3/64	5,16	.203	○	○	○	○	○	○	○	○	○	○	○	○	○	○	○	○	○	○	○	○	○	○	○
												○	○	○	○	○	○	○	○	○	○	○	○	○	○	○	○	○	○	○	○	○	○	○
WNMG080416UR	WNMG434UR	12,70	1/2	8,69	.342	4,76	3/16	1,6	1/16	5,16	.203	○	○	○	○	○	○	○	○	○	○	○	○	○	○	○	○	○	○	○	○	○	○	○
												○	○	○	○	○	○	○	○	○	○	○	○	○	○	○	○	○	○	○	○	○	○	○

## WNMP • Medium Machining

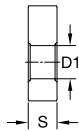
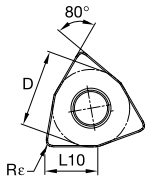
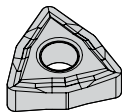

● first choice  
○ alternate choice

ISO catalog number	ANSI catalog number	D		L10		S		R <sub>ε</sub>		D1																								
		mm	in	mm	in	mm	in	mm	in	mm	in	WP05CT	WP15CT	WP25CT	WP35CT	WM15CT	WM25CT	WM35CT	WK05CT	WK15CT	WK20CT	WS10PT	WS25PT	WU10HT	WU05PT	WP20TT	THM	TTR	WM20CT	WU10PT	WU25PT			
WNMP080408	WNMP432	12,70	1/2	8,69	.342	4,76	3/16	0,8	1/32	5,16	.203	○	○	○	○	○	○	○	○	○	○	○	○	○	○	○	○	○	○	○	○	○	○	○
												○	○	○	○	○	○	○	○	○	○	○	○	○	○	○	○	○	○	○	○	○	○	○

WPMT-FP • Finishing Positive

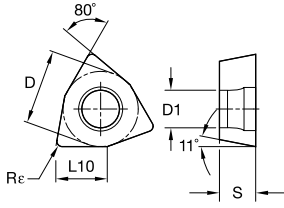
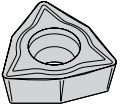

● first choice  
○ alternate choice

	P	M	K	N	S	H															
ISO catalog number	WP05CT	WP15CT	WP25CT	WP35CT	WM15CT	WM25CT	WM35CT	WK05CT	WK15CT	WK20CT	WS10PT	WS25PT	WU10HT	WU05PT	WP20TT	TTHM	TTR	WM20CT	WU10PT	WU25PT	
ANSI catalog number			4170342			4168840															
D																					
L10																					
S																					
Rε																					
D1																					
mm																					
in																					
WPMT06T308FP	WPMT06T308FP	WPMT06T308FP	WPMT06T308FP	WPMT06T308FP	WPMT06T308FP	WPMT06T308FP	WPMT06T308FP	WPMT06T308FP	WPMT06T308FP	WPMT06T308FP	WPMT06T308FP	WPMT06T308FP	WPMT06T308FP	WPMT06T308FP	WPMT06T308FP	WPMT06T308FP	WPMT06T308FP	WPMT06T308FP	WPMT06T308FP	WPMT06T308FP	

INDEXABLE MILLING

SOLID END MILLING

HOLE/MAKING

TAPPING

TURNING

# Inserts for Aluminum

## -AL Geometry

The AL geometry ISO turning series offers various grades and popular styles, giving customers more versatility and optionality when machining aluminum and non-ferrous metal materials in medium to finish turning applications.

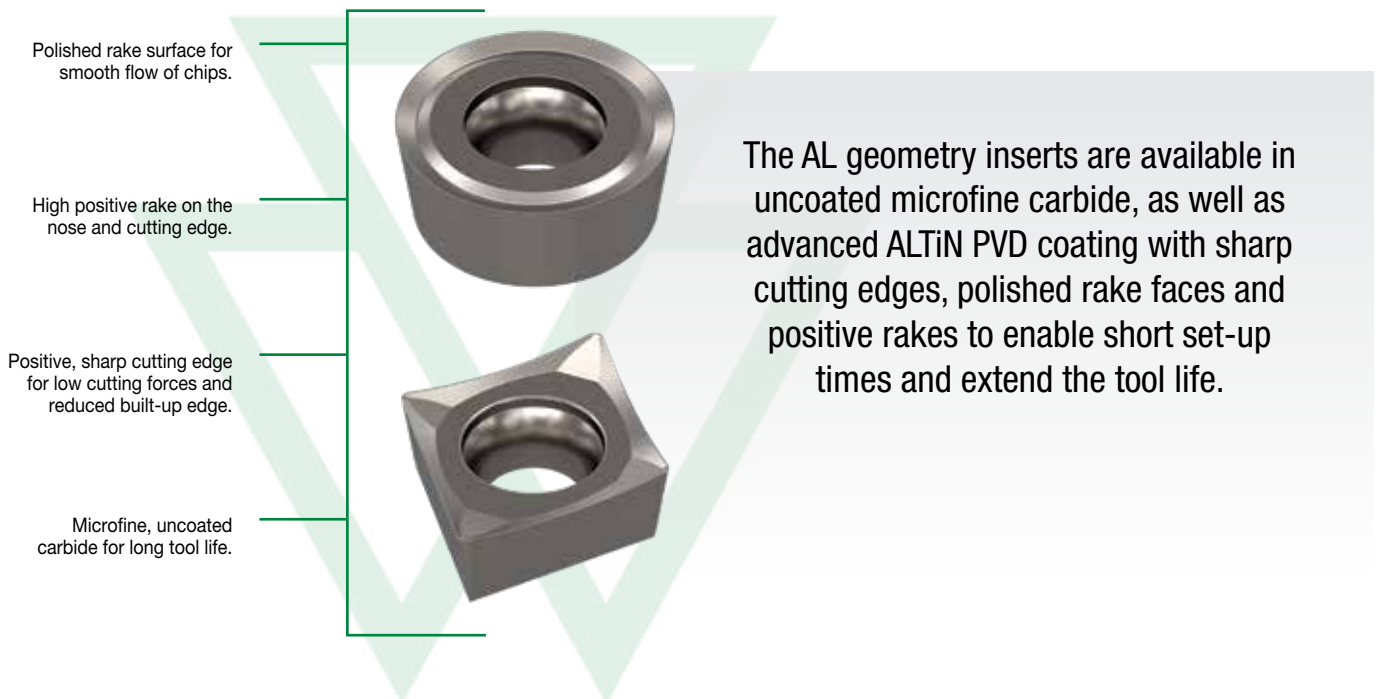

## INSERTS FOR ALUMINUM

**VERSATILE**

**RELIABLE**

**AFFORDABLE**

# MEDIUM TO FINISHING ALUMINUM TURNING

## WU10HT/WU05PT • GRADE INFORMATION

A hard, unalloyed, low-binder content with fine-grained carbide. WU10HT/WU05PT are wear-resistant, uncoated carbide grades for machining of aluminum and other non-ferrous materials.

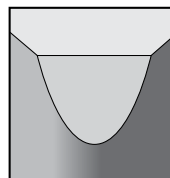

WU10HT/WU05PT

		Geometry
		AL
Lightly Interrupted Cut		WU10HT/WU05PT
Varying Depth of Cut		WU10HT/WU05PT
Smooth Cut		WU10HT/WU05PT

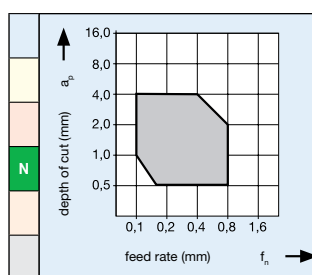

For cost-effective machining of aluminum, non-ferrous metals, and plastics. Extremely sharp cutting edges result in optimum part finishes with low cutting forces and short chips.

### APPLICATIONS



TURNING



FACING



PROFILING



CHAMFERING



BORING

### INDUSTRY

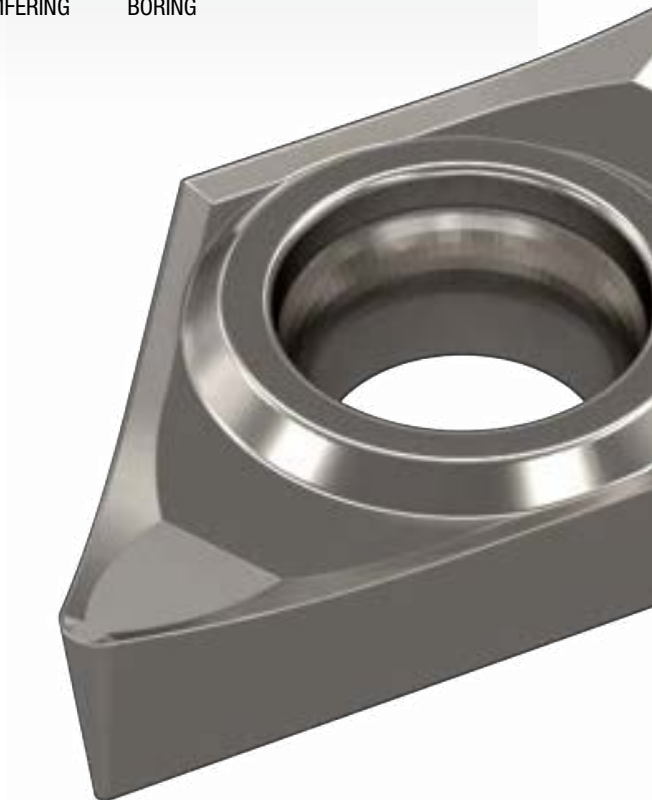



## Grades and Grade Descriptions

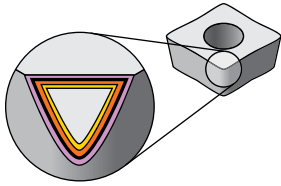

Coatings provide high-speed capability and are engineered for finishing to heavy roughing.

P	Steel
M	Stainless Steel
K	Cast Iron
N	Non-Ferrous
S	High-Temp Alloys
H	Hardened Materials

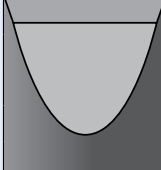
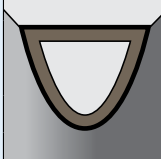
Coating	Grade Description	wear resistance ← toughness									
		05	10	15	20	25	30	35	40	45	
<b>WU10HT</b>  <b>HW-N10</b>	Uncoated carbide. Highly wear-resistant microfine substrate. Suitable for finish turning applications in aluminum and all types of non-ferrous materials, stainless steel, and high-temp alloys with suitable edge preparation. Mainly applied in continuous cuts.										
		M									
		N									
		S									
<b>WU05PT</b>  <b>HC-N05</b>	Coated carbide. PVD AlTiN-coated grade with microfine substrate and highly wear-resistant coating. Suitable for finish turning in aluminum and other non-ferrous materials and also steels, stainless steel, and high-temp alloys with reliability in continuous cuts with suitable edge preparation.	P									
		M									
		K									
		N									
S											

## CUTTING SPEED RECOMMENDATION • N • INCH

**Low-Silicon Aluminum Alloys (hypoeutectic <12,2% Si) and Magnesium Alloys**

material group	grade	Speed – m/min (SFM)										Starting Conditions	
		250 (800)	500 (1600)	750 (2400)	1000 (3200)	1250 (4000)	1500 (4800)	1750 (5600)	2000 (6400)	2250 (7200)	2500 (8000)	m/min	SFM
N1	WU10HT	◊										488	1597

**Low-Silicon Aluminum Alloys (hypoeutectic <12,2% Si) and Magnesium Alloys**

material group	grade	Speed – m/min (SFM)										Starting Conditions	
		250 (800)	500 (1600)	750 (2400)	1000 (3200)	1250 (4000)	1500 (4800)	1750 (5600)	2000 (6400)	2250 (7200)	2500 (8000)	m/min	SFM
N2	WU10HT	◊										488	1597

**High-Silicon Aluminum Alloys (hypereutectic >12,2% Si) and Magnesium Alloys**

material group	grade	Speed – m/min (SFM)										Starting Conditions	
		250 (800)	500 (1600)	750 (2400)	1000 (3200)	1250 (4000)	1500 (4800)	1750 (5600)	2000 (6400)	2250 (7200)	2500 (8000)	m/min	SFM
N3	WU10HT	◊										488	1597
	WU05PT	◊										550	1800

**Copper-, Brass-, Zinc-Based on a Machinability Index Range of 70–100**

material group	grade	Speed – m/min (SFM)				Starting Conditions	
		250 (800)	500 (1600)	750 (2400)	1000 (3200)	m/min	SFM
N4	WU10HT	◊				259	847
	WU05PT	◊				275	900

**Nylon, Plastics, Rubbers, Phenolics, Resins, Fiberglass, and Glass**

material group	grade	Speed – m/min (SFM)				Starting Conditions	
		250 (800)	500 (1600)	750 (2400)	1000 (3200)	m/min	m/min
N5	WU10HT	◊				170	550
	WU05PT	◊				170	550

**Carbon and Graphite Composites: Brush Alloys, Kevlar, and Graphite (280–400 HB) (30–43 HRC)**

material group	grade	Speed – m/min (SFM)				Starting Conditions	
		250 (800)	500 (1600)	750 (2400)	1000 (3200)	m/min	m/min
N6	WU05PT	◊				200	650

**MMCs (Aluminum-Based Metal Matrix Composites)**

material group	grade	Speed – m/min (SFM)				Starting Conditions	
		250 (800)	500 (1600)	750 (2400)	1000 (3200)	m/min	SFM
N7	WU10HT	◊				180	589

**Tin Alloys, Cast: ASTM 823, Alloys 1, 2, 3, 11**

material group	grade	Speed – m/min (SFM)				Starting Conditions	
		250 (800)	500 (1600)	750 (2400)	1000 (3200)	m/min	SFM
N8	WU05PT	◊				215	700

# High-Performance Inserts for Machining Aluminum

INDEXABLE MILLING

SOLID END MILLING

HOLEMAKING

TAPPING

TURNING

## CCGT-AL • Inserts for Aluminum

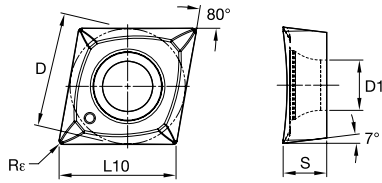

- first choice
- alternate choice

P	<input type="checkbox"/>	<input type="checkbox"/>	<input type="checkbox"/>
M	<input type="checkbox"/>	<input type="checkbox"/>	<input type="checkbox"/>
K	<input type="checkbox"/>	<input type="checkbox"/>	<input type="checkbox"/>
N	<input checked="" type="checkbox"/>	<input checked="" type="checkbox"/>	<input type="checkbox"/>
S	<input type="checkbox"/>	<input type="checkbox"/>	<input type="checkbox"/>
H	<input type="checkbox"/>	<input type="checkbox"/>	<input type="checkbox"/>

ISO catalog number	ANSI catalog number	D		L10		S		R <sub>ε</sub>		D1		WU10HT	WU05PT
		mm	in	mm	in	mm	in	mm	in	mm	in		
CCGT060202AL	CCGT21505AL	6,35	1/4	6,45	.254	2,38	3/32	0,2	.008	2,80	.110	6846528	6968709
CCGT060204AL	CCGT2151AL	6,35	1/4	6,47	.255	2,38	3/32	0,4	.016	2,79	.110	6846529	6968709
CCGT060208AL	CCGT2152AL	6,35	1/4	6,45	.254	2,38	3/32	0,8	.031	2,80	.110	6846530	6968710
CCGT09T302AL	CCGT32505AL	9,53	3/8	9,67	.381	3,97	5/32	0,2	.008	4,40	.173	6846531	6968711
CCGT09T304AL	CCGT3251AL	9,53	3/8	9,67	.381	3,97	5/32	0,4	.016	4,40	.173	6846532	6968751
CCGT09T308AL	CCGT3252AL	9,53	3/8	9,67	.381	3,97	5/32	0,8	.031	4,40	.173	6846533	6968752
CCGT120402AL	CCGT4305AL	12,70	1/2	12,90	.508	4,76	3/16	0,2	.008	5,50	.217	6846584	6968753
CCGT120404AL	CCGT431AL	12,70	1/2	12,90	.508	4,76	3/16	0,4	.016	5,50	.217	6846585	6968753
CCGT120408AL	CCGT432AL	12,70	1/2	12,90	.508	4,76	3/16	0,8	.031	5,50	.217	6846586	6968754

## DCGT-AL • Inserts for Aluminum

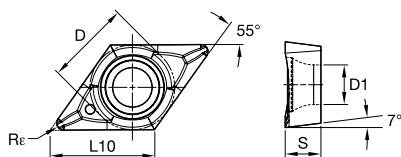

- first choice
- alternate choice

P	■	■	○
M	■	■	○
K	■	■	○
N	■	●	○
S	■	○	○
H	■	■	○

ISO catalog number	ANSI catalog number	D		L10		S		Rε		D1		WU10HT	WU05PT
		mm	in	mm	in	mm	in	mm	in	mm	in		
DCGT070202AL	DCGT21505AL	6,35	1/4	7,75	.305	2,38	3/32	0,2	.008	2,90	.114	6846587	6846587
DCGT070204AL	DCGT2151AL	6,35	1/4	7,75	.305	2,38	3/32	0,4	.016	2,90	.114	6846598	6968755
DCGT11T302AL	DCGT32505AL	9,53	3/8	11,63	.458	3,97	5/32	0,2	.008	4,40	.173	6846589	6846589
DCGT11T304AL	DCGT3251AL	9,53	3/8	11,59	.457	3,97	5/32	0,4	.016	4,40	.173	6846590	6968756
DCGT11T308AL	DCGT3252AL	9,53	3/8	11,63	.458	3,97	5/32	0,8	.031	4,40	.173	6846591	6968757

## RCGT-AL • Inserts for Aluminum

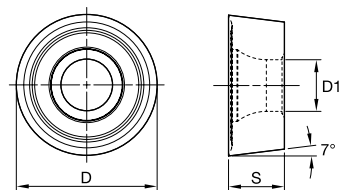

- first choice
- alternate choice

P	■	■	○
M	■	■	○
K	■	■	○
N	■	●	○
S	■	○	○
H	■	■	○

ISO catalog number	ANSI catalog number	D		S		D1		WU10HT	WU05PT
		mm	in	mm	in	mm	in		
RCGT0803M0AL	RCGT0803M0AL	8,00	.315	3,18	1/8	3,40	.134	6846592	6968758
RCGT1204M0AL	RCGT1204M0AL	12,00	.4724	4,76	3/16	4,40	.173	6846592	6968758

# High-Performance Inserts for Machining Aluminum

INDEXABLE MILLING

SOLID END MILLING

HOLEMAKING

TAPPING

TURNING

## TCGT-AL • Inserts for Aluminum

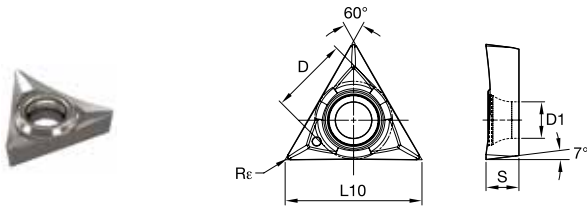

- first choice
- alternate choice

P	■	■	○
M	■	■	○
K	■	■	○
N	■	●	○
S	■	○	○
H	■	■	○

ISO catalog number	ANSI catalog number	D		L10		S		Re		D1		WU10HT	WU05PT
		mm	in	mm	in	mm	in	mm	in	mm	in		
TCGT110204AL	TCGT2151AL	6,35	1/4	11,00	.433	2,38	3/32	0,4	.016	2,80	.110	6846593	6968759
TCGT16T304AL	TCGT3251AL	9,53	3/8	16,51	.650	3,97	5/32	0,4	.016	4,40	.173	6846594	6968760
TCGT16T308AL	TCGT3252AL	9,53	3/8	16,50	.650	3,97	5/32	0,8	.031	4,40	.173	6846595	6968761

## VCGT-AL • Inserts for Aluminum

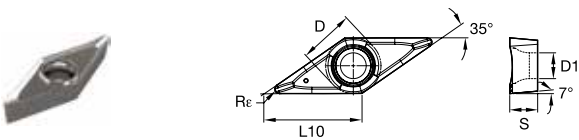

- first choice
- alternate choice

P	■	■	○
M	■	■	○
K	■	■	○
N	■	●	○
S	■	○	○
H	■	■	○

ISO catalog number	ANSI catalog number	D		L10		S		Re		D1		WU10HT	WU05PT
		mm	in	mm	in	mm	in	mm	in	mm	in		
VCGT160404AL	VCGT331AL	9,53	3/8	16,61	.654	4,76	3/16	0,4	.031	4,40	.173	6968762	6968763
VCGT160408AL	VCGT332AL	9,53	3/8	16,61	.654	4,76	3/16	0,8	.031	4,40	.173	6968763	6968763

## VBGT-AL • Inserts for Aluminum

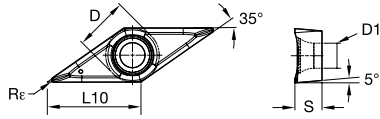

- first choice
- alternate choice

P	<input type="checkbox"/>	<input type="checkbox"/>	<input type="checkbox"/>
M	<input type="checkbox"/>	<input type="checkbox"/>	<input type="checkbox"/>
K	<input type="checkbox"/>	<input type="checkbox"/>	<input type="checkbox"/>
N	<input checked="" type="checkbox"/>	<input checked="" type="checkbox"/>	<input checked="" type="checkbox"/>
S	<input type="checkbox"/>	<input type="checkbox"/>	<input type="checkbox"/>
H	<input type="checkbox"/>	<input type="checkbox"/>	<input type="checkbox"/>

ISO catalog number	ANSI catalog number	D		L10		S		Re		D1		WU10HT	WU05PT
		mm	in	mm	in	mm	in	mm	in	mm	in		
VBGT160404AL	VBGT331AL	9,53	3/8	16,61	.654	4,76	3/16	0,4	.016	4,40	.173	6846596	I
VBGT160408AL	VBGT332AL	9,53	3/8	16,46	.648	4,76	3/16	0,8	.031	4,40	.173	6846597	I

INDEXABLE MILLING

SOLID END MILLING

HOLE/MAKING

TAPPING

TURNING

# Advanced Material Inserts

## Ceramic, PcBN, PCD Inserts

Hard part turning, along with the machining of cast irons, high-temp alloys, and non-ferrous materials, can be accomplished through the use of inserts made from advanced materials. These advanced materials include ceramics, PcBN (polycrystalline cubic boron nitride), and PCD (polycrystalline diamond).

### ADVANCED MATERIAL INSERT COMPOSITION

#### CERAMIC INSERTS

- Silicon-nitride based ceramic for cast iron machining.
- Mixed ceramic for hard machining and finishing of cast iron.
- Whisker ceramic for high-temp alloy and hard part turning.

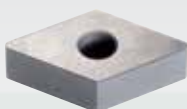

#### PCBN SOLID INSERTS

- Inserts are made only from PcBN.
- No material joint.
- Best heat-absorption capacity.
- Can work at highest temperatures.
- Inserts suitable for hard part turning with interruptions.



#### PcBN Tipped Inserts

- Require a carrier and a PcBN tip.
- The tips are brazed to a carrier.
- The substrate has to have a pocket that will accommodate and support the tip.
- Inserts are available in Multi Tip.
- Inserts suitable for hard part turning in continuous and interrupted applications.

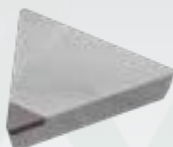

#### PCD Inserts

- Targeted machining of non-ferrous materials.
- Significant advantage in hardness over carbide tools.
- Increased productivity through higher speeds and longer tool life.
- Best used in processing materials that are un-machinable with conventional tooling.



# ADVANCED MATERIAL INSERTS

**MATERIALS**



**CERAMIC**

- Ceramics offer greater wear resistance and toughness.
- Ceramics can be used in high-speed, continuous, and lightly interrupted turning applications in cast iron materials.
- Ceramics can be used for high-speed applications in high-temp alloys.
- Ceramics can also be used for hard part turning.

**MATERIALS**



**PCBN**

- PVD-coated grades available.
- Complete range of CBN grades for continuous to heavily interrupted turning.
- Industry-leading grades for gray cast iron machining.
- Full line of grades for hard part turning.
- For best performance: solid, full-top, and tipped inserts are available.

**MATERIALS**



**PCD**

- Two PCD grades — WDN25U and WDN00U — cover a wide range of applications.
- New grades provide outstanding performance to increase productivity and cut manufacturing costs.
- High abrasion and chipping resistance.
- Used in machining aluminum alloys with low- and high-silicon content, copper alloys, ceramics, and plastics.
- Suitable for machining highly abrasive materials such as titanium and Metal Matrix Composites (MMC).

**INDUSTRY**





## Catalog Numbering System

Each character in our catalog number signifies a specific trait of that product. Use the following key columns and corresponding images to easily identify which attributes apply.

C		C		G		W		2																																																																																																																																																																																																																																			
Insert Shape		Insert Clearance Angle		Tolerance Class		Insert Features		Size																																																																																																																																																																																																																																			
<b>H</b>	Hexagon 120°		<b>A</b>	3°	<p>Tolerances apply prior to edge prep and coating</p> <p><b>D</b> = Theoretical diameter of the insert inscribed circle  <b>S</b> = Thickness  <b>B</b> = See figures below</p>	<b>N</b>		<table border="1"> <thead> <tr> <th colspan="2">"D"</th> <th colspan="7">Code for inch cutting edge length "L10"</th> </tr> <tr> <th>inch</th> <th>inch</th> <th>C</th> <th>D</th> <th>R</th> <th>S</th> <th>T</th> <th>V</th> <th>W</th> </tr> </thead> <tbody> <tr> <td>1.2 (5)</td> <td>5/32</td> <td>S4</td> <td>04</td> <td>03</td> <td>03</td> <td>06</td> <td>—</td> <td>—</td> </tr> <tr> <td>1.5 (6)</td> <td>3/16</td> <td>04</td> <td>05</td> <td>04</td> <td>04</td> <td>08</td> <td>08</td> <td>S3</td> </tr> <tr> <td>1.8 (7)</td> <td>7/32</td> <td>05</td> <td>06</td> <td>05</td> <td>05</td> <td>09</td> <td>09</td> <td>03</td> </tr> <tr> <td>—</td> <td>.236</td> <td>—</td> <td>—</td> <td>06</td> <td>—</td> <td>—</td> <td>—</td> <td>—</td> </tr> <tr> <td>2</td> <td>1/4</td> <td>06</td> <td>07</td> <td>06</td> <td>06</td> <td>11</td> <td>11</td> <td>04</td> </tr> <tr> <td>2.5</td> <td>5/16</td> <td>08</td> <td>09</td> <td>07</td> <td>07</td> <td>13</td> <td>13</td> <td>05</td> </tr> <tr> <td>—</td> <td>.315</td> <td>—</td> <td>—</td> <td>08</td> <td>—</td> <td>—</td> <td>—</td> <td>—</td> </tr> <tr> <td>3</td> <td>3/8</td> <td>09</td> <td>11</td> <td>09</td> <td>09</td> <td>16</td> <td>16</td> <td>06</td> </tr> <tr> <td>—</td> <td>.394</td> <td>—</td> <td>—</td> <td>10</td> <td>—</td> <td>—</td> <td>—</td> <td>—</td> </tr> <tr> <td>3.5</td> <td>7/16</td> <td>11</td> <td>13</td> <td>11</td> <td>11</td> <td>19</td> <td>19</td> <td>07</td> </tr> <tr> <td>—</td> <td>.472</td> <td>—</td> <td>—</td> <td>12</td> <td>—</td> <td>—</td> <td>—</td> <td>—</td> </tr> <tr> <td>4</td> <td>1/2</td> <td>12</td> <td>15</td> <td>12</td> <td>12</td> <td>22</td> <td>22</td> <td>08</td> </tr> <tr> <td>4.5</td> <td>9/16</td> <td>14</td> <td>17</td> <td>14</td> <td>14</td> <td>24</td> <td>24</td> <td>09</td> </tr> <tr> <td>5</td> <td>5/8</td> <td>16</td> <td>19</td> <td>15</td> <td>15</td> <td>27</td> <td>27</td> <td>10</td> </tr> <tr> <td>—</td> <td>.630</td> <td>—</td> <td>—</td> <td>16</td> <td>—</td> <td>—</td> <td>—</td> <td>—</td> </tr> <tr> <td>5.5</td> <td>11/16</td> <td>17</td> <td>21</td> <td>17</td> <td>17</td> <td>30</td> <td>30</td> <td>11</td> </tr> <tr> <td>6</td> <td>3/4</td> <td>19</td> <td>23</td> <td>19</td> <td>19</td> <td>33</td> <td>33</td> <td>13</td> </tr> <tr> <td>—</td> <td>.787</td> <td>—</td> <td>—</td> <td>20</td> <td>—</td> <td>—</td> <td>—</td> <td>—</td> </tr> <tr> <td>7</td> <td>7/8</td> <td>22</td> <td>27</td> <td>22</td> <td>22</td> <td>38</td> <td>38</td> <td>15</td> </tr> <tr> <td>—</td> <td>.984</td> <td>—</td> <td>—</td> <td>25</td> <td>—</td> <td>—</td> <td>—</td> <td>—</td> </tr> <tr> <td>8</td> <td>1</td> <td>25</td> <td>31</td> <td>25</td> <td>25</td> <td>44</td> <td>44</td> <td>17</td> </tr> <tr> <td>10</td> <td>1-1/4</td> <td>32</td> <td>38</td> <td>31</td> <td>31</td> <td>54</td> <td>54</td> <td>21</td> </tr> <tr> <td>—</td> <td>1.260</td> <td>—</td> <td>—</td> <td>32</td> <td>—</td> <td>—</td> <td>—</td> <td>—</td> </tr> </tbody> </table>	"D"		Code for inch cutting edge length "L10"							inch	inch	C	D	R	S	T	V	W	1.2 (5)	5/32	S4	04	03	03	06	—	—	1.5 (6)	3/16	04	05	04	04	08	08	S3	1.8 (7)	7/32	05	06	05	05	09	09	03	—	.236	—	—	06	—	—	—	—	2	1/4	06	07	06	06	11	11	04	2.5	5/16	08	09	07	07	13	13	05	—	.315	—	—	08	—	—	—	—	3	3/8	09	11	09	09	16	16	06	—	.394	—	—	10	—	—	—	—	3.5	7/16	11	13	11	11	19	19	07	—	.472	—	—	12	—	—	—	—	4	1/2	12	15	12	12	22	22	08	4.5	9/16	14	17	14	14	24	24	09	5	5/8	16	19	15	15	27	27	10	—	.630	—	—	16	—	—	—	—	5.5	11/16	17	21	17	17	30	30	11	6	3/4	19	23	19	19	33	33	13	—	.787	—	—	20	—	—	—	—	7	7/8	22	27	22	22	38	38	15	—	.984	—	—	25	—	—	—	—	8	1	25	31	25	25	44	44	17	10	1-1/4	32	38	31	31	54	54	21	—	1.260	—	—	32	—	—	—	—	<b>R</b>	
"D"		Code for inch cutting edge length "L10"																																																																																																																																																																																																																																									
inch	inch	C	D	R		S	T		V	W																																																																																																																																																																																																																																	
1.2 (5)	5/32	S4	04	03		03	06		—	—																																																																																																																																																																																																																																	
1.5 (6)	3/16	04	05	04		04	08		08	S3																																																																																																																																																																																																																																	
1.8 (7)	7/32	05	06	05		05	09		09	03																																																																																																																																																																																																																																	
—	.236	—	—	06		—	—		—	—																																																																																																																																																																																																																																	
2	1/4	06	07	06		06	11		11	04																																																																																																																																																																																																																																	
2.5	5/16	08	09	07		07	13		13	05																																																																																																																																																																																																																																	
—	.315	—	—	08		—	—		—	—																																																																																																																																																																																																																																	
3	3/8	09	11	09	09	16	16	06																																																																																																																																																																																																																																			
—	.394	—	—	10	—	—	—	—																																																																																																																																																																																																																																			
3.5	7/16	11	13	11	11	19	19	07																																																																																																																																																																																																																																			
—	.472	—	—	12	—	—	—	—																																																																																																																																																																																																																																			
4	1/2	12	15	12	12	22	22	08																																																																																																																																																																																																																																			
4.5	9/16	14	17	14	14	24	24	09																																																																																																																																																																																																																																			
5	5/8	16	19	15	15	27	27	10																																																																																																																																																																																																																																			
—	.630	—	—	16	—	—	—	—																																																																																																																																																																																																																																			
5.5	11/16	17	21	17	17	30	30	11																																																																																																																																																																																																																																			
6	3/4	19	23	19	19	33	33	13																																																																																																																																																																																																																																			
—	.787	—	—	20	—	—	—	—																																																																																																																																																																																																																																			
7	7/8	22	27	22	22	38	38	15																																																																																																																																																																																																																																			
—	.984	—	—	25	—	—	—	—																																																																																																																																																																																																																																			
8	1	25	31	25	25	44	44	17																																																																																																																																																																																																																																			
10	1-1/4	32	38	31	31	54	54	21																																																																																																																																																																																																																																			
—	1.260	—	—	32	—	—	—	—																																																																																																																																																																																																																																			
<b>F</b>		<b>M</b>																																																																																																																																																																																																																																									
<b>A</b>		<b>G</b>																																																																																																																																																																																																																																									
<b>W</b>		<b>W</b>																																																																																																																																																																																																																																									
<b>T</b>		<b>T</b>																																																																																																																																																																																																																																									
<b>Q</b>		<b>Q</b>																																																																																																																																																																																																																																									
<b>U</b>		<b>U</b>																																																																																																																																																																																																																																									
<b>B</b>		<b>B</b>																																																																																																																																																																																																																																									
<b>H</b>		<b>H</b>																																																																																																																																																																																																																																									
<b>C</b>		<b>C</b>																																																																																																																																																																																																																																									
<b>J</b>		<b>J</b>																																																																																																																																																																																																																																									
<b>X</b>		<b>X</b>																																																																																																																																																																																																																																									
<b>V</b>		<b>V</b>																																																																																																																																																																																																																																									
			<b>X</b>	Special Design																																																																																																																																																																																																																																							

\*Tolerances apply prior to edge prep and coating.

Catalog Numbering System

(continued)

<b>15</b>	<b>05</b>		<b>E</b>			<b>C</b>																																																																																															
Thickness "S"	Corner Radius "Re"	Hand of Insert (optional)	Cutting Edge (optional)	T-Land Width (optional)	T-Land Angle (optional)	Tip Style (optional)	Chipbreaker (optional)																																																																																														
<table border="1"> <thead> <tr> <th>symbol</th> <th>thick- ness</th> </tr> <tr> <th>inch</th> <th>inch</th> </tr> </thead> <tbody> <tr><td>.5 (1)</td><td>1/32</td></tr> <tr><td>.6</td><td>.040</td></tr> <tr><td>1 (2)</td><td>1/16</td></tr> <tr><td>1.2</td><td>5.64</td></tr> <tr><td>1.5 (3)</td><td>3/32</td></tr> <tr><td>2</td><td>1/8</td></tr> <tr><td>2.5</td><td>5/32</td></tr> <tr><td>3</td><td>3/16</td></tr> <tr><td>3.5</td><td>7/32</td></tr> <tr><td>4</td><td>1/4</td></tr> <tr><td>5</td><td>5/16</td></tr> <tr><td>6</td><td>3/8</td></tr> <tr><td>7</td><td>7/16</td></tr> <tr><td>8</td><td>1/2</td></tr> </tbody> </table>	symbol	thick- ness	inch	inch	.5 (1)	1/32	.6	.040	1 (2)	1/16	1.2	5.64	1.5 (3)	3/32	2	1/8	2.5	5/32	3	3/16	3.5	7/32	4	1/4	5	5/16	6	3/8	7	7/16	8	1/2	<table border="1"> <thead> <tr> <th>symbol</th> <th>corner radius</th> </tr> <tr> <th>inch</th> <th>inch</th> </tr> </thead> <tbody> <tr><td>X0</td><td>.0015</td></tr> <tr><td>0</td><td>.004</td></tr> <tr><td>.5</td><td>.008</td></tr> <tr><td>1</td><td>1/64</td></tr> <tr><td>2</td><td>1/32</td></tr> <tr><td>3</td><td>3/64</td></tr> <tr><td>4</td><td>1/16</td></tr> <tr><td>5</td><td>5/64</td></tr> <tr><td>6</td><td>3/32</td></tr> <tr><td>7</td><td>7/64</td></tr> <tr><td>8</td><td>1/8</td></tr> <tr><td>—</td><td>round insert</td></tr> </tbody> </table>	symbol	corner radius	inch	inch	X0	.0015	0	.004	.5	.008	1	1/64	2	1/32	3	3/64	4	1/16	5	5/64	6	3/32	7	7/64	8	1/8	—	round insert	<p>R = Right hand</p> <p>L = Left hand</p> <p>N = Neutral</p>	<p>F* Sharp</p> <p>E Rounded</p> <p>T* Chamfered</p> <p>S* Chamfered and Rounded</p> <p>K Double-Chamfered</p> <p>P Double-Chamfered and Rounded</p> <p><i>*Also available in wiper style.</i></p>	<table border="1"> <thead> <tr> <th>symbol</th> <th>inch</th> <th>size</th> </tr> <tr> <th>ANSI</th> <th>size</th> <th></th> </tr> </thead> <tbody> <tr><td>04</td><td>.004</td><td></td></tr> <tr><td>08</td><td>.008</td><td></td></tr> </tbody> </table>	symbol	inch	size	ANSI	size		04	.004		08	.008		<table border="1"> <thead> <tr> <th>symbol</th> <th>size</th> </tr> </thead> <tbody> <tr><td>10</td><td>10°</td></tr> <tr><td>15</td><td>15°</td></tr> <tr><td>20</td><td>20°</td></tr> <tr><td>25</td><td>25°</td></tr> <tr><td>30</td><td>30°</td></tr> </tbody> </table>	symbol	size	10	10°	15	15°	20	20°	25	25°	30	30°	<p>FW = Finishing Wiper</p> <p>MW = Medium Wiper</p> <table border="1"> <thead> <tr> <th>symbol</th> <th>usage</th> </tr> </thead> <tbody> <tr><td>C</td><td>full top</td></tr> <tr><td>M</td><td>mini tip</td></tr> <tr><td>MT</td><td>multi-tip</td></tr> <tr><td>ST</td><td>single tip</td></tr> </tbody> </table>	symbol	usage	C	full top	M	mini tip	MT	multi-tip	ST	single tip	
symbol	thick- ness																																																																																																				
inch	inch																																																																																																				
.5 (1)	1/32																																																																																																				
.6	.040																																																																																																				
1 (2)	1/16																																																																																																				
1.2	5.64																																																																																																				
1.5 (3)	3/32																																																																																																				
2	1/8																																																																																																				
2.5	5/32																																																																																																				
3	3/16																																																																																																				
3.5	7/32																																																																																																				
4	1/4																																																																																																				
5	5/16																																																																																																				
6	3/8																																																																																																				
7	7/16																																																																																																				
8	1/2																																																																																																				
symbol	corner radius																																																																																																				
inch	inch																																																																																																				
X0	.0015																																																																																																				
0	.004																																																																																																				
.5	.008																																																																																																				
1	1/64																																																																																																				
2	1/32																																																																																																				
3	3/64																																																																																																				
4	1/16																																																																																																				
5	5/64																																																																																																				
6	3/32																																																																																																				
7	7/64																																																																																																				
8	1/8																																																																																																				
—	round insert																																																																																																				
symbol	inch	size																																																																																																			
ANSI	size																																																																																																				
04	.004																																																																																																				
08	.008																																																																																																				
symbol	size																																																																																																				
10	10°																																																																																																				
15	15°																																																																																																				
20	20°																																																																																																				
25	25°																																																																																																				
30	30°																																																																																																				
symbol	usage																																																																																																				
C	full top																																																																																																				
M	mini tip																																																																																																				
MT	multi-tip																																																																																																				
ST	single tip																																																																																																				

"D"	± Tolerance on "D"				"D"	± Tolerance on "B"			
	Class M Tolerance			Class U Tolerance		Class M Tolerance			Class U Tolerance
	Shapes S, T, C, R, & W	Shape D	Shape V	Shapes S, T, & C		Shapes S, T, C, R, & W	Shape D	Shape V	Shapes S, T, & C
inch	inch	inch	inch	inch	inch	inch	inch	inch	
5/32	.002	—	—	—	5/32	.003	—	—	—
3/16	.002	—	—	.003	3/16	.003	—	—	.005
7/32	.002	.002	.002	.003	7/32	.003	.004	—	.005
1/4	.002	.002	.002	.003	1/4	.003	.004	—	.005
5/16	.002	.002	.002	.003	5/16	.003	.004	—	.005
3/8	.002	.002	.002	.003	3/8	.003	.004	.007	.005
7/16	.003	.003	.003	.005	7/16	.005	.006	—	—
1/2	.003	.003	.003	.005	1/2	.005	.006	.010	.008
9/16	.003	.003	.003	.005	9/16	.005	.006	—	—
5/8	.004	.004	.004	.007	5/8	.006	.007	—	.011
11/16	.004	.004	.004	.007	11/16	.006	.007	—	.011
3/4	.004	.004	.004	.007	3/4	.006	.007	—	.011
7/8	.005	—	—	.010	7/8	.006	—	—	.015
1	.005	—	—	.010	1	.007	—	—	.015
1 1/4	.006	—	—	.010	1 1/4	.008	—	—	.015

## WBH20P™ for Enhanced Performance — Five Unique Features

INDEXABLE MILLING

SOLID END MILLING

HOLEMAKING

TAPPING

TURNING

### 1 Newly developed substrate enables application in a wide variety of demanding situations.

The substrate contains superhard grains with a uniquely formulated size distribution and nano-structured binder phase. This unique combination provides an unparalleled balance of wear resistance and toughness. The net result is a robust hard turning tooling solution for a wide range of applications, including continuous to interrupted cutting.

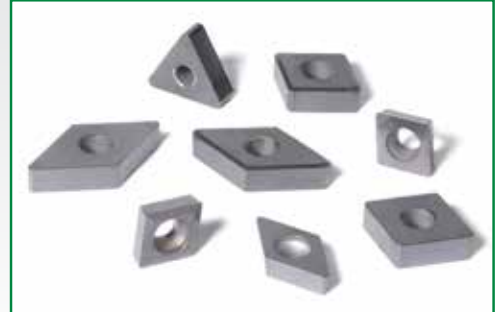

### 2 Nano-composite coating that enhances speed capabilities and tool life.

- Specially developed, advanced PVD coating with nano-composite architecture for improved performance.
- Improved wear resistance by PVD coating chemistry technology for machining hardened steels.
- Enhanced PVD coating adhesion on PcBN substrates.

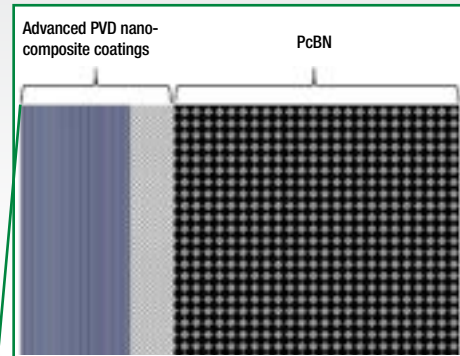

### 3 Improved edge preparation technology for longer tool life, reliable performance, better surface finish, and tighter workpiece tolerances.

A critical performance factor is the edge preparation itself. The grind direction, surface roughness, hone sizes, and tolerances have great impact on performance and process reliability. WIDIA™ has performed significant research work and optimized edge preparation to improve your overall machining effectiveness.

WBH20P™ for Enhanced Performance — Five Unique Features

(continued)

4 Large standard portfolio.

Standard edge preparation — the optimum combination of T-land angle, T-land width, and hone size — is paramount in achieving maximum performance. WIDIA™ has developed three standard edge configurations, including wiper inserts.

- Light machining edge prep E.
  - Medium machining edge prep S01015.
  - Heavy machining edge prep S01025.
- E: Honed cutting edge  
 S01015:  $W \times \beta = 0,10\text{mm} \times 15^\circ$   
 S01025:  $W \times \beta = 0,10\text{mm} \times 25^\circ$

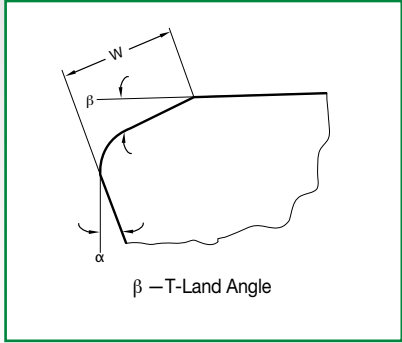

These edge preps are available in common styles, sizes, and nose radii in both positive and negative geometries.

5 CB1 chipbreaker in positive and negative geometries, solving chipbreaking and chip control issues.

Chipbreaker — when machining case-hardened steel with a hard outer skin and a tough and softer core, a chipbreaker provides a great advantage. The CB1 chipbreaker is a proven solution to effectively breaking chips. Long chips can form bird nests, causing machine malfunctions, increasing scrap-rates, and reducing the overall equipment effectiveness.

Available as a custom solution product.

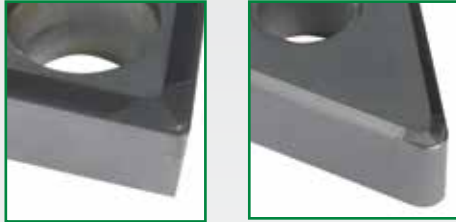

Insert without Chipbreaker



- Long chips.
- Bird-nest formation.

Insert with Chipbreaker



- Chips are broken.

INDEXABLE MILLING

SOLID END MILLING

HOLEMAKING

TAPPING

TURNING

## Grade Numbering System — Ceramics

CW	2	0	15
Brand	Cutting Material Group		Application Range
CW = WIDIA™	<ul style="list-style-type: none"> <li>2 = CM Mixed (black) ceramic</li> <li>3 = CR Whisker reinforced ceramic</li> <li>5 = CN Silicon-nitride ceramic</li> </ul>	<ul style="list-style-type: none"> <li>0 = Stationary cutting edges (turning, parting, threading)</li> <li>1 = First successor</li> <li>2 = Semi-standard rotating cutting edges</li> <li>3 = Semi-standard general applications</li> <li>5 = Rotating cutting edges (milling, drilling, reaming)</li> </ul>	<ul style="list-style-type: none"> <li>05 = fine finishing</li> <li>10 = finishing</li> <li>15 = } medium to roughing</li> <li>20 = }</li> <li>25 = }</li> <li>30 = } roughing</li> <li>35 = }</li> <li>40 = }</li> <li>45 = } heaviest roughing</li> <li>50 = }</li> </ul>



Grade Numbering System — PcBN and PCD

<b>W</b>	<b>B</b>	<b>H</b>	<b>30</b>	<b>P</b>
Brand	Cutting Material Group	Material Range	Application Range	Coating
WIDIA™	<p><b>B</b> = CBN</p> <p><b>D</b> = PCD</p>	<p><b>H</b> = hardened materials</p> <p><b>N</b> = non-ferrous materials</p>	<p><b>05</b> = fine finishing</p> <p><b>10</b> = finishing</p> <p><b>15</b> = } medium to roughing</p> <p><b>20</b> = }</p> <p><b>25</b> = }</p> <p><b>30</b> = } roughing</p> <p><b>35</b> = }</p> <p><b>40</b> = }</p> <p><b>45</b> = } heaviest roughing</p> <p><b>50</b> = }</p>	<p><b>U</b> = Uncoated</p> <p><b>C</b> = CVD Coated</p> <p><b>P</b> = PVD Coated</p>

<b>P</b>	Steel
<b>M</b>	Stainless Steel
<b>K</b>	Cast Iron
<b>N</b>	Non-Ferrous
<b>S</b>	High-Temp Alloys
<b>H</b>	Hardened Materials
<b>U</b>	Universal Machining

INDEXABLE MILLING

SOLID END MILLING

HOLE/MAKING

TAPPING

TURNING

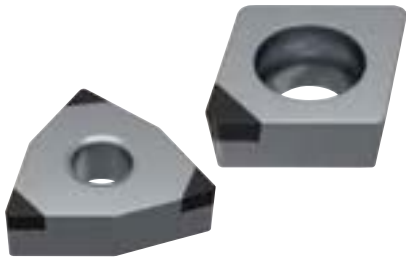

## Cutting Material Groups

The cutting tool materials are classified by the combination of their hardness and wear-resistance characteristics.

The extended standard DIN ISO 513 also includes ceramic cutting materials and the super-hard polycrystalline materials, boron nitride and diamond, resulting in additional identification symbols for these cutting material groups.

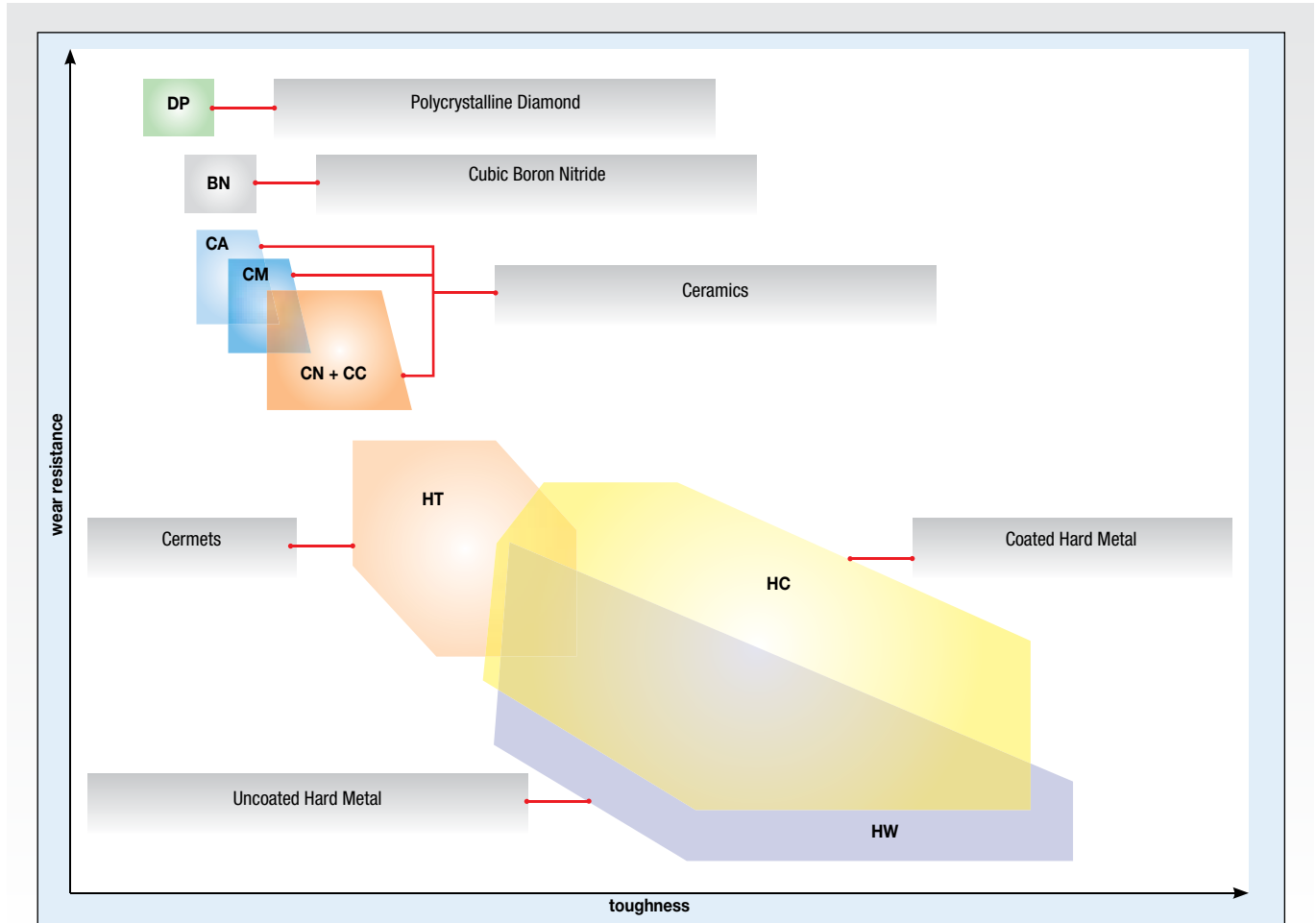

main group	sub-group (symbol)	feature
hard metal	HW	Uncoated WC-base hard metal
	HT	Uncoated TiC/TiN-base hard metal (cermets)
	HC	Coated hard metal
ceramics	CA	Al <sub>2</sub> O <sub>3</sub> -base oxide ceramics
	CM	Composite ceramics Al <sub>2</sub> O <sub>3</sub> + metal carbide
	CN	Si <sub>3</sub> N <sub>4</sub> -base nitride ceramics
	CC	Coated ceramics
cubic boron nitride	BL	Cubic boron nitride (CBN) with low CBN content
	BH	Cubic boron nitride (CBN) with high CBN content
diamond	DP	Polycrystalline diamond (PCD)

## Ceramic Inserts for Hard Turning, Turning in Cast Iron Materials, and Turning in High-Temp Alloys



- Ceramics offer greater wear resistance and toughness.
- Ceramics can be used in high-speed, continuous, and lightly interrupted turning applications in cast iron materials.
- Ceramics can be used for high-speed applications in high-temp alloys.

### Ceramic Turning Grades

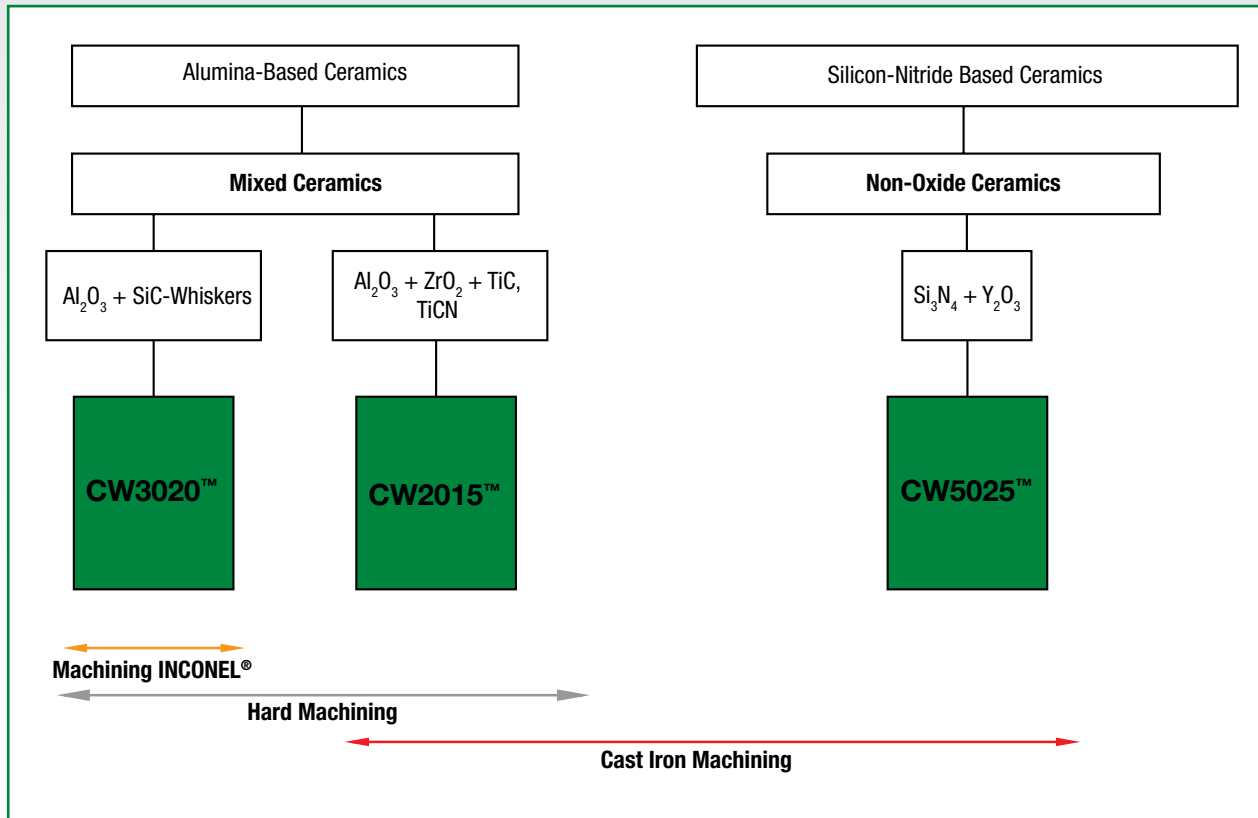

#### CW2015™

- Alumina and titanium carbo-nitride.
- High hardness and wear resistance.
- TiCN increases strength and hardness.
- Black in color.

#### CW3020™

- Alumina + SiC whisker.
- High hardness and wear resistance.
- Whisker ceramic with elongated crystals and very high strength.
- Gray-green color.

#### CW5025™

- Pure silicon-nitride composition.
- Used in high-speed turning applications.
- Designed for use in gray cast iron and lower-tensile ductile irons.



## PcBN Grades for Hard Turning, Powder Metal, and Gray Cast Iron Machining

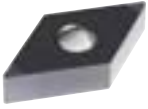

- PVD-coated grades available.
- Complete range of CBN grades for continuous to heavily interrupted turning.
- Industry-leading grades for gray cast iron machining.
- Full line of grades for hard turning.
- For best performance: solid, full-top, and tipped inserts are available.

### Hard Turning Grades

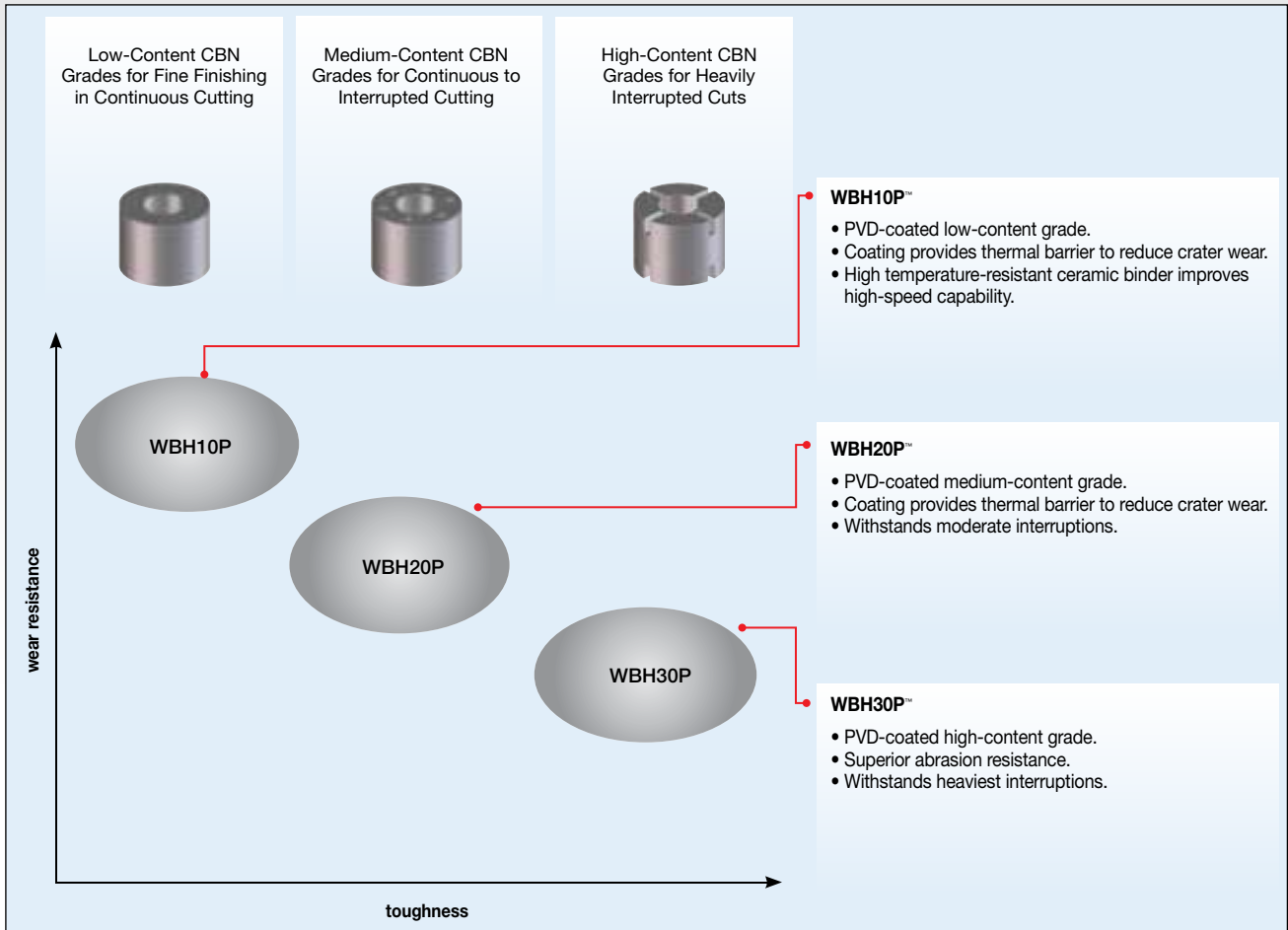

### Gray Cast Iron Grade

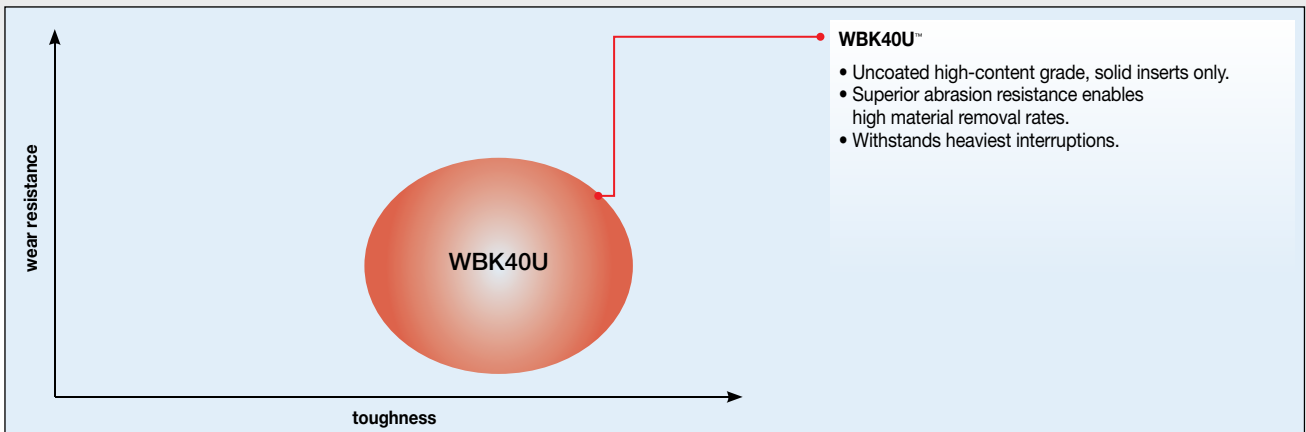

## PCD Grades for Turning Non-Ferrous Materials

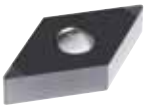

- Two PCD grades — WDN25U and WDN00U — cover a wide range of applications.
- Grades provide outstanding performance to increase productivity and cut manufacturing costs.
- High abrasion and chipping resistance.
- Used in machining aluminum alloys with low- and high-silicon content, copper alloys, ceramics, and plastics.
- Suitable for machining highly abrasive materials such as titanium and Metal Matrix Composites (MMC).

### Non-Ferrous Grades

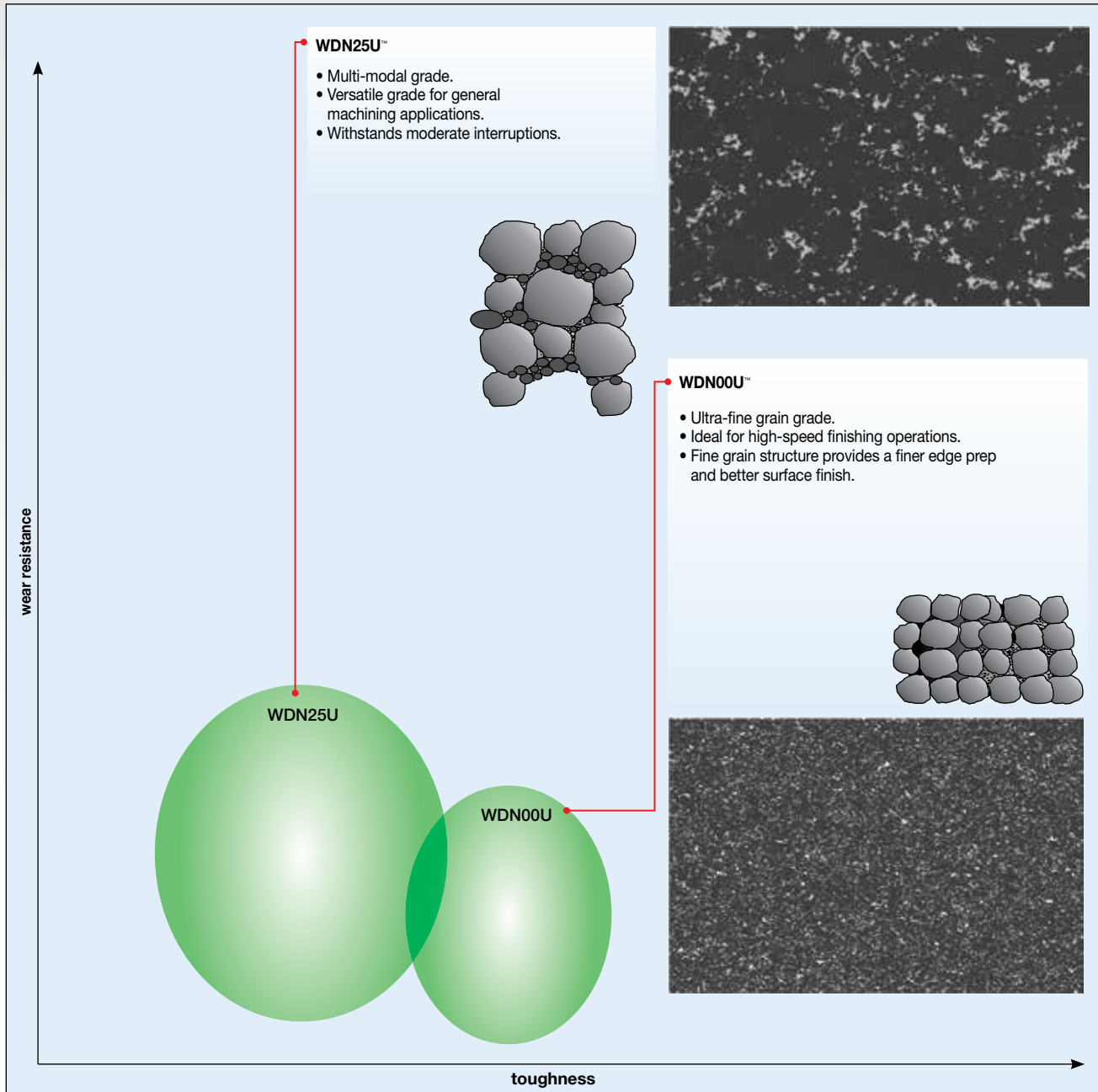

INDEXABLE MILLING

SOLID END MILLING

HOLEMAKING

TAPPING

**TURNING**

## Advanced Materials for Hard Turning

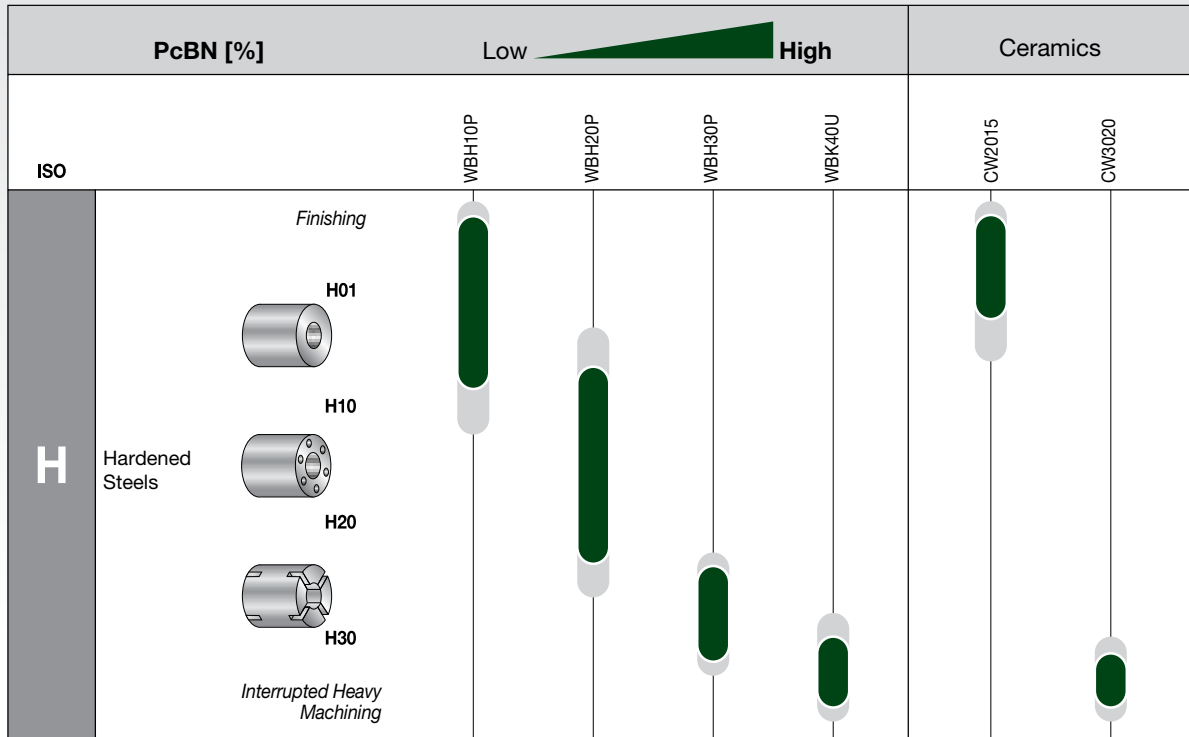

### Hard Turning Grade Selection

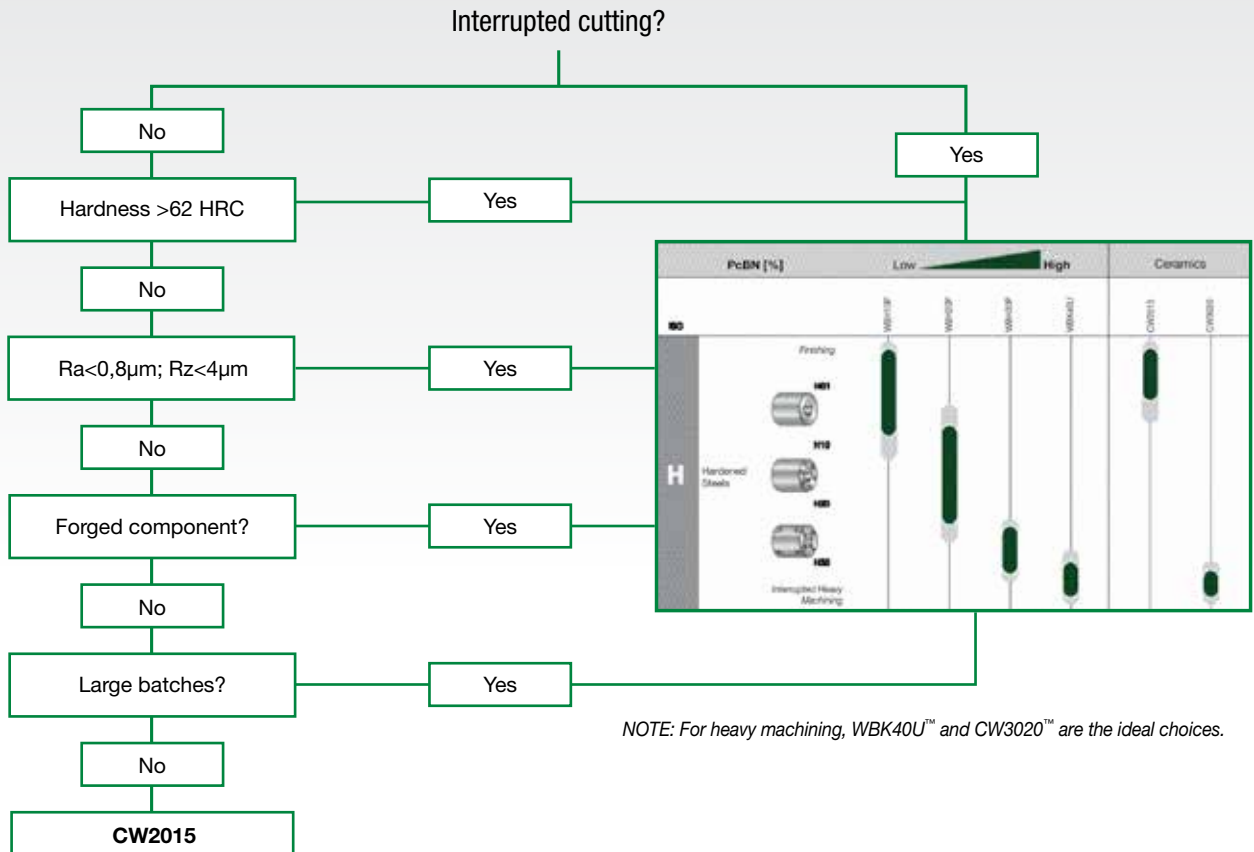

NOTE: For heavy machining, WBK40U™ and CW3020™ are the ideal choices.

## Advanced Materials for Cast Iron Machining

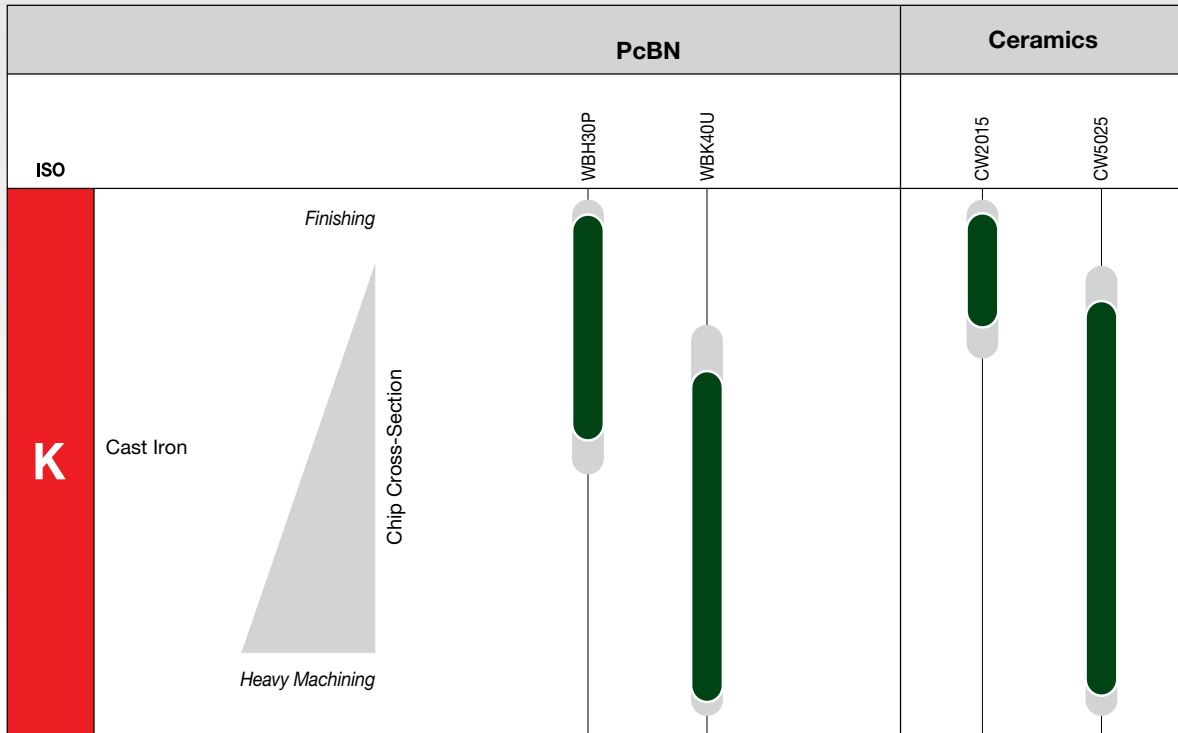

### Cast Iron Machining Grade Selection

Constant and high-quality casting?

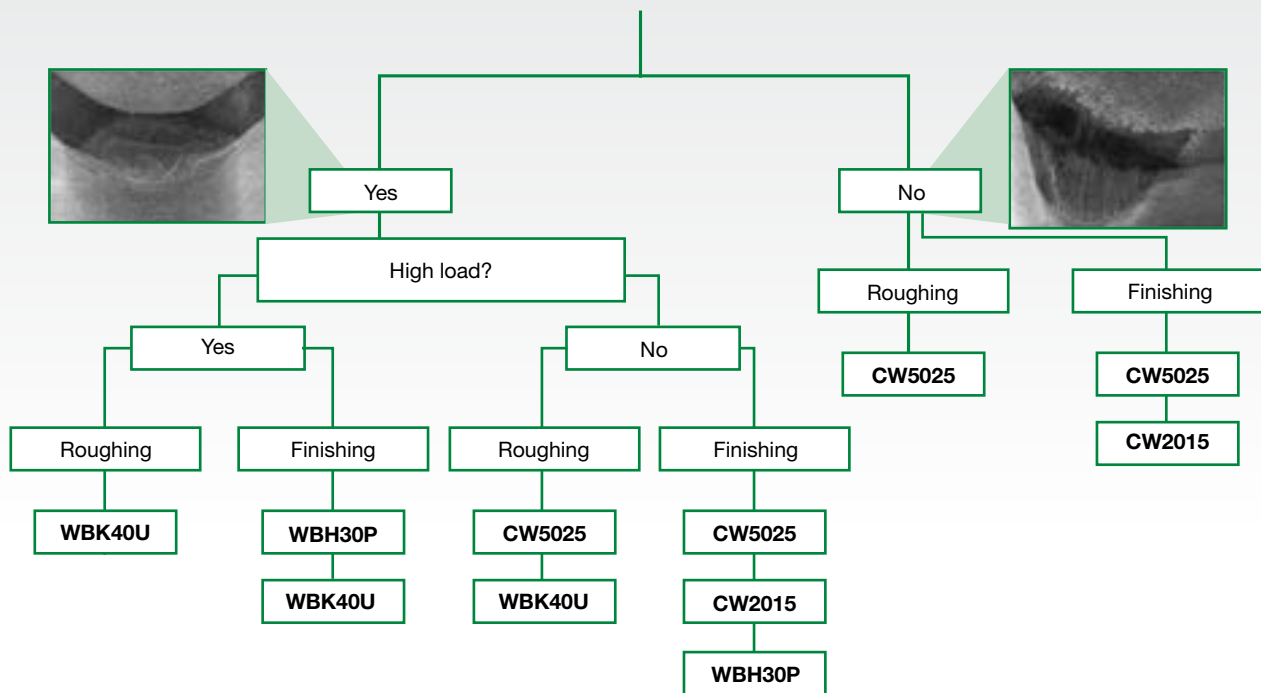

## Advanced Materials for High-Temperature Machining

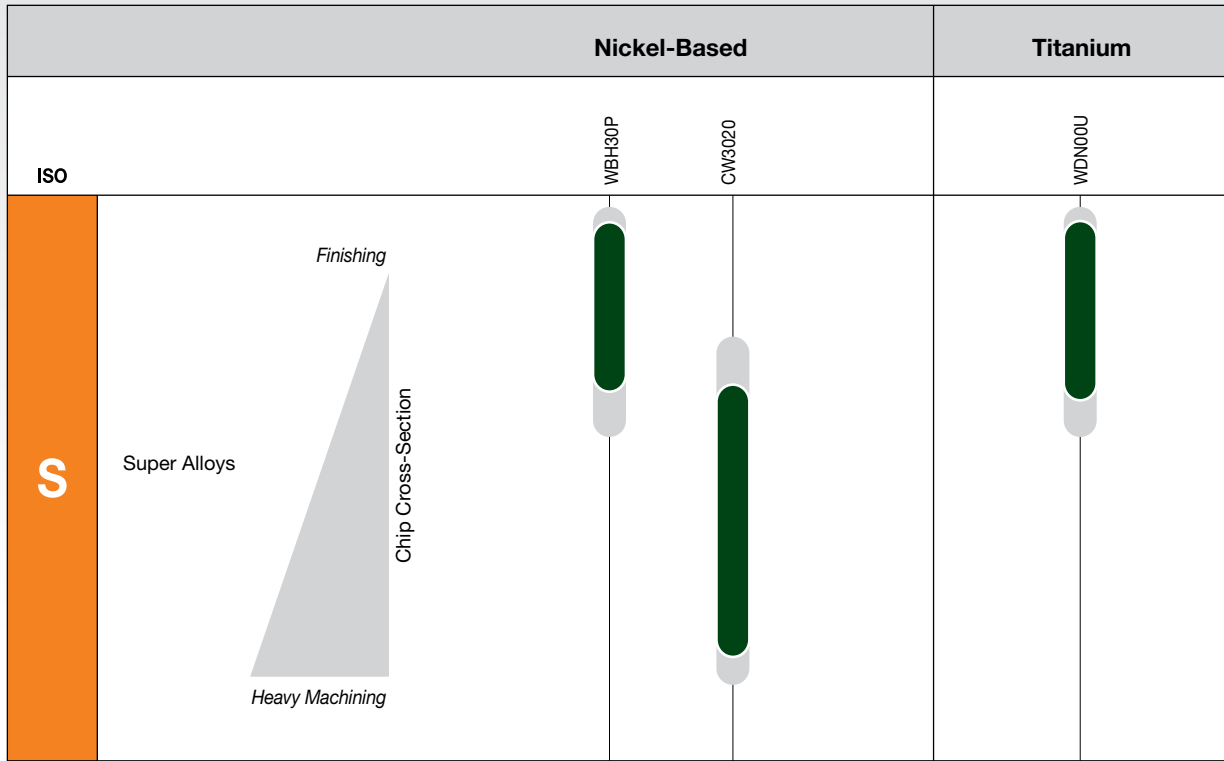

## Advanced Materials for Non-Ferrous Machining

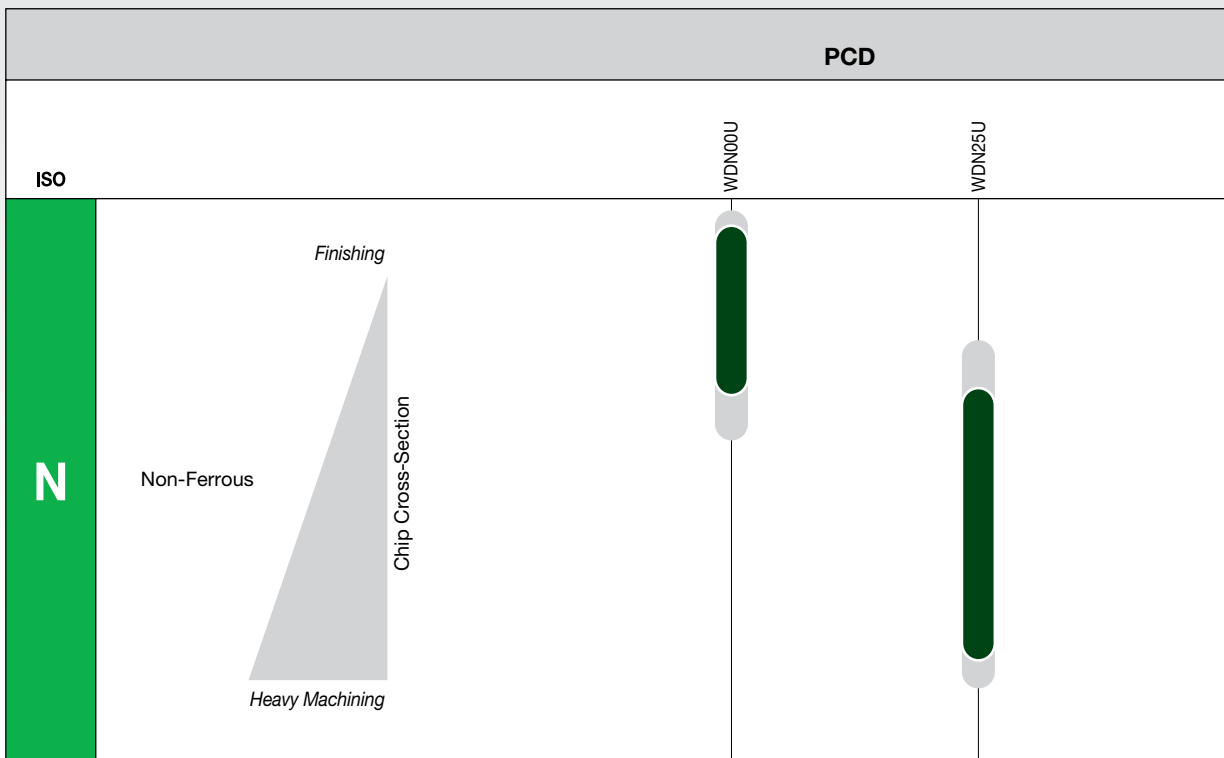

INDEXABLE MILLING

SOLID END MILLING

HOLEMAKING

TAPPING

TURNING

Grades and Grade Descriptions

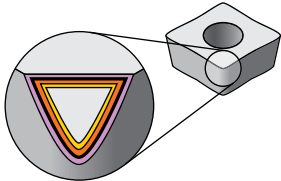

Reduce cycle times. High speed and feed capability. Long tool life. New multi-layer coating provides better wear resistance.

P	Steel
M	Stainless Steel
K	Cast Iron
N	Non-Ferrous
S	High-Temp Alloys
H	Hardened Materials

		wear resistance ← → toughness									
Coating	Grade Description	05	10	15	20	25	30	35	40	45	
CW2015		Mixed (black) ceramic. Matrix Al <sub>2</sub> O <sub>3</sub> and TiCN. Good toughness properties combined with good wear resistance. Semi-finishing and finishing. For hardened iron base materials and gray cast iron (finishing).	P								
	CM-H10		K	K							
CW5025		Silicon-nitride ceramic. Extraordinary toughness properties. Roughing, also in heavily interrupted cuts. Capable of high-performance turning. To be used with or without coolant. For gray cast iron.	P								
	CN-K15		K	K	K						
CW3020		Whisker ceramic with a matrix of Al <sub>2</sub> O <sub>3</sub> + SiCw. The SiC whiskers embedded in the micro-structure give this ceramic excellent toughness for cutting high-temp alloys and cast materials with high Brinell hardness.	P								
	C4		S		S	S					
WBK40U		A high-content CBN, solid CBN insert with multiple cutting edges. Applied in roughing to finishing of fully pearlitic gray cast iron, chilled irons, high-chrome alloyed steels, sintered powdered metals, and heavy cuts in hardened steels (>45 HRC). Use for finishing chilled and fully pearlitic cast iron. Solid inserts offer better security and shock resistance than tipped inserts, while also enabling deeper depth-of-cut capability.	P								
	BN-K40		K					K	K		
WBH10P		A low-content CBN grade with a PVD-AlTiN coating for added wear resistance. Designed for precision machining of hardened steels (>45 HRC); the harder the steel the better. PVD coating offers improved wear resistance and excellent surface finish capability. Effectively applied on bearing steels, hot and cold work tool steels, high-speed steels, die steels, case-hardened steels, carburized and nitrided irons, and some hard coatings.	P								
	BN-H10		H								

INDEXABLE MILLING  
 SOLID END MILLING  
 HOLE/MAKING  
 TAPPING  
 TURNING

## Grades and Grade Descriptions

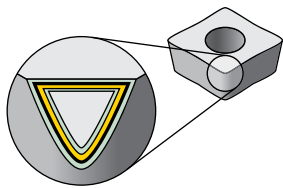

Reduce cycle times. High speed and feed capability. Long tool life. New multi-layer coating provides better wear resistance.

<b>P</b>	Steel
<b>M</b>	Stainless Steel
<b>K</b>	Cast Iron
<b>N</b>	Non-Ferrous
<b>S</b>	High-Temp Alloys
<b>H</b>	Hardened Materials

wear resistance ← → toughness

Grade	Coating	Grade Description	Material Group															
			05	10	15	20	25	30	35	40	45							
WBH20P		A PVD-AlTiN coating over a low-content, CBN tip brazed onto a carbide insert. Designed for roughing to finishing of hardened steels (>45 HRC). Use on bearing steel, hot and cold work tool steels, high-speed steels, die steels, case-hardened steels, carburized and nitrided irons, and some hard coatings.																
	<b>BN-H25</b>																	
WBH30P		A PVD-AlTiN coating over a low-content, CBN tip brazed onto a carbide insert. Designed for roughing to finishing in interrupted cuts on hardened steels (>45 HRC). Applied on gray cast iron, chilled irons, high-chrome alloyed steels, high-temp alloys, and sintered powdered metals.																
	<b>BN-H30</b>																	
WDN00U		An ultra-fine grained polycrystalline diamond (PCD) tip brazed onto a carbide substrate. Designed for general-purpose turning of primarily non-ferrous materials. Applied over a wide range of continuous to interrupted cuts where superior surface finish is needed. Use on low to medium silicon content aluminum alloys, non-metallics, copper, brass, and zinc-based alloys. The ultra-fine grained diamond particle size enables superior surface finishes while ensuring the best mechanical shock resistance of any PCD cutting tool.																
	<b>DP-N10</b>																	
WDN25U		A multi-modal PCD grade with a range of grain sizes brazed onto a carbide substrate. Engineered for extreme abrasion resistance and good edge strength for demanding applications. An ideal choice for high-silicon aluminum alloys, bi-metallic (AL/GC) materials, MMC, carbon-fiber reinforced plastics, and other abrasive non-metallic materials.																
	<b>DP-N25</b>																	

\*Grade available as Custom Solution only.

Speed and Feed Chart • Ceramics • Metric

Material Group		Cutting Speed – vc m/min								
		CW2015			CW3020			CW5025		
		min	Start	max	min	Start	max	min	Start	max
ap [mm]		0,5		4,0	0,5		4,0	1,0		8,0
f [mm/rev]		0,2		0,4	0,1		0,5	0,2		0,6
<b>P</b>	0	-	-	-	-	-	-	-	-	-
	1	-	-	-	-	-	-	-	-	-
	2	-	-	-	-	-	-	-	-	-
	3	-	-	-	-	-	-	-	-	-
	4	-	-	-	-	-	-	-	-	-
	5	-	-	-	-	-	-	-	-	-
<b>M</b>	1	-	-	-	-	-	-	-	-	-
	2	-	-	-	-	-	-	-	-	-
	3	-	-	-	-	-	-	-	-	-
<b>K</b>	1	250	475	725	-	-	-	250	760	1000
	2	300	550	800	-	-	-	275	365	490
	3	250	400	600	-	-	-	275	335	440
<b>N</b>	1	-	-	-	-	-	-	-	-	-
	2	-	-	-	-	-	-	-	-	-
	3	-	-	-	-	-	-	-	-	-
	4	-	-	-	-	-	-	-	-	-
	5	-	-	-	-	-	-	-	-	-
	6	-	-	-	-	-	-	-	-	-
	7	-	-	-	-	-	-	-	-	-
	8	-	-	-	-	-	-	-	-	-
<b>S</b>	1	-	-	-	170	200	375	-	-	-
	2	-	-	-	170	200	375	-	-	-
	3	-	-	-	190	250	375	-	-	-
	4	-	-	-	-	-	-	-	-	-
<b>H</b>	1	60	100	140	45	85	125	-	-	-
	2	60	100	140	45	85	125	-	-	-
	3	60	100	140	45	85	125	-	-	-
	4	60	100	140	45	85	125	-	-	-

INDEXABLE INSERTS

SOLID END MILLING

HOLE MAKING

TAPPING

TURNING



## Speed and Feed Chart • Ceramics • Inch

Material Group		Cutting Speed – vc SFM								
		CW2015			CW3020			CW5025		
		min	Start	max	min	Start	max	min	Start	max
ap [inch]		0.0197		0.1575	0.0197		0.0394	0.0394		0.315
f [inch]		0.0079		0.0157	0.0039		0.0197	0.0047		0.0236
P	0	-	-	-	-	-	-	-	-	-
	1	-	-	-	-	-	-	-	-	-
	2	-	-	-	-	-	-	-	-	-
	3	-	-	-	-	-	-	-	-	-
	4	-	-	-	-	-	-	-	-	-
	5	-	-	-	-	-	-	-	-	-
M	1	-	-	-	-	-	-	-	-	-
	2	-	-	-	-	-	-	-	-	-
	3	-	-	-	-	-	-	-	-	-
K	1	815	1555	2375	-	-	-	800	2500	3300
	2	980	1800	2600	-	-	-	900	1200	1600
	3	820	1310	1965	-	-	-	900	1100	1450
N	1	-	-	-	-	-	-	-	-	-
	2	-	-	-	-	-	-	-	-	-
	3	-	-	-	-	-	-	-	-	-
	4	-	-	-	-	-	-	-	-	-
	5	-	-	-	-	-	-	-	-	-
	6	-	-	-	-	-	-	-	-	-
	7	-	-	-	-	-	-	-	-	-
	8	-	-	-	-	-	-	-	-	-
S	1	-	-	-	550	650	1200	-	-	-
	2	-	-	-	550	720	1200	-	-	-
	3	-	-	-	600	820	1200	-	-	-
	4	-	-	-	-	-	-	-	-	-
H	1	200	325	450	150	275	400	-	-	-
	2	200	325	450	150	275	400	-	-	-
	3	200	325	450	150	275	400	-	-	-
	4	200	325	450	150	275	400	-	-	-

INDEXABLE MILLING

SOLID END MILLING

HOLEMAKING

TAPPING

TURNING

Speed and Feed Chart • PcBN PCD • Metric

		Cutting Speed – vc m/min																	
Material Group		WBH10P			WBH20P			WBH30P			WBK40U			WDN00U			WDN25U		
		min	Start	max	min	Start	max	min	Start	max	min	Start	max	min	Start	max	min	Start	max
	ap [mm]	0,10		0,50	0,10		0,50	0,08		0,40	0,10		1,50	0,20		2,00	0,20		2,00
	f [mm/rev]	0,06		0,25	0,05		0,20	0,05		0,20	0,08		0,20	0,10		0,30	0,10		0,25
<b>P</b>	0/1	-	-	-	-	-	-	-	-	-	-	-	-	-	-	-	-	-	-
	2	-	-	-	-	-	-	-	-	-	-	-	-	-	-	-	-	-	-
	3	-	-	-	-	-	-	-	-	-	-	-	-	-	-	-	-	-	-
	4	-	-	-	-	-	-	-	-	-	-	-	-	-	-	-	-	-	-
	5	-	-	-	-	-	-	-	-	-	-	-	-	-	-	-	-	-	-
	6	-	-	-	-	-	-	-	-	-	-	-	-	-	-	-	-	-	-
<b>M</b>	1	-	-	-	-	-	-	-	-	-	-	-	-	-	-	-	-	-	-
	2	-	-	-	-	-	-	-	-	-	-	-	-	-	-	-	-	-	-
	3	-	-	-	-	-	-	-	-	-	-	-	-	-	-	-	-	-	-
<b>K</b>	1	-	-	-	-	-	-	400	600	800	650	800	1200	-	-	-	-	-	-
	2	-	-	-	-	-	-	-	-	-	-	-	-	-	-	-	-	-	-
	3	-	-	-	-	-	-	-	-	-	-	-	-	-	-	-	-	-	-
<b>N</b>	1	-	-	-	-	-	-	-	-	-	-	-	-	500	765	2500	500	765	2500
	2	-	-	-	-	-	-	-	-	-	-	-	-	-	-	-	350	580	1000
	3	-	-	-	-	-	-	-	-	-	-	-	-	250	520	1000	250	520	1000
	4	-	-	-	-	-	-	-	-	-	-	-	-	250	400	750	250	400	750
	5	-	-	-	-	-	-	-	-	-	-	-	-	550	760	1000	550	760	1000
	6	-	-	-	-	-	-	-	-	-	-	-	-	400	460	850	400	365	750
	7	-	-	-	-	-	-	-	-	-	-	-	-	-	-	-	-	-	-
<b>S</b>	1	-	-	-	-	-	-	120	160	200	-	-	-	-	-	-	-	-	-
	2	-	-	-	-	-	-	120	160	200	-	-	-	-	-	-	-	-	-
	3	-	-	-	-	-	-	120	160	200	-	-	-	-	-	-	-	-	-
	4	-	-	-	-	-	-	-	-	-	-	-	-	100	180	320	-	-	-
<b>H</b>	1	80	170	260	80	160	230	60	120	220	60	120	220	-	-	-	-	-	-
	2	80	170	260	80	160	230	60	120	220	60	120	220	-	-	-	-	-	-
	3	80	170	260	80	160	230	60	120	220	60	120	220	-	-	-	-	-	-
	4	80	170	260	80	160	230	60	120	220	60	120	220	-	-	-	-	-	-

INDEXABLE MILLING

SOLID END MILLING

HOLE/MAKEING

TAPPING

TURNING

INDEXABLE MILLING

SOLID END MILLING

HOLEMAKING

TAPPING

TURNING

Speed and Feed Chart • PcBN PCD • Inch

Material Group		Cutting Speed – vc SFM																	
		WBH10P			WBH20P			WBH30P			WBK40U			WDN00U			WDN25U		
		min	Start	max	min	Start	max	min	Start	max	min	Start	max	min	Start	max	min	Start	max
ap [inch]		0.004		0.020	0.004		0.020	0.003		0.016	0.008		0.080	0.008		0.079	0.008		0.079
f [inch]		0.002		0.010	0.002		0.008	0.002		0.008	0.003		0.010	0.004		0.010	0.004		0.010
<b>P</b>	0/1	-	-	-	-	-	-	-	-	-	-	-	-	-	-	-	-	-	-
	2	-	-	-	-	-	-	-	-	-	-	-	-	-	-	-	-	-	-
	3	-	-	-	-	-	-	-	-	-	-	-	-	-	-	-	-	-	-
	4	-	-	-	-	-	-	-	-	-	-	-	-	-	-	-	-	-	-
	5	-	-	-	-	-	-	-	-	-	-	-	-	-	-	-	-	-	-
	6	-	-	-	-	-	-	-	-	-	-	-	-	-	-	-	-	-	-
<b>M</b>	1	-	-	-	-	-	-	-	-	-	-	-	-	-	-	-	-	-	-
	2	-	-	-	-	-	-	-	-	-	-	-	-	-	-	-	-	-	-
	3	-	-	-	-	-	-	-	-	-	-	-	-	-	-	-	-	-	-
<b>K</b>	1	-	-	-	-	-	-	1310	1975	2625	2125	2625	3950	-	-	-	-	-	-
	2	-	-	-	-	-	-	-	-	-	-	-	-	-	-	-	-	-	-
	3	-	-	-	-	-	-	-	-	-	-	-	-	-	-	-	-	-	-
<b>N</b>	1	-	-	-	-	-	-	-	-	-	-	-	-	1600	2500	8000	1600	2500	8000
	2	-	-	-	-	-	-	-	-	-	-	-	-	-	-	-	1000	2000	3200
	3	-	-	-	-	-	-	-	-	-	-	-	-	800	1700	3200	800	1700	3200
	4	-	-	-	-	-	-	-	-	-	-	-	-	800	1300	2400	800	1300	2400
	5	-	-	-	-	-	-	-	-	-	-	-	-	1700	2500	3200	1700	2500	3200
	6	-	-	-	-	-	-	-	-	-	-	-	-	1000	1200	2400	1000	1500	2800
	7	-	-	-	-	-	-	-	-	-	-	-	-	-	-	-	-	-	-
<b>S</b>	1	-	-	-	-	-	-	400	525	650	-	-	-	-	-	-	-	-	-
	2	-	-	-	-	-	-	400	525	650	-	-	-	-	-	-	-	-	-
	3	-	-	-	-	-	-	400	525	650	-	-	-	-	-	-	-	-	-
	4	-	-	-	-	-	-	-	-	-	-	-	-	325	600	1050	-	-	-
<b>H</b>	1	275	550	850	275	525	755	200	400	725	200	400	725	-	-	-	-	-	-
	2	275	550	850	275	525	755	200	400	725	200	400	725	-	-	-	-	-	-
	3	275	550	850	275	525	755	200	400	725	200	400	725	-	-	-	-	-	-
	4	275	550	850	275	525	755	200	400	725	200	400	725	-	-	-	-	-	-

Ceramic Inserts • CNGN/CNG

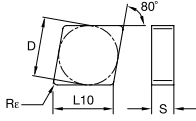
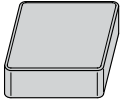

- first choice
- alternate choice

P	■	■	■	■
M	■	■	■	■
K	■	●	■	■
N	■	■	■	■
S	■	■	■	■
H	■	●	■	■
	■	■	■	■

ISO catalog number	ANSI catalog number	D		L10		S		Rε		CW2015	CW3020	CW5025
		mm	in	mm	in	mm	in	mm	in			
CNGN120404T02020	CNG431T0820	12,70	1/2	12,90	.508	4,76	3/16	0,4	.016	2952551		
CNGN120408T01020	CNG432T0420	12,70	1/2	12,90	.508	4,76	3/16	0,8	.031		3869578	
CNGN120408T02020	CNG432T0820	12,70	1/2	12,90	.508	4,76	3/16	0,8	.031	2952552		
CNGN120412T01020	CNG433T0420	12,70	1/2	12,90	.508	4,76	3/16	1,2	.047		3869579	
CNGN120412T02020	CNG433T0820	12,70	1/2	12,90	.508	4,76	3/16	1,2	.047	2952603		
CNGN120712T01020	CNG453T0420	12,70	1/2	12,90	.508	7,94	5/16	1,2	.047		3869581	
CNGN120712T02020	CNG453T0820	12,70	1/2	12,90	.508	7,94	5/16	1,2	.047	2952605		2952115

INDEXABLE MILLING

SOLID END MILLING

HOLEMAKING

TAPPING

TURNING

## Ceramic Inserts • CNGA

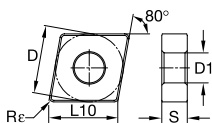
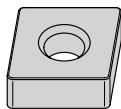

- first choice
- alternate choice

P	■	■	■	■
M	■	■	■	■
K	■	●	■	■
N	■	■	■	■
S	■	■	●	■
H	■	●	■	■

ISO catalog number	ANSI catalog number	D		L10		S		R <sub>ε</sub>		D1		CW2015	CW3020	CW5025
		mm	in	mm	in	mm	in	mm	in	mm	in			
CNGA120404T02020	CNGA431T0820	12,70	1/2	12,90	.508	4,76	3/16	0,4	.016	5,16	.203	2952526	2952527	2952159
CNGA120408T02020	CNGA432T0820	12,70	1/2	12,90	.508	4,76	3/16	0,8	.031	5,16	.203	2952528	2952161	2952173
CNGA120412T02020	CNGA433T0820	12,70	1/2	12,90	.508	4,76	3/16	1,2	.047	5,16	.203	2952529	2952175	
CNGA120416T02020	CNGA434T0820	12,70	1/2	12,90	.508	4,76	3/16	1,6	.063	5,16	.203			
CNGA160612T02020	CNGA543T0820	15,88	5/8	16,12	.635	6,35	1/4	1,2	.047	6,35	.250			
CNGA160616T02020	CNGA544T0820	15,88	5/8	16,12	.635	6,35	1/4	1,6	.063	6,35	.250			

## Ceramic Inserts • CNGA-FW

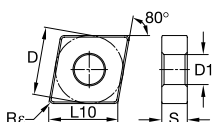
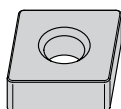

- first choice
- alternate choice

P	■	■	■	■
M	■	■	■	■
K	■	●	■	■
N	■	■	■	■
S	■	■	●	■
H	■	●	■	■

ISO catalog number	ANSI catalog number	D		L10		S		R <sub>ε</sub>		D1		CW2015	CW3020	CW5025
		mm	in	mm	in	mm	in	mm	in	mm	in			
CNGA120412T01020FW	CNGA433T0420FW	12,70	1/2	12,90	.508	4,76	3/16	1,2	.047	5,16	.203			2952160

## Ceramic Inserts • CNGX

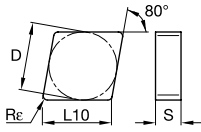
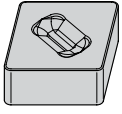

- first choice
- alternate choice

P	■	■	■	■
M	■	■	■	■
K	■	●	■	■
N	■	■	■	■
S	■	■	●	■
H	■	■	■	■

ISO catalog number	ANSI catalog number	D		L10		S		Rε		CW2015	CW3020	CW5025
		mm	in	mm	in	mm	in	mm	in			
CNGX120712T02020	CNGX453T0820	12,70	1/2	12,90	.508	7,94	5/16	1,2	.047	●	●	2952119

## Ceramic Inserts • CNMX

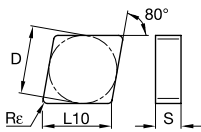
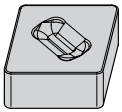

- first choice
- alternate choice

P	■	■	■	■
M	■	■	■	■
K	■	●	■	■
N	■	■	■	■
S	■	■	●	■
H	■	■	■	■

ISO catalog number	ANSI catalog number	D		L10		S		Rε		CW2015	CW3020	CW5025
		mm	in	mm	in	mm	in	mm	in			
CNMX120712T02020	CNMX453T0820	12,70	1/2	12,90	.508	7,94	5/16	1,2	.047	●	●	2952122
CNMX120716T02020	CNMX454T0820	12,70	1/2	12,90	.508	7,94	5/16	1,6	.063	●	●	2952123

INDEXABLE MILLING

SOLID END MILLING

HOLE/MAKING

TAPPING

TURNING

## Ceramic Inserts • DNGA

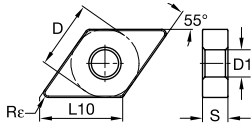
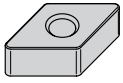

- first choice
- alternate choice

P				
M				
K	●			●
N				
S				●
H	●			

ISO catalog number	ANSI catalog number	D		L10		S		R $\epsilon$		D1		CW2015	CW3020	CW5025	
		mm	in	mm	in	mm	in	mm	in	mm	in				
DNGA150404T02020	DNGA431T0820	12,70	1/2	15,50	.610	4,76	3/16	0,4	.016	5,16	.203	2952532	2952532	●	●
DNGA150408T02020	DNGA432T0820	12,70	1/2	15,50	.610	4,76	3/16	0,8	.031	5,16	.203	2952533	2952533	●	●
DNGA150412T02020	DNGA433T0820	12,70	1/2	15,50	.610	4,76	3/16	1,2	.047	5,16	.203	2952534	2952534	●	●
DNGA150604T02020	DNGA441T0820	12,70	1/2	15,50	.610	6,35	1/4	0,4	.016	5,16	.203	2952535	2952535	●	●
DNGA150608T02020	DNGA442T0820	12,70	1/2	15,50	.610	6,35	1/4	0,8	.031	5,16	.203	2952536	2952536	●	●
DNGA150612T02020	DNGA443T0820	12,70	1/2	15,50	.610	6,35	1/4	1,2	.047	5,16	.203	2952537	2952185	●	●

Ceramic Inserts • DNGX

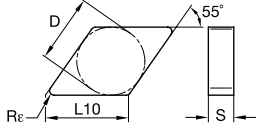
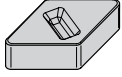

- first choice
- alternate choice

P	■	■	■	■
M	■	■	■	■
K	■	●	■	●
N	■	■	■	■
S	■	■	●	■
H	■	●	■	■

ISO catalog number	ANSI catalog number	D		L10		S		Rε		CW2015	CW3020	CW5025
		mm	in	mm	in	mm	in	mm	in			
DNGX120712T02020	DNGX120712T02020	10,00	.3937	12,21	.481	7,94	5/16	1,2	.047	●	●	2952124
DNGX150712T02020	DNGX453T0820	12,70	1/2	15,50	.610	7,94	5/16	1,2	.047	●	●	2952127
DNGX150716T02020	DNGX454T0820	12,70	1/2	15,50	.610	7,94	5/16	1,6	.063	●	●	2952128

Ceramic Inserts • ENGN/ENG

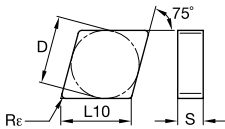
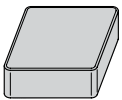

- first choice
- alternate choice

P	■	■	■	■
M	■	■	■	■
K	■	●	■	●
N	■	■	■	■
S	■	■	●	■
H	■	●	■	■

ISO catalog number	ANSI catalog number	D		L10		S		Rε		CW2015	CW3020	CW5025
		mm	in	mm	in	mm	in	mm	in			
ENGN130712T02020	ENG453T0820	12,70	1/2	13,15	.518	7,94	5/16	1,2	.047	2952613	●	●



## Ceramic Inserts • RCGX/RCGV

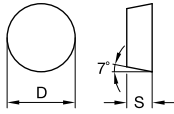
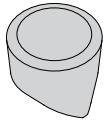

- first choice
- alternate choice

P	■	■	■	■
M	■	■	■	■
K	■	●	■	●
N	■	■	■	■
S	■	■	●	■
H	■	●	■	■

ISO catalog number	ANSI catalog number	D		S		CW2015	CW3020	CW5025
		mm	in	mm	in			
RCGX060400T01020	RCGV23T0420	6,35	1/4	4,76	3/16		3869746	
RCGX090700T02020	RCGV35T0820	9,53	3/8	7,92	5/16	2952694		
RCGX090700T07015	RCGV35T2815	9,53	3/8	7,92	5/16	2952695		
RCGX090700T01020	RCGV35T0420	9,53	3/8	7,94	5/16	2952693	3869747	
RCGX120700T01020	RCGV45T0420	12,70	1/2	7,92	5/16		3869748	
RCGX120700T02020	RCGV45T0820	12,70	1/2	7,92	5/16	2952697		
RCGX120700T20015	RCGV45T8015	12,70	1/2	7,92	5/16	2952698		

INDEXABLE MILLING

SOLID END MILLING

HOLE/MAKING

TAPPING

TURNING

Ceramic Inserts • RNGN/RNG

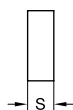
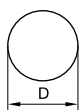
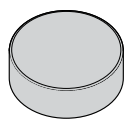

- first choice
- alternate choice

P	Blue			
M	Yellow			
K	Red	●	●	●
N	Green			
S	Orange			
H	Grey	●		

ISO catalog number	ANSI catalog number	D		S		CW2015	CW3020	CW5025
		mm	in	mm	in			
RNGN090300T01020	RNG32T0420	9,53	3/8	3,18	1/8		3869749	
RNGN090400T02020	RNG33T0820	9,53	3/8	4,76	3/16	2952615		
RNGN120400T01020	RNG43T0420	12,70	1/2	4,76	3/16		3869750	
RNGN120400T02020	RNG43T0820	12,70	1/2	4,76	3/16	2952616		2952131
RNGN120700T01020	RNG45T0420	12,70	1/2	7,94	5/16		3869751	
RNGN120700T02020	RNG45T0820	12,70	1/2	7,94	5/16	2952617		
RNGN120700T10015	RNG45T4015	12,70	1/2	7,94	5/16	2952618		
RNGN120700T20015	RNG45T8015	12,70	1/2	7,94	5/16	2952619		

INDEXABLE MILLING

SOLID END MILLING

HOLE/MAKING

TAPPING

TURNING

INDEXABLE MILLING

SOLID END MILLING

HOLE/MAKING

TAPPING

TURNING

## Ceramic Inserts • RPGX/RPGV

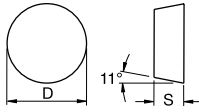
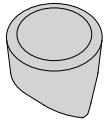

- first choice
- alternate choice

P				
M				
K	●			●
N				
S				
H	●			

ISO catalog number	ANSI catalog number	D		S		CW2015	CW3020	CW5025
		mm	in	mm	in			
RPGX060400T01020	RPGV23T0420	6,35	1/4	4,78	3/16		3869753	
RPGX090700T01020	RPGV35T0420	9,53	3/8	7,92	5/16		3869754	
RPGX120700T01020	RPGV45T0420	12,70	1/2	7,94	5/16		3869755	

Ceramic Inserts • SNGN/SNG

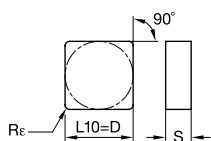
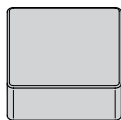

- first choice
- alternate choice

P	■	■	■	■
M	■	■	■	■
K	■	●	■	■
N	■	■	■	■
S	■	■	●	■
H	■	●	■	■

ISO catalog number	ANSI catalog number	D		L10		S		Rε		CW2015	CW3020	CW5025
		mm	in	mm	in	mm	in	mm	in			
SNGN120408T00520	SNG432T0220	12,70	1/2	12,70	.500	4,76	3/16	0,8	.031	2952750		
SNGN120408T02020	SNG432T0820	12,70	1/2	12,70	.500	4,76	3/16	0,8	.031	2952751		
SNGN120412T01020	SNG433T0420	12,70	1/2	12,70	.500	4,76	3/16	1,2	.047		3869756	
SNGN120412T02020	SNG433T0820	12,70	1/2	12,70	.500	4,76	3/16	1,2	.047	2952752		2952136
SNGN120708T02020	SNG452T0820	12,70	1/2	12,70	.500	7,94	5/16	0,8	.031	2952825		
SNGN120712T02020	SNG453T0820	12,70	1/2	12,70	.500	7,94	5/16	1,2	.047	2952826		
SNGN120716T00520	SNG454T0220	12,70	1/2	12,70	.500	7,94	5/16	1,6	.063	2953340		
SNGN190720K20015	SNG655K8015	19,05	3/4	19,05	.750	7,94	5/16	2,0	.079	2952832		

INDEXABLE MILLING

SOLID END MILLING

HOLE/MAKING

TAPPING

TURNING

## Ceramic Inserts • SNGA

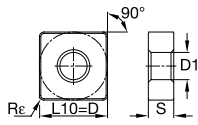
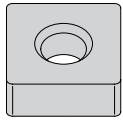

- first choice
- alternate choice

P				
M				
K	●			●
N				
S				
H	●			

ISO catalog number	ANSI catalog number	D		L10		S		Rε		D1		CW2015	CW3020	CW5025
		mm	in	mm	in	mm	in	mm	in	mm	in			
SNGA120408T02020	SNGA432T0820	12,70	1/2	12,70	.500	4,76	3/16	0,8	.031	5,16	.203	2952538	●	●
SNGA120412T02020	SNGA433T0820	12,70	1/2	12,70	.500	4,76	3/16	1,2	.047	5,16	.203	2952539	●	●

## Ceramic Inserts • SNGX

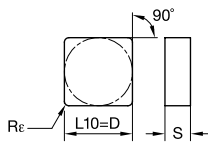
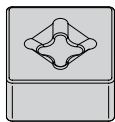

- first choice
- alternate choice

P				
M				
K	●			●
N				
S				
H	●			

ISO catalog number	ANSI catalog number	D		L10		S		Rε		CW2015	CW3020	CW5025
		mm	in	mm	in	mm	in	mm	in			
SNGX120712T02020	SNGX453T0820	12,70	1/2	12,70	.500	7,94	5/16	1,2	.047	●	●	2952142

Ceramic Inserts • SNMX

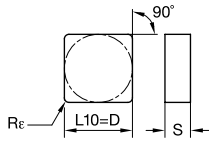
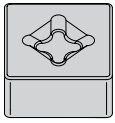

- first choice
- alternate choice

P	■	■	■	■
M	■	■	■	■
K	■	●	■	●
N	■	■	■	■
S	■	■	●	■
H	■	●	■	■

ISO catalog number	ANSI catalog number	D		L10		S		Rε		CW2015	CW3020	CW5025
		mm	in	mm	in	mm	in	mm	in			
SNMX120712T02020	SNMX453T0820	12,70	1/2	12,70	.500	7,94	5/16	1,2	.047	■	■	2952069
SNMX120716T02020	SNMX454T0820	12,70	1/2	12,70	.500	7,94	5/16	1,6	.063	■	■	2952070

Ceramic Inserts • SPGN/SPG

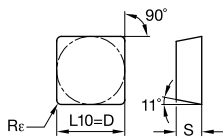
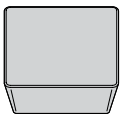

- first choice
- alternate choice

P	■	■	■	■
M	■	■	■	■
K	■	●	■	●
N	■	■	■	■
S	■	■	●	■
H	■	●	■	■

ISO catalog number	ANSI catalog number	D		L10		S		Rε		CW2015	CW3020	CW5025
		mm	in	mm	in	mm	in	mm	in			
SPGN120308T01020	SPG422T0420	12,70	1/2	12,70	.500	3,18	1/8	0,8	.031	2952702	■	■

## Ceramic Inserts • TNGA

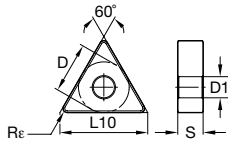
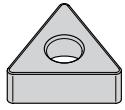

- first choice
- alternate choice

P				
M				
K	●			
N				
S				
H	●			

ISO catalog number	ANSI catalog number	D		L10		S		Re		D1		CW2015	CW3020	CW5025
		mm	in	mm	in	mm	in	mm	in	mm	in			
TNGA160408T02020	TNGA332T0820	9,53	3/8	16,50	.650	4,76	3/16	0,8	.031	3,81	.150			
TNGA160412T02020	TNGA333T0820	9,53	3/8	16,50	.650	4,76	3/16	1,2	.047	3,81	.150			
TNGA220408T02020	TNGA432T0820	12,70	1/2	22,00	.866	4,76	3/16	0,8	.031	5,16	.203			

## Ceramic Inserts • TNGN/TNG

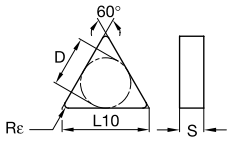
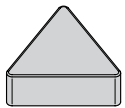

- first choice
- alternate choice

P				
M				
K	●			
N				
S				
H	●			

ISO catalog number	ANSI catalog number	D		L10		S		Re		CW2015	CW3020	CW5025
		mm	in	mm	in	mm	in	mm	in			
TNGN160404T02020	TNG331T0820	9,53	3/8	16,50	.650	4,76	3/16	0,4	.016			
TNGN160408T01020	TNG332T0420	9,53	3/8	16,50	.650	4,76	3/16	0,8	.031			
TNGN160408T02020	TNG332T0820	9,53	3/8	16,50	.650	4,76	3/16	0,8	.031			
TNGN160712T02020	TNG353T0820	9,53	3/8	16,50	.650	7,94	5/16	1,2	.047			
TNGN220408T02020	TNG432T0820	12,70	1/2	22,00	.866	4,76	3/16	0,8	.031			

Ceramic Inserts • TPGN/TPG

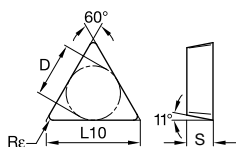
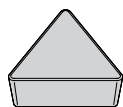

- first choice
- alternate choice

P				
M				
K	●			●
N				
S			●	
H	●			

ISO catalog number	ANSI catalog number	D		L10		S		Rε		CW2015	CW3020	CW5025
		mm	in	mm	in	mm	in	mm	in			
TPGN110304T01020	TPG221T0420	6,35	1/4	11,00	.433	3,18	1/8	0,4	.016	2952706		
TPGN110308T01020	TPG222T0420	6,35	1/4	11,00	.433	3,18	1/8	0,8	.031	2952707		
TPGN160304T00520	TPG321T0220	9,53	3/8	16,50	.650	3,18	1/8	0,4	.016	2952709		
TPGN160304T01020	TPG321T0420	9,53	3/8	16,50	.650	3,18	1/8	0,4	.016	2952710		
TPGN160308T00520	TPG322T0220	9,53	3/8	16,50	.650	3,18	1/8	0,8	.031	2952711		
TPGN160308T01020	TPG322T0420	9,53	3/8	16,50	.650	3,18	1/8	0,8	.031	2952712		

INDEXABLE MILLING

SOLID END MILLING

HOLE/MAKING

TAPPING

TURNING



## Ceramic Inserts • VNGA

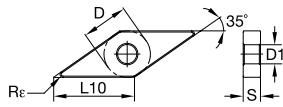
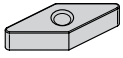

- first choice
- alternate choice

P	■	■	■	■
M	■	■	■	■
K	●	■	■	■
N	■	■	■	■
S	■	■	■	■
H	■	■	■	■

ISO catalog number	ANSI catalog number	D		L10		S		Re		D1		CW2015	CW3020	CW5025
		mm	in	mm	in	mm	in	mm	in	mm	in			
VNGA160404T02020	VNGA331T0820	9,53	3/8	16,61	.654	4,76	3/16	0,4	.016	3,81	.150	2952545	■	■
VNGA160408T02020	VNGA332T0820	9,53	3/8	16,61	.654	4,76	3/16	0,8	.031	3,81	.150	2952546	■	■
VNGA160412T02020	VNGA333T0820	9,53	3/8	16,61	.654	4,76	3/16	1,2	.047	3,81	.150	2952547	■	■

## Ceramic Inserts • WNGA

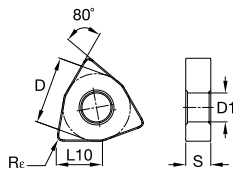
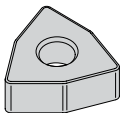

- first choice
- alternate choice

P	■	■	■	■
M	■	■	■	■
K	●	■	■	■
N	■	■	■	■
S	■	■	■	■
H	■	■	■	■

ISO catalog number	ANSI catalog number	D		L10		S		Re		D1		CW2015	CW3020	CW5025
		mm	in	mm	in	mm	in	mm	in	mm	in			
WNGA080408T02020	WNGA432T0820	12,70	1/2	8,69	.342	4,76	3/16	0,8	.031	5,16	.203	■	■	2952199
WNGA080412T02020	WNGA433T0820	12,70	1/2	8,69	.342	4,76	3/16	1,2	.047	5,16	.203	■	■	2952200

## Polycrystalline Diamond Inserts (PCD) • CCGW-FST

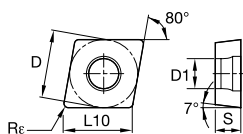
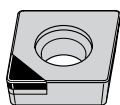

- first choice
- alternate choice

P	■	■	■
M	■	■	■
K	■	■	■
N	■	●	●
S	■	●	■
H	■	■	■

ISO catalog number	D		L10		S		Rε		D1		WDN00U	WDN25U
	mm	in	mm	in	mm	in	mm	in	mm	in		
CCGW060204FST	6,35	1/4	6,45	.254	2,38	3/32	0,4	.016	2,80	.110	5885722	3898746
CCGW09T304FST	9,53	3/8	9,67	.381	3,97	5/32	0,4	.016	4,40	.173	5885723	3898749
CCGW09T308FST	9,53	3/8	9,67	.381	3,97	5/32	0,8	.031	4,40	.173	5885724	3898750

## Polycrystalline Diamond Inserts (PCD) • CCMW-FST

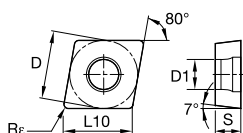
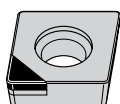

- first choice
- alternate choice

P	■	■	■
M	■	■	■
K	■	■	■
N	■	●	●
S	■	●	■
H	■	■	■

ISO catalog number	D		L10		S		Rε		D1		WDN00U	WDN25U
	mm	in	mm	in	mm	in	mm	in	mm	in		
CCMW09T304FST	9,53	3/8	9,67	.381	3,97	5/32	0,4	.016	4,40	.173	3883134	
CCMW09T308FST	9,53	3/8	9,67	.381	3,97	5/32	0,8	.031	4,40	.173	3883136	

## Polycrystalline Diamond Inserts (PCD) • CDHB-FST

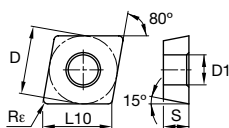

- first choice
- alternate choice

P	■	■	■
M	■	■	■
K	■	■	■
N	■	●	●
S	■	●	■
H	■	■	■

ISO catalog number	D		L10		S		Rε		D1		WDN00U	WDN25U
	mm	in	mm	in	mm	in	mm	in	mm	in		
CDHBS4T0X0FST	3,97	5/32	4,03	.159	1,02	.040	0,1	.002	2,13	.084	■	3898745
CDHBS4T002FST	3,97	.1562	4,03	.159	1,02	.040	0,2	.007	2,13	.084	■	3898744

## Polycrystalline Diamond Inserts (PCD) • CNGA-FST

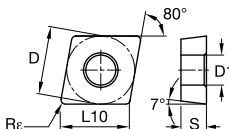
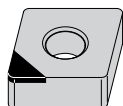

- first choice
- alternate choice

P	■	■	■
M	■	■	■
K	■	■	■
N	■	●	●
S	■	●	■
H	■	■	■

ISO catalog number	D		L10		S		Rε		D1		WDN00U	WDN25U
	mm	in	mm	in	mm	in	mm	in	mm	in		
CNGA120404FST	12,70	1/2	12,90	.508	4,76	3/16	0,4	.016	5,16	.203	■	3898726
CNGA120408FST	12,70	1/2	12,90	.508	4,76	3/16	0,8	.031	5,16	.203	■	3898727

Polycrystalline Diamond Inserts (PCD) • CPGW-FWST

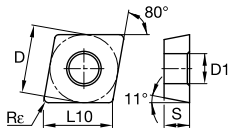
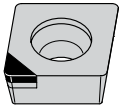

- first choice
- alternate choice

P				
M				
K				
N			●	●
S			●	
H				

ISO catalog number	D		L10		S		Rε		D1		WDN00U	WDN25U
	mm	in	mm	in	mm	in	mm	in	mm	in		
CPGW060204FWST	6,35	1/4	6,45	.254	2,38	3/32	0,4	.016	2,80	.110	5885758	I

Polycrystalline Diamond Inserts (PCD) • CPGW-FST

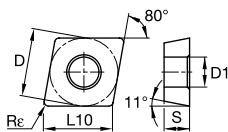
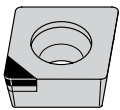

- first choice
- alternate choice

P				
M				
K				
N			●	●
S			●	
H				

ISO catalog number	D		L10		S		Rε		D1		WDN00U	WDN25U
	mm	in	mm	in	mm	in	mm	in	mm	in		
CPGW060204FST	6,35	1/4	6,45	.254	2,38	3/32	0,4	.016	2,80	.110	I	3898752
CPGW060208FST	6,35	1/4	6,45	.254	2,38	3/32	0,8	.031	2,80	.110	I	3898753

## Polycrystalline Diamond Inserts (PCD) • DCGW-FST

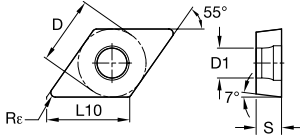
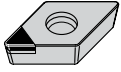

- first choice
- alternate choice

P			
M			
K			
N	●	●	
S	●		
H			

ISO catalog number	D		L10		S		Rε		D1		WDN00U	WDN25U
	mm	in	mm	in	mm	in	mm	in	mm	in		
DCGW070204FST	6,35	1/4	7,75	.305	2,38	3/32	0,4	.016	2,80	.110	○	3898761
DCGW11T304FST	9,53	3/8	11,63	.458	3,97	5/32	0,4	.016	4,40	.173	○	3898762

## Polycrystalline Diamond Inserts (PCD) • DCMW-FST

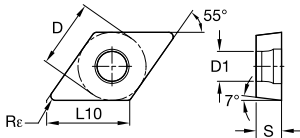
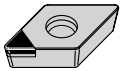

- first choice
- alternate choice

P			
M			
K			
N	●	●	
S	●		
H			

ISO catalog number	D		L10		S		Rε		D1		WDN00U	WDN25U
	mm	in	mm	in	mm	in	mm	in	mm	in		
DCMW070204FST	6,35	1/4	7,75	.305	2,38	3/32	0,4	.016	2,80	.110	○	3883142
DCMW11T304FST	9,53	3/8	11,63	.458	3,97	5/32	0,4	.016	4,40	.173	○	3883122
DCMW11T308FST	9,53	3/8	11,63	.458	3,97	5/32	0,8	.031	4,40	.173	○	3883143

## Polycrystalline Diamond Inserts (PCD) • DNGA-FST

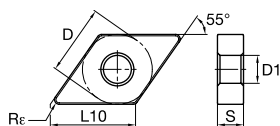
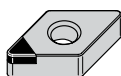

- first choice
- alternate choice

P	■	■	■
M	■	■	■
K	■	■	■
N	■	●	●
S	■	●	■
H	■	■	■

ISO catalog number	D		L10		S		Rε		D1		WDN00U 5885775	WDN25U 3898731
	mm	in	mm	in	mm	in	mm	in	mm	in		
DNGA150408FST	12,70	1/2	15,50	.610	4,76	3/16	0,8	.031	5,16	.203		

## Polycrystalline Diamond Inserts (PCD) • DPGW-FST

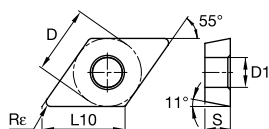
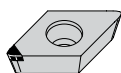

- first choice
- alternate choice

P	■	■	■
M	■	■	■
K	■	■	■
N	■	●	●
S	■	●	■
H	■	■	■

ISO catalog number	D		L10		S		Rε		D1		WDN00U 5885778	WDN25U 1
	mm	in	mm	in	mm	in	mm	in	mm	in		
DPGW070202FST	6,35	1/4	7,75	.305	2,38	3/32	0,2	.008	2,80	.110		

INDEXABLE MILLING

## Polycrystalline Diamond Inserts (PCD) • DPGW-FWST

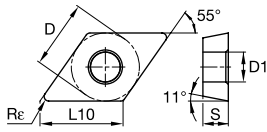
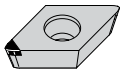

- first choice
- alternate choice

P	■	■	■
M	■	■	■
K	■	■	■
N	■	●	●
S	■	●	■
H	■	■	■

ISO catalog number	D		L10		S		Rε		D1		WDN00U	WDN25U
	mm	in	mm	in	mm	in	mm	in	mm	in		
DPGW11T304FWST	9,53	3/8	11,63	.458	3,97	5/32	0,4	.016	4,40	.173	5885791	1

SOLID END MILLING

HOLEMAKING

## Polycrystalline Diamond Inserts (PCD) • TCGW-FST

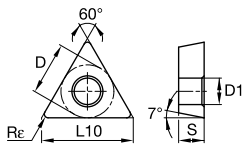
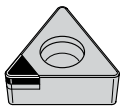

- first choice
- alternate choice

P	■	■	■
M	■	■	■
K	■	■	■
N	■	●	●
S	■	●	■
H	■	■	■

ISO catalog number	D		L10		S		Rε		D1		WDN00U	WDN25U
	mm	in	mm	in	mm	in	mm	in	mm	in		
TCGW110204FST	6,35	1/4	11,00	.433	2,38	3/32	0,4	.016	2,80	.110	1	3898768
TCGW16T304FST	9,53	3/8	16,50	.650	3,97	5/32	0,4	.016	4,40	.173	1	3898769

TAPPING

TURNING

Polycrystalline Diamond Inserts (PCD) • TCMW-FST

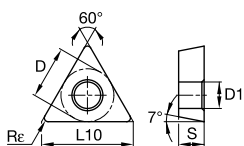
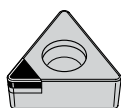

- first choice
- alternate choice

P	■	■	■
M	■	■	■
K	■	■	■
N	■	●	●
S	■	●	■
H	■	■	■

ISO catalog number	D		L10		S		Rε		D1		WDN00U	WDN25U
	mm	in	mm	in	mm	in	mm	in	mm	in		
TCMW110204FST	6,35	1/4	11,00	.433	2,38	3/32	0,4	.016	2,80	.110	■	3883144

Polycrystalline Diamond Inserts (PCD) • TNMS-FST

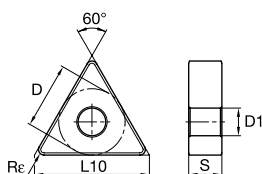
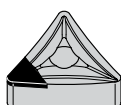

- first choice
- alternate choice

P	■	■	■
M	■	■	■
K	■	■	■
N	■	●	●
S	■	●	■
H	■	■	■

ISO catalog number	D		L10		S		Rε		D1		WDN00U	WDN25U
	mm	in	mm	in	mm	in	mm	in	mm	in		
TNMS160404FST	9,53	3/8	16,50	.650	4,76	3/16	0,4	.016	3,81	.150	■	3898734



## Polycrystalline Diamond Inserts (PCD) • TPGN/TPG

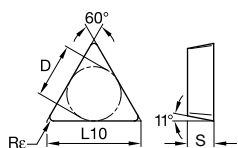

- first choice
- alternate choice

P	■	■	■
M	■	■	■
K	■	■	■
N	■	●	●
S	■	●	■
H	■	■	■

ISO catalog number	ANSI catalog number	D		L10		S		R <sub>ε</sub>		WDN00U	WDN25U
		mm	in	mm	in	mm	in	mm	in		
TPGN160304F	TPG321F	9,53	3/8	16,50	.650	3,18	1/8	0,4	.016	I	3898721

## Polycrystalline Diamond Inserts (PCD) • TPGW-FST

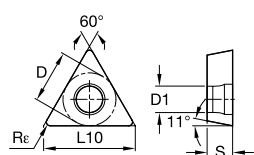
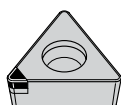

- first choice
- alternate choice

P	■	■	■
M	■	■	■
K	■	■	■
N	■	●	●
S	■	●	■
H	■	■	■

ISO catalog number	D		L10		S		R <sub>ε</sub>		D1		WDN00U	WDN25U
	mm	in	mm	in	mm	in	mm	in	mm	in		
TPGW16T304FST	9,53	3/8	16,50	.650	3,97	5/32	0,4	.016	4,40	.173	I	3898772

Polycrystalline Diamond Inserts (PCD) • VBGW-FST

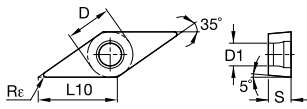
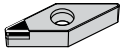

- first choice
- alternate choice

P	■	■	■
M	■	■	■
K	■	■	■
N	■	●	●
S	■	●	■
H	■	■	■

ISO catalog number	D		L10		S		Rε		D1		WDN00U WDN25U	3898774 3898775
	mm	in	mm	in	mm	in	mm	in	mm	in		
VBGW110304FST	6,35	1/4	11,07	.436	3,18	1/8	0,4	.016	2,80	.110	■	
VBGW160404FST	9,53	3/8	16,61	.654	4,76	3/16	0,4	.016	4,40	.173	■	

Polycrystalline Diamond Inserts (PCD) • VNMS-FST

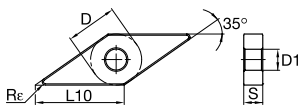
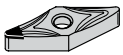

- first choice
- alternate choice

P	■	■	■
M	■	■	■
K	■	■	■
N	■	●	●
S	■	●	■
H	■	■	■

ISO catalog number	D		L10		S		Rε		D1		WDN00U WDN25U	3898739
	mm	in	mm	in	mm	in	mm	in	mm	in		
VNMS160408FST	9,53	3/8	16,61	.654	4,76	3/16	0,8	.031	3,81	.150	■	

INDEXABLE MILLING

SOLID END MILLING

HOLEMAKING

TAPPING

TURNING

## Polycrystalline Diamond Inserts (PCD) • WNGA-FST

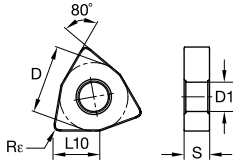
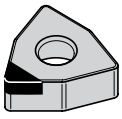

- first choice
- alternate choice

P				
M				
K				
N			●	●
S			●	
H				

ISO catalog number	D		L10		S		Rε		D1		WDN00U	WDN25U
	mm	in	mm	in	mm	in	mm	in	mm	in		
WNGA080408FST	12,70	1/2	8,69	.342	4,76	3/16	0,8	.031	5,16	.203	I	3898741

## Cubic Boron Nitride (CBN) Inserts • CCGW-M

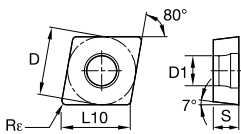
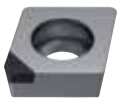

- first choice
- alternate choice

P				
M				
K				
N			●	●
S			●	
H		●	●	●

ISO catalog number	ANSI catalog number	D		L10		S		Rε		D1		WBH10P	WBH20P	WBH30P	WBK40U
		mm	in	mm	in	mm	in	mm	in	mm	in				
CCGW09T308S01015M	CCGW3252S0415M	9,53	3/8	9,67	.381	3,99	.157	0,8	.031	4,40	.173	I	6904774	I	I

## Cubic Boron Nitride (CBN) Inserts • CCGW-MT

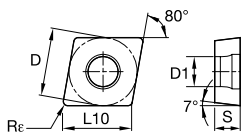

- first choice
- alternate choice

P	■				
M	■				
K	■			●	●
N	■				
S	■			●	
H	■	●	●	●	●

ISO catalog number	ANSI catalog number	D		L10		S		Rε		D1		WBH10P	WBH20P	WBH30P	WBK40U
		mm	in	mm	in	mm	in	mm	in	mm	in				
CCGW09T304S01015MT	CCGW3251S0415MT	9,53	3/8	9,67	.381	3,99	.157	0,4	.016	4,40	.173	3883507	6904777	●	●
CCGW09T308S01015MT	CCGW3252S0415MT	9,53	3/8	9,67	.381	3,99	.157	0,8	.031	4,40	.173	3883508	6904776	●	●
CCGW120408S01015MT	CCGW432S0415MT	12,70	1/2	12,90	.508	4,78	.1883	0,8	.031	5,50	.216	6904775	6018004	●	●

## Cubic Boron Nitride (CBN) Inserts • CNGA-EMT

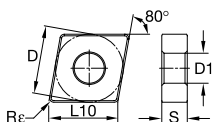
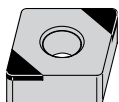

- first choice
- alternate choice

P	■				
M	■				
K	■			●	●
N	■				
S	■			●	
H	■	●	●	●	●

ISO catalog number	ANSI catalog number	D		L10		S		Rε		D1		WBH10P	WBH20P	WBH30P	WBK40U
		mm	in	mm	in	mm	in	mm	in	mm	in				
CNGA120408EMT	CNGA432EMT	12,70	1/2	12,90	.508	4,76	3/16	0,8	.031	5,16	.203	6904778	6018004	●	●

## Cubic Boron Nitride (CBN) Inserts • CNGA-MT

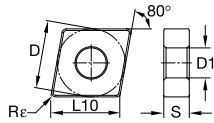
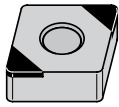

- first choice
- alternate choice

P					
M					
K					
N					
S					
H					

ISO catalog number	ANSI catalog number	D		L10		S		Re		D1		WBH10P	WBH20P	WBH30P	WBK40U
		mm	in	mm	in	mm	in	mm	in	mm	in				
CNGA120404S01025MT	CNGA431S0425MT	12,70	1/2	12,90	.508	4,78	.1883	0,4	.016	5,16	.203	3883509	6904779		
CNGA120408S01025MT	CNGA432S0425MT	12,70	1/2	12,90	.508	4,78	.1883	0,8	.031	5,16	.203	3883510	6904780	6018008	
CNGA120412S01020MT	CNGA433S0420MT	12,70	1/2	12,90	.508	4,78	.1883	1,2	.047	5,16	.203			6018009	
CNGA120412S01025MT	CNGA433S0425MT	12,70	1/2	12,90	.508	4,78	.1883	1,2	.047	5,16	.203		6904821	6018010	

## Cubic Boron Nitride (CBN) Inserts • CPGW-C

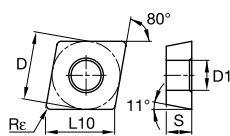

- first choice
- alternate choice

P					
M					
K					
N					
S					
H					

ISO catalog number	ANSI catalog number	D		L10		S		Re		D1		WBH10P	WBH20P	WBH30P	WBK40U
		mm	in	mm	in	mm	in	mm	in	mm	in				
CPGW060204S01015C	CPGW2151S0415C	6,35	1/4	6,45	.254	2,38	3/32	0,4	.016	2,80	.110			6018082	

## Cubic Boron Nitride (CBN) Inserts • CPGW-MT

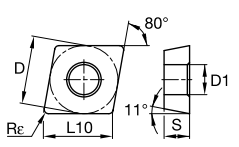
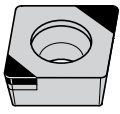

● first choice  
○ alternate choice

P	■					
M	■					
K	■			●	●	
N	■					
S	■				●	
H	■	●	●	●	●	

ISO catalog number	ANSI catalog number	D		L10		S		R <sub>ε</sub>		D1		WBH10P	WBH20P	WBH30P	WBK40U
		mm	in	mm	in	mm	in	mm	in	mm	in				
CPGW09T308S01015MT	CPGW3252S0415MT	9,53	3/8	9,67	.381	3,99	.157	0,8	.031	4,40	.173			6018085	

## Cubic Boron Nitride (CBN) Inserts • DCGW-C

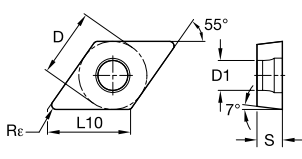
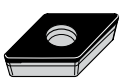

● first choice  
○ alternate choice

P	■					
M	■					
K	■			●	●	
N	■					
S	■				●	
H	■	●	●	●	●	

ISO catalog number	ANSI catalog number	D		L10		S		R <sub>ε</sub>		D1		WBH10P	WBH20P	WBH30P	WBK40U
		mm	in	mm	in	mm	in	mm	in	mm	in				
DCGW070202S01015C	DCGW21505S0415C	6,35	1/4	7,75	.305	2,38	3/32	0,2	.008	2,80	.110	3883528			
DCGW070204S01015C	DCGW2151S0415C	6,35	1/4	7,75	.305	2,38	3/32	0,4	.016	2,80	.110	3883529			

## Cubic Boron Nitride (CBN) Inserts • DCGW-MT

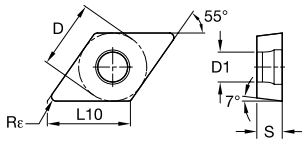
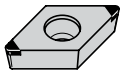

- first choice
- alternate choice

P				
M				
K			●	●
N				
S			●	
H	●	●	●	●

ISO catalog number	ANSI catalog number	D		L10		S		Rε		D1		WBH10P	WBH20P	WBH30P	WBK40U
		mm	in	mm	in	mm	in	mm	in	mm	in				
DCGW11T304S01015MT	DCGW3251S0415MT	9,53	3/8	11,63	.458	3,99	.157	0,4	.016	4,40	.173	3883530	6904823	6018088	
DCGW11T308S01015MT	DCGW3252S0415MT	9,53	3/8	11,63	.458	3,99	.157	0,8	.031	4,40	.173	3883531	6904824		

## Cubic Boron Nitride (CBN) Inserts • DCMW-MT

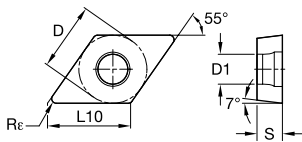
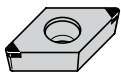

- first choice
- alternate choice

P				
M				
K			●	●
N				
S			●	
H	●	●	●	●

ISO catalog number	ANSI catalog number	D		L10		S		Rε		D1		WBH10P	WBH20P	WBH30P	WBK40U
		mm	in	mm	in	mm	in	mm	in	mm	in				
DCMW070204S01020MT	DCMW2151S0420MT	6,35	1/4	7,74	.305	2,38	3/32	0,4	.016	2,80	.110		6904822		

### Cubic Boron Nitride (CBN) Inserts • DNGA-EMT

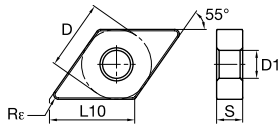

- first choice
- alternate choice

P	■	■	■	■
M	■	■	■	■
K	■	■	●	●
N	■	■	■	■
S	■	■	●	●
H	■	●	●	●

ISO catalog number	ANSI catalog number	D		L10		S		Rε		D1		WBH10P	WBH20P	WBH30P	WBK40U
		mm	in	mm	in	mm	in	mm	in	mm	in				
DNGA150408EMT	DNGA432EMT	12,70	1/2	15,50	.610	4,76	3/16	0,8	.031	5,16	.203	■	■	■	■
DNGA150412EMT	DNGA433EMT	12,70	1/2	15,50	.610	4,76	3/16	1,2	.047	5,16	.203	■	■	■	■

### Cubic Boron Nitride (CBN) Inserts • DNGA-MT

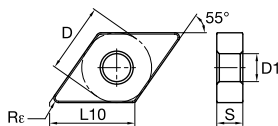
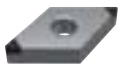

- first choice
- alternate choice

P	■	■	■	■
M	■	■	■	■
K	■	■	●	●
N	■	■	■	■
S	■	■	●	●
H	■	●	●	●

ISO catalog number	ANSI catalog number	D		L10		S		Rε		D1		WBH10P	WBH20P	WBH30P	WBK40U
		mm	in	mm	in	mm	in	mm	in	mm	in				
DNGA150404S01025MT	DNGA431S0425MT	12,70	1/2	15,50	.610	4,78	.1883	0,4	.016	5,16	.203	■	■	■	■
DNGA150408S01025MT	DNGA432S0425MT	12,70	1/2	15,50	.610	4,78	.1883	0,8	.031	5,16	.203	■	■	■	■
DNGA150608S01225MT	DNGA442S0525MT	12,70	1/2	15,50	.610	6,37	—	0,8	.031	5,16	.203	■	■	■	■



INDEXABLE MILLING

## Cubic Boron Nitride (CBN) Inserts • DNMA-ST

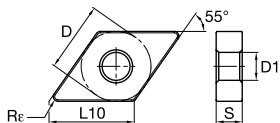

- first choice
- alternate choice

P	■				
M	■				
K	■			●	●
N	■				
S	■			●	
H	■	●	●	●	●

ISO catalog number	ANSI catalog number	D		L10		S		Rε		D1		WBH10P	WBH20P	WBH30P	WBK40U
		mm	in	mm	in	mm	in	mm	in	mm	in				
DNMA150604S01020ST	DNMA441S0420ST	12,70	1/2	15,50	.610	6,35	1/4	0,4	.016	5,16	.203	■	6904827	■	■

SOLID END MILLING

HOLE/MAKING

## Cubic Boron Nitride (CBN) Inserts • RNGN/RNG

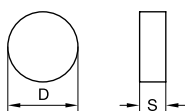

- first choice
- alternate choice

P	■				
M	■				
K	■			●	●
N	■				
S	■			●	
H	■	●	●	●	●

ISO catalog number	ANSI catalog number	D		S		WBH10P	WBH20P	WBH30P	WBK40U
		mm	in	mm	in				
RNGN120400S01020	RNG43S0420	12,70	1/2	4,76	3/16	■	6904851	■	■

TAPPING

TURNING

Cubic Boron Nitride (CBN) Inserts • RNMN/RNM

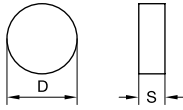

- first choice
- alternate choice

P	■	■	■	■	■
M	■	■	■	■	■
K	■	■	■	●	●
N	■	■	■	■	■
S	■	■	■	■	■
H	■	●	●	●	●

ISO catalog number	ANSI catalog number	D		S		WBH10P	WBH20P	WBH30P	WBK40U
		mm	in	mm	in				
RNMN090300S02020	RNM32S0820	9,53	3/8	3,18	1/8	●	●	●	3883315
RNMN120300S02020	RNM42S0820	12,70	1/2	3,18	1/8	●	●	●	3883316
RNMN120400S02020	RNM43S0820	12,70	1/2	4,76	3/16	●	●	●	3883317

Cubic Boron Nitride (CBN) Inserts • SNGA-MT

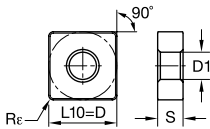

- first choice
- alternate choice

P	■	■	■	■	■
M	■	■	■	■	■
K	■	■	■	●	●
N	■	■	■	■	■
S	■	■	■	■	■
H	■	●	●	●	●

ISO catalog number	ANSI catalog number	D		L10		S		Rε		D1		WBH10P	WBH20P	WBH30P	WBK40U
		mm	in	mm	in	mm	in	mm	in	mm	in				
SNGA120408S01025MT	SNGA432S0425MT	12,70	1/2	12,70	.500	4,78	.1883	0,8	.031	5,16	.203	●	6904852	●	●

## Cubic Boron Nitride (CBN) Inserts • TCGW-MT

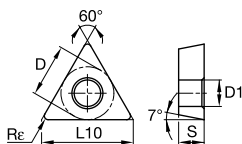
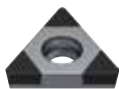

● first choice

○ alternate choice

P	■			
M	■			
K	■		●	●
N	■			
S	■		●	
H	■	●	●	●

ISO catalog number	ANSI catalog number	D		L10		S		Rε		D1		WBH10P	WBH20P	WBH30P	WBK40U
		mm	in	mm	in	mm	in	mm	in	mm	in				
TCGW110204S01015MT	TCGW2151S0415MT	6,35	1/4	11,00	.433	2,40	.0945	0,4	.016	2,80	.110	■	■	■	■
TCGW110208S01015MT	TCGW2152S0415MT	6,35	1/4	11,00	.433	2,40	.0945	0,8	.031	2,80	.110	■	■	■	■
TCGW16T308S01015MT	TCGW3252S0415M	9,53	3/8	16,50	.650	3,99	.157	0,8	.031	4,40	.173	■	■	■	■

## Cubic Boron Nitride (CBN) Inserts • TNGA-MT

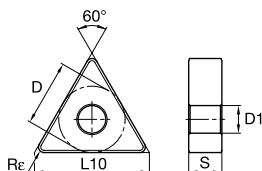

● first choice

○ alternate choice

P	■			
M	■			
K	■		●	●
N	■			
S	■		●	
H	■	●	●	●

ISO catalog number	ANSI catalog number	D		L10		S		Rε		D1		WBH10P	WBH20P	WBH30P	WBK40U
		mm	in	mm	in	mm	in	mm	in	mm	in				
TNGA160404S01025MT	TNGA331S0425MT	9,53	3/8	16,50	.650	4,78	.1883	0,4	.016	3,81	.150	■	■	■	■
TNGA160408S01025MT	TNGA332S0425MT	9,53	3/8	16,50	.650	4,78	.1883	0,8	.031	3,81	.150	■	■	■	■
TNGA160412S01225MT	TNGA333S0525MT	9,53	3/8	16,50	.650	4,78	.1883	1,2	.047	3,81	.150	■	■	■	■

Cubic Boron Nitride (CBN) Inserts • TPGW-C

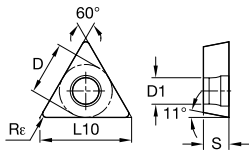

- first choice
- alternate choice

P	■				
M	■				
K	■			●	●
N	■				
S	■			●	
H	■	●	●	●	●

ISO catalog number	ANSI catalog number	D		L10		S		Re		D1		WBH10P	WBH20P	WBH30P	WBK40U
		mm	in	mm	in	mm	in	mm	in	mm	in				
TPGW110204S01015C	TPGW2151S0415C	6,35	1/4	11,00	.433	2,38	3/32	0,4	.016	2,80	.110	●	●	●	●
TPGW110208S01015C	TPGW2152S0415C	6,35	1/4	11,00	.433	2,38	3/32	0,8	.031	2,80	.110	●	●	●	●

Cubic Boron Nitride (CBN) Inserts • VBGW-MT

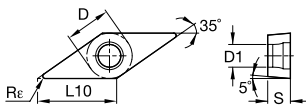
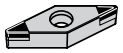

- first choice
- alternate choice

P	■				
M	■				
K	■			●	●
N	■				
S	■			●	
H	■	●	●	●	●

ISO catalog number	ANSI catalog number	D		L10		S		Re		D1		WBH10P	WBH20P	WBH30P	WBK40U
		mm	in	mm	in	mm	in	mm	in	mm	in				
VBGW160404S01015MT	VBGW331S0415MT	9,53	3/8	16,61	.654	4,78	.1883	0,4	.016	4,40	.173	●	●	●	●
VBGW160408S01015MT	VBGW332S0415MT	9,53	3/8	16,61	.654	4,78	.1883	0,8	.031	4,40	.173	●	●	●	●

## Cubic Boron Nitride (CBN) Inserts • VNGA-MT

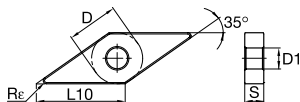

● first choice

○ alternate choice

P	■	■	■	■
M	■	■	■	■
K	■	■	■	■
N	■	■	■	■
S	■	■	■	■
H	●	●	●	●

ISO catalog number	ANSI catalog number	D		L10		S		Rε		D1		WBH10P	WBH20P	WBH30P	WBK40U
		mm	in	mm	in	mm	in	mm	in	mm	in				
VNGA160404S01025MT	VNGA331S0425MT	9,53	3/8	16,61	.654	4,78	.1883	0,4	.016	3,81	.150	3883538	6904868	6018096	■
VNGA160408S01025MT	VNGA332S0425MT	9,53	3/8	16,61	.654	4,78	.1883	0,8	.031	3,81	.150	■	■	6018097	■
VNGA160408S01225MT	VNGA332S0525MT	9,53	3/8	16,61	.654	4,78	.1883	0,8	.031	3,81	.150	■	6904869	■	■

## Cubic Boron Nitride (CBN) Inserts • WNGA-MT

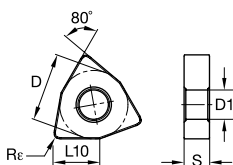
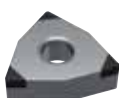

● first choice

○ alternate choice

P	■	■	■	■
M	■	■	■	■
K	■	■	■	■
N	■	■	■	■
S	■	■	■	■
H	●	●	●	●

ISO catalog number	ANSI catalog number	D		L10		S		Rε		D1		WBH10P	WBH20P	WBH30P	WBK40U
		mm	in	mm	in	mm	in	mm	in	mm	in				
WNGA080404S01015MT	WNGA4310415MT	12,70	1/2	8,69	.342	4,78	.1883	0,4	.016	5,16	.203	■	6904870	■	■
WNGA080408S01225MT	WNGA4320525MT	12,70	1/2	8,69	.342	4,78	.1883	0,8	.031	5,16	.203	■	6904871	■	■



# Tools for External Turning

## External Toolholder

WIDIA™ offers an extensive range of toolholders for external turning to meet even the most exacting production demands across a broad spectrum of workpieces, shapes, and sizes.



# TOOLS FOR EXTERNAL TURNING

## D-STYLE CLAMPING

- Used for negative style inserts.
- Clamp assembly contains clamp, screw, and retaining ring.
- Quick insert indexing.
- Ensures insert repeatability and seating.
- Reduced chatter and extended tool life.

## P-STYLE CLAMPING

- Lever-type clamping system for negative indexable inserts.
- No interference to chip flow.
- Fast insert changes.
- P-style available in metric sizes only.

## S-STYLE CLAMPING

- Screw clamping system for positive indexable inserts.
- Compact design for high reliability and cost efficiency.
- Carbide shim for additional tool protection.

## C-STYLE CLAMPING

- Height-adjustable clamp permits use of additional chipbreakers.
- Universal clamping system for positive and negative flat top inserts.
- Robust engineering makes it easy to handle.
- Carbide shim for extra tool protection.

## APPLICATIONS



TURNING



FACING



PROFILING



CHAMFERING

## INDUSTRY

GENERAL  
ENGINEERING

TRANSPORTATION



ENERGY



AEROSPACE



MEDICAL





# Toolholder Selection Guide

Each unique clamping system offers product options to fill your specific toolholder needs. Find the illustration that fits your application and navigate to the corresponding page to get the correct solution.

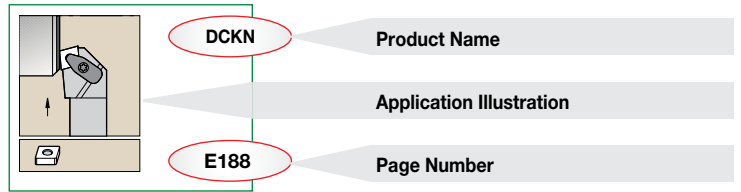

## D-Style Clamping

**D**

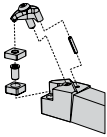

One-piece clamp assembly holder for use with negative style inserts. An extremely rigid clamping system. The tool is protected by a carbide shim.

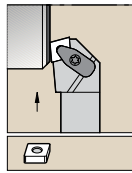

**DCKN**  
15°  
Page:  
**E188**

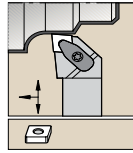

**DCLN**  
-5°  
Page:  
**E188**

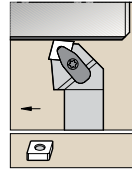

**DCRN**  
15°  
Page:  
**E189**

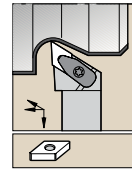

**DDJN**  
-3°  
Page:  
**E189**

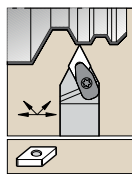

**DDPN**  
27.5°  
Page:  
**E190**

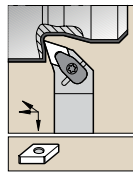

**DDQN**  
-17.5°  
Page:  
**E190**

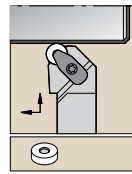

**DRGN**  
Page:  
**E191**

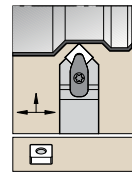

**DSDN**  
45°  
Page:  
**E191**

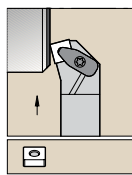

**DSKN**  
15°  
Page:  
—

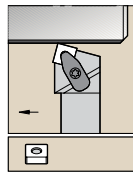

**DSRN**  
15°  
Page:  
**E192**

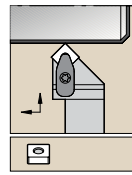

**DSSN**  
45°  
Page:  
**E192**

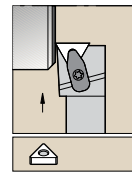

**DTFN**  
0°  
Page:  
—

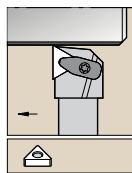

**DTGN**  
0°  
Page:  
**E193**

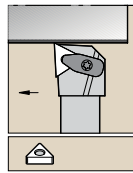

**DTJN**  
-3°  
Page:  
—

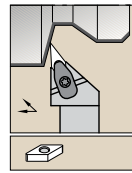

**DVJN**  
3°  
Page:  
**E193**

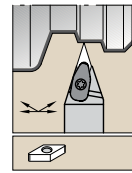

**DVVN**  
17.5°  
Page:  
**E194**

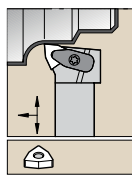

**DWLN**  
-5°  
Page:  
**E195**

INDEXABLE MILLING

SOLID END MILLING

HOLEMAKING

TAPPING

TURNING

## C-Style Clamping

**C**

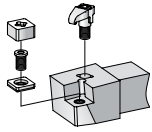

Top clamping system for negative and positive indexable inserts to DIN 4968. This universal clamping system is robust and easy to handle. Some height-adjustable clamps enable the use of additional chipbreakers. A carbide shim provides additional tool protection. Toolholders with cutting edge heights upwards of .625" and insert iCs greater than .250".

	<b>CCLN-MX</b> -5° Page: —		<b>CSDN-MX</b> 45° Page: E199		<b>CSKN-MX</b> 15° Page: —		<b>CWLN-MX</b> -5° Page: —
	<b>CSDP</b> 45° Page: E200		<b>CTAP</b> 0° Page: —		<b>CTCP</b> 0° Page: —		<b>CTEP</b> 30° Page: —
	<b>CTGP</b> 0° Page: —		<b>CRDP*</b> 0° Page: —		<b>CRGP*</b> 45° Page: —		

\*Exact Clamping System not shown.

## S-Style Clamping

**S**

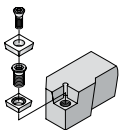



Screw clamping system for positive indexable inserts with countersunk hole to DIN 4967. Compact design using a minimum of spare parts for high reliability and cost efficiency. A carbide shim provides additional tool protection. Toolholders with cutting edge heights upwards of .625" and insert iCs from .375" are secured by means of a threaded bushing.

	<b>SCGP</b> 0° Page: E201		<b>SCLC</b> -5° Page: E201		<b>SCLP</b> -5° Page: E202		<b>SCRP</b> 15° Page: —
	<b>SDJC</b> -3° Page: E202		<b>SSDC</b> 45° Page: E203		<b>STFP</b> 0° Page: E233		<b>STGP</b> 0° Page: E203
	<b>SVJB</b> -3° Page: E204		<b>SVVB</b> 17.5° Page: E204				

## Catalog Numbering System

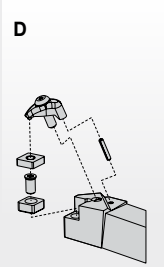
Each character in our catalog number signifies a specific trait of that product. Use the following key columns and corresponding images to easily identify which attributes apply.

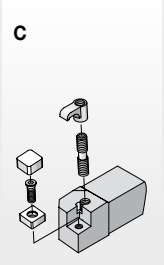
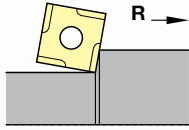
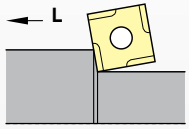
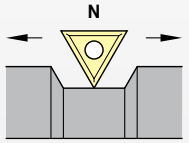
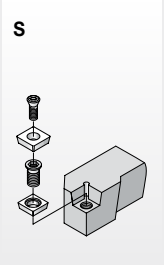
D	C	L	N	R	
Insert Holding Method	Insert Shape	Tool Style or Lead Angle	Insert Clearance Angle	Hand of Tool	Additional Information
<p><b>D</b></p> 	<p><b>A</b> 85°</p> <p><b>B</b> 82°</p> <p><b>C</b> 80°</p> <p><b>D</b> 55°</p> <p><b>E</b> 75°</p> <p><b>H</b> 120°</p> <p><b>K</b> 55°</p> <p><b>L</b> 90°</p> <p><b>M</b> 86°</p> <p><b>O</b> 135°</p> <p><b>P</b> 108°</p> <p><b>R</b> </p> <p><b>S</b> 90°</p> <p><b>T</b> 60°</p> <p><b>V</b> 35°</p> <p><b>W</b> 80°</p>	<p><b>A</b> 0°    <b>L</b> 5°</p> <p><b>B</b> 15°    <b>P</b> 27.5°</p> <p><b>C</b> 0°    <b>Q</b> 27.5°</p> <p><b>D</b> 45°    <b>R</b> 15°</p> <p><b>E</b> 30°    <b>S</b> 45°</p> <p><b>F</b> 0°    <b>U</b> 3°</p> <p><b>G</b> 0°    <b>V</b> 17.5°</p> <p><b>Y</b> 5°</p>	<p><b>N</b> 0°</p> <p><b>B</b> 5°</p> <p><b>C</b> 7°</p> <p><b>P</b> 11°</p> <p><b>D</b> 15°</p> <p><b>E</b> 20°</p> <p><b>F</b> 25°</p>	<p><b>R =</b></p> <p>Right hand</p> <p><b>L =</b></p> <p>Left hand</p> <p><b>N =</b></p> <p>Neutral</p>	<p><b>C =</b></p> <p>Deep pocket for ceramic insert</p> <p><b>S =</b></p> <p>Single pocket locating wall</p> <p><b>F =</b></p> <p>Straight shank, no offset</p>
<p><b>C</b></p> 				  	
<p><b>S</b></p> 					

## Catalog Numbering System

(continued)

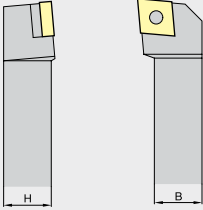
1	6	4	D	KC	3
Shank Dimensions		Insert Size	Qualified Surface and Length	Additional Information	Insert Thickness (optional)
		<p><b>Insert iC</b></p> <p>Number of 1/8ths of "D"</p>	<p><b>A</b> = Qualified back and end, 4" long  <b>B</b> = Qualified back and end, 4.5" long  <b>C</b> = Qualified back and end, 5" long  <b>D</b> = Qualified back and end, 6" long  <b>E</b> = Qualified back and end, 7" long  <b>F</b> = Qualified back and end, 8" long  <b>G*</b> = Qualified back and end, 5.5" long  <b>H*</b> = Qualified back and end, 5.625" long  <b>I*</b> = Qualified back and end, 3" long  <b>J*</b> = Qualified back and end, 5.3" long  <b>K*</b> = Qualified back and end, 14" long  <b>L*</b> = Qualified back and end, 6.8" long  <b>M</b> = Qualified front and end, 4" long  <b>N</b> = Qualified front and end, 4.5" long  <b>P</b> = Qualified front and end, 5" long  <b>R</b> = Qualified front and end, 6" long  <b>S</b> = Qualified front and end, 7" long  <b>T</b> = Qualified front and end, 8" long  <b>U*</b> = Qualified front and end, 5.5" long  <b>V*</b> = Qualified back and end, 3.5" long  <b>W*</b> = Qualified front and end, 3.5" long  <b>Y*</b> = Qualified back and end, 3.75" long  <b>Z*</b> = Qualified back and end, 3.250" long</p> <p>* WIDIA™ standard only.</p>	<p><b>R =</b> Radial clearance for 4" minimum bore</p> <p><b>S =</b> 3.00 minimum bore</p> <p><b>KC =</b> D-Style Clamping</p>	<p><b>3</b> = .188"  <b>4</b> = .250"</p>
<p>This two-digit number indicates the holder cross section.</p> <ul style="list-style-type: none"> <li>For shanks 5/8" square and larger, the number represents the number of sixteenths of width and height.</li> <li>For shanks under 5/8" square, the number of sixteenths of cross-section are preceded by zero.</li> <li>For rectangular holders, the first digit represents the number of eighths of width "B" and the second digit the number of quarters of height "H", except for a toolholder 1-1/4" x 1-1/2", which is given the number 91.</li> </ul>					

INDEXABLE MILLING

SOLID END MILLING

HOLEMAKING

TAPPING

TURNING

# External Machining • D-Style Toolholders for Negative Inserts

INDEXABLE MILLING

SOLID END MILLING

HOLEMAKING

TAPPING

TURNING

## DCKN 15°

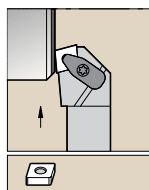

See pages E28-E42, E148, E171-E172 for inserts.

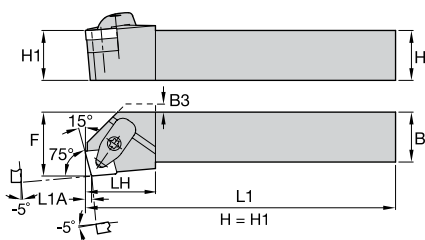

order number	catalog number	H	B	F	L1	LH	L1A	gage insert
<b>right hand</b>								
5696522	DCKNR164DKC3	1.00	1.00	1.250	6.00	1.25	.122	CN..432
5696524	DCKNR205DKC4	1.25	1.25	1.500	6.00	1.25	.150	CN..543
<b>left hand</b>								
5696308	DCKNL164DKC3	1.00	1.00	1.250	6.00	1.25	.122	CN..432

## DCLN -5°

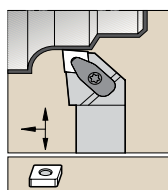

See pages E28-E42, E148, E171-E172 for inserts.

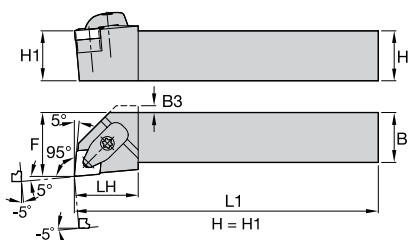

order number	catalog number	H	B	F	L1	LH	B3	gage insert
<b>right hand</b>								
5564319	DCLNR124BKC3	.75	.75	1.000	4.50	1.25	.15	CN..432
5564321	DCLNR164DKC3	1.00	1.00	1.250	6.00	1.25	—	CN..432
5564322	DCLNR165DKC4	1.00	1.00	1.250	6.00	1.38	—	CN..543
5564323	DCLNR166DKC4	1.00	1.00	1.250	6.00	1.38	—	CN..643
5564324	DCLNR204DKC3	1.25	1.25	1.500	6.00	1.25	—	CN..432
5564325	DCLNR205DKC4	1.25	1.25	1.500	6.00	1.38	—	CN..543
5564326	DCLNR206DKC4	1.25	1.25	1.500	6.00	1.63	—	CN..643
5564327	DCLNR244DKC3	1.50	1.50	2.000	6.00	1.25	—	CN..432
5564328	DCLNR245DKC4	1.50	1.50	2.000	6.00	1.38	—	CN..543
<b>left hand</b>								
5564295	DCLNL123BKC3	.75	.75	1.000	4.50	1.12	.06	CN..322
5564296	DCLNL124BKC3	.75	.75	1.000	4.50	1.25	.15	CN..432
5564298	DCLNL164DKC3	1.00	1.00	1.250	6.00	1.25	—	CN..432
5564299	DCLNL165DKC4	1.00	1.00	1.250	6.00	1.38	—	CN..543
5564310	DCLNL166DKC4	1.00	1.00	1.250	6.00	1.63	—	CN..643
5564311	DCLNL204DKC3	1.25	1.25	1.500	6.00	1.25	—	CN..432
5564312	DCLNL205DKC4	1.25	1.25	1.500	6.00	1.38	—	CN..543
5564313	DCLNL206DKC4	1.25	1.25	1.500	6.00	1.63	—	CN..643
5564315	DCLNL244DKC3	1.50	1.50	2.000	6.00	1.25	—	CN..432
5564316	DCLNL245DKC4	1.50	1.50	2.000	6.00	1.38	—	CN..543

## DCRN 15°

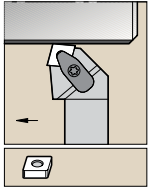

See pages E28-E42,  
E148, E171-E172  
for inserts.

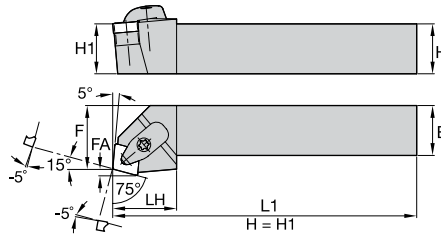

order number	catalog number	H	B	F	L1	LH	FA	gage insert
<b>right hand</b>								
5696532	DCRNR164DKC3	1.00	1.00	1.128	6.00	1.25	.12	CN..432

## DDJN -3°

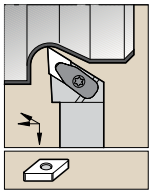

See pages E49-E60,  
E150, E165,  
E175-E176  
for inserts.

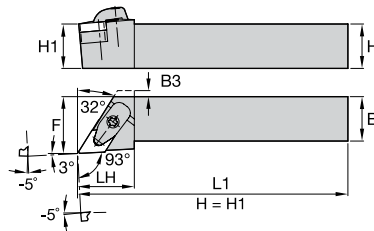

order number	catalog number	H	B	F	L1	LH	B3	gage insert
<b>right hand</b>								
5696544	DDJNR123BKC3	.75	.75	1.000	4.50	1.25	.06	DN..332
5696545	DDJNR163DKC3	1.00	1.00	1.250	6.00	1.25	—	DN..332
5696546	DDJNR164DKC3	1.00	1.00	1.250	6.00	1.25	—	DN..432
5696549	DDJNR204DKC3	1.25	1.25	1.500	6.00	1.25	—	DN..432
<b>left hand</b>								
5696538	DDJNL164DKC3	1.00	1.00	1.250	6.00	1.25	—	DN..432
5696541	DDJNL204DKC3	1.25	1.25	1.500	6.00	1.25	—	DN..432

INDEXABLE MILLING

SOLID END MILLING

HOLE/MAKING

TAPPING

TURNING

## DDPN 27.5°

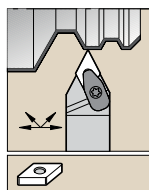

See pages E49-E60,  
E150, E165,  
E175-E176  
for inserts.

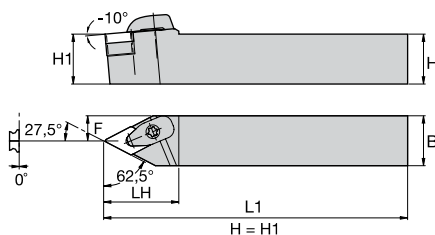

order number	catalog number	H	B	F	L1	LH	gage insert
neutral hand							
5696552	DDPNN164DKC3	1.00	1.00	.497	6.00	1.62	DN..432

## DDQN -17.5°

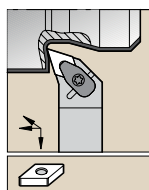

See pages E49-E60,  
E150, E165,  
E175-E176  
for inserts.

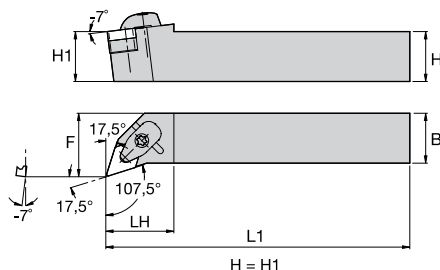

order number	catalog number	H	B	F	L1	LH	gage insert
right hand							
5564339	DDQNR164CKC3	1.00	1.00	1.250	5.00	1.38	DN..432
left hand							
5564337	DDQNL164DKC3	1.00	1.00	1.250	6.00	1.38	DN..432
5564338	DDQNL204DKC3	1.25	1.25	1.500	6.00	1.38	DN..432

## DRGN

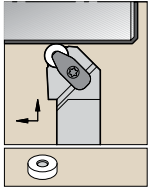

See page E63 for inserts.

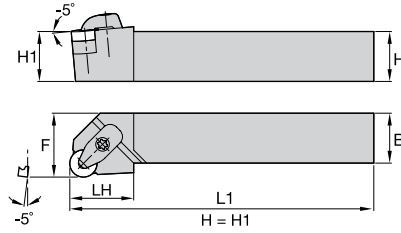

order number	catalog number	H	B	F	L1	LH	gage insert
<b>left hand</b>							
5697731	DRGNL164DKC3	1.00	1.00	1.250	6.00	1.25	RN..43
5697733	DRGNL204DKC3	1.25	1.25	1.500	6.00	1.25	RN..43

## DSDN 45°

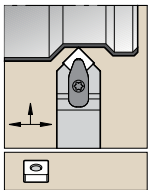

See pages E67-E78, E156, E177 for inserts.

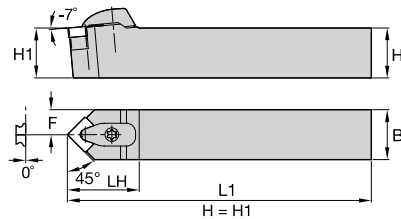

order number	catalog number	H	B	F	L1	LH	gage insert
<b>neutral hand</b>							
5697740	DSDNN124KC3	.75	.75	.375	4.50	1.44	SN..432
5697741	DSDNN164KC3	1.00	1.00	.500	6.00	1.44	SN..432
5697742	DSDNN204KC3	1.25	1.25	.625	6.00	1.44	SN..432



## DSRN 15°

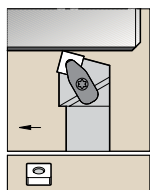

See pages E67-E78, E156, E177 for inserts.

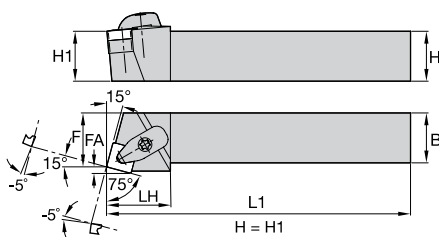

order number	catalog number	H	B	F	L1	LH	FA	gage insert
left hand								
5564342	DSRNL206DKC4	1.25	1.25	1.321	6.00	1.50	.18	SN..643

## DSSN 45°

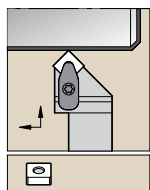

See pages E67-E78, E156, E177 for inserts.

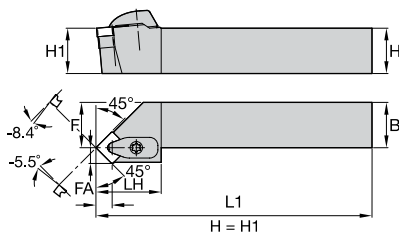

order number	catalog number	H	B	F	L1	LH	FA	gage insert
right hand								
5697754	DSSNR164DKC3	1.00	1.00	.912	6.00	1.50	.34	SN..432
left hand								
5697753	DSSNL164DKC3	1.00	1.00	.912	6.00	1.50	.34	SN..432

## DTGN 0°

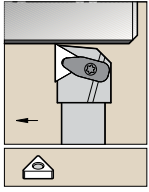

See pages E86-E95, E158, E167, E178 for inserts.

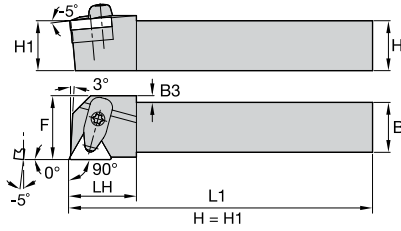

order number	catalog number	H	B	F	L1	LH	B3	gage insert
<b>right hand</b>								
5697764	DTGNR123BKC3	.75	.75	1.000	4.50	1.12	.25	TN..332
5697766	DTGNR164DKC3	1.00	1.00	1.250	6.00	1.25	.09	TN..432
<b>left hand</b>								
5697763	DTGNL164DKC3	1.00	1.00	1.250	6.00	1.25	.09	TN..432

## DVJN 3°

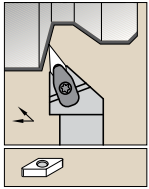

See pages E102-E108, E160, E169, E180 for inserts.

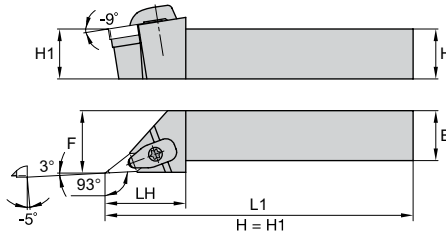

order number	catalog number	H	B	F	L1	LH	gage insert	
<b>right hand</b>								
5697781	DVJNR123CKC3	.75	.75	1.000	5.00	1.82	VN..332	
5564346	DVJNR163DKC3	1.00	1.00	1.250	6.00	1.82	VN..332	
5564347	DVJNR164DKC3	1.00	1.00	1.250	6.00	2.15	VN..432	
5697782	DVJNR853DKC3	1.25	1.00	1.250	6.00	1.82	VN..332	
5697783	DVJNR854DKC3	1.25	1.00	1.250	6.00	2.15	VN..432	
<b>left hand</b>								
5697768	DVJNL123CKC3	.75	.75	1.000	5.00	1.82	VN..332	
5564344	DVJNL163DKC3	1.00	1.00	1.250	6.00	1.82	VN..332	
5564345	DVJNL164DKC3	1.00	1.00	1.250	6.00	2.15	VN..432	
5697769	DVJNL853DKC3	1.25	1.00	1.250	6.00	1.82	VN..332	
5697780	DVJNL854DKC3	1.25	1.00	1.250	6.00	2.15	VN..432	

# External Machining • D-Style Toolholders for Negative Inserts

INDEXABLE MILLING

SOLID END MILLING

HOLEMAKING

TAPPING

TURNING

## DCLN 5°

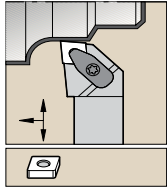

See pages E28-E42, E148, E171-E172 for inserts.

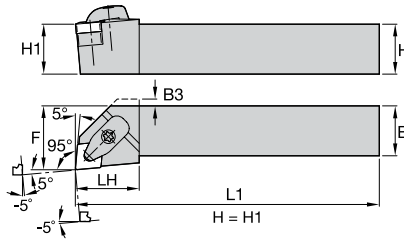

order number	catalog number	H	B	F	L1	LH	B3	gage insert
<b>right hand</b>								
5564319	DCLNR124BKC3	.75	.75	1.000	4.50	1.25	.15	CN..432
5564321	DCLNR164DKC3	1.00	1.00	1.250	6.00	1.25	—	CN..432
5564322	DCLNR165DKC4	1.00	1.00	1.250	6.00	1.38	—	CN..543
5564323	DCLNR166DKC4	1.00	1.00	1.250	6.00	1.38	—	CN..643
5564324	DCLNR204DKC3	1.25	1.25	1.500	6.00	1.25	—	CN..432
5564325	DCLNR205DKC4	1.25	1.25	1.500	6.00	1.38	—	CN..543
5564326	DCLNR206DKC4	1.25	1.25	1.500	6.00	1.63	—	CN..643
5564333	DCLNR3225P12KC04	1.26	.98	1.260	6.69	1.26	—	CN..120408
5564327	DCLNR244DKC3	1.50	1.50	2.000	6.00	1.25	—	CN..432
5564328	DCLNR245DKC4	1.50	1.50	2.000	6.00	1.38	—	CN..543
<b>left hand</b>								
5564295	DCLNL123BKC3	.75	.75	1.000	4.50	1.12	.06	CN..322
5564296	DCLNL124BKC3	.75	.75	1.000	4.50	1.25	.15	CN..432
5564298	DCLNL164DKC3	1.00	1.00	1.250	6.00	1.25	—	CN..432
5564299	DCLNL165DKC4	1.00	1.00	1.250	6.00	1.38	—	CN..543
5564310	DCLNL166DKC4	1.00	1.00	1.250	6.00	1.63	—	CN..643
5564311	DCLNL204DKC3	1.25	1.25	1.500	6.00	1.25	—	CN..432
5564312	DCLNL205DKC4	1.25	1.25	1.500	6.00	1.38	—	CN..543
5564313	DCLNL206DKC4	1.25	1.25	1.500	6.00	1.63	—	CN..643
5564315	DCLNL244DKC3	1.50	1.50	2.000	6.00	1.25	—	CN..432
5564316	DCLNL245DKC4	1.50	1.50	2.000	6.00	1.38	—	CN..543

## DVWN 17.5°

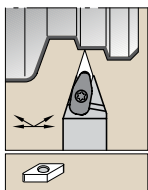

See pages E102-E108, E160, E169, E180 for inserts.

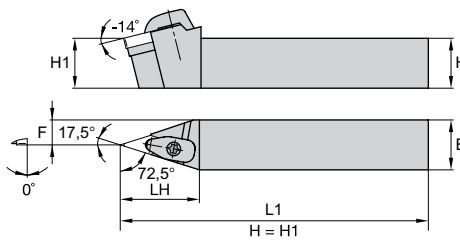

order number	catalog number	H	B	F	L1	LH	gage insert
<b>neutral hand</b>							
5564348	DVWNN163DKC3	1.00	1.00	.496	6.00	1.97	VN..332

## DWLN -5°

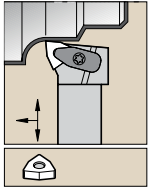

See pages  
E108-E116, E160,  
E170, E180  
for inserts.

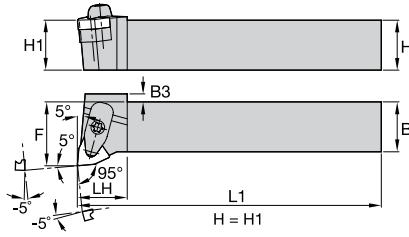

order number	catalog number	H	B	F	L1	LH	B3	gage insert
<b>right hand</b>								
5697789	DWLN123BKC3	.75	.75	1.000	4.50	1.00	.28	WN..332
5697790	DWLN163DKC3	1.00	1.00	1.250	6.00	1.00	.06	WN..332
5697791	DWLN164CKC3	1.00	1.00	1.250	5.00	1.00	.15	WN..432
5697792	DWLN164DKC3	1.00	1.00	1.250	6.00	1.00	.15	WN..432
<b>left hand</b>								
5697787	DWLN164DKC3	1.00	1.00	1.250	6.00	1.00	.15	WN..432

INDEXABLE MILLING

SOLID END MILLING

HOLE/MAKING

TAPPING

TURNING

## MCKN 15°

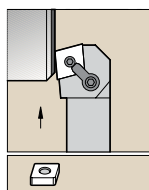

See pages E28-E42, E148, E171-E172 for inserts.

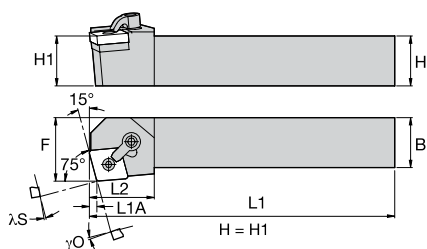

order number	catalog number	H	B	F	L1	L2	L1A	λS°	γO°	gage insert
<b>right hand</b>										
2951294	MCKNR164C	1.00	1.00	1.250	5.00	1.21	.12	-5.00	-5.0	CN..432

## MCMN 40°

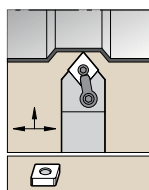

See pages E28-E42, E148, E171-E172 for inserts.

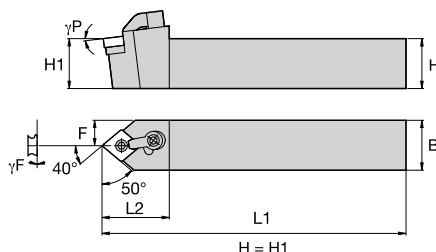

order number	catalog number	H	B	F	L1	L2	γP°	γF°	gage insert
<b>neutral hand</b>									
3851318	MCMNN124B	.75	.75	.375	4.50	1.39	-7.0	.0 deg	CN..432
3851319	MCMNN164D	1.00	1.00	.500	6.00	1.39	-7.0	.0 deg	CN..432

## MDJN -3°

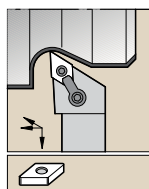

See pages E49-E60, E150, E165, E175-E176 for inserts.

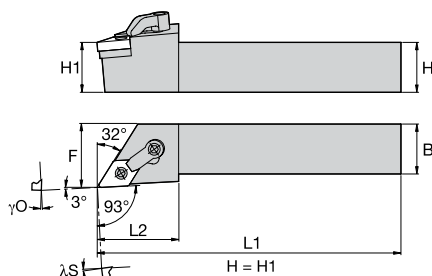

order number	catalog number	H	B	F	L1	L2	λS°	γO°	gage insert
<b>right hand</b>									
2953464	MDJNR124B	.75	.75	1.000	4.50	1.38	-5.00	-5.00	DN..432
2953465	MDJNR164C	1.00	1.00	1.250	5.00	1.24	-5.00	-5.00	DN..432

## MSDN 45°

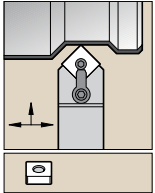

See pages E67-E78, E156, E177 for inserts.

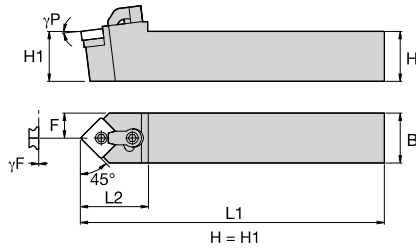

order number	catalog number	H	B	F	L1	L2	$\gamma_P^\circ$	$\gamma_F^\circ$	gage insert
neutral hand									
2953473	MSDNN083	.50	.50	.250	4.50	1.14	-7.0	.0	SN..322

## MTEN-S 30°

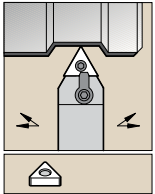

See pages E86-E95, E158, E167, E178 for inserts.

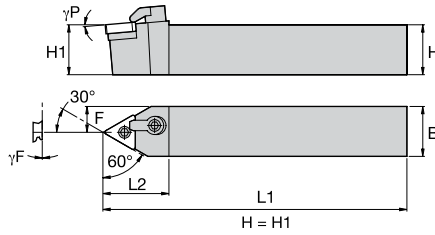

order number	catalog number	H	B	F	L1	L2	$\gamma_P^\circ$	$\gamma_F^\circ$	gage insert
neutral hand									
2951327	MTENNS164	1.00	1.00	.500	6.00	1.50	-10.0	.0	TN..432

## MTJN-S -3°

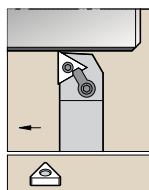

See pages E86-E95, E158, E167, E178 for inserts.

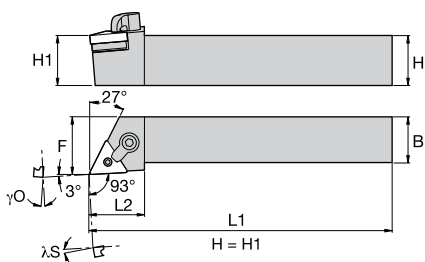

order number	catalog number	H	B	F	L1	L2	λS°	γO°	gage insert
<b>right hand</b>									
2951340	MTJNRS123	.75	.75	1.000	4.50	1.12	-5.00	-5.00	TN..332
2951341	MTJNRS163	1.00	1.00	1.250	6.00	1.12	-5.00	-5.00	TN..332
2951342	MTJNRS164	1.00	1.00	1.250	6.00	1.32	-5.00	-5.00	TN..432
<b>left hand</b>									
2951335	MTJNLS123	.75	.75	1.000	4.50	1.12	-5.00	-5.00	TN..332
2951337	MTJNLS164	1.00	1.00	1.250	6.00	1.32	-5.00	-5.00	TN..432

## MWLN -5°

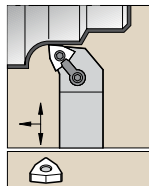

See pages E108-E116, E160, E170, E180 for inserts.

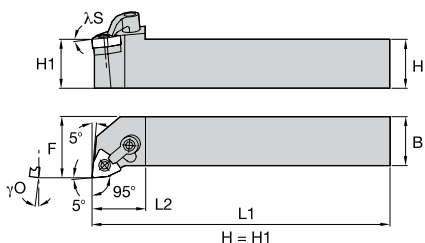

order number	catalog number	H	B	F	L1	L2	λS°	γO°	gage insert
<b>right hand</b>									
2951347	MWLN124B	.75	.75	1.000	4.50	1.12	-5.00	-5.00	WN..432
<b>left hand</b>									
2951344	MWLN124B	.75	.75	1.000	4.50	1.12	-5.00	-5.00	WN..432

## CSDN-MX 45°

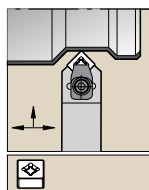

See pages E156-E157 for inserts.

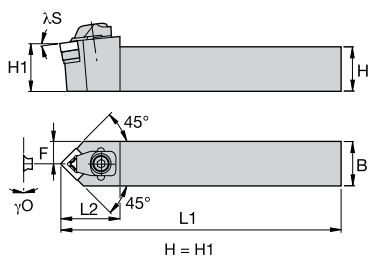

order number	catalog number	H	B	F	L1	L2	gage insert
neutral hand							
3093609	CSDNN164DMX5	1.00	1.00	.500	6.00	1.38	SN.X452

INDEXABLE MILLING

SOLID END MILLING

HOLE/MAKING

TAPPING

TURNING



INDEXABLE MILLING

SOLID END MILLING

HOLEMAKING

TAPPING

TURNING

## CSDP 45°

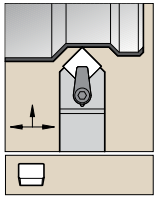

Steel shank with through coolant. See pages E79, E81-E82, E157 for inserts.

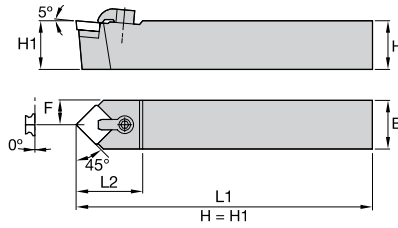

order number	catalog number	H	B	F	L1	L2	gage insert
neutral hand 2951285	CSDPN164	1.00	1.00	.500	6.00	1.38	SP.422

## SCGP 0°

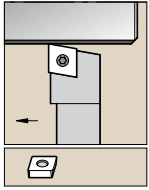

See pages E43, E163, E172-E173 for inserts.

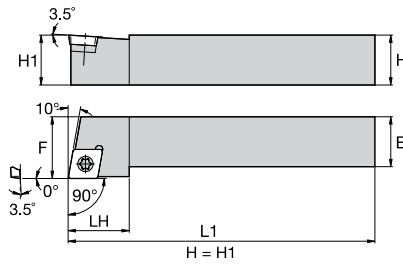

order number	catalog number	H	B	F	L1	L2	gage insert
<b>right hand</b>							
5094166	SCGPR083V	.50	.50	.625	3.50	.62	CP..3252

## SCLC -5°

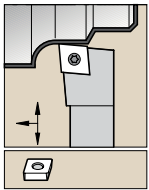

See pages E22-E27, E122, E161-E162, E170-E171 for inserts.

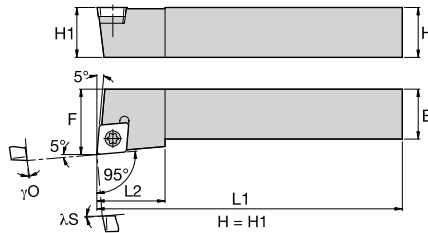

order number	catalog number	H	B	F	L1	L2	λS°	γO°	gage insert
<b>right hand</b>									
2951363	SCLCR083	.50	.50	.625	3.50	.63	.00	.00	CC..3252
2951364	SCLCR103	.63	.63	.750	4.00	.62	.00	.00	CC..3252
2951365	SCLCR123	.75	.75	1.000	4.50	.62	.00	.00	CC..3252
2951366	SCLCR164D	1.00	1.00	1.250	6.00	.75	.00	.00	CC..432
<b>left hand</b>									
2951350	SCLCL062	.38	.38	.500	2.50	.50	.00	.00	CC..2151
2951351	SCLCL083	.50	.50	.625	3.50	.63	.00	.00	CC..3252

INDEXABLE MILLING

SOLID END MILLING

HOLE/MAKING

TAPPING

TURNING

## SCLP -5°

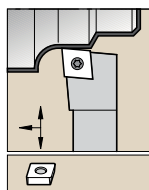

See pages E43, E163, E172-E173 for inserts.

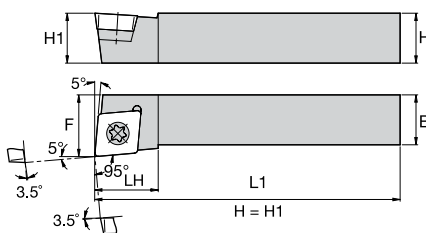

order number	catalog number	H	B	F	L1	L2	gage insert
<b>right hand</b>							
5094214	SCLPR062	.38	.38	.500	2.50	.44	CP..2151

## SDJC -3°

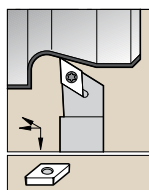

See pages E44-E48, E123, E164, E173-E174 for inserts.

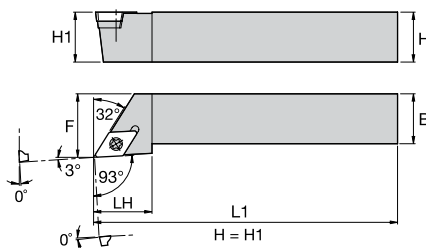

order number	catalog number	H	B	F	L1	L2	$\lambda_S^\circ$	$\gamma_0^\circ$	gage insert
<b>right hand</b>									
2951370	SDJCR123	.75	.75	1.000	4.50	.88	.00	.00	DC..3252
2951371	SDJCR163	1.00	1.00	1.250	6.00	.88	.00	.00	DC..3252
<b>left hand</b>									
2951367	SDJCL102	.63	.63	.750	4.00	.62	.00	.00	DC..2151

## SSDC 45°

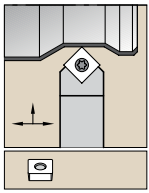

See pages E64-E67 for inserts.

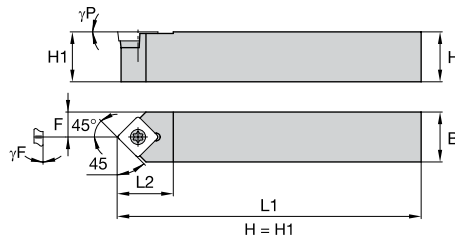

order number	catalog number	H	B	F	L1	L2	$\gamma_F^\circ$	$\gamma_P^\circ$	gage insert
neutral hand 2951372	SSDCN083	.50	.50	.250	3.50	.63	0.0	0.0	SC..3252

## STGP 0°

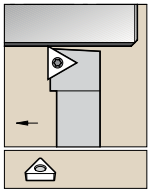

See pages E97, E168, E179 for inserts.

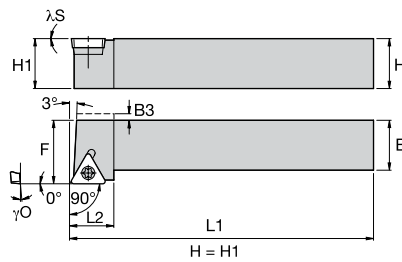

order number	catalog number	H	B	F	L1	L2	$\lambda_S^\circ$	$\gamma_O^\circ$	gage insert
right hand 5094259	STGPR082V	.50	.50	.625	3.50	.56	5.00 deg	.00 deg	TP..2151

INDEXABLE MILLING

SOLID END MILLING

HOLE/MAKING

TAPPING

TURNING

## SVJB -3°

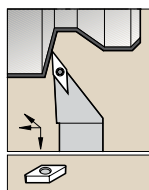

See pages  
E99-E101, E125,  
E169, E179  
for inserts.

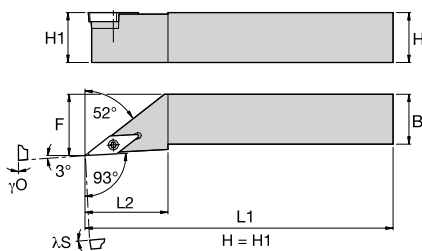

order number	catalog number	H	B	F	L1	L2	λS°	γO°	gage insert
<b>right hand</b>									
2951375	SVJBR123	.75	.75	1.000	4.50	1.38	.00	.00	VB..332
2951376	SVJBR163	1.00	1.00	1.250	6.00	1.38	.00	.00	VB..332
<b>left hand</b>									
2951373	SVJBL123	.75	.75	1.000	4.50	1.38	.00	.00	VB..332
2951374	SVJBL163	1.00	1.00	1.250	6.00	1.38	.00	.00	VB..332

## SVVB 17.5°

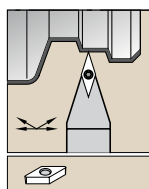

See pages  
E99-E101, E125,  
E169, E179  
for inserts.

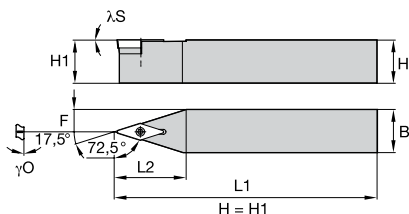

order number	catalog number	H	B	F	L1	L2	λS°	γO°	gage insert
<b>neutral hand</b>									
2951377	SVVBN163	1.00	1.00	.500	6.00	1.31	.00	.00	VB..332



# Tools for Internal Boring

## Boring Bars

WIDIA™ offers an extensive range of toolholders for internal boring to meet even the most precise production demands across a broad spectrum of workpiece shapes and sizes.



WIDIA boring bars, available with both a conventional steel shank or a vibration-resistant carbide shank and coolant hole, guarantee consistent results and enhanced production reliability.

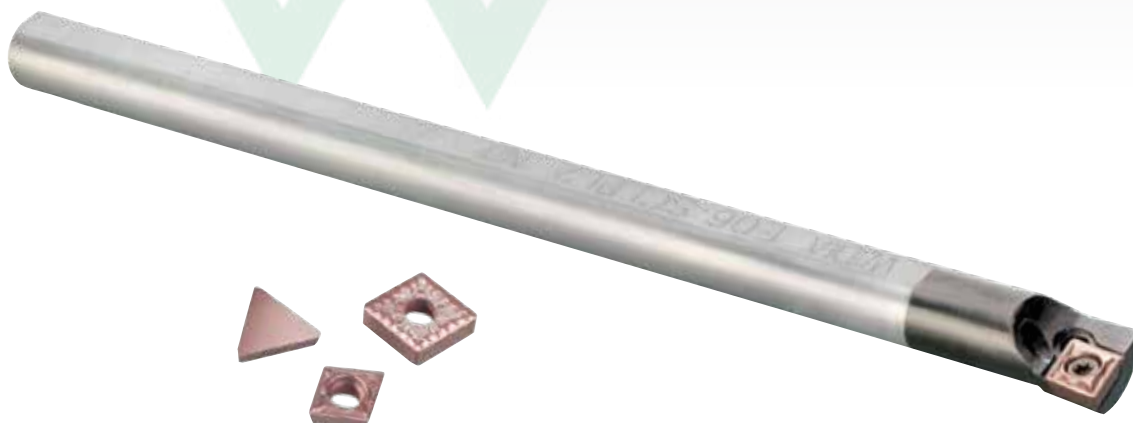

## TOOLS FOR INTERNAL BORING

### D-STYLE CLAMPING

- Used for negative style inserts.
- Clamp assembly contains clamp, screw, and retaining ring.
- Quick insert indexing.
- Ensures insert repeatability and seating.
- Reduced chatter and extended tool life.

### P-STYLE CLAMPING

- Lever-type clamping system for negative indexable inserts.
- No interference to chip flow.
- Fast insert changes.
- P-style available in metric sizes only.

### S-STYLE CLAMPING

- Screw clamping system for positive indexable inserts.
- Compact design for high reliability and cost efficiency.
- Carbide shim for additional tool protection.

### C-STYLE CLAMPING

- Height-adjustable clamp permits use of additional chipbreakers.
- Universal clamping system for positive and negative flat top inserts.
- Robust engineering makes it easy to handle.
- Carbide shim for extra tool protection.

### APPLICATIONS



BORING

### INDUSTRY





# Boring Bar Selection Guide

Each unique clamping system offers product options to fill your specific toolholder needs. Find the illustration that fits your application and navigate to the corresponding page to get the correct solution.

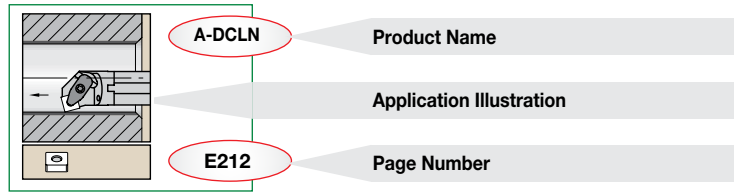

## D-Style Clamping

**D**

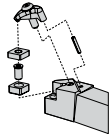

One-piece clamp assembly holder for use with negative style inserts. An extremely rigid clamping system. The tool is protected by a carbide shim.

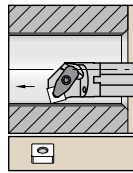

**A-DCFN**

0°

Page:

—

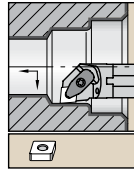

**A-DCLN**

-5°

Page:

**E212**

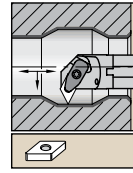

**A-DDPN**

27.5°

Page:

—

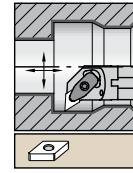

**A-DDUN**

-3°

Page:

—

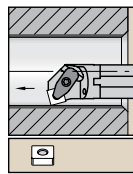

**A-DSKN**

15°

Page:

—

## C-Style Clamping

**C**

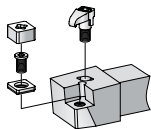

Top clamping system for negative and positive indexable inserts to DIN 4968. This universal clamping system is robust and easy to handle. Some height-adjustable clamps enable the use of additional chipbreakers. A carbide shim provides additional tool protection. Toolholders with cutting edge heights upwards of .625" and insert ICs greater than .250".

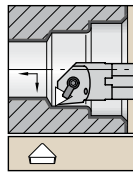

**A-CTFP**

0°

Page:

**E215**

INDEXABLE MILLING

SOLID END MILLING

HOLEMAKING

TAPPING

TURNING

## S-Style Clamping

**S**

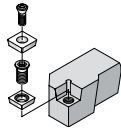

Screw clamping system for positive indexable inserts with countersunk hole to DIN 4967. Compact design using a minimum of spare parts for high reliability and cost efficiency. A carbide shim provides additional tool protection. Toolholders with cutting edge heights upwards of .625" and insert ICs from .375" are secured by means of a threaded bushing.

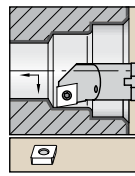

**A-SCFC**  
0°  
Page:  
**E216**

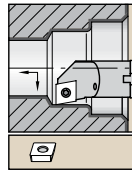

**A-SCFP**  
0°  
Page:  
**E216**

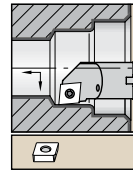

**A-SCLC**  
-5°  
Page:  
**E217**

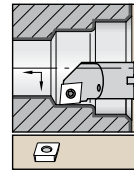

**A-SCLP**  
-5°  
Page:  
**E218**

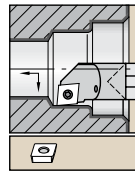

**E-SCLP**  
-5°  
Page:  
**E218**

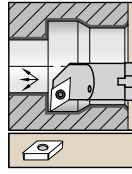

**A-SDUC**  
-3°  
Page:  
**E219**

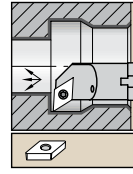

**A-SDUP**  
-3°  
Page:  
**E219**

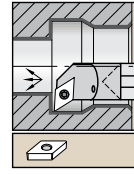

**E-SDUP**  
-3°  
Page:  
**E220**

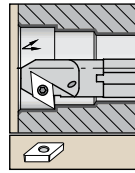

**A-SDXP**  
-5°  
Page:  
**E220**

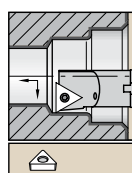

**A-STFC**  
0°  
Page:  
**E221**

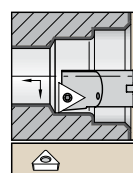

**A-STFP**  
0°  
Page:  
**E221**

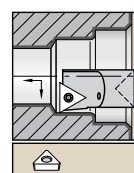



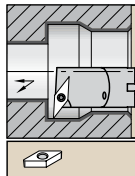









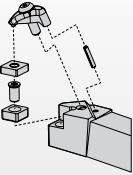
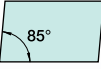
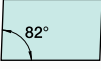



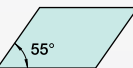
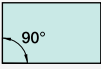
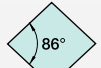





**E-STFP**  
0°  
Page:  
**E222**

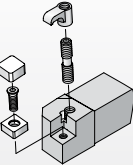

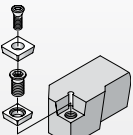
**A-SVUB**  
-3°  
Page:  
**E222**

## Catalog Numbering System

















Each character in our catalog number signifies a specific trait of that product. Use the following key columns and corresponding images to easily identify which attributes apply.

A	32	V	D	C
Bar Type	Bar Diameter	Bar Length**	Insert Holding Method	Insert Shape
<p><b>A</b> </p> <p>Steel bar with coolant</p>	<p></p> <p>Inch: A two-digit number indicates the bar diameter in 1/16" increments</p>	<p>3 = F 3.5 = G 4 = H 4.5 = J 5 = K 5.5 = L 6 = M 6.5 = N 7 = Q 8 = R 10 = S 12 = T 14 = U 16 = V 18 = W 20 = Y</p>	<p><b>D</b> </p>	<p><b>A</b> </p> <p><b>B</b> </p> <p><b>C</b> </p> <p><b>D</b> </p> <p><b>E</b> </p> <p><b>H</b> </p> <p><b>K</b> </p> <p><b>L</b> </p> <p><b>M</b> </p> <p><b>O</b> </p> <p><b>P</b> </p> <p><b>R</b> </p> <p><b>S</b> </p> <p><b>T</b> </p> <p><b>V</b> </p> <p><b>W</b> </p>
<p><b>S</b> </p> <p>Steel bar without coolant</p>			<p><b>C</b> </p>	
<p><b>C</b> </p> <p>Carbide bar</p>			<p><b>S</b> </p>	
<p><b>D</b> </p> <p>DeVibrator bar with coolant</p>				
<p><b>D</b> </p> <p>Tunable bar with coolant</p>				
<p><b>E</b> </p> <p>Carbide bar with coolant</p>				
<p><b>B</b> </p> <p>DeVibrator</p>				
<p><b>H</b> </p> <p>Interchangeable head</p>				
<p><b>L</b> </p> <p>Heavy metal bar with coolant</p>				

\*\*Used only when more than one length is available or a special length is required.

## Catalog Numbering System

(continued)

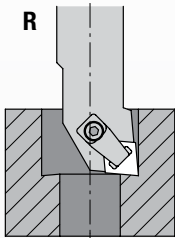
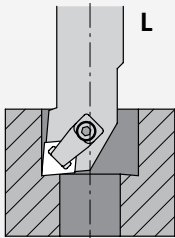
<b>L</b>	<b>N</b>	<b>R</b>	<b>5</b>	<b>KC4</b>
Bar Style or Lead Angle	Insert Clearance Angle	Hand of Tool	Insert Size	Additional Information
<p><b>E</b> </p> <p><b>F</b> </p> <p><b>K</b> </p> <p><b>L</b> </p> <p>(E-style inserts)</p> <p><b>L</b> </p> <p><b>P</b> </p> <p><b>Q</b> </p> <p><b>S</b> </p> <p><b>U</b> </p> <p><b>X</b> </p>	<p><b>N</b> 0° </p> <p><b>B</b> 5° </p> <p><b>C</b> 7° </p> <p><b>P</b> 11° </p> <p><b>D</b> 15° </p> <p><b>E</b> 20° </p> <p><b>F</b> 25° </p>	<p><b>R</b> = Right-hand boring bar</p> <p></p> <p><b>L</b> = Left-hand boring bar</p> <p></p>	<p>Insert <b>iC</b></p> <p>Number of 1/8ths of "D"</p>	<p><b>M...</b> = TNT/MTS clamping systems for ceramic and PcBN inserts</p> <p><b>D</b> = Dual pocket</p> <p><b>AP5</b> = Axil positive</p> <p><b>KC</b> = D-Style</p> <p><b>+</b> = Insert thickness</p>

# Internal Machining • D-Style Boring Bars for Negative Inserts

INDEXABLE MILLING

SOLID END MILLING

HOLEMAKING

TAPPING

TURNING

## A-DCLN -5°



Steel shank with through coolant.  
See pages E28-E42, E148, E171-E172 for inserts.

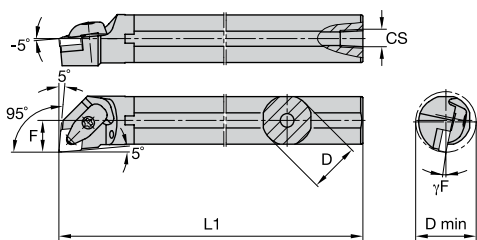

order number	catalog number	D	D min	F	L1	CS	$\gamma F^\circ$	gage insert
<b>right hand</b>								
5696297	A16TDCLNR4KC3	1.000	1.200	.640	12.00	1/4-18 NPT	-12.0	CN..432
5696298	A20UDCLNR4KC3	1.250	1.470	.765	14.00	1/4-18 NPT	-12.0	CN..432
5696299	A24UDCLNR4KC3	1.500	1.760	.890	14.00	1/4-18 NPT	-12.0	CN..432
5696300	A24UDCLNR5KC4	1.500	1.760	.890	14.00	1/4-18 NPT	-14.0	CN..543
5696302	A32VDCLNR4KC3	2.000	2.400	1.281	16.00	1/4-18 NPT	-12.0	CN..432
5696305	A40VDCLNR4KC3	2.500	3.030	1.531	16.00	1/4-18 NPT	-8.0	CN..432
5696306	A40VDCLNR6KC4	2.500	3.030	1.531	16.00	1/4-18 NPT	-10.0	CN..643
<b>left hand</b>								
5696286	A16TDCLNL4KC3	1.000	1.200	.640	12.00	1/4-18 NPT	-12.0	CN..432
5696287	A20UDCLNL4KC3	1.250	1.470	.765	14.00	1/4-18 NPT	-12.0	CN..432
5696288	A24UDCLNL4KC3	1.500	1.760	.890	14.00	1/4-18 NPT	-12.0	CN..432
5696291	A32VDCLNL4KC3	2.000	2.400	1.281	16.00	1/4-18 NPT	-12.0	CN..432

## A-MDUN -3°

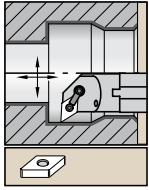

Steel shank with through coolant. See pages E49-E60, E150, E165, E175-E176 for inserts.

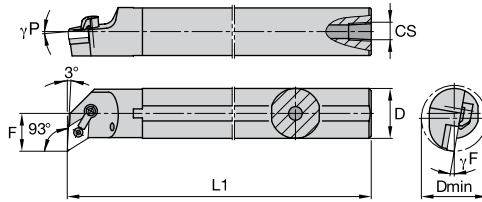

order number	catalog number	D	D min	F	L1	CS	$\gamma_F^\circ$	$\gamma_P^\circ$	gage insert
<b>right hand</b>									
2951412	A24UMDUNR4	1.500	2.000	1.120	14.00	1/4-18 NPT	-10.0	-5.0	DN..432
2951423	A32VMDUNR4	2.000	2.500	1.370	16.00	1/4-18 NPT	-8.0	-5.0	DN..432

## A-MVUN -3°

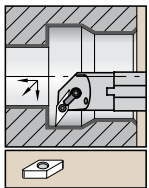

Steel shank with through coolant. See pages E102-E108, E160, E169, E180 for inserts.

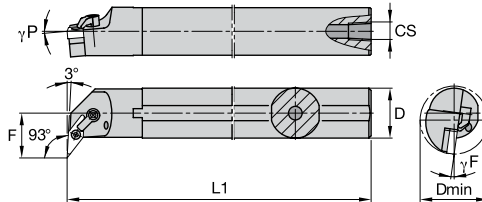

order number	catalog number	D	D min	F	L1	CS	$\gamma_F^\circ$	$\gamma_P^\circ$	gage insert
<b>right hand</b>									
3883412	A20UMVUNR3	1.250	1.705	1.000	14.00	1/4-18 NPT	-12.0	-5.0	VN..332

INDEXABLE MILLING

SOLID END MILLING

HOLE/MAKING

TAPPING

TURNING

## A-MWLN -5°

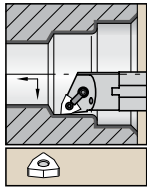

Steel shank with through coolant.  
See pages E108-E116, E160, E170, E180 for inserts.

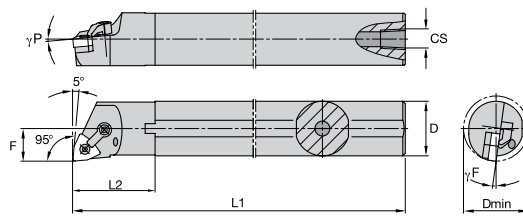

order number	catalog number	D	D min	F	L1	CS	$\gamma_F^\circ$	$\gamma_P^\circ$	gage insert
<b>right hand</b>									
2951390	A12SMWLN3	.750	.930	.500	10.00	1/8-27 NPT	-14.0	-5.0	WN.332
2951398	A16TMWLN4	1.000	1.220	.640	12.00	1/4-18 NPT	-12.0	-5.0	WN.432
2951407	A20UMWLN4	1.250	1.470	.765	14.00	1/4-18 NPT	-14.0	-5.0	WN.432

## A-CTFP 0°

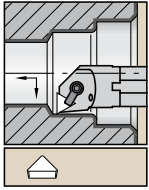

Steel shank with through coolant. See pages E96-E98, E159, E168 for inserts.

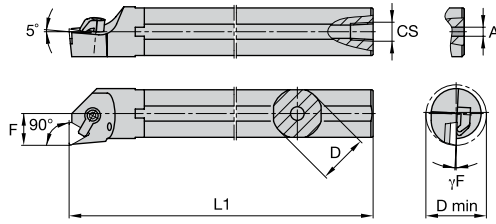

order number	catalog number	D	D min	F	L1	A	CS	γF°	gage insert
right hand 2951400	A20UCTFPR3	1.250	1.470	.765	14.00	6,35	1/4-18 NPT	-3.0	TP.322

INDEXABLE MILLING

SOLID END MILLING

HOLE/MAKING

TAPPING

TURNING



## A-SCFC 0°

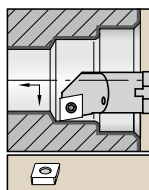

Steel shank with through coolant. See pages E22-E27, E122, E161-E162, E170-E171 for inserts.

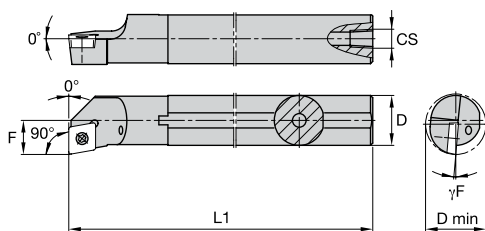

order number	catalog number	D	D min	F	L1	CS	γF°	gage insert
<b>right hand</b>								
3883416	A08RSCFCR2	.500	.600	.312	8.00	1/16-27 NPT	-7.0	CC..2151
3883421	A12SSFCR3	.750	.930	.500	10.00	1/8-27 NPT	-5.0	CC..3252

## A-SCFP 0°

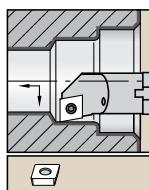

Steel shank with through coolant.

See pages E43, E163, E172-E173 for inserts.

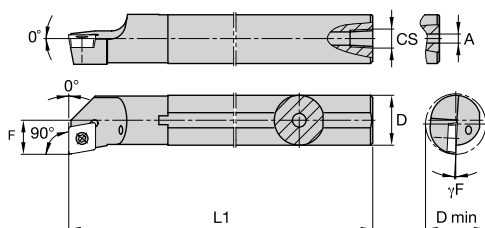

order number	catalog number	D	D min	F	L1	A	CS	γF°	gage insert
<b>right hand</b>									
5077440	A06MSCFPR2	.375	.480	.250	6.00	.13	—	-4.0	CP..2151
5077445	A08RSCFPR2	.500	.600	.312	8.00	—	1/16-27 NPT	-2.0	CP..2151
5077499	A12SSCFPR3	.750	.930	.500	10.00	—	1/8-27 NPT	-2.0	CP..3252

## A-SCLC -5°

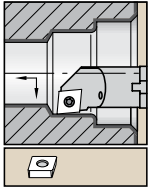

Steel shank with through coolant. See pages E22-E27, E122, E161-E162, E170-E171 for inserts.

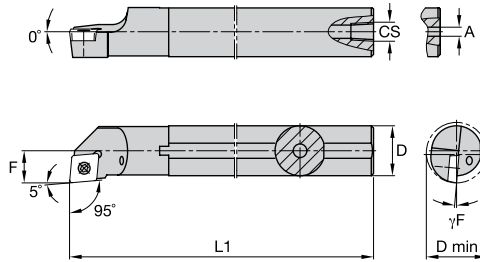

order number	catalog number	D	D min	F	L1	A	CS	γF°	gage insert
<b>right hand</b>									
2951383	A06MSCLCR2	.375	.480	.250	6.00	.13	—	-8.0	CC..2151
2951386	A08RSCLCR2	.500	.600	.312	8.00	—	1/16-27 NPT	-7.0	CC..2151
2951388	A10SSCLCR2	.625	.770	.406	10.00	—	1/8-27 NPT	-5.0	CC..2151
2951392	A12SSCLCR3	.750	.930	.500	10.00	—	1/8-27 NPT	-5.0	CC..3252
2951399	A16TSCLCR3	1.000	1.200	.640	12.00	—	1/4-18 NPT	-4.0	CC..3252
2951408	A20USCLCR4	1.250	1.470	.765	14.00	—	1/4-18 NPT	-5.0	CC..432
2951418	A24USCLCR4	1.500	1.760	.890	14.00	—	1/4-18 NPT	-4.0	CC..432
<b>left hand</b>									
2951391	A12SSCLCL3	.750	.930	.500	10.00	—	1/8-27 NPT	-5.0	CC..3252

INDEXABLE MILLING

SOLID END MILLING

HOLEMAKING

TAPPING

TURNING

# Internal Machining • S-Style Boring Bars for Positive Inserts

INDEXABLE MILLING

SOLID END MILLING

HOLEMAKING

TAPPING

TURNING

## A-SCLP -5°



See pages E43, E163, E172-E173 for inserts.  
Steel shank with through coolant.

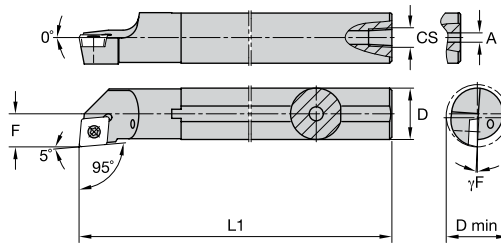

order number	catalog number	D	D min	F	L1	A	CS	γF°	gage insert
<b>right hand</b>									
5077618	A06MSCLPR2	.375	.480	.250	6.00	.13	—	-6.0	CP..2151
5077643	A08RSCLPR2	.500	.600	.312	8.00	.16	1/16-27 NPT	-3.0	CP..2151
5077648	A10SSCLPR2	.625	.770	.406	10.00	—	1/8-27 NPT	-2.0	CP..2151
5077649	A10SSCLPR3	.625	.770	.406	10.00	.16	1/8-27 NPT	-2.0	CPMT3252
5077686	A12SSCLPR3	.750	.930	.500	10.00	—	1/8-27 NPT	-2.0	CP..3252
5077699	A16TSCLPR3	1.000	1.200	.640	12.00	—	1/4-18 NPT	.0	CP..3252
<b>left hand</b>									
5077616	A06MSCLPL2	.375	.480	.250	6.00	.13	—	-6.0	CP..2151
5077682	A12SSCLPL3	.750	.930	.500	10.00	—	1/8-27 NPT	-2.0	CP..3252

## E-SCLP -5°



See pages E43, E163, E172-E173 for inserts.  
Carbide shank with through coolant.

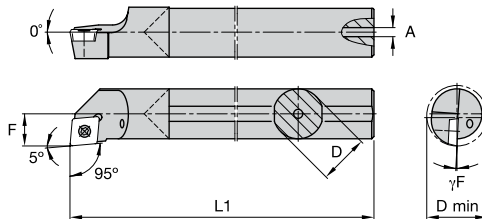

order number	catalog number	D	D min	F	L1	A	γF°	gage insert
<b>right hand</b>								
5093183	E16TSCLPR3	.312	1.200	.640	12.000	.281	.0	CP..3252
5093092	E06MSCLPR2	.375	.480	.250	6.000	.125	-6.0	CP..2151
5093096	E08RSCLPR2	.500	.600	.312	8.000	.187	-2.0	CP..2151
5093142	E10SSCLPR3	.625	.770	.406	10.000	.218	-3.0	CP..3252
5093148	E12SSCLPR3	.750	.930	.500	10.000	.281	-2.0	CP..3252
<b>left hand</b>								
5093095	E08RSCLPL2	.500	.600	.312	8.000	.187	-2.0	CP..2151

## A-SDUC -3°

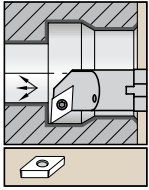

Steel shank with through coolant. See pages E44-E48, E123, E164, E173-E174 for inserts.

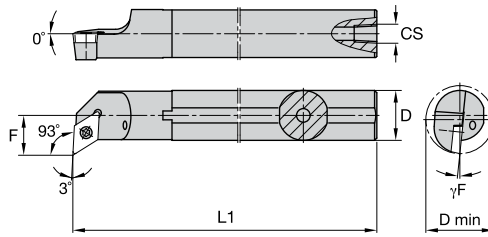

order number	catalog number	D	D min	F	L1	CS	γF°	gage insert
<b>right hand</b>								
2951394	A12SSDUCR3	.750	.980	.562	10.00	1/8-27 NPT	-5.0	DC..3252
<b>left hand</b>								
2951393	A12SSDUCL3	.750	.980	.562	10.00	1/8-27 NPT	-5.0	DC..3252

## A-SDUP -3°



See pages E165, E166 for inserts. Steel shank with through coolant.

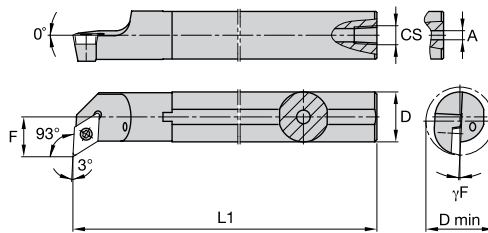

order number	catalog number	D	D min	F	L1	A	CS	γF°	gage insert
<b>right hand</b>									
5078324	A06MSDUPR2	.375	.600	.375	6.000	.125	—	-3.0	DP..2151
5078326	A08RSDUPR2	.500	.730	.437	8.000	.156	1/16-27 NPT	.0	DP..2151
5078366	A16TSDUPR3	1.000	1.300	.750	12.000	.250	1/4-18 NPT	.0	DP..3252

INDEXABLE MILLING

SOLID END MILLING

HOLE/MAKING

TAPPING

TURNING

## E-SDUP -3°

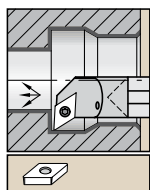

Carbide shank with through coolant.

See pages E165, E166 for inserts.

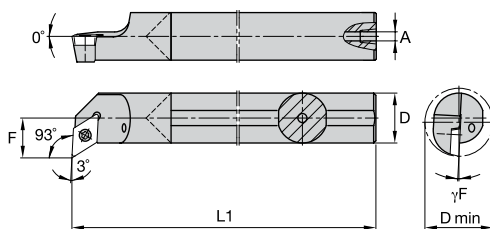

order number	catalog number	D	D min	F	L1	A	$\gamma F^\circ$	gage insert
right hand								
5093424	E08RSDUPR2	.500	.730	.437	8.000	.187	.0	DP..2151

## A-SDXP -5°

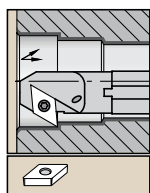

See pages E165, E166 for inserts.

Steel shank with through coolant.

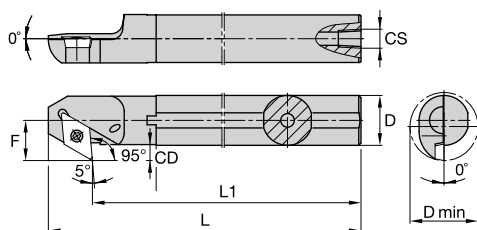

order number	catalog number	D	D min	F	L1	L	CD	CS	gage insert
left hand									
5078402	A12SSDXPL3	.750	.980	.562	10.00	10.63	.187	1/8-27 NPT	DP..3252

## A-STFC 0°

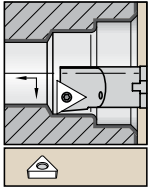

Steel shank with through coolant.

See pages E82-E85, E124, E166-E167, E178 for inserts.

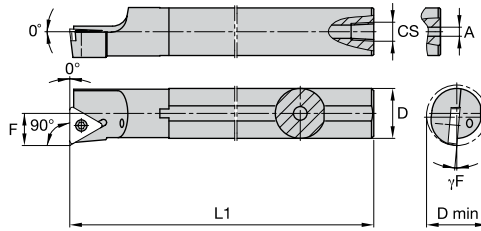

order number	catalog number	D	D min	F	L1	A	CS	γF°	gage insert
<b>right hand</b>									
2951385	A06MSTFCR2	.375	.480	.250	6.00	.13	—	-8.0	TC..2151
2951387	A08RSTFCR2	.500	.600	.312	8.00	.16	1/16-27 NPT	-7.0	TC..2151
2951389	A10SSTFCR2	.625	.770	.406	10.00	.16	1/8-27 NPT	-5.0	TC..2151
2951395	A12SSTFCR2	.750	.930	.500	10.00	.16	1/8-27 NPT	-5.0	TC..2151

## A-STFP -0°



See pages E97, E168, E179 for inserts.  
Steel shank with through coolant.

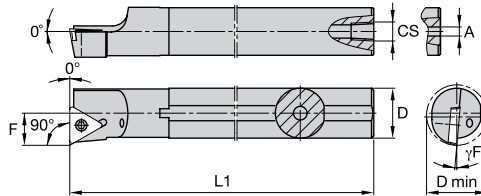

order number	catalog number	D	D min	F	L1	A	CS	γF°	gage insert
<b>right hand</b>									
5086723	A06MSTFPR2	.375	.480	.250	6.000	.125	—	-4.0	TP..2151
5086728	A08RSTFPR2	.500	.600	.312	8.000	.160	—	-2.0	TP..2151
5086804	A12SSTFPR3	.750	.930	.500	10.000	.156	1/8-27 NPT	-2.0	TPMT3252

# Internal Machining • S-Style Boring Bars for Positive Inserts

INDEXABLE MILLING

SOLID END MILLING

## E-STFP -0°

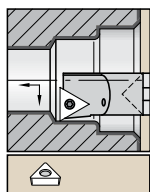

Carbide shank with through coolant.  
See pages E97, E168, E179 for inserts.

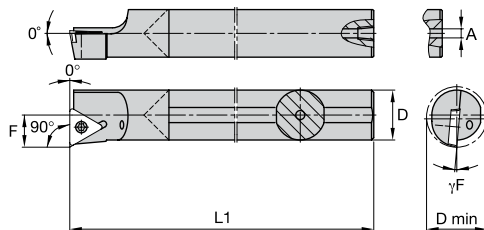

order number	catalog number	D	D min	F	L1	A	γF°	gage insert
<b>right hand</b>								
5093698	E08RSTFPR2	.500	.600	.312	8.000	.187	-2.0	TP..2151

HOLEMAKING

TAPPING

## A-SVUB -3°

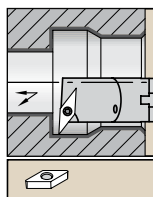

Steel shank with through coolant.  
See pages E99-E101, E125, E169, E179 for inserts.

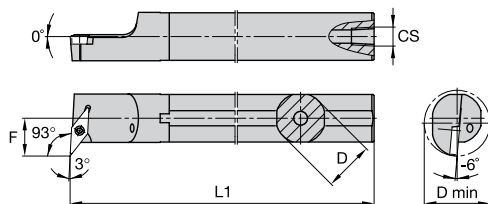

order number	catalog number	D	D min	F	L1	CS	gage insert
<b>right hand</b>							
3883423	A12SSVUBR2	.750	.980	.562	10.00	1/8-27 NPT	VB..221
3883425	A16TSVUBR3	1.000	1.300	.750	12.00	1/4-18 NPT	VB..332
<b>left hand</b>							
3883422	A12SSVUBL2	.750	.980	.562	10.00	1/8-27 NPT	VB..221
3883424	A16TSVUBL3	1.000	1.300	.750	12.00	1/4-18 NPT	VB..332

TURNING

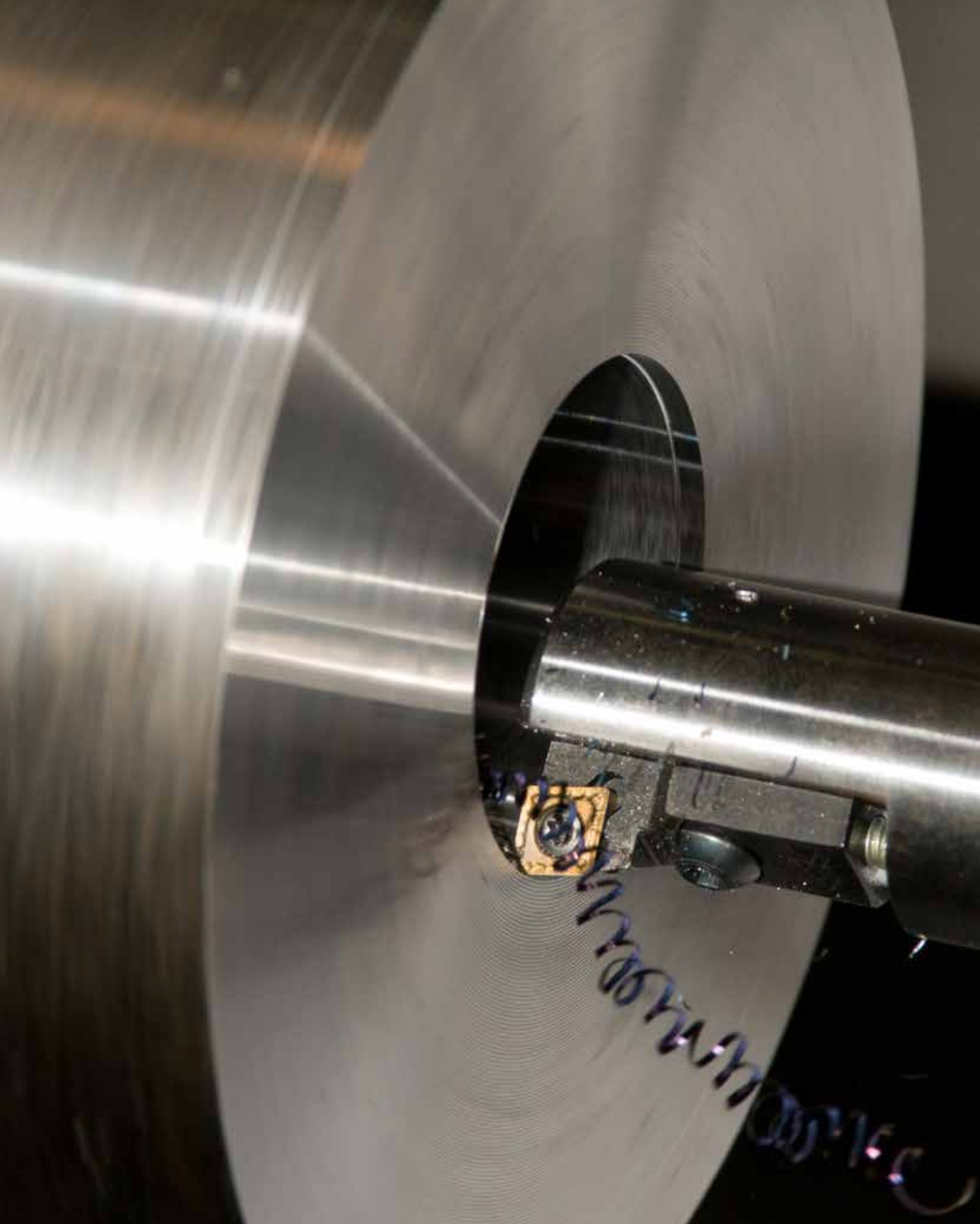



# Cartridges

## Cartridges for Negative and Positive Inserts

Standard WIDIA™ cartridges are ideal for turning tools with one or several cutting edges. A wide range of cartridge sizes and styles provides numerous combinations and application possibilities.

Same clamping systems as standard turning toolholders. Overall sizes to DIN and ISO are ideal for single- and multi-tooth turning, boring, and spotting tools.

Precise axial and radial positioning by adjustment screws.



# CARTRIDGES

## P-STYLE CLAMPING

- Lever-type clamping system for negative indexable inserts with hole to DIN 4988 and positive round inserts more than 20mm in diameter.
- Inserts with one- and two-side chip control geometries have positive rakes from 6° to 18°.
- Advantages of this system are fast insert changes and no interference with chip flow.
- P-style available in metric sizes only.

## S-STYLE CLAMPING

- Screw clamping system for positive indexable inserts with countersunk hole to DIN 4967.
- Compact design using a minimum of spare parts for high reliability and cost efficiency.
- A carbide shim provides additional tool protection.
- Toolholders with cutting edge heights upwards of 16mm (.625") and insert iCs from 9,52mm (.375") are secured by means of a threaded bushing.

## APPLICATIONS



BORING

I. D.  
CHAMFERING

I. D. FACING

## INDUSTRY



# Cartridges

Each unique clamping system offers product options to fill your specific toolholder needs. Find the illustration that fits your application and navigate to the corresponding page to get the correct solution.

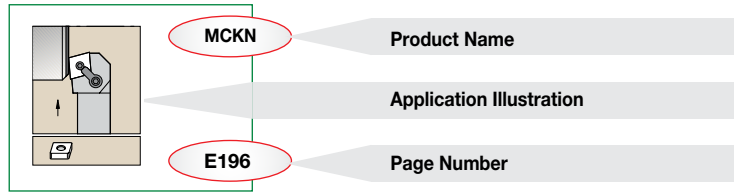

## Clamping System M

**M**

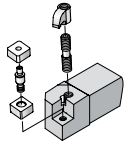

Combined pin/wedge clamp for negative inserts. An extremely sturdy clamping system, specially designed for interrupted cuts. The tool is protected by a carbide shim.

	<b>MCFN</b> 0° Page: —		<b>MCKN</b> 15° Page: E196		<b>MCLN</b> -5° Page: —		<b>MDJN</b> -3° Page: E196
	<b>MDQN</b> -17.5° Page: —		<b>MSKN</b> 15° Page: —		<b>MSRN</b> 15° Page: —		<b>MSSN</b> 45° Page: —
	<b>MSTN</b> 30° Page: —		<b>MSYN</b> 5° Page: —		<b>MTFN</b> 0° Page: —		<b>MTGN</b> 0° Page: —

INDEXABLE MILLING

SOLID END MILLING

HOLEMAKING

TAPPING

TURNING

## Clamping System S

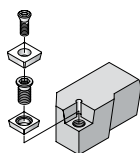
**S**

Combined pin/wedge clamp for negative inserts. An extremely sturdy clamping system, specially designed for interrupted cuts. The tool is protected by a carbide shim.

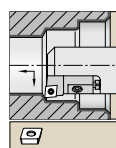
**SCFP**

0°

Page:

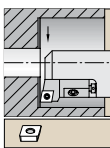
**E230**

**SCGP**

0°

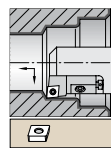
Page:

**E201**

**SCLC**

-5°

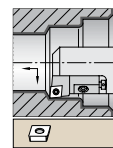
Page:

**E201**

**SCLP**

-5°

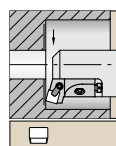
Page:

**E202**

**SCRP**

15°

Page:

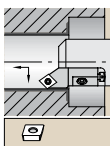
-

**SCSP**

45°

Page:

-

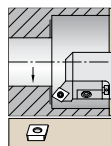
**SCTP**

30°

Page:

-

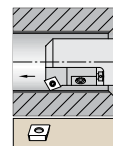
**SCWP**

30°

Page:

-

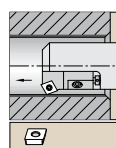
**SDJP**

-3°

Page:

-

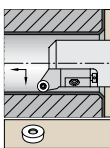
**SRGC**

0°

Page:

-

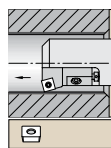
**SSKC**

15°

Page:

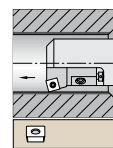
**E231**

**SSKP**

15°

Page:

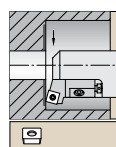
-

**SSRC**

15°

Page:

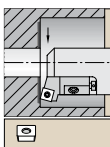
**E231**

**SSRP**

15°

Page:

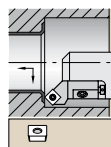
-

**SSSC**

45°

Page:

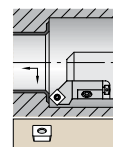
**E232**

**SSSP**

45°

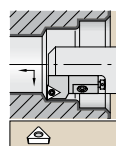
Page:

**E232**

**STFP**

0°

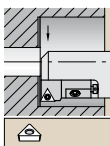
Page:

**E233**

**STGP**

0°

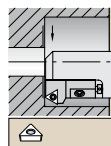
Page:

**E203**

**STTP**

30°

Page:

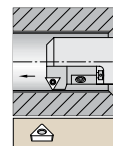
-

**STWP**











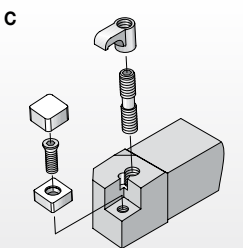
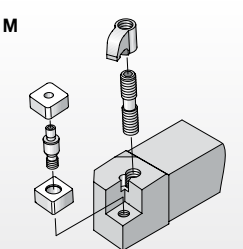
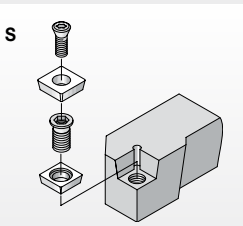





30°

Page:

**E233**

## Catalog Numbering System

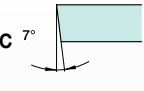
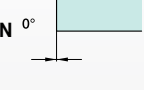
Each character in our catalog number signifies a specific trait of that product. Use the following key columns and corresponding images to easily identify which attributes apply.

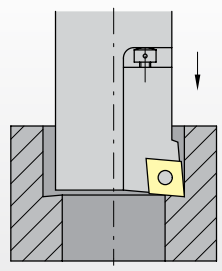
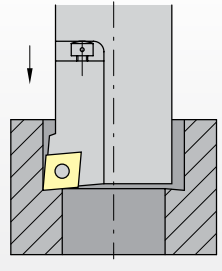
<b>M</b>	<b>C</b>	<b>F</b>	<b>N</b>	<b>R</b>
<p><b>Insert Clamping System</b></p>  <p><b>C</b></p> <p>Top clamping by clamping finger for inserts without hole.</p>  <p><b>M</b></p> <p>Top and hole clamping for inserts with hole.</p>  <p><b>S</b></p> <p>Center clamping by screw for inserts with hole.</p>	<p><b>Insert Shape</b></p>  <p><b>C</b> 80°</p>  <p><b>D</b> 55°</p>  <p><b>R</b></p>  <p><b>S</b> 90°</p>  <p><b>T</b> 60°</p>  <p><b>W</b> 80°</p>	<p><b>Cartridge Style</b></p>  <p><b>F</b> 0°</p>  <p><b>K</b> 15°</p>  <p><b>L</b> 5°</p>  <p><b>J</b> 3°</p>  <p><b>Q</b> 27.5°</p>  <p><b>R</b> 15°</p>  <p><b>S</b> 45°</p>  <p><b>G</b> 0°</p>	<p><b>Insert Clearance Angle</b></p>  <p><b>C</b> 7°</p>  <p><b>N</b> 0°</p>  <p><b>P</b> 11°</p>	<p><b>Hand of Tool</b></p> <p><b>Right-hand cartridge</b></p>  <p><b>R</b></p> <p><b>Left-hand cartridge</b></p>  <p><b>L</b></p>

## Catalog Numbering System

(continued)

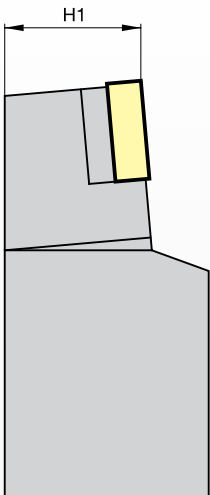
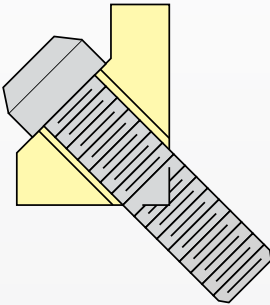
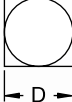
10	C	A	3	
Cartridge Size	Identifying Code of Cartridge	Mounting Design of Cartridge	Insert Size	Additional Information
 <p>A technical drawing of a cartridge mounted on a tool holder. A horizontal dimension line above the cutting edge is labeled 'H1', indicating the cutting edge height of the cartridge in inches.</p>	<p><b>C</b> = Cartridge</p>	<p>A-design conforming to ISO 5611</p>  <p>A perspective view of a cartridge mounted on a tool holder, showing the A-design mounting configuration.</p>	 <p>A square diagram representing an insert with a circular cutting edge. A horizontal dimension line below the circle is labeled 'D', representing the diameter of the insert.</p> <p><b>Insert iC</b> Number of 1/8ths of "D"</p>	

INDEXABLE MILLING

SOLID END MILLING

HOLE/MAKING

TAPPING

TURNING

## SCFP 0°

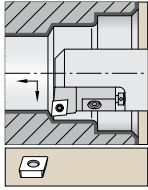

See pages E43, E163, E172-E173 for inserts.

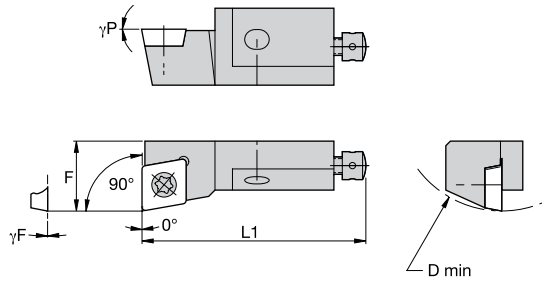

order number	catalog number	D min	F	L1	$\gamma_F^\circ$	$\gamma_P^\circ$	gage insert
<b>right hand</b>							
3871284	SCFPR06CA05	.787	.315	.98	.0	.0	CP..050204/CP..18151
3871283	SCFPR08CA06	.984	.394	1.26	.0	.0	CP..060204/CP..2151
3871272	SCFPR10CA09	1.575	.551	1.97	.0	.0	CP..09T308/CP..3252

## SCLC -5°

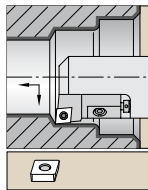

See pages E22-E27, E122, E161-E162, E170-E171 for inserts.

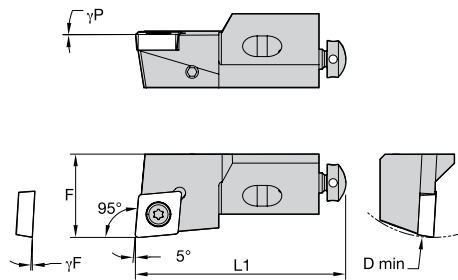

order number	catalog number	D min	F	L1	$\gamma_F^\circ$	$\gamma_P^\circ$	gage insert
<b>left hand</b>							
3871267	SCLCL12CA12	1.969	.787	2.17	-3.0	.0	CC..120408/CC..432

## SSKC 15°

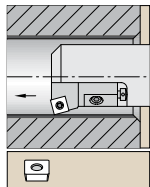

See pages E64-E67 for inserts.

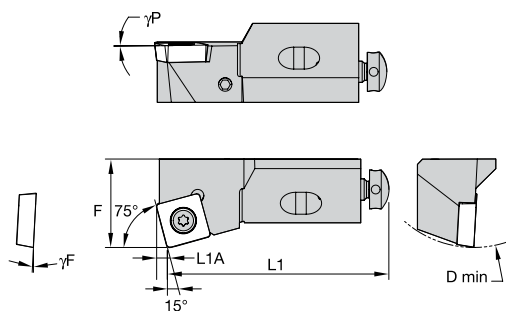

order number	catalog number	D min	F	L1	L1A	$\gamma_F^\circ$	$\gamma_P^\circ$	gage insert
<b>right hand</b> 3871191	SSKCR12CA12	1.969	.787	2.17	.12	-3.0	.0	SC..120408/SC..432

## SSRC 15°

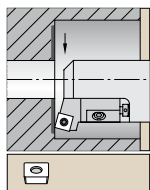

See pages E64-E67 for inserts.

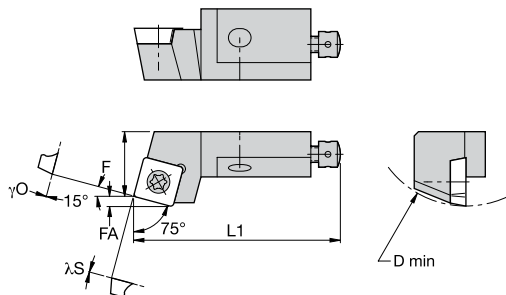

order number	catalog number	D min	F	L1	FA	$\lambda_S^\circ$	$\gamma_O^\circ$	gage insert
<b>left hand</b> 3870391	SSRCL12CA12	1.969	.787	2.17	.121	-3.0	.0	SC..120408/SC..432



INDEXABLE MILLING

SOLID END MILLING

## SSSC 45°

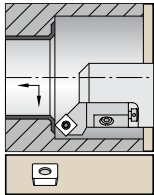

See pages E64-E67 for inserts.

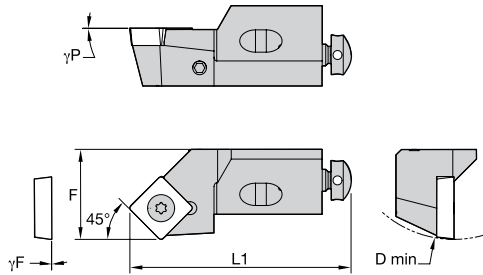

order number	catalog number	D min	F	L1	γF°	γP°	gage insert
right hand							
3870385	SSSCR12CA12	1.969	.787	1.85	-3.0	.0	SC..120408/SC..432

HOLEMAKING

TAPPING

## SSSP 45°

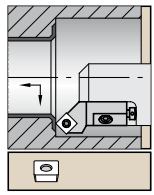

See page E80 for inserts.

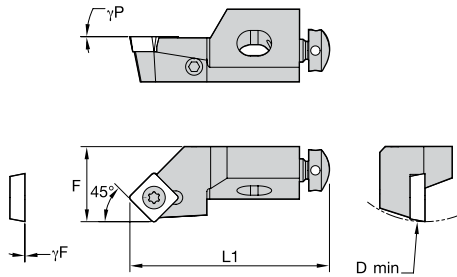

order number	catalog number	D min	F	L1	γF°	γP°	gage insert
right hand							
3870382	SSSPR10CA09	1.575	.551	1.73	.0	.0	SP..09T308/SP..3252

TURNING

## STFP 0°

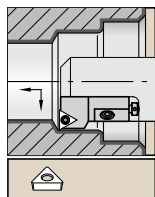

See pages E97, E168, E179 for inserts.

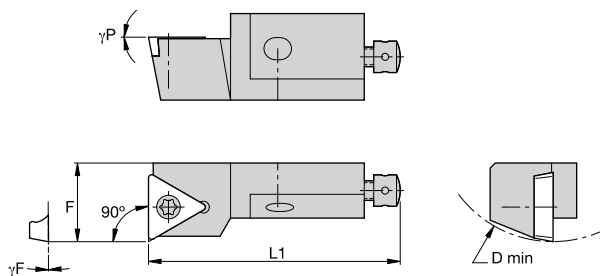

order number	catalog number	D min	F	L1	$\gamma_F^\circ$	$\gamma_P^\circ$	gage insert
<b>right hand</b>							
3870378	STFPR08CA09	.984	.394	1.26	.0	.0	TP..090204/TP..18151

## STWP 30°

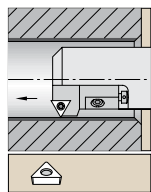

See pages E97, E168, E179 for inserts.

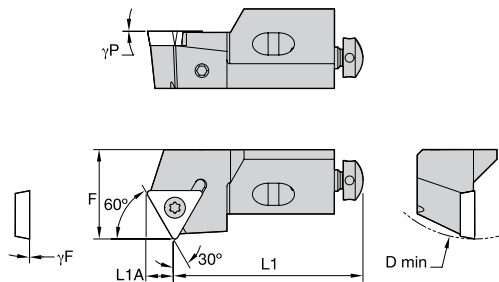

order number	catalog number	D min	F	L1	L1A	$\gamma_F^\circ$	$\gamma_P^\circ$	gage insert
<b>right hand</b>								
3870364	STWPR08CA09	.984	.394	1.10	.17	.0	.0	TP..090204/TP..18151
<b>left hand</b>								
3870365	STWPL12CA16	1.969	.787	1.85	.28	.0	.0	TP..16T308/TP..3252

# Railway Wheelset Reconditioning Tools

## Wheel Reprofilng/Wheelset Turning

Toolholders and indexable inserts for all types of wheel lathes used in the railroad industry.



### TOOLHOLDERS

- Robust lever clamping design with no top clamp to interfere with chip flow.
- Toolholders are made from heat-treated alloy steel, providing rigid support to the insert to withstand severe roughing cuts on work-hardened wheels.



### INSERTS

- Upended inserts are neutral and common for either hand of the toolholder.
- Multiple chipbreaker profiles and highly wear-resistant coated carbide grades
- Grades are available to machine the wheels in a range of wear conditions.

## WIDIA™ TOOLS FOR RAILWAY WHEEL MACHINING

WIDIA offers toolholders and indexable inserts for all types of wheel lathes being used in the Industry.

- The tooling for wheelset reprofiling/reconditioning has been developed in close cooperation with machine tool builders and railway workshops.
- The wheel profile wears during usage and also due to skidding, mismatched wheels, etc.
- Different chipbreaker profiles and grades are available to machine the wheels with different wear conditions.
- The upended design of inserts enhances the insert strength and the chipbreakers are designed to provide optimum performance with efficient chipbreaking while machining the profile.
- The toolholders adopt the robust lever clamping system.

WIDIA tooling solutions for heavy-duty turning have a proven history of success in these extremely demanding applications around the world. Customers looking for maximum material removal and improved productivity can rely on WIDIA to provide the right tool, inserts, and grades for their workpiece, machine tool, and applications.

### APPLICATIONS



TURNING



FACING



PROFILING

### INDUSTRY



TRANSPORTATION

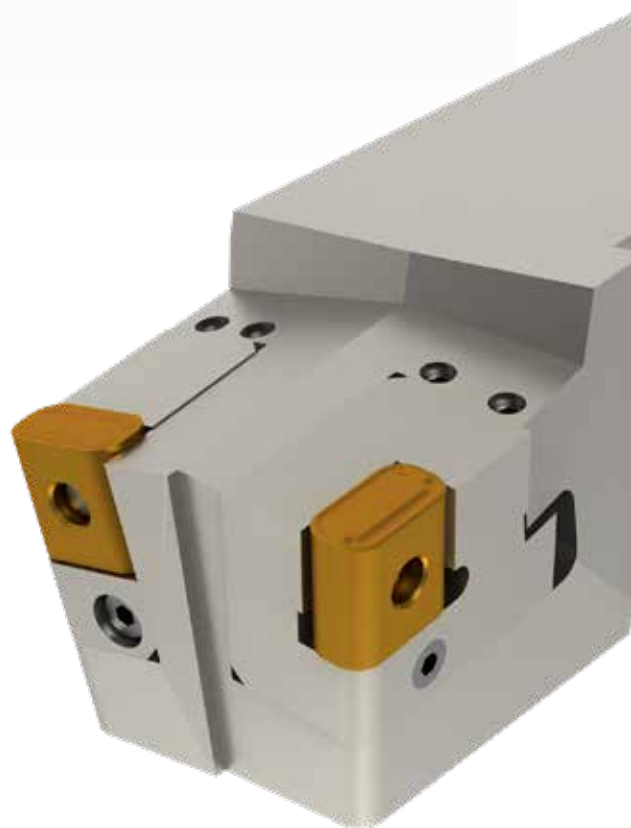

INDEXABLE MILLING

SOLID END MILLING

HOLE/MAKING

TAPPING

TURNING

## Railway Wheel Reprofilng Inserts • LNUX-16

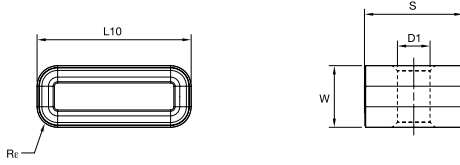

- first choice
- alternate choice

P	■	○	●
M	■	○	●
K	■	○	●
N	■	○	●
S	■	○	●
H	■	○	●

ISO catalog number	ANSI catalog number	W		L10		S		Rε		D1		WK20CT	WP15CT
		mm	in	mm	in	mm	in	mm	in	mm	in		
LNUX30194016	LNUX30194016	12,00	.472	30,00	1.181	19,05	3/4	4,0	.158	6,35	.250	I	6128295

## Railway Wheel Reprofilng Inserts • LNUX-13

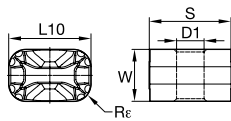
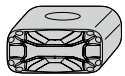

- first choice
- alternate choice

P	■	○	●
M	■	○	●
K	■	○	●
N	■	○	●
S	■	○	●
H	■	○	●

ISO catalog number	ANSI catalog number	W		L10		S		Rε		D1		WK20CT	WP15CT
		mm	in	mm	in	mm	in	mm	in	mm	in		
LNUX19194013	LNUX19194013	10,00	.394	19,05	.750	19,05	3/4	4,0	.158	6,35	.250	I	4170966
LNUX30194013	LNUX30194013	12,00	.472	30,00	1.181	19,05	3/4	4,0	.158	6,35	.250	I	4170968

## Railway Wheel Reprofilng Inserts • LNUX-T

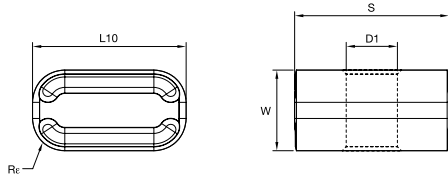

- first choice
- alternate choice

P	■	○	●
M	■	○	●
K	■	○	●
N	■	○	●
S	■	○	●
H	■	○	●

ISO catalog number	ANSI catalog number	W		L10		S		Rr		D1		WK20CT 4170967 6128294	WP15CT 4170969 6128294
		mm	in	mm	in	mm	in	mm	in	mm	in		
LNUX191940T	LNUX191940T	10,00	.394	19,05	.750	19,05	3/4	4,0	.158	6,35	.250		
LNUX301940T	LNUX301940T	12,00	.472	30,00	1.181	19,05	3/4	4,0	.158	6,35	.250		

INDEXABLE MILLING

SOLID END MILLING

HOLEMAKING

TAPPING

TURNING

INDEXABLE MILLING

SOLID END MILLING

HOLEMAKING

TAPPING

TURNING

## Railway Toolholder • Wheel Turning Lathe • Left Hand • LNUX19 Inserts

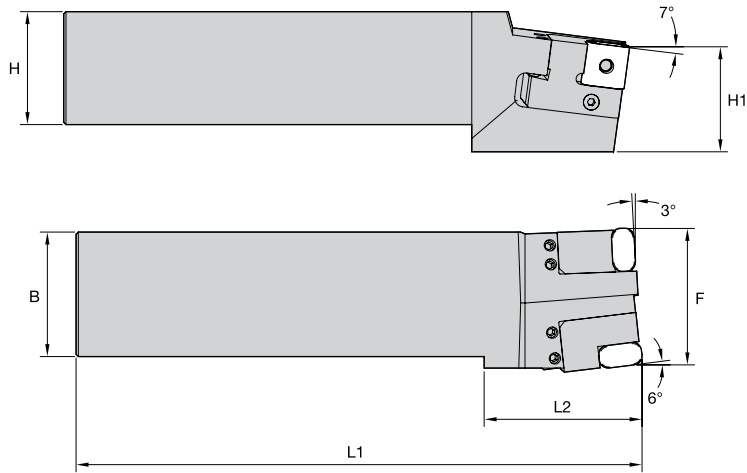

order number	catalog number	B		F		H		H1		L1		L2	
		mm	in	mm	in	mm	in	mm	in	mm	in	mm	in
left hand													
2552320	6939143120	55,00	2.161	60,00	2.362	50,00	1.969	46,00	1.339	250,00	9.843	70,00	2.756

## Railway Toolholder • Wheel Turning Lathe • Left Hand • LNUX30 Inserts

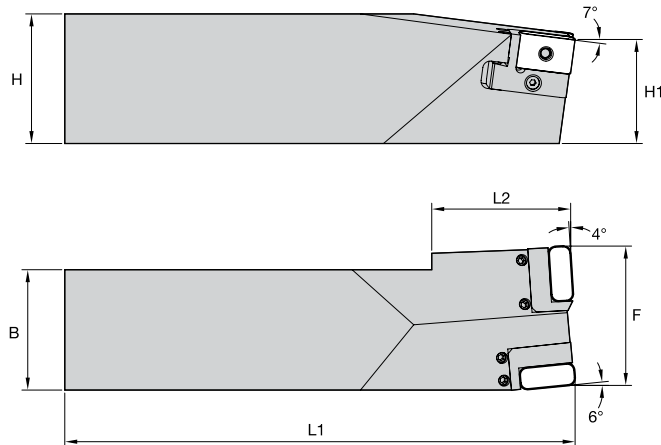

order number	catalog number	B		F		H		H1		L1		L2	
		mm	in	mm	in	mm	in	mm	in	mm	in	mm	in
left hand													
2552318	6939145820	65,00	2.559	75,00	2.953	70,00	2.756	56,00	2.205	276,00	10.866	77,78	3.062

## Railway Toolholder • Wheel Turning Lathe • Right Hand • LNUX19 Inserts

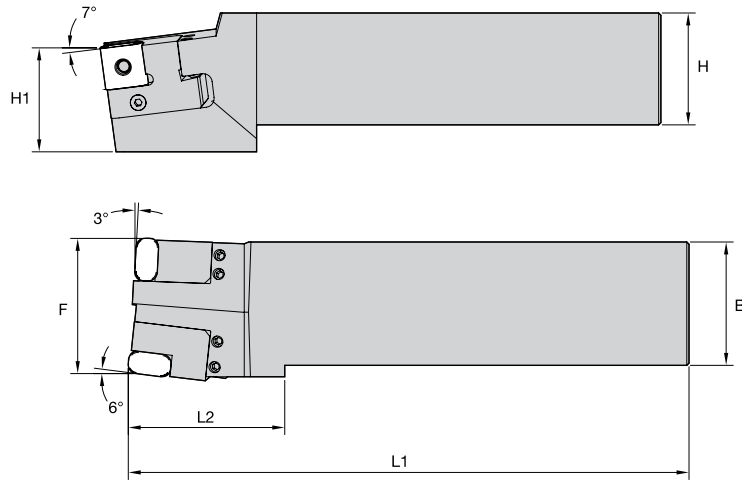

order number	catalog number	B		F		H		H1		L1		L2	
right hand		mm	in	mm	in	mm	in	mm	in	mm	in	mm	in
2552321	6939143110	55,00	2.162	60,00	2.362	50,00	1.969	46,00	1.339	250,00	9.845	70,00	2.756

## Railway Toolholder • Wheel Turning Lathe • Right Hand • LNUX30 Inserts

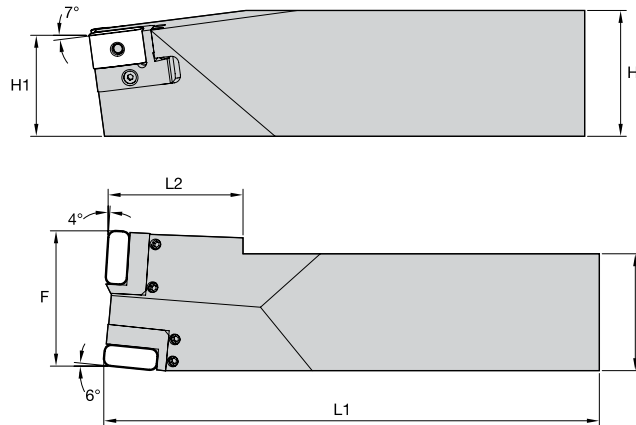

order number	catalog number	B		F		H		H1		L1		L2	
right hand		mm	in	mm	in	mm	in	mm	in	mm	in	mm	in
2552319	6939145810	65,00	2.559	75,00	2.953	70,00	2.760	56,00	2.205	276,00	10.866	77,78	3.062

INDEXABLE MILLING

SOLID END MILLING

HOLE/MAKING

TAPPING

TURNING



## Railway Turning Cassette • Wheel Turning Lathe • Left Hand • LNUX30 Inserts

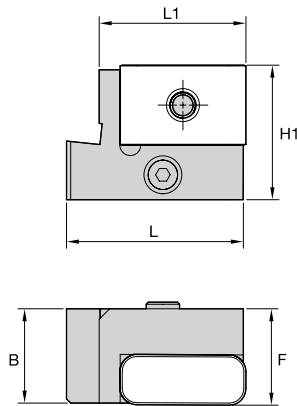

order number	catalog number	B		F		L		L1		H1		gage insert
		mm	in	mm	in	mm	in	mm	in	mm	in	
left hand												
2035331	6939318620	22,50	.886	23,00	.905	42,20	1.661	35,00	1.378	32,10	1.264	LNUX301940

## Railway Turning Cassette • Wheel Turning Lathe • Left Hand • LNUX30 Inserts

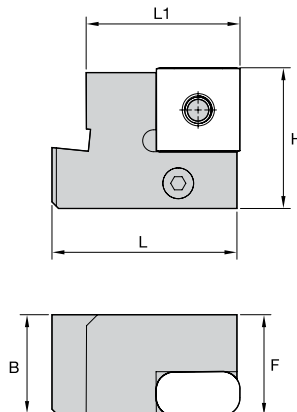

order number	catalog number	B		F		L		L1		H1		gage insert
		mm	in	mm	in	mm	in	mm	in	mm	in	
left hand												
2276948	6939318820	22,55	.888	23,00	.906	42,20	1.661	35,00	1.378	32,00	1.260	LNUX191940

## Railway Turning Cassette • Wheel Turning Lathe • Right Hand • LNUX19 Inserts

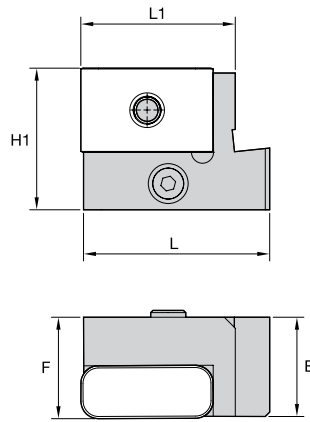

order number	catalog number	B		F		L		L1		H1		gage insert
		mm	in	mm	in	mm	in	mm	in	mm	in	
right hand 2039208	6939318610	22,50	.886	23,00	.905	42,20	1.661	35,00	1.378	32,00	1.264	LNUX301940

## Railway Turning Cassette • Wheel Turning Lathe • Right Hand • LNUX30 Inserts

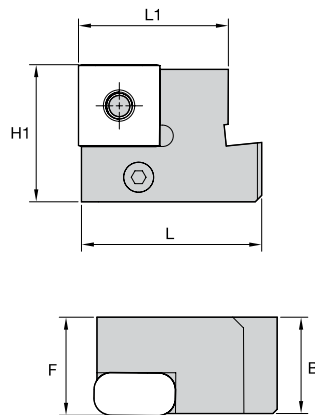

order number	catalog number	B		F		L		L1		H1		gage insert
		mm	in	mm	in	mm	in	mm	in	mm	in	
right hand 2276947	6939318710	22,55	.888	23,00	.906	42,20	1.661	35,00	1.378	32,00	1.260	LNUX191940

INDEXABLE MILLING

SOLID END MILLING

HOLE/MAKING

TAPPING

TURNING

INDEXABLE MILLING

SOLID END MILLING

HOLE/MAKING

TAPPING

TURNING

## Railway Facing Cassette • Wheel Turning Lathe • Left Hand • LNUX19 Inserts

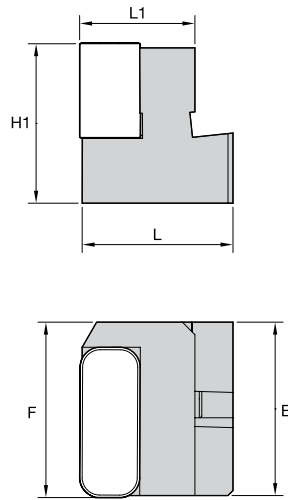
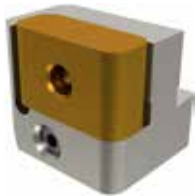

order number	catalog number	B		F		L		L1		H1		gage insert
		mm	in	mm	in	mm	in	mm	in	mm	in	
left hand 2403738	6939322020	34,60	1.362	35,00	1.378	30,10	1.185	23,00	.906	32,00	1.260	LNUX301940

## Railway Facing Cassette • Wheel Turning Lathe • Right Hand • LNUX19 Inserts

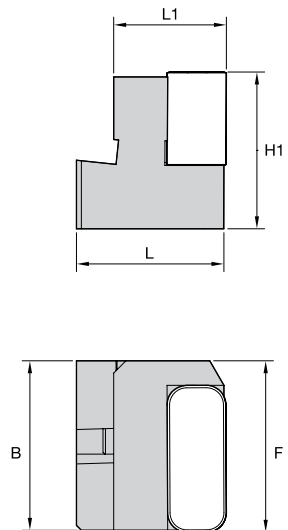

order number	catalog number	B		F		L		L1		H1		gage insert
		mm	in	mm	in	mm	in	mm	in	mm	in	
right hand 2403739	6939322110	34,60	1.362	35,00	1.378	30,10	1.185	23,00	.906	32,00	1.260	LNUX301940

## WIDIA™ Tools for Bar Peeling Applications

Bar peeling is a unique and economical machining operation for the production of cylindrical surfaces on blank bars (e.g., round bars, wires, blocks, and pipes) with high surface finishes and dimensional accuracies.

During the bar peeling process, scales, cracks, and sand inclusion are removed. Bar peeling is faster than conventional turning. It is used when high volumes, high quality, and high productivity with good surface finish are required.

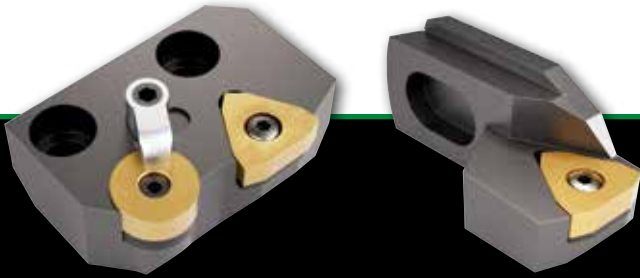

New bar peeling machines demand high performance from cutting tools. WIDIA offers a wide variety of inserts in different grades for cost-effective bar peeling operations in different types of steels, stainless steels, etc. WIDIA also offers toolholders and cartridges for bar peeling as a custom solution.

- Ideal in high feed rate applications, WIDIA bar peeling tools enable economical machining operations for the production of cylindrical surfaces on bright bars.
- High surface finishes, dimensional accuracy, and most efficient removal of scales, cracks, sand enclosures, and other errors.

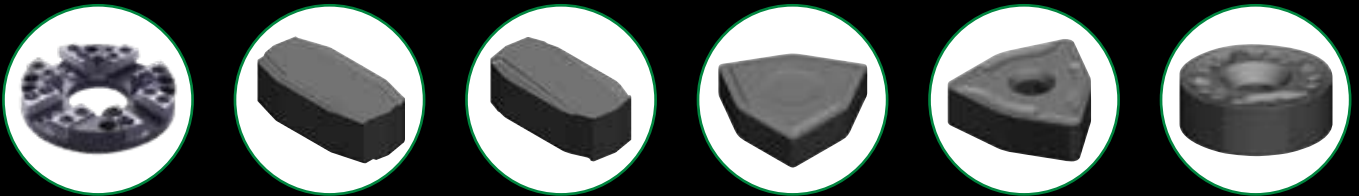

### Application Range of WIDIA Bar Peeling Tools

Bar peeling machines require a high level of utilization and demand high performance from the cutting tools. WIDIA offers specially developed tools with indexable inserts for bar peeling, which are capable of meeting these demands, making manufacturing more cost-efficient.

### WIDIA Victory™ CVD-Coated Grades

#### WP15CT

Coated carbide. MT-CVD/CVD — TiN-TiCN-Al<sub>2</sub>O<sub>3</sub>-ZrCN. Good balance of wear resistance and toughness properties. High productivity machining on smooth to lightly interrupted cuts. For steels.

#### WP25CT

Coated carbide. MT-CVD/CVD — TiN-TiCN-Al<sub>2</sub>O<sub>3</sub>-ZrCN. Good toughness properties. Excellent first choice for steel machining. Provides high-productivity metal removal for all but the harshest interrupted cuts.

#### WP35CT

Coated carbide. MT-CVD/CVD — TiN-TiCN-Al<sub>2</sub>O<sub>3</sub>-ZrCN. Proven on all roughing and heavy roughing operations, wet or dry, on interrupted and uninterrupted cuts.

#### WM25CT

Coated carbide. MT-CVD/CVD — TiN-TiCN-Al<sub>2</sub>O<sub>3</sub>-ZrCN. Good balance of wear resistance and toughness properties. Light and medium machining. For austenitic stainless steel AISI series.

*For more information on heavy-duty tooling, contact your local sales representative.*

# Small Hole Boring

## Micro Boring Bars

The WIDIA™ line of micro boring bars provides accurate holemaking tooling in diameters as small as 4,57mm. These economical, indexable inserts are available in both steel and carbide shanks and are stocked in both metric and inch sizes. Ideal for a wide range of applications, including precision micro boring.



Inserts are available in multiple styles and grades, including polycrystalline diamond tipped, for all machining applications.



## I.D. INDEXABLE INSERT TOOLING



### 80° DIAMOND INSERT BORING BARS

- Available in shanks as small as 4mm to bore >4,57mm diameter.
- Positive rake geometry for free cutting.
- Superior, unobstructed chip evacuation.
- Stocked in multiple grades to bore a wide range of materials.



### THREADING AND GROOVING BORING BARS

- Easy insert changes for threading and grooving.
- Thread down to a 48 TPI, 1,3mm TP (pitch).
- Thread and groove capabilities to an inside bore diameter of 6,91mm.



### TRIANGLE INSERT BORING BARS

- Designed for less obstruction and greater chip evacuation.
- Positive rake geometry to bore holes >6,98mm diameter.
- Stocked in all grades, including diamond-tipped and borazon-tipped styles.
- Stocked in shanks as small as 6mm for 7,06mm minimum bore diameter.

## APPLICATIONS



BORING

## INDUSTRY



## Choosing the Correct Small Hole Boring Bar

**1 Check the Hole Size to be bored (D min) in the component.**  
(To check suitability of the product platform)

**2 Determine boring bar (D).**

- A** Select shank size (D) based on your machine's requirements.
- B** Determine bore depth (how far the boring bar extends from the holder). Multiply bar diameter by 4. If bore depth is less, use a steel bar. If bore depth exceeds 4:1 ratio, use a carbide bar. Use L1 or L4 depending on bar selected. (See recommended maximum overhang chart on page E296.) For indexable tooling, go to step 3. For all other tooling systems, go directly to step 4.
- C** Determine lead angle (KRA). Zero degree lead angle is used when maximum stability is required. Lead angle may vary based on changing conditions, such as boring in a blind hole.

### Small Hole Boring Bars for Turning

NOTE: KRA shown as 0°.

order number	catalog number	KRA	D	D min	F	L1	A	IP°	JP°	GROUP
right hand										
2832148	CCB140515667R	-7	154	180	205	8.000	040	0.0°	0.0°	CD, 120905
2832281	CCB140514745R	-5	168	208	154	4.000	040	0.0°	5.0°	CD, 120905
2832276	CCB140514765R	-5	183	208	154	8.000	040	0.0°	5.0°	CD, 120905
2832193	CCB14051459R	-5	188	218	111	4.000	040	0.0°	5.0°	CD, 120905
2832194	CCB14051459R	-5	188	218	111	8.000	040	0.0°	5.0°	CD, 120905
2832048	CCB1250454R	-5	250	286	148	4.000	047	0.0°	5.0°	CD, 120905
2832129	CCB1250654R	-5	250	295	145	8.000	047	0.0°	5.0°	CD, 120905
2832270	CCB1250654R	-5	212	296	185	8.000	045	0.0°	5.0°	CD, 120905
2832195	CCB14051459R	0	167	224	117	4.000	040	0.0°	5.0°	CD, 120905
2832062	CCB1250454R	0	155	250	113	4.000	047	0.0°	5.0°	CD, 120905

**3 Determine which chipbreaker is best for the material to be machined.**

Consult the Small Hole Boring Chipbreaker Geometry charts on pages E254.

### Small Hole Boring

#### Chipbreaker Geometries • Single-Sided, Positive Inserts

- HB:** Full insert. Peripheral ground to best surface quality and reduced cutting pressure. Very stable.
- HT:** Peripheral ground insert chipbreaker. Good chip control. Geometry for general purpose.
- HB-M:** Cubic Boron Nitride (CBN) or Polycrystalline Diamond (PCD) tip for high-temp alloys and cast iron.

**4 Determine which grade is best for the material to be machined.**

Consult the Grades and Grade Descriptions charts on pages E256–E257.

### Grades and Grade Descriptions

#### Small Hole Boring Inserts

Coatings provide high-speed capability and are engineered for finishing to light roughing.

- P:** Steel
- M:** Stainless Steel
- K:** Cast Iron
- N:** Non-Ferrous
- H:** High-Temp Alloys
- B:** Hardened Materials





Coating	Grade Description	wear resistance → toughness								
		05	10	15	20	25	30	35	40	45
CMT	Uncoated carbide. A very tough, ultra-fine grain unalloyed substrate. For general-purpose machining of most steels, stainless steels, high-temperature alloys, titanium, iron, and non-ferrous materials. Performs best at low speeds and will handle interruptions and high feed rates. Use when C2, C3, or C5. Fail due to chipping or breaking.	P	M	K	N	H	B			
MW-S25										



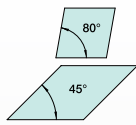
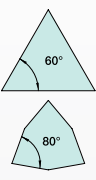
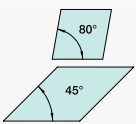
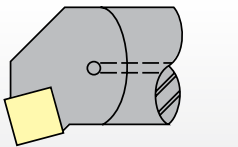
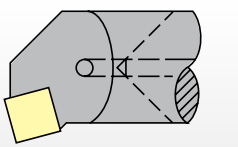

## Catalog Numbering System

Each character in our catalog number signifies a specific trait of that product. Use the following key columns and corresponding images to easily identify which attributes apply.

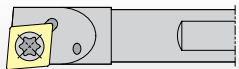
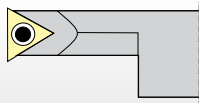
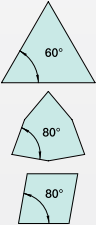
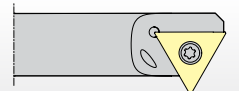
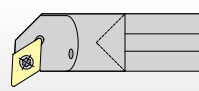
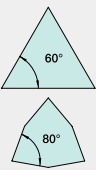
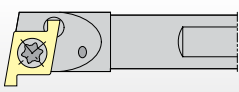
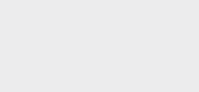
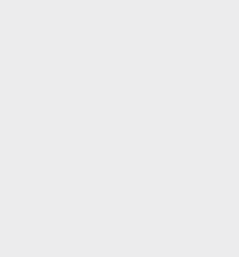
<b>C</b>	<b>S</b>	<b>B</b>	<b>I</b>	
Series Type	Bar Type	Bar Style Designation	Units	Insert Shape (optional)
<p><b>C</b></p>  <p><b>F</b></p>  <p><b>G</b></p> 	<p><b>S</b> = Steel (with coolant)</p>  <p><b>C</b> = Carbide (with coolant)</p> 		<p><b>I</b> = Inch <b>M</b> = Metric</p>	<p><b>C</b></p>  <p><b>W</b></p> 
<p><b>L</b></p> 	<p><b>B</b> Boring Bar</p> 	<p><b>O</b> Offset Boring Bar</p> 		
<p><b>Q</b></p> 	<p><b>C</b> External Chamfering Bar</p> 	<p><b>P</b> Profiling Bar</p> 		
<p><b>S</b></p> 	<p><b>I</b> Internal Threading Bar</p> 	<p><b>R</b> Reverse Chamfer or Back Chamfer Bar</p> 		
	<p><b>M</b> Offset Internal Grooving Bar</p> 			

## Catalog Numbering System

(continued)

### 180

Head Diameter shown as "D2"

#### Inch

165 = .166"  
 180 = .180"/.189"  
 203 = .203"/.207"/.210"  
 250 = .260"/.258"  
 312 = .313"/.321"/.322"/.323"  
 322 = .322"  
 375 = .375"/.385"/.390"  
 500 = .510"

#### Metric

7 = 6,60mm  
 8 = 8,18mm/8,20mm  
 10 = 9,78mm  
 13 = 12,70mm/12,95mm  
 45 = 4,57mm  
 48 = 4,80mm  
 52 = 5,16mm  
 53 = 5,30mm  
 64 = 6,60mm  
 66 = 6,55mm/6,60mm  
 82 = 8,15mm  
 95 = 9,50mm  
 99 = 9,91mm  
 159 = 15,88mm

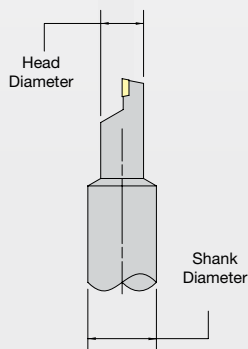

NOTE: Only shown on stepped-style bars.

### 187

Shank Diameter shown as "D"

#### Inch

156 = .156"  
 187 = .187"/.188"  
 250 = .250"  
 312 = .312"/.313"  
 375 = .375"  
 500 = .500"  
 625 = .625"  
 750 = .750"  
 875 = .875"  
 1000 = 1.000"  
 1250 = 1.250"

#### Metric

4 = 4,00mm  
 5 = 5,00mm  
 6 = 6,00mm  
 8 = 8,00mm  
 10 = 10,00mm  
 12 = 12,00mm  
 16 = 16,00mm

### 25

Length/Depth shown as "L1/L4"

Bore Length for Step Bars  
 Thread Depth for Threading Bars  
 Overall Length for Straight Shank Bars

#### Inch

1 = 1.000"  
 1125 = 1.125"  
 125 = 1.250"  
 15 = 1.500"  
 1875 = 1.875"  
 2 = 2.000"  
 25 = 2.500"  
 3125 = 3.125"  
 35 = 3.500"  
 4 = 4.000"  
 45 = 4.500"  
 5 = .500"/5.000"  
 6 = 6.000"  
 7 = 7.000"/7.085"  
 75 = .750"  
 8 = 8.000"  
 90 = .900"  
 10 = 10.000"  
 12 = 12.000"

#### Metric

12 = 12,70mm  
 19 = 19,05mm  
 22 = 22,23mm  
 25 = 25,40mm  
 32 = 31,75mm  
 38 = 38,10mm  
 48 = 47,63mm  
 51 = 50,80mm  
 63 = 63,50mm  
 64 = 64,00mm  
 76 = 76,00mm  
 79 = 79,38mm  
 100 = 100,58mm/101,50mm/101,60mm  
 102 = 101,60mm  
 127 = 127,00mm  
 152 = 152,00mm/152,40mm  
 178 = 177,80mm/179,90mm  
 203 = 203,20mm  
 254 = 254,00mm

### 7

Lead Angle\*

0 = 0°  
 Used for Threading/  
 Grooving Bars

3 = 3°  
 5 = 5°  
 7 = 7°  
 225 = 22.5°  
 30 = 30°  
 45 = 45°  
 60 = 60°

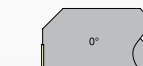

0°

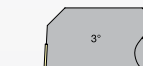

3°



22.5°

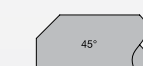

45°



7°



5°

### R

Hand of Tool

R = Right hand  
 L = Left hand

Right hand boring bar

R

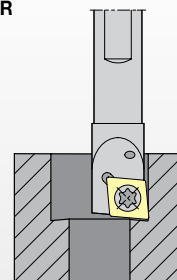

Left hand boring bar

L

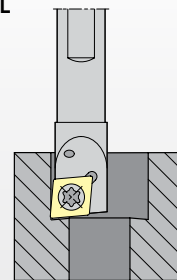

\*NOTE: Shown as "KRI" for metric bars and "KRA" for inch bars.

## Catalog Numbering System

Each character in our catalog number signifies a specific trait of that product. Use the following key columns and corresponding images to easily identify which attributes apply.

<b>C</b>	<b>D</b>	<b>H</b>	<b>B</b>	<b>12</b>																																							
Insert Shape	Insert Clearance Angle	Tolerance Class	Insert Features	Size																																							
<p>T 60° </p> <p>C 80° </p> <p>G 45° </p> <p>W 80° </p>	<p>B 5° </p> <p>C 7° </p> <p>D 15° </p> <p>P 11° </p>	<p>Tolerances apply prior to edge prep and coating.</p> <p><b>D</b> = Theoretical diameter of the insert inscribed circle  <b>S</b> = Thickness  <b>B</b> = See figures below</p>		<table border="1" style="width: 100%; border-collapse: collapse;"> <thead> <tr> <th rowspan="2">"D" inch</th> <th colspan="4">Code for inch cutting edge length "L10"</th> </tr> <tr> <th>C</th> <th>G</th> <th>T</th> <th>W</th> </tr> </thead> <tbody> <tr> <td>5/32</td> <td>12</td> <td>12</td> <td>-</td> <td>-</td> </tr> <tr> <td>.160</td> <td>-</td> <td>-</td> <td>13</td> <td>-</td> </tr> <tr> <td>3/16</td> <td>-</td> <td>15</td> <td>-</td> <td>15</td> </tr> <tr> <td>1/4</td> <td>2</td> <td>-</td> <td>2</td> <td>2</td> </tr> <tr> <td>3/8</td> <td>3</td> <td>-</td> <td>3</td> <td>3</td> </tr> <tr> <td>.386</td> <td>-</td> <td>-</td> <td>31</td> <td>-</td> </tr> </tbody> </table>	"D" inch	Code for inch cutting edge length "L10"				C	G	T	W	5/32	12	12	-	-	.160	-	-	13	-	3/16	-	15	-	15	1/4	2	-	2	2	3/8	3	-	3	3	.386	-	-	31	-
"D" inch	Code for inch cutting edge length "L10"																																										
	C	G	T	W																																							
5/32	12	12	-	-																																							
.160	-	-	13	-																																							
3/16	-	15	-	15																																							
1/4	2	-	2	2																																							
3/8	3	-	3	3																																							
.386	-	-	31	-																																							
			<p>Partly cylindrical hole, 40-60° countersink, single-sided</p> <p>W </p> <p>T </p>																																								
			<p>Partly cylindrical hole, 70-90° countersink, single-sided</p> <p>B </p> <p>H </p>																																								
<table border="1" style="width: 100%; border-collapse: collapse;"> <thead> <tr> <th>tolerance class</th> <th>tolerance on "D"</th> <th>tolerance on "B"</th> <th>tolerance on "S"</th> </tr> </thead> <tbody> <tr> <td>C</td> <td>±.0010"</td> <td>±.0005"</td> <td>±.001"</td> </tr> <tr> <td>H</td> <td>±.0005"</td> <td>±.0005"</td> <td>±.001"</td> </tr> <tr> <td>E</td> <td>±.0010"</td> <td>±.0010"</td> <td>±.001"</td> </tr> <tr> <td>G</td> <td>±.0010"</td> <td>±.0010"</td> <td>±.005"</td> </tr> <tr> <td>M</td> <td colspan="2">See tables on next page</td> <td>±.005"</td> </tr> <tr> <td>U</td> <td colspan="2">See tables on next page</td> <td>±.005"</td> </tr> </tbody> </table>	tolerance class	tolerance on "D"	tolerance on "B"	tolerance on "S"	C	±.0010"	±.0005"	±.001"	H	±.0005"	±.0005"	±.001"	E	±.0010"	±.0010"	±.001"	G	±.0010"	±.0010"	±.005"	M	See tables on next page		±.005"	U	See tables on next page		±.005"															
tolerance class	tolerance on "D"	tolerance on "B"	tolerance on "S"																																								
C	±.0010"	±.0005"	±.001"																																								
H	±.0005"	±.0005"	±.001"																																								
E	±.0010"	±.0010"	±.001"																																								
G	±.0010"	±.0010"	±.005"																																								
M	See tables on next page		±.005"																																								
U	See tables on next page		±.005"																																								

## Catalog Numbering System

(continued)

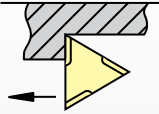
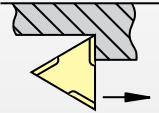
06		05				
Thickness		Corner Radius "Re"		Hand of Insert <i>(optional)</i>	Cutting Edge Condition or Chip Control Features <i>(optional)</i>	Tip Style <i>(optional)</i>
<b>symbol inch</b>	<b>thickness inch</b>	<b>symbol inch</b>	<b>corner radius inch</b>	R = Right hand L = Left hand	HP = High positive LF = Light finishing	<b>Symbol</b> M <b>Usage</b> Mini tip
06	.040	X0	.0015			
1	.0625	0	.004			
12	.0781	05	.008	<b>R</b>		
15	.0938	1	.0156			
2	.1250	13	.021			
25	.1563	2	.0313			
		24	.037			
		3	.0469			
		4	.0625			

"D" inch	± Tolerance on "D"				"D" inch	± Tolerance on "B"			
	Class M Tolerance			Class U Tolerance		Class M Tolerance			Class U Tolerance
	Shapes S, T, C, R, & W inch	Shape D inch	Shape V inch	Shapes S, T, & C inch		Shapes S, T, C, R, & W inch	Shape D inch	Shape V inch	Shapes S, T, & C inch
5/32	.002	-	-	-	5/32	.003	-	-	-
3/16	.002	-	-	.003	3/16	.003	-	-	.005
7/32	.002	.002	.002	.003	7/32	.003	.004	-	.005
1/4	.002	.002	.002	.003	1/4	.003	.004	-	.005
5/16	.002	.002	.002	.003	5/16	.003	.004	-	.005
3/8	.002	.002	.002	.003	3/8	.003	.004	.007	.005
7/16	.003	.003	.003	.005	7/16	.005	.006	-	-
1/2	.003	.003	.003	.005	1/2	.005	.006	.010	.008
9/16	.003	.003	.003	.005	9/16	.005	.006	-	-
5/8	.004	.004	.004	.007	5/8	.006	.007	-	.011
11/16	.004	.004	.004	.007	11/16	.006	.007	-	.011
3/4	.004	.004	.004	.007	3/4	.006	.007	-	.011
7/8	.005	-	-	.010	7/8	.006	-	-	.015
1	.005	-	-	.010	1	.007	-	-	.015
1 1/4	.006	-	-	.010	1 1/4	.008	-	-	.015

# Small Hole Boring • Insert Selection Guide

INDEXABLE MILLING

The WIDIA™ three-step insert selection system makes choosing and applying the most productive tool easy. Tool recommendations are based on six workpiece material groups.

- 1 Select the Insert Geometry:**  
Based on the needed depth of cut and feed rate, choose the geometry that best matches your needs.
- 2 Select the Grade:**  
Determine your cutting conditions, and choose the proper grade.

SOLID END MILLING

HOLEMAKING

TAPPING

TURNING

## TN7–CM1 for Steel

ISO 513	P				
	01	10	20	30	40
Hard Metal Coated	TN7				
	ALO				
	CG6				
	CG55				
			CG5		
			CM1		

wear resistance = harder

- TN7** — High edge strength and wear-resistant cermet. Finishing to semi-finishing of carbon, alloy, and stainless steels at medium to high speeds.
- ALO** — Can withstand light interruptions. Alumina coating enables higher cutting speeds.
- CG6** — High-speed, general-purpose grade for all kinds of steel and cast iron.
- CG55** — High edge strength and wear resistance. Reduces problems with built-up edge. Superior thermal deformation resistance and depth-of-cut notch resistance.
- CG5** — Best at low speeds. Will handle interruptions and high feed rates.
- CM1** — For heavy turning and heavily interrupted cuts.

toughness = softer

## ALO–CM1 for Stainless Steel

ISO 513	M				
	01	10	20	30	40
Hard Metal Coated	ALO				
	C3 and C25				
	C2				
	CG6				
	CG55				
			CG5		
			CM1		

wear resistance = harder

- ALO** — Can withstand light interruptions. Alumina coating enables higher cutting speeds.
- C3 and C25** — Good wear resistance with some toughness.
- C2** — Excellent abrasion resistance for machining cast irons, austenitic stainless steels, non-ferrous metals, non-metals, and most high-temperature alloys.
- CG6** — High-speed, general-purpose grade for all kinds of steel and cast iron.
- CG55** — High edge strength and wear-resistance. Reduces problems with built-up edge. Superior thermal deformation resistance and depth-of-cut notch resistance.
- CG5** — Best at low speeds. Will handle interruptions and high feed rates.
- CM1** — For heavy turning and heavily interrupted cuts.

toughness = softer

### 3 Select the Cutting Speed:

In the foldout speed and feed chart, establish your cutting speed and obtain your optimal starting conditions and range.

<b>P</b>	Steel
<b>M</b>	Stainless Steel
<b>K</b>	Cast Iron
<b>N</b>	Non-Ferrous
<b>S</b>	High-Temp Alloys
<b>H</b>	Hardened Materials

## TN7–CM1 for Cast Iron

ISO 513	K									
	01	10	20	30	40					
Hard Metal Coated	<p style="writing-mode: vertical-rl; transform: rotate(180deg);">wear resistance = harder</p> <p style="writing-mode: vertical-rl; transform: rotate(180deg);">toughness = softer</p>									
						TN7				
						ALO				
						CG6				
						CG55				
						C3 and C25				
						C2				
						CG5				
						CM1				
						<p><b>TN7</b> — High edge strength and wear-resistant cermet.</p> <p><b>ALO</b> — Can withstand light interruptions. Alumina coating enables higher cutting speeds.</p> <p><b>CG6</b> — High-speed, general-purpose grade for all kinds of steel and cast iron.</p> <p><b>CG55</b> — High edge strength and wear resistance. Reduces problems with built-up edge. Superior thermal deformation resistance and depth-of-cut notch resistance.</p> <p><b>C3 and C25</b> — Good wear resistance with some toughness.</p> <p><b>C2</b> — Excellent abrasion resistance for machining cast irons, austenitic stainless steels, non-ferrous metals, non-metals, and most high-temperature alloys.</p> <p><b>CG5</b> — Best at low speeds. Will handle interruptions and high feed rates.</p> <p><b>CM1</b> — For heavy turning and heavily interrupted cuts.</p>				

## C3–CM1 for High-Temperature Alloys

ISO 513	S									
	01	10	20	30	40					
Hard Metal Coated	<p style="writing-mode: vertical-rl; transform: rotate(180deg);">wear resistance = harder</p> <p style="writing-mode: vertical-rl; transform: rotate(180deg);">toughness = softer</p>									
						C3 and C25				
						C2				
						CG5				
						CM1				
<p><b>C3 and C25</b> — Good wear resistance with some toughness.</p> <p><b>C2</b> — Excellent abrasion resistance for machining cast irons, austenitic stainless steels, non-ferrous metals, non-metals, and most high-temperature alloys.</p> <p><b>CG5</b> — Best at low speeds. Will handle interruptions and high feed rates.</p> <p><b>CM1</b> — For heavy turning and heavily interrupted cuts.</p>										

## Chipbreaker Geometries • Single-Sided, Positive Inserts

INDEXABLE MILLING

SOLID END MILLING

HOLEMAKING

TAPPING

TURNING

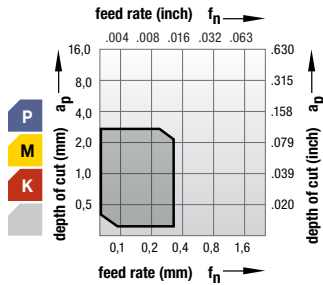

**..HB**

Flat inserts. Peripheral ground for best surface quality and reduced cutting pressure. Very stable cutting edge offers maximum rigidity.

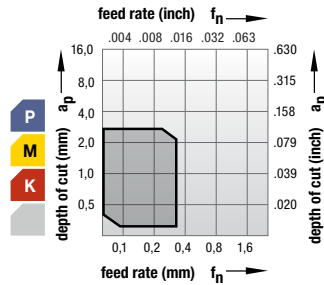

**..HT**

Peripheral ground insert chipbreaker. Good chip control. Geometry for general-purpose applications.

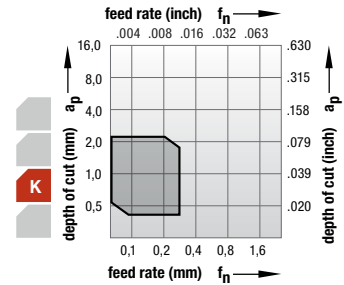

**..HB-M**

Cubic Boron Nitride (CBN) or Polycrystalline Diamond (PCD) tip for high-temp alloys and non-ferrous machining. Very stable cutting edge offers maximum rigidity.

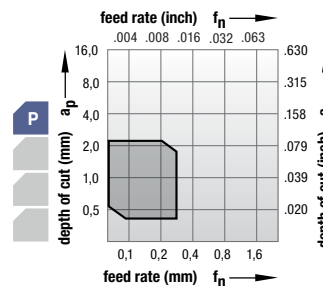

**..LF**

Geometry for general-purpose applications. Very good chip control. Recommended for general finish machining.

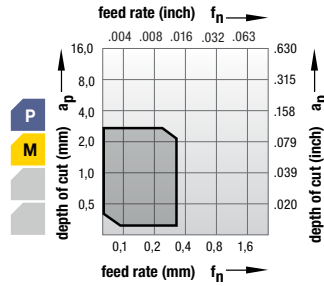

**..HH**

Peripheral ground for best surface quality and reduced cutting pressure. For fine to medium finishes.

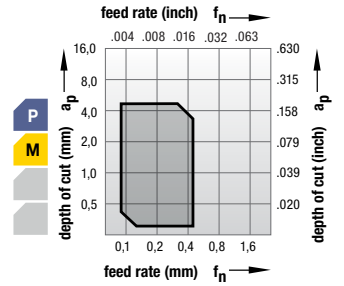

**HP**

High positive-type chipbreaker. Peripheral ground for best surface quality and reduced cutting pressure. Recommended for high-temp alloys and non-ferrous machining.

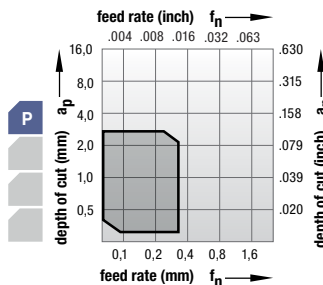

**..HH-R/L**

Ground-in chipbreaker. Peripheral ground for best surface quality and reduced cutting pressure. \*Right-hand inserts used in left-hand bars ONLY. Left-hand inserts used in right-hand bars ONLY.

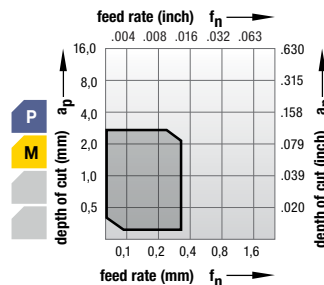

**..HW**

Flat insert for profiling. Very stable cutting edge offers maximum rigidity.

## Chipbreaker Geometries • Geometry Selection Criteria

### Flat Top-Type Inserts

Chipbreaker Geometry ..HB, ..HB-M, ..HW

- Suitable for interrupted cuts.
- Use when chip control is not critical.

### Pressed Chipbreaker-Type Inserts

Chipbreaker Geometry ..LF

- Suitable for moderate interruption of cuts.
- Use when chip control is a concern.

### Pressed Chipbreaker-Type Inserts with Ground Periphery

Chipbreaker Geometry ..HH, ..HT, HP

- Suitable for light to moderate interruption of cuts.
- Use when chip control is a concern.
- Superior surface finish and closer tolerance on workpiece.

### Ground-In Chipbreaker-Type Inserts

Chipbreaker Geometry ..HH-R/L

- Suitable for smooth cuts.
- Use when chip control is a concern.
- Superior surface finish and closer tolerance on workpiece.

INDEXABLE MILLING

SOLID END MILLING

HOLEMAKING

TAPPING

TURNING



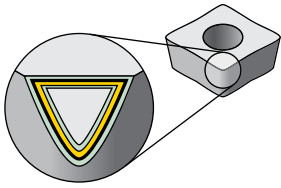

## Small Hole Boring Inserts



Coatings provide high-speed capability and are engineered for finishing to light roughing.

P	Steel
M	Stainless Steel
K	Cast Iron
N	Non-Ferrous
S	High-Temp Alloys
H	Hardened Materials

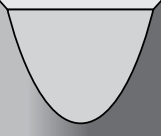
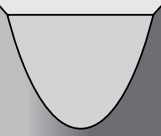
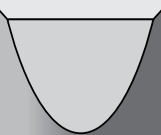
wear resistance ← → toughness

Coating		Grade Description		05	10	15	20	25	30	35	40	45		
Grade CM1	 HW-S25	Uncoated carbide. A very tough, ultra-fine grain unalloyed substrate. For general-purpose machining of most steels, stainless steels, high-temperature alloys, titanium, irons, and non-ferrous materials. Performs best at low speeds and will handle interruptions and high feed rates. Use when C2, C3, or C25 fail due to chipping or breaking.	P											
			M											
			K											
			N											
			S											
Grade C2	 HW-N15	Uncoated carbide. A hard, low binder content, unalloyed WC/Co fine-grained grade. General-purpose grade for non-ferrous materials. Has excellent abrasion resistance for machining cast irons, austenitic stainless steels, non-ferrous metals, non-metals, and most high-temperature alloys.	M											
			K											
			N											
			S											
Grade C3 and C25	 HW-K15	Uncoated carbide. Has excellent abrasion resistance for machining cast irons, aluminum, and non-ferrous metals. Good wear resistance with some toughness. Harder than C2, resulting in greater edge wear resistance. Suitable for finishing operations.	M											
			K											
			N											
			S											
Grade TN7	 HT-P15	A highly wear-resistant (TiC/TiN-based) cermet grade. High edge strength and wear-resistant cermet offers improved tool life over uncoated/coated carbides and resists material build-up on cutting edge. Finishing to semi-finishing of carbon, alloy, and stainless steels at medium to high speeds. Can also be used on non-ferrous materials.	P											
			M											
			K											
Grade ALO	 HC-K15	Coated carbide. CVD — TiCN-TiC-Al <sub>2</sub> O <sub>3</sub> . A thin alumina coating over a hard, deformation-resistant substrate. High-speed finishing of gray cast irons and medium-speed finishing of alloy steels that are in a hardness range of 35–50 HRC. Can withstand light interruptions. Alumina coating enables higher cutting speeds.	P											
			M											
			K											

## Small Hole Boring Inserts

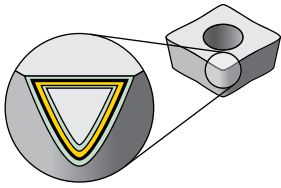

Coatings provide high-speed capability and are engineered for finishing to light roughing.

<b>P</b>	Steel
<b>M</b>	Stainless Steel
<b>K</b>	Cast Iron
<b>N</b>	Non-Ferrous
<b>S</b>	High-Temp Alloys
<b>H</b>	Hardened Materials

Grade	Coating	Grade Description	wear resistance ← → toughness																			
			05	10	15	20	25	30	35	40	45											
CG6	 HC-P10	Coated carbide. CVD — TiC-TiCN-TiN. Tri-phase coating on a hard, low binder content, fine-grained grade. High-speed, general-purpose grade for all kinds of steel. Gold in color.	P																			
			M																			
CG5	 HC-S25	A PVD-TiN-coated grade. Straight 9.5% Co substrate. Submicron grain. For general-purpose machining of most steels, stainless steels, high-temperature alloys, titanium, irons, and non-ferrous materials. Performs best at low speeds and will handle interruptions and high feed rates.	P																			
			M																			
CG55	 HC-M20	A PVD-TiN coating over a very wear-resistant, unalloyed carbide substrate. For general-purpose machining of most steels, stainless steels, high-temperature alloys, titanium, irons, and non-ferrous materials. Grade provides combination of high edge strength and wear resistance. Coating increases wear resistance and reduces problems with built-up edge. The substrate offers superior thermal deformation resistance and depth-of-cut notch resistance.	P																			
			M																			
CBN6	 BN-H25	PcBN tip brazed onto a carbide insert. Recommended for machining hardened steel (45–65 HRC). Use on bearing steel, hot and cold work tool steels, high-speed steels, die steels, case-hardened steels, carburized and nitrided irons, and some hard coatings. Can be run both dry and wet.	P																			
			M																			
CPD1	 DP-N10	Polycrystalline diamond (PCD) compact grade provides exceptional hardness and abrasion resistance. CPD1 is a superior finish boring grade that will significantly improve workpiece tolerances, surface finishes, and insert tool life in high-silicon aluminum, copper, aluminum carbon graphite, hard rubber, plastics, and/or wood.	P																			
			M																			

INDEXABLE MILLING

SOLID END MILLING

HOLEMAKING

TAPPING

TURNING

# Speed and Feed Chart

## Positive Inserts • Inch

Material Group		Cutting Speed – vc SFM																	
		C2			C25			C3			CG5			CG55			CG6		
		min	Start	max	min	Start	max	min	Start	max	min	Start	max	min	Start	max	min	Start	max
P	ap [inch]	-	-	-	-	-	-	-	-	-	.002	-	.012	.002	-	.012	.002	-	.012
	f [inch]	-	-	-	-	-	-	-	-	-	.012	-	.001	.012	-	.001	.012	-	.001
	0/1	-	-	-	-	-	-	0/1	-	-	305	<b>380</b>	460	340	<b>420</b>	505	415	<b>515</b>	620
	2	-	-	-	-	-	-	-	-	-	200	<b>250</b>	300	220	<b>275</b>	330	270	<b>335</b>	405
	3	-	-	-	-	-	-	-	-	-	200	<b>250</b>	300	220	<b>275</b>	330	270	<b>335</b>	405
	4	-	-	-	-	-	-	-	-	-	155	<b>195</b>	235	170	<b>215</b>	260	210	<b>260</b>	315
	5	-	-	-	-	-	-	-	-	-	200	<b>250</b>	300	220	<b>275</b>	330	270	<b>335</b>	405
6	-	-	-	-	-	-	-	-	-	135	<b>165</b>	200	150	<b>185</b>	225	180	<b>220</b>	265	
M	ap [inch]	.002	-	.012	.002	-	.012	.002	-	.012	.002	-	.012	.002	-	.012	.002	-	.012
	f [inch]	.001	-	.012	.001	-	.012	.001	-	.012	.001	-	.012	.001	-	.012	.001	-	.012
	1	180	<b>225</b>	270	205	<b>255</b>	310	205	<b>255</b>	310	240	<b>300</b>	360	265	<b>330</b>	400	305	<b>380</b>	460
	2	165	<b>205</b>	250	185	<b>230</b>	280	185	<b>230</b>	280	220	<b>270</b>	325	240	<b>300</b>	360	280	<b>345</b>	415
3	120	<b>150</b>	185	140	<b>170</b>	210	140	<b>170</b>	210	160	<b>200</b>	245	180	<b>220</b>	270	205	<b>255</b>	310	
K	ap [inch]	.002	-	.012	.002	-	.012	.002	-	.012	.002	-	.012	.002	-	.012	.002	-	.012
	f [inch]	.001	-	.012	.001	-	.012	.001	-	.012	.001	-	.012	.001	-	.012	.001	-	.012
	1	170	<b>213</b>	255	190	<b>235</b>	285	190	<b>235</b>	285	195	<b>240</b>	295	220	<b>270</b>	325	240	<b>300</b>	360
	2	220	<b>270</b>	330	240	<b>300</b>	360	240	<b>300</b>	360	250	<b>310</b>	375	275	<b>345</b>	415	305	<b>380</b>	460
3	160	<b>200</b>	240	180	<b>220</b>	265	180	<b>220</b>	265	180	<b>225</b>	270	200	<b>250</b>	300	220	<b>275</b>	330	
N	ap [inch]	.002	-	.020	.002	-	.020	.002	-	.020	.002	-	.020	.002	-	.020	.002	-	.020
	f [inch]	.001	-	.012	.001	-	.012	.001	-	.012	.001	-	.012	.001	-	.012	.001	-	.012
	1	1320	<b>1650</b>	1980	1320	<b>1650</b>	1980	1320	<b>1650</b>	1980	1320	<b>1650</b>	1980	1455	<b>1815</b>	2180	-	-	-
	2	970	<b>1210</b>	1450	970	<b>1215</b>	1460	970	<b>1215</b>	1460	970	<b>1215</b>	1460	1070	<b>1335</b>	1600	-	-	-
	3	225	<b>280</b>	340	225	<b>280</b>	340	225	<b>280</b>	340	275	<b>340</b>	410	300	<b>375</b>	450	-	-	-
	4	1015	<b>1250</b>	1520	1010	<b>1270</b>	1520	1010	<b>1270</b>	1520	455	<b>570</b>	690	505	<b>630</b>	760	-	-	-
	5	480	<b>600</b>	720	480	<b>600</b>	720	480	<b>600</b>	720	580	<b>720</b>	865	640	<b>795</b>	955	-	-	-
	6	460	<b>575</b>	690	460	<b>575</b>	690	460	<b>575</b>	690	555	<b>690</b>	830	610	<b>765</b>	920	-	-	-
7	780	<b>975</b>	1170	780	<b>980</b>	1175	780	<b>980</b>	1175	800	<b>1000</b>	1200	875	<b>1100</b>	1320	-	-	-	
S	ap [inch]	.001	-	.008	.001	-	.008	.001	-	.008	.001	-	.008	.001	-	.008	.001	-	.008
	f [inch]	.001	-	.005	.001	-	.005	.001	-	.005	.001	-	.005	.001	-	.005	.001	-	.005
	1	95	<b>120</b>	145	95	<b>120</b>	145	95	<b>120</b>	145	95	<b>120</b>	145	108	<b>133</b>	163	-	-	-
	2	75	<b>95</b>	115	75	<b>95</b>	120	75	<b>95</b>	120	75	<b>95</b>	120	87	<b>107</b>	130	-	-	-
	3	75	<b>95</b>	115	75	<b>95</b>	120	75	<b>95</b>	120	105	<b>130</b>	160	120	<b>145</b>	175	-	-	-
4	80	<b>100</b>	120	80	<b>100</b>	120	80	<b>100</b>	120	-	-	-	-	-	-	-	-	-	
H	ap [inch]	-	-	-	-	-	-	-	-	-	-	-	-	-	-	-	-	-	-
	f [inch]	-	-	-	-	-	-	-	-	-	-	-	-	-	-	-	-	-	-
	1	-	-	-	-	-	-	-	-	-	-	-	-	-	-	-	-	-	-
	2	-	-	-	-	-	-	-	-	-	-	-	-	-	-	-	-	-	-
	3	-	-	-	-	-	-	-	-	-	-	-	-	-	-	-	-	-	-
4	-	-	-	-	-	-	-	-	-	-	-	-	-	-	-	-	-	-	

NOTE: Speed and feed rates and depth of cut may vary depending on materials and machining conditions including, but not limited to, tool overhang, tool size, and finished surface requirements.

INDEXABLE MILLING

SOLID END MILLING

HOLEMAKING

TAPPING

TURNING

## Positive Inserts • Inch

Material Group		Cutting Speed – vc SFM														
		CM1			ALO			TN7			CBN6			CPD1		
		min	Start	max	min	Start	max	min	Start	max	min	Start	max	min	Start	max
P	ap [inch]	.002	–	.012	.002	–	.012	.002	–	.012	–	–	–	–	–	–
	f [inch]	.012	–	.001	.012	–	.001	.012	–	.001	–	–	–	–	–	–
	0/1	180	<b>220</b>	265	540	<b>675</b>	810	650	<b>810</b>	975	–	–	–	–	–	–
	2	115	<b>140</b>	175	350	<b>440</b>	530	420	<b>525</b>	630	–	–	–	–	–	–
	3	115	<b>140</b>	175	350	<b>440</b>	530	420	<b>525</b>	630	–	–	–	–	–	–
	4	90	<b>110</b>	135	275	<b>340</b>	410	330	<b>410</b>	495	–	–	–	–	–	–
	5	115	<b>140</b>	175	350	<b>440</b>	525	420	<b>520</b>	628	–	–	–	–	–	–
6	80	<b>95</b>	115	235	<b>290</b>	350	280	<b>350</b>	420	–	–	–	–	–	–	
M	ap [inch]	.002	–	.012	.002	–	.012	.002	–	.012	–	–	–	–	–	–
	f [inch]	.001	–	.012	.001	–	.012	.001	–	.012	–	–	–	–	–	–
	1	180	<b>220</b>	265	345	<b>430</b>	520	340	<b>420</b>	505	–	–	–	–	–	–
	2	160	<b>200</b>	240	315	<b>390</b>	470	305	<b>380</b>	460	–	–	–	–	–	–
3	120	<b>150</b>	180	235	<b>295</b>	355	225	<b>280</b>	340	–	–	–	–	–	–	
K	ap [inch]	.002	–	.012	.002	–	.012	.002	–	.012	–	–	–	–	–	–
	f [inch]	.001	–	.012	.001	–	.012	.001	–	.012	–	–	–	–	–	–
	1	150	<b>190</b>	230	410	<b>510</b>	615	270	<b>340</b>	410	–	–	–	–	–	–
	2	190	<b>240</b>	290	520	<b>650</b>	780	345	<b>430</b>	520	–	–	–	–	–	–
3	140	<b>175</b>	210	380	<b>470</b>	565	255	<b>315</b>	380	–	–	–	–	–	–	
N	ap [inch]	.002	–	.020	–	–	–	.002	–	.020	–	–	–	.002	–	.020
	f [inch]	.001	–	.012	–	–	–	.001	–	.012	–	–	–	.001	–	.012
	1	1320	<b>1650</b>	1980	–	–	–	1320	<b>1650</b>	1980	–	–	–	2800	<b>3500</b>	4200
	2	970	<b>1215</b>	1460	–	–	–	970	<b>1210</b>	1455	–	–	–	2130	<b>2665</b>	3200
	3	225	<b>280</b>	340	–	–	–	265	<b>330</b>	400	–	–	–	1200	<b>1500</b>	1800
	4	330	<b>410</b>	490	–	–	–	635	<b>790</b>	955	–	–	–	1065	<b>1330</b>	1600
	5	480	<b>600</b>	720	–	–	–	640	<b>800</b>	960	–	–	–	1120	<b>1400</b>	1680
	6	460	<b>575</b>	690	–	–	–	580	<b>725</b>	870	–	–	–	1100	<b>1375</b>	1650
7	780	<b>975</b>	1175	–	–	–	795	<b>990</b>	1195	–	–	–	1730	<b>2170</b>	2600	
S	ap [inch]	.001	–	.008	–	–	–	–	–	–	.001	–	.008	–	–	–
	f [inch]	.001	–	.005	–	–	–	–	–	–	.001	–	.005	–	–	–
	1	85	<b>105</b>	130	–	–	–	–	–	–	290	<b>360</b>	435	–	–	–
	2	65	<b>80</b>	100	–	–	–	–	–	–	230	<b>280</b>	340	–	–	–
	3	90	<b>110</b>	135	–	–	–	–	–	–	320	<b>400</b>	480	–	–	–
4	75	<b>90</b>	110	–	–	–	–	–	–	–	–	–	–	–	–	
H	ap [inch]	–	–	–	–	–	–	–	–	–	.001	–	.008	–	–	–
	f [inch]	–	–	–	–	–	–	–	–	–	.001	–	.005	–	–	–
	1	–	–	–	–	–	–	–	–	–	360	<b>450</b>	540	–	–	–
	2	–	–	–	–	–	–	–	–	–	340	<b>420</b>	505	–	–	–
	3	–	–	–	–	–	–	–	–	–	320	<b>400</b>	480	–	–	–
4	–	–	–	–	–	–	–	–	–	290	<b>360</b>	435	–	–	–	

NOTE: Speed and feed rates and depth of cut may vary depending on materials and machining conditions including, but not limited to, tool overhang, tool size, and finished surface requirements.

INDEXABLE MILLING

SOLID END MILLING

HOLEMAKING

TAPPING

TURNING

INDEXABLE MILLING

SOLID END MILLING

HOLEMAKING

TAPPING

TURNING

## Positive Inserts • Metric

Material Group		Cutting Speed – vc m/min																	
		C2			C25			C3			CG5			CG55			CG6		
		min	Start	max	min	Start	max	min	Start	max	min	Start	max	min	Start	max	min	Start	max
P	ap [mm]	-	-	-	-	-	-	-	-	-	0,051	-	0,300	0,051	-	0,300	0,051	-	0,300
	f [mm/rev]	-	-	-	-	-	-	-	-	-	0,025	-	0,300	0,025	-	0,300	0,025	-	0,300
	0/1	-	-	-	-	-	-	-	-	-	95	115	140	105	130	155	125	155	190
	2	-	-	-	-	-	-	-	-	-	60	75	90	65	85	100	80	100	125
	3	-	-	-	-	-	-	-	-	-	60	75	90	65	85	100	80	100	125
	4	-	-	-	-	-	-	-	-	-	45	60	70	50	65	80	65	80	95
	5	-	-	-	-	-	-	-	-	-	60	75	90	65	85	100	80	100	125
6	-	-	-	-	-	-	-	-	-	40	50	60	45	55	70	55	65	80	
M	ap [mm]	0,051	-	0,300	0,051	-	0,300	0,051	-	0,300	0,051	-	0,300	0,051	-	0,300	0,051	-	0,300
	f [mm/rev]	0,025	-	0,300	0,025	-	0,300	0,025	-	0,300	0,025	-	0,300	0,025	-	0,300	0,025	-	0,300
	1	55	70	80	60	80	95	60	80	95	75	90	110	80	100	120	95	115	140
	2	50	60	75	55	70	85	55	70	85	65	80	100	75	90	110	85	105	125
3	35	45	55	45	50	65	45	50	65	50	60	75	55	65	80	60	80	95	
K	ap [mm]	0,051	-	0,300	0,051	-	0,300	0,051	-	0,300	0,051	-	0,300	0,051	-	0,300	0,051	-	0,300
	f [mm/rev]	0,025	-	0,300	0,025	-	0,300	0,025	-	0,300	0,025	-	0,300	0,025	-	0,300	0,025	-	0,300
	1	50	65	80	60	70	85	60	70	85	60	75	90	65	80	100	75	90	110
	2	65	80	100	75	90	110	75	90	110	75	95	115	85	105	125	95	115	140
3	50	60	75	55	65	80	55	65	80	55	70	80	60	75	90	65	85	100	
N	ap [mm]	0,051	-	0,300	0,051	-	0,300	0,051	-	0,300	0,051	-	0,300	0,051	-	0,300	-	-	-
	f [mm/rev]	0,025	-	0,300	0,025	-	0,300	0,025	-	0,300	0,025	-	0,300	0,025	-	0,300	-	-	-
	1	400	505	605	400	505	605	400	505	605	400	505	605	445	555	665	-	-	-
	2	295	370	440	295	370	445	295	370	445	295	370	445	325	405	490	-	-	-
	3	70	85	105	70	85	105	70	85	105	85	105	125	90	115	135	-	-	-
	4	310	380	465	310	385	465	310	385	465	140	175	210	155	190	230	-	-	-
	5	145	185	220	145	185	220	145	185	220	175	220	265	195	240	290	-	-	-
	6	140	175	210	140	175	210	140	175	210	170	210	255	185	235	280	-	-	-
7	240	295	355	240	300	360	240	300	360	245	305	365	265	335	400	-	-	-	
S	ap [mm]	0,025	-	0,200	0,025	-	0,200	0,025	-	0,200	0,025	-	0,200	0,025	-	0,200	-	-	-
	f [mm/rev]	0,025	-	0,127	0,025	-	0,127	0,025	-	0,127	0,025	-	0,127	0,025	-	0,127	-	-	-
	1	30	35	45	30	35	45	30	35	45	30	35	45	35	40	50	-	-	-
	2	25	30	35	25	30	35	25	30	35	25	30	35	25	35	40	-	-	-
	3	25	30	35	25	30	35	25	30	35	30	40	50	35	45	55	-	-	-
4	25	30	35	25	30	35	25	30	35	-	-	-	-	-	-	-	-	-	
H	ap [mm]	-	-	-	-	-	-	-	-	-	-	-	-	-	-	-	-	-	-
	f [mm/rev]	-	-	-	-	-	-	-	-	-	-	-	-	-	-	-	-	-	-
	1	-	-	-	-	-	-	-	-	-	-	-	-	-	-	-	-	-	-
	2	-	-	-	-	-	-	-	-	-	-	-	-	-	-	-	-	-	-
	3	-	-	-	-	-	-	-	-	-	-	-	-	-	-	-	-	-	-
4	-	-	-	-	-	-	-	-	-	-	-	-	-	-	-	-	-	-	

NOTE: Speed and feed rates and depth of cut may vary depending on materials and machining conditions including, but not limited to, tool overhang, tool size, and finished surface requirements.

## Positive Inserts • Metric

Material Group		Cutting Speed – vc m/min														
		CM1			ALO			TN7			CBN6			CPD1		
		min	Start	max	min	Start	max	min	Start	max	min	Start	max	min	Start	max
P	ap [mm]	0,051	–	0,300	0,051	–	0,300	0,051	–	0,300	–	–	–	–	–	–
	f [mm/rev]	0,025	–	0,300	0,025	–	0,300	0,025	–	0,300	–	–	–	–	–	–
	0/1	55	<b>65</b>	80	165	<b>205</b>	245	200	<b>245</b>	295	–	–	–	–	–	–
	2	35	<b>45</b>	55	105	<b>135</b>	160	130	<b>160</b>	190	–	–	–	–	–	–
	3	35	<b>45</b>	55	105	<b>135</b>	160	130	<b>160</b>	190	–	–	–	–	–	–
	4	25	<b>35</b>	40	85	<b>105</b>	125	100	<b>125</b>	150	–	–	–	–	–	–
	5	35	<b>45</b>	55	105	<b>135</b>	160	130	<b>160</b>	190	–	–	–	–	–	–
6	25	<b>30</b>	35	70	<b>90</b>	105	85	<b>105</b>	130	–	–	–	–	–	–	
M	ap [mm]	0,051	–	0,300	0,051	–	0,300	0,051	–	0,300	–	–	–	–	–	–
	f [mm/rev]	0,025	–	0,300	0,025	–	0,300	0,025	–	0,300	–	–	–	–	–	–
	1	55	<b>65</b>	80	105	<b>130</b>	160	105	<b>130</b>	155	–	–	–	–	–	–
	2	50	<b>60</b>	75	95	<b>120</b>	145	95	<b>115</b>	140	–	–	–	–	–	–
K	ap [mm]	0,051	–	0,300	0,051	–	0,300	0,051	–	0,300	–	–	–	–	–	–
	f [mm/rev]	0,025	–	0,300	0,025	–	0,300	0,025	–	0,300	–	–	–	–	–	–
	1	45	<b>60</b>	70	125	<b>155</b>	185	80	<b>105</b>	125	–	–	–	–	–	–
	2	60	<b>75</b>	90	160	<b>200</b>	240	105	<b>130</b>	160	–	–	–	–	–	–
N	ap [mm]	0,051	–	0,300	–	–	–	0,051	–	0,300	–	–	–	0,051	–	0,300
	f [mm/rev]	0,025	–	0,300	–	–	–	0,025	–	0,300	–	–	–	0,025	–	0,300
	1	400	<b>505</b>	605	–	–	–	400	<b>505</b>	605	–	–	–	855	<b>1065</b>	1280
	2	295	<b>370</b>	445	–	–	–	295	<b>370</b>	445	–	–	–	650	<b>810</b>	975
	3	70	<b>85</b>	105	–	–	–	80	<b>100</b>	120	–	–	–	365	<b>455</b>	550
	4	100	<b>125</b>	150	–	–	–	195	<b>240</b>	290	–	–	–	325	<b>405</b>	490
	5	145	<b>185</b>	220	–	–	–	195	<b>245</b>	295	–	–	–	340	<b>425</b>	510
	6	140	<b>175</b>	210	–	–	–	175	<b>220</b>	265	–	–	–	335	<b>420</b>	505
S	ap [mm]	0,025	–	0,200	–	–	–	–	–	–	0,025	–	0,200	–	–	–
	f [mm/rev]	0,025	–	0,127	–	–	–	–	–	–	0,025	–	0,127	–	–	–
	1	25	<b>30</b>	40	–	–	–	–	–	–	90	<b>110</b>	135	–	–	–
	2	20	<b>25</b>	30	–	–	–	–	–	–	70	<b>85</b>	105	–	–	–
	3	25	<b>35</b>	40	–	–	–	–	–	–	100	<b>120</b>	145	–	–	–
H	ap [mm]	–	–	–	–	–	–	–	–	–	0,025	–	0,200	–	–	–
	f [mm/rev]	–	–	–	–	–	–	–	–	–	0,025	–	0,127	–	–	–
	1	–	–	–	–	–	–	–	–	–	110	<b>135</b>	165	–	–	–
	2	–	–	–	–	–	–	–	–	–	105	<b>130</b>	155	–	–	–
	3	–	–	–	–	–	–	–	–	–	100	<b>120</b>	145	–	–	–
4	–	–	–	–	–	–	–	–	–	90	<b>110</b>	135	–	–	–	

NOTE: Speed and feed rates and depth of cut may vary depending on materials and machining conditions including, but not limited to, tool overhang, tool size, and finished surface requirements.

# Small Hole Boring • Positive Inserts

## CDHB

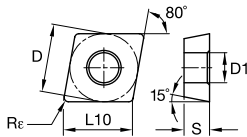
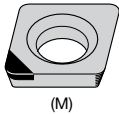

● first choice

○ alternate choice

<b>P</b>	<input type="checkbox"/>	<input type="checkbox"/>	<input type="checkbox"/>	<input type="checkbox"/>	<input type="checkbox"/>	<input type="checkbox"/>	<input type="checkbox"/>	<input type="checkbox"/>	<input type="checkbox"/>	<input type="checkbox"/>	<input type="checkbox"/>	<input type="checkbox"/>	<input type="checkbox"/>	<input type="checkbox"/>	<input type="checkbox"/>	<input type="checkbox"/>	<input type="checkbox"/>
<b>M</b>	<input type="checkbox"/>	<input type="checkbox"/>	<input type="checkbox"/>	<input type="checkbox"/>	<input type="checkbox"/>	<input type="checkbox"/>	<input type="checkbox"/>	<input type="checkbox"/>	<input type="checkbox"/>	<input type="checkbox"/>	<input type="checkbox"/>	<input type="checkbox"/>	<input type="checkbox"/>	<input type="checkbox"/>	<input type="checkbox"/>	<input type="checkbox"/>	<input type="checkbox"/>
<b>K</b>	<input checked="" type="checkbox"/>	<input checked="" type="checkbox"/>	<input checked="" type="checkbox"/>	<input checked="" type="checkbox"/>	<input checked="" type="checkbox"/>	<input checked="" type="checkbox"/>	<input checked="" type="checkbox"/>	<input checked="" type="checkbox"/>	<input checked="" type="checkbox"/>	<input checked="" type="checkbox"/>	<input checked="" type="checkbox"/>	<input checked="" type="checkbox"/>	<input checked="" type="checkbox"/>	<input checked="" type="checkbox"/>	<input checked="" type="checkbox"/>	<input checked="" type="checkbox"/>	<input checked="" type="checkbox"/>
<b>N</b>	<input checked="" type="checkbox"/>	<input checked="" type="checkbox"/>	<input checked="" type="checkbox"/>	<input checked="" type="checkbox"/>	<input checked="" type="checkbox"/>	<input checked="" type="checkbox"/>	<input checked="" type="checkbox"/>	<input checked="" type="checkbox"/>	<input checked="" type="checkbox"/>	<input checked="" type="checkbox"/>	<input checked="" type="checkbox"/>	<input checked="" type="checkbox"/>	<input checked="" type="checkbox"/>	<input checked="" type="checkbox"/>	<input checked="" type="checkbox"/>	<input checked="" type="checkbox"/>	<input checked="" type="checkbox"/>
<b>S</b>	<input type="checkbox"/>	<input type="checkbox"/>	<input type="checkbox"/>	<input type="checkbox"/>	<input type="checkbox"/>	<input type="checkbox"/>	<input type="checkbox"/>	<input type="checkbox"/>	<input type="checkbox"/>	<input type="checkbox"/>	<input type="checkbox"/>	<input type="checkbox"/>	<input type="checkbox"/>	<input type="checkbox"/>	<input type="checkbox"/>	<input type="checkbox"/>	<input type="checkbox"/>
<b>H</b>	<input type="checkbox"/>	<input type="checkbox"/>	<input type="checkbox"/>	<input type="checkbox"/>	<input type="checkbox"/>	<input type="checkbox"/>	<input type="checkbox"/>	<input type="checkbox"/>	<input type="checkbox"/>	<input type="checkbox"/>	<input type="checkbox"/>	<input type="checkbox"/>	<input type="checkbox"/>	<input type="checkbox"/>	<input type="checkbox"/>	<input type="checkbox"/>	<input type="checkbox"/>

ISO catalog number	ANSI catalog number	D		L10		S		R <sub>ε</sub>		D1		max DOC		C2	C25	C3	CG5	CG55	CG6	CM1	ALO	TN7	CBN6	CPD1		
		mm	in	mm	in	mm	in	mm	in	mm	in	mm	in													
CDHBS4T0X0	CDHB1206X0	3,97	5/32	4,03	.159	1,02	.040	0,05	.002	2,13	.084	—	—	—	2830897	—	—	3884731	—	2830888	2830881	—	—	—	—	—
CDHBS4T0X0M	CDHB1206X0M	3,97	5/32	4,03	.159	1,02	.040	0,05	.002	2,13	.084	1,90	.075	—	—	—	—	—	—	—	—	—	2830746	—	—	
CDHBS4T002	CDHB120605	3,97	5/32	4,03	.159	1,02	.040	0,18	.007	2,13	.084	—	—	—	2830864	—	—	3884732	—	2830853	2830848	—	—	—	—	—
CDHBS4T002M	CDHB120605M	3,97	5/32	4,03	.159	1,02	.040	0,18	.007	2,13	.084	0,96	.038	—	—	—	—	—	—	—	—	—	—	2830741	—	—
CDHBS4T004	CDHB12061	3,97	5/32	4,03	.159	1,02	.040	0,38	.015	2,13	.084	—	—	—	2830830	—	—	2830788	—	2830817	2830813	—	—	—	—	—

NOTE: Max DOC only applies to tipped inserts, which are designated with an "M" at the end of the catalog number.

CDHH • R/L

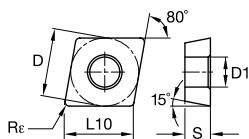

● first choice

○ alternate choice

P	■	○	○	○	●	○	○	○	○	○	○	○	○	○
M	■	○	○	○	○	○	○	○	○	○	○	○	○	○
K	■	○	●	○	○	○	○	○	○	○	○	○	○	○
N	■	○	○	○	○	○	○	○	○	○	○	○	○	○
S	■	○	○	○	○	○	○	○	○	○	○	○	○	○
H	■	○	○	○	○	○	○	○	○	○	○	○	○	○

ISO catalog number	ANSI catalog number	D		L10		S		Rε		D1		C2	C25	C3	CG5	CG55	CG6	CM1	ALO	TN7	CBN6	CPD1	
		mm	in	mm	in	mm	in	mm	in	mm	in												
right hand																							
CDHHS4T002R	CDHH120605R	3,97	5/32	4,03	.159	1,02	.040	0,18	.007	2,13	.084	■	■	■	2830731	■	■	2830706	■	■	■	■	■
CDHHS4T004R	CDHH12061R	3,97	5/32	4,03	.159	1,02	.040	0,38	.015	2,13	.084	■	■	■	2830682	■	■	■	■	■	■	■	■
left hand																							
CDHHS4T002L	CDHH120605L	3,97	5/32	4,03	.159	1,02	.040	0,18	.007	2,13	.084	■	■	■	2830724	■	■	2830712	■	■	■	■	■
CDHHS4T004L	CDHH12061L	3,97	5/32	4,03	.159	1,02	.040	0,38	.015	2,13	.084	■	■	■	2830678	■	■	2830700	■	■	■	■	■

INDEXABLE MILLING

SOLID END MILLING

HOLE/MAKING

TAPPING

TURNING



# Small Hole Boring • Positive Inserts

INDEXABLE MILLING

## CDHH

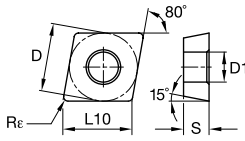
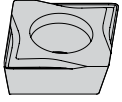

- first choice
- alternate choice

	P	M	K	N	S	H	C2	C25	C3	CG5	CG55	CG6	CM1	ALO	TN7	CBN6	CPD1
P	●	○	○	○	○	○	○	○	○	○	○	○	○	○	○	○	○
M	○	●	○	○	○	○	○	○	○	○	○	○	○	○	○	○	○
K	○	○	●	○	○	○	○	○	○	○	○	○	○	○	○	○	○
N	○	○	○	●	○	○	○	○	○	○	○	○	○	○	○	○	○
S	○	○	○	○	●	○	○	○	○	○	○	○	○	○	○	○	○
H	○	○	○	○	○	○	○	○	○	○	○	○	○	○	○	○	○

ISO catalog number neutral hand	ANSI catalog number	D		L10		S		Rε		D1		C2	C25	C3	CG5 2830632	CG55	CG6 2830638	CM1	ALO	TN7	CBN6	CPD1
		mm	in	mm	in	mm	in	mm	in	mm	in											
CDHHS4T002	CDHH120605	3,97	5/32	4,03	.159	1,02	.040	0,18	.007	2,13	.084	○	○	○	○	○	○	○	○	○	○	○
CDHHS4T004	CDHH12061	3,97	5/32	4,10	.161	1,02	.040	0,38	.015	2,13	.084	○	○	○	○	○	○	○	○	○	○	○

SOLID END MILLING

HOLEMAKING

## CPHB

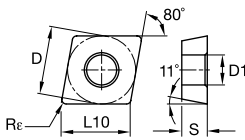
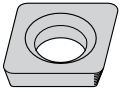

- first choice
- alternate choice

	P	M	K	N	S	H	C2	C25	C3	CG5	CG55	CG6	CM1	ALO	TN7	CBN6	CPD1
P	●	○	○	○	○	○	○	○	○	○	○	○	○	○	○	○	○
M	○	●	○	○	○	○	○	○	○	○	○	○	○	○	○	○	○
K	○	○	●	○	○	○	○	○	○	○	○	○	○	○	○	○	○
N	○	○	○	●	○	○	○	○	○	○	○	○	○	○	○	○	○
S	○	○	○	○	●	○	○	○	○	○	○	○	○	○	○	○	○
H	○	○	○	○	○	○	○	○	○	○	○	○	○	○	○	○	○

ISO catalog number	ANSI catalog number	D		L10		S		Rε		D1		C2	C25	C3	CG5 2824583	CG55	CG6	CM1	ALO	TN7	CBN6	CPD1
		mm	in	mm	in	mm	in	mm	in	mm	in											
CPHB06T102	CPHB21205	6,35	1/4	6,45	.254	1,90	.075	0,18	.007	2,79	.110	○	○	○	○	○	○	○	○	○	○	○
CPHB06T104	CPHB2121	6,35	1/4	6,45	.254	1,90	.075	0,38	.015	2,79	.110	○	○	○	○	○	○	○	○	○	○	○

TAPPING

TURNING

### CPHH

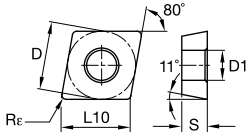
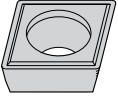

● first choice  
○ alternate choice

P	●	○	○	○	○	○	○	○	○	○	○	○	○	○	○	○
M	○	○	○	○	○	○	○	○	○	○	○	○	○	○	○	○
K	○	○	○	○	○	○	○	○	○	○	○	○	○	○	○	○
N	○	○	○	○	○	○	○	○	○	○	○	○	○	○	○	○
S	○	○	○	○	○	○	○	○	○	○	○	○	○	○	○	○
H	○	○	○	○	○	○	○	○	○	○	○	○	○	○	○	○

ISO catalog number	ANSI catalog number	D		L10		S		Rε		D1		C2	C25	C3	CG5 2824461 2824441	CG55 2824454	CG6 CM1	ALO	TN7	CBN6	CPD1
		mm	in	mm	in	mm	in	mm	in	mm	in										
CPHH06T102	CPHH21205	6,35	1/4	6,45	.254	1,91	.075	0,18	.007	2,79	.110										
CPHH06T104	CPHH2121	6,35	1/4	6,45	.254	1,91	.075	0,38	.015	2,80	.110										

### CPMT-LF

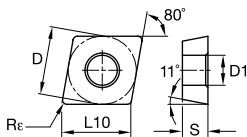

● first choice  
○ alternate choice

P	●	○	○	○	○	○	○	○	○	○	○	○	○	○	○	○
M	○	○	○	○	○	○	○	○	○	○	○	○	○	○	○	○
K	○	○	○	○	○	○	○	○	○	○	○	○	○	○	○	○
N	○	○	○	○	○	○	○	○	○	○	○	○	○	○	○	○
S	○	○	○	○	○	○	○	○	○	○	○	○	○	○	○	○
H	○	○	○	○	○	○	○	○	○	○	○	○	○	○	○	○

ISO catalog number	ANSI catalog number	D		L10		S		Rε		D1		C2	C25	C3	CG5 2821519 2821499	CG55 2821484	CG6	CM1	ALO	TN7	CBN6	CPD1
		mm	in	mm	in	mm	in	mm	in	mm	in											
CPMT09T302LF	CPMT32505LF	9,53	3/8	9,67	.381	3,97	.156	0,20	.008	4,40	.173											
CPMT09T304LF	CPMT3251LF	9,53	3/8	9,67	.381	3,97	.156	0,40	.016	4,40	.173											
CPMT09T308LF	CPMT3252LF	9,53	3/8	9,67	.381	3,97	.156	0,80	.031	4,40	.173											

# Small Hole Boring • Positive Inserts

INDEXABLE MILLING

## GCHW

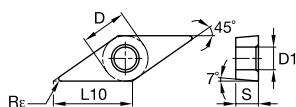
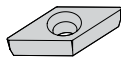

● first choice

○ alternate choice

P	●	○	○	○	○	○	○	○	○	○	○	○	○	○	○	○	○	○	○
M	○	○	○	○	○	○	○	○	○	○	○	○	○	○	○	○	○	○	○
K	○	○	○	○	○	○	○	○	○	○	○	○	○	○	○	○	○	○	○
N	○	○	○	○	○	○	○	○	○	○	○	○	○	○	○	○	○	○	○
S	○	○	○	○	○	○	○	○	○	○	○	○	○	○	○	○	○	○	○
H	○	○	○	○	○	○	○	○	○	○	○	○	○	○	○	○	○	○	○

ISO catalog number	ANSI catalog number	D		L10		S		Rε		D1		C2	C25	C3	CG5 2827596	CG55	CG6	CM1 2827601	ALO	TN7	CBN6	CPD1
		mm	in	mm	in	mm	in	mm	in	mm	in											
GCHW060202	GCHW151505	4,76	3/16	6,73	.265	2,36	.093	0,18	.007	2,39	.094	○	○	○	○	○	○	○	○	○	○	○
GCHW060204	GCHW15151	4,76	3/16	6,73	.265	2,36	.093	0,38	.015	2,39	.094	○	○	○	○	○	○	○	○	○	○	○

SOLID END MILLING

HOLEMAKING

## GCHT

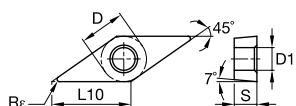

● first choice

○ alternate choice

P	○	○	○	○	○	○	○	○	○	○	○	○	○	○	○	○	○	○	○
M	○	○	○	○	○	○	○	○	○	○	○	○	○	○	○	○	○	○	○
K	○	○	○	○	○	○	○	○	○	○	○	○	○	○	○	○	○	○	○
N	○	○	○	○	○	○	○	○	○	○	○	○	○	○	○	○	○	○	○
S	○	○	○	○	○	○	○	○	○	○	○	○	○	○	○	○	○	○	○
H	○	○	○	○	○	○	○	○	○	○	○	○	○	○	○	○	○	○	○

ISO catalog number	ANSI catalog number	D		L10		S		Rε		D1		C2	C25	C3	CG5 2827537	CG55	CG6	CM1 2827531	ALO	TN7	CBN6	CPD1
		mm	in	mm	in	mm	in	mm	in	mm	in											
GCHT060202	GCHT151505	4,83	.1902	6,83	.269	2,36	.093	0,18	.007	2,39	.094	○	○	○	○	○	○	○	○	○	○	○
GCHT060204	GCHT15151	4,76	3/16	6,83	.269	2,36	.093	0,38	.015	2,39	.094	○	○	○	○	○	○	○	○	○	○	○

TAPPING

TURNING

### GPHW

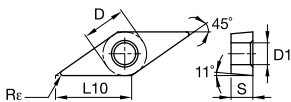
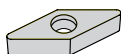

● first choice  
○ alternate choice

P	●	○	○	○	○	○	○	○	○	○	○	○	○	○	○
M	○	○	○	○	○	○	○	○	○	○	○	○	○	○	○
K	○	○	○	○	○	○	○	○	○	○	○	○	○	○	○
N	○	○	○	○	○	○	○	○	○	○	○	○	○	○	○
S	○	○	○	○	○	○	○	○	○	○	○	○	○	○	○
H	○	○	○	○	○	○	○	○	○	○	○	○	○	○	○

ISO catalog number	ANSI catalog number	D		L10		S		Rε		D1		C2	C25	C3	CG5	CG55	CG6	CM1	ALO	TN7	CBN6	CPD1		
		mm	in	mm	in	mm	in	mm	in	mm	in													
GPHW050102	GPHW12105	3,97	5/32	5,61	.221	1,59	.062	0,18	.007	2,13	.084	○	○	○	○	○	○	○	○	○	○	○	○	○
GPHW050104	GPHW1211	3,97	5/32	5,61	.221	1,59	.062	0,38	.015	2,13	.084	○	○	○	○	○	○	○	○	○	○	○	○	○

### GPHT

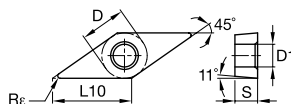
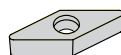

● first choice  
○ alternate choice

P	●	○	○	○	○	○	○	○	○	○	○	○	○	○	○	○	○	○	○	○	○	○	○
M	○	○	○	○	○	○	○	○	○	○	○	○	○	○	○	○	○	○	○	○	○	○	○
K	○	○	○	○	○	○	○	○	○	○	○	○	○	○	○	○	○	○	○	○	○	○	○
N	○	○	○	○	○	○	○	○	○	○	○	○	○	○	○	○	○	○	○	○	○	○	○
S	○	○	○	○	○	○	○	○	○	○	○	○	○	○	○	○	○	○	○	○	○	○	○
H	○	○	○	○	○	○	○	○	○	○	○	○	○	○	○	○	○	○	○	○	○	○	○

ISO catalog number	ANSI catalog number	D		L10		S		Rε		D1		C2	C25	C3	CG5	CG55	CG6	CM1	ALO	TN7	CBN6	CPD1	
		mm	in	mm	in	mm	in	mm	in	mm	in												
GPHT050102	GPHT12105	3,97	5/32	5,76	.227	1,57	.062	0,18	.007	2,13	.084	○	○	○	○	○	○	○	○	○	○	○	○
GPHT050104	GPHT1211	4,08	.1605	5,76	.227	1,57	.062	0,38	.015	2,13	.084	○	○	○	○	○	○	○	○	○	○	○	○

# Small Hole Boring • Positive Inserts

## TBHB

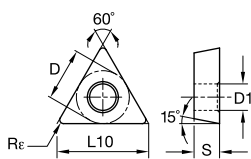
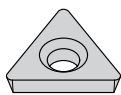

- first choice
- alternate choice

P	○	○	○	○	●	○	○	○	○	○	○	○	○	○
M	○	○	○	○	○	○	○	○	○	○	○	○	○	○
K	○	○	●	●	●	○	○	○	○	○	○	○	○	○
N	○	○	●	●	●	○	○	○	○	○	○	○	○	○
S	○	○	○	○	○	○	○	○	○	○	○	○	○	○
H	○	○	○	○	○	○	○	○	○	○	○	○	○	○

ISO catalog number	ANSI catalog number	D		L10		S		Re		D1		C2	C25	C3	CG5	CG55	CG6	CM1	ALO	TN7	CBN6	CPD1	
		mm	in	mm	in	mm	in	mm	in	mm	in												
TBHB07S1X0	TBHB1308X0	4,06	.16	7,04	.277	1,19	.047	0,05	.002	2,39	.094	○	○	○	○	○	○	○	○	○	○	○	○
TBHB110201	TBHB2150	6,35	1/4	11,00	.433	2,38	.094	0,10	.004	3,33	.131	○	○	○	○	○	○	○	○	○	○	○	○

INDEXABLE MILLING

SOLID END MILLING

HOLEMAKING

TAPPING

TURNING

## TDHB

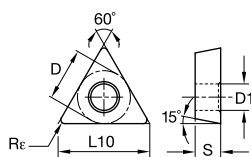
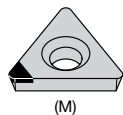

- first choice
- alternate choice

P																		
M	●	○	○	○	○	○	○	○	○	○	○	○	○	○	○	○	○	○
K	○	○	○	○	○	○	○	○	○	○	○	○	○	○	○	○	○	○
N	○	○	○	○	○	○	○	○	○	○	○	○	○	○	○	○	○	○
S	○	○	○	○	○	○	○	○	○	○	○	○	○	○	○	○	○	○
H	○	○	○	○	○	○	○	○	○	○	○	○	○	○	○	○	○	○

ISO catalog number	ANSI catalog number	D		L10		S		Rε		D1		max DOC		C2	C25	C3	CG5	CG55	CG6	CM1	ALO	TN7	CBN6	CPD1	
		mm	in	mm	in	mm	in	mm	in	mm	in	mm	in												
TDHB07S102M	TDHB130805M	4,06	.160	7,04	.277	1,19	.047	0,18	.007	2,39	.095	1,27	.050	○	○	○	○	○	○	○	○	○	○	○	○
TDHB07S104M	TDHB13081M	4,06	.160	7,04	.277	1,19	.047	0,38	.015	2,39	.094	1,27	.050	○	○	○	○	○	○	○	○	○	○	○	○
TDHB07S1X0	TDHB1308X0	4,06	.160	7,04	.277	1,19	.047	0,05	.002	2,41	.095	—	—	○	○	○	○	○	○	○	○	○	○	○	○
TDHB07S102	TDHB130805	4,06	.160	7,04	.277	1,19	.047	0,18	.007	2,41	.095	—	—	○	○	○	○	○	○	○	○	○	○	○	○
TDHB07S104	TDHB13081	4,06	.160	7,04	.277	1,19	.047	0,38	.015	2,41	.095	—	—	○	○	○	○	○	○	○	○	○	○	○	○
TDHB07S108	TDHB13082	4,06	.160	7,04	.277	1,19	.047	0,79	.031	2,41	.095	—	—	○	○	○	○	○	○	○	○	○	○	○	○

NOTE: Max DOC only applies to tipped inserts, which are designated with an "M" at the end of the catalog number.

INDEXABLE MILLING

SOLID END MILLING

HOLE/MAKING

TAPPING

TURNING



## TPHB

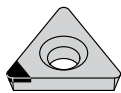

(M)

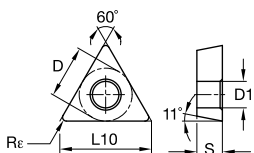

● first choice  
○ alternate choice

	P	M	K	N	S	H
C2	○	○	○	○	○	○
C25	○	○	○	○	○	○
C3	○	○	○	○	○	○
CG5	○	○	○	○	○	○
CG55	○	○	○	○	○	○
CG6	○	○	○	○	○	○
CM1	○	○	○	○	○	○
ALO	○	○	○	○	○	○
TN7	○	○	○	○	○	○
CBN6	○	○	○	○	○	○
CPD1	○	○	○	○	○	○

ISO catalog number	ANSI catalog number	D		L10		S		R <sub>ε</sub>		D1		max DOC		C2	C25	C3	CG5	CG55	CG6	CM1	ALO	TN7	CBN6	CPD1
		mm	in	mm	in	mm	in	mm	in	mm	in	mm	in											
TPHB1102X0	TPHB215X0	6,35	1/4	11,00	.433	2,38	.094	0,05	.002	3,30	.130	—	—	—	—	—	—	—	—	—	—	—	—	—
TPHB1102X0M	TPHB215X0M	6,35	1/4	11,00	.433	2,38	.094	0,05	.002	3,30	.130	1,62	.064	—	—	—	—	—	—	—	—	—	—	—
TPHB110202	TPHB21505	6,35	1/4	11,00	.433	2,38	.094	0,18	.007	3,30	.130	—	—	—	—	—	—	—	—	—	—	—	—	—
TPHB110202M	TPHB21505M	6,35	1/4	11,00	.433	2,38	.094	0,18	.007	3,30	.130	1,62	.064	—	—	—	—	—	—	—	—	—	—	—
TPHB110204M	TPHB2151M	6,35	1/4	11,00	.433	2,38	.094	0,40	.015	3,30	.130	1,62	.064	—	—	—	—	—	—	—	—	—	—	—
TPHB110204	TPHB2151	6,35	1/4	11,00	.433	2,38	.094	0,38	.015	3,30	.130	—	—	—	—	—	—	—	—	—	—	—	—	—
TPHB110208	TPHB2152	6,35	1/4	11,00	.433	2,38	.094	0,79	.031	3,30	.130	—	—	—	—	—	—	—	—	—	—	—	—	—
TPHB1603X0	TPHB32X0	9,53	3/8	16,50	.650	3,18	.125	0,05	.002	3,30	.130	—	—	—	—	—	—	—	—	—	—	—	—	—
TPHB160302	TPHB3205	9,53	3/8	16,50	.650	3,18	.125	0,18	.007	3,30	.130	—	—	—	—	—	—	—	—	—	—	—	—	—
TPHB160304	TPHB321	9,53	3/8	16,50	.650	3,18	.125	0,38	.015	3,30	.130	—	—	—	—	—	—	—	—	—	—	—	—	—
TPHB160308	TPHB322	9,53	3/8	16,50	.650	3,18	.125	0,79	.031	3,30	.130	—	—	—	—	—	—	—	—	—	—	—	—	—
TPCB160302	TD6P05	9,53	3/8	—	—	3,23	.127	0,18	.007	3,30	.130	—	—	—	—	—	—	—	—	—	—	—	—	—

NOTE: Max DOC only applies to tipped inserts, which are designated with an "M" at the end of the catalog number.

INDEXABLE MILLING

SOLID END MILLING

HOLE/MAKING

TAPPING

TURNING



## TPHH • R/L

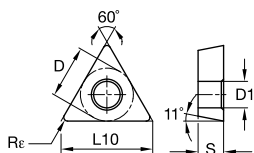
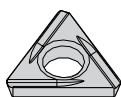

● first choice  
○ alternate choice

P	■				●	○	●	○	○	○	○	○										
M	■	○	○	○	○	○	○	○	○	○	○	○	○	○	○	○	○	○	○	○	○	○
K	■	○	○	○	○	○	○	○	○	○	○	○	○	○	○	○	○	○	○	○	○	○
N	■	○	○	○	○	○	○	○	○	○	○	○	○	○	○	○	○	○	○	○	○	○
S	■	○	○	○	○	○	○	○	○	○	○	○	○	○	○	○	○	○	○	○	○	○
H	■	○	○	○	○	○	○	○	○	○	○	○	○	○	○	○	○	○	○	○	○	○

ISO catalog number	ANSI catalog number	D		L10		S		Rε		D1		C2	C25	C3	CG5	CG55	CG6	CM1	ALO	TN7	CBN6	CPD1
		mm	in	mm	in	mm	in	mm	in	mm	in											
<b>right hand</b>																						
TPHH110202R	TPHH21505R	6,35	1/4	11,00	.433	2,38	.094	0,18	.007	3,33	.131				2823812							
TPHH160302R	TPHH3205R	9,53	3/8	16,50	.650	3,18	.125	0,18	.007	3,33	.131				2821213							
TPHH160304R	TPHH321R	9,53	3/8	16,50	.650	3,18	.125	0,38	.015	3,33	.131				2821168							
TPHH160308R	TPHH322R	9,53	3/8	16,50	.650	3,18	.125	0,79	.031	3,33	.131				2821121							
<b>left hand</b>																						
TPHH110202L	TPHH21505L	6,35	1/4	11,00	.433	2,38	.094	0,18	.007	3,33	.131				2823805						2823767	
TPHH110204L	TPHH2151L	6,35	1/4	11,00	.433	2,38	.094	0,38	.015	3,33	.131				2823753		2823739					
TPHH160302L	TPHH3205L	9,53	3/8	16,50	.650	3,18	.125	0,18	.007	3,33	.131				2821208							
TPHH160304L	TPHH321L	9,53	3/8	16,50	.650	3,18	.125	0,38	.015	3,33	.131				2821162		2821150					
TPHH160308L	TPHH322L	9,53	3/8	16,50	.650	3,18	.125	0,79	.031	3,33	.131				2821115							

**TPHH**

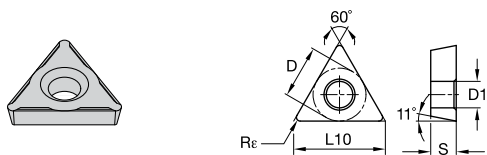

● first choice  
○ alternate choice

P	■	■	■	■	●	○	○	○	○	○	○	○	○	○	○
M	■	■	■	■	●	○	○	○	○	○	○	○	○	○	○
K	■	■	■	■	●	○	○	○	○	○	○	○	○	○	○
N	■	■	■	■	●	○	○	○	○	○	○	○	○	○	○
S	■	■	■	■	○	○	○	○	○	○	○	○	○	○	○
H	■	■	■	■	○	○	○	○	○	○	○	○	○	○	○

ISO catalog number	ANSI catalog number	D		L10		S		Re		D1		C2	C25	C3	CG5	CG55	CG6	CM1	ALO	TN7	CBN6	CPD1	
		mm	in	mm	in	mm	in	mm	in	mm	in												
TPHH110202	TPHH21505	6,35	1/4	11,00	.433	2,38	.094	0,18	.007	3,30	.130					2823914		2823908					
TPHH110204	TPHH2151	6,35	1/4	11,00	.433	2,38	.094	0,38	.015	3,30	.130				2823858								
TPCH110204	TPCH221	6,50	.256	11,26	.443	2,38	.094	0,38	.015	3,30	.130						2823851						

**TPHH-LF**

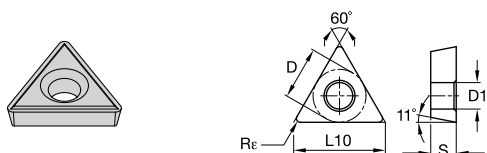

● first choice  
○ alternate choice

P	■	■	■	■	●	○	○	○	○	○	○	○	○	○	○
M	■	■	■	■	●	○	○	○	○	○	○	○	○	○	○
K	■	■	■	■	●	○	○	○	○	○	○	○	○	○	○
N	■	■	■	■	●	○	○	○	○	○	○	○	○	○	○
S	■	■	■	■	○	○	○	○	○	○	○	○	○	○	○
H	■	■	■	■	○	○	○	○	○	○	○	○	○	○	○

ISO catalog number	ANSI catalog number	D		L10		S		Re		D1		C2	C25	C3	CG5	CG55	CG6	CM1	ALO	TN7	CBN6	CPD1	
		mm	in	mm	in	mm	in	mm	in	mm	in												
TPHH160304	TPHH321	9,53	3/8	16,50	.650	3,18	.125	0,40	.016	3,33	.131					2821070		2821705					
TPHH160304LF	TPHH321LF	9,53	3/8	16,50	.650	3,18	.125	0,40	.016	3,33	.131		2821718										
TPHH160308	TPHH322	9,53	3/8	16,50	.650	3,18	.125	0,79	.031	3,33	.131						2821670						
TPHH160308	TPHH322LF	9,53	3/8	16,50	.650	3,18	.125	0,79	.031	3,33	.131				2821067								
TPHH17T309LF	TPHH312524LF	9,80	.386	16,98	.669	3,97	.156	0,94	.037	3,33	.131				2821319								

# Small Hole Boring • Positive Inserts

INDEXABLE MILLING

## TPGT-HP

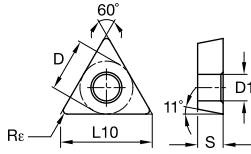
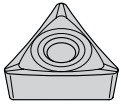

● first choice  
○ alternate choice

P	■	■	■	■	●	○	●	○	○	○	●	■	■	■	■	■	■	■	■
M	■	○	○	○	○	○	○	○	○	○	○	○	○	○	○	○	○	○	○
K	■	○	○	○	○	○	○	○	○	○	○	○	○	○	○	○	○	○	○
N	■	○	○	○	○	○	○	○	○	○	○	○	○	○	○	○	○	○	○
S	■	○	○	○	○	○	○	○	○	○	○	○	○	○	○	○	○	○	○
H	■	○	○	○	○	○	○	○	○	○	○	○	○	○	○	○	○	○	○

ISO catalog number	ANSI catalog number	D		L10		S		Rε		D1		C2	C25	C3	CG5	CG55	CG6	CM1	ALO	TN7	CBN6	CPD1	
		mm	in	mm	in	mm	in	mm	in	mm	in												
TPGT110202HP	TPGT21505HP	6,35	1/4	11,00	.433	2,38	.094	0,20	.008	2,90	.114	■	■	■	○	●	○	○	○	○	○	○	○
TPGT110204HP	TPGT2151HP	6,35	1/4	11,00	.433	2,38	.094	0,40	.016	2,90	.114	■	■	■	○	●	○	○	○	○	○	○	○
TPGT16T304HP	TPGT3251HP	9,53	3/8	16,50	.650	3,97	.156	0,40	.016	4,40	.173	■	■	■	○	●	○	○	○	○	○	○	○

SOLID END MILLING

HOLEMAKING

## TPMT-LF

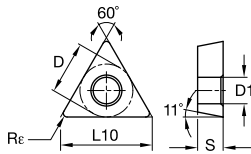
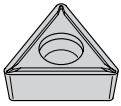

● first choice  
○ alternate choice

P	■	■	■	■	●	○	●	○	○	○	○	○	○	○	○	○	○	○	○	○	○	○	○
M	■	○	○	○	○	○	○	○	○	○	○	○	○	○	○	○	○	○	○	○	○	○	○
K	■	○	○	○	○	○	○	○	○	○	○	○	○	○	○	○	○	○	○	○	○	○	○
N	■	○	○	○	○	○	○	○	○	○	○	○	○	○	○	○	○	○	○	○	○	○	○
S	■	○	○	○	○	○	○	○	○	○	○	○	○	○	○	○	○	○	○	○	○	○	○
H	■	○	○	○	○	○	○	○	○	○	○	○	○	○	○	○	○	○	○	○	○	○	○

ISO catalog number	ANSI catalog number	D		L10		S		Rε		D1		C2	C25	C3	CG5	CG55	CG6	CM1	ALO	TN7	CBN6	CPD1	
		mm	in	mm	in	mm	in	mm	in	mm	in												
TPMT110202LF	TPMT21505LF	6,35	1/4	11,00	.433	2,38	.094	0,20	.008	2,80	.110	■	■	■	○	●	○	○	○	○	○	○	○
TPMT110204LF	TPMT2151LF	6,35	1/4	11,00	.433	2,38	.094	0,40	.016	2,90	.114	■	■	■	○	●	○	○	○	○	○	○	○
TPMT160304LF	TPMT321LF	9,53	3/8	16,50	.650	3,18	.125	0,40	.016	4,40	.173	■	■	■	○	●	○	○	○	○	○	○	○
TPMT160308LF	TPMT322LF	9,53	3/8	16,50	.650	3,18	.125	0,79	.031	4,40	.173	■	■	■	○	●	○	○	○	○	○	○	○

TAPPING

TURNING

## WPHT

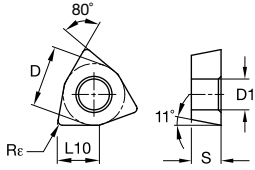
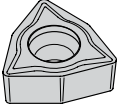

- first choice
- alternate choice

<b>P</b>	○	○	○	○	●	○	○	○	○	○	○	○	○	○	○	○	○	○	○	○	○	○
<b>M</b>	○	○	○	○	○	○	○	○	○	○	○	○	○	○	○	○	○	○	○	○	○	○
<b>K</b>	○	○	○	○	○	○	○	○	○	○	○	○	○	○	○	○	○	○	○	○	○	○
<b>N</b>	○	○	○	○	○	○	○	○	○	○	○	○	○	○	○	○	○	○	○	○	○	○
<b>S</b>	○	○	○	○	○	○	○	○	○	○	○	○	○	○	○	○	○	○	○	○	○	○
<b>H</b>	○	○	○	○	○	○	○	○	○	○	○	○	○	○	○	○	○	○	○	○	○	○

ISO catalog number	ANSI catalog number	D		L10		S		Rε		D1		C2	C25	C3	CG5	CG55	CG6	CM1	ALO	TN7	CBN6	CPD1	
		mm	in	mm	in	mm	in	mm	in	mm	in												
WPHTS30101	WPHT1510	4,76	3/16	3,26	.128	1,59	.062	0,10	.004	2,16	.085												
WPHTS30102	WPHT15105	4,76	3/16	3,26	.128	1,59	.062	0,20	.008	2,16	.085				2827483			2827490					
WPHTS30104	WPHT1511	4,76	3/16	3,26	.128	1,59	.062	0,40	.016	2,16	.085				2827471			2827477					
WPGT040202UF	WPGT21505UF	6,35	1/4	4,34	.171	2,38	.094	0,20	.008	2,79	.110				2824331								
WPHT040201	WPHT2150	6,35	1/4	4,34	.171	2,38	.094	0,10	.004	2,80	.110				2824344								
WPHT040204	WPHT2151	6,35	1/4	4,34	.171	2,38	.094	0,40	.016	2,80	.110				2824316								

# Small Hole Boring • Positive Inserts

INDEXABLE MILLING

SOLID END MILLING

HOLEMAKING

TAPPING

TURNING

## WPMT-LF

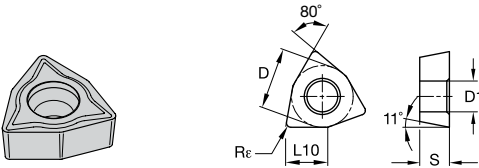

● first choice  
○ alternate choice

P	■	○	○	○	○	○	○	○	○	○	○	○	○	○
M	■	○	○	○	○	○	○	○	○	○	○	○	○	○
K	■	○	○	○	○	○	○	○	○	○	○	○	○	○
N	■	○	○	○	○	○	○	○	○	○	○	○	○	○
S	■	○	○	○	○	○	○	○	○	○	○	○	○	○
H	■	○	○	○	○	○	○	○	○	○	○	○	○	○

ISO catalog number	ANSI catalog number	D		L10		S		Rε		D1		C2	C25	C3	CG5	CG55	CG6	CM1	ALO	TN7	CBN6	CPD1		
		mm	in	mm	in	mm	in	mm	in	mm	in													
WPMTS3T104LF	WPMT15121LF	4,76	3/16	3,26	.128	1,98	.078	0,40	.016	2,15	.085	●	○	○	○	○	○	○	○	○	○	○	○	○
WPMT040204LF	WPMT2151LF	6,35	1/4	4,34	.171	2,38	.094	0,40	.016	2,90	.114	○	○	○	○	○	○	○	○	○	○	○	○	○
WPMT06T304LF	WPMT3251LF	9,53	3/8	6,52	.257	3,97	.156	0,40	.016	4,40	.173	○	○	○	○	○	○	○	○	○	○	○	○	○
WPMT06T308LF	WPMT3252LF	9,53	3/8	6,52	.257	3,97	.156	0,80	.031	4,40	.173	○	○	○	○	○	○	○	○	○	○	○	○	○

## CDG • R/L

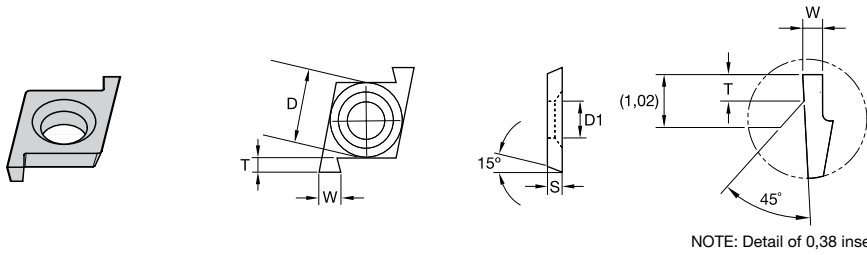

NOTE: Detail of 0,38 insert.

● first choice  
○ alternate choice

P	■	○	○	○	○	○	○	○	○	○	○	○	○	○
M	■	○	○	○	○	○	○	○	○	○	○	○	○	○
K	■	○	○	○	○	○	○	○	○	○	○	○	○	○
N	■	○	○	○	○	○	○	○	○	○	○	○	○	○
S	■	○	○	○	○	○	○	○	○	○	○	○	○	○
H	■	○	○	○	○	○	○	○	○	○	○	○	○	○

ISO catalog number	ANSI catalog number	D		S		T		W		D1		C2	C25	C3	CG5	CG55	CG6	CM1	ALO	TN7	CBN6	CPD1		
		mm	in	mm	in	mm	in	mm	in	mm	in													
CDG50252R	CDG50252R	3,97	5/32	1,27	.050	1,02	.040	0,64	.025	2,13	.084	○	○	○	○	○	○	○	○	○	○	○	○	○
CDG50302R	CDG50302R	3,97	5/32	1,27	.050	1,02	.040	0,76	.030	2,13	.084	○	○	○	○	○	○	○	○	○	○	○	○	○

## CPG • R/L

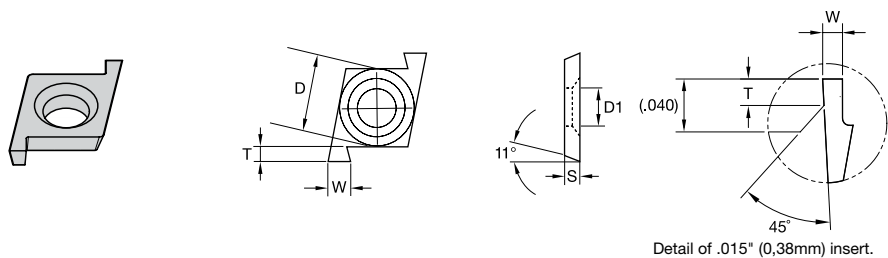

- first choice
- alternate choice

P	●																						
M	●																						
K	●																						
N	●																						
S	●																						
H																							

ISO catalog number right hand	ANSI catalog number	D		S		T		W		D1		C2	C25	C3	CG5 2824546	CG55	CG6	CM1	ALO	TN7	CBN6	CPD1	
		mm	in	mm	in	mm	in	mm	in	mm	in												
CPG2032R	CPG2032R	6,35	1/4	1,91	.075	1,65	.065	0,76	.030	2,79	.110	-	-	-	-	-	-	-	-	-	-	-	-
CPG2062R	CPG2062R	6,35	1/4	1,91	.075	1,65	.065	1,52	.060	2,79	.110	-	-	-	2824531	-	-	-	-	-	-	-	-

## CDT • R/L

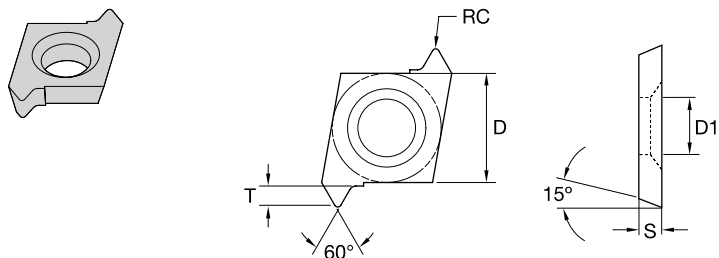

- first choice
- alternate choice

P	●																						
M	●																						
K	●																						
N	●																						
S	●																						
H																							

catalog number	D	S	T	RC	D1	TP min	TP max	TPI min	TPI max	C2	C25	C3	CG5 2830567	CG55	CG6	CM1	ALO	TN7	CBN6	CPD1	
CDT50022R	3,97	1,27	0,76	0,05	2,11	0,5	1,0	24.0	48.0	-	-	-	-	-	-	-	-	-	-	-	-

# Small Hole Boring • Positive Inserts

## CPT • R/L

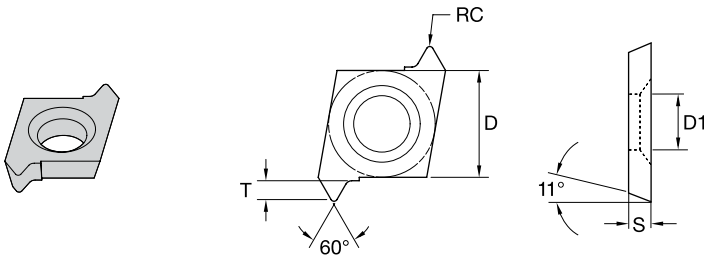

- first choice
- alternate choice

ISO	ANSI	D	S	T	RC	D1	TPI min	TPI max	TP min	TP max	C2	C25	C3	CG5	CG55	CG6	CM1	ALO	TN7	CBN6	CPD1	
right hand																						
CPT20052R	CPT20052R	6,35	1/4	1,91	.075	1,65	.065	0,13	.005	2,79	.110	10	24	1,0	2,5	-	-	-	-	-	-	-

INDEXABLE MILLING

SOLID END MILLING

HOLE/MAKING

TAPPING

TURNING

## CSBI

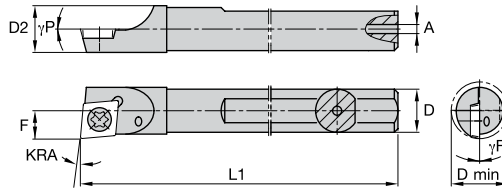

NOTE: KRA shown as -5°.

order number	catalog number	KRA	D	D min	D2	F	L1	A	γF°	γP°	gage insert
<b>right hand</b>											
2832371	CSBI16518757R	-7	.188	.180	.166	.095	2.500	.040	0.0°	0.0°	CD..120605
2832617	CSBI180187255R	-5	.188	.204	.180	.104	2.500	.040	0.0°	5.0°	CD..120605
2832553	CSBI187255R	-5	.188	.228	.203	.228	2.500	.040	0.0°	5.0°	CD..120605
2832442	CSBI25035R	-5	.250	.285	.260	.145	3.000	.040	0.0°	5.0°	CD..120605
2832566	CSBI187250R	0	.188	.244	.203	.122	2.500	.040	0.0°	5.0°	CD..120605
2832454	CSBI25030R	0	.250	.292	.260	.152	3.000	.040	0.0°	5.0°	CD..120605
<b>left hand</b>											
2832365	CSBI16518757L	-7	.188	.180	.166	.095	2.500	.040	0.0°	0.0°	CD..120605
2832623	CSBI180187255L	-5	.188	.204	.180	.104	2.500	.040	0.0°	5.0°	CD..120605
2832559	CSBI187255L	-5	.188	.228	.203	.116	2.500	.040	0.0°	5.0°	CD..120605
2832448	CSBI25035L	-5	.250	.285	.260	.145	3.000	.040	0.0°	5.0°	CD..120605

## CSBI • STEPPED

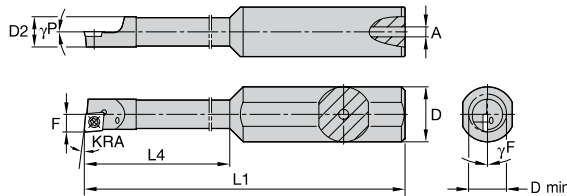

NOTE: KRA shown as -5°.

order number	catalog number	KRA	D	D min	D2	F	L1	L4	A	γF°	γP°	gage insert
<b>right hand</b>												
2832607	CSBI18037515R	-5	.375	.204	.180	.104	2.500	1.000	.040	0.0°	5.0°	CD..120605
2832596	CSBI18037555R	-5	.375	.204	.180	.104	2.500	.500	.040	0.0°	5.0°	CD..120605
2832535	CSBI20337515R	-5	.375	.228	.203	.116	2.500	1.000	.040	0.0°	5.0°	CD..120605
2832429	CSBI2503751255R	-5	.375	.285	.260	.145	2.500	1.250	.040	0.0°	5.0°	CD..120605
2832414	CSBI250375755R	-5	.375	.285	.260	.145	2.500	.750	.040	0.0°	5.0°	CD..120605
2832589	CSBI18050015R	-5	.500	.204	.180	.104	2.750	1.000	.040	0.0°	5.0°	CD..120605
2832577	CSBI18050055R	-5	.500	.204	.180	.104	2.750	.500	.040	0.0°	5.0°	CD..120605
2832488	CSBI20350015R	-5	.500	.228	.203	.116	2.750	1.000	.040	0.0°	5.0°	CD..120605
2832467	CSBI20350055R	-5	.500	.228	.203	.116	2.750	.500	.040	0.0°	5.0°	CD..120605
2832398	CSBI2505001255R	-5	.500	.285	.260	.145	2.750	1.250	.040	0.0°	5.0°	CD..120605
2832374	CSBI250500755R	-5	.500	.285	.260	.145	2.750	.750	.040	0.0°	5.0°	CD..120605
2832547	CSBI20337510R	0	.375	.234	.203	.122	2.500	1.000	.040	0.0°	5.0°	CD..120605
<b>left hand</b>												
2832602	CSBI18037555L	-5	.375	.204	.180	.104	2.500	.500	.040	0.0°	5.0°	CD..120605
2832419	CSBI250375755L	-5	.375	.285	.260	.145	2.500	.750	.040	0.0°	5.0°	CD..120605
2832583	CSBI18050055L	-5	.500	.204	.180	.104	2.750	.500	.040	0.0°	5.0°	CD..120605
2832494	CSBI20350015L	-5	.500	.228	.203	.116	2.750	1.000	.040	0.0°	5.0°	CD..120605



# Small Hole Boring Bars for Turning

## CCBI

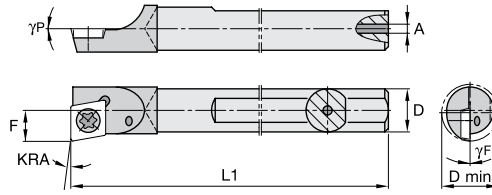

NOTE: KRA shown as  $-5^\circ$ .

order number	catalog number	KRA	D	D min	F	L1	A	$\gamma_F^\circ$	$\gamma_P^\circ$	gage insert
<b>right hand</b>										
2831949	CCBI16515667R	-7	.156	.180	.095	6.000	.040	0.0°	0.0°	CD..120605
2832281	CCBI18018745R	-5	.188	.208	.104	4.000	.040	0.0°	5.0°	CD..120605
2832276	CCBI18018765R	-5	.188	.208	.104	6.000	.040	0.0°	5.0°	CD..120605
2832183	CCBI18745R	-5	.188	.218	.111	4.000	.040	0.0°	5.0°	CD..120605
2832164	CCBI18765R	-5	.188	.218	.111	6.000	.040	0.0°	5.0°	CD..120605
2832049	CCBI25045R	-5	.250	.285	.145	4.000	.047	0.0°	5.0°	CD..120605
2832029	CCBI25065R	-5	.250	.285	.145	6.000	.047	0.0°	5.0°	CD..120605
2832270	CCBI31265R	-5	.312	.356	.185	6.000	.093	0.0°	5.0°	CD..120605
2832195	CCBI18740R	0	.187	.224	.117	4.000	.040	0.0°	5.0°	CD..120605
2832062	CCBI25040R	0	.250	.292	.152	4.000	.047	0.0°	5.0°	CD..120605
2832234	CCBI31260R	0	.313	.356	.185	6.000	.093	0.0°	5.0°	CD..120605
<b>left hand</b>										
2831945	CCBI16515667L	-7	.156	.180	.095	6.000	.040	0.0°	0.0°	CD..120605
2832287	CCBI18018745L	-5	.188	.208	.104	4.000	.040	0.0°	5.0°	CD..120605
2832190	CCBI18745L	-5	.188	.218	.111	4.000	.040	0.0°	5.0°	CD..120605
2832172	CCBI18765L	-5	.188	.218	.111	6.000	.040	0.0°	5.0°	CD..120605
2832057	CCBI25045L	-5	.250	.285	.145	4.000	.047	0.0°	5.0°	CD..120605
2832033	CCBI25065L	-5	.250	.285	.145	6.000	.047	0.0°	5.0°	CD..120605
2832265	CCBI31265L	-5	.313	.356	.185	6.000	.093	0.0°	5.0°	CD..120605
2832200	CCBI18740L	0	.188	.224	.117	4.000	.040	0.0°	5.0°	CD..120605

INDEXABLE MILLING

SOLID END MILLING

HOLEMAKING

TAPPING

TURNING

## CCBI • STEPPED

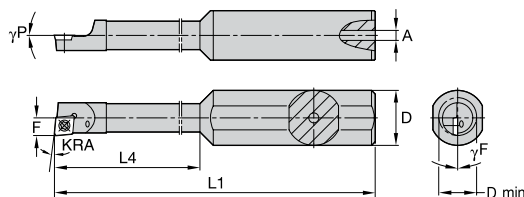

NOTE: KRA shown as -5°.

order number	catalog number	KRA	D	D min	F	L1	L4	A	γF°	γP°	gage insert
<b>right hand</b>											
2832254	CCBI18050018755R	-5	.500	.208	.104	3.375	1.875	.125	0.0°	5.0°	CD..120605
2832241	CCBI1805008755R	-5	.500	.208	.104	2.375	.875	.040	0.0°	5.0°	CD..120605
2832141	CCBI20350015R	-5	.500	.234	.119	2.500	1.000	.040	0.0°	5.0°	CD..S4T002
2832120	CCBI20350025R	-5	.500	.234	.119	3.500	2.000	.125	0.0°	5.0°	CD..120605
2832006	CCBI2505001255R	-5	.500	.285	.145	2.750	1.250	.125	0.0°	5.0°	CD..120605
2832205	CCBI1806258755R	-5	.625	.208	.104	3.375	.875	.125	0.0°	5.0°	CD..120605
2832101	CCBI20362515R	-5	.625	.234	.119	3.500	1.000	.125	0.0°	5.0°	CD..S4T002
2831976	CCBI2506251255R	-5	.625	.285	.145	3.750	1.250	.125	0.0°	5.0°	CD..120605
2832152	CCBI20350010R	0	.500	.234	.125	2.500	1.000	.125	0.0°	5.0°	CD..S4T002
3337598	CCBI2505001250R	0	.500	.292	.152	2.750	1.250	.125	0.0°	5.0°	CD..120605
<b>left hand</b>											
2832247	CCBI1805008755L	-5	.500	.208	.104	2.375	.875	.125	0.0°	5.0°	CD..120605
2832147	CCBI20350015L	-5	.500	.234	.119	2.500	1.000	.125	0.0°	5.0°	CD..S4T002
2832012	CCBI2505001255L	-5	.500	.285	.145	2.750	1.250	.125	0.0°	5.0°	CD..120605
2832211	CCBI1806258755L	-5	.625	.208	.104	3.375	.875	.125	0.0°	5.0°	CD..120605

## QSMI

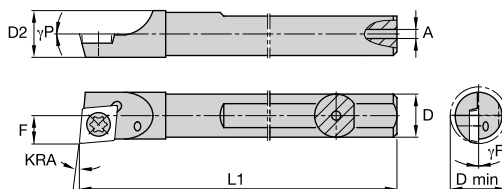

NOTE: KRA shown as -5°.

order number	catalog number	KRA	D	D min	D2	F	L1	A	γF°	γP°	gage insert
<b>right hand</b>											
2825394	QSMI62565R	-5	.625	.670	.635	.343	6.000	.156	0.0°	0.0°	CP..2....
2825464	QSMI37545R	0	.375	.481	.385	.278	3.997	.125	0.0°	0.0°	CP..2....
2825455	QSMI50055R	0	.500	.605	.510	.340	4.997	.156	0.0°	0.0°	CP..2....
<b>left hand</b>											
2825457	QSMI37545L	0	.375	.481	.385	.278	3.997	.125	0.0°	0.0°	CP..2....

NOTE: D min and F calculated using the CPG grooving-style insert.

# Small Hole Boring Bars for Turning

INDEXABLE MILLING

SOLID END MILLING

HOLEMAKING

TAPPING

TURNING

## QCMi

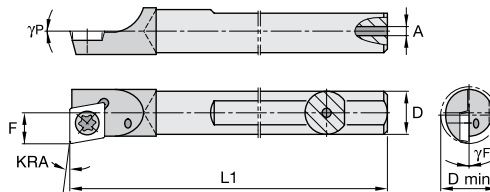

NOTE: KRA shown as -5°.

order number	catalog number	KRA	D	D min	F	L1	A	$\gamma_F^\circ$	$\gamma_P^\circ$	gage insert
<b>right hand</b>										
2825117	QCMi37565R	-5	.375	.420	.218	6.000	.125	0.0°	0.0°	CPHB21205
2825105	QCMi50085R	-5	.500	.545	.280	8.000	.188	0.0°	0.0°	CP..21205
<b>left hand</b>										
2825112	QCMi37565L	-5	.375	.420	.218	6.000	.125	0.0°	0.0°	CP..2..

NOTE: F calculated using the CPG-style insert.

## SSBiC

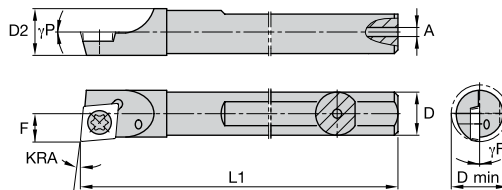

NOTE: KRA shown as -5°.

order number	catalog number	KRA	D	D min	D2	F	L1	A	$\gamma_F^\circ$	$\gamma_P^\circ$	gage insert
<b>right hand</b>											
2822637	SSBiC62575R	-5	.625	.680	.635	.353	7.000	.156	0.0°	0.0°	CP..3252

## SDBiC

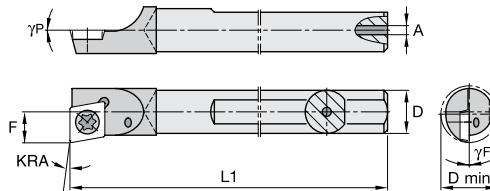

NOTE: KRA shown as -5°.

order number	catalog number	KRA	D	D min	F	L1	A	$\gamma_F^\circ$	$\gamma_P^\circ$	gage insert
<b>right hand</b>										
2822301	SDBiC62565R	-5	.625	.680	.353	6.000	.218	-5.0°	0.0°	CPMT3252
2822289	SDBiC625105R	-5	.625	.680	.353	10.000	.218	-5.0°	0.0°	CPMT3252

## FSBI

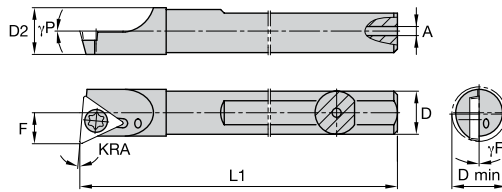

NOTE: KRA shown as  $-5^\circ$ .

order number	catalog number	KRA	D	D min	D2	F	L1	A	$\gamma_F^\circ$	$\gamma_P^\circ$	gage insert
<b>right hand</b>											
2830455	FSBI187355R	-5	.188	.275	.197	.123	3.500	.040	0.0°	5.0°	TD..130805
2830358	FSBI25045R	-5	.250	.296	.260	.156	4.000	.040	0.0°	5.0°	TD..130805
2830260	FSBI31245R	-5	.313	.358	.322	.187	4.000	.060	0.0°	5.0°	TD..130805
<b>left hand</b>											
2830270	FSBI31245L	-5	.313	.358	.322	.187	4.000	.060	0.0°	5.0°	TD..130805

## FSBI • STEPPED

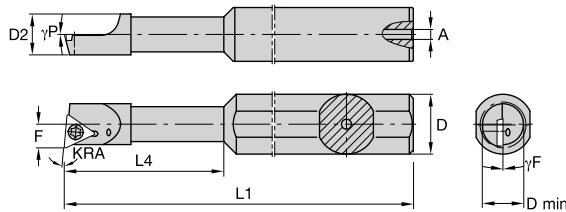

NOTE: KRA shown as  $-5^\circ$ .

order number	catalog number	KRA	D	D min	D2	F	L1	L4	A	$\gamma_F^\circ$	$\gamma_P^\circ$	gage insert
<b>right hand</b>												
2830430	FSBI20350015R	-5	.500	.275	.203	.126	3.000	1.000	.040	0.0°	5.0°	TD..130805
2830405	FSBI20350055R	-5	.500	.275	.203	.126	3.000	.500	.040	0.0°	5.0°	TD..130805
2830335	FSBI2505001255R	-5	.500	.296	.259	.156	3.000	1.250	.040	0.0°	5.0°	TD..130805
2830312	FSBI250500755R	-5	.500	.296	.259	.156	3.000	.750	.040	0.0°	5.0°	TD..130805
2830245	FSBI312500155R	-5	.500	.358	.321	.187	3.000	1.500	.060	0.0°	5.0°	TD..130805
2830212	FSBI31250015R	-5	.500	.358	.321	.187	3.000	1.000	.060	0.0°	5.0°	TD..130805
2830380	FSBI20362555R	-5	.625	.275	.203	.126	4.000	.500	.040	0.0°	5.0°	TD..130805
2830284	FSBI250625755R	-5	.625	.296	.259	.156	4.000	.750	.040	0.0°	5.0°	TD..130805
2830189	FSBI312625155R	-5	.625	.358	.321	.187	4.000	1.500	.060	0.0°	5.0°	TD..130805
2830185	FSBI31262515R	-5	.625	.358	.321	.187	4.000	1.000	.060	0.0°	5.0°	TD..130805
2830417	FSBI20350050R	0	.500	.275	.203	.134	3.000	.500	.040	0.0°	5.0°	TD..130805
2830329	FSBI250500750R	0	.500	.296	.259	.156	3.000	.750	.040	0.0°	5.0°	TD..130805
<b>left hand</b>												
2830324	FSBI250500755L	-5	.500	.296	.259	.156	3.000	.750	.040	0.0°	5.0°	TD..130805
3383045	FSBI2506251250L	0	.625	.296	.259	.156	4.000	1.250	.040	0.0°	5.0°	TD..130805

# Small Hole Boring Bars for Turning

INDEXABLE MILLING

SOLID END MILLING

HOLEMAKING

TAPPING

TURNING

## FCBI

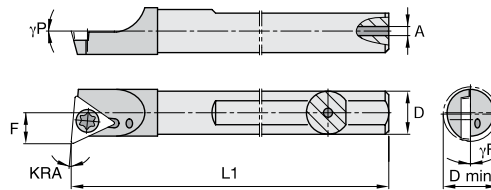

NOTE: KRA shown as -5°.

order number	catalog number	KRA	D	D min	F	L1	A	$\gamma F^\circ$	$\gamma P^\circ$	gage insert
<b>right hand</b>										
2830020	FCBI18745R	-5	.188	.275	.126	4.000	.040	0.0°	5.0°	TD..130805
2829995	FCBI18765R	-5	.188	.275	.126	6.000	.040	0.0°	5.0°	TD..130805
2829897	FCBI25045R	-5	.250	.296	.156	4.000	.047	0.0°	5.0°	TD..130805
2829764	FCBI31265R	-5	.312	.358	.187	6.000	.093	0.0°	5.0°	TD..130805
2829881	FCBI25065R	-5	.250	.296	.156	6.000	.047	0.0°	5.0°	TDHB130805
2829787	FCBI31245R	-5	.312	.358	.187	4.000	.093	0.0°	5.0°	TDHB130805
2830032	FCBI18740R	0	.188	.275	.134	4.000	.040	0.0°	5.0°	TD..130805
2829908	FCBI25040R	0	.250	.296	.156	4.000	.047	0.0°	5.0°	TD..130805
2829892	FCBI25060R	0	.250	.296	.156	6.000	.047	0.0°	5.0°	TD..130805
2829799	FCBI31240R	0	.313	.358	.187	4.000	.093	0.0°	5.0°	TD..130805
2829777	FCBI31260R	0	.313	.358	.187	6.000	.093	0.0°	5.0°	TD..130805
<b>left hand</b>										
2830027	FCBI18745L	-5	.187	.275	.126	4.000	.040	0.0°	5.0°	TD..130805
2829903	FCBI25045L	-5	.250	.296	.156	4.000	.047	0.0°	5.0°	TD..130805
2829793	FCBI31245L	-5	.312	.358	.187	4.000	.093	0.0°	5.0°	TD..130805
2829770	FCBI31265L	-5	.312	.358	.187	6.000	.093	0.0°	5.0°	TD..130805

## FCBI • STEPPED

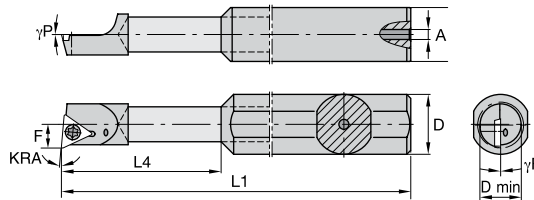

order number	catalog number	KRA	D	D min	F	L1	L4	A	$\gamma F^\circ$	$\gamma P^\circ$	gage insert
<b>right hand</b>											
2829979	FCBI20350015R	-5	.500	.275	.126	2.500	1.000	.125	0.0°	5.0°	TD..130805
2829857	FCBI2505001255R	-5	.500	.296	.156	2.750	1.250	.250	0.0°	5.0°	TD..130805
2829740	FCBI312500155R	-5	.500	.358	.187	3.000	1.500	.125	0.0°	5.0°	TD..130805
2829942	FCBI20362515R	-5	.625	.275	.126	3.500	1.000	.125	0.0°	5.0°	TD..130805
2829828	FCBI2506251255R	-5	.625	.296	.156	3.750	1.250	.250	0.0°	5.0°	TD..130805
2829704	FCBI312625155R	-5	.625	.358	.187	4.000	1.500	.125	0.0°	5.0°	TD..130805
2829751	FCBI312500150R	0	.500	.358	.187	3.000	1.500	.125	0.0°	5.0°	TD..130805
<b>left hand</b>											
2829835	FCBI2506251255L	-5	.625	.296	.156	3.750	1.250	.125	0.0°	5.0°	TD..130805

## FSRI

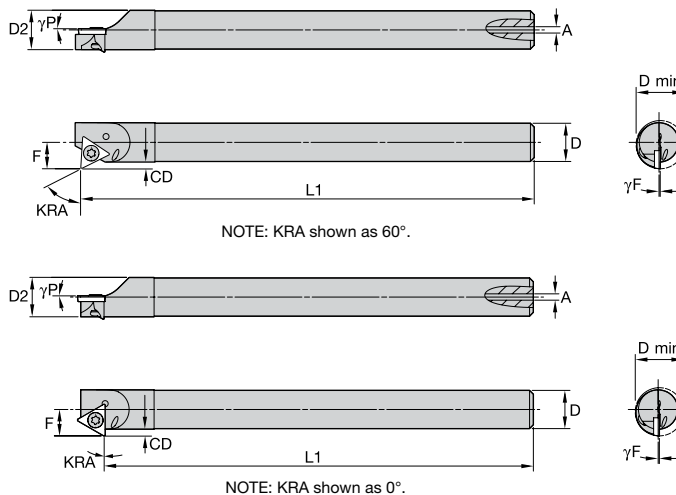

order number	catalog number	KRA	D	D min	D2	F	L1	CD	A	$\gamma_F^\circ$	$\gamma_P^\circ$	gage insert
right hand												
2830138	FSRI312350R	0	.313	.394	.322	.223	3.500	.062	.040	0.0°	0.0°	TD..130805
2830120	FSRI3123560R	30	.313	.407	.322	.236	3.500	.075	.040	0.0°	0.0°	TD..130805

## QSBI

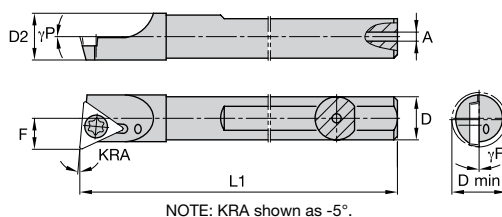

order number	catalog number	KRA	D	D min	D2	F	L1	A	$\gamma_F^\circ$	$\gamma_P^\circ$	gage insert
right hand											
2825910	QSBI37555R	-5	.375	.438	.385	.221	5.000	.125	0.0°	5.0°	TP..21505
2825774	QSBI50065R	-5	.500	.563	.510	.296	6.000	.156	0.0°	5.0°	TP..21505
2825923	QSBI37550R	0	.375	.438	.385	.221	5.000	.125	0.0°	5.0°	TP..21505
2825788	QSBI50060R	0	.500	.563	.510	.296	6.000	.156	0.0°	5.0°	TP..21505
left hand											
2825917	QSBI37555L	-5	.375	.438	.385	.221	5.000	.125	0.0°	5.0°	TP..21505
2825781	QSBI50065L	-5	.500	.563	.510	.296	6.000	.156	0.0°	5.0°	TP..21505

## QSBI • STEPPED

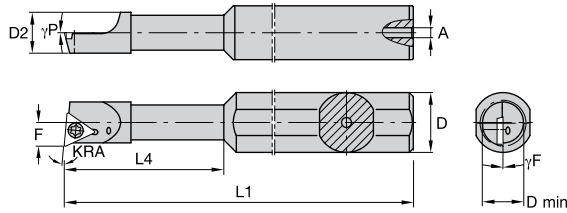

NOTE: KRA shown as -5°.

order number	catalog number	KRA	D	D min	D2	F	L1	L4	A	γF°	γP°	gage insert
<b>right hand</b>												
2825884	QSBI37550011255R	-5	.500	.438	.390	.221	3.750	1.125	.080	0.0°	5.0°	TP..21505
2825854	QSBI37550018755R	-5	.500	.438	.390	.221	3.750	1.875	.080	0.0°	5.0°	TP..21505
2825832	QSBI37562511255R	-5	.625	.438	.390	.221	4.250	1.125	.080	0.0°	5.0°	TP..21505
2825816	QSBI37562518755R	-5	.625	.438	.390	.221	4.250	1.875	.080	0.0°	5.0°	TP..21505
2825753	QSBI500625155R	-5	.625	.563	.510	.296	4.250	1.500	.156	0.0°	5.0°	TP..21505
2825801	QSBI375750155R	-5	.750	.438	.390	.221	4.000	1.500	.080	0.0°	5.0°	TP..21505
2825720	QSBI625750255R	-5	.750	.688	.625	.353	4.500	2.500	.098	0.0°	5.0°	TP..21505
2825897	QSBI37550011250R	0	.500	.438	.390	.221	3.750	1.125	.080	0.0°	5.0°	TP..21505
<b>left hand</b>												
2825760	QSBI500625155L	-5	.625	.563	.510	.296	4.250	1.500	.156	0.0°	5.0°	TP..21505
3783153	QSBI500625255L	-5	.625	.563	.510	.296	4.250	2.500	.156	0.0°	5.0°	TP..21505

## QCBI

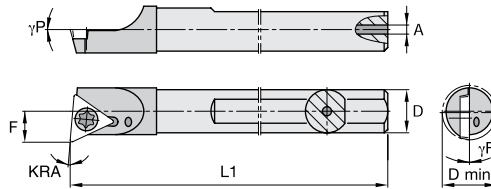

NOTE: KRA shown as -5°.

order number	catalog number	KRA	D	D min	F	L1	A	γF°	γP°	gage insert
<b>right hand</b>										
2825290	QCBI37565R	-5	.375	.438	.228	6.000	.125	0.0°	5.0°	TP..21505
2825265	QCBI375105R	-5	.375	.438	.228	10.000	.125	0.0°	5.0°	TP..21505
2825272	QCBI50085R	-5	.500	.563	.296	8.000	.188	0.0°	5.0°	TP..21505
2825232	QCBI500105R	-5	.500	.563	.296	10.000	.188	0.0°	5.0°	TP..21505
2825304	QCBI37560R	0	.375	.438	.228	6.000	.125	0.0°	5.0°	TP..21505
2825285	QCBI50080R	0	.500	.563	.296	8.000	.188	0.0°	5.0°	TP..21505
<b>left hand</b>										
2825297	QCBI37565L	-5	.375	.438	.228	6.000	.125	0.0°	5.0°	TP..21505
2825278	QCBI50085L	-5	.500	.563	.296	8.000	.188	0.0°	5.0°	TP..21505

## QSOI

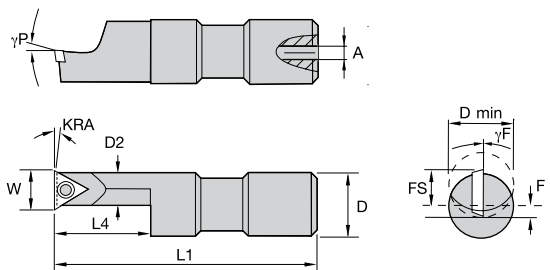

NOTE: KRA shown as  $-5^\circ$ .

order number	catalog number	KRA	D	D min	D2	F	L1	L4	FS	W	A	$\gamma F^\circ$	$\gamma P^\circ$	gage insert
<b>right hand</b>														
2825640	QSOI375750155R	-5	.750	.750	.375	.023	3.750	1.500	—	—	.080	0.0°	5.0°	TP..21505
2825660	QSOI3126251250R	0	.625	.606	.312	.055	3.125	1.250	.156	.422	.060	0.0°	5.0°	TP..21505
2825647	QSOI375750150R	0	.750	.750	.375	.024	3.750	1.500	.188	.423	.080	0.0°	5.0°	TP..21505

## SSBI

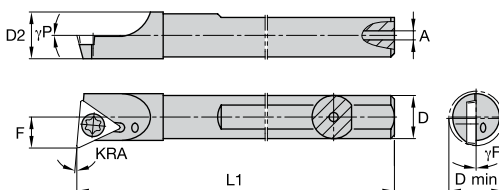

NOTE: KRA shown as  $-5^\circ$ .

order number	catalog number	KRA	D	D min	D2	F	L1	A	$\gamma F^\circ$	$\gamma P^\circ$	gage insert
<b>right hand</b>											
2823053	SSBI500255R	-5	.500	.668	.572	.339	2.500	.156	0.0°	5.0°	TP..3205
2823025	SSBI50065R	-5	.500	.668	.572	.339	6.000	.156	0.0°	5.0°	TP..3205
2822980	SSBI62545R	-5	.625	.720	.635	.393	4.000	.156	0.0°	5.0°	TP..3205
2822947	SSBI62575R	-5	.625	.720	.635	.393	7.000	.156	0.0°	5.0°	TP..3205
2822921	SSBI75045R	-5	.750	.850	.760	.460	4.000	.156	0.0°	5.0°	TP..3205
2822898	SSBI75085R	-5	.750	.850	.760	.460	8.000	.156	0.0°	5.0°	TP..3205
2823121	SSBI1000105R	-5	1.000	1.100	1.010	.585	10.000	.250	0.0°	5.0°	TP..3205
2823096	SSBI100055R	-5	1.000	1.100	1.010	.585	5.000	.250	0.0°	5.0°	TP..3205
2822935	SSBI75040R	0	.750	.850	.760	.460	4.000	.156	0.0°	5.0°	TP..3205
<b>left hand</b>											
2823032	SSBI50065L	-5	.500	.668	.572	.339	6.000	.156	0.0°	5.0°	TP..3205
2822987	SSBI62545L	-5	.625	.720	.635	.393	4.000	.156	0.0°	5.0°	TP..3205
2822954	SSBI62575L	-5	.625	.720	.635	.393	7.000	.156	0.0°	5.0°	TP..3205
2822901	SSBI75085L	-5	.750	.850	.760	.460	8.000	.156	0.0°	5.0°	TP..3205



# Small Hole Boring Bars for Turning

INDEXABLE MILLING

SOLID END MILLING

HOLEMAKING

TAPPING

TURNING

## SCBI

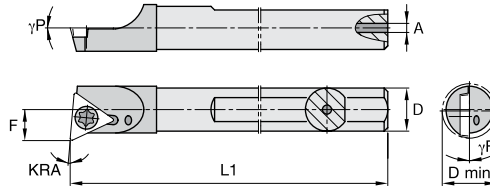

NOTE: KRA shown as -5°.

order number	catalog number	KRA	D	D min	F	L1	A	$\gamma F^\circ$	$\gamma P^\circ$	gage insert
<b>right hand</b>										
2822500	SCBI62565R	-5	.625	.720	.393	6.000	.218	0.0°	5.0°	TP..3205
2822515	SCBI625105R	-5	.625	.720	.393	10.000	.218	0.0°	5.0°	TP..3205
2822454	SCBI75065R	-5	.750	.850	.460	6.000	.281	0.0°	5.0°	TP..3205
2822479	SCBI750105R	-5	.750	.850	.460	10.000	.281	0.0°	5.0°	TP..3205
2822561	SCBI1000125R	-5	1.000	1.100	.585	12.000	.312	0.0°	5.0°	TP..3205
<b>left hand</b>										
2822503	SCBI62565L	-5	.625	.720	.393	6.000	.218	0.0°	5.0°	TP..3205
2822460	SCBI75065L	-5	.750	.850	.460	6.000	.281	0.0°	5.0°	TP..3205

## SSOI

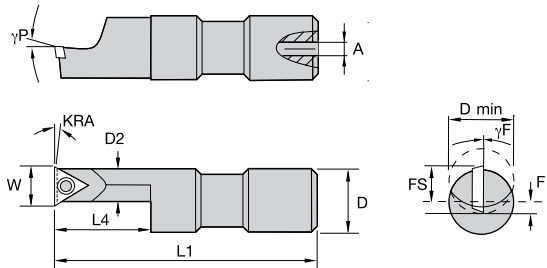

NOTE: KRA shown as -5°.

order number	catalog number	KRA	D	D min	D2	F	L1	L4	FS	W	A	$\gamma F^\circ$	$\gamma P^\circ$	gage insert
<b>right hand</b>														
2822843	SSOI5001000255R	-5	1.000	.969	.500	.070	4.750	2.500	—	—	.118	0.0°	5.0°	TP..3205
2822857	SSOI5001000150R	0	1.000	.969	.500	.070	3.750	1.500	.250	.640	.118	0.0°	5.0°	TP..3205
2822850	SSOI5001000250R	0	1.000	.969	.500	.070	4.750	2.500	.250	.640	.118	0.0°	5.0°	TP..3205

## QSRI

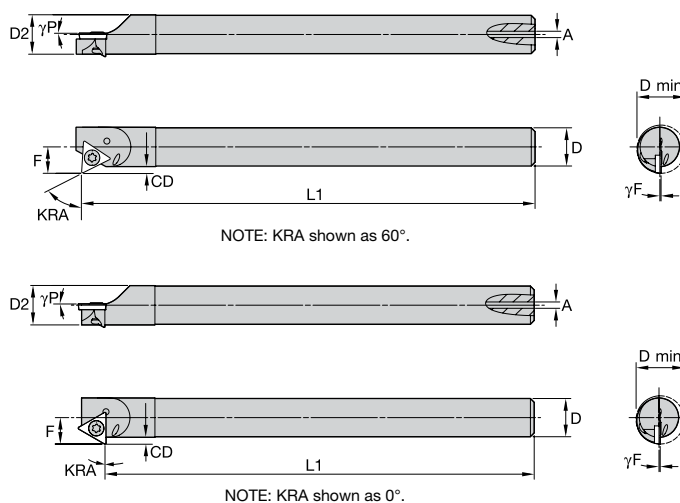

order number	catalog number	KRA	D	D min	D2	F	L1	CD	A	γF°	γP°	gage insert
right hand												
2825633	QSRI375450R	0	.375	.492	.370	.287	4.500	.102	.125	0.0°	0.0°	TP..21505
2825605	QSRI50050R	0	.500	.645	.510	.380	5.000	.125	.156	0.0°	0.0°	TP..21505
2825614	QSRI375560R	30	.375	.525	.390	.320	5.000	.125	.125	0.0°	0.0°	TP..21505
2825587	QSRI500660R	30	.500	.645	.510	.380	6.000	.125	.156	0.0°	0.0°	TP..21505
2825621	QSRI375545R	45	.375	.525	.390	.320	5.000	.125	.125	0.0°	0.0°	TP..21505
2825594	QSRI500645R	45	.500	.645	.510	.380	6.000	.125	.156	0.0°	0.0°	TP..21505

## GSBIW

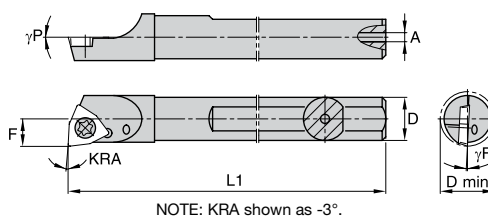

order number	catalog number	KRA	D	D min	D2	F	L1	A	γF°	γP°	gage insert
right hand											
2828170	GSBIW18743R	-3	.188	.260	.228	.126	4.000	.040	-3.0°	0.0°	WP..1511
2828161	GSBIW25043R	-3	.250	.285	.260	.142	4.000	.040	-3.0°	0.0°	WP..1511
2828145	GSBIW31243R	-3	.313	.347	.322	.174	4.000	.040	-3.0°	0.0°	WP..1511

# Small Hole Boring Bars for Turning

INDEXABLE MILLING

SOLID END MILLING

HOLEMAKING

TAPPING

TURNING

## QSB IW

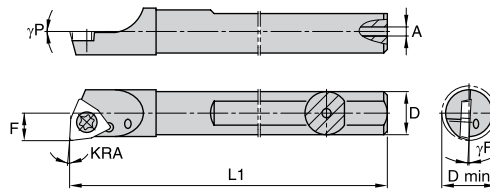

NOTE: KRA shown as  $-3^\circ$ .

order number	catalog number	KRA	D	D min	D2	F	L1	A	$\gamma_F^\circ$	$\gamma_P^\circ$	gage insert
right hand											
2825364	QSB IW37553R	-3	.375	.413	.385	.211	5.000	.093	$-3.0^\circ$	$0.0^\circ$	WP..2151
2825351	QSB IW50063R	-3	.500	.538	.510	.272	6.000	.156	$-3.0^\circ$	$0.0^\circ$	WP..2151

## SSB IW

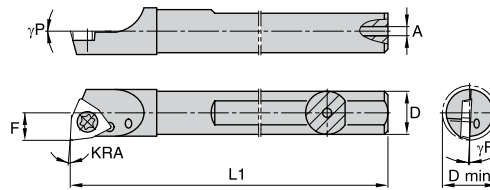

NOTE: KRA shown as  $-3^\circ$ .

order number	catalog number	KRA	D	D min	D2	F	L1	A	$\gamma_F^\circ$	$\gamma_P^\circ$	gage insert
right hand											
2823167	SSB IW62573R	-3	.625	.673	.635	.345	7.000	.156	$-3.0^\circ$	$0.0^\circ$	WP..3251
2823155	SSB IW75083R	-3	.750	.797	.760	.407	8.000	.156	$-3.0^\circ$	$0.0^\circ$	WP..321

## SCB IW

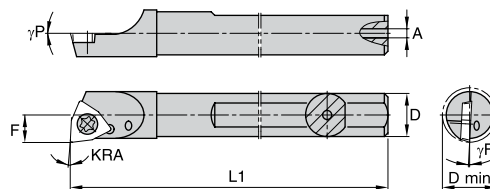

NOTE: KRA shown as  $-3^\circ$ .

order number	catalog number	KRA	D	D min	F	L1	A	$\gamma_F^\circ$	$\gamma_P^\circ$	gage insert	
right hand											
2822603	SCB IW625103R	-3	.625	.673	.345	10.000	.218	$-3.0^\circ$	$0.0^\circ$	WP..3251	
2822591	SCB IW750103R	-3	.750	.797	.407	10.000	.281	$-3.0^\circ$	$0.0^\circ$	WP..321	

## QCBIW

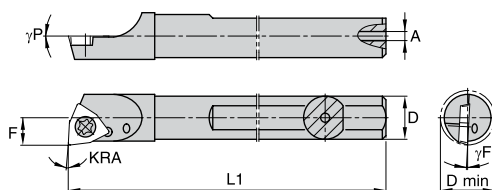

NOTE: KRA shown as  $-3^\circ$ .

order number	catalog number	KRA	D	D min	F	L1	A	$\gamma_F^\circ$	$\gamma_P^\circ$	gage insert
<b>right hand</b>										
2825335	QCBIW37563R	-3	.375	.413	.211	6.000	.125	$-3.0^\circ$	$0.0^\circ$	WP..2151
2825324	QCBIW50083R	-3	.500	.538	.273	8.000	.188	$0.0^\circ$	$0.0^\circ$	WP..2151
<b>left hand</b>										
2825327	QCBIW37563L	-3	.375	.413	.211	6.000	.125	$-3.0^\circ$	$0.0^\circ$	WP..2151
2825318	QCBIW50083L	-3	.500	.538	.273	8.000	.188	$0.0^\circ$	$0.0^\circ$	WP..2151

## GCB IW

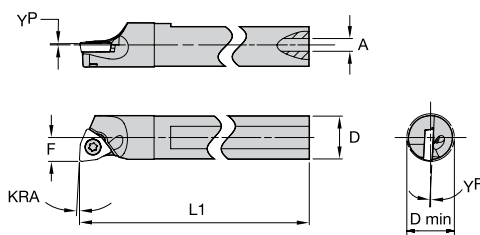

NOTE: KRA shown as  $-3^\circ$ .

order number	catalog number	KRA	D	D min	F	L1	A	$\gamma_F^\circ$	$\gamma_P^\circ$	gage insert
<b>right hand</b>										
2827756	GCB IW18763R	-3	.188	.260	.126	6.000	.040	$-3.0^\circ$	$0.0^\circ$	WP..1511
2827743	GCB IW25063R	-3	.250	.285	.143	6.000	.047	$-3.0^\circ$	$0.0^\circ$	WP..1511
2827734	GCB IW31263R	-3	.312	.347	.174	6.000	.093	$-3.0^\circ$	$0.0^\circ$	WP..1511
<b>left hand</b>										
2827727	GCB IW31263L	-3	.312	.347	.174	6.000	.093	$-3.0^\circ$	$0.0^\circ$	WP..1511

# Small Hole Boring Bars for Profiling

## CSPI

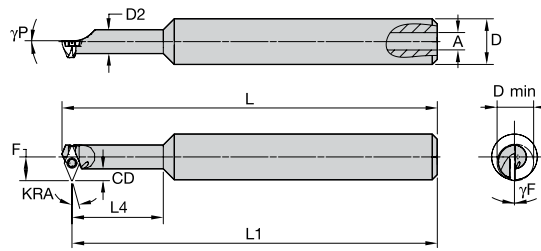

NOTE: KRA shown as 22.5°.

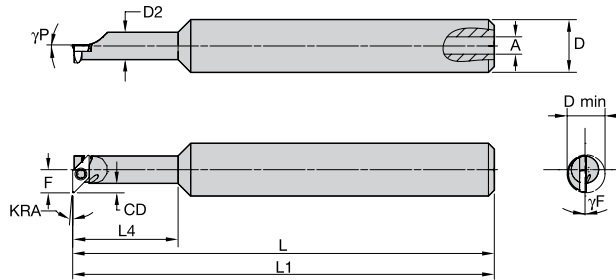

NOTE: KRA shown as -5°.

order number	catalog number	KRA	D	D min	D2	F	CD	L	L1	L4	A	$\gamma_F^\circ$	$\gamma_P^\circ$	gage insert
<b>right hand</b>														
2832344	CSPI25050015R	-5.0	.500	.360	.260	.220	.090	4.000	4.000	1.000	.040	0.0°	0.0°	GP..12105
2832334	CSPI3125001255R	-5.0	.500	.423	.323	.251	.090	4.000	4.000	1.250	.040	0.0°	0.0°	GP..12105
2832297	CSPI25050010R	.0	.500	.360	.260	.220	.090	4.000	4.000	1.000	.040	0.0°	0.0°	GPHW12105
2832319	CSPI2505001225R	22.5	.500	.400	.260	.260	.130	4.080	4.000	1.000	.040	0.0°	0.0°	GP..12105
<b>left hand</b>														
2832326	CSPI3125001255L	-5.0	.500	.423	.323	.251	.090	4.000	4.000	1.250	.040	0.0°	0.0°	GP..12105

INDEXABLE MILLING

SOLID END MILLING

HOLEMAKING

TAPPING

TURNING

## CCPI

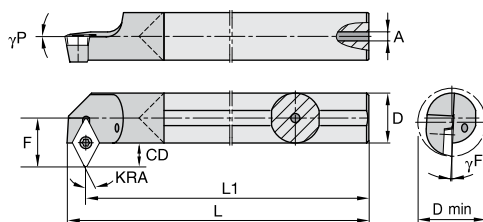

NOTE: KRA shown as 22.5°.

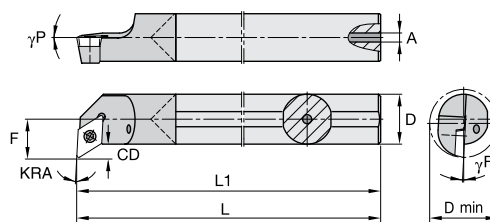

NOTE: KRA shown as -5°.

order number	catalog number	KRA	D	D min	F	CD	L	L1	A	$\gamma_F^\circ$	$\gamma_P^\circ$	gage insert
<b>right hand</b>												
2831774	CCPI25065R	-5.0	.250	.360	.220	.091	6.000	6.000	.047	0.0°	0.0°	GP..12105
2831762	CCPI31265R	-5.0	.313	.423	.251	.091	6.000	6.000	.093	0.0°	0.0°	GP..12105
2831727	CCPI25060R	.0	.250	.360	.220	.091	6.000	6.000	.047	0.0°	0.0°	GP..12105
2831739	CCPI3126225R	22.5	.313	.448	.276	.116	6.101	6.000	.093	0.0°	0.0°	GP..12105
<b>left hand</b>												
2831767	CCPI25065L	-5.0	.250	.360	.220	.091	6.000	6.000	.047	0.0°	0.0°	GP..12105

INDEXABLE MILLING

SOLID END MILLING

HOLE/MAKING

TAPPING

TURNING

# Small Hole Boring Bars for Profiling

INDEXABLE MILLING

SOLID END MILLING

HOLEMAKING

TAPPING

TURNING

## GSPI

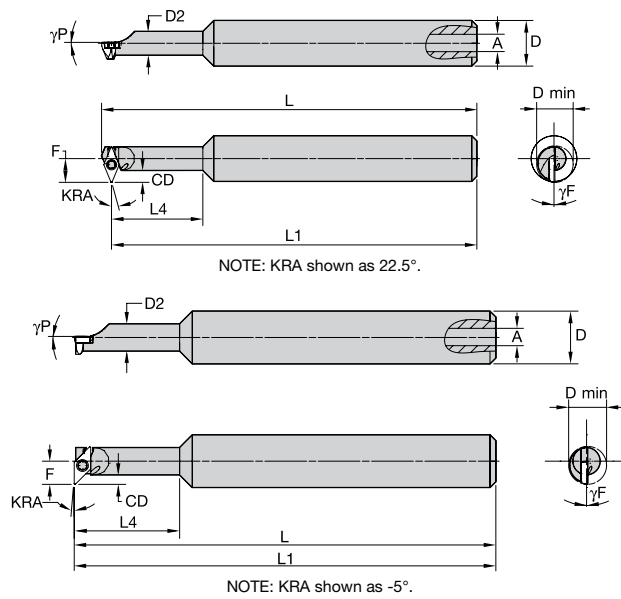

order number	catalog number	KRA	D	D min	D2	F	CD	L	L1	L4	A	$\gamma F^\circ$	$\gamma P^\circ$	gage insert
<b>right hand</b>														
2828281	GSPI375625155R	-5.0	.625	.515	.385	.312	.120	4.500	4.500	1.500	.098	0.0°	0.0°	GC..151505
2828269	GSPI50075025R	-5.0	.750	.630	.510	.374	.119	5.000	5.000	2.000	.098	0.0°	0.0°	GC..151505
2828203	GSPI50075020R	.0	.750	.630	.510	.374	.119	5.000	5.000	2.000	.098	0.0°	0.0°	GC..151505
2828310	GSPI37562515225R	22.5	.625	.540	.385	.338	.146	4.134	4.000	1.500	.098	0.0°	0.0°	GC..151505
<b>left hand</b>														
2828275	GSPI375625155L	-5.0	.625	.515	.385	.312	.120	4.500	4.500	1.500	.098	0.0°	0.0°	GC..151505

## GCPI

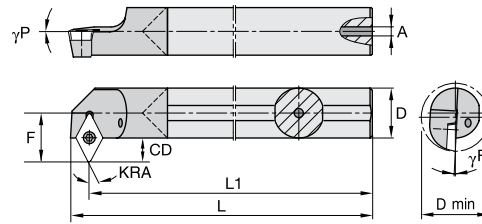

NOTE: KRA shown as 22.5°.

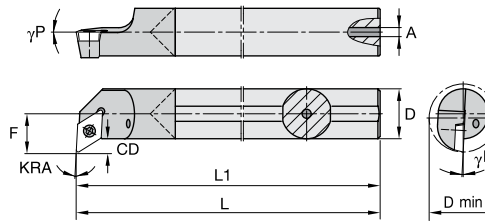

NOTE: KRA shown as -5°.

order number	catalog number	KRA	D	D min	F	CD	L	L1	A	$\gamma_F^\circ$	$\gamma_P^\circ$	gage insert
right hand												
2827811	GCPI50085R	-5.0	.500	.640	.374	.120	8.000	8.000	.188	0.0°	0.0°	GC..151505
2827800	GCPI625105R	-5.0	.625	.765	.437	.121	10.000	10.000	.218	0.0°	0.0°	GC..151505
2827775	GCPI37560R	.0	.375	.515	.312	.121	6.000	6.000	.125	0.0°	0.0°	GC..151505
2827825	GCPI37565R	.0	.375	.515	.312	.121	6.000	6.000	.125	0.0°	0.0°	GC..151505
2827767	GCPI50080R	.0	.500	.640	.374	.120	8.000	8.000	.188	0.0°	0.0°	GC..151505
2827845	GCPI3756225R	22.5	.375	5.400	.338	.147	6.134	6.000	.125	0.0°	0.0°	GC..151505

## CTPI

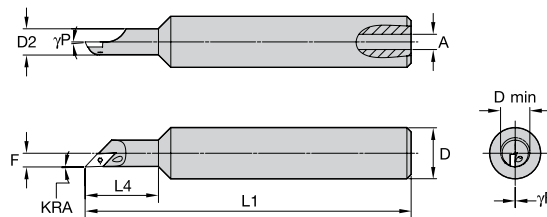

NOTE: KRA shown as -2°.

order number	catalog number	KRA	D	D min	D2	F	L1	L4	A	$\gamma_F^\circ$	$\gamma_P^\circ$	gage insert
right hand												
2828101	CTPI32262590647R	-2.0	.625	.339	.322	.168	4.000	.900	.187	0.0°	0.0°	GP..12105



## GTPI

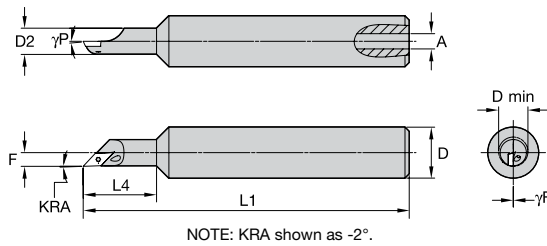

order number	catalog number	KRA	D	D min	D2	F	L1	L4	A	$\gamma_F^\circ$	$\gamma_P^\circ$	gage insert
right hand 2828184	GTPI37562590647R	-2.0	.625	.625	.375	.236	4.000	.900	.187	0.0°	-3.0°	GC..151505

## Setup Recommendations

### Setup Recommendations for Bar Overhang

WIDIA-CIRCLE® cutting tools are the finest quality boring, grooving, profiling, and threading tools available. For more than 50 years, WIDIA-CIRCLE has been the industry leader in solving small-diameter hole machining problems in major manufacturing plants worldwide.

A common problem associated with any cutting tool is extending the tool beyond its support point. This condition of excessive overhang can cause chatter, poor finishes, or inadequate tool life.

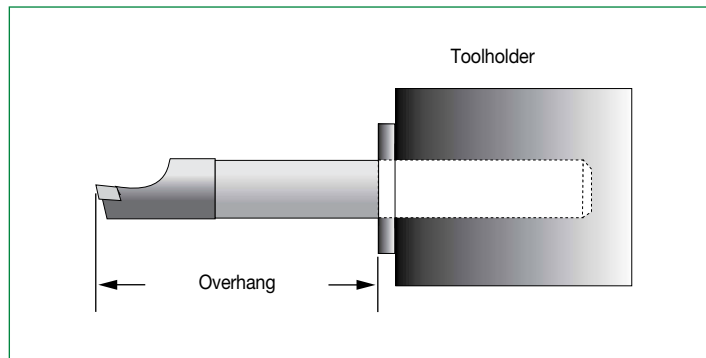

We recommend a 4:1 ratio (4 times bar diameter) overhang when using steel shank bars and up to a 10:1 (10 times bar diameter) overhang when using carbide shank bars. The overhang ratios are affected by many factors:

- Type(s) of material(s) being machined.
- Depth of cut(s).
- Feed rate(s).

Recommended conditions may still be unsatisfactory because of chatter. Chatter can be induced by non-rigid setups or harmonics from the machine or machining conditions. In many cases, changing the RPM of the machine can reduce chatter.

shank diameter (inch)	steel shank ratio 4:1 (inch)	carbide shank ratio 10:1 (inch)
0.156"	0.625"	1.560"
0.187"	0.748"	1.187"
0.250"	1.000"	2.500"
0.375"	1.500"	3.750"
0.500"	2.000"	5.000"
0.625"	2.500"	6.250"
0.750"	3.000"	7.500"
0.875"	3.500"	8.750"
1.000"	4.000"	10.000"
1.250"	5.000"	12.500"

shank diameter (mm)	steel shank ratio 4:1 (mm)	carbide shank ratio 10:1 (mm)
4,00mm	16,00mm	40,00mm
5,00mm	20,00mm	50,00mm
6,00mm	24,00mm	60,00mm
8,00mm	32,00mm	80,00mm
10,00mm	40,00mm	100,00mm
12,00mm	48,00mm	120,00mm
16,00mm	64,00mm	160,00mm
20,00mm	80,00mm	200,00mm
25,00mm	100,00mm	250,00mm
32,00mm	128,00mm	320,00mm

# Small Hole Boring Bars for Grooving and Threading

## CSMI

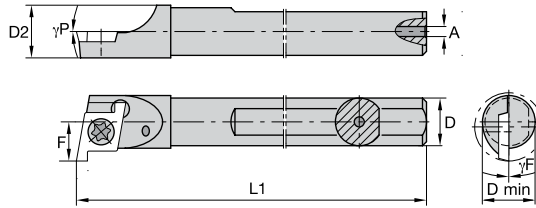

order number	catalog number	D	D min	D2	F	L1	A	γF°	γP°	gage insert
<b>right hand</b>										
2832353	CSMI187250R	.188	.272	.219	.154	2.500	.040	0.0°	0.0°	CD.5..
2832348	CSMI25030R	.250	.312	.260	.175	3.000	.040	0.0°	0.0°	CD.5..

## CCMI

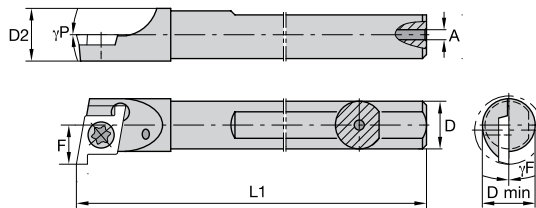

order number	catalog number	D	D min	D2	F	L1	A	γF°	γP°	gage insert
<b>right hand</b>										
2831841	CCMI18740R	.187	.272	.208	.154	4.000	.040	0.0°	0.0°	CD.5..
2831838	CCMI25040R	.250	.312	.258	.175	4.000	.047	0.0°	0.0°	CD.5..

## QSMI

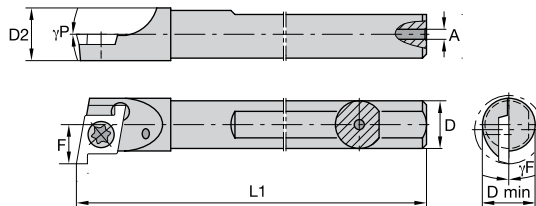

order number	catalog number	KRA	D	D min	D2	F	L1	A	γF°	γP°	gage insert
<b>right hand</b>											
2825394	QSMI62565R	-5	.625	.670	.635	.343	6.000	.156	0.0°	0.0°	CP..2....
2825464	QSMI37545R	0	.375	.481	.385	.278	3.997	.125	0.0°	0.0°	CP..2....
2825455	QSMI50055R	0	.500	.605	.510	.340	4.997	.156	0.0°	0.0°	CP..2....
<b>left hand</b>											
2825457	QSMI37545L	0	.375	.481	.385	.278	3.997	.125	0.0°	0.0°	CP..2....

NOTE: D min and F calculated using the CPG grooving-style insert.  
Refer to insert design for cutting depth, cutting width, and blind hole limitations.

# Small Hole Boring Bars for Grooving and Threading

INDEXABLE MILLING

SOLID END MILLING

HOLEMAKING

TAPPING

TURNING

## QCM1

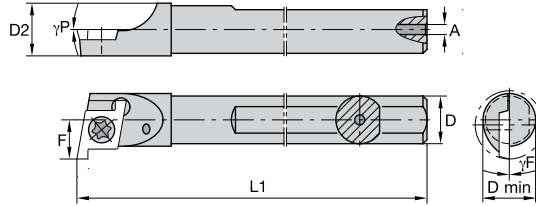

order number	catalog number	KRA	D	D min	F	L1	A	$\gamma F^\circ$	$\gamma P^\circ$	gage insert
<b>right hand</b>										
2825117	QCM137565R	-5	.375	.420	.218	6.000	.125	0.0°	0.0°	CPHB21205
2825105	QCM150085R	-5	.500	.545	.280	8.000	.188	0.0°	0.0°	CP..21205
<b>left hand</b>										
2825112	QCM137565L	-5	.375	.420	.218	6.000	.125	0.0°	0.0°	CP..2..

NOTE: F calculated using the CPG-style insert.  
Refer to insert design for cutting depth, cutting width, and blind hole limitations.

## FSII

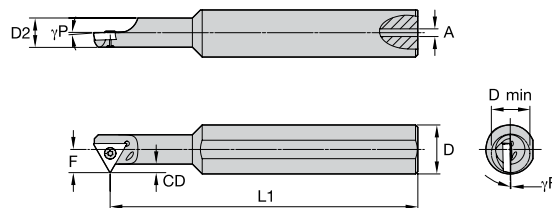

order number	catalog number	D	D min	D2	F	L1	CD	A	$\gamma F^\circ$	$\gamma P^\circ$	gage insert
<b>right hand</b>											
2830177	FSII25062512560R	.625	.322	.250	.155	4.000	.060	.040	0.0°	-2.0°	TB..1308X0
2830171	FSII2506257560R	.625	.322	.250	.155	4.000	.060	.040	0.0°	-2.0°	TB..1308X0

## QSII

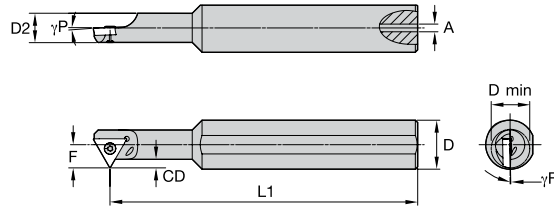

order number	catalog number	D	D min	D2	F	L1	CD	A	γF°	γP°	gage insert
right hand											
2825707	QSII375625187560R	.625	.468	.375	.234	4.000	.093	.098	0.0°	-2.0°	TB..2150
2825693	QSII375625112560R	.625	.478	.375	.234	4.000	.093	.098	0.0°	-2.0°	TB..2150
2825679	QSII5006251560R	.625	.603	.501	.297	4.000	.093	.098	0.0°	-2.0°	TB..2150

## SSII

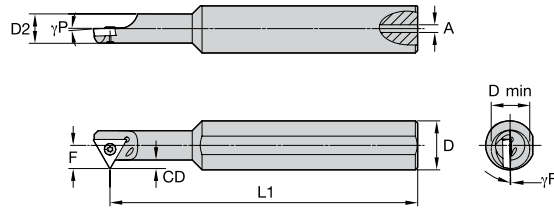

order number	catalog number	D	D min	D2	F	L1	CD	A	γF°	γP°	gage insert
right hand											
2822864	SSII750860R	.750	.935	.760	.548	8.000	.168	.156	0.0°	-2.0°	TP..3205

## CSI

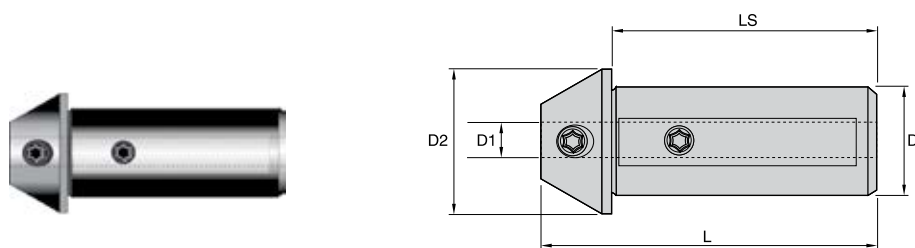

order number	catalog number	D1	D	D2	LS	L
2832898	CSI750187	.188	.750	1.100	2.000	2.500
2832795	CSI1000187	.188	1.000	1.100	2.000	2.500
2832893	CSI750250	.250	.750	1.100	2.000	2.500
2832790	CSI1000250	.250	1.000	1.100	2.000	2.500
2832885	CSI750312	.313	.750	1.100	2.000	2.500
2832785	CSI1000312	.313	1.000	1.100	2.000	2.500
2832844	CSI625375	.375	.625	1.100	2.000	2.500
2832879	CSI750375	.375	.750	1.100	2.000	2.500
2832780	CSI1000375	.375	1.000	1.100	2.000	2.500
2832874	CSI750500	.500	.750	1.100	2.000	2.500
2832775	CSI1000500	.500	1.000	1.100	2.000	2.500

INDEXABLE MILLING

SOLID END MILLING

HOLEMAKING

TAPPING

TURNING



The most versatile tool in the market for grooving, profiling, and cut-off operations.



### 4 BENEFITS IN 1

#### VERSATILITY

Single-sided versatile grooving, cut-off, and profiling solution for all materials.

#### STABILITY

Secure seating and clamping for reliability in demanding groove-turn applications.

#### PRODUCTIVITY

Higher speeds and feeds due to better chip evacuation and low cutting forces. Optimized chip breaker design and through coolant capability.

#### SIMPLICITY

Easy to select and apply for all grooving, cut-off, and profiling applications.

#### GROOVING

PRECISION MOLDED AND GROUND



P M N S

PT-Positive Rake

PRECISION MOLDED



P M K H

PN-Negative Rake

#### CUT-OFF

PRECISION MOLDED AND GROUND



P M N S

F-Fine

PRECISION MOLDED



P K

M-Medium



P M

R-Rough

#### PROFILING

PRECISION GROUND





P M N S

PC-Full Radius

NOTE: Use the NOVO™ software to select appropriate toolholder and insert.

# WIDIA GROOVING AND CUT-OFF

## INSERTS

APPLICATION	TYPES	GROOVE WIDTH	INSERT GEOMETRY	MATERIALS
<b>GROOVING</b>		2.00–10.13mm (0.084–0.399")	PT-Positive Rake	<b>P M K N S</b>
			PN-Negative Rake	<b>P M K S</b>
<b>CUT-OFF</b>		1.4–8.0mm (0.055–0.315")	F-Fine	<b>P M K N S</b>
			M-Medium	<b>P M K S</b>
			R-Rough	<b>P M K S</b>
<b>PROFILING</b>		2.0–8.0mm (0.079–0.315")	PC-Full Radius	<b>P M K N S</b>

## APPLICATIONS



TURNING



PROFILING



FACING



CHAMFERING



GROOVING



CUT-OFF



DEEP  
GROOVING



THROUGH  
COOLANT

## INDUSTRY

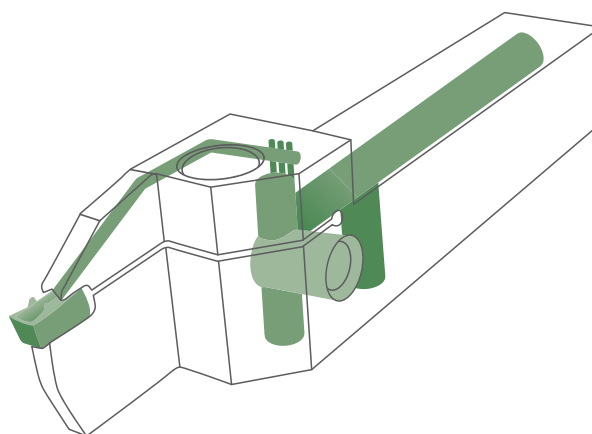



## Grooving and Cut-Off • WGC

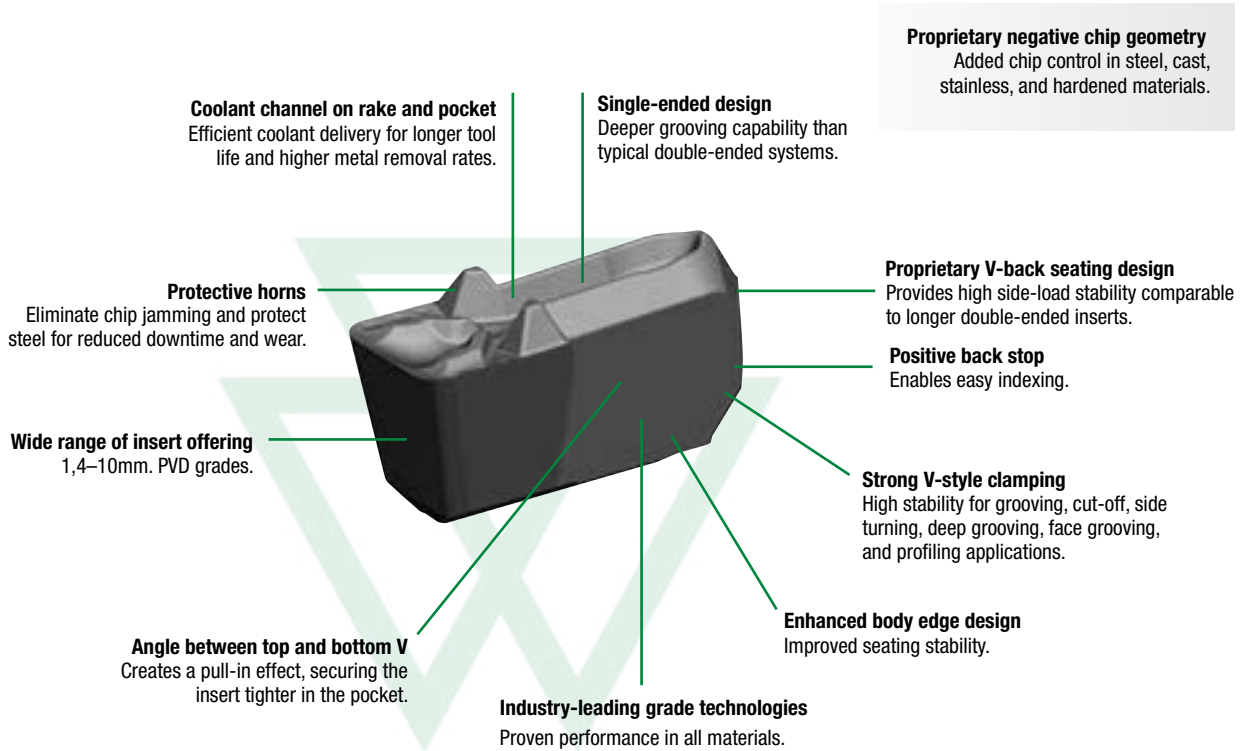

## Catalog Numbering System

Each character in our catalog number signifies a specific trait of that product.  
Use the following key columns and corresponding images to easily identify which attributes apply.

<b>W</b>	<b>G</b>	<b>0312</b>	<b>M</b>	<b>03</b>	<b>U</b>	<b>02</b>	<b>PT</b>																																																										
Family Name	Insert Type	Groove Width	Unit	Seat Size	Tolerance	Corner Radius	Chipbreaker/ Edge Condition																																																										
WGC	<b>G</b> = Square  <b>R</b> = Full Radius	<b>Metric</b> = 1/100mm  <b>Inch</b> = 1/1000"	<b>M</b> = Metric  <b>I</b> = Inch	<table border="1"> <thead> <tr> <th rowspan="2">seat size (SSC)</th> <th colspan="2">groove width</th> </tr> <tr> <th>mm</th> <th>inch</th> </tr> </thead> <tbody> <tr><td>1B</td><td>1,40</td><td>.055</td></tr> <tr><td>1F</td><td>1,60-1,99</td><td>.063-.078</td></tr> <tr><td>02</td><td>2,00-2,99</td><td>.079-.117</td></tr> <tr><td>03</td><td>3,00-3,99</td><td>.118-.156</td></tr> <tr><td>04</td><td>4,00-4,99</td><td>.157-.196</td></tr> <tr><td>05</td><td>5,00-5,99</td><td>.197-.235</td></tr> <tr><td>06</td><td>6,00-7,99</td><td>.236-.314</td></tr> <tr><td>08</td><td>8,00-8,99</td><td>.315-.353</td></tr> <tr><td>10</td><td>9,00-10,12</td><td>.354-.398</td></tr> </tbody> </table> <p>*.312" = seat size 08</p>	seat size (SSC)	groove width		mm	inch	1B	1,40	.055	1F	1,60-1,99	.063-.078	02	2,00-2,99	.079-.117	03	3,00-3,99	.118-.156	04	4,00-4,99	.157-.196	05	5,00-5,99	.197-.235	06	6,00-7,99	.236-.314	08	8,00-8,99	.315-.353	10	9,00-10,12	.354-.398	<b>U</b> = Precision Molded  <b>P</b> = Precision Ground	<table border="1"> <thead> <tr> <th colspan="2">mm</th> </tr> </thead> <tbody> <tr><td>00</td><td>full radius</td></tr> <tr><td>01</td><td>0,1</td></tr> <tr><td>02</td><td>0,2</td></tr> <tr><td>04</td><td>0,4</td></tr> <tr><td>08</td><td>0,8</td></tr> <tr><td>12</td><td>1,2</td></tr> </tbody> </table> <table border="1"> <thead> <tr> <th colspan="2">inch</th> </tr> </thead> <tbody> <tr><td>00</td><td>full radius</td></tr> <tr><td>05</td><td>.008</td></tr> <tr><td>1</td><td>.016</td></tr> <tr><td>2</td><td>.032</td></tr> <tr><td>3</td><td>.047</td></tr> </tbody> </table>	mm		00	full radius	01	0,1	02	0,2	04	0,4	08	0,8	12	1,2	inch		00	full radius	05	.008	1	.016	2	.032	3	.047	<b>PT</b> = Groove-Turn Universal Positive  <b>PN</b> = Groove-Turn Universal Negative
seat size (SSC)	groove width																																																																
	mm	inch																																																															
1B	1,40	.055																																																															
1F	1,60-1,99	.063-.078																																																															
02	2,00-2,99	.079-.117																																																															
03	3,00-3,99	.118-.156																																																															
04	4,00-4,99	.157-.196																																																															
05	5,00-5,99	.197-.235																																																															
06	6,00-7,99	.236-.314																																																															
08	8,00-8,99	.315-.353																																																															
10	9,00-10,12	.354-.398																																																															
mm																																																																	
00	full radius																																																																
01	0,1																																																																
02	0,2																																																																
04	0,4																																																																
08	0,8																																																																
12	1,2																																																																
inch																																																																	
00	full radius																																																																
05	.008																																																																
1	.016																																																																
2	.032																																																																
3	.047																																																																

<b>W</b>	<b>C</b>	<b>030</b>	<b>M</b>	<b>03</b>	<b>N</b>	<b>00</b>	<b>F</b>	<b>02</b>																																																																		
Family Name	Insert Type	Cutting Edge Width	Unit	Seat Size	Hand of Insert	Approach Angle	Chipbreaker	Corner Radius																																																																		
WGC	<b>C</b> = Cut-Off	<table border="1"> <thead> <tr> <th></th> <th>mm</th> <th>inch</th> </tr> </thead> <tbody> <tr><td>014</td><td>1,4</td><td>.055</td></tr> <tr><td>020</td><td>2,0</td><td>.079</td></tr> <tr><td>030</td><td>3,0</td><td>.118</td></tr> <tr><td>040</td><td>4,0</td><td>.157</td></tr> <tr><td>050</td><td>5,0</td><td>.197</td></tr> <tr><td>060</td><td>6,0</td><td>.236</td></tr> <tr><td>070</td><td>7,0</td><td>.279</td></tr> <tr><td>080</td><td>8,0</td><td>.315</td></tr> </tbody> </table>		mm	inch	014	1,4	.055	020	2,0	.079	030	3,0	.118	040	4,0	.157	050	5,0	.197	060	6,0	.236	070	7,0	.279	080	8,0	.315	<b>M</b> = Metric  <b>I</b> = Inch	<table border="1"> <thead> <tr> <th></th> <th>mm</th> <th>inch</th> </tr> </thead> <tbody> <tr><td>1B</td><td>1,4</td><td>.055</td></tr> <tr><td>1F</td><td>2,0</td><td>.079</td></tr> <tr><td>02</td><td>3,0</td><td>.118</td></tr> <tr><td>03</td><td>4,0</td><td>.157</td></tr> <tr><td>04</td><td>5,0</td><td>.197</td></tr> <tr><td>05</td><td>6,0</td><td>.236</td></tr> <tr><td>06</td><td>7,0</td><td>.279</td></tr> <tr><td>08</td><td>8,0</td><td>.315</td></tr> </tbody> </table>		mm	inch	1B	1,4	.055	1F	2,0	.079	02	3,0	.118	03	4,0	.157	04	5,0	.197	05	6,0	.236	06	7,0	.279	08	8,0	.315	<b>N</b> = Neutral  <b>L</b> = Left hand  <b>R</b> = Right hand	<b>00</b> = Neutral  <b>06</b> = 6°	<b>F</b> = Cut-Off Low Feed  <b>M</b> = Cut-Off Fine  <b>R</b> = Cut-Off Rough	<table border="1"> <thead> <tr> <th></th> <th>mm</th> <th>inch</th> </tr> </thead> <tbody> <tr><td>01</td><td>0,1</td><td>.004</td></tr> <tr><td>02</td><td>0,2</td><td>.008</td></tr> <tr><td>04</td><td>0,4</td><td>.016</td></tr> </tbody> </table>		mm	inch	01	0,1	.004	02	0,2	.008	04	0,4	.016
	mm	inch																																																																								
014	1,4	.055																																																																								
020	2,0	.079																																																																								
030	3,0	.118																																																																								
040	4,0	.157																																																																								
050	5,0	.197																																																																								
060	6,0	.236																																																																								
070	7,0	.279																																																																								
080	8,0	.315																																																																								
	mm	inch																																																																								
1B	1,4	.055																																																																								
1F	2,0	.079																																																																								
02	3,0	.118																																																																								
03	4,0	.157																																																																								
04	5,0	.197																																																																								
05	6,0	.236																																																																								
06	7,0	.279																																																																								
08	8,0	.315																																																																								
	mm	inch																																																																								
01	0,1	.004																																																																								
02	0,2	.008																																																																								
04	0,4	.016																																																																								

## Grades and Grade Descriptions

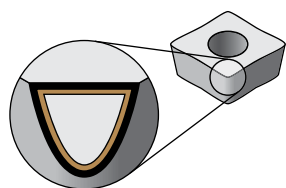

Coatings provide high-speed capability and are engineered for finishing to heavy roughing.

P	Steel
M	Stainless Steel
K	Cast Iron
N	Non-Ferrous
S	High-Temp Alloys
H	Hardened Materials

Coating	Grade Description	wear resistance ← → toughness									
			05	10	15	20	25	30	35	40	45
WU10PT	<p><b>Composition:</b> An advanced multilayer PVD coating over a very deformation-resistant unalloyed carbide substrate. The new and improved coating improves edge stability with wide range speed and feed capabilities.</p> <p><b>Application:</b> The WU10PT™ grade is ideal for finishing to general machining of most workpiece materials at a wide range of speed and feed capabilities. Excellent for machining most steels, stainless steels, cast irons, non-ferrous materials, and super alloys with improved edge toughness and higher cutting speed/feed capability.</p>	P									
		M									
		K									
		N									
		S									
		H									
WU25PT	<p><b>Composition:</b> An advanced PVD-TiAlN-coated grade with a tough, ultra-fine grain, unalloyed substrate.</p> <p><b>Application:</b> For general-purpose machining of most steels, stainless steels, high-temperature alloys, titanium, irons, and non-ferrous materials. Speeds may vary from low to medium and will handle interruptions and high feed rates.</p>	P									
		M									
		K									
		N									
		S									
		H									
WU35PT	<p><b>Composition:</b> A multilayer PVD-coated carbide grade with an advanced AlTiN-TiN coating over a super-tough substrate.</p> <p><b>Application:</b> WU35PT is an excellent grade for machining stainless steels, all types of steels, super alloys in turning, and cut-off applications. The substrate provides improved toughness while the coating layers offer excellent abrasion resistance and dependability at a wide range of speeds and feeds. Improved edge toughness provides security in interrupted cuts.</p>	P									
		M									
		K									
		N									
		S									
		H									

### Plunge Feed Rates

- first choice
- alternate choice

<b>P</b> Steel	<b>K</b> Cast Iron	<b>S</b> High-Temp Alloys
<b>M</b> Stainless Steel	<b>N</b> Non-Ferrous	<b>H</b> Hardened Materials

Chip Control	Description	Insert Geometry	Seat Size (SSC)	Corner Radius	Starting Conditions	Plunge Feed Rates inch/rev (mm/rev)							
				in (mm)	in (mm)	.0020 (0,05)	.0040 (0,10)	.0060 (0,15)	.0080 (0,20)	.0100 (0,25)	.0120 (0,30)	.0140 (0,35)	
-PT	Positive rake angle for lower cutting forces.		1F	.008 (0,2)	.0024 (0,06)	◊							
			2	.008 (0,2)	.0031 (0,08)		◊						
			3	.008 (0,2)	.0035 (0,09)			◊					
				.016 (0,4)	.0043 (0,11)				◊				
			4	.016 (0,4)	.0047 (0,12)				◊				
				.031 (0,8)	.0059 (0,15)					◊			
			5	.016 (0,4)	.0059 (0,15)					◊			
				.031 (0,8)	.0059 (0,16)						◊		
			6	.016 (0,4)	.0059 (0,15)						◊		
				.031 (0,8)	.0071 (0,18)							◊	
8	.031 (0,8)	.0079 (0,20)							◊				
	.047 (1,2)	.0087 (0,22)								◊			
10	.047 (1,2)	.0094 (0,24)								◊			
-PN	Stable negative cutting edge allowing for more aggressive applications.		1F	.008 (0,2)	.0024 (0,06)	◊							
			2	.008 (0,2)	.0031 (0,08)		◊						
			3	.008 (0,2)	.0035 (0,09)			◊					
				.016 (0,4)	.0043 (0,11)				◊				
			4	.016 (0,4)	.0047 (0,12)				◊				
				.031 (0,8)	.0059 (0,15)					◊			
			5	.016 (0,4)	.0059 (0,15)					◊			
				.031 (0,8)	.0059 (0,16)						◊		
			6	.016 (0,4)	.0059 (0,15)						◊		
				.031 (0,8)	.0071 (0,18)							◊	
8	.031 (0,8)	.0079 (0,20)							◊				
	.047 (1,2)	.0087 (0,22)								◊			
10	.047 (1,2)	.0094 (0,24)								◊			

### Cut-Off Feed Rates

Chip Control	Description	Insert Geometry	Seat Size (SSC)	Starting Conditions	Cut-Off Feed Rates inch/rev (mm/rev)							
				in (mm)	.0020 (0,05)	.0040 (0,10)	.0060 (0,15)	.0080 (0,20)	.0100 (0,25)	.0120 (0,30)	.0140 (0,35)	.0160 (0,40)
-F	Positive geometry for reduced cutting forces.		1B	.0024 (0,06)	◊							
			2	.0028 (0,07)		◊						
			3	.0035 (0,09)			◊					
			4	.0043 (0,11)				◊				
			5	.0051 (0,13)					◊			
-M	Stable cutting edge for aggressive feed rates. Primarily in cast iron.		1B	.0024 (0,06)	◊							
			2	.0028 (0,07)		◊						
			3	.0035 (0,09)			◊					
			4	.0043 (0,11)				◊				
			5	.0055 (0,14)					◊			
			6	.0063 (0,16)						◊		
-R	Most stable cutting edge for steel.		2	.0039 (0,10)			◊					
			3	.0055 (0,14)				◊				
			4	.0063 (0,16)					◊			
			5	.0075 (0,19)						◊		
			6	.0083 (0,21)							◊	
8	.0090 (0,23)								◊			

NOTE: For cut-off inserts with a lead angle, maximum feed rate should be reduced by up to 40%.

#### Maximum Feed Rate Values

Data above is for P and K material groups. <b>Maximum</b> feed rates should be adjusted by multiplying max feed rate values by following factors for shown material groups.	Material Group	Feed Factor
	<b>M</b>	0.8
	<b>N</b>	1.2
	<b>S</b>	0.8
	<b>H</b>	0.5

**I.D. and Face Grooving**  
For I.D. and face grooving applications, reduce feed rate by 20%.

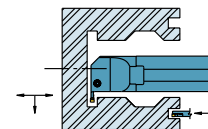

INDEXABLE MILLING

SOLID END MILLING

HOLEMAKING

TAPPING

TURNING

Turn and Profile Feed Rates

Seat Size 1F

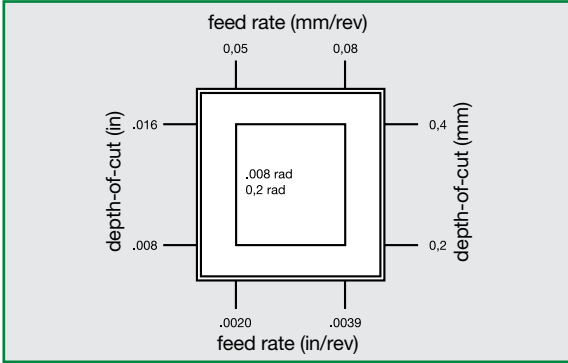

Seat Size 2

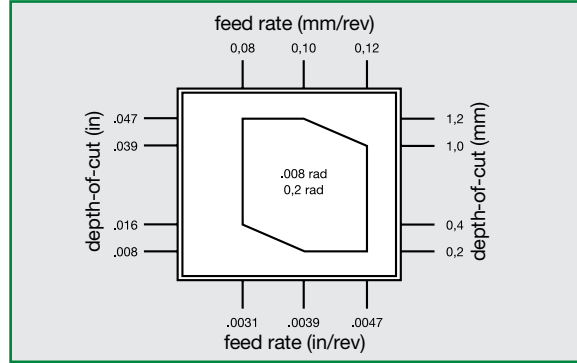

Seat Size 3

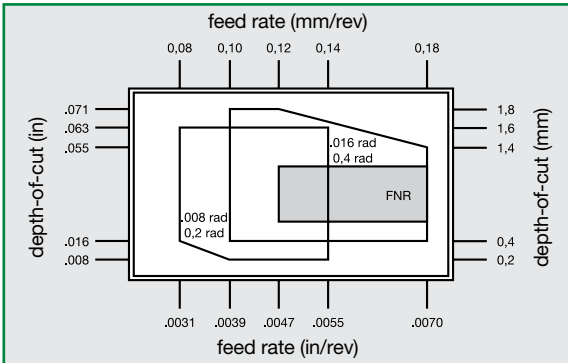

Seat Size 4

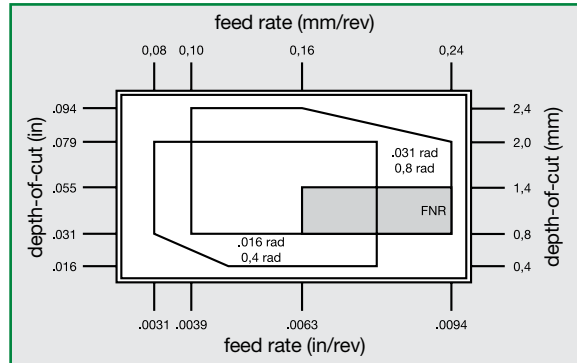

Seat Size 5

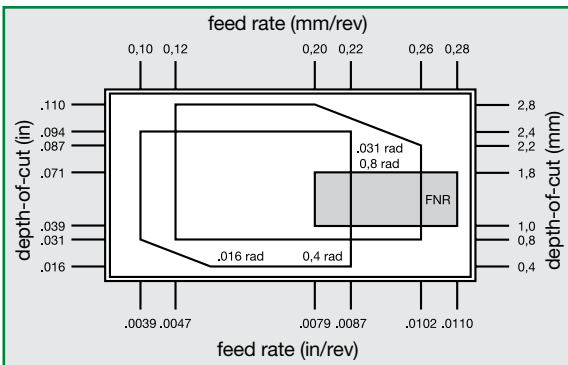

Seat Size 6

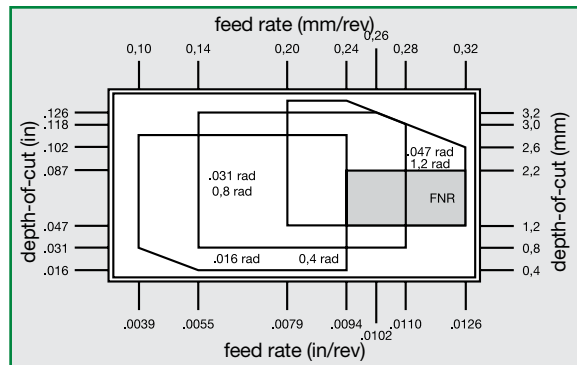

Seat Size 8

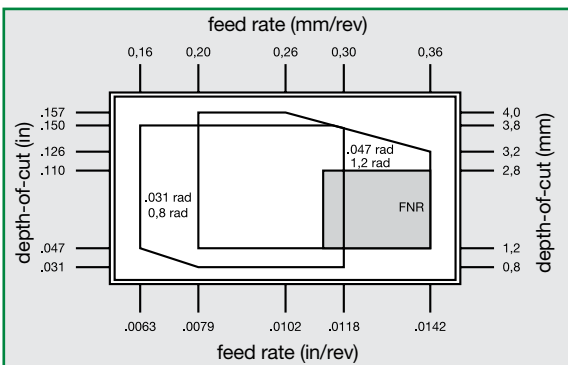

Seat Size 10

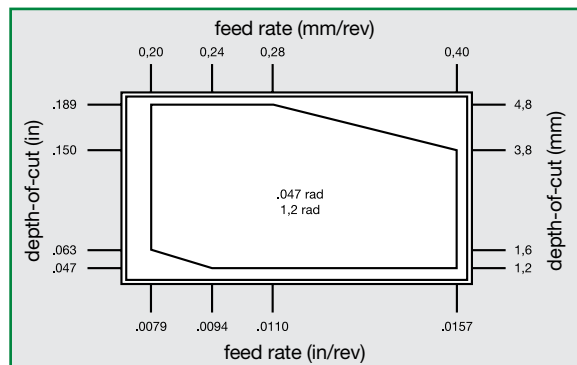

\* FNR = Full Nose Radius

Recommended Starting Speeds [SFM]

Material Group		WU10PT			WU25PT			WU35PT		
P	0-1	450	<b>450</b>	450	360	<b>740</b>	880	290	<b>590</b>	700
	2	450	<b>450</b>	450	360	<b>520</b>	880	290	<b>420</b>	510
	3	450	<b>450</b>	450	360	<b>410</b>	800	290	<b>330</b>	510
	4	250	<b>250</b>	250	200	<b>290</b>	540	160	<b>230</b>	350
	5	400	<b>400</b>	400	320	<b>530</b>	680	260	<b>420</b>	540
	6	350	<b>350</b>	350	280	<b>400</b>	600	220	<b>320</b>	480
M	1	450	<b>450</b>	450	300	<b>550</b>	800	250	<b>400</b>	450
	2	400	<b>400</b>	400	300	<b>500</b>	800	250	<b>350</b>	450
	3	400	<b>400</b>	400	300	<b>450</b>	700	250	<b>300</b>	450
K	1	400	<b>400</b>	400	320	<b>480</b>	760	-	-	-
	2	300	<b>300</b>	300	240	<b>400</b>	560	-	-	-
	3	200	<b>200</b>	200	160	<b>280</b>	400	-	-	-
N	1-2	500	<b>500</b>	500	400	<b>1440</b>	2560	-	-	-
	3	-	-	-	-	-	-	-	-	-
	4	400	<b>400</b>	400	320	<b>960</b>	1600	-	-	-
	5	300	<b>300</b>	300	240	<b>440</b>	640	-	-	-
	6	400	<b>400</b>	400	320	<b>560</b>	800	-	-	-
S	1	50	<b>50</b>	50	25	<b>125</b>	200	25	<b>125</b>	200
	2	50	<b>50</b>	50	25	<b>100</b>	250	25	<b>100</b>	200
	3	50	<b>50</b>	50	50	<b>125</b>	250	50	<b>125</b>	200
	4	50	<b>50</b>	50	25	<b>175</b>	350	50	<b>150</b>	300
H	1	100	<b>100</b>	100	-	-	-	-	-	-
	2	50	<b>50</b>	50	-	-	-	-	-	-
	3	-	-	-	-	-	-	-	-	-

NOTE: First choice starting speeds are in **bold** type.  
As the average chip thickness increases, the speed should be decreased.

INDEXABLE MILLING

SOLID END MILLING

HOLE/MAKING

TAPPING

TURNING

## WGC Cut-Off Inserts • F Precision Molded • Metric



Left Hand



Neutral



Right Hand

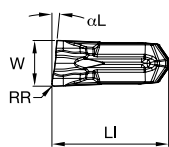

Left Hand

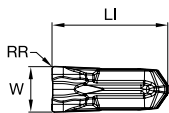

Neutral

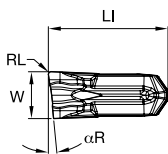

Right Hand

● first choice

○ alternate choice

P	●	○	●	●
M	●	○	●	●
K	●	○	○	○
N	○	○	○	○
S	○	○	○	○
H	○	○	○	○

catalog number	SSC	W		W tol ±		LI		αR	αL	RR		RL		WU10PT	WU25PT	WU35PT
		mm	in	mm	in	mm	in			mm	in	mm	in			
WC014M1BL06F01	1B	1,40	.055	0,050	.002	9,00	.355	—	6	0,15	.006	—	—	●	○	○
WC014M1BN00F01	1B	1,40	.055	0,050	.002	9,00	.355	—	—	0,15	.006	0,15	.006	○	○	○
WC014M1BR06F01	1B	1,40	.055	0,050	.002	9,02	.355	6	—	—	—	0,15	.006	○	○	○
WC020M02L06F02	2	2,00	.079	0,050	.002	9,00	.353	—	6	0,20	.008	—	—	○	○	○
WC020M02N00F02	2	2,00	.079	0,050	.002	9,00	.353	—	—	0,20	.008	0,20	.008	○	○	○
WC020M02R06F02	2	2,00	.079	0,050	.002	9,00	.353	6	—	—	—	0,20	.008	○	○	○
WC030M03L06F02	3	3,00	.118	0,075	.003	9,60	.378	—	6	0,20	.008	—	—	○	○	○
WC030M03N00F02	3	3,00	.118	0,075	.003	9,63	.379	—	—	0,20	.008	0,20	.008	○	○	○
WC030M03R06F02	3	3,00	.118	0,075	.003	9,60	.378	6	—	—	—	—	—	○	○	○
WC040M04L06F02	4	4,00	.157	0,075	.003	10,19	.401	—	6	0,20	.008	—	—	○	○	○
WC040M04N00F02	4	4,00	.157	0,075	.003	10,19	.401	—	—	0,20	.008	0,20	.008	○	○	○
WC040M04R06F02	4	4,00	.157	0,075	.003	10,19	.401	6	—	—	—	0,20	.008	○	○	○
WC050M05N00F03	5	5,00	.197	0,075	.003	12,24	.482	—	—	0,30	.012	0,30	.012	○	○	○

NOTE: SSC = To correspond with the SSC on the toolholder.

INDEXABLE MILLING

SOLID END MILLING

HOLEMAKING

TAPPING

TURNING

WGC Cut-Off Inserts • F Precision Ground • Inch

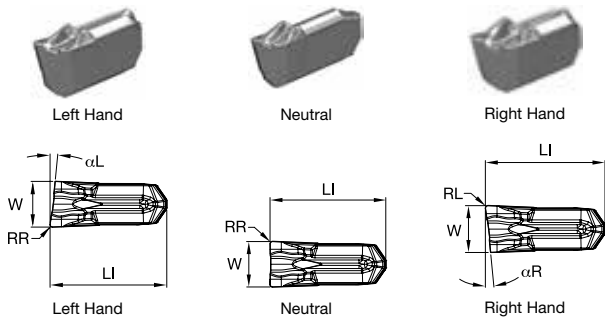

● first choice  
○ alternate choice

P	●	○	●	○
M	●	○	●	○
K	○	○	○	○
N	●	○	○	○
S	○	○	○	○
H	○	○	○	○

catalog number	SSC	W		W tol ±		LI		αR	αL	RR		RL		WU10PT	WU25PT	WU35PT
		mm	in	mm	in	mm	in			mm	in	mm	in			
WC014M1BPR06F00	1B	1,40	.055	0,025	.001	9,00	.355	6	—	—	—	—	—	—	—	—
WC014M1BPR12F00	1B	1,40	.055	0,025	.001	9,00	.355	12	—	—	—	—	—	—	—	—
WC094I02PL06F00	2	2,39	.094	0,025	.001	8,95	.352	—	6	—	—	—	—	—	—	—
WC094I02PL12F00	2	2,39	.094	0,025	.001	8,95	.352	—	12	—	—	—	—	—	—	—
WC094I02PN00F00	2	2,39	.094	0,025	.001	8,95	.352	—	—	—	—	—	—	—	—	—
WC094I02PR06F00	2	2,39	.094	0,025	.001	8,95	.352	6	—	—	—	—	—	—	—	—
WC094I02PR12F00	2	2,39	.094	0,025	.001	8,95	.352	—	12	—	—	—	—	—	—	—
WC094I02PL06F0	2	2,39	.094	0,025	.001	9,04	.360	—	6	0,10	.004	0,10	.004	—	—	—
WC094I02PN00F0	2	2,39	.094	0,025	.001	9,04	.356	—	—	0,10	.004	0,10	.004	—	—	—
WC094I02PN00F05	2	2,39	.094	0,025	.001	9,04	.356	—	—	0,20	.008	0,20	.008	—	—	—
WC094I02PR06F0	2	2,39	.094	0,025	.001	9,04	.356	6	—	0,10	.004	0,10	.004	—	—	—
WC094I02PR06F05	2	2,39	.094	0,025	.001	9,04	.356	6	—	0,20	.008	0,20	.008	—	—	—



## WGC Cut-Off Inserts • F Precision Ground • Inch

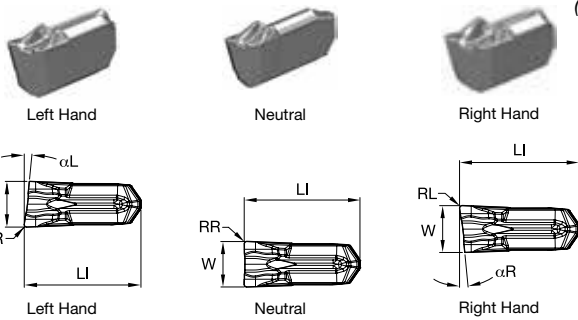

(continued)

● first choice  
○ alternate choice

P	●	○	●	○
M	●	○	●	○
K	●	○	●	○
N	●	○	●	○
S	●	○	●	○
H	○	○	○	○

catalog number	SSC	W		W tol ±		LI		αR	αL	RR		RL		WU10PT	WU25PT	WU35PT
		mm	in	mm	in	mm	in			mm	in	mm	in			
WC025M02PR06F01	2	2,50	.098	0,025	.001	9,04	.356	6	—	0,15	.006	0,15	.006	—	—	—
WC030M03PN00F02	3	3,00	.118	0,075	.003	9,63	.379	—	—	0,20	.008	0,20	.008	—	—	6686473 6686472
WC125I03PL06F00	3	3,18	.125	0,025	.001	9,48	.373	—	6	—	—	—	—	—	—	6686414
WC125I03PL12F00	3	3,18	.125	0,025	.001	9,48	.373	—	12	—	—	—	—	—	—	6686416
WC125I03PN00F00	3	3,18	.125	0,025	.001	9,48	.373	—	—	—	—	—	—	—	—	6686086 6686418
WC125I03PR06F00	3	3,18	.125	0,025	.001	9,48	.373	6	—	—	—	—	—	—	—	6686089 6686421
WC125I03PL06F0	3	3,18	.125	0,025	.001	9,63	.379	—	6	0,10	.004	0,10	.004	—	—	6686478
WC125I03PL06F05	3	3,18	.125	0,025	.001	9,63	.379	—	6	0,20	.008	0,20	.008	—	—	6686415
WC125I03PN00F0	3	3,18	.125	0,025	.001	9,63	.379	—	—	0,10	.004	0,10	.004	—	—	6686083 6686417
WC125I03PN00F05	3	3,18	.125	0,025	.001	9,63	.379	—	—	0,20	.008	0,20	.008	—	—	6686087 6686419
WC125I03PR06F0	3	3,18	.125	0,025	.001	9,63	.379	6	—	0,10	.004	0,10	.004	—	—	6686088 6686420
WC125I03PR06F05	3	3,18	.125	0,025	.001	9,63	.379	6	—	0,20	.008	0,20	.008	—	—	6686480

INDEXABLE MILLING

SOLID END MILLING

HOLEMAKING

TAPPING

TURNING

WGC Cut-Off Inserts • F Precision Ground • Inch

(continued)

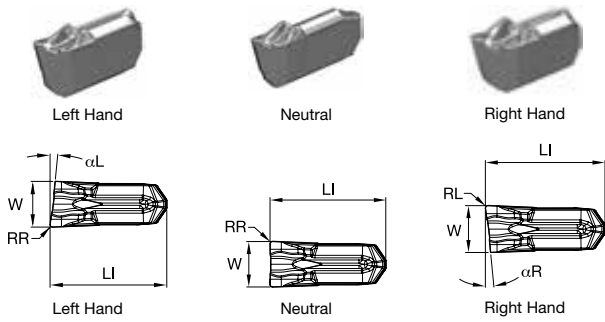

- first choice
- alternate choice

P	●	○	●	●
M	●	○	●	●
K	●	○	○	○
N	●	○	○	○
S	●	○	○	○
H	○	○	○	○

catalog number	SSC	W		W tol ±		LI		αR	αL	RR		RL		WU10PT	WU25PT	WU55PT
		mm	in	mm	in	mm	in			mm	in	mm	in			
WC125I03PR12F00	3	3,18	.125	0,025	.001	9,75	.373	12	—	—	—	—	—	●	●	●
WC040M04PR06F00	4	4,00	.158	0,025	.001	10,01	.394	6	—	—	—	—	—	●	●	●
WC040M04PR12F00	4	4,00	.158	0,025	.001	10,01	.394	12	—	—	—	—	—	●	●	●
WC188I04PR12F00	4	4,75	.187	0,025	.001	10,01	.394	12	—	—	—	—	—	●	●	●
WC188I04PR06F00	4	4,76	.188	0,025	.001	10,01	.394	6	—	—	—	—	—	○	○	○
WC188I04PL06F00	4	4,76	.188	0,025	.001	10,02	.395	—	6	—	—	—	—	○	○	○
WC188I04PN00F00	4	4,76	.188	0,025	.001	10,02	.395	—	—	—	—	—	—	○	○	○
WC188I04PN00F05	4	4,76	.188	0,025	.001	10,16	.400	—	—	0,20	.008	0,20	.008	○	○	○
WC188I04PR06F05	4	4,76	.188	0,025	.001	10,17	.400	6	—	0,20	.008	0,20	.008	○	○	○

NOTE: SSC = To correspond with the SSC on the toolholder.

INDEXABLE MILLING

SOLID END MILLING

HOLEMAKING

TAPPING

TURNING

## WGC Cut-Off Inserts • M Precision Molded • Metric



Left Hand



Neutral



Right Hand

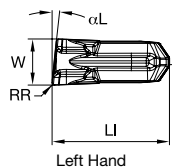

Left Hand

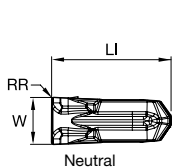

Neutral

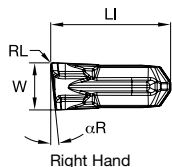

Right Hand

- first choice
- alternate choice

P	●	○	●	○
M	●	○	●	○
K	●	○	●	○
N	●	○	●	○
S	●	○	●	○
H	○	○	○	○

catalog number	SSC	W		W tol ±		LI		αR	αL	RR		RL		WU10PT	WU25PT	WU35PT
		mm	in	mm	in	mm	in			mm	in	mm	in			
WC014M1BL06M02	1B	1,40	.055	0,050	.002	9,02	.355	—	6	—	—	0,20	.008	●	○	○
WC014M1BN00M01	1B	1,40	.055	0,050	.002	9,01	.355	—	—	0,15	.006	0,15	.006	○	○	○
WC014M1BR06M02	1B	1,40	.055	0,050	.002	9,02	.355	6	—	—	—	0,20	.008	○	○	○
WC020M02L06M02	2	2,00	.079	0,050	.002	8,97	.353	—	6	—	—	0,20	.008	○	○	○
WC020M02N00M02	2	2,00	.079	0,050	.002	8,98	.353	—	—	0,20	.008	0,20	.008	○	○	○
WC020M02R06M02	2	2,00	.079	0,050	.002	9,00	.353	6	—	—	—	0,20	.009	○	○	○
WC030M03L06M02	3	3,00	.118	0,075	.003	9,61	.378	—	6	—	—	0,20	.008	○	○	○
WC030M03N00M02	3	3,00	.118	0,075	.003	9,60	.378	—	—	0,20	.008	0,20	.008	○	○	○
WC030M03R06M02	3	3,00	.118	0,075	.003	9,61	.378	6	—	—	—	0,20	.008	○	○	○
WC040M04L06M02	4	4,00	.157	0,075	.003	10,19	.401	—	6	0,20	.008	—	—	○	○	○
WC040M04N00M02	4	4,00	.157	0,075	.003	10,20	.402	—	—	0,20	.008	0,20	.008	○	○	○
WC040M04R06M02	4	4,00	.158	0,050	.002	10,20	.401	6	—	—	—	0,20	.008	○	○	○

INDEXABLE MILLING

SOLID END MILLING

HOLEMAKING

TAPPING

TURNING

WGC Cut-Off Inserts • M Precision Molded • Metric



Left Hand



Neutral



Right Hand

(continued)

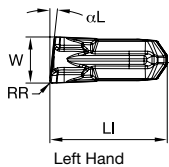

Left Hand

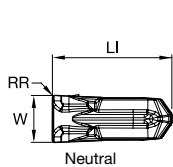

Neutral

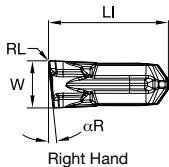

Right Hand

- first choice
- alternate choice

P	●	○	●	○
M	●	○	●	○
K	●	○	●	○
N	●	○	●	○
S	●	○	●	○
H	○	○	○	○

catalog number	SSC	W		W tol ±		LI		αR	αL	RR		RL		WU10PT	WU25PT	WU35PT
		mm	in	mm	in	mm	in			mm	in	mm	in			
WC050M05N00M03	5	5,00	.197	0,075	.003	12,25	.482	—	—	0,30	.012	0,30	.012	—	—	—
WC060M06N00M03	6	6,00	.236	0,075	.003	14,59	.574	—	—	0,30	.012	0,30	.012	—	—	—
WC080M08N00M04	8	8,00	.315	0,075	.003	17,46	.688	—	—	0,40	.016	0,40	.016	—	—	—

NOTE: SSC = To correspond with the SSC on the toolholder.

INDEXABLE MILLING

SOLID END MILLING

HOLE/MAKING

TAPPING

TURNING

## WGC Cut-Off Inserts • R Precision Molded • Metric

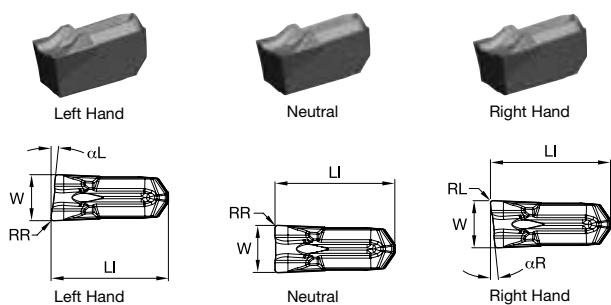

● first choice  
○ alternate choice

P	●	○	○	○
M	●	○	○	○
K	●	○	○	○
N	●	○	○	○
S	●	○	○	○
H	○	○	○	○

catalog number	SSC	W		W tol ±		LI		αR	αL	RR		RL		WU10PT	WU25PT	WU35PT
		mm	in	mm	in	mm	in			mm	in	mm	in			
WC020M02L06R02	2	2,00	.079	0,050	.002	8,97	.353	—	6	0,20	.008	—	—	●	○	○
WC020M02N00R02	2	2,00	.079	0,050	.002	8,98	.353	—	—	0,20	.008	0,20	.008	○	○	○
WC020M02R06R02	2	2,00	.079	0,050	.002	8,97	.353	6	—	—	—	0,20	.008	○	○	○
WC030M03L06R02	3	3,00	.118	0,075	.003	9,61	.378	—	6	0,20	.008	—	—	○	○	○
WC030M03N00R02	3	3,00	.118	0,075	.003	9,60	.378	—	—	0,20	.008	0,20	.008	○	○	○
WC030M03R06R02	3	3,00	.118	0,075	.003	9,61	.378	6	—	—	—	0,20	.008	○	○	○
WC040M04N00R02	4	4,00	.158	0,075	.003	10,20	.402	—	—	0,20	.008	0,20	.008	○	○	○
WC050M05N00R03	5	5,00	.197	0,075	.003	12,25	.482	—	—	0,30	.012	0,30	.012	○	○	○
WC060M06N00R03	6	6,00	.236	0,075	.003	14,59	.574	—	—	0,30	.012	0,30	.012	○	○	○
WC080M08N00R04	8	8,00	.315	0,075	.003	17,46	.687	—	—	0,40	.016	0,40	.016	○	○	○

NOTE: SSC = To correspond with the SSC on the toolholder.

INDEXABLE MILLING

SOLID END MILLING

HOLEMAKING

TAPPING

TURNING

WGC Grooving Inserts • PT Precision Molded • Metric

● first choice  
○ alternate choice

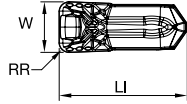

P	<input checked="" type="checkbox"/>	<input type="checkbox"/>	<input type="checkbox"/>	<input type="checkbox"/>
M	<input checked="" type="checkbox"/>	<input type="checkbox"/>	<input type="checkbox"/>	<input type="checkbox"/>
K	<input checked="" type="checkbox"/>	<input type="checkbox"/>	<input type="checkbox"/>	<input type="checkbox"/>
N	<input checked="" type="checkbox"/>	<input type="checkbox"/>	<input type="checkbox"/>	<input type="checkbox"/>
S	<input checked="" type="checkbox"/>	<input type="checkbox"/>	<input type="checkbox"/>	<input type="checkbox"/>
H	<input type="checkbox"/>	<input type="checkbox"/>	<input type="checkbox"/>	<input type="checkbox"/>

catalog number	SSC	W		W tol ±		RR		LI		WU10PT	WU25PT	WU35PT
		mm	in	mm	in	mm	in	mm	in			
WG0212M02U02PT	2	2,13	.084	0,050	.002	0,20	.008	8,97	.353	●	●	●
WG0251M02U02PT	2	2,51	.099	0,050	.002	0,20	.008	8,97	.353	●	●	●
WG0312M03U02PT	3	3,13	.123	0,075	.003	0,20	.008	9,60	.378	●	●	●
WG0312M03U04PT	3	3,13	.123	0,075	.003	0,40	.016	9,60	.378	●	●	●
WG0412M04U04PT	4	4,13	.162	0,075	.003	0,40	.016	10,19	.401	●	●	●
WG0412M04U08PT	4	4,13	.162	0,075	.003	0,80	.031	10,19	.401	●	●	●
WG0512M05U04PT	5	5,13	.202	0,075	.003	0,40	.016	12,25	.482	●	●	●
WG0512M05U08PT	5	5,13	.202	0,075	.003	0,80	.032	12,25	.482	●	●	●
WG0612M06U04PT	6	6,13	.241	0,075	.003	0,40	.016	14,59	.575	●	●	●
WG0612M06U08PT	6	6,13	.241	0,075	.003	0,80	.032	14,59	.574	●	●	●
WG0712M06U08PT	6	7,13	.281	0,075	.003	0,80	.032	14,59	.574	●	●	●
WG0812M08U08PT	8	8,13	.320	0,075	.003	0,80	.032	17,45	.687	●	●	●
WG0812M08U12PT	8	8,13	.320	0,075	.003	1,20	.046	17,45	.687	●	●	●
WG1012M10U12PT	10	10,13	.399	0,075	.003	1,20	.047	20,75	.817	●	●	●

NOTE: SSC = To correspond with the SSC on the toolholder.

INDEXABLE MILLING

SOLID END MILLING

HOLEMAKING

TAPPING

TURNING

## WGC Grooving Inserts • PT Precision Molded • Inch

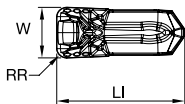

● first choice

○ alternate choice

P	<input type="checkbox"/>	<input type="checkbox"/>	<input type="checkbox"/>	<input type="checkbox"/>
M	<input type="checkbox"/>	<input type="checkbox"/>	<input type="checkbox"/>	<input type="checkbox"/>
K	<input type="checkbox"/>	<input type="checkbox"/>	<input type="checkbox"/>	<input type="checkbox"/>
N	<input type="checkbox"/>	<input type="checkbox"/>	<input type="checkbox"/>	<input type="checkbox"/>
S	<input type="checkbox"/>	<input type="checkbox"/>	<input type="checkbox"/>	<input type="checkbox"/>
H	<input type="checkbox"/>	<input type="checkbox"/>	<input type="checkbox"/>	<input type="checkbox"/>

catalog number	SSC	W		W tol ±		RR		LI		WU10PT	WU25PT	WU35PT
		mm	in	mm	in	mm	in	mm	in			
WG130I03U1PT	3	3,30	.130	0,075	.003	0,40	.016	9,60	.378	✓	✓	✓
WG130I03U05PT	3	3,30	.130	0,075	.003	0,20	.008	9,60	.378	✓	✓	✓
WG192I04U1PT	4	4,88	.192	0,075	.003	0,40	.016	10,19	.401	✓	✓	✓
WG192I04U2PT	4	4,88	.192	0,075	.003	0,78	.031	10,19	.401	✓	✓	✓
WG255I06U1PT	6	6,48	.255	0,075	.003	0,40	.016	14,58	.574	✓	✓	✓
WG255I06U2PT	6	6,48	.255	0,075	.003	0,80	.031	14,58	.574	✓	✓	✓
WG317I08U3PT	8	8,05	.317	0,075	.003	1,19	.047	17,46	.687	✓	✓	✓
WG380I10U3PT	10	9,65	.380	0,075	.003	1,19	.047	20,75	.817	✓	✓	✓

NOTE: SSC = To correspond with the SSC on the toolholder.

INDEXABLE MILLING

SOLID END MILLING

HOLEMAKING

TAPPING

TURNING

WGC Grooving Inserts • PT Precision Ground • Metric

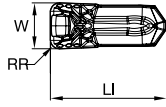

● first choice  
○ alternate choice

P	●	○	●	○
M	●	○	●	○
K	●	○	●	○
N	●	○	●	○
S	●	○	●	○
H	○	○	○	○

catalog number	SSC	W		W tol ±		RR		LI		WU10PT	WU25PT	WU35PT
		mm	in	mm	in	mm	in	mm	in			
WG0200M02P02PT	2	2,00	.079	0,025	.001	0,20	.079	8,92	.351	●	●	●
WG0300M03P02PT	3	3,00	.118	0,025	.001	0,20	.008	9,55	.376	●	●	●
WG0300M03P04PT	3	3,00	.118	0,025	.001	0,40	.016	9,55	.376	○	○	○
WG0400M04P04PT	4	4,00	.158	0,025	.001	0,40	.016	10,15	.399	○	○	○
WG0400M04P08PT	4	4,00	.158	0,025	.001	0,80	.032	10,15	.399	○	○	○
WG0500M05P04PT	5	5,00	.197	0,025	.001	0,40	.016	12,18	.480	○	○	○
WG0500M05P08PT	5	5,00	.197	0,025	.001	0,08	.032	12,20	.480	○	○	○
WG0600M06P04PT	6	6,00	.236	0,025	.001	0,40	.016	14,53	.572	○	○	○
WG0600M06P08PT	6	6,00	.236	0,025	.001	0,80	.032	14,54	.573	○	○	○

NOTE: SSC = To correspond with the SSC on the toolholder.

INDEXABLE MILLING

SOLID END MILLING

HOLEMAKING

TAPPING

TURNING



## WGC Grooving Inserts • PT Precision Ground • Inch

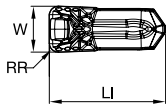

● first choice

○ alternate choice

P	<input type="checkbox"/>	<input type="checkbox"/>	<input type="checkbox"/>
M	<input type="checkbox"/>	<input type="checkbox"/>	<input type="checkbox"/>
K	<input type="checkbox"/>	<input type="checkbox"/>	<input type="checkbox"/>
N	<input type="checkbox"/>	<input type="checkbox"/>	<input type="checkbox"/>
S	<input type="checkbox"/>	<input type="checkbox"/>	<input type="checkbox"/>
H	<input type="checkbox"/>	<input type="checkbox"/>	<input type="checkbox"/>

catalog number	SSC	W		W tol ±		RR		LI		WU10PT	WU25PT	WU35PT
		mm	in	mm	in	mm	in	mm	in			
WG125I03P05PT	3	3,18	.125	0,075	.003	0,20	.008	9,55	.376		6686432	
WG188I04P08PT	4	4,76	.188	0,025	.001	0,32	.013	10,14	.399		6686433	
WG250I06P08PT	6	6,35	.250	0,075	.001	0,32	.013	14,53	.572		6686434	

NOTE: SSC = To correspond with the SSC on the toolholder.

INDEXABLE MILLING

SOLID END MILLING

HOLE/MAKING

TAPPING

TURNING

WGC Grooving Inserts • PN Precision Molded • Metric

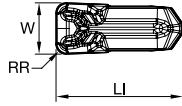

- first choice
- alternate choice

P	●	○	●	○
M	●	○	●	○
K	●	○	●	○
N	●	○	●	○
S	●	○	●	○
H	○	○	○	○

catalog number	SSC	W		W tol ±		RR		LI		WU10PT	WU25PT	WU35PT
		mm	in	mm	in	mm	in	mm	in			
WG0212M02U02PN	2	2,13	.084	0,050	.002	0,20	.008	8,97	.353	●	●	●
WG0251M02U02PN	2	2,51	.099	0,050	.002	0,20	.008	8,97	.353	●	●	●
WG0312M03U02PN	3	3,13	.123	0,075	.003	0,20	.008	9,60	.378	●	●	●
WG0312M03U04PN	3	3,13	.123	0,075	.003	0,40	.016	9,60	.378	●	●	●
WG0412M04U04PN	4	4,13	.162	0,075	.003	0,40	.016	10,20	.401	●	●	●
WG0412M04U08PN	4	4,13	.162	0,075	.003	0,80	.031	10,20	.401	●	●	●
WG0512M05U04PN	5	5,13	.202	0,075	.003	0,40	.016	12,24	.482	●	●	●
WG0512M05U08PN	5	5,13	.202	0,075	.003	0,80	.031	12,24	.482	●	●	●
WG0612M06U04PN	6	6,13	.241	0,075	.003	0,40	.016	14,59	.575	●	●	●
WG0612M06U08PN	6	6,13	.241	0,075	.003	0,80	.031	14,59	.574	●	●	●
WG0812M08U08PN	8	8,13	.320	0,075	.003	0,80	.031	17,46	.687	●	●	●
WG0812M08U12PN	8	8,13	.320	0,075	.003	1,20	.047	17,46	.687	●	●	●
WG1012M10U12PN	10	10,13	.399	0,075	.003	1,20	.047	20,75	.817	●	●	●

NOTE: SSC = Pocket Seat Reference. To correspond with the SSC on the toolholder.

INDEXABLE MILLING

SOLID END MILLING

HOLEMAKING

TAPPING

TURNING

## WGC Grooving Inserts • PN Precision Molded • Inch

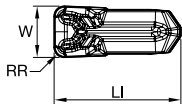

● first choice

○ alternate choice

P	●	○	●	○
M	●	○	●	○
K	●	○	●	○
N	●	○	●	○
S	●	○	●	○
H	○	○	○	○

catalog number	SSC	W		W tol ±		RR		LI		WU10PT	WU25PT	WU35PT
		mm	in	mm	in	mm	in	mm	in			
WG125I03U1PN	3	3,18	.125	0,075	.003	0,40	.016	9,60	.378	●	●	●
WG125I03U05PN	3	3,18	.125	0,075	.003	0,20	.008	9,60	.378	○	○	○
WG130I03U1PN	3	3,30	.130	0,075	.003	0,40	.016	9,60	.378	●	●	●
WG130I03U05PN	3	3,30	.130	0,075	.003	0,20	.008	9,60	.378	○	○	○
WG187I04U1PN	4	4,75	.187	0,075	.003	0,40	.016	10,19	.401	●	●	●
WG187I04U2PN	4	4,75	.187	0,075	.003	0,80	.032	10,20	.401	○	○	○
WG192I04U1PN	4	4,88	.192	0,075	.003	0,40	.016	10,20	.401	●	●	●
WG192I04U2PN	4	4,88	.192	0,075	.003	0,80	.031	10,20	.401	○	○	○
WG250I06U1PN	6	6,35	.250	0,075	.003	0,40	.016	14,58	.574	●	●	●
WG250I06U2PN	6	6,35	.250	0,075	.003	0,80	.032	14,58	.574	○	○	○
WG255I06U1PN	6	6,48	.255	0,075	.003	0,40	.016	14,58	.574	●	●	●
WG255I06U2PN	6	6,48	.255	0,075	.003	0,80	.031	14,58	.574	○	○	○

INDEXABLE MILLING

SOLID END MILLING

HOLEMAKING

TAPPING

TURNING

WGC Grooving Inserts • PN Precision Molded • Inch

(continued)

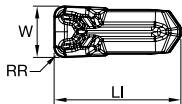

- first choice
- alternate choice

P	<input checked="" type="checkbox"/>	<input type="checkbox"/>	<input type="checkbox"/>	<input type="checkbox"/>
M	<input checked="" type="checkbox"/>	<input type="checkbox"/>	<input type="checkbox"/>	<input type="checkbox"/>
K	<input checked="" type="checkbox"/>	<input type="checkbox"/>	<input type="checkbox"/>	<input type="checkbox"/>
N	<input checked="" type="checkbox"/>	<input type="checkbox"/>	<input type="checkbox"/>	<input type="checkbox"/>
S	<input checked="" type="checkbox"/>	<input type="checkbox"/>	<input type="checkbox"/>	<input type="checkbox"/>
H	<input type="checkbox"/>	<input type="checkbox"/>	<input type="checkbox"/>	<input type="checkbox"/>

catalog number	SSC	W		W tol ±		RR		LI		WU10PT	WU25PT	WU35PT
		mm	in	mm	in	mm	in	mm	in			
WG312108U3PN	8	7,93	.312	0,075	.003	1,20	.047	17,46	.687			
WG317108U3PN	8	8,05	.317	0,075	.003	1,19	.047	17,46	.687			
WG375110U3PN	10	9,53	.375	0,075	.003	1,20	.047	20,75	.817			
WG380110U3PN	10	9,65	.380	0,075	.003	1,20	.047	20,70	.815			

NOTE: SSC = To correspond with the SSC on the toolholder.

INDEXABLE MILLING

SOLID END MILLING

HOLEMAKING

TAPPING

TURNING

## WGC Grooving Inserts • PC Full Radius Precision Ground • Metric

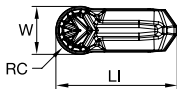

● first choice

○ alternate choice

P	●	○	●	○
M	●	○	●	○
K	●	○	●	○
N	●	○	●	○
S	●	○	●	○
H	○	○	○	○

catalog number	SSC	W		W tol ±		RC		LI		WU10PT	WU25PT	WU35PT
		mm	in	mm	in	mm	in	mm	in			
WR0200M02P00PC	2	2,00	.079	0,025	.001	1,00	.039	8,91	.351		6470467	
WR0300M03P00PC	3	3,00	.118	0,025	.001	1,50	.059	9,54	.376		6470468	
WR0400M04P00PC	4	4,00	.158	0,025	.001	2,00	.079	10,13	.399		6470469	
WR0500M05P00PC	5	5,00	.197	0,025	.001	2,50	.098	12,18	.480		6470470	
WR0600M06P00PC	6	6,00	.236	0,025	.001	3,00	.118	14,52	.572		6470481	
WR0800M08P00PC	8	8,00	.315	0,025	.001	4,00	.158	17,41	.685		6470482	

NOTE: SSC = To correspond with the SSC on the toolholder.

INDEXABLE MILLING

SOLID END MILLING

HOLE/MAKING

TAPPING

TURNING

WGC Grooving Inserts • PC Full Radius Precision Ground • Inch

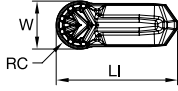

● first choice  
○ alternate choice

P	<input checked="" type="checkbox"/>	<input type="checkbox"/>	<input type="checkbox"/>	<input type="checkbox"/>
M	<input checked="" type="checkbox"/>	<input type="checkbox"/>	<input type="checkbox"/>	<input type="checkbox"/>
K	<input checked="" type="checkbox"/>	<input type="checkbox"/>	<input type="checkbox"/>	<input type="checkbox"/>
N	<input checked="" type="checkbox"/>	<input type="checkbox"/>	<input type="checkbox"/>	<input type="checkbox"/>
S	<input checked="" type="checkbox"/>	<input type="checkbox"/>	<input type="checkbox"/>	<input type="checkbox"/>
H	<input type="checkbox"/>	<input type="checkbox"/>	<input type="checkbox"/>	<input type="checkbox"/>

catalog number	SSC	W		W tol ±		RC		LI		WU10PT	WU25PT	WU35PT
		mm	in	mm	in	mm	in	mm	in			
WR125I03P00PC	3	3,18	.125	0,025	.001	1,59	.062	9,54	.376		6470263	
WR187I04P00PC	4	4,76	.188	0,025	.001	2,38	.094	10,13	.399		6470264	
WR250I06P00PC	6	6,35	.250	0,025	.001	3,18	.125	14,54	.572		6470265	
WR312I08P00PC	8	7,92	.312	0,025	.001	3,96	.156	17,40	.685		6470266	

NOTE: SSC = To correspond with the SSC on the toolholder.

INDEXABLE MILLING

SOLID END MILLING

HOLE/MAKING

TAPPING

TURNING

## Catalog Numbering System • Grooving

Each character in our catalog number signifies a specific trait of that product.  
Use the following key columns and corresponding images to easily identify which attributes apply.

WGC	S	M	R	10	02	08	C
Family Name	Tool Style	Support Type	Hand	Shank Size	Seat Size	Max Groove Depth	Coolant
WIDIA™ Grooving and Cut-Off	<b>S = Straight mount</b>	<b>M</b> = Maximum support for specific groove width and straight clearance for unlimited workpiece diameter <b>A</b> = Face grooving – inboard sweep <b>B</b> = Face grooving – outboard sweep	<b>L</b> = Left hand <b>R</b> = Right hand	<b>Metric</b> = Height x Width in mm letter indicates tool length according to ISO  <b>Inch</b> = Height x Width in 1/16" increments	1B 1F 02 03 04 05 06 08 10	in millimetres	<b>C</b> = Through the pocket coolant capable

Catalog Numbering System • Cut-Off Blades

Each character in our catalog number signifies a specific trait of that product. Use the following key columns and corresponding images to easily identify which attributes apply.

A	16	R	WGC	E	M	R	03	07	I																							
Steel Bar with Coolant	Bar Diameter	Bar Length	Platform	Tool Type	Support Type	Hand of Tool	Insert Seat Size	Max Cutting Depth	Tool Units																							
Steel boring bar with through coolant capability.	<b>Metric</b> = Diameter in mm <b>Inch</b> = Diameter in 1/16" increments		WIDIA™ Grooving and Cut-Off	<b>E</b> = End mount (90°)	<b>M</b> = Maximum support	<b>L</b> = Left hand <b>R</b> = Right hand	<b>1F</b> <b>02</b> <b>03</b> <b>04</b> <b>05</b> <b>06</b> <b>08</b> <b>10</b>	in millimeters	<b>M</b> = Metric <b>I</b> = Inch																							
		<table border="1"> <thead> <tr> <th>symbol</th> <th>mm</th> <th>inch</th> </tr> </thead> <tbody> <tr> <td>K</td> <td>125</td> <td>5</td> </tr> <tr> <td>M</td> <td>150</td> <td>6</td> </tr> <tr> <td>Q</td> <td>180</td> <td>7</td> </tr> <tr> <td>R</td> <td>200</td> <td>8</td> </tr> <tr> <td>S</td> <td>250</td> <td>10</td> </tr> <tr> <td>T</td> <td>300</td> <td>12</td> </tr> </tbody> </table>		symbol	mm	inch	K	125	5	M	150	6	Q	180	7	R	200	8	S	250	10	T	300	12								
symbol	mm	inch																														
K	125	5																														
M	150	6																														
Q	180	7																														
R	200	8																														
S	250	10																														
T	300	12																														

INDEXABLE MILLING

SOLID END MILLING

HOLE/MAKING

TAPPING

TURNING



**Catalog Numbering System • Modular Toolholders**

Each character in our catalog number signifies a specific trait of that product. Use the following key columns and corresponding images to easily identify which attributes apply.

WGC	M	S	R	16	50	C
Family Name	Modular	Tool Style	Hand	Shank Size	Blade Size	Coolant
WIDIA™ Grooving and Cut-Off		<p><b>S</b> = Straight Mount</p> <p><b>E</b> = End Mount (90°)</p>	<p><b>L</b> = Left hand</p> <p><b>R</b> = Right hand</p>	<p><b>Metric</b> = Height x Width in mm letter indicates tool length according to ISO</p> <p><b>Inch</b> = Height x Width in 1/16" increments</p>	<p><b>50</b></p> <p><b>65</b></p>	<p><b>C</b> = Through coolant capable</p>

INDEXABLE MILLING

SOLID END MILLING

HOLEMAKING

TAPPING

TURNING

### Catalog Numbering System • Modular Blades

Each character in our catalog number signifies a specific trait of that product. Use the following key columns and corresponding images to easily identify which attributes apply.

<b>WGC</b>	<b>M</b>	<b>50</b>	<b>R</b>	<b>03</b>	<b>12</b>	<b>M</b>	<b>C</b>
Family Name	Modular	Blade Size	Hand	Seat Size	Max Groove Depth	Support Type	Coolant
WIDIA™ Grooving and Cut-Off		50 65	L = Left hand R = Right hand	1B 1F 02 03 04 05 06 08 10	in millimeters	M = Maximum support for specific groove width and straight clearance for unlimited diameter	C = Through the pocket coolant capable

INDEXABLE MILLING

SOLID END MILLING

HOLE/MAKING

TAPPING

TURNING

## WGC • Integral Reinforced Front Clamp Toolholders

Each character in our catalog number signifies a specific trait of that product.  
Use the following key columns and corresponding images to easily identify which attributes apply.

<b>WGC</b>	<b>S</b>	<b>C</b>	<b>F</b>	<b>L</b>	<b>2020K</b>	<b>3</b>	<b>16</b>	<b>C</b>
<b>WGC</b>	<b>S</b>	<b>C</b>	<b>F</b>	<b>L</b>	<b>12</b>	<b>3</b>	<b>16</b>	<b>C</b>
Family Name	Tool Style	Support Type	Clamping Screw Position	Hand	Shank Size	Seat Size	Cut-Off Depth	Coolant
Widia Grooving and Cut-Off	S: Straight Mount	C: Reinforced maximum support width circular clearance	F: Front	L: Left Hand R: Right Hand	Metric: Height x Width in mm  Letter Indicates Tool Length according to ISO  Inch: Height x Width in 1/16 inch increment	1B 1F 2 3 4 5 6 8 10	in Millimeters	Through Coolant Capability

### Benefits of Front Clamp Compared to Top Clamp

Reduced Head Length for Added Stability.

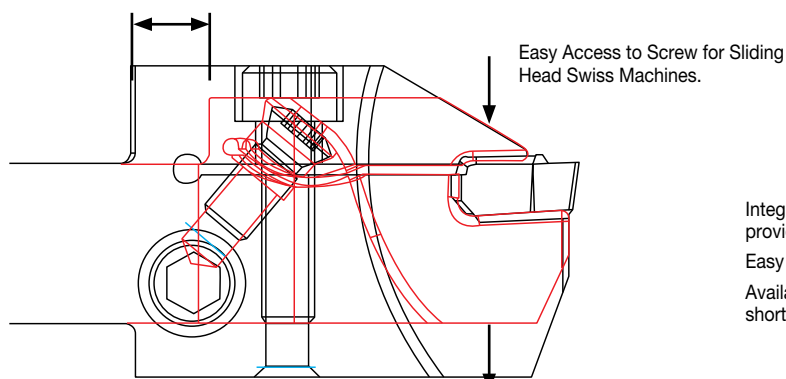

Integral reinforced Front Clamp Holders provide greater rigidity and stability.  
Easy access to clamp and unclamp screw.  
Available in small shank sizes and suitable for shorter CDs.

## WGC Separator Blades and Clamps for Universal Style Holders

- Cut-off up to 3" bar capacity.
- Insert widths .094-.188" (2,38-4,76mm).
- Quick, reliable insert indexing.
- Positive mechanical clamping.
- Common blade for RH and LH holders.
- Inserts in proven PVD grades WU10PT, WU25PT, and WU35PT.

### Toolholder Assembly:

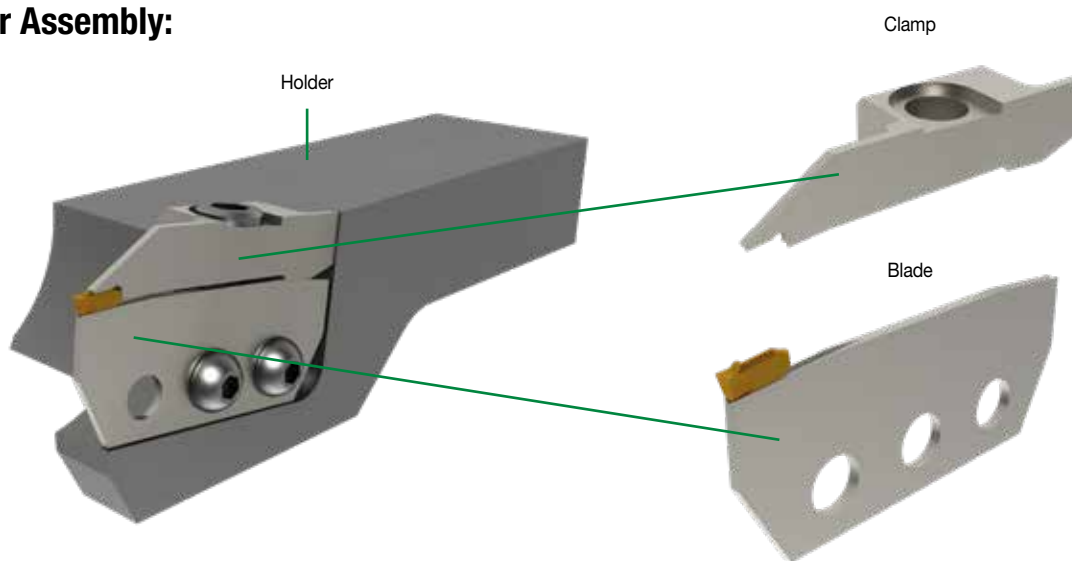

## WGC Separator Blades and Clamps for Universal Style Holders

Each character in our catalog number signifies a specific trait of that product. Use the following key columns and corresponding images to easily identify which attributes apply.

WGC	SU	N	02	28	B
Platform (WIDIA™ Grooving and Cut-Off)	Separator Universal	Hand	Pocket Seat Size	CD (mm)	
		N: Neutral R: Right L: Left			B: Blade K: Clamp

## WIDIA™ WGC Ranger Adjustable Face Grooving System

WGC Ranger is the industry's only fully adjustable face grooving platform. The system can produce face groove diameters from 2.25–16" (57,2–406mm).

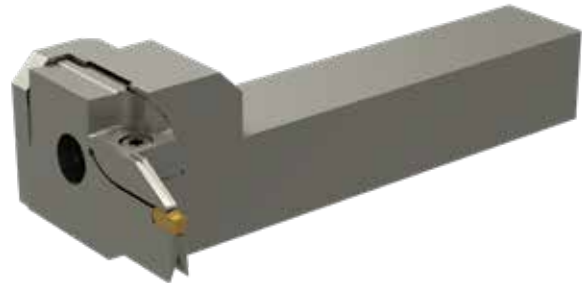

### Square Shank Toolholders

- Compact, right angle design with full 1" depth of cut capability when using .188"- and .250"-wide inserts.
- Versatile selection of curve-out cartridges, featuring .125", .188", and .250" widths.
- Inserts in grades for steels, stainless steels, non-ferrous materials, and cast iron.

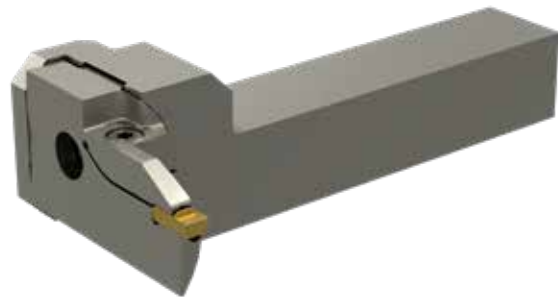

### Round Shank Bars

- Available in 1", 1.25", and 1.50" round shanks with added flexibility to use both right-hand and left-hand cartridges in the same shank.
- Versatile selection of both curve-in and curve-out cartridges to produce external and internal (through the bore) face groove styles.
- Insert widths of .125", .188", and .250" with choice of square front inserts for plunge and groove, or full nose radii for plunge, groove, and profile.



### WGC Ranger • Nomenclature

Each character in our catalog number signifies a specific trait of that product.  
Use the following key columns and corresponding images to easily identify which attributes apply.

WGC	M	RA	L	3	19	B	317
Platform (WIDIA™ Grooving and Cut-Off)	Modular	Ranger	Hand	Pocket Seat Size	CD [mm]	Style	Minimum Insert Width
			L: Left Hand R: Right Hand	3 4 6		A: Inboard B: Outboard	317: 3.17 [0.125] 476: 4.76 [0.187] 635: 6.35 [0.250]
							Use only recommended insert width or higher for a particular pocket seat size.

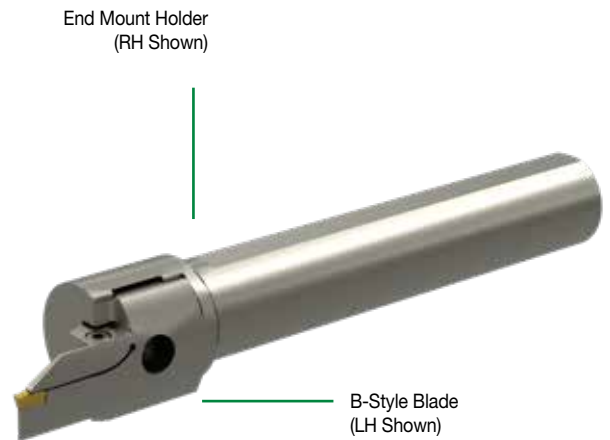
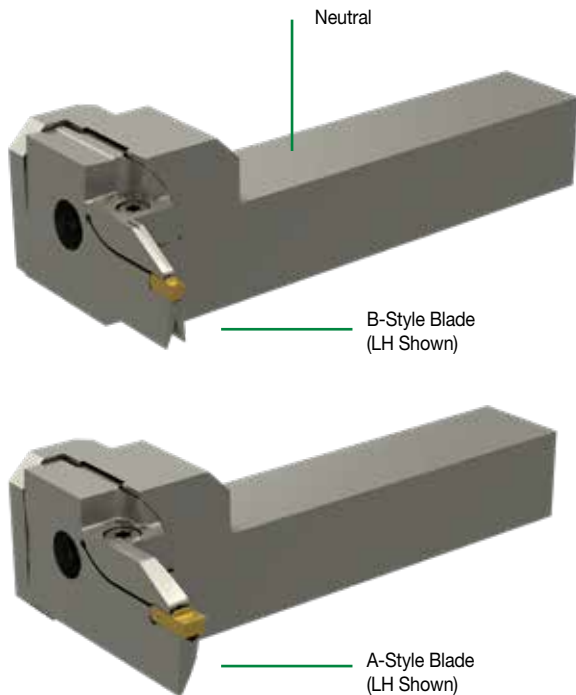

Use LH Blade for RH Holder and vice versa.

INDEXABLE MILLING

SOLID END MILLING

HOLE/MAKING

TAPPING

TURNING



WGCSM-Non Through Coolant Integral Toolholders • Integral Straight Shank



Left Hand



Right Hand

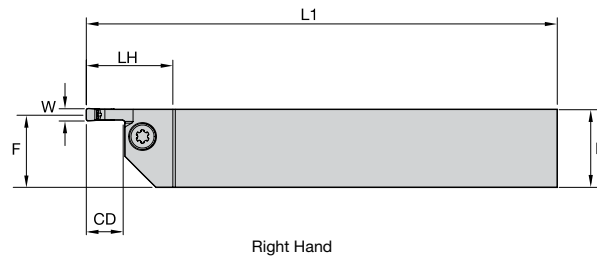
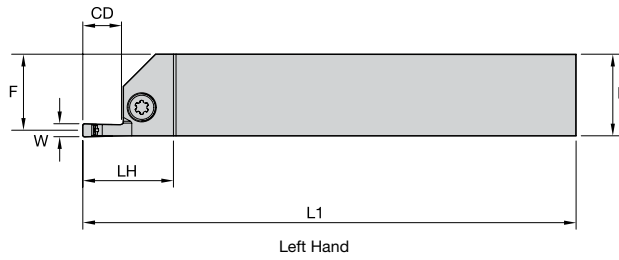
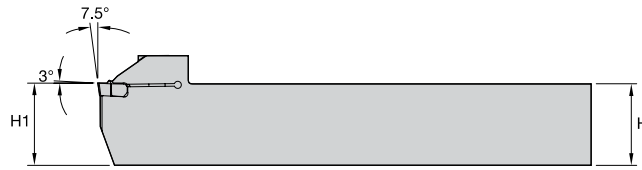

order number	catalog number	SSC	CD	H1	H	B	F	L1	W	LH
<b>right hand</b>										
6949739	WGCSMR100208	2	.32	.625	.625	.625	.63	4.50	.08	.91
6949740	WGCSMR120208	2	.32	.750	.750	.625	.75	4.50	.08	.91
6949791	WGCSMR160208	2	.32	1.000	1.000	1.000	1.00	6.00	.08	.91
6949792	WGCSMR120310	3	.39	.750	.750	.750	.75	4.50	.12	1.02
6949793	WGCSMR160310	3	.39	1.000	1.000	1.000	1.00	6.00	.12	1.02
6949794	WGCSMR120316	3	.63	.750	.750	.750	.75	4.50	.12	1.26
6949795	WGCSMR160316	3	.63	1.000	1.000	1.000	1.00	6.00	.12	1.26
6949796	WGCSMR120412	4	.47	.750	.750	.750	.75	4.50	.16	1.10
6949797	WGCSMR160412	4	.47	1.000	1.000	1.000	1.00	6.00	.16	1.10
<b>left hand</b>										
6949798	WGCSML100208	2	.32	.625	.625	.625	.63	4.50	.08	.91
6949799	WGCSML120208	2	.32	.750	.750	.750	.75	4.50	.08	.91
6949800	WGCSML160208	2	.32	1.000	1.000	1.000	1.00	6.00	.08	.91
6949801	WGCSML120310	3	.39	.750	.750	.750	.75	4.50	.12	1.02
6949802	WGCSML160310	3	.39	.985	.985	1.000	1.00	6.00	.12	1.02
6949803	WGCSML120316	3	.63	.750	.750	.750	.75	4.50	.12	1.26
6949804	WGCSML160316	3	.63	.985	.985	1.000	1.00	6.00	.12	1.26
6949805	WGCSML120412	4	.47	.750	.750	.750	.75	4.50	.16	1.10
6949806	WGCSML160412	4	.47	1.000	1.000	1.000	1.00	6.00	.16	1.10

NOTE: SSC = Pocket Seat Reference. To correspond with the SSC on the insert.

INDEXABLE MILLING

SOLID END MILLING

HOLEMAKING

TAPPING

TURNING



WGC Integral Toolholders • Reinforced Front Clamp • Inch

INDEXABLE MILLING

SOLID END MILLING

HOLEMAKING

TAPPING

TURNING



Right Hand

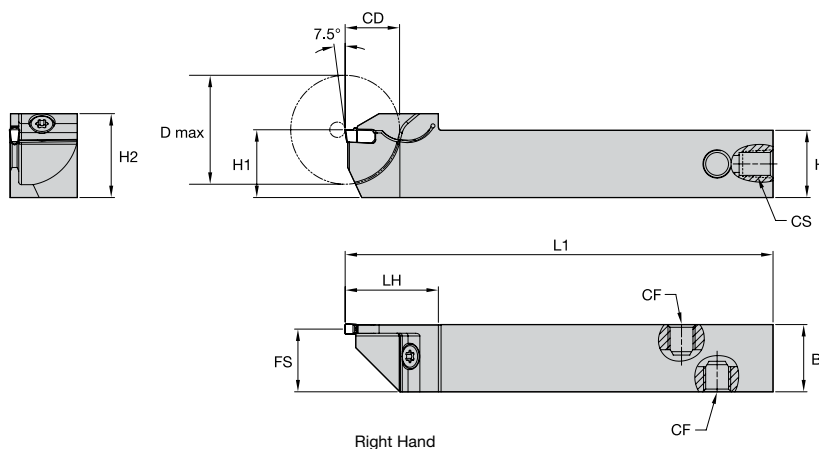

Left Hand

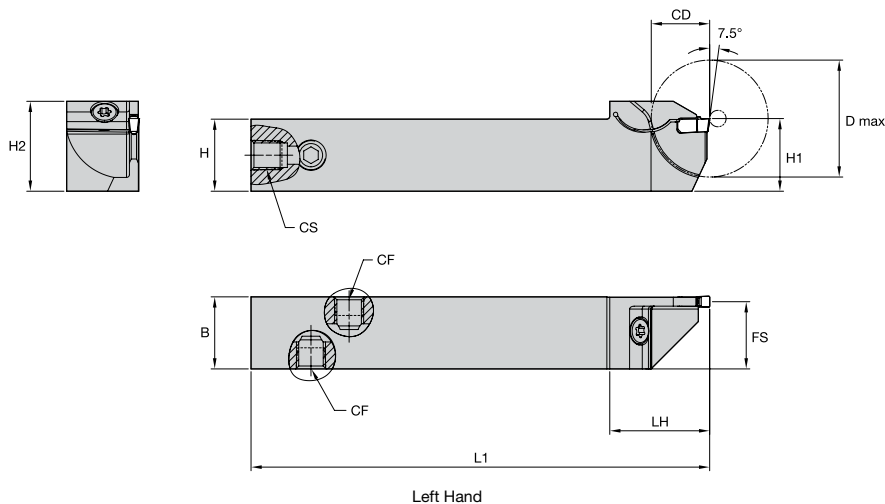

order number	catalog number	SSC	CD	D max	H1	H	B	H2	L1	FS	LH	CF
<b>right hand</b>												
6765342	WGCSCFR060210	2	.39	.787	.375	.375	.375	.53	4.50	.34	.81	—
6765348	WGCSCFR080216	2	.63	1.260	.500	.500	.500	.66	4.50	.46	1.04	—
6765350	WGCSCFR100216	2	.63	1.260	.625	.625	.625	.80	4.50	.59	1.04	—
6765402	WGCSCFR120216	2	.63	1.260	.750	.750	.750	.93	4.50	.71	1.04	—
6765349	WGCSCFR080316C	3	.63	1.260	.500	.500	.500	.69	4.50	.44	1.08	M8X1
6765401	WGCSCFR100316C	3	.63	1.260	.625	.625	.625	.81	4.50	.57	1.08	M8X1
6765403	WGCSCFR120316C	3	.63	1.260	.750	.750	.750	.94	4.50	.69	1.08	M8X1
<b>left hand</b>												
6765325	WGCSCFL060210	2	.39	.787	.375	.375	.375	.53	4.50	.34	.81	—
6765326	WGCSCFL080216	2	.63	1.260	.500	.500	.500	.66	4.50	.46	1.04	—
6765327	WGCSCFL100216	2	.63	1.260	.625	.625	.625	.82	4.50	.59	1.04	—
6765330	WGCSCFL120216	2	.63	1.260	.750	.750	.750	.93	4.50	.71	1.04	—
6656188	WGCSCFL080316C	3	.63	1.260	.500	.500	.500	.69	4.50	.44	1.08	M8X1
6765329	WGCSCFL100316C	3	.63	1.260	.625	.625	.625	.81	4.50	.57	1.08	M8X1
6765341	WGCSCFL120316C	3	.63	1.260	.750	.750	.750	.94	4.50	.69	1.08	M8X1

NOTE: SSC = Pocket Seat Reference. To correspond with the SSC on the insert.

WGC • Modular Toolholders • Endmount • with Coolant • Inch

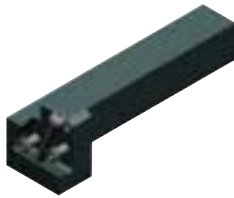

M50 Blade Right Hand

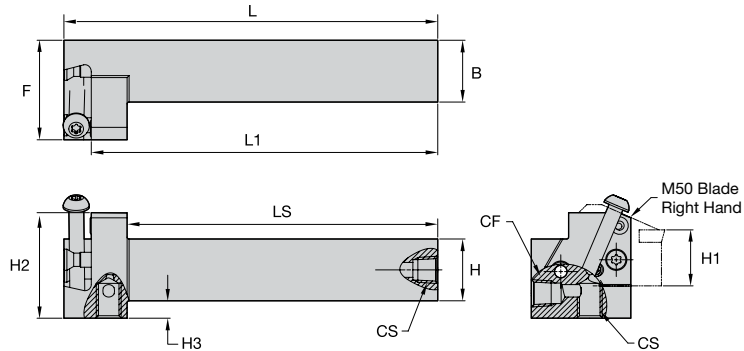

M65 Blade Left Hand

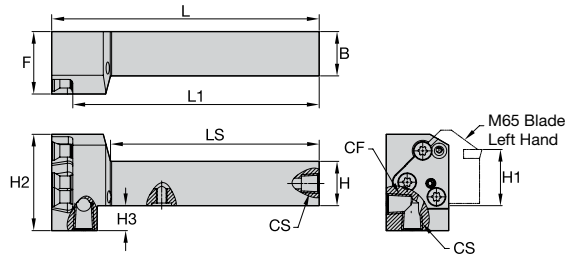

order number	catalog number	B	H	H1	L	L1	LS	F	CS	CF	H2	H3	blade size
<b>right hand</b>													
6498941	WGCMER1650C	1.00	1.00	1.00	6.0	5.5	4.96	.47	G 1/8-28	G 1/8-28	1.67	.25	50
6498942	WGCMER1665C	1.00	1.00	1.00	6.0	5.5	4.70	1.38	G 1/8-28	G 1/8-28	2.09	.50	65
6498943	WGCMER2050C	1.25	1.25	1.25	6.0	5.5	4.96	.47	G 1/8-28	G 1/8-28	1.67	—	50
6498944	WGCMER2065C	1.25	1.25	1.25	6.0	5.5	4.70	1.38	G 1/8-28	G 1/8-28	2.09	.25	65
6498945	WGCMER2450C	1.50	1.50	1.50	6.0	5.5	4.96	.47	G 1/8-28	G 1/8-28	1.92	—	50
6498946	WGCMER2465C	1.50	1.50	1.50	7.0	6.5	5.70	1.49	G 1/8-28	G 1/8-28	2.09	—	65
<b>left hand</b>													
6498947	WGC MEL1650C	1.00	1.00	1.00	6.0	5.5	4.96	.47	G 1/8-28	G 1/8-28	1.67	.25	50
6498948	WGC MEL1665C	1.00	1.00	1.00	6.0	5.5	4.70	1.38	G 1/8-28	G 1/8-28	2.09	.50	65
6498949	WGC MEL2050C	1.25	1.25	1.25	6.0	5.5	4.96	.47	G 1/8-28	G 1/8-28	1.67	—	50
6498950	WGC MEL2065C	1.25	1.25	1.25	6.0	5.5	4.70	1.38	G 1/8-28	G 1/8-28	2.09	.25	65
6498951	WGC MEL2450C	1.50	1.50	1.50	6.0	5.5	4.96	.47	G 1/8-28	G 1/8-28	1.92	—	50
6498952	WGC MEL2465C	1.50	1.50	1.50	7.0	6.5	5.70	1.49	G 1/8-28	G 1/8-28	2.09	—	65

NOTE: WGCMS.: Right-hand holder uses right-hand blades.  
 WGCME.: Right-hand holder uses left-hand blades.  
 M50 blade and clamp screw torque equals 71–88 in. lbs. (8–10 Nm).  
 M65 blade and clamp screw torque equals 159–177 in. lbs. (18–20 Nm).

screw catalog number	screw order number	Nm	torque in. lbs.	thread	socket	wrench catalog number	wrench order number
MS1160	1099645	7	62	M5	T20	KT20	1022703
MS1162	1127019	9	80	M6	T25	KT25	1022725
MS1163	1124104	18	159	M8	T30	KT30L	1099676
MS1273	1020977	4	35.4	M4	T15	KT15	1022701
MS1490	2263299	17	151	M8	T45	KT45	1018227
MS1595	1094300	12	106	M6	T30	KT30	1099676
MS1970	1106668	12	106	M6	T30	KT30	1099676
MS2002	1621087	9	80	M6	T25	KT25	1022725
MS2091	1931147	9	80	M5	25IP	K25IP	2050113

## WGC • Modular Toolholders • Endmount • with Coolant • Inch

INDEXABLE MILLING

SOLID END MILLING

HOLEMAKING

TAPPING

TURNING



M50 Blade Right Hand

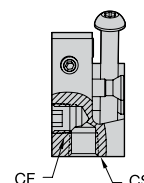
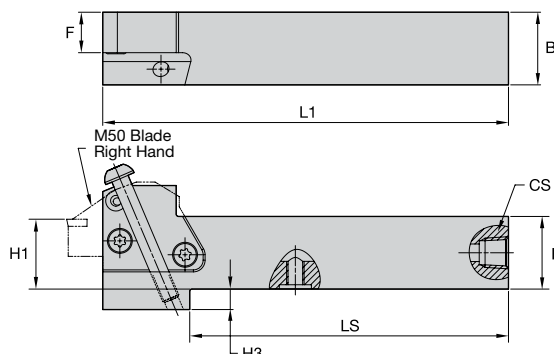

M65 Blade Left Hand

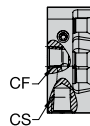
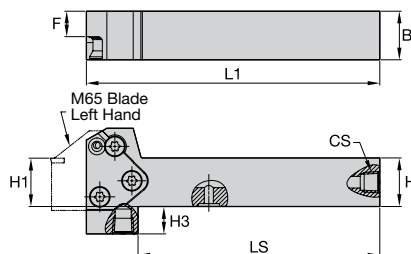

order number	catalog number	H	H1	B	L1	LS	F	CS	CF	H3	blade size
<b>right hand</b>											
6499230	WGCMR1650C	1.00	1.00	1.00	5.5	4.33	.56	G 1/8-28	G 1/8-28	.25	50
6499271	WGCMR1665C	1.00	1.00	1.00	6.0	4.90	.53	G 1/8-28	G 1/8-28	—	65
6499272	WGCMR2050C	1.25	1.25	1.25	5.5	4.52	.81	G 1/8-28	G 1/8-28	—	50
6499273	WGCMR2065C	1.25	1.25	1.25	6.0	4.90	.78	G 1/8-28	G 1/8-28	—	65
6499274	WGCMR2450C	1.50	1.50	1.50	5.5	4.52	1.06	G 1/8-28	G 1/8-28	—	50
6499275	WGCMR2465C	1.50	1.50	1.50	7.0	5.90	1.03	G 1/8-28	G 1/8-28	—	65
<b>left hand</b>											
6499276	WGMSL1650C	1.00	1.00	1.00	5.5	4.33	.56	G 1/8-28	G 1/8-28	.25	50
6499277	WGMSL1665C	1.00	1.00	1.00	6.0	4.90	.53	G 1/8-28	G 1/8-28	—	65
6499278	WGMSL2050C	1.25	1.25	1.25	5.5	4.52	.81	G 1/8-28	G 1/8-28	—	50
6499279	WGMSL2065C	1.25	1.25	1.25	6.0	4.90	.78	G 1/8-28	G 1/8-28	—	65
6499280	WGMSL2450C	1.50	1.50	1.50	5.5	4.52	1.06	G 1/8-28	G 1/8-28	—	50
6499281	WGMSL2465C	1.50	1.50	1.50	7.0	5.90	1.03	G 1/8-28	G 1/8-28	—	65

NOTE: WGCMs.: Right-hand holder uses right-hand blades.

WGCMe.: Right-hand holder uses left-hand blades.

M50 blade and clamp screw torque equals 71–88 in. lbs. (8–10 Nm).

M65 blade and clamp screw torque equals 159–177 in. lbs. (18–20 Nm).

screw catalog number	screw order number	torque		thread	socket	wrench catalog number	wrench order number
		Nm	in. lbs.				
MS1160	1099645	7	62	M5	T20	KT20	1022703
MS1162	1127019	9	80	M6	T25	KT25	1022725
MS1163	1124104	18	159	M8	T30	KT30L	1099676
MS1273	1020977	4	35.4	M4	T15	KT15	1022701
MS1490	2263299	17	151	M8	T45	KT45	1018227
MS1595	1094300	12	106	M6	T30	KT30	1099676
MS1970	1106668	12	106	M6	T30	KT30	1099676
MS2002	1621087	9	80	M6	T25	KT25	1022725
MS2091	1931147	9	80	M5	25IP	K25IP	2050113

WGCM-S-C • WGC Modular Straight Blade with Coolant

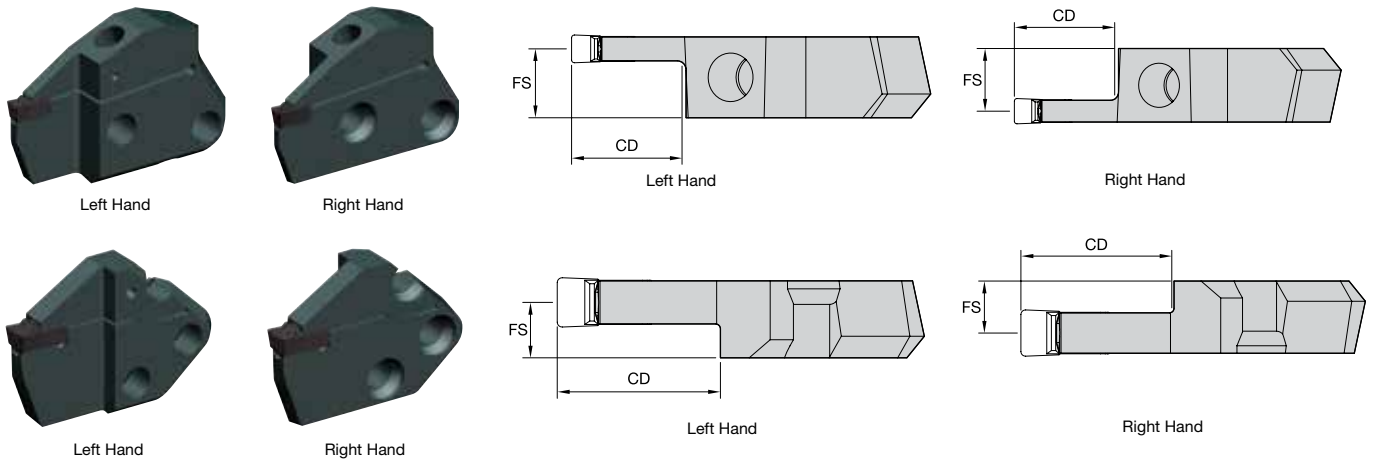

order number	catalog number	SSC	CD	FS	blade size
<b>right hand</b>					
6498457	WGCM50R1F12M	1F	12,0	11,00	50
6498458	WGCM50R0212M	2	12,0	10,88	50
6498459	WGCM50R0216M	2	16,0	10,88	50
6498460	WGCM50R0312MC	3	12,0	10,43	50
6498861	WGCM50R0322MC	3	22,0	10,43	50
6498862	WGCM50R0412MC	4	12,0	9,93	50
6498863	WGCM50R0422MC	4	22,0	9,93	50
6498864	WGCM50R0432MC	4	32,0	9,93	50
6498865	WGCM50R0512MC	5	12,0	9,43	50
6498866	WGCM50R0516MC	5	16,0	9,43	50
6498867	WGCM50R0526MC	5	26,0	9,43	50
6498868	WGCM50R0532MC	5	32,0	9,43	50
6498869	WGCM65R0616MC	6	16,0	9,88	65
6498870	WGCM65R0626MC	6	26,0	9,88	65
6498881	WGCM65R0632MC	6	32,0	9,88	65
6498882	WGCM65R0816MC	8	16,0	9,00	65
6498883	WGCM65R0826MC	8	26,0	9,00	65
<b>left hand</b>					
6498884	WGCM50L1F12M	1F	12,0	11,00	50
6498885	WGCM50L0212M	2	12,0	10,88	50
6498886	WGCM50L0216M	2	16,0	10,88	50
6498887	WGCM50L0312MC	3	12,0	10,43	50
6498888	WGCM50L0322MC	3	22,0	10,43	50
6498889	WGCM50L0412MC	4	12,0	9,93	50
6498890	WGCM50L0422MC	4	22,0	9,93	50
6498891	WGCM50L0432MC	4	32,0	9,93	50
6498892	WGCM50L0512MC	5	12,0	9,43	50
6498893	WGCM50L0516MC	5	16,0	9,43	50
6498894	WGCM50L0526MC	5	26,0	9,43	50
6498895	WGCM50L0532MC	5	32,0	9,43	50
6498896	WGCM65L0616MC	6	16,0	9,88	65
6498897	WGCM65L0626MC	6	26,0	9,88	65
6498898	WGCM65L0632MC	6	32,0	9,88	65
6498899	WGCM65L0816MC	8	16,0	9,00	65
6498900	WGCM65L0826MC	8	26,0	9,00	65

NOTE: SSC = Pocket Seat Reference. To correspond with the SSC on the insert.  
Through the pocket coolant available in seat sizes 3 and higher.

INDEXABLE MILLING

SOLID END MILLING

HOLEMAKING

TAPPING

TURNING

WGC • Integral I.D. Grooving Boring Bars • Inch



Right Hand



Left Hand

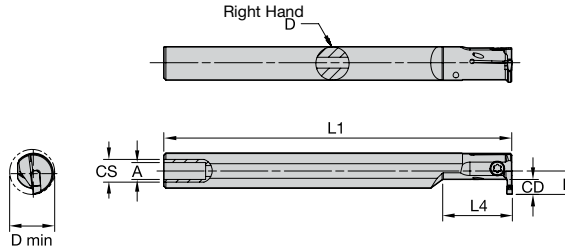
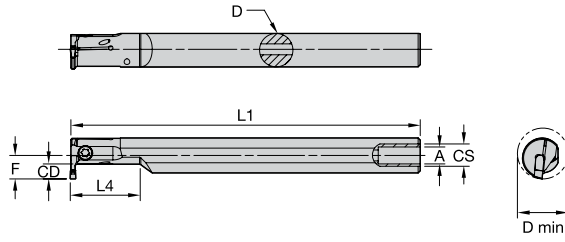

Left Hand

order number	catalog number	SSC	D	D min	CD	L1	F	L4	A	CS
<b>right hand</b>										
6949807	A08KWGCER0205I	2	.500	.625	.197	5.000	.336	1.000	.156	1/16 - 27 NPT
6949808	A10MWGCER0207I	2	.625	.787	.276	6.000	.436	1.250	.156	1/8 - 27 NPT
6949809	A12QWGCER0207I	2	.750	.984	.276	7.000	.550	1.500	.156	1/8 - 27 NPT
6949810	A16RWGCER0210I	2	1.000	1.250	.394	8.000	.681	2.000	.156	1/4 - 18 NPT
6949811	A10MWGCER0307I	3	.625	.787	.276	6.000	.436	1.250	.156	1/8 - 27 NPT
6949812	A12QWGCER0307I	3	.750	.984	.276	7.000	.549	1.500	.156	1/8 - 27 NPT
6949813	A16RWGCER0310I	3	1.000	1.250	.394	8.000	.681	2.000	.156	1/4 - 18 NPT
6949814	A16RWGCER0410I	4	1.000	1.250	.394	8.000	.681	2.500	.156	1/4 - 18 NPT
<b>left hand</b>										
6949815	A08KWGCML0205I	2	.500	.625	.197	5.000	.336	1.000	.156	1/16 - 27 NPT
6949816	A10MWGCML0207I	2	.625	.787	.276	6.000	.436	1.250	.156	1/8 - 27 NPT
6949817	A12QWGCML0207I	2	.750	.984	.276	7.000	.550	1.500	.156	1/8 - 27 NPT
6949818	A16RWGCML0210I	2	1.000	1.250	.394	8.000	.681	2.000	.156	1/4 - 18 NPT
6949819	A10MWGCML0307I	3	.625	.787	.276	6.000	.436	1.250	.156	1/8 - 27 NPT
6949820	A12QWGCML0307I	3	.750	.984	.276	7.000	.549	1.500	.156	1/8 - 27 NPT
6949821	A16RWGCML0310I	3	1.000	1.250	.394	8.000	.681	2.000	.156	1/4 - 18 NPT
6949822	A16RWGCML0410I	4	1.000	1.250	.394	8.000	.681	2.500	.156	1/4 - 18 NPT

NOTE: SSC = Pocket Seat Reference. To correspond with the SSC on the insert.

WGC • Blade Holders • Inch

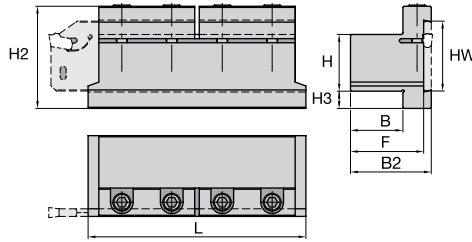

order number	catalog number	HW	H	B	F	H2	B2	H3	L
<b>neutral hand</b>									
2968845	32251221200	1.024	.750	.750	1.161	1.57	1.34	.32	3.39
2968846	32251221600	1.260	1.000	1.000	1.417	1.89	1.63	.30	4.33
2968847	32251222000	1.260	1.250	1.250	1.673	1.97	1.89	.13	4.33

WGC • Double-Ended Cut-Off Blade



Straight

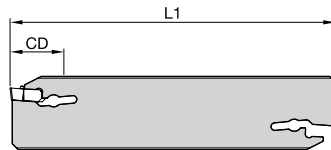

Straight

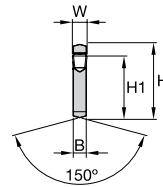

Reinforced

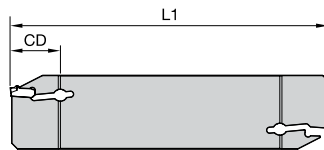

Reinforced

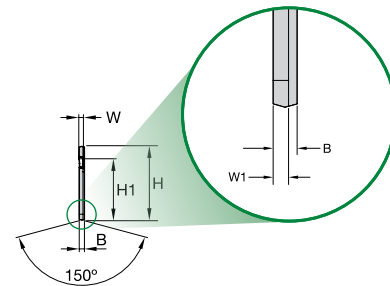

order number	catalog number	SSC	H	W	W1	H1	L1	B	CD
<b>neutral hand</b>									
6498987	WGCBSN19G1B14	1B	19	1,4	1,15	15,5	90	1,80	14
6498988	WGCBSN26J1B15	1B	26	1,4	1,15	21,5	110	1,80	15
6498989	WGCBSN19G1F16	1F	19	1,6	1,30	15,5	90	1,80	16
6498990	WGCBSN26J1F17	1F	26	1,6	1,30	21,5	110	1,80	17
6499211	WGCBSN19G0220	2	19	2,0	—	15,5	90	1,65	20
6499212	WGCBSN26J0230	2	26	2,0	—	21,5	110	1,65	30
6499213	WGCBSN32M0250	2	32	2,0	—	25,1	150	1,65	50
6499214	WGCBSN26J0340	3	26	3,0	2,40	21,5	110	2,40	40
6499215	WGCBSN32M0350	3	32	3,0	2,40	25,1	150	2,40	50
6499216	WGCBSN26J0440	4	26	4,0	3,40	21,5	110	3,40	40
6499217	WGCBSN32M0450	4	32	4,0	3,40	25,1	150	3,40	50
6499218	WGCBSN32M0560	5	32	5,0	4,40	25,1	150	4,40	60
6499219	WGCBSN32M0660	6	32	6,0	5,40	25,1	150	5,40	60
6499220	WGCBSN32M0860	8	32	8,0	7,00	25,1	150	7,00	60
6499221	WGCBSN52X08120	8	53	8,0	7,00	45,3	260	7,00	120

NOTE: SSC = Pocket Seat Reference. To correspond with the SSC on the insert.

WGC Separator Universal Style Toolholder • 2¼" Bar Capacity

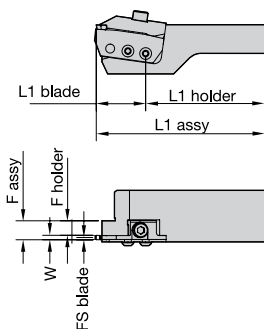

order number	catalog number	B	H	H2	F	L1	L
<b>right hand</b>							
3538667	206128	.812	.750	1.719	1.334	2.747	4.270
3538658	206113	1.062	1.000	1.719	1.584	4.247	5.770
3538665	206123	1.062	1.000	1.719	1.584	3.247	4.770
<b>left hand</b>							
3538662	206118	.812	.750	1.719	1.334	2.747	4.270
3538668	206136	1.062	1.000	1.719	1.584	3.247	4.770

W	L1	FS	left hand clamp	clamp for toolholder 206118 only	support blade	clamp for toolholder 206128 only	right hand clamp
.094	1.752	.036	435149	435151	310109	435150	435148
.125	1.752	.050	435104	435110	310102	435116	435101
.188	1.752	.072	435105	435109	310108	435117	435102

NOTE: Ships with blade and clamp screws.  
 Support blade requires two screws.  
 .750" shank holders 206118 and 206128 use different clamps.  
 Please use right hand clamp with right hand holder or left hand clamp with left hand holder.

WGC Separator Universal Style Toolholder • 3" Bar Capacity

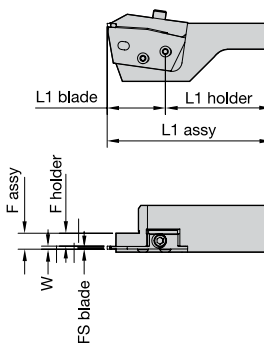

order number	catalog number	B	H	H2	F	L1	L
<b>right hand</b>							
3538660	206115	.964	1.000	2.219	1.454	3.754	5.640
3538661	206116	1.064	1.000	2.219	1.554	3.754	5.640
3587587	206121	1.194	1.250	2.219	1.684	4.004	5.890
<b>left hand</b>							
3563799	206110	1.074	1.000	2.219	1.564	3.304	5.190
3538663	206119	1.104	1.000	2.219	1.594	3.754	5.640

W	L1	FS	left hand clamp	support blade	right hand clamp
.125	2.246	.050	435137	309111	435136
.188	2.246	.072	435106	309105	435103
.250	2.246	.094	435107	309106	435108

NOTE: Ships with blade and clamp screws.  
 Support blade requires two screws.  
 Please use right hand clamp with right hand holder or left hand clamp with left hand holder.

INDEXABLE MILLING

SOLID END MILLING

HOLEMAKING

TAPPING

TURNING

**WGCMSU-B • WGC Separator Universal Blade • for 2¼" Bar Capacity**

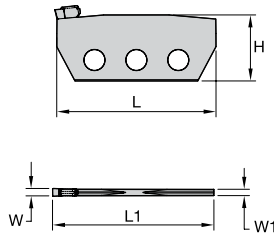

order number	catalog number	SSC	H	FS	L	LPR
<b>neutral hand</b>						
6788445	WGCSUN0228B	2	25,40	,825	60,325	60,325
6788446	WGCSUN0328B	3	25,00	1,200	60,325	60,325
6788447	WGCSUN0428B	4	24,70	1,700	60,325	60,325

NOTE: SSC = Pocket Seat Reference. To correspond with the SSC on the insert.  
Through the pocket coolant available in seat sizes 3 and higher.

**WGCMSU-B • WGC Separator Universal Blade • for 3" Bar Capacity**

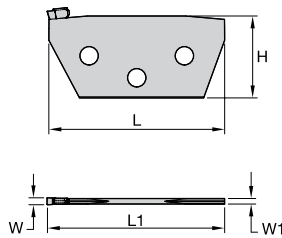

order number	catalog number	SSC	H	FS	L	LPR
<b>neutral hand</b>						
6788453	WGCSUN0338B	3	35,50	1,200	76,200	76,200
6788454	WGCSUN0438B	4	35,20	1,700	76,200	76,200

NOTE: SSC = Pocket Seat Reference. To correspond with the SSC on the insert.  
Through the pocket coolant available in seat sizes 3 and higher.

INDEXABLE MILLING

SOLID END MILLING

HOLE/MAKING

TAPPING

TURNING



### WGC Ranger Toolholder • Square Shank

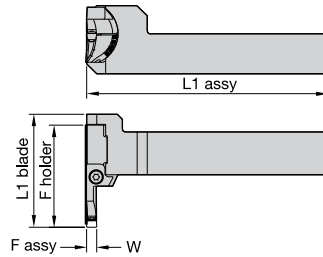

order number	catalog number	B	B3	F	H	H2	L1	LS
<b>right hand</b>								
3538797	235104	1.06	.44	-.19	1.00	1.69	5.963	4.475
<b>left hand</b>								
3538800	235107	1.06	.44	-.19	1.00	1.69	5.963	4.475
3538801	235108	1.06	.44	-.19	1.25	1.94	5.963	4.475

NOTE: The toolholder shank is supplied with the support blade mounting screw, 606218, and nut, 61317. Order the insert and cartridge separately. Select left-hand cartridge for right-hand toolholder. Select right-hand cartridge for left-hand toolholder.

### WGC Ranger Toolholder • Round Shank • Universal Shank for RH and LH Assemblies

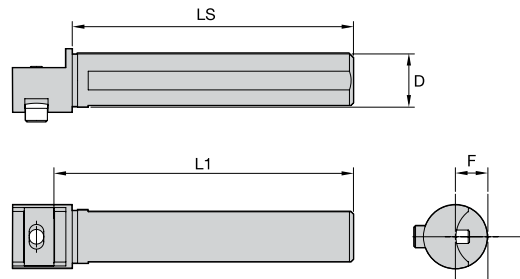

order number	catalog number	D	L1	LS	F
<b>neutral hand</b>					
3538803	235110	1.000	6.750	6.600	.763
3538802	235109	1.250	6.750	6.600	.763
3538794	235101	1.500	6.750	6.500	.763

NOTE: Select right-hand cartridge for right-hand assembly. Select left-hand cartridge for left-hand assembly. Round shank bars are supplied with the support blade mounting screw, 619155, and washer, 613135. Order the insert and cartridge separately.

WGCRM-A • WGC Ranger Single-Ended Modular Blades

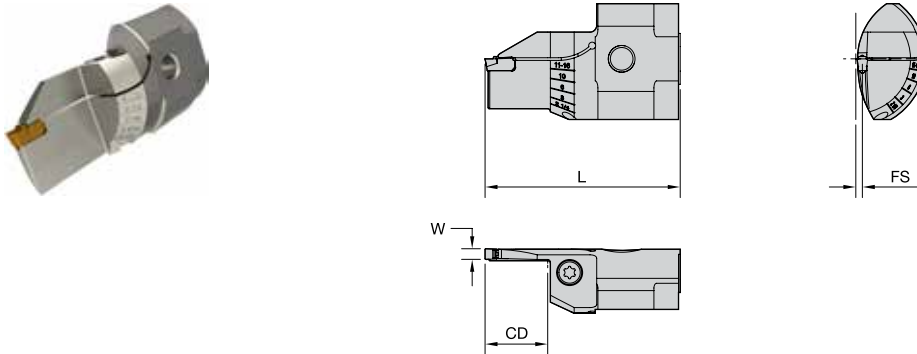

order number	catalog number	SSC	W	CD	D min	D max	FS	L
<b>right hand</b>								
6740385	WGCMRAR0319A317	3	.125	19,1	2,25	16,00	-1,63	2,30
6740386	WGCMRAR0425A476	4	.188	25,4	2,25	16,00	-2,42	2,55
6740387	WGCMRAR0625A635	6	.250	25,4	2,25	16,00	-3,23	2,55
<b>left hand</b>								
6740382	WGCMRAL0319A317	3	.125	19,1	2,25	16,00	-1,63	2,30
6740383	WGCMRAL0425A476	4	.188	25,4	2,25	16,00	-2,42	2,55
6740384	WGCMRAL0625A635	6	.250	25,4	2,25	16,00	-3,23	2,55

NOTE: SSC = Pocket Seat Reference. To correspond with the SSC on the insert.  
Through the pocket coolant available in seat sizes 3 and higher.

WGCRM-B • WGC Ranger Single-Ended Modular Blades

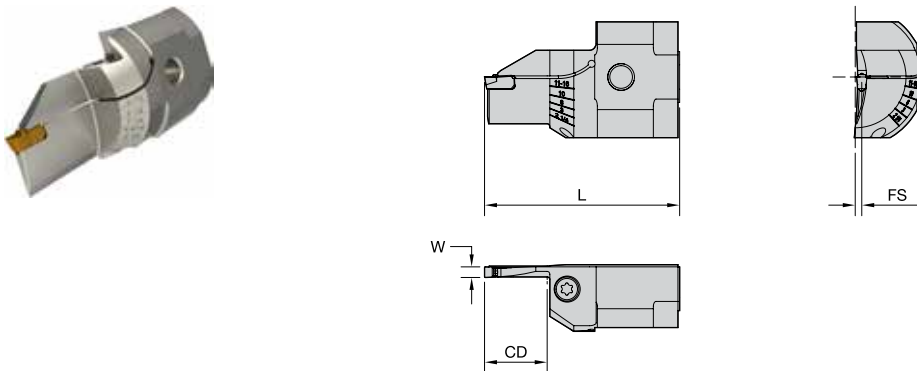

order number	catalog number	SSC	W	CD	D min	D max	FS	L
<b>right hand</b>								
6740411	WGCMRAR0319B317	3	.125	19,1	2,25	16,00	-1,55	2,30
6740412	WGCMRAR0425B476	4	.188	25,4	2,25	16,00	-2,34	2,55
6740413	WGCMRAR0625B635	6	.250	25,4	2,25	16,00	-3,13	2,55
<b>left hand</b>								
6740388	WGCMRAL0319B317	3	.125	19,1	2,25	16,00	-1,55	2,30
6740389	WGCMRAL0425B476	4	.188	25,4	2,25	16,00	-2,34	2,55
6740390	WGCMRAL0625B635	6	.250	25,4	2,25	16,00	-,31	2,55

NOTE: SSC = Pocket Seat Reference. To correspond with the SSC on the insert.  
Through the pocket coolant available in seat sizes 3 and higher.

INDEXABLE MILLING

SOLID END MILLING

HOLEMAKING

TAPPING

TURNING

## WGC Ranger™ - Technical Information

### Application Information:

- When changing inserts, be sure the new insert locates against the positive stop on the blade.
- Never tighten the insert clamping screw without an insert in the pocket. Permanent damage to the clamp could occur.
- Toolholder projection length out of the tool block should be as short as possible to maintain rigidity.
- Slower speeds and feeds are recommended compared to O.D. grooving.

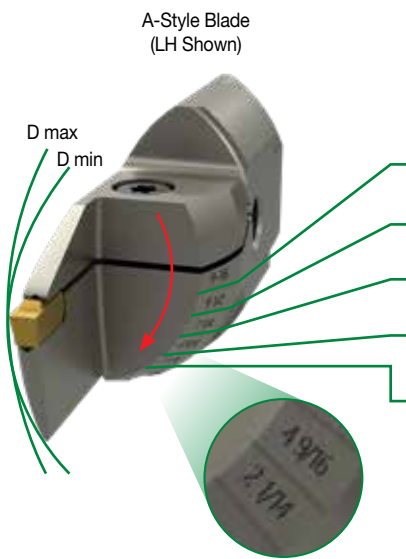

Blade Marking	D min	D max
	[Inch]	[Inch]
	Metric	Metric
9-16	[9] 228.6	[16] 406.4
9 1/2	[8] 203.2	[11] 279.4
7 1/4	[5] 127	[9.5] 241.3
4 9/16	[3.375] 85.725	[5.75] 146.05
2 1/4	[2.25] 57.15	[3.5] 88.9

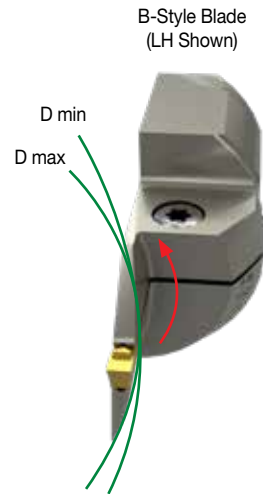

NOTE: Align Each Blade Marking Against Holder Marking to get the Right D min-D max. Tool Pre-setting recommended after each setting.

### WGC Ranger™ Blade Setting positions

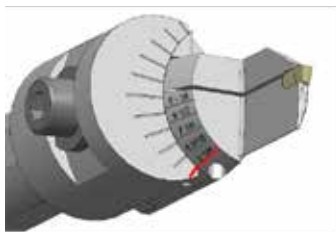

Mark = 2 1/4 setting,  
D min = 2.25" D max = 3.5"

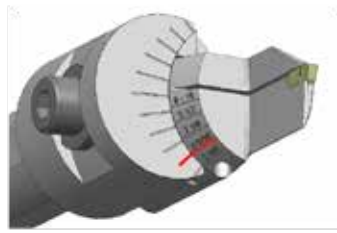

Mark = 4 9/16 setting,  
D min = 3.375" D max = 5.75"

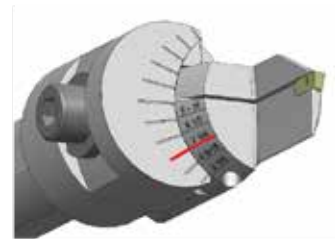

Mark = 7 1/4 setting,  
D min = 5" D max = 9.5"

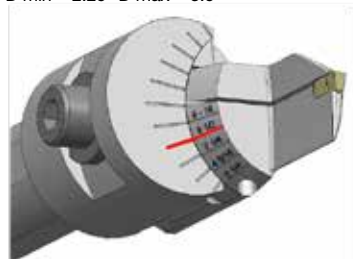

Mark = 9 1/2 setting,  
D min = 8" D max = 11"

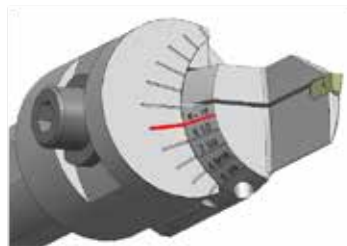

Mark = 9-16 setting,  
D min = 9" D max = 16"

WGC Ranger™ Blade vs Old Ranger Blade Cross-Reference

WGC Ranger Blade mm#	ANSI Catalog #	ISO Catalog #	Ranger Blade mm#	Ranger Blade Catalog #
6740382	WGCMRAL0319A317	WGCMRAL0319A317	3539537	338-123
6740383	WGCMRAL0425A476	WGCMRAL0425A476	3539538	338-124
6740384	WGCMRAL0625A635	WGCMRAL0625A635	3539546	338-132
6740385	WGCMRAR0319A317	WGCMRAR0319A317	3539535	338-121
6740386	WGCMRAR0425A476	WGCMRAR0425A476	3539536	338-122
6740387	WGCMRAR0625A635	WGCMRAR0625A635	3539545	338-131
6740388	WGCMRAL0319B317	WGCMRAL0319B317	3539539	338-125
6740389	WGCMRAL0425B476	WGCMRAL0425B476	3539540	338-126
6740390	WGCMRAL0625B635	WGCMRAL0625B635	3539541	338-127
6740411	WGCMRAR0319B317	WGCMRAR0319B317	3539542	338-128
6740412	WGCMRAR0425B476	WGCMRAR0425B476	3539543	338-129
6740413	WGCMRAR0625B635	WGCMRAR0625B635	3539544	338-130

Coolant Kit

Kit Description	Order Number	Shank Size	Coolant Pressure	Component Description												
				Component Order Number												
				1/16 NPTF MALE TO JIC MALE	1/8 NPTF MALE TO JIC MALE	M8 X 1.25 MALE TO JIC MALE	M8 X 1.0 MALE TO JIC MALE	G1/8 MALE TO JIC MALE	M10 MALE TO JIC MALE	MALE JIC TO FEMALE JIC ELBOW	HEAVY-DUTY 200MM COOLANT HOSE	HEAVY-DUTY 300MM COOLANT HOSE	UNIV 200MM FLEX COOLANT HOSE	UNIV 300MM FLEX COOLANT HOSE	M8X1.0 BANJO 200MM FLEX HOSE	G1/8 BANJO 200MM FLEX HOSE
6145374	6145375	6145378	6475041	6145376	6145377	6145379	6145380	6145381	6432549	6432550	6475043	6475045	6475047	6475049		
<i>Universal 200mm flex hose coolant kit</i>	<b>6475019</b>	12-40mm 1/2-1-1/2"	200 Bar 2901 psi		•	•	•	•	•	•		•				
<i>Universal 300mm flex hose coolant kit</i>	<b>6475021</b>	12-40mm 1/2-1-1/2"	200 Bar 2901 psi	•	•	•	•	•	•			•				
<i>M8x1.0 banjo 200mm flex hose coolant kit</i>	<b>6475023</b>	12-20mm 1/2-3/4"	200 Bar 2901 psi					•	•	•			•			
<i>M8x1.0 banjo 300mm flex hose coolant kit</i>	<b>6475025</b>	12-20mm 1/2-3/4"	200 Bar 2901 psi					•	•	•				•		
<i>G 1/8 banjo 200mm flex hose coolant kit</i>	<b>6475027</b>	25-40mm 1-1-1/2"	200 Bar 2901 psi					•	•	•				•		
<i>G 1/8 banjo 300mm flex hose coolant kit</i>	<b>6475029</b>	25-40mm 1-1-1/2"	200 Bar 2901 psi					•	•	•					•	
<i>Universal 200mm heavy-duty coolant kit</i>	<b>6145372</b>	25-40mm 1-1-1/2"	350 Bar* 5076 psi*	•	•			•	•	•	•					
<i>Universal 300mm heavy-duty coolant kit</i>	<b>6145373</b>	25-40mm 1-1-1/2"	350 Bar* 5076 psi*	•	•			•	•	•	•					

\* Max pressure for seat size 02 holders is 200 bar/2901 psi.

### Individual Kit Component List



order number	catalog number	description
6145374	1-16NPTF-JIC	Straight fitting, 1/16 NPTF male thread to JIC male thread
6145375	1-8NPTF-JIC	Straight fitting, 1/8 NPTF male thread to JIC male thread
6145378	M8X1.25-JIC	Straight fitting, M8 x 1.25 male thread to JIC male thread
6475041	M8X1-JIC	Straight fitting, M8 x 1.0 male thread to JIC male thread
6145376	G18-JIC	Straight fitting, G 1/8 male thread to JIC male thread
6145377	M10X1.5-JIC	Straight fitting, M10 x 1.5 male thread to JIC male thread
6145379	JICM-JICF-ELB	Elbow fitting, male JIC thread to female JIC thread
6145380	COOL-HOSE-200-HD	Heavy Duty 200mm Coolant hose with JIC female fitting both ends
6145381	COOL-HOSE-300-HD	Heavy Duty 300mm Coolant hose with JIC female fitting both ends
6432549	COOL-HOSE-200-FLEX	Flexible braided 200mm Coolant hose with JIC female fitting both ends
6432550	COOL-HOSE-300-FLEX	Flexible braided 300mm Coolant hose with JIC female fitting both ends
6475043	M8X1-BAN-JIC-HOSE-200	Flexible braided 200mm Coolant hose, M8 x 1.0 male thread to JIC female thread. Contains (1) M8x1.0 banjo bolt and (2) M8 bonded washers
6475045	G18-BAN-JIC-HOSE-200	Flexible braided 200mm Coolant hose, G 1/8 male thread to JIC female thread. Contains (1) G 1/8 banjo bolt and (2) G 1/8 bonded washers
6475047	M8X1-BAN-JIC-HOSE-300	Flexible braided 300mm Coolant hose, M8 x 1.0 male thread to JIC female thread. Contains (1) M8x1.0 banjo bolt and (2) M8 bonded washers
6475049	G18-BAN-JIC-HOSE-300	Flexible braided 300mm Coolant hose, G 1/8 male thread to JIC female thread. Contains (1) G 1/8 banjo bolt and (2) G 1/8 bonded washers

### Individual Kit Component List



The items shown below are not part of any coolant kits shown on previous pages.

order number	catalog number	description
6145382	M6X1-JIC	Straight fitting, M6 x 1.0 male thread to JIC male thread
6145383	JICM-JICM-STR	Straight fitting, JIC male thread to JIC male thread
6145386	G14-G18-RED	Straight fitting, G 1/4 male thread to G 1/8th male thread
6475058	R18-JIC	Straight fitting, 1/8 BSPT male thread to JIC male thread
6475059	R14-JIC	Straight fitting, 1/4 BSPT male thread to JIC male thread

### Coolant Spare Parts

Included in kits; part of components.

order number	catalog number	description
6475051	M8X1-BAN-BOLT	Banjo bolt, M8 x 1.0 male thread
6475053	G18-BAN-BOLT	Banjo bolt, G1/8 male thread
6475060	M6-BON-WASHER	M6 bonded washer
6475055	M8-BON-WASHER	M8 bonded washer
6475061	M10-BON-WASHER	M10 bonded washer
6475056	G18-BON-WASHER	G 1/8 bonded washer

## Internal Coolant Delivery Guidelines

1. WGC system capable of 5076 psi (350 bar).
2. Toolholder delivered with four entry holes.
3. A quality filtration system is necessary to prevent blockages in the toolholder that will affect coolant flow and performance.
4. Machines without a proper filtering system may require modification or an inline filter.
  - For pressure >1015 psi [70 bar], use 10–20 µm filter.
  - For pressure <1015 psi [70 bar], 50–100 µm.
  - Using fine filters in low-pressure applications may affect flow rate.

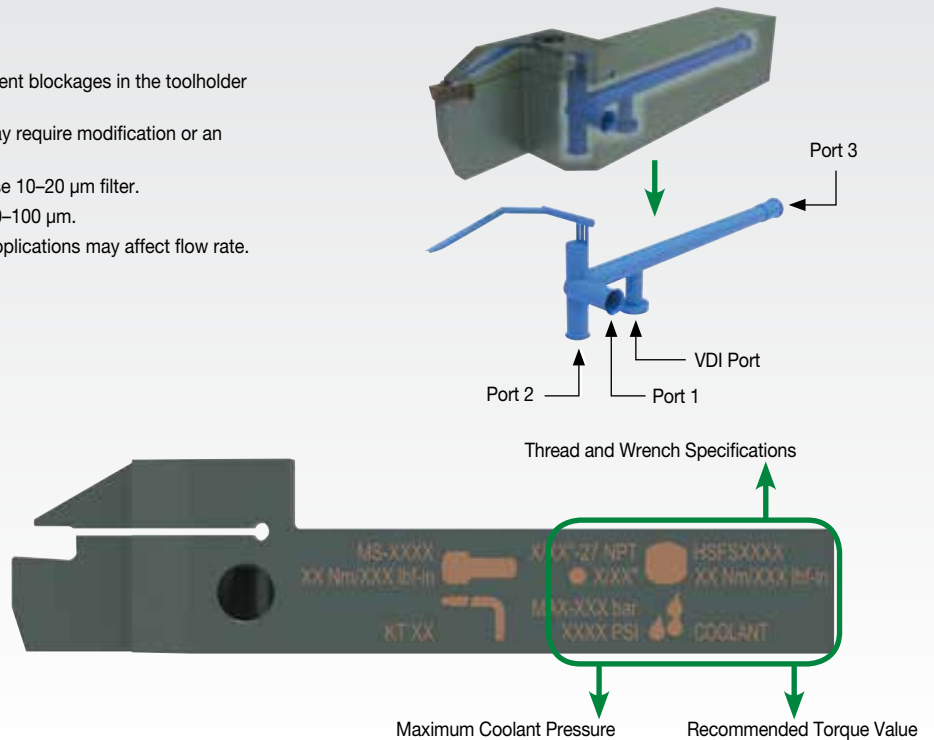

## General Safety Guidelines

1. All safety doors and mechanisms must be in place before trying out the internal coolant to avoid any danger to the operator in the event of a failure.
2. Use the correct pipe fittings to connect the holders to the system. Ensure the maximum pressure recommended for the fittings are not exceeded.
3. While implementing pressure >1160 psi [80 bar], increase the pressure in steps to ensure proper functioning of insert clamping and leak-free joints.
4. While indexing inserts, ensure the pocket is free from chips and/or dirt. Also, inspect the insert and make sure there are no blockages in the coolant canal.
5. Periodically check all hoses and fittings for damage and wear for proper functioning of the system. This check should also include filters.

## Internal Coolant Delivery Performance

Internal coolant offers a clear advantage in tool life and chip forming/evacuation vs. external coolant in difficult conditions and in high-pressure coolant.

*Example: Chipbreaking in plunging of steel.*

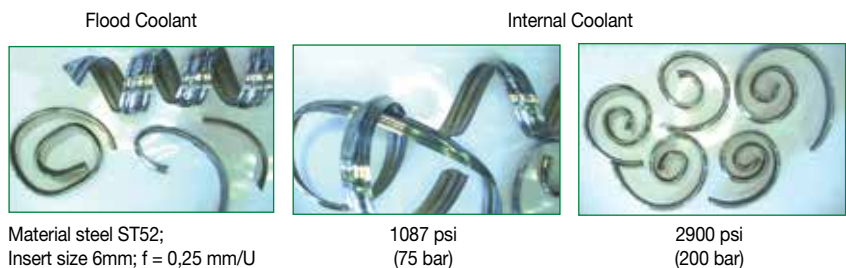

**Low Pressure** — If performance is at risk due to low coolant pressure, apply internal coolant in combination with external coolant to increase volume.

**Recommendation to improve tool life and/or productivity:** Apply high-pressure coolant: 80–350 bar recommended.

### VDI Assemblies

The WGC internal coolant delivery can be leveraged with VDI holding systems with both traditional or Quick-Change coolant connections.

The WMT platform is the economical and reliable option for grooving, cut-off, turning, and profiling applications.

The WMT system, with its extra-long clamping area and precise insert positioning, ensures exceptionally fast and accurate machining, and is an all-in-one tool for demanding operations.

- Specifically designed to increase speeds and feeds.
- Versatile geometry for even your most demanding deep-grooving applications.
- The WMT system enables heavy stock removal in turning applications.
- Ensures finer surface finishes and a long, reliable tool life.
- Extra-long clamping area for unsurpassed grooving and turning stability.
- Interchangeable grooving and cut-off inserts designed for excellent chip control.



## FIVE AVAILABLE CHIPBREAKER STYLES

### CM

Cut-Off Medium

### CM-W

Cut-Off Medium  
with Wiper

### PT

Groove, Plunge,  
and Turn

### PC







Plunge and Contour

### PH

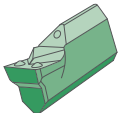
Groove, Plunge,  
and Turn

# RELIABLE ACCURACY WITH WMT™

## INSERTS

APPLICATION	TYPES	GROOVE WIDTH	INSERT GEOMETRY	GRADE	MATERIALS
<b>GROOVING</b>		2,0–8,0mm (0.081–0.317")	PT, PH	WU10PT, WU25PT	
<b>FACE GROOVING</b>		3,0–6,35mm (0.125–0.250")	PT, PH	WU10HT	
<b>CUT-OFF</b>		1,5–4,0mm (0.059–0.157")	CM CM-W	WP10CT, WP25CT	
<b>PROFILING</b>		3,0–8,0mm (0.118–0.317")	PC - Full Radius		

## APPLICATIONS



TURNING



GROOVING



I.D. GROOVING



FACE  
GROOVING



CUT-OFF



PROFILING

## INDUSTRY

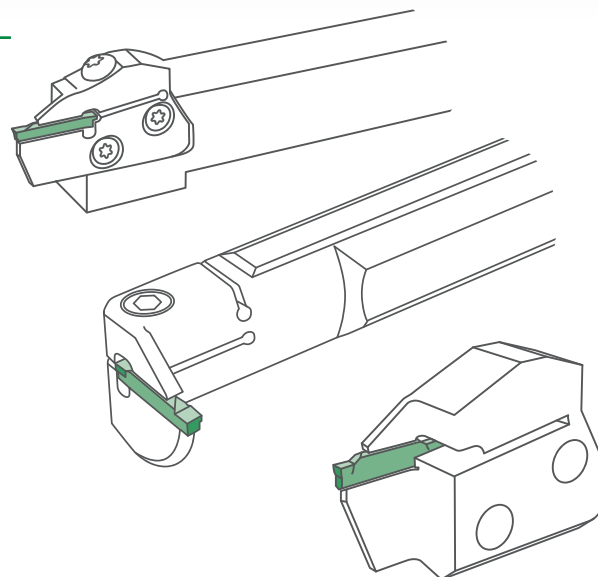



## Choosing the Correct WMT Tooling

### The Most Advanced Turning Solutions in the Industry

For unsurpassed quality, value, and performance, look no further than the WIDIA™ comprehensive line of specially engineered and dependable grooving and cut-off solutions. All the tools you need from the reliable name you can trust!

The WMT system, with its extra-long clamping area and precise insert positioning, ensures exceptionally fast and accurate machining, all-in-one tool, for your most demanding grooving, cut-off, turning, and profiling applications.

It is perfect for all general-purpose operations, including both shallow and deep grooving.

Utilize this handy, easy-to-use guide to identify and select the appropriate grooving and cut-off tools for your specific needs.

### 1 Choose the application to be performed:

Groove depth, width, and profile.

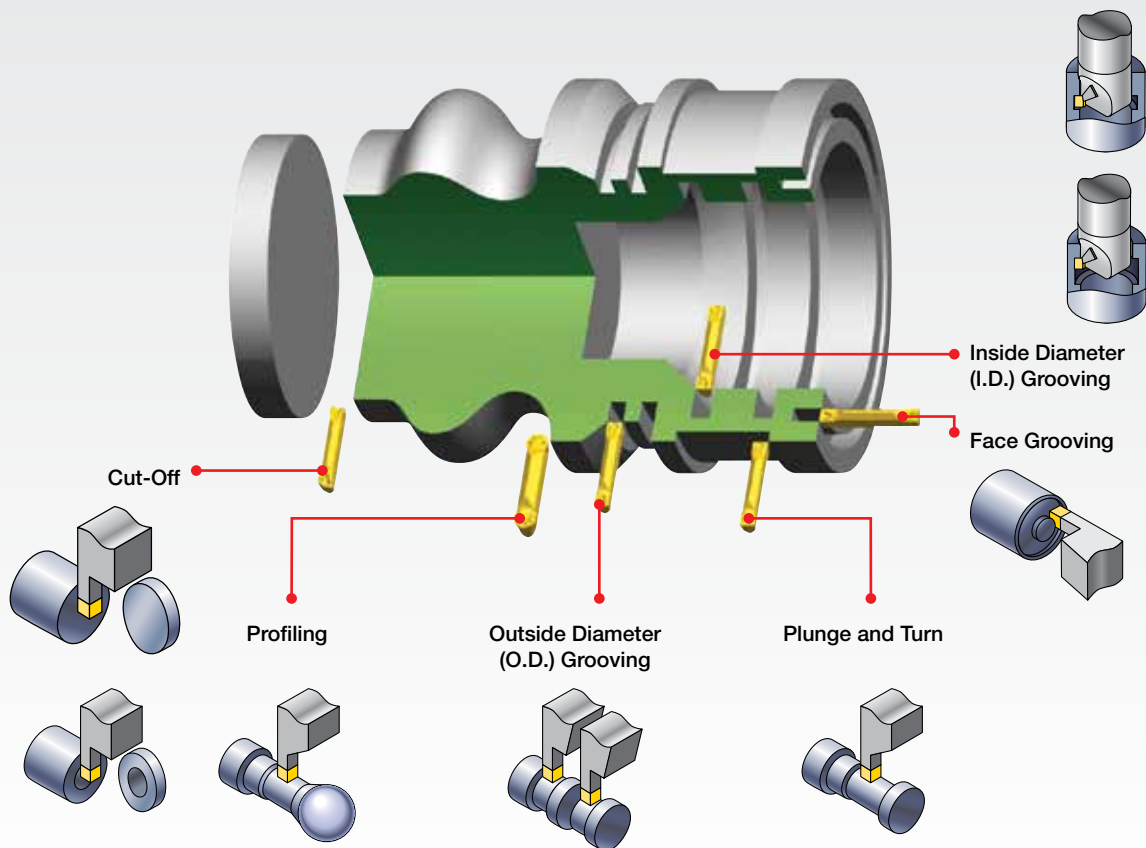

### 2 Identify the material to be machined:

Each tool has a material grid marked with a letter indicating the materials that can be machined.

P	Steel
M	Stainless Steel
K	Cast Iron
N	Non-Ferrous
S	High-Temp Alloys
H	Hardened Materials

Choosing the Correct WMT Tooling

3 Select your toolholder based on the application:

- A Choose the appropriate width “W” required for the application.
- B Choose the shortest cutting depth “CD” dimension for increased tool rigidity.
- C Select the largest toolholder shank “H” and “B” dimensions for maximum rigidity.

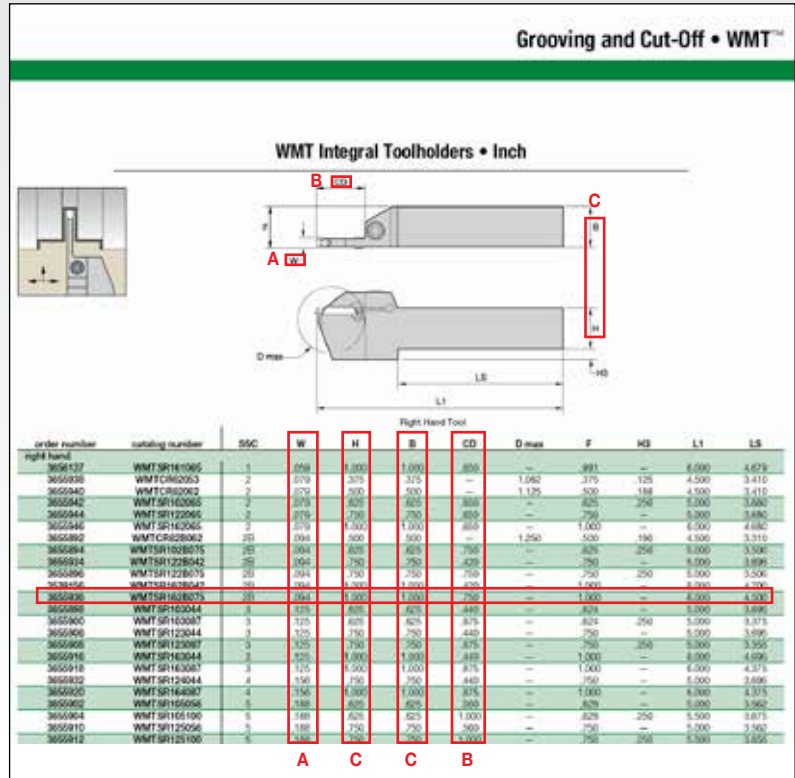

	application	conventional toolholders	modular blades
	O.D. Grooving and Cut-Off	pages E375–E376	page E382
	Face Grooving	page E377	page E381
	I.D. Grooving	page E379	—
	Plunge and Turn	pages E375–E376	page E382

## Choosing the Correct WMT Tooling

### 4 Select chipbreaker style for the application:

- CM** Cut-Off Medium
- CM-W** Cut-Off Medium with Wiper
- PT** Groove, Plunge, and Turn
- PC** Plunge and Contour
- PH** Groove, Plunge, and Turn

NOTE: Chart shows recommended starting feed rates.

### Grooving and Cut-Off • WMT™

#### Feed Values for Grooving Inserts

**CM Cut-Off Medium**

- Double-ended, V-bottom and top, mechanically clamped.
- Neutral, right, and left hand lead angles up to 12°.
- Designed to increase speed and feed.
- Chip geometry designed for excellent chip control and minimized cutting pressure on various materials.
- Ideal for 300 Series stainless steel, tool steel, titanium, INCONEL™, and other nickel-based alloys at moderate speeds and feeds.



**CM-W Cut-Off Medium with Wiper**

- Wiper fits where surface finish is critical.
- Double-ended, V-bottom, and top, mechanically clamped.
- Neutral, right, and left hand lead angles up to 12°.
- Designed to increase speed and feed.
- Chip geometry designed for excellent chip control and minimized cutting pressure on various materials.



**PT Plunge, Groove, and Turn Inserts**

- High positive rake geometry for low cutting force, especially in soft materials.
- Deep grooving tool for plunge and turn O.D. and face grooving operations.
- Delivers chip control over full range of DOC when turning.
- Cut in both axial and radial directions.



**PC Grooving and Profiling Inserts**

- Superior chip control.
- Full nose radius geometry for plunge and contour operations.
- Effective cutting edge geometry exceeds 100° for increased versatility.



**PH Plunge, Groove, and Turn Inserts**

- Excellent performance to greater than 30 HRC.
- Deep grooving tool for plunge and turn O.D. and face grooving operations.
- Delivers chip control over full range of DOC when turning.
- Delivers superior chip control in interrupted cuts.



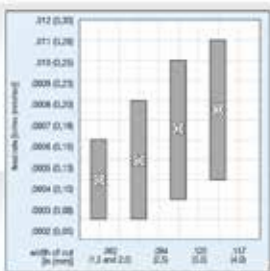

Recommended Starting Feed

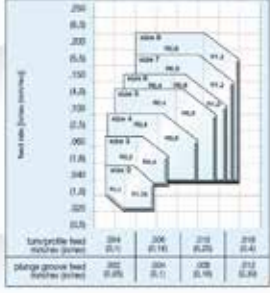

Lead Angle (Degrees)

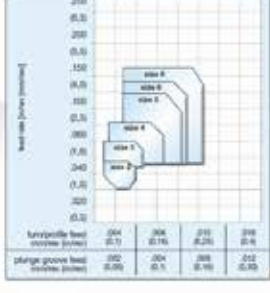

Lead Angle (Degrees)

- A Choose the appropriate insert width “W” for your specific application.
- B Select the required corner radius value “RR”.

### Grooving and Cut-Off • WMT™

#### WMT Cut-Off Inserts • F Precision Molded

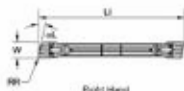

Right Hand



Neutral  
RR = RL on neutral inserts



Left Hand

● first choice  
○ alternate choice

P	●	●	●	●	●	●	●	●	●
M	●	●	●	●	●	●	●	●	●
K	●	●	●	●	●	●	●	●	●
N	●	●	●	●	●	●	●	●	●
S	●	●	●	●	●	●	●	●	●
H	●	●	●	●	●	●	●	●	●

catalog number	SSC	W		RR		RL	LI	-L	-R	WMT10PT	WMT25MF	WMT10CT	WMT50CT	WMT15MT	
		mm	in	mm	in										
WMT015R12CAM8	1	1.50	0.06	0.08	0.03	0.06	0.03	10.00	7.50	—	12°				

### Choosing the Correct WMT Tooling

#### 5 Select grade:

Grooving cutting condition		Recommended Grades					
		steel	stainless steel	cast iron	non-ferrous metals	high-temp alloys	hardened materials
heavily interrupted cut		WU25PT	WU25PT	WU25PT	WU25PT	WU25PT	-
lightly interrupted cut		WP25CT/ WU25PT	WU25PT	WP25CT/ WU25PT	WU25PT	WU25PT	-
varying depth of cut, casting, or forging skin		WU10PT	WU10PT	WP10CT/ WU10PT	WU10PT	WU10HT/ WU10PT	WU10PT
smooth cut, pre-turned surface		WP10CT/ WU10PT	WU10PT	WP10CT/ WU10PT	WU10PT	WU10HT/ WU10PT	WU10PT

Cut-Off cutting condition		Recommended Grades					
		steel	stainless steel	cast iron	non-ferrous metals	high-temp alloys	hardened materials
heavily interrupted cut		WU25PT	WU25PT	WU25PT	WU25PT	WU25PT	-
lightly interrupted cut		WU25PT	WU25PT	WU25PT	WU25PT	WU25PT	-
varying depth of cut, casting, or forging skin		WU25PT	WU25PT	WU25PT	WU25PT	WU25PT	WU25PT
smooth cut, pre-turned surface		WU25PT	WU25PT	WU25PT	WU25PT	WU25PT	WU25PT

NOTE: See page E357 for Grades and Grade Descriptions.

#### 6 Determine cutting data:

- A Based on material group and grade, identify starting speed (vc).
- B First choice starting speed is in bold.

NOTE: See pages E359–E360 for cutting data.

Grooving and Cut-Off • WMT™

Recommended Cutting Speeds • Inch

Material Group	Cutting Speed – vc SFM															
	WU10HT			WU10PT			WU25PT			WP10CT			WP25CT			
	min	Start	max	min	Start	max	min	Start	max	min	Start	max	min	Start	max	
P	0.1	290	<b>300</b>	320	620	650	680	520	<b>550</b>	580	470	700	740	590	625	660
	2	370	325	345	570	600	630	520	545	575	480	720	760	595	625	655
	3	370	325	345	570	600	630	520	545	575	480	720	760	595	625	655
	4	195	<b>205</b>	220	520	545	575	475	<b>485</b>	520	445	470	495	385	405	430
M	5	280	275	290	520	550	580	480	500	530	580	615	645	610	540	565
	6	120	125	130	480	500	530	430	450	470	260	275	290	240	250	260
	1	240	250	260	430	450	470	400	425	450	-	-	-	-	-	-
K	2	140	150	160	310	325	340	290	300	315	-	-	-	-	-	-
	3	155	165	170	310	325	340	285	300	315	-	-	-	-	-	-
	1	240	250	260	505	520	540	570	605	630	490	725	760	595	625	655
G	2	225	235	245	610	640	675	565	585	615	465	700	735	570	600	630
	3	240	250	260	520	550	580	480	500	530	710	750	790	620	650	680
	1	240	250	260	480	500	530	380	400	420	-	-	-	-	-	-
N	2	240	250	260	480	500	530	380	400	420	-	-	-	-	-	-
	3	240	250	260	480	500	530	380	400	420	-	-	-	-	-	-

## Catalog Numbering System

Each character in our catalog number signifies a specific trait of that product. Use the following key columns and corresponding images to easily identify which attributes apply.

### Cut-Off

<b>WMT</b>	<b>C</b>	<b>015</b>	<b>N</b>	<b>00</b>	<b>CM</b>	<b>08</b>
Tooling System	Cut-Off	W in mm* 10 inch* 1000	Hand of Insert	Main Cutting Edge Lead Angle	Chipbreaker Geometry  CM = Cut-Off Medium CM-W = Cut-Off Medium with Wiper	Corner Radius in mm* 10

### Groove, Plunge, Turn, and Contour Inserts

<b>WMT</b>	<b>S</b>	<b>205</b>	<b>M</b>	<b>2</b>	<b>U</b>	<b>02</b>	<b>PT</b>
Tooling System	Square	mm* 10 inch* 1000	Unit of Measurement for Width  M = mm I = inch	Seat Size	Insert Tolerance	Corner Radius in mm* 10	Chipbreaker Geometry  PT = Groove, Plunge, and Turn PH = Groove, Plunge, and Turn PC = Plunge and Contour

**P** = Precision ground grooving width tolerance:  
± .001" (0,025mm)

**U** = Utility molded grooving width tolerance:

3,05–4,05:	$\frac{+.006''}{-0}$	$\frac{(+0,15\text{mm})}{-0}$
5,05–10,05:	$\frac{+.010''}{-0}$	$\frac{(+0,25\text{mm})}{-0}$

## Grades and Grade Descriptions

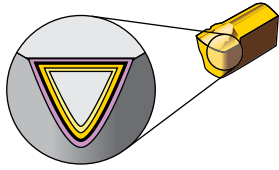

Coatings provide high-speed capability and are engineered for finishing to heavy roughing.

P	Steel
M	Stainless Steel
K	Cast Iron
N	Non-Ferrous
S	High-Temp Alloys
H	Hardened Materials

Grade	Coating	Grade Description	wear resistance ← → toughness																			
			05	10	15	20	25	30	35	40	45											
WU10PT		An advanced PVD-TiAlN coating over a very deformation-resistant unalloyed carbide substrate. The WU10PT™ grade's new and improved coating enables speeds to be increased by 50-100%. The WU10PT grade is ideal for finishing to general machining of most workpiece materials at higher speeds. Excellent for machining most steels, stainless steels, cast irons, non-ferrous materials, and super alloys under stable conditions. It also performs well machining hardened and short chipping materials.	P																			
	HC-P15		M																			
WU25PT		An advanced PVD-TiAlN-coated grade with a tough, ultra-fine-grain, unalloyed substrate. For general-purpose machining of most steels, stainless steels, high-temperature alloys, titanium, irons, and non-ferrous materials. Speeds may vary from low to medium and will handle interruptions and high feed rates.	P																			
	HC-P30		M																			
WU10HT		A hard, low binder content, unalloyed WC/Co fine-grained uncoated grade. Exceptional edge wear resistance combined with very high strength for machining titanium, cast irons, austenitic stainless steels, non-ferrous metals, non-metals, and most high-temperature alloys. Superior thermal deformation and depth-of-cut notch resistance. The grain structure is well controlled for minimal pits and flaws, which contributes to long, reliable service.	K																			
	HW-K15		M																			
WP10CT		A specially engineered, proprietary, cobalt-enriched carbide grade with thick K-MTCVD-TiCN coating layer, an Al <sub>2</sub> O <sub>3</sub> layer of controlled grain size, and outer layers of TiCN and TiN for maximum wear resistance. An excellent finishing to medium machining grade for a variety of workpiece materials including most steels, ferritic and martensitic stainless steels, and cast irons. The specially engineered cobalt-enriched substrate offers a balanced combination of deformation resistance and edge toughness, while the thick coating layers offer outstanding abrasion resistance and crater wear resistance for high-speed machining. The smooth coating provides good resistance to edge build-up and microchipping and produces excellent surface finishes.	P																			
	HC-P10		K																			
WP25CT		A tough cobalt-enriched carbide grade with a newly designed multilayer K-MTCVD TiCN-Al <sub>2</sub> O <sub>3</sub> -TiCN/TiN coating with superior interlayer adhesion. This is the industry's best general-purpose turning grade for most steels and ferritic and martensitic stainless steels. The substrate design, with cobalt-enrichment, ensures adequate deformation resistance along with excellent bulk toughness and insert edge strength. The coating layers offer good wear resistance over a wide range of machining conditions. The smoothness of the coating leads to reduced frictional heat, minimizes microchipping, and improves workpiece surface finishes.	P																			
	HC-P25		K																			

### Feed Values for Grooving Inserts

#### CM Cut-Off Medium

- Double-ended, V-bottom and top, mechanically clamped.
- Neutral, right-, and left-hand lead angles up to 12°.
- Designed to increase speed and feed.
- Chip geometry designed for excellent chip control and minimized cutting pressure on various materials.
- Ideal for 300 Series stainless steel, tool steel, titanium, INCONEL®, and other nickel-based alloys at moderate speeds and feeds.



#### CM-W Cut-Off Medium with Wiper

- Wiper flats where surface finish is critical.
- Double-ended, V-bottom, and top, mechanically clamped.
- Neutral, right-, and left-hand lead angles up to 12°.
- Designed to increase speed and feed.
- Chip geometry designed for excellent chip control and minimized cutting pressure on various materials.



#### PT Plunge, Groove, and Turn Inserts

- High positive rake geometry for low cutting force, especially in soft materials.
- Deep grooving tool for plunge and turn O.D. and face grooving operations.
- Deliver chip control over full range of DOC when turning.
- Cut in both axial and radial directions.



#### PC Grooving and Profiling Inserts

- Superior chip control.
- Full nose radius geometry for plunge and contour operations.
- Effective cutting edge geometry exceeds 180° for increased versatility.



#### PH Plunge, Groove, and Turn Inserts

- Excellent performance in greater than 35 HRC.
- Deep grooving tool for plunge and turn O.D. and face grooving operations.
- Deliver chip control over full range of DOC when turning.
- Deliver superior chip control in interrupted cuts.

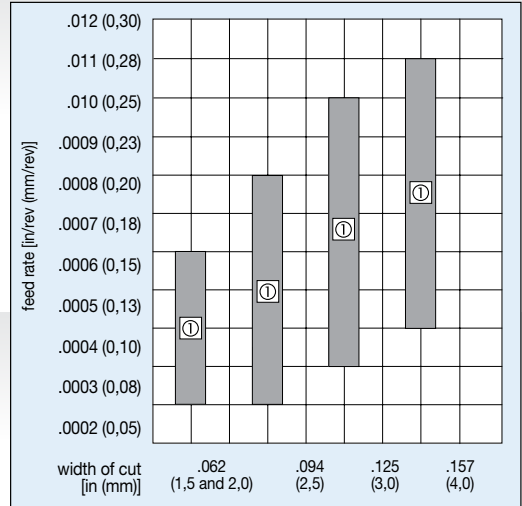

① Recommended Starting Feed

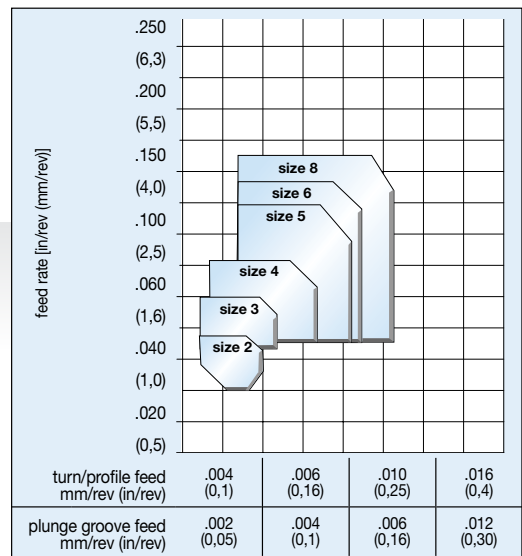
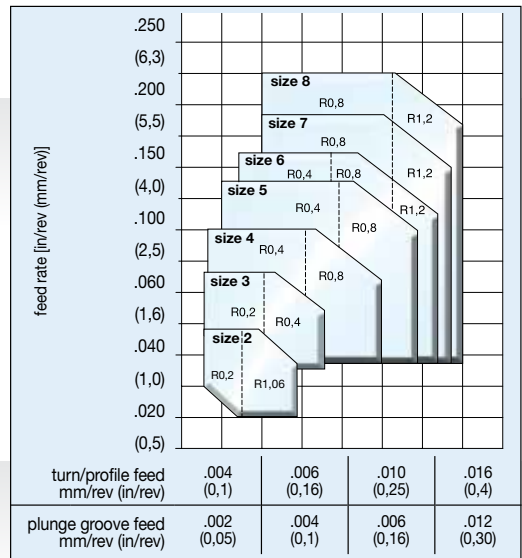



Recommended Cutting Speeds • Metric

Material Group		Cutting Speed – vc m/min														
		WU10HT			WU10PT			WU25PT			WP10CT			WP25CT		
		min	Start	max	min	Start	max	min	Start	max	min	Start	max	min	Start	max
P	0/1	100	<b>100</b>	110	190	<b>200</b>	210	170	<b>175</b>	180	210	<b>225</b>	240	170	<b>175</b>	180
	2	95	<b>95</b>	105	180	<b>185</b>	190	150	<b>160</b>	170	210	<b>220</b>	230	185	<b>195</b>	205
	3	95	<b>95</b>	105	180	<b>185</b>	190	150	<b>160</b>	170	210	<b>220</b>	230	185	<b>195</b>	205
	4	70	<b>70</b>	75	165	<b>170</b>	175	135	<b>145</b>	155	140	<b>145</b>	155	125	<b>125</b>	135
	5	85	<b>90</b>	95	170	<b>175</b>	180	140	<b>150</b>	160	180	<b>190</b>	195	155	<b>165</b>	170
	6	50	<b>50</b>	50	140	<b>150</b>	160	120	<b>125</b>	130	70	<b>75</b>	80	70	<b>75</b>	80
M	1	70	<b>75</b>	80	120	<b>125</b>	130	120	<b>125</b>	130	-	-	-	-	-	-
	2	50	<b>50</b>	50	100	<b>100</b>	110	70	<b>75</b>	80	-	-	-	-	-	-
	3	50	<b>50</b>	50	95	<b>100</b>	105	85	<b>90</b>	95	-	-	-	-	-	-
K	1	85	<b>90</b>	95	190	<b>200</b>	210	155	<b>165</b>	170	215	<b>225</b>	235	180	<b>190</b>	195
	2	75	<b>75</b>	80	185	<b>190</b>	200	155	<b>165</b>	175	205	<b>215</b>	225	175	<b>185</b>	195
	3	70	<b>75</b>	80	170	<b>175</b>	180	140	<b>150</b>	160	210	<b>225</b>	240	190	<b>200</b>	210
N	1	70	<b>75</b>	80	140	<b>150</b>	160	110	<b>120</b>	130	-	-	-	-	-	-
	2	70	<b>75</b>	80	140	<b>150</b>	80	110	<b>120</b>	80	-	-	-	-	-	-
	3	70	<b>75</b>	80	140	<b>150</b>	80	110	<b>120</b>	80	-	-	-	-	-	-
	4	70	<b>75</b>	80	140	<b>150</b>	80	110	<b>120</b>	80	-	-	-	-	-	-
	5	70	<b>75</b>	80	140	<b>150</b>	80	110	<b>120</b>	80	-	-	-	-	-	-
	6	70	<b>75</b>	80	140	<b>150</b>	80	110	<b>120</b>	80	-	-	-	-	-	-
	7	70	<b>75</b>	80	140	<b>150</b>	120	110	<b>120</b>	105	-	-	-	-	-	-
S	1	20	<b>25</b>	30	70	<b>75</b>	80	60	<b>65</b>	65	-	-	-	-	-	-
	2	20	<b>25</b>	30	65	<b>65</b>	70	50	<b>50</b>	50	-	-	-	-	-	-
	3	50	<b>50</b>	50	100	<b>100</b>	110	70	<b>75</b>	80	-	-	-	-	-	-
	4	-	-	-	70	<b>75</b>	80	50	<b>50</b>	50	-	-	-	-	-	-
H	1	-	-	-	15	<b>30</b>	60	15	<b>30</b>	60	-	-	-	-	-	-
	2	-	-	-	15	<b>30</b>	60	15	<b>30</b>	60	-	-	-	-	-	-
	3	-	-	-	15	<b>30</b>	60	15	<b>30</b>	60	-	-	-	-	-	-
	4	-	-	-	15	<b>30</b>	60	15	<b>30</b>	60	-	-	-	-	-	-

INDEXABLE MILLING

SOLID END MILLING

HOLE/MAKING

TAPPING

TURNING



Recommended Cutting Speeds • Inch

Material Group		Cutting Speed – vc SFM														
		WU10HT			WU10PT			WU25PT			WP10CT			WP25CT		
		min	Start	max	min	Start	max	min	Start	max	min	Start	max	min	Start	max
P	0/1	290	300	320	620	650	680	520	550	580	670	700	740	590	625	660
	2	310	325	345	570	600	630	520	545	575	680	720	760	595	625	655
	3	310	325	345	570	600	630	520	545	575	680	720	760	595	625	655
	4	195	205	220	520	545	575	475	495	520	445	470	495	385	405	430
	5	265	275	290	520	550	580	480	500	530	580	615	645	510	540	565
	6	120	125	130	480	500	530	430	450	470	260	275	290	240	250	260
M	1	240	250	260	430	450	470	400	425	450	-	-	-	-	-	-
	2	140	150	160	310	325	340	290	300	320	-	-	-	-	-	-
	3	155	165	170	310	325	340	285	300	315	-	-	-	-	-	-
K	1	240	250	265	595	625	660	550	575	605	690	725	760	595	625	655
	2	225	235	245	610	640	675	555	585	615	665	700	735	570	600	630
	3	240	250	260	520	550	580	480	500	530	710	750	790	620	650	680
N	1	240	250	260	480	500	530	380	400	420	-	-	-	-	-	-
	2	240	250	260	480	500	530	380	400	420	-	-	-	-	-	-
	3	240	250	260	480	500	530	380	400	420	-	-	-	-	-	-
	4	240	250	260	480	500	530	380	400	420	-	-	-	-	-	-
	5	240	250	260	480	500	530	380	400	420	-	-	-	-	-	-
	6	240	250	260	480	500	530	380	400	420	-	-	-	-	-	-
	7	240	250	260	480	500	530	380	400	420	-	-	-	-	-	-
S	1	110	115	120	235	250	265	215	225	235	-	-	-	-	-	-
	2	55	60	60	195	210	220	195	210	220	-	-	-	-	-	-
	3	190	200	210	310	325	340	290	300	320	-	-	-	-	-	-
	4	100	100	110	-	-	-	-	-	-	-	-	-	-	-	-
H	1	-	-	-	60	100	200	60	100	200	-	-	-	-	-	-
	2	-	-	-	60	100	200	60	100	200	-	-	-	-	-	-
	3	-	-	-	60	100	200	60	100	200	-	-	-	-	-	-
	4	-	-	-	60	100	200	60	100	200	-	-	-	-	-	-

WMT Cut-Off Inserts • F Precision Molded

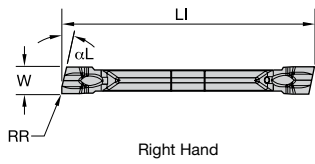

Right Hand

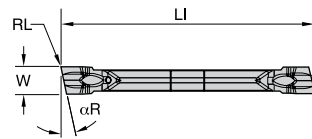

Neutral

RR = RL on neutral inserts

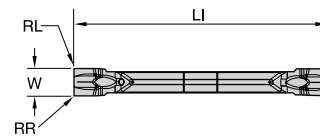

Left Hand

● first choice  
○ alternate choice

P	○	○	●	●	○
M	●	○	○	○	○
K	○	○	○	○	○
N	○	○	○	○	○
S	○	○	○	○	○
H	○	○	○	○	○

catalog number	SSC	W		RR		RL		LI		αL	αR	WU10PT	WU25PT	WP10CT	WP25CT	WU10HT
		mm	in	mm	in	mm	in	mm	in							
WMTC015R12CM08	1	1,50	.059	0,08	.003	0,08	.003	19,28	.759	—	12	●	●	●	●	○
WMTC015N00CM08	1	1,50	.059	0,08	.003	0,08	.003	19,30	.760	—	—	○	○	○	○	○
WMTC015R05CM08	1	1,50	.059	0,08	.003	0,08	.003	19,31	.760	—	5	●	●	●	●	○
WMTC015L05CM08	1	1,50	.059	0,08	.003	0,08	.003	19,31	.760	5	—	○	○	○	○	○
WMTC020L05CM08	2	1,99	.079	0,08	.003	0,08	.003	19,21	.756	5	—	○	○	○	○	○
WMTC020R05CM08	2	1,99	.079	0,08	.003	0,08	.003	19,21	.756	—	5	○	○	○	○	○
WMTC020N00CM08	2	2,00	.079	0,08	.003	0,08	.003	19,21	.756	—	—	○	○	○	○	○
WMTC020L12CM08	2	2,00	.079	0,08	.003	0,08	.003	19,25	.758	12	—	○	○	○	○	○
WMTC020R12CM08	2	2,00	.079	0,08	.003	0,08	.003	19,26	.758	—	12	○	○	○	○	○
WMTC094R12CM13	2B	2,39	.094	0,13	.005	0,13	.005	22,28	.877	—	12	○	○	○	○	○
WMTC094N00CM13	2B	2,39	.094	0,13	.005	0,13	.005	22,32	.879	—	—	○	○	○	○	○
WMTC094R05CM13	2B	2,39	.094	0,13	.005	0,13	.005	22,32	.879	—	5	○	○	○	○	○

## WMT Cut-Off Inserts • F Precision Molded

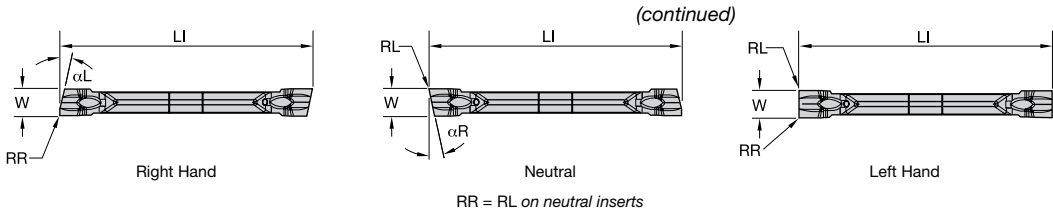

● first choice  
○ alternate choice

P	□	□	□	●	●	●	●
M	□	●	○	●	●	●	○
K	■	○	○	●	●	●	●
N	■	●	●	○	○	○	○
S	■	●	●	●	●	●	●
H	○	○	○	○	○	○	○

catalog number	SSC	W		RR		RL		LI		αL	αR	WU10PT	WU25PT	WP10CT	WP25CT	WU10HT
		mm	in	mm	in	mm	in	mm	in							
WMTC030R05CM17	3	3,00	.118	0,17	.007	0,17	.007	25,40	1.000	—	5	●	○	○	○	○
WMTC030R12CM17	3	3,00	.118	0,17	.007	0,17	.007	25,40	1.000	—	12	○	○	○	○	○
WMTC030L12CM17	3	3,00	.118	0,17	.007	0,17	.007	25,40	1.000	12	—	○	○	○	○	○
WMTC030N00CM17	3	3,00	.118	0,17	.007	0,17	.007	25,40	1.000	—	—	○	○	○	○	○
WMTC030L05CM17	3	3,00	.118	0,17	.007	0,17	.007	25,40	1.000	5	—	○	○	○	○	○
WMTC125R05CM17	3	3,17	.125	0,17	.007	0,17	.007	25,40	1.000	—	5	○	○	○	○	○
WMTC125N00CM17	3	3,17	.125	0,17	.007	0,17	.007	25,41	1.000	—	—	○	○	○	○	○
WMTC125R12CM17	3	3,18	.125	0,17	.007	0,17	.007	25,40	1.000	—	12	○	○	○	○	○
WMTC040L12CM17	4	4,00	.157	0,17	.007	0,17	.007	25,40	1.000	12	—	○	○	○	○	○
WMTC040N00CM17	4	4,00	.157	0,17	.007	0,17	.007	25,40	1.000	—	—	○	○	○	○	○
WMTC040R12CM17	4	4,00	.157	0,17	.007	0,17	.007	25,40	1.000	—	12	○	○	○	○	○
WMTC040R05CM17	4	4,00	.157	0,17	.007	0,17	.007	25,40	1.000	—	5	○	○	○	○	○
WMTC040L05CM17	4	4,00	.157	0,17	.007	0,17	.007	25,40	1.000	5	—	○	○	○	○	○

NOTE: SSC = Pocket Seat Reference. To correspond with the SSC on the insert.

WMT Cut-Off Inserts • F Precision Molded

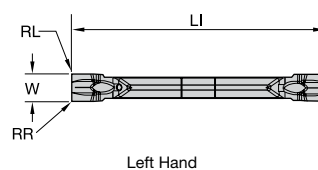
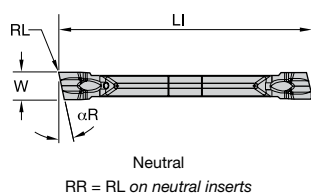
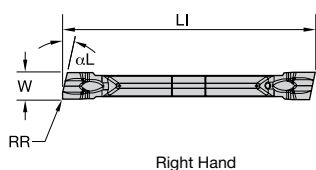

● first choice

○ alternate choice

P	●	○	○	○	○
M	○	○	○	○	○
K	○	○	○	○	○
N	○	○	○	○	○
S	○	○	○	○	○
H	○	○	○	○	○

catalog number	SSC	W		RR		RL		LI		$\alpha L$	$\alpha R$	WU10PT	WU25PT	WP10CT	WP25CT	WU10HT
		mm	in	mm	in	mm	in	mm	in							
WMTC015N00CMW08	1	1,50	.059	0,08	.003	0,08	.003	19,30	.760	—	—	●	○	○	○	○
WMTC020R05CMW08	2	2,00	.079	0,08	.003	0,08	.003	19,20	.756	—	5	○	○	○	○	○
WMTC020N00CMW08	2	2,00	.079	0,08	.003	0,08	.003	19,21	.756	—	—	○	○	○	○	○
WMTC020L12CMW08	2	2,00	.079	0,08	.003	0,08	.003	19,27	.759	12	—	○	○	○	○	○
WMTC020R12CMW08	2	2,00	.079	0,08	.003	0,08	.003	19,27	.758	—	12	○	○	○	○	○
WMTC094R12CMW13	2B	2,39	.094	0,13	.005	0,13	.005	22,29	.877	—	12	○	○	○	○	○
WMTC094N00CMW13	2B	2,39	.094	0,13	.005	0,13	.005	22,32	.879	—	—	○	○	○	○	○
WMTC094R05CMW13	2B	2,39	.094	0,13	.005	0,13	.005	22,32	.879	—	5	○	○	○	○	○
WMTC030R05CMW17	3	3,00	.118	0,17	.007	0,17	.007	25,40	1.000	—	5	○	○	○	○	○
WMTC030R12CMW17	3	3,00	.118	0,17	.007	0,17	.007	25,40	1.000	—	12	○	○	○	○	○
WMTC030L12CMW17	3	3,00	.118	0,17	.007	0,17	.007	25,40	1.000	12	—	○	○	○	○	○
WMTC030N00CMW17	3	3,00	.118	0,17	.007	0,17	.007	25,40	1.000	—	—	○	○	○	○	○

## WMT Cut-Off Inserts • F Precision Molded

(continued)

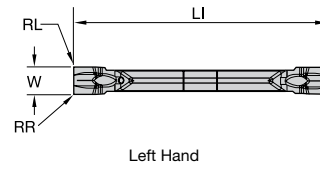
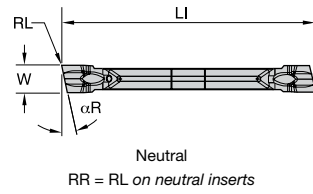
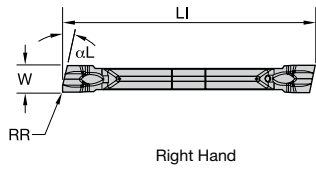

● first choice  
○ alternate choice

P	<input type="checkbox"/>	<input type="checkbox"/>	<input checked="" type="checkbox"/>	<input type="checkbox"/>	<input type="checkbox"/>
M	<input checked="" type="checkbox"/>	<input type="checkbox"/>	<input type="checkbox"/>	<input type="checkbox"/>	<input type="checkbox"/>
K	<input type="checkbox"/>	<input type="checkbox"/>	<input type="checkbox"/>	<input type="checkbox"/>	<input type="checkbox"/>
N	<input checked="" type="checkbox"/>	<input type="checkbox"/>	<input type="checkbox"/>	<input type="checkbox"/>	<input type="checkbox"/>
S	<input checked="" type="checkbox"/>	<input type="checkbox"/>	<input type="checkbox"/>	<input type="checkbox"/>	<input type="checkbox"/>
H	<input type="checkbox"/>	<input type="checkbox"/>	<input type="checkbox"/>	<input type="checkbox"/>	<input type="checkbox"/>

catalog number	SSC	W		RR		RL		LI		αL	αR	WU10PT	WU25PT	WP10CT	WP25CT	WU10HT
		mm	in	mm	in	mm	in	mm	in							
WMTC030L05CMW17	3	3,00	.118	0,17	.007	0,17	.007	25,40	1.000	5	—	●	●	●	●	●
WMTC125R05CMW17	3	3,17	.125	0,17	.007	0,17	.007	25,41	1.000	—	5	●	●	●	●	●
WMTC125R12CMW17	3	3,17	.125	0,17	.007	0,17	.007	25,41	1.000	—	12	●	●	●	●	●
WMTC125N00CMW17	3	3,18	.125	0,17	.007	0,17	.007	25,41	1.000	—	—	●	●	●	●	●
WMTC040N00CMW17	4	4,00	.157	0,17	.007	0,17	.007	25,40	1.000	—	—	●	●	●	●	●

NOTE: SSC = Pocket Seat Reference. To correspond with the SSC on the insert.

WMT Grooving Inserts • PT Precision Molded

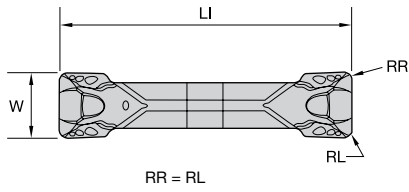

- first choice
- alternate choice

P	●	○	○	○	○	○	○	○	○
M	●	○	○	○	○	○	○	○	○
K	●	○	○	○	○	○	○	○	○
N	●	○	○	○	○	○	○	○	○
S	●	○	○	○	○	○	○	○	○
H	○	○	○	○	○	○	○	○	○

catalog number	SSC	W		RR		LI		WU10PT	WU25PT	WP10CT	WP25CT	WU10HT							
		mm	in	mm	in	mm	in												
WMTS205M2U02PT	2	2,13	.084	0,15	.006	19,23	.757	4113568	4116131	4113569	4116132	4169566	4169564	4169565	4169567	4169565	4169565	4169565	4169565
WMTS305M3U03PT	3	3,13	.123	0,31	.012	25,81	1.016	4113570	4113570	4113571	4113571	4169568	4169568	4169569	4169569	4169569	4169569	4169569	4169569
WMTS305M3U06PT	3	3,13	.123	0,61	.024	25,78	1.015	4113577	4113577	4113578	4113578	4169568	4169568	4169569	4169569	4169569	4169569	4169569	4169569
WMTS405M4U03PT	4	4,13	.163	0,31	.012	25,53	1.005	4113577	4113577	4113578	4113578	4169560	4169560	4169561	4169561	4169561	4169561	4169561	4169561
WMTS405M4U06PT	4	4,13	.163	0,61	.024	25,53	1.005	4113579	4113579	4113580	4113580	4169562	4169562	4169563	4169563	4169563	4169563	4169563	4169563
WMTS505M5U03PT	5	5,13	.202	0,30	.012	28,76	1.320	4116148	4116148	4116149	4116149	4169564	4169564	4169565	4169565	4169565	4169565	4169565	4169565
WMTS505M5U06PT	5	5,13	.202	0,61	.024	28,76	1.320	4116150	4116150	4116151	4116151	4169566	4169566	4169567	4169567	4169567	4169567	4169567	4169567
WMTS605M6U03PT	6	6,13	.241	0,30	.012	28,76	1.320	4117253	4117253	4117254	4117254	4169568	4169568	4169569	4169569	4169569	4169569	4169569	4169569
WMTS605M6U06PT	6	6,13	.241	0,59	.023	28,76	1.320	4117255	4117255	4117256	4117256	4169570	4169570	4169571	4169571	4169571	4169571	4169571	4169571
WMTS805M8U06PT	8	8,13	.320	0,61	.024	28,70	1.130	4117261	4117261	4117262	4117262	4169572	4169572	4169573	4169573	4169573	4169573	4169573	4169573
WMTS805M8U15PT	8	8,13	.320	1,50	.059	28,71	1.130	4117263	4117263	4117264	4117264	4169574	4169574	4169575	4169575	4169575	4169575	4169575	4169575

NOTE: SSC = Pocket Seat Reference. To correspond with the SSC on the insert.

INDEXABLE MILLING

SOLID END MILLING

HOLEMAKING

TAPPING

TURNING

INDEXABLE MILLING

SOLID END MILLING

HOLEMAKING

TAPPING

TURNING

### WMT Grooving Inserts • PT Precision Ground

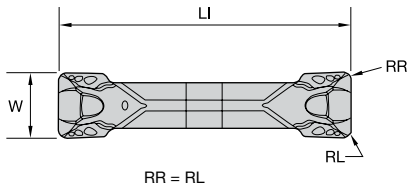

- first choice
- alternate choice

P	□	○	○	●	●	○
M	■	●	●	●	●	○
K	■	○	○	●	●	●
N	■	●	●	○	○	○
S	■	●	●	○	○	○
H	○	○	○	○	○	○

catalog number	SSC	W		RR		LI		WU10PT	WU25PT	WP10CT	WP25CT	WU10HT
		mm	in	mm	in	mm	in					
WMTS200M2P02PT	2	2,00	.079	0,15	.006	19,10	.752	4116129	4116130	●	●	○
WMTS094I2BP02PT	2B	2,38	.094	0,15	.006	22,15	.872	4118451	4118452	●	●	○
WMTS094I2BP04PT	2B	2,38	.094	0,38	.015	22,14	.872	4118583	4118584	●	●	○
WMTS300M3P03PT	3	3,00	.118	0,31	.012	25,65	1.010	4113563	4113564	●	●	○
WMTS300M3P06PT	3	3,00	.118	0,61	.024	25,65	1.010	4113565	4113567	●	●	○
WMTS125I3P03PT	3	3,17	.125	0,23	.009	25,40	1.000	4118585	4118586	●	●	○
WMTS125I3P08PT	3	3,17	.125	0,76	.030	25,40	1.000	4118587	4118588	●	●	○
WMTS400M4P03PT	4	4,00	.157	0,31	.012	25,40	1.000	4113572	4113574	●	●	○
WMTS400M4P06PT	4	4,00	.157	0,60	.024	25,40	1.000	4113575	4113576	●	●	○
WMTS188I5P03PT	5	4,76	.188	0,26	.010	28,63	1.127	4118589	4118590	●	●	○
WMTS188I5P08PT	5	4,77	.188	0,76	.030	28,63	1.127	4118591	4118592	●	●	○
WMTS500M5P03PT	5	5,00	.197	0,30	.012	28,63	1.127	4116143	4116144	●	●	○

WMT Grooving Inserts • PT Precision Ground

(continued)

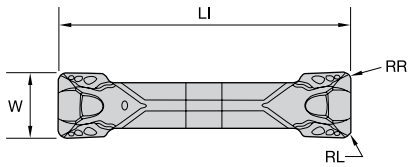

- first choice
- alternate choice

P	Blue	○	○	●	●	○
M	Yellow	●	○	○	○	○
K	Red	○	○	●	●	●
N	Green	○	○	○	○	○
S	Orange	●	●	○	○	○
H	Grey	○	○	○	○	○

catalog number	SSC	W		RR		LI		WU10PT	WU25PT	WP10CT	WP25CT	WU10HT
		mm	in	mm	in	mm	in					
WMTS500M5P06PT	5	5,00	.197	0,61	.024	28,63	1.127	4116146	4116147	○	○	○
WMTS600M6P03PT	6	6,00	.236	0,30	.012	28,63	1.127	4117239	4117240	○	○	○
WMTS600M6P06PT	6	6,00	.236	0,58	.022	28,63	1.127	4117241	4117242	○	○	○
WMTS250I6P08PT	6	6,34	.250	0,76	.030	28,63	1.127	4118595	4118596	○	○	○
WMTS250I6P03PT	6	6,35	.250	0,25	.010	28,63	1.127	4118593	4118594	○	○	○
WMTS800M8P06PT	8	8,00	.315	0,61	.024	28,57	1.125	4117258	4117259	○	○	○
WMTS800M8P15PT	8	8,00	.315	1,50	.059	28,57	1.125	4117260	4117261	○	○	○

NOTE: SSC = Pocket Seat Reference. To correspond with the SSC on the insert.

INDEXABLE MILLING

SOLID END MILLING

HOLEMAKING

TAPPING

TURNING



WMT Grooving Inserts • PC Full Radius Precision Molded

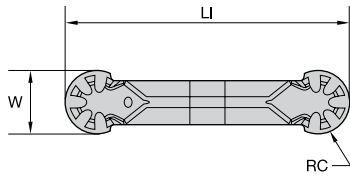

- first choice
- alternate choice

P	●	○	○	○	○	○	○	○	○
M	●	○	○	○	○	○	○	○	○
K	●	○	○	○	○	○	○	○	○
N	●	○	○	○	○	○	○	○	○
S	●	○	○	○	○	○	○	○	○
H	○	○	○	○	○	○	○	○	○

catalog number	SSC	W		RC		LI		WU10PT	WU25PT	WP10CT	WP25CT	WU10HT
		mm	in	mm	in	mm	in					
WMTR305M3UPC	3	3,13	.123	1,53	.060	25,53	1.005	4170172	4170173	4170174		
WMTR405M4UPC	4	4,13	.163	2,03	.080	25,58	1.007	4170177	4170178	4170179		
WMTR505M5UPC	5	5,13	.202	2,53	.099	29,01	1.142	4170182	4170183	4170184		
WMTR605M6UPC	6	6,12	.241	3,03	.119	28,77	1.133	4170187	4170188	4170189		
WMTR805M8UPC	8	8,13	.320	4,03	.159	29,22	1.150	4170192	4170193	4170194		

NOTE: SSC = Pocket Seat Reference. To correspond with the SSC on the insert.

INDEXABLE MILLING

SOLID END MILLING

HOLEMAKING

TAPPING

TURNING

WMT Grooving Inserts • PC Full Radius Precision Ground

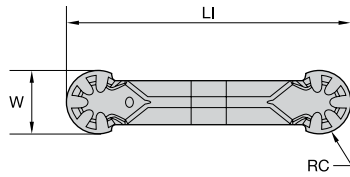

- first choice
- alternate choice

P	Blue	○	○	●	●	○
M	Yellow	○	○	●	●	○
K	Red	○	○	●	●	○
N	Green	○	○	●	●	○
S	Orange	○	○	●	●	○
H	Grey	○	○	●	●	○

catalog number	SSC	W		RC		LI		WU10PT	WU25PT	WP10CT	WP25CT	WU10HT
		mm	in	mm	in	mm	in					
WMTR300M3PPC	3	3,00	.118	1,50	.059	25,40	1.000	4170170	4170171			4170195
WMTR400M4PPC	4	4,00	.158	2,00	.079	25,45	1.002	4170175	4170176			4170196
WMTR188I5PPC	5	4,78	.188	2,39	.094	28,65	1.128	4170119	4170120			
WMTR500M5PPC	5	5,00	.197	2,50	.098	28,88	1.137	4170180	4170181			
WMTR600M6PPC	6	6,00	.236	3,00	.118	28,65	1.128	4170185	4170186			
WMTR250I6PPC	6	6,36	.250	3,18	.125	29,01	1.142	4170121	4170122			
WMTR312I8PPC	8	7,94	.312	3,96	.156	29,00	1.142	4170163	4170164			
WMTR800M8PPC	8	8,00	.315	4,00	.158	29,08	1.145	4170190	4170191			

NOTE: SSC = Pocket Seat Reference. To correspond with the SSC on the insert.

INDEXABLE MILLING

SOLID END MILLING

HOLEMAKING

TAPPING

TURNING

## WMT Grooving Inserts • PH Precision Molded

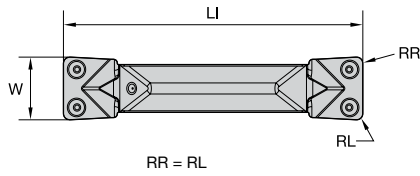

- first choice
- alternate choice

P	□	○	○	●	●	○
M	■	●	●	●	●	○
K	■	○	○	●	●	●
N	■	●	●	○	○	○
S	■	●	●	○	○	○
H	■	○	○	○	○	○

catalog number	SSC	W		RR		LI		WU10PT	WU25PT	WP10CT	WP25CT	WU10HT
		mm	in	mm	in	mm	in					
WMTS305M3U03PH	3	3,13	.123	0,30	.012	25,81	1.016	5346392	5346393	●	●	○
WMTS305M3U06PH	3	3,13	.123	0,60	.024	25,81	1.016	5346394	5346395	●	●	○
WMTS405M4U03PH	4	4,13	.163	0,30	.012	25,53	1.005	5346396	5346397	●	●	○
WMTS405M4U06PH	4	4,13	.163	0,60	.024	25,53	1.005	5346398	5346399	●	●	○
WMTS505M5U03PH	5	5,13	.202	0,30	.012	28,76	1.320	5346400	5346401	●	●	○
WMTS505M5U06PH	5	5,13	.202	0,60	.024	28,76	1.320	5346402	5346403	●	●	○
WMTS605M6U03PH	6	6,13	.241	0,30	.012	28,76	1.320	5346404	5346405	●	●	○
WMTS605M6U06PH	6	6,13	.241	0,60	.024	28,76	1.320	5346406	5346407	●	●	○
WMTS805M8U03PH	8	8,13	.320	0,30	.012	28,70	1.130	5346410	5346411	●	●	○
WMTS805M8U06PH	8	8,13	.320	0,60	.024	28,70	1.130	5346408	5346409	●	●	○

NOTE: SSC = Pocket Seat Reference. To correspond with the SSC on the insert.

WMT Grooving Inserts • PH Precision Ground

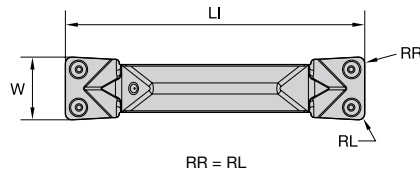

- first choice
- alternate choice

P	●	○	○	○	○	○	○
M	○	○	○	○	○	○	○
K	○	○	○	○	○	○	○
N	○	○	○	○	○	○	○
S	○	○	○	○	○	○	○
H	○	○	○	○	○	○	○

catalog number	SSC	W		RR		LI		WU10PT	WU25PT	WP10CT	WP25CT	WU10HT
		mm	in	mm	in	mm	in					
WMTS300M3P03PH	3	3,00	.118	0,30	.012	25,65	1.010	5346412	5346413	●	●	○
WMTS300M3P06PH	3	3,00	.118	0,60	.024	25,65	1.010	5346415	5346416	●	●	○
WMTS125I3P03PH	3	3,18	.125	0,25	.010	25,40	1.000	5345914	5291300	○	○	○
WMTS125I3P08PH	3	3,18	.125	0,75	.030	25,40	1.000	5345915	5331093	○	○	○
WMTS156I4P03PH	4	3,95	.156	0,30	.012	25,40	1.000	5345916	5345917	○	○	○
WMTS156I4P08PH	4	3,96	.156	0,75	.030	25,40	1.000	5345918	5345919	○	○	○
WMTS400M4P03PH	4	4,00	.157	0,30	.012	25,40	1.000	5346418	5346419	○	○	○
WMTS400M4P06PH	4	4,00	.157	0,60	.024	25,40	1.000	5346421	5346422	○	○	○
WMTS188I5P03PH	5	4,77	.188	0,25	.010	28,63	1.127	5345980	5331095	○	○	○
WMTS188I5P08PH	5	4,77	.188	0,75	.030	28,63	1.127	5345981	5331097	○	○	○
WMTS500M5P03PH	5	5,00	.197	0,30	.012	28,63	1.127	5346427	5346425	○	○	○
WMTS500M5P06PH	5	5,00	.197	0,60	.024	28,63	1.127	5346428	5346426	○	○	○

INDEXABLE MILLING

SOLID END MILLING

HOLEMAKING

TAPPING

TURNING

INDEXABLE MILLING

SOLID END MILLING

HOLEMAKING

TAPPING

TURNING

WMT Grooving Inserts • PH Precision Ground

(continued)

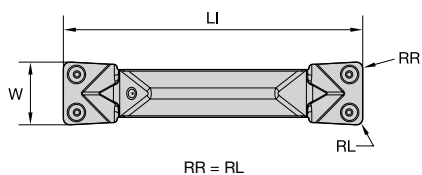

● first choice

○ alternate choice

P	●	○	○	○	○	○	○	○	○	○
M	●	○	○	○	○	○	○	○	○	○
K	●	○	○	○	○	○	○	○	○	○
N	●	○	○	○	○	○	○	○	○	○
S	●	○	○	○	○	○	○	○	○	○
H	○	○	○	○	○	○	○	○	○	○

catalog number	SSC	W		RR		LI		WU10PT	WU25PT	WP10CT	WP25CT	WU10HT
		mm	in	mm	in	mm	in					
WMTS600M6P03PH	6	6,00	.236	0,30	.012	28,63	1.127	5346430	5346431			
WMTS600M6P06PH	6	6,00	.236	0,60	.024	28,63	1.127	5346432	5346433			
WMTS250I6P08PH	6	6,32	.249	0,75	.030	28,63	1.127	5345984	5327621			
WMTS250I6P03PH	6	6,35	.250	0,25	.010	28,63	1.127	5345983	5327620			
WMTS312I8P03PH	8	7,92	.312	0,25	.010	28,57	1.125	5345985	5345986			
WMTS312I8P08PH	8	7,92	.312	0,75	.030	28,57	1.125	5345987	5345988			
WMTS800M8P03PH	8	8,00	.315	0,30	.012	28,57	1.125		5346437			
WMTS800M8P06PH	8	8,00	.315	0,60	.024	28,57	1.125	5346435				

NOTE: SSC = Pocket Seat Reference. To correspond with the SSC on the insert.

## Catalog Numbering System

Our WMT Toolholders now have a smart new naming system. Here are some examples of the improved nomenclature for our WMT Toolholders.

### Integral Toolholders

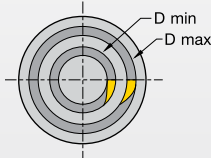
<b>WMT</b> Tooling System	<b>B</b> Tool Style	<b>R</b> Hand	<b>16</b> Shank Size	<b>3</b> Seat Size	<b>050</b> Max Grooving Depth	<b>—</b>	<b>150-200</b> Face Grooving Diameter
<b>WMT</b> = Groove and Turn (WMT Insert)	<p><b>S</b> = Straight</p> <p><b>C</b> = Straight with circular support</p> <p><b>E</b> = End mount</p> <p><b>A</b> = Straight, face grooving, curve in</p> <p><b>B</b> = Straight, face grooving, curve out</p>	<p><b>R</b> = Right hand</p> <p><b>L</b> = Left hand</p>	For square shanks, the number indicates the height and width in 1/16" increments. For rectangular shanks, the first digit indicates the number of eighths of width "B" and the second digit indicates the number of quarters of height "H".	<p>1</p> <p>2</p> <p><b>2B</b></p> <p>3</p> <p>4</p> <p>5</p> <p>6</p> <p>8</p>	<p>CD max in 1/100"</p> <p><b>NOTE:</b> Values &lt;1.00" use a preceding zero (e.g., 075 = .75" max groove depth)</p>	<p>D min – D max in 1/100" e.g., 275-400 = 2.75" D min 4.00" D max</p>	<p>Diameters are min and max for outer face groove diameter 999 = unlimited D max</p> 

### Modular Blades

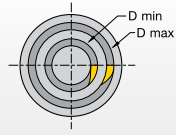
<b>WMT</b> Tooling System	<b>WGM</b> Connection Type	<b>R</b> Hand	<b>3</b> Seat Size	<b>16</b> Max Grooving Depth	<b>B</b> Tool Style	<b>070-100</b> Face Grooving Diameter
		<p><b>R</b> = Right hand</p> <p><b>L</b> = Left hand</p>			<p><b>A</b> = Curve In</p> <p><b>B</b> = Curve Out</p>	

INDEXABLE MILLING

SOLID END MILLING

HOLEMAKING

TAPPING

TURNING

## Catalog Numbering System

### Modular Toolholders

<b>WGM</b>	<b>S</b>	<b>R</b>	<b>16</b>
Tooling System	Tool Style	Hand	Shank Size
<p><b>MDG</b> = Modular Deep Grooving</p> <p><b>WGM</b> = Modular Serrated Locking System</p>	<p><b>S</b> = Straight</p> <p><b>E</b> = End mount</p>	<p><b>R</b> = Right hand</p> <p><b>L</b> = Left hand</p>	<p>For square shanks, the number indicates the height and width in 1/16" increments. For rectangular shanks, the first digit indicates the number of eighths of width "B" and the second digit indicates the number of quarters of height "H".</p>

### Integral Boring Bars

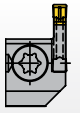
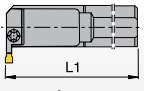
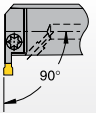
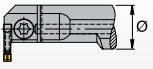
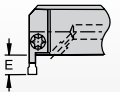
<b>A</b>	<b>16</b>	<b>R</b>	<b>WMT</b>	<b>E</b>	<b>R</b>	<b>03</b>	<b>16</b>	<b>N</b>																		
Steel Bar with Coolant	Bar Diameter	Bar Length	WMT Groove and Turn System	Tool Style	Hand	Seat Size	Max Grooving Depth	Tool Units																		
					<p><b>R</b> = Right hand</p> <p><b>L</b> = Left hand</p>			<p><b>N</b> = Inch</p> <p><b>M</b> = Metric</p>																		
		<table border="1"> <tr> <th>inch bars:</th> <th>metric bars:</th> </tr> <tr> <td>R = 8"</td> <td>R = 200mm</td> </tr> <tr> <td>S = 10"</td> <td>S = 150mm</td> </tr> <tr> <td>T = 12"</td> <td>T = 300mm</td> </tr> </table>	inch bars:	metric bars:	R = 8"	R = 200mm	S = 10"	S = 150mm	T = 12"	T = 300mm		<b>E</b> = End mounted (90°)														
inch bars:	metric bars:																									
R = 8"	R = 200mm																									
S = 10"	S = 150mm																									
T = 12"	T = 300mm																									
																										
	<table border="1"> <tr> <th>inch bars:</th> <th>metric bars:</th> </tr> <tr> <td>A two-digit number which indicates the bar diameter in 1/16" increments.</td> <td>Bar diameter in millimeters</td> </tr> </table>	inch bars:	metric bars:	A two-digit number which indicates the bar diameter in 1/16" increments.	Bar diameter in millimeters																					
inch bars:	metric bars:																									
A two-digit number which indicates the bar diameter in 1/16" increments.	Bar diameter in millimeters																									
						<table border="1"> <tr> <th>pocket seat size</th> <th>cutting width (mm)</th> </tr> <tr> <td>02</td> <td>2,00-2,62</td> </tr> <tr> <td>2B</td> <td>2,39-2,62</td> </tr> <tr> <td>03</td> <td>3,0-3,05</td> </tr> <tr> <td>04</td> <td>4,0-4,05</td> </tr> <tr> <td>05</td> <td>5,0-5,05</td> </tr> <tr> <td>06</td> <td>6,0-6,05</td> </tr> <tr> <td>08</td> <td>8,0-8,05</td> </tr> <tr> <td>10</td> <td>10,0-10,05</td> </tr> </table>	pocket seat size	cutting width (mm)	02	2,00-2,62	2B	2,39-2,62	03	3,0-3,05	04	4,0-4,05	05	5,0-5,05	06	6,0-6,05	08	8,0-8,05	10	10,0-10,05		
pocket seat size	cutting width (mm)																									
02	2,00-2,62																									
2B	2,39-2,62																									
03	3,0-3,05																									
04	4,0-4,05																									
05	5,0-5,05																									
06	6,0-6,05																									
08	8,0-8,05																									
10	10,0-10,05																									
																										
							<p><b>conversions:</b></p> <table border="1"> <tr> <th>mm</th> <th>inch</th> </tr> <tr> <td>7mm</td> <td>.28"</td> </tr> <tr> <td>10mm</td> <td>.39"</td> </tr> <tr> <td>12mm</td> <td>.47"</td> </tr> <tr> <td>16mm</td> <td>.63"</td> </tr> </table>	mm	inch	7mm	.28"	10mm	.39"	12mm	.47"	16mm	.63"									
mm	inch																									
7mm	.28"																									
10mm	.39"																									
12mm	.47"																									
16mm	.63"																									

WMT Integral Toolholders • Inch

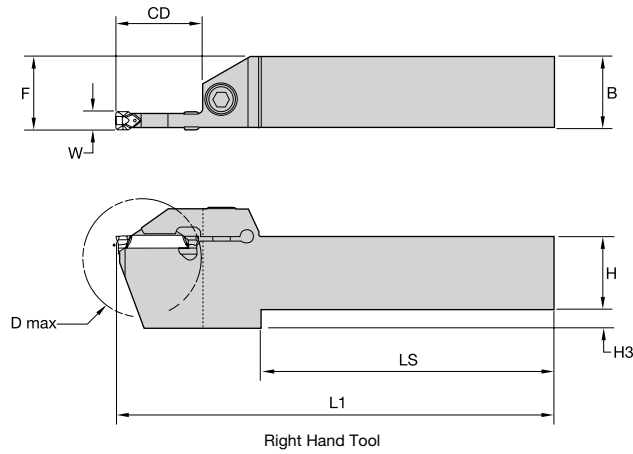
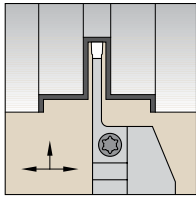

Right Hand Tool

order number	catalog number	SSC	W	H	B	CD	D max	F	H3	L1	LS
<b>right hand</b>											
3656137	WMTSR161065	1	.059	1.000	1.000	.650	—	.991	—	6.000	4.679
3655938	WMTCR62053	2	.079	.375	.375	—	1.062	.375	.125	4.500	3.410
3655940	WMTCR82062	2	.079	.500	.500	—	1.125	.500	.188	4.500	3.410
3655942	WMTSR102065	2	.079	.625	.625	.650	—	.625	.250	5.000	3.680
3655944	WMTSR122065	2	.079	.750	.750	.650	—	.750	—	5.000	3.680
3655946	WMTSR162065	2	.079	1.000	1.000	.650	—	1.000	—	6.000	4.680
3655892	WMTCR82B062	2B	.094	.500	.500	—	1.250	.500	.190	4.500	3.310
3655894	WMTSR102B075	2B	.094	.625	.625	.750	—	.625	.250	5.000	3.500
3655934	WMTSR122B042	2B	.094	.750	.750	.420	—	.750	—	5.000	3.695
3655896	WMTSR122B075	2B	.094	.750	.750	.750	—	.750	.250	5.000	3.500
3539156	WMTSR162B042	2B	.094	1.000	1.000	.420	—	1.000	—	6.000	4.700
3655936	WMTSR162B075	2B	.094	1.000	1.000	.750	—	1.000	—	6.000	4.500
3655898	WMTSR103044	3	.125	.625	.625	.440	—	.624	—	5.000	3.695
3655900	WMTSR103087	3	.125	.625	.625	.875	—	.624	.250	5.000	3.375
3655906	WMTSR123044	3	.125	.750	.750	.440	—	.750	—	5.000	3.695
3655908	WMTSR123087	3	.125	.750	.750	.875	—	.750	.250	5.000	3.355
3655916	WMTSR163044	3	.125	1.000	1.000	.440	—	1.000	—	6.000	4.695
3655918	WMTSR163087	3	.125	1.000	1.000	.875	—	1.000	—	6.000	4.375
3655932	WMTSR124044	4	.156	.750	.750	.440	—	.750	—	5.000	3.695
3655920	WMTSR164087	4	.156	1.000	1.000	.875	—	1.000	—	6.000	4.375
3655902	WMTSR105056	5	.188	.625	.625	.560	—	.629	—	5.000	3.562
3655904	WMTSR105100	5	.188	.625	.625	1.000	—	.629	.250	5.500	3.675
3655910	WMTSR125056	5	.188	.750	.750	.560	—	.750	—	5.000	3.562
3655912	WMTSR125100	5	.188	.750	.750	1.000	—	.750	.250	5.500	3.655
3655922	WMTSR165056	5	.188	1.000	1.000	.560	—	1.000	—	6.000	4.562
3655924	WMTSR165100	5	.188	1.000	1.000	1.000	—	1.000	—	6.000	4.175
3655914	WMTSR126056	6	.250	.750	.750	.560	—	.754	—	5.000	3.562
3655926	WMTSR166056	6	.250	1.000	1.000	.560	—	1.004	—	6.000	4.562
3655928	WMTSR166100	6	.250	1.000	1.000	1.000	—	1.002	—	6.000	4.174
3539139	WMTSR168056	8	.312	1.000	1.000	.560	—	1.000	—	6.000	4.553
3539141	WMTSR168100	8	.312	1.000	1.000	1.000	—	1.000	—	6.000	4.174
3539145	WMTSR208100	8	.312	1.250	1.250	1.000	—	1.250	—	6.000	4.174
<b>left hand</b>											
3656138	WMTSL161065	1	.059	1.000	1.000	.650	—	.991	—	6.000	4.679
3655939	WMTCL62053	2	.079	.375	.375	—	1.062	.375	.125	4.500	3.410
3655941	WMTCL82062	2	.079	.500	.500	—	1.125	.500	.188	4.500	3.410
3655945	WMTSL122065	2	.079	.750	.750	.650	—	.750	—	5.000	3.680
3655947	WMTSL162065	2	.079	1.000	1.000	.650	—	1.000	—	6.000	4.680
3655893	WMTCL82B062	2B	.094	.500	.500	—	1.250	.500	.190	4.500	3.310
3655895	WMTSL102B075	2B	.094	.625	.625	.750	—	.625	.250	5.000	3.500
3655935	WMTSL122B042	2B	.094	.750	.750	.420	—	.750	—	5.000	3.700
3655897	WMTSL122B075	2B	.094	.750	.750	.750	—	.750	.250	5.000	3.500
3655937	WMTSL162B075	2B	.094	1.000	1.000	.750	—	1.000	—	6.000	4.500
3655899	WMTSL103044	3	.125	.625	.625	.440	—	.624	—	5.000	3.695
3655901	WMTSL103087	3	.125	.625	.625	.875	—	.624	.250	5.000	3.375
3655907	WMTSL123044	3	.125	.750	.750	.440	—	.750	—	5.000	3.695
3655909	WMTSL123087	3	.125	.750	.750	.875	—	.750	.250	5.000	3.355
3655917	WMTSL163044	3	.125	1.000	1.000	.440	—	1.000	—	6.000	4.695
3655919	WMTSL163087	3	.125	1.000	1.000	.875	—	1.000	—	6.000	4.375
3655933	WMTSL124044	4	.156	.750	.750	.440	—	.750	—	5.000	3.697
3655921	WMTSL164087	4	.156	1.000	1.000	.875	—	1.000	—	6.000	4.375
3655923	WMTSL165056	5	.188	1.000	1.000	.560	—	1.000	—	6.000	4.562
3655925	WMTSL165100	5	.188	1.000	1.000	1.000	—	1.000	—	6.000	4.175
3655915	WMTSL126056	6	.250	.750	.750	.560	—	.754	—	5.000	3.562
3655927	WMTSL166056	6	.250	1.000	1.000	.560	—	1.004	—	6.000	4.562
3655929	WMTSL166100	6	.250	1.000	1.000	1.000	—	1.004	—	6.000	4.174
3539146	WMTSL208100	8	.312	1.250	1.207	1.000	—	1.250	—	6.000	4.174

NOTE: SSC = To correspond with the SSC on the insert.

INDEXABLE MILLING

SOLID END MILLING

HOLEMAKING

TAPPING

TURNING



## WMT Integral Toolholders • Swiss Style • Inch

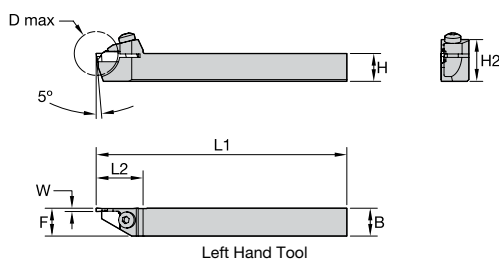
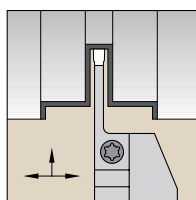

order number	catalog number	SSC	W	H	B	D max	F	H2	L1	L2
<b>right hand</b>										
3655949	WMTCR081039	1	.059	.500	.500	.787	.500	.750	4.500	.842
3656135	WMTCR121051	1	.059	.750	.750	1.024	.750	1.050	5.000	.952
3656133	WMTCR101051	1	.059	.625	.625	1.024	.626	.925	5.000	.952
3656141	WMTCR082039	2	.079	.500	.500	.787	.500	.750	4.500	.843
3656143	WMTCR102051	2	.079	.625	.625	1.024	.625	.925	5.000	.953
3656139	WMTCR062039	2	.079	.375	.375	.787	.375	.625	4.500	.843
3656145	WMTCR122051	2	.079	.750	.750	1.024	.750	1.050	5.000	.953
<b>left hand</b>										
3656186	WMTCL061039	1	.059	.375	.375	.787	.375	.625	4.500	.842
3656101	WMTCL081039	1	.059	.500	.500	.787	.500	.750	4.500	.842
3656136	WMTCL121051	1	.059	.750	.750	1.024	.750	1.050	5.000	.952
3656140	WMTCL062039	2	.079	.375	.375	.787	.375	.625	4.500	.843
3656142	WMTCL082039	2	.079	.500	.500	.787	.500	.750	4.500	.843
3656144	WMTCL102051	2	.079	.625	.625	1.024	.625	.925	5.000	.953
3656146	WMTCL122051	2	.079	.750	.750	1.024	.750	1.050	5.000	.953

NOTE: Insert exterior edge in line with toolholder edge for .375" and .500" shank toolholders.  
SSC = To correspond with the SSC on the insert.

INDEXABLE MILLING

SOLID END MILLING

HOLEMAKING

TAPPING

TURNING

WMT Integral Toolholders • Face Grooving • Inch

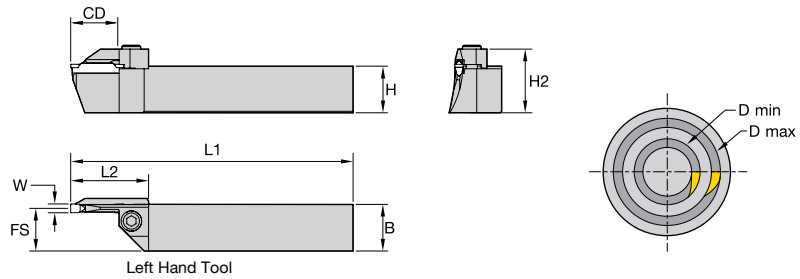
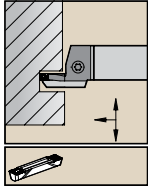

Left Hand Tool

order number	catalog number	SSC	W	H	B	CD	D max	D min	FS	H2	L1	L2
<b>right hand</b>												
3656151	WMTBR163063-275-400	3	.125	.990	.990	.625	4.000	2.750	.937	1.280	6.000	1.343
<b>left hand</b>												
3656152	WMTBL163063-275-400	3	.125	.990	.990	.625	4.000	2.750	.937	1.280	6.000	1.343
3656169	WMTBL166100-400-800	6	.250	.990	.990	1.000	8.000	4.000	.875	1.372	6.000	1.655

NOTE: Initial cut of tool must be between D min and D max. Due to the insert being positioned .030" above center, minimum diameter after initial cut is .850".  
 Toolholders that accept .125" width inserts have an integral clamp.  
 Toolholders that accept .187" and .250" width inserts are supplied with a detachable clamp.  
 SSC = To correspond with the SSC on the insert.

Blade Style	Part Shape		Left Hand	Right Hand
Curve Out				

INDEXABLE MILLING

SOLID END MILLING

HOLENMAKING

TAPPING

TURNING

WMT Modular Toolholders • Straight Mount • Grooving, Cut-Off, Face Grooving • Inch

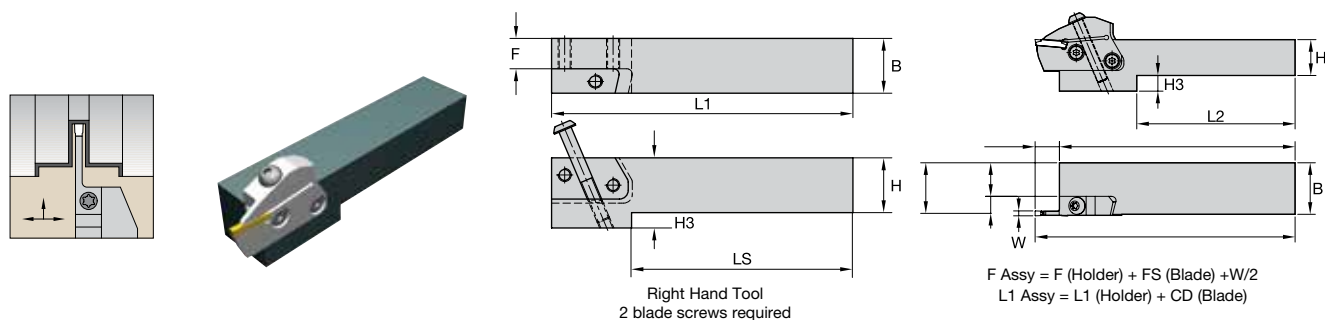

order number	catalog number	H	B	L1	LS	F	H3
<b>right hand</b>							
5349621	WGMSR12	.75	.75	4.30	2.75	.31	.49
5349622	WGMSR16	1.00	1.00	5.05	3.86	.56	.24
5349624	WGMSR20	1.25	1.25	5.05	—	.81	—
<b>left hand</b>							
5349609	WGMSL12	.75	.75	4.30	2.75	.31	.49
5349620	WGMSL16	1.00	1.00	5.05	3.86	.56	.24
5349623	WGMSL20	1.25	1.25	5.05	—	.81	—

NOTE: Use the larger seat size toolholder for optimal performance.  
Blade screws and clamp screw included with holder.

WMT Modular Toolholders • End Mount • Grooving, Cut-Off, Face Grooving • Inch

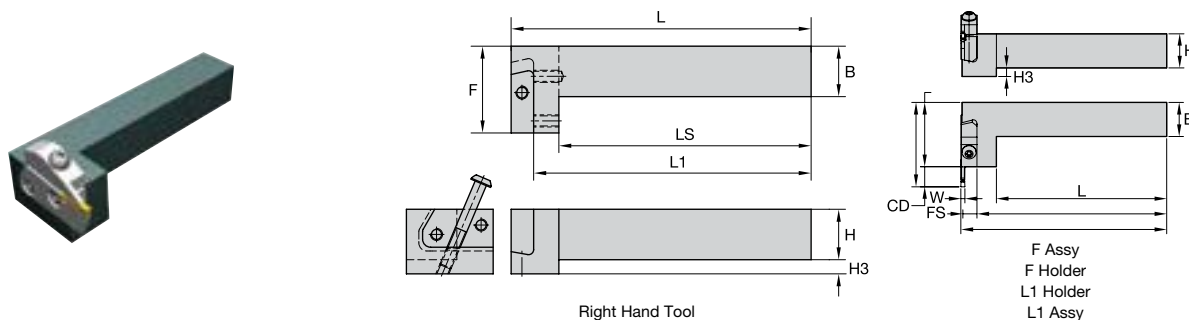

order number	catalog number	H	B	L	L1	LS	F	H3
<b>right hand</b>								
5514977	WGMR16	1.00	1.00	5.96	5.53	4.96	1.70	.24
5515022	WGMR2050	1.25	1.25	5.96	5.53	4.96	1.70	—
<b>left hand</b>								
5514976	WGML16	1.00	1.00	5.96	5.53	4.96	1.70	.24
5515023	WGML2050	1.25	1.25	5.96	5.53	4.96	1.70	—

WMT Integral I.D. Grooving Boring Bars • Inch

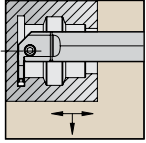

Steel shank with through coolant.

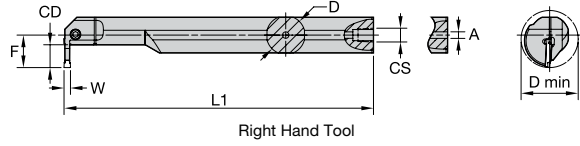

order number	catalog number	SSC	W	CD	D min	D	L1	F	A	CS
<b>right hand</b>										
5423448	A16RWMTER0316N	3	.125	.630	1.59	1.00	8.00	1.024	.25	1/4-18 NPT
5423449	A20SWMTER0319N	3	.125	.748	1.85	1.25	10.00	1.142	.25	1/4-18 NPT
5423840	A16RWMTER0416N	4	.156	.630	1.59	1.00	8.00	1.024	.25	1/4-18 NPT
5423841	A20SWMTER0419N	4	.156	.748	1.85	1.25	10.00	1.142	.25	1/4-18 NPT
5423842	A20SWMTER0519N	5	.188	.748	1.85	1.25	10.00	1.142	.25	1/4-18 NPT
5423843	A24TWMTER0522N	5	.188	.866	2.13	1.50	12.00	1.260	.25	1/4-18 NPT
5423844	A20SWMTER0619N	6	.250	.748	1.85	1.25	10.00	1.142	.25	1/4-18 NPT
5423845	A24TWMTER0622N	6	.250	.866	2.13	1.50	12.00	1.260	.25	1/4-18 NPT
<b>left hand</b>										
5423846	A16RWMTEL0316N	3	.125	.630	1.59	1.00	8.00	1.024	.25	1/4-18 NPT
5423847	A20SWMTEL0319N	3	.125	.748	1.85	1.25	10.00	1.142	.25	1/4-18 NPT
5423848	A16RWMTEL0416N	4	.156	.630	1.59	1.00	8.00	1.024	.25	1/4-18 NPT
5423870	A20SWMTEL0519N	5	.188	.748	1.85	1.25	10.00	1.142	.25	1/4-18 NPT
5423872	A20SWMTEL0619N	6	.250	.748	1.85	1.25	10.00	1.142	.25	1/4-18 NPT
5423873	A24TWMTEL0622N	6	.250	.866	2.13	1.50	12.00	1.260	.25	1/4-18 NPT

SSC = To correspond with the SSC on the insert.

INDEXABLE MILLING

SOLID END MILLING

HOLEMAKING

TAPPING

TURNING

WMT Integral Toolholders • Face Grooving • Inch

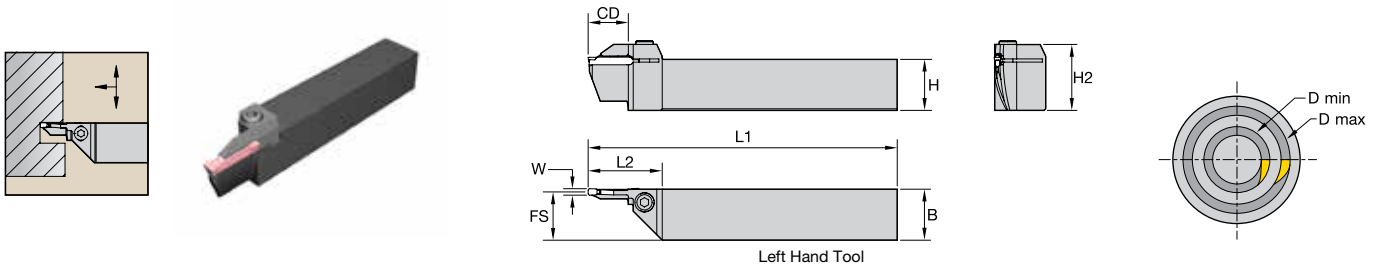

order number	catalog number	SSC	W	H	B	CD	D max	D min	FS	H2	L1	L2
right hand												
3539331	WMTAR166100-400-800	6	.250	.990	.990	1.000	8.000	4.000	.875	1.336	6.000	1.655

NOTE: Initial cut of tool must be between D min and D max. Due to the insert being positioned .030" above center, minimum diameter after initial cut is .850".  
 Toolholders that accept .125" width inserts have an integral clamp.  
 Toolholders that accept .187" and .250" width inserts are supplied with a detachable clamp.  
 SSC = To correspond with the SSC on the insert.

Blade Style	Part Shape		Left Hand	Right Hand
Curve In				

INDEXABLE MILLING

SOLID END MILLING

HOLEMAKING

TAPPING

TURNING

WMT Modular Blades • Face Grooving • Metric

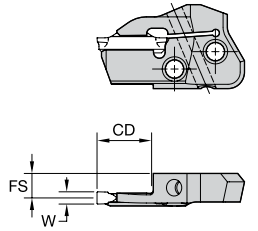
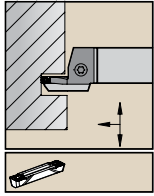

Right Hand Tool

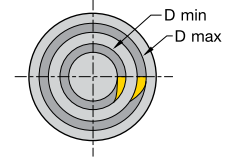

order number	catalog number	SSC	D min		D max		CD		W		FS	
			mm	in	mm	in	mm	in	mm	in	mm	in
<b>right hand</b>												
5359150	WMTWGMR313B038-052	3	38,00	1.496	52,00	2.047	12,70	.500	3,00	.118	11,00	.433
5359151	WMTWGMR316B052-070	3	52,00	2.047	70,00	2.756	15,88	.625	3,00	.118	11,00	.433
5359152	WMTWGMR316B070-100	3	70,00	2.756	100,00	3.937	15,88	.625	3,00	.118	11,00	.433
5359153	WMTWGMR319B100-205	3	100,00	3.937	205,00	8.071	19,05	.750	3,00	.118	11,00	.433
5359154	WMTWGMR416B052-070	4	52,00	2.047	70,00	2.756	15,88	.625	4,00	.157	10,50	.413
5359155	WMTWGMR416B070-100	4	70,00	2.756	100,00	3.937	15,88	.625	4,00	.157	10,50	.413
5359156	WMTWGMR419B100-205	4	100,00	3.937	205,00	8.071	19,05	.750	4,00	.157	10,50	.413
5359157	WMTWGMR522B100-205	5	100,00	3.937	205,00	8.071	22,00	.866	5,00	.197	10,00	.394
5359158	WMTWGMR622B100-205	6	100,00	3.937	205,00	8.071	22,00	.866	6,00	.236	10,00	.394
<b>left hand</b>												
5359134	WMTWGML313B038-052	3	38,00	1.496	52,00	2.047	12,70	.500	3,00	.118	11,00	.433
5359135	WMTWGML316B052-070	3	52,00	2.047	70,00	2.756	15,88	.625	3,00	.118	11,00	.433
5359136	WMTWGML316B070-100	3	70,00	2.756	100,00	3.937	15,88	.625	3,00	.118	11,00	.433
5359137	WMTWGML319100-205	3	100,00	3.937	205,00	8.071	19,05	.750	3,00	.118	11,00	.433
5359138	WMTWGML413B038-052	4	38,00	1.496	52,00	2.047	12,70	.500	4,00	.157	10,50	.413
5359139	WMTWGML416B052-070	4	52,00	2.047	70,00	2.756	15,88	.625	4,00	.157	10,50	.413
5359141	WMTWGML419B100-205	4	100,00	3.937	205,00	8.071	19,05	.750	4,00	.157	10,50	.413
5359142	WMTWGML516B038-052	5	38,00	1.496	52,00	2.047	15,88	.625	5,00	.197	10,00	.394
5359143	WMTWGML519B052-070	5	52,00	2.047	70,00	2.756	19,05	.750	5,00	.197	10,00	.394
5359144	WMTWGML519B070-100	5	70,00	2.756	100,00	3.937	19,05	.750	5,00	.197	10,00	.394
5359145	WMTWGML522B100-205	5	100,00	3.937	205,00	8.071	22,00	.866	5,00	.197	10,00	.394
5359147	WMTWGML619B052-070	6	52,00	2.047	70,00	2.756	19,05	.750	6,00	.236	10,00	.394
5359148	WMTWGML619B070-100	6	70,00	2.756	100,00	3.937	19,05	.750	6,00	.236	10,00	.394
5359149	WMTWGML622B100-205	6	100,00	3.937	205,00	8.071	22,00	.866	6,00	.236	10,00	.394

NOTE: Blade and clamp screw torque equals 71–88 in. lbs. (8–10 Nm).  
SSC = To correspond with the SSC on the insert.

INDEXABLE MILLING

SOLID END MILLING

HOLEMAKING

TAPPING

TURNING

WMT Modular Blades • Metric

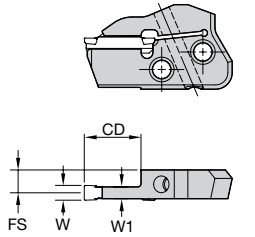
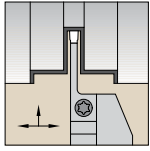

Right Hand Blade



order number	catalog number	SSC	CD		W		FS		W1	
			mm	in	mm	in	mm	in	mm	in
<b>right hand</b>										
5359127	WMTWGMR114S	1	14,00	.551	1,50	.059	11,04	.435	1,22	.048
5359128	WMTWGMR213S	2	13,00	.512	2,00	.079	10,81	.426	1,68	.066
5359129	WMTWGMR2B16S	2B	16,50	.650	2,39	.094	10,71	.422	1,88	.074
5359130	WMTWGMR319S	3	19,00	.748	3,00	.118	10,38	.409	2,54	.100
5359131	WMTWGMR419S	4	19,00	.748	4,00	.157	10,00	.394	3,30	.130
5359132	WMTWGMR522S	5	22,00	.866	5,00	.197	9,82	.387	3,66	.144
5359133	WMTWGMR622S	6	22,00	.866	6,00	.236	9,26	.365	4,78	.188
<b>left hand</b>										
5359121	WMTWGML213S	2	13,00	.512	2,00	.079	10,81	.426	1,68	.066
5359122	WMTWGML2B16S	2B	16,50	.650	2,39	.094	10,71	.422	1,88	.074
5359123	WMTWGML319S	3	19,00	.748	3,00	.118	10,38	.409	2,54	.100
5359124	WMTWGML419S	4	19,00	.748	4,00	.157	10,00	.394	3,30	.130
5359125	WMTWGML522S	5	22,00	.866	5,00	.197	9,82	.387	3,66	.144
5359126	WMTWGML622S	6	22,00	.866	6,00	.236	9,26	.365	4,78	.188

NOTE: Blade and clamp screw torque equals 8–10 Nm (71–88 in. lbs.).  
SSC = To correspond with the SSC on the insert.





The WIDIA™ TopGroove clamping system is perfect for shallow grooving operations and features an extensive carbide grade selection to meet the most demanding application requirements. With maximum clamping rigidity and superior versatility, TopGroove inserts employ a unique top rake chip control geometry that efficiently evacuates chips and produces better quality parts.

- TopGroove clamping design features a rugged bridge clamp, which locates in a groove molded into the insert, to provide superior resistance to side and radial cutting forces.
- TopGroove inserts are available for shallow grooving, deep grooving, light turning, profiling, shallow and deep face grooving, back turning, undercutting, and Poly-Vee grooving.
- The proprietary WIDIA chip control design works in multidirectional turning as well as radial feed applications to provide excellent chip evacuation in deep grooving applications.



### RIGID



















Inserts feature a top rake chip control geometry for maximum clamping rigidity.

### VERSATILE

The TopGroove clamping system provides a complete line of grooving geometries and an extensive grade selection to meet even the most demanding application requirements.

# SHALLOW GROOVING CLAMPING SYSTEM

## INSERTS

INSERT STYLE	APPLICATION	RAKE ANGLE	INSERT STYLE	APPLICATION	RAKE ANGLE
<b>NG</b> 	<ul style="list-style-type: none"> <li>General-purpose grooving.</li> <li>O-ring grooving.</li> <li>Circlip grooving.</li> </ul>	Neutral	<b>NFD-KI*</b> 	<ul style="list-style-type: none"> <li>Internal deep face grooving with chip control.</li> <li>For use in boring bars for internal face grooves.</li> </ul>	10° positive
<b>NG-K</b> 	<ul style="list-style-type: none"> <li>Chip control geometry.</li> <li>General-purpose grooving.</li> <li>O-ring grooving.</li> <li>Circlip grooving.</li> <li>Light turning.</li> </ul>	10° positive	<b>NP-K</b> 	<ul style="list-style-type: none"> <li>Turning.</li> <li>Back turning positive.</li> <li>Profiling with chip control.</li> </ul>	10° positive
<b>NGC-K*</b> 	<ul style="list-style-type: none"> <li>Combined groove and chamfered edge break in one positive plunge with chip control.</li> <li>Designed for DIN 471/472 standard circlip grooves.</li> </ul>	10° positive	<b>NR</b> 	<ul style="list-style-type: none"> <li>Full radius grooving.</li> <li>Turning and profiling.</li> </ul>	Neutral
<b>NGD*</b> 	<ul style="list-style-type: none"> <li>Deep grooving.</li> </ul>	Neutral	<b>NR-K</b> 	<ul style="list-style-type: none"> <li>Chip control geometry.</li> <li>Full radius grooving, turning, and profiling.</li> </ul>	10° positive
<b>NGD-K</b> 	<ul style="list-style-type: none"> <li>Chip control geometry.</li> <li>Deep grooving.</li> <li>Light turning.</li> </ul>	10° positive	<b>NRD</b> 	<ul style="list-style-type: none"> <li>Deep grooving.</li> <li>Full radius end-form.</li> </ul>	Neutral
<b>NGP</b> 	<ul style="list-style-type: none"> <li>General-purpose grooving.</li> <li>O-ring grooving.</li> <li>Circlip grooving.</li> </ul>	5° positive	<b>NRP*</b> 	<ul style="list-style-type: none"> <li>Full radius grooving.</li> <li>Light-turning profiling.</li> </ul>	5° positive
<b>NF*</b> 	<ul style="list-style-type: none"> <li>Face grooving.</li> <li>Additional side clearance.</li> </ul>	Neutral	<b>NU*</b> 	<ul style="list-style-type: none"> <li>Undercutting.</li> </ul>	Neutral
<b>NF-K</b> 	<ul style="list-style-type: none"> <li>Face grooving with chip control.</li> <li>Additional side clearance.</li> </ul>	10° positive	<b>NV*</b> 	<ul style="list-style-type: none"> <li>Poly-Vee grooving.</li> </ul>	Neutral
<b>NFD-K</b> 	<ul style="list-style-type: none"> <li>Deep face grooving with chip control.</li> <li>Additional side clearance.</li> </ul>	10° positive	<b>NB/NBD</b> 	<ul style="list-style-type: none"> <li>Blanks.</li> <li>Blanks for deep grooving.</li> <li>Available in uncoated grades only.</li> </ul>	—

\*Inserts are available as custom solutions.

### INDUSTRY



### APPLICATIONS



FACE  
GROOVING



GROOVING



I.D.  
GROOVING

## Choosing the Correct TopGroove Cutter

### The Most Advanced Turning Solutions in the Industry

Perfect for shallow grooving operations, the WIDIA™ TopGroove clamping system provides a complete line of grooving geometries and an extensive grade selection to meet even the most demanding application requirements. For increased rigidity, versatility, chip control, and carbide grade options, the TopGroove clamping system is the proven solution.

With maximum clamping rigidity and superior versatility, TopGroove inserts employ a unique top rake chip control geometry that efficiently evacuates chips and produces better quality parts, faster than ever before.

Use this comprehensive, easy-to-use guide for the information necessary to identify, choose, and select the appropriate cutting tools for your specific needs.

#### What you need to know:

- Material being machined.
- Groove depth, width, and profile.
- Application to be performed (face, O.D., or I.D. grooving).
- Toolholder requirements (e.g., KM™, ERICKSON™, square shank, right/left).

### 1 Choose the application to be performed:

Groove depth, width, and profile.

TopGroove is the best choice for groove depth-to-width ratios of 1.5 or less.

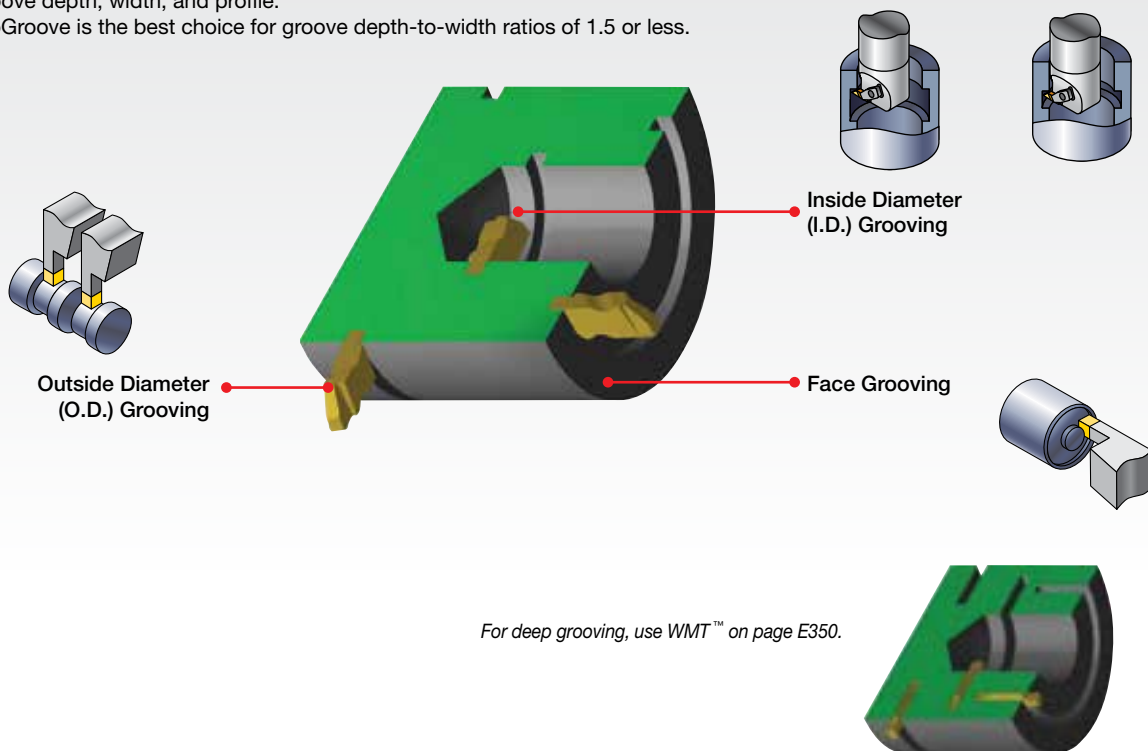

For deep grooving, use WMT™ on page E350.

### TopGroove for Internal, External, and Face Grooving Applications

system capabilities		minimum	maximum
	O.D./I.D. Grooving	width	.020" (0,50mm)
		depth	—
	Face Grooving	width	.125" (3,2mm)
		depth	—
	Internal Grooving	diameter	.440" (11,2mm)
	Face Grooving Diameter	standard	.940" (23,9mm)
		deep	—
	Deep O.D./I.D. Grooving	width	.059" (1,50mm)
		depth	—
	Deep Face Grooving	width	.125" (3,18mm)
		depth	—

## Choosing the Correct TopGroove Cutter

### 2 Identify the material to be machined:

Each tool has a material grid marked with a letter indicating the materials that can be machined.

<b>P</b>	Steel
<b>M</b>	Stainless Steel
<b>K</b>	Cast Iron
<b>N</b>	Non-Ferrous
<b>S</b>	High-Temp Alloys
<b>H</b>	Hardened Materials

### 3 Select your toolholder based on the application:

- A Choose the appropriate gage insert (width) required for the application.
- B Choose the shortest cutting depth "CD" dimension for increased tool rigidity.
- C Select the largest toolholder shank "H" and "B" dimensions for maximum rigidity.

**Grooving and Cut-Off • TopGroove™**

**Integral Toolholders • NS**

order number	catalog number	H	B	F	L1	L2	Ø4	CD	gage insert
right hand									
3632147	NSR042	375	375	592	2.50	75	35	138	N,DR
3634235	NSR042V	500	500	792	3.50	75	35	138	N,DR
3634236	NSR1228	750	750	1,000	3.50	75	35	138	N,DR
3634237	NSR125A	750	750	1,000	4.00	1.25	30	210	N,DR
3634232	NSR1228	750	750	1,000	4.75	1.25	30	210	N,DR
3634235	NSR163C	1,000	1,000	1,250	5.00	75	35	138	N,DR
3634232	NSR163C	1,000	1,000	1,250	6.00	1.25	30	210	N,DR
3634232	NSR163D	1,000	1,000	1,250	6.00	1.25	30	210	N,DR
3634232	NSR203D	1,250	1,250	1,500	6.00	1.25	30	210	N,DR
left hand									
3632145	NSL1228	750	750	1,000	4.50	75	35	138	N,SL
3632152	NSL125A	750	750	1,000	4.00	1.25	30	210	N,SL
3634232	NSL1228	750	750	1,000	4.00	1.25	30	210	N,SL
3632138	NSL163C	1,000	1,000	1,250	5.00	75	35	138	N,SL
3634232	NSL163C	1,000	1,000	1,250	6.00	1.25	30	210	N,SL
3634234	NSL163D	1,000	1,000	1,250	6.00	1.25	30	210	N,SL
3634237	NSL203D	1,250	1,250	1,500	6.00	1.25	30	210	N,SL

NOTE: F dimension measured over sharp point of insert.

application		conventional toolholders	modular blades
		E375-E376	E382
		E379	—

## Choosing the Correct TopGroove Cutter

### 4 Select chipbreaker style for the application:

See application guide on page E392 for a complete list of insert styles.

NOTE: Chart shows recommended starting feed rates.

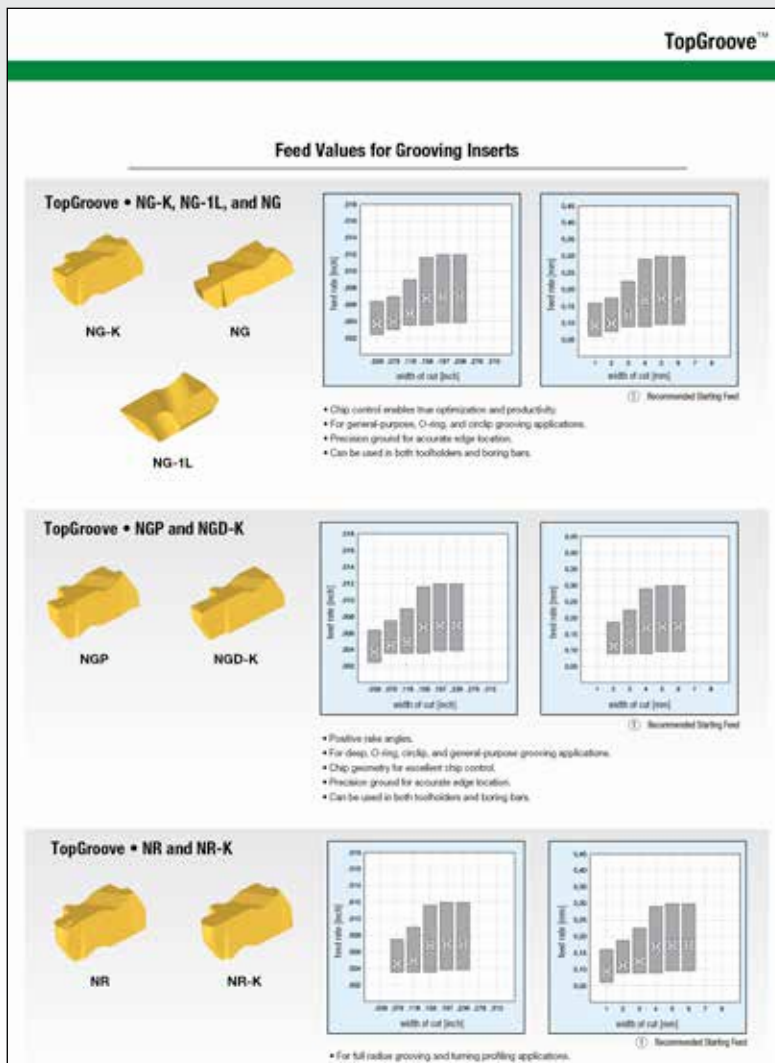

- A Choose the appropriate insert width “W” for your specific application.
- B Select the required corner radius value “RR”.

**Grooving and Cut-Off • TopGroove™**

**Grooving and Turning Inserts • NG • Grooving • Neutral**





• first choice  
 ○ alternate choice

catalog number	SSC	W		RR		T	R
		mm	in	mm	in		
NG201R	2	0.79	.031	0.09	.004	1.27	.050
NG204R	2	1.58	.041	0.09	.004	1.27	.050

FN8010  
 FN8025  
 FN8050  
 FN8075  
 FN8100  
 FN8125  
 FN8150  
 FN8175  
 FN8200  
 FN8225  
 FN8250  
 FN8275  
 FN8300  
 FN8325  
 FN8350  
 FN8375  
 FN8400  
 FN8425  
 FN8450  
 FN8475  
 FN8500  
 FN8525  
 FN8550  
 FN8575  
 FN8600  
 FN8625  
 FN8650  
 FN8675  
 FN8700  
 FN8725  
 FN8750  
 FN8775  
 FN8800  
 FN8825  
 FN8850  
 FN8875  
 FN8900  
 FN8925  
 FN8950  
 FN8975  
 FN9000  
 FN9025  
 FN9050  
 FN9075  
 FN9100  
 FN9125  
 FN9150  
 FN9175  
 FN9200  
 FN9225  
 FN9250  
 FN9275  
 FN9300  
 FN9325  
 FN9350  
 FN9375  
 FN9400  
 FN9425  
 FN9450  
 FN9475  
 FN9500  
 FN9525  
 FN9550  
 FN9575  
 FN9600  
 FN9625  
 FN9650  
 FN9675  
 FN9700  
 FN9725  
 FN9750  
 FN9775  
 FN9800  
 FN9825  
 FN9850  
 FN9875  
 FN9900  
 FN9925  
 FN9950  
 FN9975  
 FN10000

## Choosing the Correct TopGroove Cutter

### 5 Select grade:

cutting condition		Recommended Grades					
		steel	stainless steel	cast iron	non-ferrous metals	high-temp alloys	hardened materials
smooth cut, pre-turned surface		TN7110	TN6010	TN7110	TN6010/THM	TN6010	TN6010
varying depth of cut, casting, or forging skin		TN6010	TN6010	TN6010	TN6010/THM	TN6010	TN6010
lightly interrupted cut		TN6025	TN6025	TN6025	TN6010/THM	TN6010	TN6025
heavily interrupted cut		TN6025	TN6025	TN6025	TN6010/THM	TN6010	TN6025

See page E357 for Grades and Grade Descriptions.

### 6 Determine cutting data:

- A Based on material group and grade, identify starting speed (vc).
- B First choice starting speed is in bold.

See page E359–E360 for cutting data.

**Grooving and Cut-Off • WMT™**

**Recommended Cutting Speeds • Inch**

Material Group	Cutting Speed – vc – SFM															
	WU13HT			WU13PT			WU25PT			WP10CT			WP25CT			
	min	Start	max	min	Start	max	min	Start	max	min	Start	max	min	Start	max	
A	0/1	290	300	320	400	450	520	<b>590</b>	670	700	740	590	625	660		
	2	310	325	345	420	470	540	<b>610</b>	640	720	760	610	645	680		
	3	310	325	345	420	470	540	<b>610</b>	640	720	760	610	645	680		
	4	195	205	220	320	345	375	<b>400</b>	440	470	495	385	405	430		
	5	255	275	290	370	400	430	<b>460</b>	500	540	580	460	495	530		
M	1	240	250	260	430	450	470	490	510	530	550	430	450	470		
	2	140	150	160	310	325	340	350	360	370	380	310	325	340		
	3	155	165	170	310	325	340	350	360	370	380	310	325	340		
Y	1	240	250	260	430	450	470	490	510	530	550	430	450	470		
	2	225	235	245	410	440	470	500	530	560	590	410	440	470		
	3	140	150	160	310	325	340	350	360	370	380	310	325	340		
H	1	240	250	260	480	500	530	560	600	620	650	480	500	530		
	2	240	250	260	480	500	530	560	600	620	650	480	500	530		
	3	240	250	260	480	500	530	560	600	620	650	480	500	530		
	4	240	250	260	480	500	530	560	600	620	650	480	500	530		
	5	240	250	260	480	500	530	560	600	620	650	480	500	530		
S	1	240	250	260	480	500	530	560	600	620	650	480	500	530		
	2	110	115	120	220	230	240	250	260	270	280	220	230	240		
	3	55	60	65	135	140	145	150	155	160	165	135	140	145		
	4	130	140	150	310	325	340	350	360	370	380	310	325	340		
H	1	--	--	--	60	100	200	60	100	200	--	--	--	--	--	
	2	--	--	--	60	100	200	60	100	200	--	--	--	--	--	
	3	--	--	--	60	100	200	60	100	200	--	--	--	--	--	
	4	--	--	--	60	100	200	60	100	200	--	--	--	--	--	

## Catalog Numbering System

Each character in our catalog number signifies a specific trait of that product. Use the following key columns and corresponding images to easily identify which attributes apply.

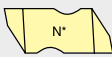
N	G	D	2	M	150	R		K																								
Type of Insert	Insert Style	Additional Information	Insert Size	Size Identification	Groove Size**	Hand of Insert	Cutting Depth	Chipbreaker Design	Definition of Inserts																							
<p><b>N</b> – TopGroove</p> 	<p><b>D</b> – Deep grooving</p> <p><b>P</b> – Positive</p> <p><b>C</b> – Groove and chamfer</p>	<p><b>B</b> – Blank (for special forms)</p> <p><b>F</b> – Face grooving</p> <p><b>G</b> – Grooving</p> <p><b>P</b> – Back turning</p> <p><b>R</b> – Full radius</p> <p><b>U</b> – Undercutting (or relieving)</p> <p><b>V</b> – Poly-Vee</p>	<p><b>M</b> – Metric insert groove width</p> <p><b>C</b> – Circlip groove insert width is nominal circlip size</p> <p><b>Blank</b> – Indicates inch width insert</p>	<table border="1"> <thead> <tr> <th rowspan="2">insert number</th> <th colspan="2">W1</th> </tr> <tr> <th>mm</th> <th>inch</th> </tr> </thead> <tbody> <tr> <td>1</td> <td>2,54</td> <td>.100</td> </tr> <tr> <td>2</td> <td>3,81</td> <td>.150</td> </tr> <tr> <td>3</td> <td>4,95</td> <td>.195</td> </tr> <tr> <td>4</td> <td>6,98</td> <td>.255</td> </tr> <tr> <td>5</td> <td>9,65</td> <td>.380</td> </tr> <tr> <td>6</td> <td>9,73</td> <td>.383</td> </tr> </tbody> </table>	insert number	W1		mm	inch	1	2,54	.100	2	3,81	.150	3	4,95	.195	4	6,98	.255	5	9,65	.380	6	9,73	.383	<p><b>150</b></p>	<p><b>L</b> – Left hand</p> <p><b>R</b> – Right hand</p>	<p>Shown for groove and chamfer inserts in .0004" increments.</p>	<p><b>K</b> – Standard chip control</p> <p><b>E</b> – Hone only</p>	<p><b>Groove size</b></p> <p><b>J or L</b> – Poly-Vee inserts</p> <p><b>I</b> – Internal face grooving</p>
insert number	W1																															
	mm	inch																														
1	2,54	.100																														
2	3,81	.150																														
3	4,95	.195																														
4	6,98	.255																														
5	9,65	.380																														
6	9,73	.383																														

Position pertains to groove width for F-, G-, and U-style inserts, radii for R-style grooving inserts, and circlip size for groove and chamfer inserts. Dimension in .001" or 0,01mm.

**Inch example:** 1/32" width groove or radius equals "031" catalog position number.

**Metric example:** 3,25mm width groove or radius equals "325" catalog position number.

**Width Tolerance:** ±.001" (±0,025mm) unless otherwise specified.

\*\*Omit position for TopGroove NB-style blanks.

### TopGroove/TopThread Threading and Grooving Insert Dimensions

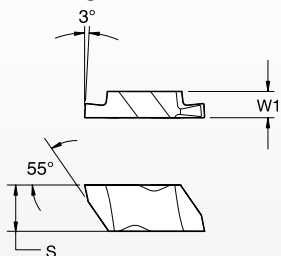

insert size	S		W1	
	mm	inch	mm	Inch
1	2,54	.100	2,54	.100
2	5,56	.219	3,81	.150
3	8,74	.344	4,95	.195
4	11,51	.453	6,48	.255
5	17,48	.688	9,65	.380
6	11,51	.453	9,73	.383
8	7,93	.312	11,13	.438

### TopGroove/TopThread Holder Design

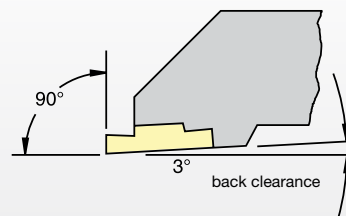

NOTE: Holders are designed to locate insert inclined to 3° to provide back clearance down open side.

WIDIA™ TopGroove and TopThread™ tooling technology combine to bring you the very best threading and grooving system available in the world today.



## Grades and Grade Descriptions

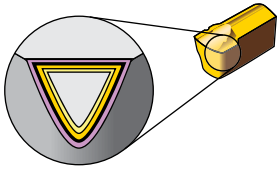

Coatings provide high-speed capability and are engineered for finishing to heavy roughing.

P	Steel
M	Stainless Steel
K	Cast Iron
N	Non-Ferrous
S	High-Temp Alloys
H	Hardened Materials

Grade	Coating	Grade Description	wear resistance ← → toughness																			
				05	10	15	20	25	30	35	40	45										
TN6010	HC-S10	An advanced PVD TiAlN coating over a very deformation-resistant unalloyed carbide substrate. TN6010 is ideal for finishing to general machining of most workpiece materials at higher speeds. Excellent for machining most steels, stainless steels, cast irons, non-ferrous materials, and super alloys under stable conditions. It also performs well machining hardened and short chipping materials.	P																			
			M																			
			K																			
			N																			
			S																			
			H																			
TN6025	HC-S25	An advanced PVD TiAlN-coated grade with a tough, ultra-fine-grain unalloyed substrate. For general-purpose machining of most steels, stainless steels, high-temp alloys, titanium, irons, and non-ferrous materials. Speeds may vary from low to medium and will handle interruptions and high feed rates.	P																			
			M																			
			K																			
			N																			
			S																			
			H																			
THM	HW-K15	Uncoated carbide. Extraordinarily good balance of hardness, wear resistance, edge stability, and toughness. Light and medium machining. For cast iron and all non-ferrous metals and non-metals. Useful in unfavorable conditions.	P																			
			M																			
			K																			
			N																			
			S																			
			H																			

INDEXABLE MILLING

SOLID END MILLING

HOLE/MAKING

TAPPING

TURNING



## Application Guide

insert style	application	rake angle	page(s)	insert style	application	rake angle	page(s)
<b>NG</b> 	<ul style="list-style-type: none"> <li>General-purpose grooving.</li> <li>O-ring grooving.</li> <li>Circlip grooving.</li> </ul>	neutral	<b>E397–E399</b>	<b>NFD-KI*</b> 	<ul style="list-style-type: none"> <li>Internal deep face grooving with chip control.</li> <li>For use in boring bars for internal face grooves.</li> </ul>	10° positive	—
<b>NG-K</b> 	<ul style="list-style-type: none"> <li>Chip control geometry.</li> <li>General-purpose grooving.</li> <li>O-ring grooving.</li> <li>Circlip grooving.</li> <li>Light turning.</li> </ul>	10° positive	<b>E400–E408</b>	<b>NP-K</b> 	<ul style="list-style-type: none"> <li>Turning.</li> <li>Back turning positive.</li> <li>Profiling with chip control.</li> </ul>	10° positive	<b>E415</b>
<b>NGC-K*</b> 	<ul style="list-style-type: none"> <li>Combined groove and chamfered edge break in one positive plunge with chip control.</li> <li>Designed for DIN 471/472 standard circlip grooves.</li> </ul>	10° positive	—	<b>NR</b> 	<ul style="list-style-type: none"> <li>Full radius grooving.</li> <li>Turning and profiling.</li> </ul>	neutral	<b>E416–E417</b>
<b>NGD*</b> 	<ul style="list-style-type: none"> <li>Deep grooving.</li> </ul>	neutral	—	<b>NR-K</b> 	<ul style="list-style-type: none"> <li>Chip control geometry.</li> <li>Full radius grooving, turning, and profiling.</li> </ul>	10° positive	<b>E420</b>
<b>NGD-K</b> 	<ul style="list-style-type: none"> <li>Chip control geometry.</li> <li>Deep grooving.</li> <li>Light turning.</li> </ul>	10° positive	<b>E409–E411</b>	<b>NRD</b> 	<ul style="list-style-type: none"> <li>Deep grooving.</li> <li>Full radius end-form.</li> </ul>	neutral	<b>E421</b>
<b>NGP</b> 	<ul style="list-style-type: none"> <li>General-purpose grooving.</li> <li>O-ring grooving.</li> <li>Circlip grooving.</li> </ul>	5° positive	<b>E412</b>	<b>NRP*</b> 	<ul style="list-style-type: none"> <li>Full radius grooving.</li> <li>Light-turning profiling.</li> </ul>	5° positive	—
<b>NF*</b> 	<ul style="list-style-type: none"> <li>Face grooving.</li> <li>Additional side clearance.</li> </ul>	neutral	—	<b>NU*</b> 	<ul style="list-style-type: none"> <li>Undercutting.</li> </ul>	neutral	—
<b>NF-K</b> 	<ul style="list-style-type: none"> <li>Face grooving with chip control.</li> <li>Additional side clearance.</li> </ul>	10° positive	<b>E413</b>	<b>NV*</b> 	<ul style="list-style-type: none"> <li>Poly-Vee grooving.</li> </ul>	neutral	—
<b>NFD-K</b> 	<ul style="list-style-type: none"> <li>Deep face grooving with chip control.</li> <li>Additional side clearance.</li> </ul>	10° positive	<b>E414</b>	<b>NB/NBD</b> 	<ul style="list-style-type: none"> <li>Blanks.</li> <li>Blanks for deep grooving.</li> <li>Available in uncoated grades only.</li> </ul>	—	<b>E396</b>

\*Inserts are available as custom solutions.

## Feed Values for Grooving Inserts

### TopGroove • NG-K, NG-1L, and NG

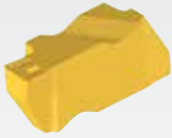

NG-K

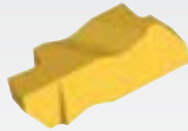

NG

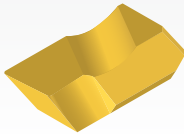

NG-1L

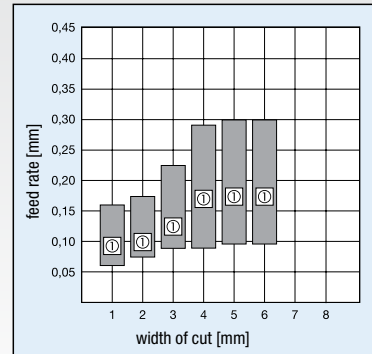
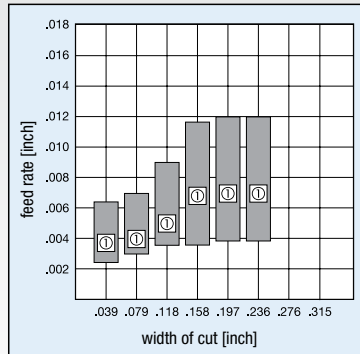

① Recommended Starting Feed

- Chip control enables true optimization and productivity.
- For general-purpose, O-ring, and circlip grooving applications.
- Precision ground for accurate edge location.
- Can be used in both toolholders and boring bars.

### TopGroove • NGP and NGD-K



NGP

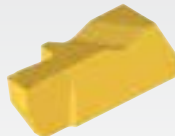

NGD-K

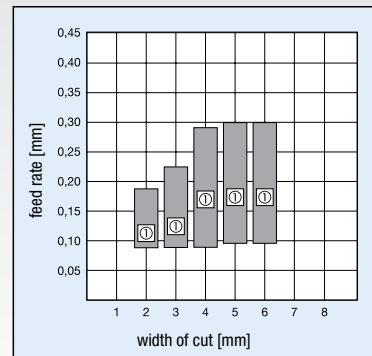
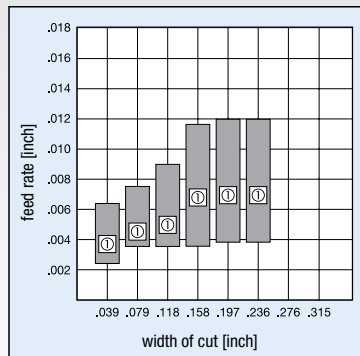

① Recommended Starting Feed

- Positive rake angles.
- For deep, O-ring, circlip, and general-purpose grooving applications.
- Chip geometry for excellent chip control.
- Precision ground for accurate edge location.
- Can be used in both toolholders and boring bars.

### TopGroove • NR and NR-K

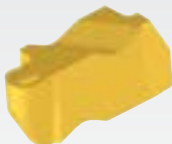

NR

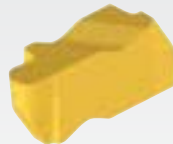

NR-K

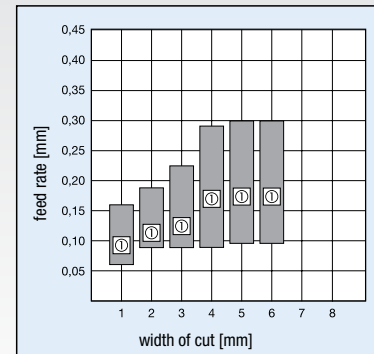
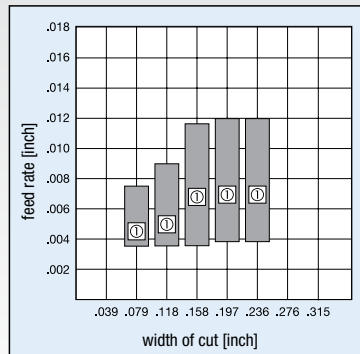

① Recommended Starting Feed

- For full radius grooving and turning profiling applications.
- Chip geometry for excellent chip control.
- Precision ground for accurate edge location.
- Can be used in both toolholders and boring bars.

Recommended Cutting Speeds • Metric

Material Group		Cutting Speed – vc m/min								
		TN6010			TN6025			THM		
		min	Start	max	min	Start	max	min	Start	max
P	0/1	140	175	210	130	140	150	90	95	100
	2	115	145	175	110	145	175	75	100	125
	3	115	145	175	110	145	175	75	100	125
	4	75	100	120	75	95	115	55	65	80
	5	105	140	170	100	125	145	70	85	100
	6	45	60	75	40	55	65	30	40	45
M	1	90	115	140	60	75	90	60	75	90
	2	55	70	90	40	50	55	50	60	75
	3	60	80	95	40	50	60	40	50	55
K	1	120	150	180	60	80	90	70	90	100
	2	120	150	180	60	75	85	50	65	80
	3	110	140	170	60	75	90	60	70	80
N	1	600	750	900	600	750	900	600	750	900
	2	535	685	835	535	685	835	500	650	800
	3	230	300	370	230	300	370	600	750	900
	4	135	180	225	135	180	225	500	650	800
	5	70	90	110	70	90	110	230	300	370
	6	445	565	690	445	565	690	150	200	250
	7	550	700	850	550	700	850	150	200	250
S	1	35	40	50	25	35	40	25	35	45
	2	20	20	30	15	20	20	20	30	35
	3	60	70	80	40	60	70	15	25	30
	4	30	35	45	20	30	35	10	15	20
H	1	15	30	60	15	30	60	10	20	35
	2	15	30	60	15	30	60	10	20	35
	3	15	30	60	15	30	60	10	20	35
	4	15	30	60	15	30	60	10	20	35

INDEXABLE MILLING

SOLID END MILLING

HOLEMAKING

TAPPING

TURNING

### Recommended Cutting Speeds • Inch

Material Group		Cutting Speed – vc SFM								
		TN6010			TN6025			THM		
		min	Start	max	min	Start	max	min	Start	max
P	0/1	455	570	685	425	455	490	295	310	325
	2	380	475	575	360	465	575	245	320	405
	3	380	475	575	360	465	575	245	320	405
	4	245	320	390	235	300	365	170	210	260
	5	345	450	555	325	400	475	230	280	330
	6	145	195	245	130	180	210	95	130	145
M	1	295	390	490	195	245	295	180	220	270
	2	180	245	310	130	160	180	115	145	165
	3	195	260	320	130	165	195	225	295	325
K	1	390	490	590	195	255	295	195	255	295
	2	390	490	590	195	240	280	195	240	280
	3	360	455	555	195	245	295	195	245	295
N	1	1965	2460	2950	1965	2460	2950	1805	2295	2785
	2	1750	2240	2730	1750	2240	2730	1805	2295	2785
	3	750	980	1210	750	980	1210	1805	2295	2785
	4	445	590	730	445	590	730	1195	1555	1915
	5	230	295	360	230	295	360	620	820	1015
	6	1450	1855	2260	1450	1855	2260	490	655	820
	7	1805	2295	2785	1805	2295	2785	425	555	690
S	1	110	130	165	75	110	130	75	110	130
	2	55	65	90	40	55	65	60	85	105
	3	195	235	260	135	195	235	45	60	75
	4	-	-	-	-	-	-	35	50	55
H	1	60	100	200	60	100	200	35	70	115
	2	60	100	200	60	100	200	35	70	115
	3	60	100	200	60	100	200	35	70	115
	4	60	100	200	60	100	200	35	70	115

INDEXABLE MILLING

SOLID END MILLING

HOLEMAKING

TAPPING

TURNING

INDEXABLE MILLING

SOLID END MILLING

HOLEMAKING

TAPPING

TURNING

## Grooving and Turning Inserts • NB • Blanks

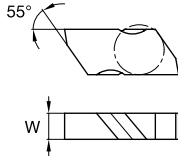
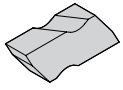

- first choice
- alternate choice

P		●	●	○
M		●	●	○
K		●	○	●
N		●	○	○
S		●	●	○
H		○	○	

right hand	catalog number	SSC	mm	in	TN6010	TN6025	THM
	NB2R	2	3,84	.151	●	○	3607064
left hand	NB2L	2	3,84	.151	○	○	3607016
	NB3L	3	4,95	.195	○	○	3607017

NOTE: Right-hand insert shown; left-hand insert is mirror image.  
SSC = To correspond with the SSC on the toolholder.

Grooving and Turning Inserts • NG • Grooving • Neutral

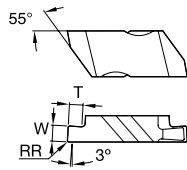
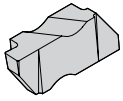

- first choice
- alternate choice

P	●	●	●	●	●
M	●	●	●	●	●
K	●	●	○	●	●
N	●	●	○	○	○
S	●	●	●	○	○
H	○	○	○	○	○

catalog number	SSC	W		RR		T		TN6010	TN6025	THM
		mm	in	mm	in	mm	in			
<b>right hand</b>										
NG2031R	2	0,79	.031	0,09	.004	1,27	.050	3607153	3607495	
NG2041R	2	1,04	.041	0,09	.004	1,27	.050		3607330	
NG2058R	2	1,47	.058	0,19	.008	1,27	.050		3607450	
NG2062R	2	1,58	.062	0,19	.008	2,79	.110	3607167	3607453	
NG3047R	3	1,19	.047	0,19	.008	1,91	.075	3607157	3607416	
NG3062R	3	1,58	.062	0,19	.008	2,39	.094	3607109	3607403	3607014
NG3094R	3	2,39	.094	0,19	.008	3,81	.150	3607137	3607406	3607018
NG3125R	3	3,18	.125	0,19	.008	3,81	.150	3607110	3607375	3607020
NG4250R	4	6,35	.250	0,57	.023	6,35	.250		3607382	
<b>left hand</b>										
NG2031L	2	0,79	.031	0,09	.004	1,27	.050		3607482	
NG2058L	2	1,47	.058	0,19	.008	1,27	.050		3607498	
NG2062L	2	1,58	.062	0,19	.008	2,79	.110		3607481	
NG3047L	3	1,19	.047	0,19	.008	1,91	.075	3607179	3607501	
NG3062L	3	1,57	.062	0,19	.008	2,38	.094	3607158	3607459	

INDEXABLE MILLING

SOLID END MILLING

HOLE/MAKING

TAPPING

TURNING

## Grooving and Turning Inserts • NG • Grooving • Neutral

(continued)

- first choice
- alternate choice

P	●	●	●	●
M	●	●	●	○
K	●	○	○	●
N	●	○	○	○
S	●	●	●	○
H	○	○	○	○

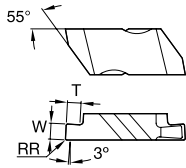
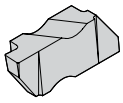

catalog number	SSC	W		RR		T		THM
		mm	in	mm	in	mm	in	
NG3094L	3	2,39	.094	0,19	.008	3,81	.150	THM
NG3125L	3	3,18	.125	0,19	.008	3,81	.150	THM
NG4250L	4	6,35	.250	0,57	.023	6,35	.250	THM

NOTE: SSC = To correspond with the SSC on the toolholder.

INDEXABLE MILLING

SOLID END MILLING

HOLEMAKING

TAPPING

TURNING

Grooving and Turning Inserts • NG-1L • Grooving

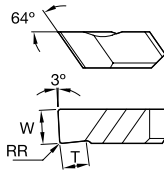
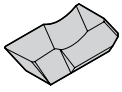

- first choice
- alternate choice

P	●	●	●	●
M	●	●	●	○
K	●	○	○	●
N	●	○	○	○
S	●	○	○	○
H	○	○	○	○

catalog number left hand	SSC	W		RR		T		cutting edges	TN6010	TN6025	THM
		mm	in	mm	in	mm	in				
NG1047L	1	1,19	.047	0,19	.008	1,91	.075	1		3636571	
NG1062L	1	1,58	.062	0,19	.008	1,91	.075	1		3636569	
NG1094L	1	2,39	.094	0,19	.008	1,91	.075	1		3636570	

NOTE: SSC = To correspond with the SSC on the toolholder.  
Width tolerance is +/- .003" (+/- 0,076mm) on NG-1L inserts.

INDEXABLE MILLING

SOLID END MILLING

HOLE/MAKING

TAPPING

TURNING



## Grooving and Turning Inserts • NG-K • Grooving with Chip Breaker

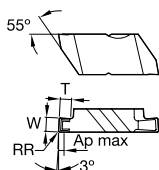
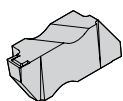

- first choice
- alternate choice

P	●	●	●	●	●
M	●	●	●	●	●
K	●	●	○	●	●
N	●	●	○	○	○
S	●	●	●	●	○
H	○	○	○	○	○

catalog number	SSC	W		Ap max		RR		T		TN6010	TN6025	THM
		mm	in	mm	in	mm	in	mm	in			
right hand												
NG2M050RK	2	0,50	.020	0,64	.025	0,09	.004	0,64	.025	3606991	3607394	■
NG2031RK	2	0,79	.031	0,76	.030	0,09	.004	1,27	.050	3607090	3607313	■
NG2M080RK	2	0,80	.032	0,76	.030	0,09	.004	1,27	.050	3606903	3607291	■
NG2M100RK	2	1,00	.039	0,76	.030	0,09	.004	1,28	.050	3607129	3607218	■
NG2M120RK	2	1,20	.047	0,76	.030	0,09	.004	1,27	.050	3606679	3607299	■
NG2047RK	2	1,19	.047	0,76	.030	0,09	.004	1,27	.050	3607123	3607404	■
NG2M140RK	2	1,40	.055	0,76	.030	0,09	.004	1,28	.050	3607151	3607318	■
NG2M150RK	2	1,50	.059	1,09	.043	0,19	.008	2,81	.110	■	3607234	■
NG2062RK	2	1,56	.062	1,09	.043	0,19	.008	2,79	.110	3607089	3607215	■
NG2M170RK	2	1,70	.067	1,09	.043	0,19	.008	2,81	.110	■	3607242	■
NG2M175RK	2	1,75	.069	1,09	.043	0,19	.008	2,81	.110	■	3607379	■

INDEXABLE MILLING

SOLID END MILLING

HOLEMAKING

TAPPING

TURNING

Grooving and Turning Inserts • NG-K • Grooving with Chip Breaker

(continued)

- first choice
- alternate choice

P	●	●	●	●
M	●	●	●	●
K	●	○	○	●
N	●	○	○	○
S	●	○	○	○
H	○	○	○	○

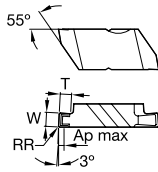
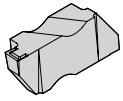

catalog number	SSC	W		Ap max		RR		T		TN6010	TN6025	THM
		mm	in	mm	in	mm	in	mm	in			
NG2M195RK	2	1,95	.077	1,09	.043	0,19	.008	2,81	.110	3606829	3607417	●
NG2M200RK	2	2,00	.079	1,09	.043	0,19	.008	2,81	.110	3607100	3607071	●
NG2M220RK	2	2,20	.087	1,09	.043	0,19	.008	2,81	.110	●	3607521	●
NG2M225RK	2	2,25	.089	1,09	.043	0,19	.008	2,81	.110	3606828	3607411	●
NG2094RK	2	2,39	.094	1,09	.043	0,19	.008	2,79	.110	3607146	3607317	●
NG2M250RK	2	2,50	.098	1,09	.043	0,19	.008	2,81	.110	●	3607324	●
NG2M275RK	2	2,75	.108	1,09	.043	0,19	.008	2,81	.110	3606916	3607409	●
NG2M300RK	2	3,00	.118	1,09	.043	0,19	.008	2,81	.110	3606676	3607340	●
NG2125RK	2	3,18	.125	1,09	.043	0,19	.008	2,79	.110	3607155	3607361	●
NG2M325RK	2	3,25	.128	1,09	.043	0,19	.008	2,79	.110	●	3607533	●
NG3M100RK	3	1,00	.039	0,76	.030	0,20	.008	1,91	.075	●	3607219	●
NG3M120RK	3	1,20	.047	0,76	.030	0,19	.008	1,91	.075	3607412	●	●

INDEXABLE MILLING

SOLID END MILLING

HOLEMAKING

TAPPING

TURNING

## Grooving and Turning Inserts • NG-K • Grooving with Chip Breaker

(continued)

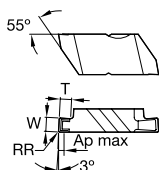
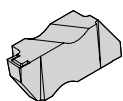

● first choice

○ alternate choice

P	●	●	●	●
M	●	●	●	○
K	●	○	○	●
N	●	○	○	○
S	○	○	○	○
H	○	○	○	○

catalog number	SSC	W		Ap max		RR		T		TN6010	TN6025	THM
		mm	in	mm	in	mm	in	mm	in			
NG3047RK	3	1,19	.047	0,76	.030	0,19	.008	1,91	.075	3607084	3607238	●
NG3M150RK	3	1,50	.059	1,02	.040	0,19	.008	2,39	.094	3607221	3607238	○
NG3062RK	3	1,57	.062	1,02	.040	0,19	.008	2,39	.094	3607055	3607070	○
NG3M175RK	3	1,75	.069	1,02	.040	0,19	.008	2,39	.094	3607418	3607238	○
NG3072RK	3	1,83	.072	1,02	.040	0,19	.008	2,39	.094	3607332	3607332	○
NG3078RK	3	1,98	.078	1,02	.040	0,19	.008	2,39	.094	3607111	3607309	○
NG3M200RK	3	2,00	.079	1,02	.040	0,19	.008	2,39	.094	3607208	3607208	○
NG3M220RK	3	2,20	.087	1,02	.040	0,19	.008	2,39	.094	3607336	3607336	○
NG3M225RK	3	2,24	.088	1,02	.040	0,19	.008	2,39	.094	3606674	3607310	○
NG3094RK	3	2,39	.094	1,02	.040	0,19	.008	3,81	.150	3606660	3607069	○
NG3M250RK	3	2,50	.098	1,02	.040	0,19	.008	3,81	.150	3607217	3607217	○
NG3M275RK	3	2,75	.108	1,02	.040	0,19	.008	3,81	.150	3606677	3607337	○

INDEXABLE MILLING

SOLID END MILLING

HOLEMAKING

TAPPING

TURNING

Grooving and Turning Inserts • NG-K • Grooving with Chip Breaker

(continued)

- first choice
- alternate choice

P	●	●	●	●
M	●	●	●	○
K	●	○	○	●
N	●	○	○	○
S	○	○	○	○
H	○	○	○	○

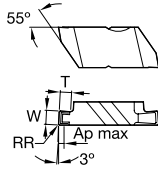
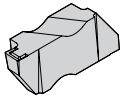

catalog number	SSC	W		Ap max		RR		T		TN6010	TN6025	THM
		mm	in	mm	in	mm	in	mm	in			
NG3M300RK	3	3,00	.118	1,02	.040	0,19	.008	3,81	.150	3607138	3607072	●
NG3125RK	3	3,18	.125	1,02	.040	0,19	.008	3,81	.150	3607057	3607068	○
NG3M320RK	3	3,20	.126	1,02	.040	0,19	.008	3,81	.150	●	3607365	○
NG3M350RK	3	3,50	.138	2,92	.115	0,32	.013	3,81	.150	●	3607302	○
NG3156RK	3	3,96	.156	2,92	.115	0,19	.008	3,81	.150	3607127	3607456	○
NG3M400RK	3	4,00	.158	2,92	.115	0,32	.013	3,81	.150	3606678	3607235	○
NG3M425RK	3	4,25	.167	2,92	.115	0,32	.013	3,81	.150	3606914	●	○
NG3M450RK	3	4,50	.177	2,92	.115	0,32	.013	3,81	.150	●	3607362	○
NG3189RK	3	4,80	.189	2,92	.115	0,57	.023	3,81	.150	3607108	3607305	○
NG4M300RK	4	3,00	.118	1,02	.040	0,19	.008	3,81	.150	●	3607388	○
NG4125RK	4	3,18	.125	1,06	.040	0,19	.008	3,81	.150	3607163	3607449	○
NG4M350RK	4	3,50	.138	2,92	.115	0,57	.023	6,35	.250	●	3607370	○

INDEXABLE MILLING

SOLID END MILLING

HOLEMAKING

TAPPING

TURNING

## Grooving and Turning Inserts • NG-K • Grooving with Chip Breaker

(continued)

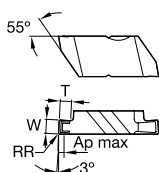
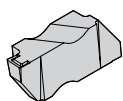

- first choice
- alternate choice

P	●	●	●	●
M	●	●	●	○
K	●	○	○	●
N	●	○	○	○
S	○	○	○	○
H	○	○	○	○

catalog number	SSC	W		Ap max		RR		T		TN6010	TN6025	THM
		mm	in	mm	in	mm	in	mm	in			
NG4M400RK	4	4,00	.158	2,92	.115	0,57	.023	6,35	.250	3606908	3607390	
NG4M450RK	4	4,50	.177	2,92	.115	0,57	.023	6,35	.250		3607390	
NG4189RK	4	4,80	.189	2,92	.115	0,57	.023	6,35	.250	3607103	3607220	
NG4M550RK	4	5,50	.217	3,81	.150	0,58	.023	6,35	.250		3607383	
NG4250RK	4	6,35	.250	3,81	.150	0,57	.023	6,35	.250		3607304	
left hand												
NG2M050LK	2	0,50	.020	0,64	.025	0,09	.004	0,64	.025		3607463	
NG2031LK	2	0,79	.031	0,76	.030	0,09	.004	1,27	.050	3607112	3607443	
NG2M080LK	2	0,80	.032	0,76	.030	0,09	.004	1,27	.050	3606911	3607534	
NG2M100LK	2	1,00	.039	0,76	.030	0,09	.004	1,27	.050		3607239	
NG2M120LK	2	1,20	.047	0,76	.030	0,09	.004	1,27	.050	3606827	3607334	
NG2047LK	2	1,19	.047	0,76	.030	0,09	.004	1,27	.050		3607376	

INDEXABLE MILLING

SOLID END MILLING

HOLEMAKING

TAPPING

TURNING

Grooving and Turning Inserts • NG-K • Grooving with Chip Breaker

(continued)

- first choice
- alternate choice

P	●	●	●	●
M	●	●	●	○
K	●	○	○	●
N	●	○	○	○
S	○	○	○	○
H	○	○	○	○

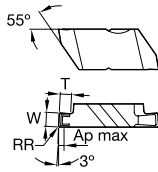
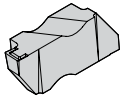

catalog number	SSC	W		Ap max		RR		T		TN6010	TN6025	THM
		mm	in	mm	in	mm	in	mm	in			
NG2M140LK	2	1,40	.055	0,76	.030	0,09	.004	1,27	.050	3606904	3607338	●
NG2M150LK	2	1,50	.059	1,09	.043	0,19	.008	2,79	.110	3607294	3607338	○
NG2062LK	2	1,58	.062	1,09	.043	0,19	.008	2,79	.110	3607126	3607307	○
NG2M170LK	2	1,70	.067	1,09	.043	0,19	.008	2,79	.110	3606905	3607327	○
NG2M175LK	2	1,75	.069	1,09	.043	0,19	.008	2,79	.110	3607421	3607421	○
NG2M195LK	2	1,95	.077	1,09	.043	0,19	.008	2,79	.110	3607420	3607421	○
NG2M200LK	2	2,00	.079	1,09	.043	0,19	.008	2,79	.110	3607144	3607207	○
NG2M220LK	2	2,20	.087	1,09	.043	0,19	.008	2,79	.110	3607367	3607367	○
NG2M225LK	2	2,25	.089	1,09	.043	0,19	.008	2,79	.110	3607413	3607413	○
NG2094LK	2	2,39	.094	1,09	.043	0,19	.008	2,79	.110	3607149	3607380	○
NG2M250LK	2	2,50	.098	1,09	.043	0,19	.008	2,79	.110	3607518	3607518	○
NG2M275LK	2	2,75	.108	1,09	.043	0,19	.008	2,80	.110	3607292	3607292	○

Grooving and Turning Inserts • NG-K • Grooving with Chip Breaker

(continued)

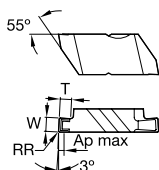
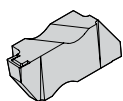

- first choice
- alternate choice

P	●	●	●	●
M	●	●	●	●
K	●	○	○	●
N	●	○	○	○
S	●	●	●	○
H	○	○	○	○

catalog number	SSC	W		Ap max		RR		T		TN6010	TN6025	THM
		mm	in	mm	in	mm	in	mm	in			
NG2M300LK	2	3,00	.118	1,09	.043	0,19	.008	2,80	.110	●	●	●
NG2125LK	2	3,18	.125	1,09	.043	0,19	.008	2,79	.110	○	○	○
NG2M325LK	2	3,25	.128	1,09	.043	0,19	.008	2,79	.110	●	●	●
NG3M100LK	3	1,00	.039	0,76	.030	0,20	.008	1,91	.075	○	○	○
NG3M120LK	3	1,20	.047	0,76	.030	0,19	.008	1,91	.075	●	●	●
NG3047LK	3	1,19	.047	0,76	.030	0,19	.008	1,90	.075	○	○	○
NG3M150LK	3	1,50	.059	1,02	.040	0,19	.008	2,39	.094	●	●	●
NG3062LK	3	1,58	.062	1,02	.040	0,19	.008	2,39	.094	○	○	○
NG3M175LK	3	1,75	.069	1,02	.040	0,19	.008	2,39	.094	●	●	●
NG3072LK	3	1,83	.072	1,02	.040	0,19	.008	2,39	.094	○	○	○
NG3078LK	3	1,98	.078	1,02	.040	0,19	.008	2,39	.094	●	●	●
NG3M200LK	3	2,00	.079	1,02	.040	0,19	.008	2,39	.094	○	○	○

INDEXABLE MILLING

SOLID END MILLING

HOLEMAKING

TAPPING

TURNING

Grooving and Turning Inserts • NG-K • Grooving with Chip Breaker

(continued)

- first choice
- alternate choice

P	●	●	●	●
M	●	●	●	●
K	●	○	○	●
N	●	○	○	○
S	○	○	○	○
H	○	○	○	○

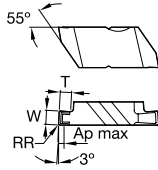
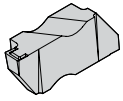

catalog number	SSC	W		Ap max		RR		T		TN6010	TN6025	THM
		mm	in	mm	in	mm	in	mm	in			
NG3M220LK	3	2,20	.087	1,02	.040	0,19	.008	2,39	.094	●	●	●
NG3M225LK	3	2,25	.089	1,02	.040	0,19	.008	2,39	.094	●	●	●
NG3094LK	3	2,39	.094	1,02	.040	0,19	.008	3,81	.150	●	●	●
NG3M250LK	3	2,50	.098	1,02	.040	0,19	.008	3,81	.150	●	●	●
NG3M275LK	3	2,75	.108	1,02	.040	0,19	.008	3,81	.150	●	●	●
NG3M300LK	3	3,00	.118	1,02	.040	0,19	.008	3,81	.150	●	●	●
NG3125LK	3	3,18	.125	1,02	.040	0,19	.008	3,81	.150	●	●	●
NG3M320LK	3	3,20	.126	1,02	.040	0,19	.008	3,81	.150	●	●	●
NG3M325LK	3	3,25	.128	1,02	.040	0,19	.008	3,81	.150	●	●	●
NG3M350LK	3	3,50	.138	2,92	.115	0,32	.013	3,81	.150	●	●	●
NG3156LK	3	3,96	.156	2,92	.115	0,19	.008	3,81	.150	●	●	●
NG3M400LK	3	4,00	.158	2,92	.115	0,32	.013	3,81	.150	●	●	●



## Grooving and Turning Inserts • NG-K • Grooving with Chip Breaker

(continued)

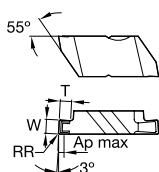
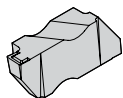

- first choice
- alternate choice

P	●	●	●	●
M	●	●	●	●
K	●	○	○	●
N	●	○	○	○
S	●	○	○	○
H	○	○	○	○

catalog number	SSC	W		Ap max		RR		T		TN6010	TN6025	THM
		mm	in	mm	in	mm	in	mm	in			
NG3M450LK	3	4,50	.177	2,92	.115	0,32	.013	3,81	.150	●	●	●
NG3189LK	3	4,80	.189	2,92	.115	0,57	.023	3,81	.150	○	○	○
NG4125LK	4	3,18	.125	1,06	.400	0,19	.008	3,81	.150	○	○	○
NG4M400LK	4	4,00	.158	2,92	.115	0,57	.023	6,35	.250	○	○	○
NG4189LK	4	4,80	.189	2,92	.115	0,57	.023	6,35	.250	○	○	○
NG4M600LK	4	6,00	.236	3,81	.150	0,57	.023	6,34	.250	○	○	○
NG4250LK	4	6,35	.250	3,81	.150	0,57	.023	6,35	.250	○	○	○

NOTE: SSC = To correspond with the SSC on the toolholder.

INDEXABLE MILLING

SOLID END MILLING

HOLEMAKING

TAPPING

TURNING

Grooving and Turning Inserts • NGD-K • Deep Grooving with Chip Breaker

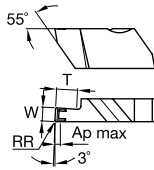
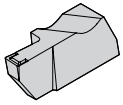

- first choice
- alternate choice

P	●	●	●	●
M	●	●	●	○
K	●	○	○	●
N	●	●	○	○
S	●	●	●	○
H	○	○	○	○

catalog number right hand	SSC	W		Ap max		RR		T		cutting edges	TN6010	TN6025	THM
		mm	in	mm	in	mm	in	mm	in				
NGD2M150RK	2	1,50	.059	1,09	.043	0,19	.008	4,06	.160	1	●	○	○
NGD2M200RK	2	2,00	.079	1,09	.043	0,19	.008	5,08	.200	1	●	○	○
NGD2M250RK	2	2,50	.098	1,09	.043	0,19	.008	5,08	.200	1	●	○	○
NGD3062RK	3	1,58	.062	1,02	.040	0,19	.008	3,18	.125	2	●	○	○
NGD3M200RK	3	2,00	.079	1,02	.040	0,19	.008	4,06	.160	1	●	○	○
NGD3094RK	3	2,39	.094	1,02	.040	0,19	.008	6,35	.250	1	●	○	○
NGD3M250RK	3	2,50	.098	1,02	.040	0,19	.008	6,35	.250	1	●	○	○
NGD3M300RK	3	3,00	.118	1,02	.040	0,19	.008	6,35	.250	1	●	○	○
NGD3125RK	3	3,18	.125	1,02	.040	0,19	.008	6,35	.250	1	●	○	○
NGD3M350RK	3	3,50	.138	2,92	.115	0,32	.013	6,35	.250	1	●	○	○
NGD3M400RK	3	4,00	.158	2,92	.115	0,32	.013	6,35	.250	1	●	○	○

INDEXABLE MILLING

SOLID END MILLING

HOLE/MAKING

TAPPING

TURNING

## Grooving and Turning Inserts • NGD-K • Deep Grooving with Chip Breaker

(continued)

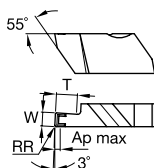
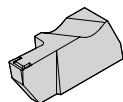

● first choice

○ alternate choice

P	●	●	●	●
M	●	●	●	○
K	●	○	○	○
N	●	○	○	○
S	●	○	○	○
H	○	○	○	○

catalog number	SSC	W		Ap max		RR		T		cutting edges	TN6010	TN6025	THM
		mm	in	mm	in	mm	in	mm	in				
NGD3189RK	3	4,80	.189	2,92	.115	0,58	.023	6,35	.250	1	3607170	3607373	1
NGD4125RK	4	3,18	.125	1,02	.040	0,19	.008	6,35	.250	2	3607133	3607312	1
NGD4M400RK	4	4,00	.157	2,92	.115	0,57	.023	9,53	.375	1	3607507	3607507	1
NGD4M450RK	4	4,50	.177	2,92	.115	0,57	.023	12,70	.500	1	3607508	3607508	1
NGD4189RK	4	4,80	.189	2,92	.115	0,57	.023	9,53	.375	1	3607161	3607321	1
NGD4M500RK	4	5,00	.197	2,92	.115	0,57	.023	12,70	.500	1	3606988	3607321	1
NGD4250RK	4	6,35	.250	3,81	.150	0,57	.023	12,70	.500	1	3607134	3607414	1
left hand													
NGD2M150LK	2	1,50	.059	1,09	.043	0,19	.008	4,06	.160	1	3606935	3607402	1
NGD2M200LK	2	2,00	.079	1,09	.043	0,19	.008	5,08	.200	1	3606936	3607399	1
NGD2M250LK	2	2,50	.098	1,09	.043	0,19	.008	5,08	.200	1	3606992	3607391	1
NGD3062LK	3	1,57	.062	1,02	.040	0,19	.008	3,18	.125	2	3607098	3607451	1

Grooving and Turning Inserts • NGD-K • Deep Grooving with Chip Breaker

(continued)

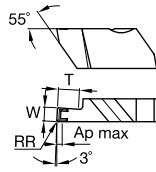
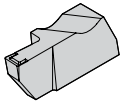

- first choice
- alternate choice

P	●	●	●	●	●
M	●	●	●	●	○
K	●	○	○	○	○
N	●	●	○	○	○
S	●	○	○	○	○
H	○	○	○	○	○

catalog number	SSC	W		Ap max		RR		T		cutting edges	TN6010	TN6025	THM
		mm	in	mm	in	mm	in	mm	in				
NGD3M200LK	3	2,00	.079	1,02	.040	0,19	.008	4,06	.160	1	3606941	3607487	3607035
NGD3094LK	3	2,39	.094	1,02	.040	0,19	.008	6,34	.250	1	3607096	3607240	3607035
NGD3M250LK	3	2,50	.098	1,02	.040	0,19	.008	6,35	.250	1	3606942	3607423	
NGD3M300LK	3	3,00	.118	1,02	.040	0,19	.008	6,35	.250	1	3606943	3607400	
NGD3125LK	3	3,18	.125	1,02	.040	0,19	.008	6,35	.250	1	3607097	3607209	
NGD3M350LK	3	3,50	.138	2,92	.115	0,32	.013	6,35	.250	1	3607488	3607424	
NGD3M400LK	3	4,00	.158	2,92	.115	0,32	.013	6,35	.250	1	3607148	3607410	
NGD3189LK	3	4,80	.189	2,92	.115	0,57	.023	6,35	.250	1	3607410	3607424	
NGD4125LK	4	3,18	.125	1,02	.040	0,19	.008	6,35	.250	2	3607489	3607316	
NGD4M400LK	4	4,00	.158	2,92	.115	0,58	.023	9,52	.375	1	3607489	3607490	
NGD4M450LK	4	4,50	.177	2,92	.115	0,57	.023	12,70	.500	1	3607147	3607314	
NGD4189LK	4	4,80	.189	2,92	.115	0,57	.023	9,53	.375	1	3607314	3607491	
NGD4M500LK	4	5,00	.197	2,92	.115	0,58	.023	12,70	.500	1	3607422	3607491	
NGD4250LK	4	6,35	.250	3,80	.150	0,57	.023	12,70	.500	1	3607422	3607491	

NOTE: SSC = To correspond with the SSC on the toolholder.

## Grooving and Turning Inserts • NGP • Grooving • Positive

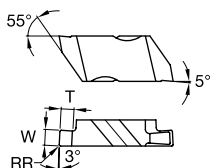
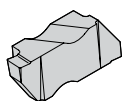

- first choice
- alternate choice

P	●	●	●	●
M	●	●	●	●
K	●	○	○	●
N	●	○	○	○
S	●	○	○	○
H	○	○	○	○

catalog number	SSC	W		RR		T		TN6010	TN6025	THM
		mm	in	mm	in	mm	in			
<b>right hand</b>										
NGP2M150R	2	1,50	.059	0,19	.008	2,79	.110	●	●	3607045
NGP2062R	2	1,58	.062	0,19	.008	2,79	.110	○	○	3607128
NGP2M200R	2	2,00	.079	0,19	.008	2,79	.110	○	○	3607046
NGP2M300R	2	3,00	.118	0,19	.008	2,79	.110	○	○	3606978
NGP3M150R	3	1,50	.059	0,19	.008	1,90	.075	○	○	3606979
<b>left hand</b>										
NGP2062L	2	1,57	.062	0,19	.008	2,79	.110	○	○	3607182
NGP2M200L	2	2,00	.079	0,19	.008	2,79	.110	○	○	3606968
NGP3M250L	3	2,50	.098	0,19	.008	3,81	.150	○	○	3606973

NOTE: SSC = To correspond with the SSC on the toolholder.

INDEXABLE MILLING

SOLID END MILLING

HOLEMAKING

TAPPING

TURNING

Grooving and Turning Inserts • NF-K • Face Grooving with Chip Breaker

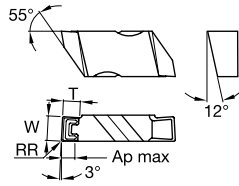
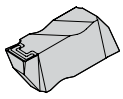

- first choice
- alternate choice

P	●	●	●	●
M	●	●	●	●
K	●	○	○	●
N	●	○	○	○
S	●	●	●	○
H	○	○	○	○

catalog number	SSC	W		Ap max		RR		T		TN6010	TN6025	THM
		mm	in	mm	in	mm	in	mm	in			
<b>right hand</b>												
NF3M200RK	3	2,00	.079	1,02	.040	0,19	.008	1,78	.070		3607511	
NF3M300RK	3	3,00	.118	1,02	.040	0,19	.008	3,81	.150		3607512	
NF3125RK	3	3,18	.125	1,02	.040	0,19	.008	3,81	.150		3607241	
<b>left hand</b>												
NF3M200LK	3	2,00	.079	1,02	.040	0,19	.008	1,78	.070		3607428	
NF3M300LK	3	3,00	.118	1,02	.040	0,19	.008	3,81	.150		3607429	
NF3125LK	3	3,18	.125	1,02	.040	0,19	.008	3,81	.150		3607322	
NF3156LK	3	3,96	.156	2,92	.115	0,19	.008	3,81	.150		3607333	

NOTE: SSC = To correspond with the SSC on the toolholder.

INDEXABLE MILLING

SOLID END MILLING

HOLE/MAKING

TAPPING

TURNING

## Grooving and Turning Inserts • NFD-K • Deep Face Grooving with Chip Breaker

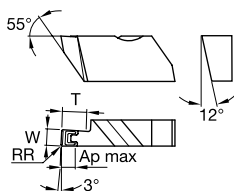
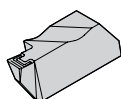

- first choice
- alternate choice

P	●	●	●	●
M	●	●	●	○
K	●	○	○	●
N	●	○	○	○
S	●	●	○	○
H	○	○	○	○

catalog number	SSC	W		Ap max		RR		T		cutting edges	TN6010	TN6025	THM
		mm	in	mm	in	mm	in	mm	in				
<b>right hand</b>													
NFD3M300RK	3	3,00	.118	1,02	.040	0,19	.008	6,35	.250	1		3607523	
NFD3125RK	3	3,18	.125	1,02	.040	0,19	.008	6,35	.250	1		3607296	
NFD4189RK	4	4,80	.189	2,92	.115	0,57	.023	9,53	.375	1		3607325	
<b>left hand</b>													
NFD3M300LK	3	3,00	.118	1,02	.040	0,19	.008	6,35	.250	1		3607464	
NFD3125LK	3	3,18	.125	1,02	.040	0,19	.008	6,35	.250	1		3607293	
NFD4189LK	4	4,80	.189	2,92	.115	0,57	.023	9,53	.375	1		3607415	

NOTE: SSC = To correspond with the SSC on the toolholder.

INDEXABLE MILLING

SOLID END MILLING

HOLEMAKING

TAPPING

TURNING

Grooving and Turning Inserts • NP-K • Profiling with Chip Control

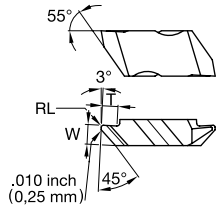
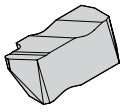

- first choice
- alternate choice

P	●	●	●	●
M	●	●	●	○
K	●	○	○	●
N	●	○	○	○
S	●	●	○	○
H	○	○	○	○

catalog number	SSC	W		Ap max		RL		T		TN6010	TN6025	THM
		mm	in	mm	in	mm	in	mm	in			
<b>right hand</b>												
NP2002RK	2	3,73	.147	2,75	.108	0,09	.004	2,81	.110	3607136	3607477	-
NP3002RK	3	4,88	.192	3,84	.151	0,09	.004	5,08	.200	3607154	3607493	-
NP3012RK	3	4,90	.193	3,86	.152	0,34	.014	5,08	.200	-	3607328	-

NOTE: SSC = To correspond with the SSC on the toolholder.  
 Right-hand insert shown; left-hand insert is mirror image.  
 Width tolerance is +/- .005" (+/- 0,13mm).

INDEXABLE MILLING

SOLID END MILLING

HOLE/MAKING

TAPPING

TURNING



## Grooving and Turning Inserts • NR • Full Radius

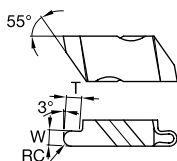
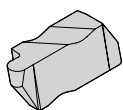

- first choice
- alternate choice

P	●	●	●	●
M	●	●	●	○
K	●	○	○	○
N	●	○	○	○
S	●	○	○	○
H	○	○	○	○

catalog number	SSC	W		RC		T		TN6010	TN6025	THM
		mm	in	mm	in	mm	in			
<b>right hand</b>										
NR2M050R	2	1,00	.039	0,50	.020	1,27	.050	3606957	3607993	●
NR2M075R	2	1,50	.059	0,75	.030	2,79	.110	3606929	3607469	●
NR2031R	2	1,58	.062	0,79	.031	2,79	.110	3607174	3607301	●
NR2M100R	2	2,00	.079	1,00	.039	2,79	.110	3606930	3607470	●
NR2047R	2	2,39	.094	1,19	.047	2,79	.110	3607494	3607470	●
NR2M150R	2	3,00	.118	1,50	.059	2,79	.110	3607174	3607472	●
NR2M175R	2	3,50	.138	1,75	.069	2,79	.110	3607483	3607483	●
NR3031R	3	1,58	.062	0,79	.031	2,39	.094	3607125	3607475	●
NR3M100R	3	2,00	.079	1,00	.039	2,39	.094	3606958	3607997	●
NR3047R	3	2,39	.094	1,19	.047	3,81	.150	3607093	3607502	●
NR3M125R	3	2,50	.098	1,25	.049	3,81	.150	3607439	3607502	●

INDEXABLE MILLING

SOLID END MILLING

HOLE/MAKING

TAPPING

TURNING

Grooving and Turning Inserts • NR • Full Radius

(continued)

- first choice
- alternate choice

P	●	●	●	●
M	●	●	●	○
K	●	○	○	●
N	●	○	○	○
S	○	○	○	○
H	○	○	○	○

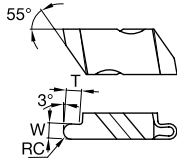
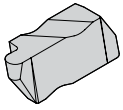

catalog number	SSC	W		RC		T		TN6010	TN6025	THM
		mm	in	mm	in	mm	in			
NR3M150R	3	3,00	.118	1,50	.059	3,81	.150	3606960	3607440	●
NR3062R	3	3,18	.125	1,59	.063	3,81	.150	3607131	3607473	○
NR3M175R	3	3,50	.138	1,75	.069	3,81	.150	●	3607441	○
NR3M200R	3	4,00	.157	2,00	.079	3,81	.150	●	3607398	○
NR3M225R	3	4,50	.177	2,25	.089	3,81	.150	●	3607442	○
NR3094R	3	4,78	.188	2,39	.094	3,81	.150	3607180	3607476	○
NR4M200R	4	4,00	.157	2,00	.079	6,35	.250	●	3607484	○
NR4M250R	4	5,00	.197	2,50	.098	6,35	.250	●	3607486	○
NR4125R	4	6,35	.250	3,18	.125	6,35	.250	3607130	3607500	○
left hand										
NR2M050L	2	1,00	.039	0,50	.020	1,27	.050	3606924	3606948	○
NR2M075L	2	1,50	.059	0,75	.030	2,79	.110	3607430	3607401	○

INDEXABLE MILLING

SOLID END MILLING

HOLEMAKING

TAPPING

TURNING

## Grooving and Turning Inserts • NR • Full Radius

(continued)

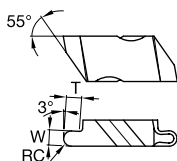
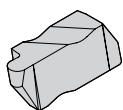

- first choice
- alternate choice

P	●	●	●	●
M	●	●	●	○
K	●	○	○	●
N	●	○	○	○
S	○	○	○	○
H	○	○	○	○

catalog number	SSC	W		RC		T		TN6010	TN6025	THM
		mm	in	mm	in	mm	in			
NR2031L	2	1,58	.062	0,79	.031	2,79	.110	3607176	3607319	■
NR2M100L	2	2,00	.079	1,00	.039	2,79	.110	3607431	3607431	■
NR2047L	2	2,39	.094	1,19	.047	2,79	.110	3607446	3607446	■
NR2M125L	2	2,50	.098	1,25	.049	2,79	.110	3607432	3607432	■
NR2M150L	2	3,00	.118	1,50	.059	2,79	.110	3606927	3607433	■
NR2M175L	2	3,50	.138	1,75	.069	2,79	.110	3607434	3607434	■
NR3031L	3	1,58	.062	0,79	.031	2,39	.094	3607139	3607478	■
NR3M100L	3	2,00	.079	1,00	.039	2,39	.094	3606949	3607478	■
NR3047L	3	2,39	.094	1,19	.047	3,81	.150	3607135	3607479	■
NR3M125L	3	2,50	.098	1,25	.049	3,81	.150	3607435	3607479	■
NR3M150L	3	3,00	.118	1,50	.059	3,81	.150	3607436	3607436	■
NR3062L	3	3,18	.125	1,59	.063	3,81	.150	3607171	3607497	■
								3607032	3607032	■

INDEXABLE MILLING

SOLID END MILLING

HOLEMAKING

TAPPING

TURNING

Grooving and Turning Inserts • NR • Full Radius

(continued)

- first choice
- alternate choice

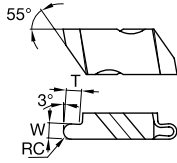
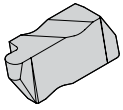

P	●	●	●	●
M	●	●	●	○
K	●	○	○	●
N	●	○	○	○
S	●	●	●	○
H	○	○	○	○

catalog number	SSC	W		RC		T		TN6010	TN6025	THM
		mm	in	mm	in	mm	in			
NR3M175L	3	3,50	.138	1,75	.069	3,81	.150	●	●	●
NR3M200L	3	4,00	.157	2,00	.079	3,81	.150	3606953	3607437	●
NR3M225L	3	4,50	.177	2,25	.089	3,81	.150	●	●	●
NR3094L	3	4,78	.188	2,39	.094	3,81	.150	●	●	●
NR4M250L	4	5,00	.197	2,50	.098	6,35	.250	3606956	●	●
NR4125L	4	6,35	.250	3,18	.125	6,35	.250	●	3607514	●

NOTE: SSC = To correspond with the SSC on the toolholder.

INDEXABLE MILLING

SOLID END MILLING

HOLEMAKING

TAPPING

TURNING

## Grooving and Turning Inserts • NR-K • Full Radius with Chip Breaker

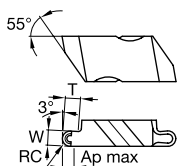
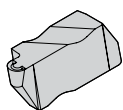

- first choice
- alternate choice

P	●	●	●	●
M	●	●	●	○
K	●	○	○	○
N	●	○	○	○
S	●	○	○	○
H	○	○	○	○

catalog number	SSC	W		Ap max		RC		T		TN6010	TN6025	THM
		mm	in	mm	in	mm	in	mm	in			
<b>right hand</b>												
NR3031RK	3	1,57	.062	1,97	.078	0,79	.031	2,39	.094	3607062	3607206	■
NR3047RK	3	2,39	.094	1,91	.075	1,19	.047	3,81	.150	3607086	3607214	■
NR3062RK	3	3,18	.125	2,92	.115	1,59	.063	3,81	.150	3607056	3607236	■
NR3078RK	3	3,97	.156	2,54	.100	1,98	.078	3,81	.150	3607407	3607407	■
NR4062RK	4	3,18	.125	2,92	.115	1,59	.063	3,81	.150	3607461	3607407	■
NR4125RK	4	6,35	.250	3,81	.150	3,18	.125	6,35	.250	3607303	3607303	■
<b>left hand</b>												
NR3031LK	3	1,58	.062	1,98	.078	0,79	.031	2,39	.094	3607095	3607222	■
NR3047LK	3	2,39	.094	3,81	.150	1,20	.047	3,81	.150	3607102	3607408	■
NR3062LK	3	3,18	.125	2,92	.115	1,59	.063	3,81	.150	3607091	3607216	■
NR3078LK	3	3,96	.156	2,54	.100	1,98	.078	3,81	.150	3607172	3607306	■
NR4062LK	4	3,18	.125	2,92	.115	1,59	.063	3,81	.150	3607156	3607156	■
NR4094LK	4	4,79	.188	3,81	.150	2,39	.094	6,35	.250	3607150	3607452	■
NR4125LK	4	6,36	.250	3,81	.150	3,18	.125	6,35	.250	3607458	3607458	■

NOTE: SSC = To correspond with the SSC on the toolholder.

Grooving and Turning Inserts • NRD • Deep Grooving • Full Radius

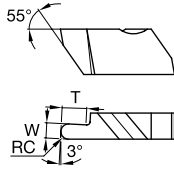
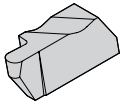

- first choice
- alternate choice

P	●	●	●	○
M	●	●	●	○
K	●	○	○	●
N	●	○	○	○
S	●	○	○	○
H	○	○	○	○

catalog number	SSC	W		RC		T		cutting edges	TN6010	TN6025	THM
		mm	in	mm	in	mm	in				
<b>right hand</b>											
NRD3031R	3	1,58	.062	0,79	.031	3,18	.125	2	3607087	3607457	1
NRD3062R	3	3,17	.125	1,59	.063	6,35	.250	1	3607099	3607474	1
NRD4062R	4	3,18	.125	1,59	.063	6,35	.250	2	3607499	3607499	1
NRD4125R	4	6,35	.250	3,18	.125	12,70	.500	1	3607496	3607496	1
<b>left hand</b>											
NRD3031L	3	1,58	.062	0,79	.031	3,18	.125	2	3607085	3607455	1
NRD3062L	3	3,17	.125	1,59	.063	6,35	.250	1	3607124	3607462	1
NRD4062L	4	3,18	.125	1,59	.063	6,35	.250	2	3607295	3607462	1

NOTE: SSC = To correspond with the SSC on the toolholder.

INDEXABLE MILLING

SOLID END MILLING

HOLE/MAKING

TAPPING

TURNING

TopGroove Holder • Catalog Numbering System

INDEXABLE MILLING

SOLID END MILLING

HOLEMAKING

TAPPING

TURNING

**N**

Insert Holding Method

**N** – TopGroove\*

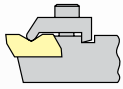

\*Proprietary standard only.

**S**

Insert Mounting Location

End mount

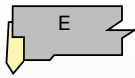

Side mount Offset

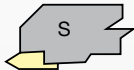

Side mount No offset for swiss machining

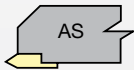

NRR undercut



**R**

Hand of Tool



Drop Head

**16**

Shank Size

**Inch:**  
For shanks 5/8" square and larger, the number represents the number of sixteenths of width and height. For shanks under 5/8" square, the number of sixteenths of cross section is preceded by a zero. For rectangular holders, the first digit represents the number of eighths of width and the second digit the number of quarters of height, except for a toolholder 1-1/4" x 1-1/2", which is given the number 91.

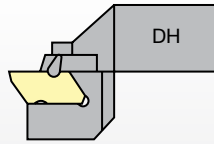

**3**

Insert Size



insert size	W1
2	.150"
3	.195"
4	.255"
5	.380"
6	.383"
8	.438"

**D**

Qualified Surface and Length

- A** – Qualified back and end, 4" long
- B** – Qualified back and end, 4.5" long
- C** – Qualified back and end, 5" long
- D** – Qualified back and end, 6" long
- E** – Qualified back and end, 7" long

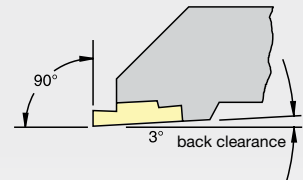

NOTE: Holders are designed to locate insert inclined to 3° to provide back clearance down open side.

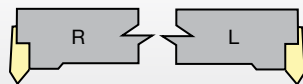

End mount

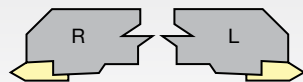

Side mount

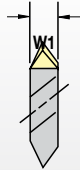
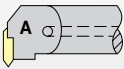
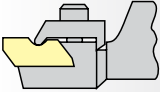
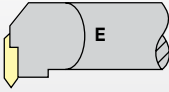
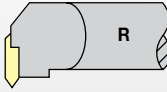
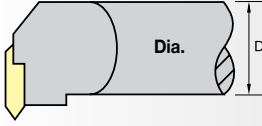
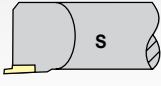

TopGroove Boring Bar • Catalog Numbering System

A	32	N	E	R	3																
Bar Type	Bar Diameter	Insert Holding Method	Insert Location	Hand of Tool	Insert Size																
Steel with coolant		N – TopGroove	End mount	Right hand																	
					<table border="1"> <thead> <tr> <th>insert size</th> <th>W1</th> </tr> </thead> <tbody> <tr> <td>1</td> <td>.100"</td> </tr> <tr> <td>2</td> <td>.150"</td> </tr> <tr> <td>3</td> <td>.195"</td> </tr> <tr> <td>4</td> <td>.255"</td> </tr> <tr> <td>5</td> <td>.380"</td> </tr> <tr> <td>6</td> <td>.383"</td> </tr> <tr> <td>8</td> <td>.438"</td> </tr> </tbody> </table>	insert size	W1	1	.100"	2	.150"	3	.195"	4	.255"	5	.380"	6	.383"	8	.438"
insert size	W1																				
1	.100"																				
2	.150"																				
3	.195"																				
4	.255"																				
5	.380"																				
6	.383"																				
8	.438"																				
A two-digit number that indicates the bar diameter in 1/16" increments.			Side mount	Left hand																	
																					

INDEXABLE MILLING

SOLID END MILLING

HOLE/MAKING

TAPPING

TURNING



## Integral Toolholders • NS

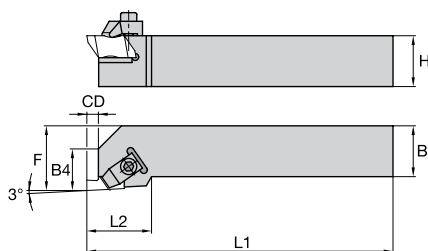
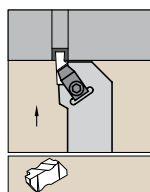

order number	catalog number	H	B	F	L1	L2	B4	CD	gage insert
<b>right hand</b>									
3632147	NSR062	.375	.375	.562	2.50	.75	.35	.138	N.2R
3639035	NSR082V	.500	.500	.750	3.50	.75	.35	.138	N.2R
3639026	NSR122B	.750	.750	1.000	4.50	.75	.35	.138	N.2R
3639027	NSR123A	.750	.750	1.000	4.00	1.25	.50	.210	N.3R
3639023	NSR123B	.750	.750	1.000	4.50	1.25	.50	.210	N.3R
3639025	NSR162C	1.000	1.000	1.250	5.00	.75	.35	.138	N.2R
3638592	NSR163C	1.000	1.000	1.250	5.00	1.25	.50	.210	N.3R
3638591	NSR163D	1.000	1.000	1.250	6.00	1.25	.50	.210	N.3R
3639028	NSR203D	1.250	1.250	1.500	6.00	1.25	.50	.210	N.3R
<b>left hand</b>									
3632145	NSL122B	.750	.750	1.000	4.50	.75	.35	.138	N.2L
3632152	NSL123A	.750	.750	1.000	4.00	1.25	.50	.210	N.3L
3639032	NSL123B	.750	.750	1.000	4.50	1.25	.50	.210	N.3L
3632138	NSL162C	1.000	1.000	1.250	5.00	.75	.35	.138	N.2L
3639029	NSL163C	1.000	1.000	1.250	5.00	1.25	.50	.210	N.3L
3639024	NSL163D	1.000	1.000	1.250	6.00	1.25	.50	.210	N.3L
3639037	NSL203D	1.250	1.250	1.500	6.00	1.25	.50	.210	N.3L

NOTE: F dimension measured over sharp point of insert.

## Integral Toolholders • NS • with Shim

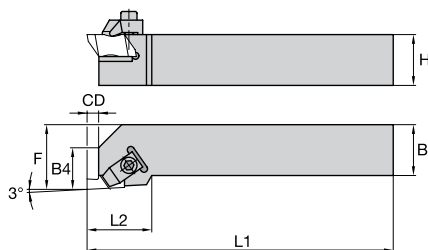
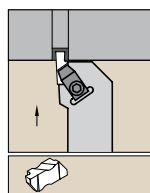

order number	catalog number	H	B	F	L1	L2	B4	CD	gage insert
<b>right hand</b>									
3639031	NSR164C	1.000	1.000	1.250	5.00	1.38	.54	.294	N.4R
3639033	NSR164D	1.000	1.000	1.250	6.00	1.38	.54	.294	N.4R
3632153	NSR166D	1.000	1.000	1.250	6.00	1.38	.67	.334	N.6R
3637539	NSR168D	1.000	1.000	1.250	6.00	1.25	.72	.225	N.8R
3637472	NSR206D	1.250	1.250	1.500	6.00	1.38	.67	.334	N.6R
3637526	NSR854D	1.250	1.000	1.250	6.00	1.38	.54	.294	N.4R
<b>left hand</b>									
3639040	NSL164D	1.000	1.000	1.250	6.00	1.38	.54	.294	N.4L
3639036	NSL204D	1.250	1.250	1.500	6.00	1.38	.54	.294	N.4L

NOTE: SSC = To correspond with the SSC on the insert.

Integral Toolholders • NAS

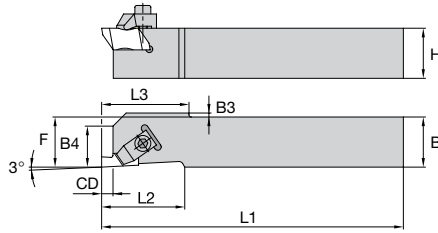
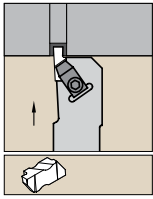

order number	catalog number	H	B	F	L1	L2	B4	CD	B3	L3	gage insert
<b>right hand</b>											
3636529	NASR082D	.500	.500	.500	6.00	.75	.35	.138	—	—	N.2R
3639042	NASR083D	.500	.500	.500	6.00	1.25	.50	.210	.13	1.32	N.3R
3639039	NASR102B	.625	.625	.625	4.50	.75	.35	.138	—	—	N.2R
3636532	NASR103B	.625	.625	.625	4.50	1.25	—	.210	—	—	N.3R
<b>left hand</b>											
3636534	NASL082D	.500	.500	.500	6.00	.75	.35	.138	—	—	N.2L
3636524	NASL103B	.625	.625	.625	4.50	1.25	—	.210	—	—	N.3L

NOTE: F dimension measured over sharp point of insert.  
Insert exterior edge in line with toolholder edge.

Integral Toolholders • NS-DH

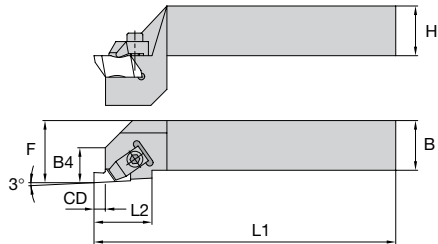
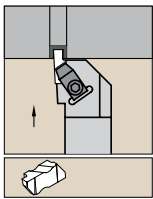

order number	catalog number	H	B	F	L1	L2	B4	CD	gage insert
<b>right hand</b>									
3637528	NSRDH163D	1.000	1.000	1.250	6.00	1.25	.58	.210	N.3R

NOTE: SSC = To correspond with the SSC on the insert.

INDEXABLE MILLING

SOLID END MILLING

HOLEMAKING

TAPPING

TURNING

## Integral Toolholders • NE

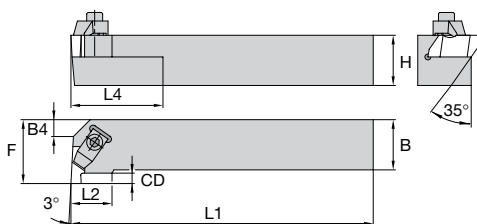
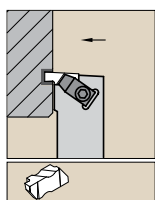

Right-hand toolholder shown.

order number	catalog number	H	B	F	L1	L2	B4	CD	gage insert
<b>right hand</b>									
3632133	NER123B	.750	.750	1.125	4.50	.75	—	.210	N.3L
3637486	NER162C	1.000	1.000	1.250	5.00	.50	.41	.138	N.2L
3639038	NER163C	1.000	1.000	1.250	5.00	.75	—	.210	N.3L
3639030	NER163D	1.000	1.000	1.250	6.00	.75	—	.210	N.3L
3639043	NER164D	1.000	1.000	1.375	6.00	.75	—	.294	N.4L
3637522	NER244D	1.500	1.500	2.000	6.00	.75	.65	.294	N.4L
<b>left hand</b>									
3637503	NEL122B	.750	.750	1.000	4.50	.50	.29	.138	N.2R
3637500	NEL162C	1.000	1.000	1.250	5.00	.50	.41	.138	N.2R
3632155	NEL163C	1.000	1.000	1.250	5.00	.75	—	.210	N.3R
3639041	NEL163D	1.000	1.000	1.250	6.00	.75	—	.210	N.3R
3632159	NEL204D	1.250	1.250	1.625	6.00	.75	.27	.294	N.4R

NOTE: F dimension measured over sharp point of insert.

## Integral I.D. Grooving Boring Bars • A-NE

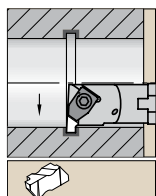

Steel shank with through coolant.

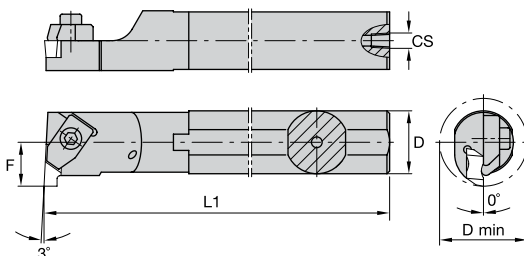

Right-hand toolholder shown.

order number	catalog number	D	D min	L1	F	CS	gage insert
<b>right hand</b>							
3632117	A08NER2	.500	.730	8.000	.437	1/16-27 NPT	N.2L
3632114	A10SNER2	.625	1.000	10.000	.500	1/8-27 NPT	N.2L
3632118	A12SNER2	.750	1.125	10.000	.562	1/8-27 NPT	N.2L
3632113	A16NER3	1.000	1.375	12.000	.688	1/4-18 NPT	N.3L
3632130	A16TNER2	1.000	1.375	12.000	.688	1/4-18 NPT	N.2L
3632116	A20NER3	1.250	1.750	14.000	.875	1/4-18 NPT	N.3L
3632115	A24NER3	1.500	2.000	14.000	1.000	1/4-18 NPT	N.3L
3632123	A28NER4	1.750	2.500	14.000	1.250	1/4-18 NPT	N.4L
3632122	A32NER3	2.000	2.500	16.000	1.250	1/4-18 NPT	N.3L
<b>left hand</b>							
3632131	A08NEL2	.500	.730	8.000	.437	1/16-27 NPT	N.2R
3632127	A10SNEL2	.625	1.000	10.000	.500	1/8-27 NPT	N.2R
3632126	A12SNEL2	.750	1.125	10.000	.562	1/8-27 NPT	N.2R
3632142	A16NEL2	1.000	1.375	12.000	.688	1/4-18 NPT	N.2R
3632120	A16NEL3	1.000	1.375	12.000	.688	1/4-18 NPT	N.3R
3632124	A20NEL3	1.250	1.750	14.000	.875	1/4-18 NPT	N.3R
3632128	A24NEL3	1.500	2.000	14.000	1.000	1/4-18 NPT	N.3R
3632141	A28NEL4	1.750	2.500	14.000	1.250	1/4-18 NPT	N.4R
3632149	A32NEL4	2.000	2.750	16.000	1.375	1/4-18 NPT	N.4R

NOTE: Minimum bore capability varies with depth of groove. See page E430 for details.  
F dimension measured over sharp point of insert.

### Integral I.D. Grooving Boring Bars • A-NE-1

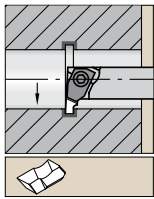

Necked steel shank with through coolant.

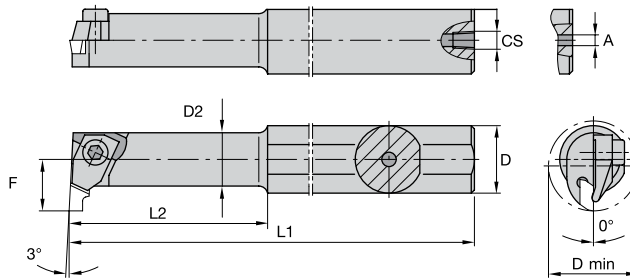

Right-hand toolholder shown.

order number	catalog number	D	D min	D2	L1	L2	F	A	CS	gage insert
<b>right hand</b>										
3632121	A06NER1	.375	.440	.312	6	1.250	.258	.125	—	N.1L
3632119	A08NER1	.500	.440	.310	8	1.290	.258	.094	1/16-27 NPT	N.1L

NOTE: Minimum bore capability varies with depth of groove. See page E430 for details.  
F dimension measured over sharp point of insert.

### Integral I.D. Grooving Boring Bars • A-NS

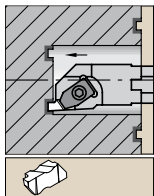

Steel shank with through coolant.

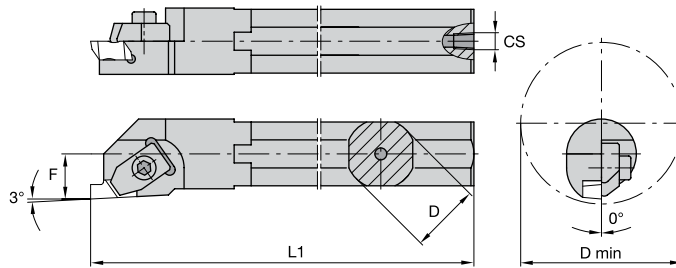

Right-hand tool holder shown.

order number	catalog number	D	D min	L1	F	CS	gage insert
<b>right hand</b>							
3632129	A16TNSR3	1.000	2.250	12.000	.640	1/4-18 NPT	N.3R
3632135	A20UNSR3	1.250	2.250	14.000	.765	1/4-18 NPT	N.3R
<b>left hand</b>							
3632137	A16TNSL3	1.000	2.250	12.000	.640	1/4-18 NPT	N.3L
3637502	A32VNSL3	2.000	2.375	16.000	1.281	1/4-18 NPT	N.3L

NOTE: Minimum bore capability varies with depth of groove. See page E430 for details.  
F dimension measured over sharp point of insert.

INDEXABLE MILLING

SOLID END MILLING

HOLE/MAKING









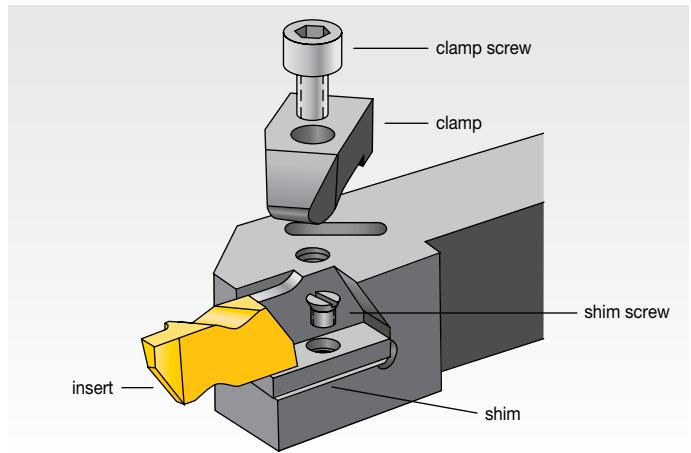

TAPPING

TURNING

## Hardware

### TopGroove Toolholders and Boring Bars



insert size and style	 clamp	 clamp screw	 shim	 shim screw
NG-1L 	CM-109	S-304	–	–
NG-2R	CM-182	S-310	–	–
NG-2L	CM-183	S-310	–	–
NG-2R 	CM-74	S-310	–	–
NG-2L	CM-75	S-310	–	–
NG-3R	CM-184	S-412	–	–
NG-3L	CM-185	S-412	–	–
NG-3R	CM-72	S-412	–	–
NG-3L 	CM-73	S-412	–	–
NG-3R*	CM-78	S-412	–	–
NG-3L*	CM-70	S-412	–	–
NG-4R	CM-72	S-412	SM-420	SL-344
NG-4L 	CM-73	S-412	SM-420	SL-344
NG-5R	CM-80	S-352	–	–
NG-5L 	CM-81	S-352	–	–
NG-6R	CM-120	S-412	SM-416	S-111
NG-6L 	CM-121	S-412	SM-416	S-111
<b>TopGroove relief grooving</b>				
NU-3125R	CM-72	S-412	–	–
NU-3125L	CM-73	S-412	–	–
NU-3125R**	CM-72	S-618	–	–
NU-3125L**	CM-73	S-618	–	–
<b>Utility threading</b>				
NTU-4R	CM-72	S-412	–	–
NTU-4L	CM-73	S-412	–	–

\*25mm diameter boring head.

\*\*Boring head.

## Grooving Tool Failure and Solution Guide

Practical Solutions to Common Grooving Problems

### Holder Position for Grooving Operation

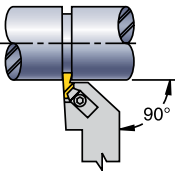

### How to Cut a Groove Slightly Wider than the Groove Tool

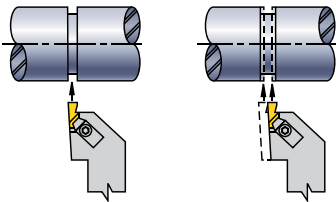

1. Plunge the center of the groove.
2. Plunge each side of the groove to get the specified width. Use a slower feed rate when cutting groove sides.

### How to Cut Wider Grooves

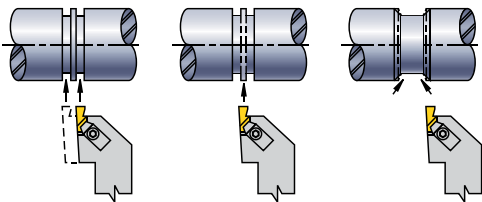

1. Plunge out both sides of groove width.
2. Plunge center area to remove web of material remaining.
3. Plunge both sides of groove at the required angle, using approximately one-half the width of the grooving tool for maximum width of cut.

### Finish Turning the Groove

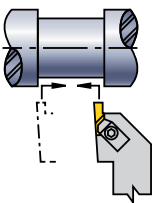

1. Follow recommendations explained above.
2. To avoid insert chipping and to achieve groove wall perpendicularity, follow the tool path outlined here.
3. Use the lightest depth of cut that still enables good chip surface finishing.

problem	solution
bur	<ol style="list-style-type: none"> <li>1. Ensure tool center height.</li> <li>2. Use sharp tool (index more often).</li> <li>3. Use positive rake PVD-coated insert.</li> <li>4. Use correct grade for workpiece material.</li> <li>5. Use correct geometry (e.g., positive rake for work-hardening material).</li> <li>6. Chamfer before grooving.</li> <li>7. Change tool path.</li> </ol>
poor surface finish	<ol style="list-style-type: none"> <li>1. Increase speed.</li> <li>2. Use sharp tool (index more often).</li> <li>3. Dwell tool in bottom 1–3 revolutions (max).</li> <li>4. Use proper chip control geometry.</li> <li>5. Increase coolant flow/concentration.</li> <li>6. Ensure proper setup (overhang, shank size).</li> <li>7. Use correct geometry (e.g., positive rake for work-hardening material).</li> </ol>
groove bottom that is not flat	<ol style="list-style-type: none"> <li>1. Use sharp tool (index more often).</li> <li>2. Dwell tool in bottom 1–3 revolutions (max).</li> <li>3. Reduce tool overhang (increase rigidity).</li> <li>4. Ensure correct tool alignment.</li> <li>5. Reduce feed rate at groove bottom.</li> <li>6. Use a wider insert.</li> <li>7. Ensure tool center height.</li> </ol>
poor chip control	<ol style="list-style-type: none"> <li>1. Use “K” chip control geometry insert.</li> <li>2. Use sharp tool (index more often).</li> <li>3. Increase coolant concentration.</li> <li>4. Adjust feed rate (usually increase first).</li> </ol>
chatter	<ol style="list-style-type: none"> <li>1. Reduce tool and workpiece overhang.</li> <li>2. Adjust speed and feed (usually increase first).</li> <li>3. Ensure center height.</li> </ol>
insert chipping	<ol style="list-style-type: none"> <li>1. Use correct grade for workpiece material.</li> <li>2. Increase speed.</li> <li>3. Reduce feed.</li> <li>4. Use a stronger grade.</li> <li>5. Increase tool and setup rigidity.</li> </ol>
side walls not straight	<ol style="list-style-type: none"> <li>1. Check tool alignment for square.</li> <li>2. Use correct insert hand.</li> <li>3. Reduce workpiece and tool overhang.</li> <li>4. Use sharp insert (index more often).</li> </ol>

INDEXABLE MILLING

SOLID END MILLING

HOLEMAKING

TAPPING

TURNING

## Machining Guidelines

### Machining Guidelines for Chip Control • Grooving

When the proper cutter diameter is not available, proper cutter positioning will provide positive results.

- Center height of insert should be positioned at the center of the workpiece or up to .005" (0,13mm) above.
- Dwell time in the bottom of the groove (more than three revolutions) is not recommended.
- Chip control is feed rate related and should be adjusted to fit the particular situation.  
Recommended feed range is .003-.012 IPR (0,08-0,3 mm/rev).

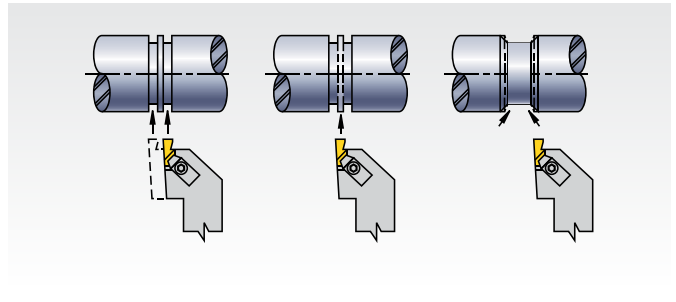

### Machining Guidelines for Chip Control • Turning/Profiling

Maximum depth of cut for side cutting (turning/profiling) depends on the material being cut and the width of the tool.

- .031-.062" (0,79-1,6mm) wide insert can cut up to .025" (0,6mm) deep.
- .067-.128" (1,7-3,3mm) wide insert can cut up to .040" (1mm) deep.
- .138-.189" (3,5-4,8mm) wide insert can cut up to .080" (2mm) deep.
- .197-.250" (5-6,35mm) wide insert can cut up to .120" (3mm) deep.

#### Finish Turning the Groove

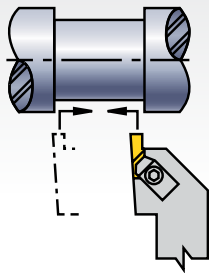

1. Plunge both sides of groove width.
2. Plunge center area to remove web of material remaining.
3. To avoid insert chipping and to achieve groove wall perpendicularity, follow the tool path outlined.
4. Use the lightest depth of cut that still allows good chipbreaking, tool life, and surface finish.

Groove Limits

insert catalog number	maximum internal groove depth		minimum bore diameter	
	inch	mm	inch	mm
NG-1094L	.075	1,91	.800	20,32
—	.040	1,02	.440	11,18
NG-2031R/L	.050	1,27	.730	18,54
NG-2041R/L	—	—	—	—
NG-2047R/L	—	—	—	—
NG-2058R/L	—	—	—	—
—	.110	2,79	2.500	63,50
NG-2062R/L	.102	2,59	1.750	44,45
NG-2094R/L	.098	2,49	1.500	38,10
NG-2125R/L	.080	2,03	1.000	25,40
—	.055	1,40	.730	18,54
NG-3047R/L	—	—	—	—
NG-3062R/L	.094	2,39	1.750	44,45
NG-3072R/L	.090	2,29	1.625	41,28
NG-3078R/L	.075	1,91	1.375	34,93
NG-3088R/L	—	—	—	—
NG-3094R/L	—	—	—	—
NG-3097R/L	.150	3,81	2.375	60,33
NG-3105R/L	—	—	—	—
NG-3110R/L	.145	3,68	2.125	53,98
NG-3122R/L	—	—	—	—
NG-3125R/L	.138	3,51	1.875	47,63
NG-3142R/L	—	—	—	—
NG-3156R/L	.125	3,18	1.625	41,28
NG-3178R/L	—	—	—	—
NG-3185R/L	.110	2,79	1.375	34,93
NG-3189R/L	—	—	—	—
NG-4125R/L	.150	3,81	2.750	69,85
—	.250	6,35	5.750	146,05
NG-4189R/L	.245	6,22	5.000	127,00
NG-4213R/L	.240	6,10	4.500	114,30
NG-4219R/L	.218	5,54	3.250	82,55
NG-4250R/L	.200	5,08	2.500	63,50

NOTE: The same maximum groove depth and minimum bore diameter values also apply to metric, NG-K (chip control), and NR (full radius) inserts of similar size. The same internal grooving depth limits are a function of bar clearance versus bore diameters.

## Machining Guidelines

### Internal Groove Depth versus Bar Interference

NOTE: Internal grooving depth limits are a function of bar clearance versus bore diameters.

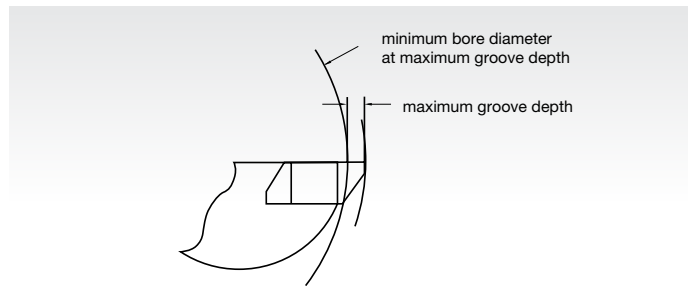

### Machining Guidelines for Back Turning/ Turning/Profiling

The NP-K-style TopGroove inserts were engineered specifically for back turning on small automatic lathes, but they also find applications for other light turning and profiling operations. For general applications, maximum depth of cut should not exceed .108" (2,74mm) for size 2 inserts or .151" (3,84mm) for size 3 inserts.

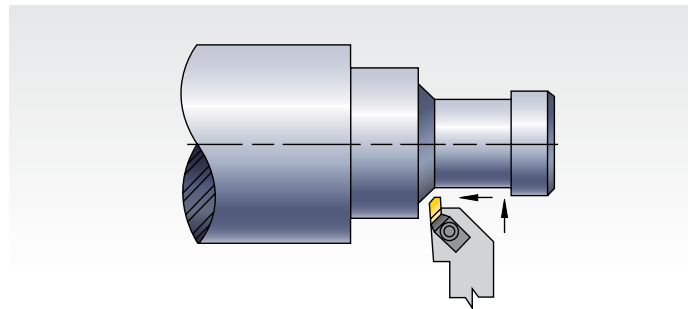

### Machining Guidelines for Using TopGroove Deep Grooving Inserts (NGD)

Typically, those NGD- and NRD-style inserts with two cutting edges require no machine offset changes. However, those inserts with only one cutting edge do require offset changes. Refer to the chart here to ensure proper offset adjustments.

insert catalog number	add to C dimension		add to F dimension	
	inch	mm	inch	mm
NGD-3062	.000	0,00	.000	0,00
NGD-3094	.100	2,54	.100	2,54
NGD-3125	.100	2,54	.100	2,54
NGD-3189	.100	2,54	.100	2,54
NGD-4125	.000	0,00	.000	0,00
NGD-4189	.125	3,18	.125	3,18
NGD-4250	.250	6,35	.250	6,35
NRD-3031	.000	0,00	.000	0,00
NRD-3062	.100	2,54	.100	2,54
NRD-4062	.000	0,00	.000	0,00
NRD-4094	.250	6,35	.250	6,35
NRD-4125	.250	6,35	.250	6,35

### TopGroove Insert Selection Guide

- All TopGroove inserts are precision ground to provide accurate edge location and secure locking of the insert in the toolholder pocket.
- TopGroove inserts can be used in either toolholders or boring bars.
- Right-hand TopGroove toolholders use right-hand inserts. Left-hand TopGroove toolholders use left-hand inserts.
- Right-hand TopGroove boring bars use left-hand inserts. Left-hand TopGroove boring bars use right-hand inserts.

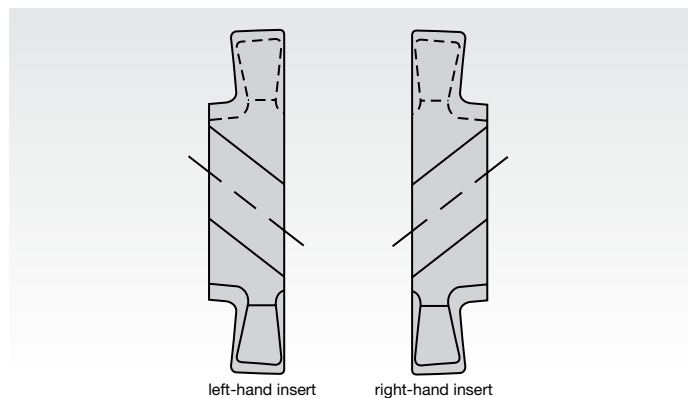



## Machining Guidelines

### Machining Guidelines for Poly-Vee Grooving with Custom Solution and TopGroove NV Inserts (NV3-J and NV4-L)

- To machine cross section “J”, use insert NV3-J.
- To machine cross section “L”, use insert NV4-L.

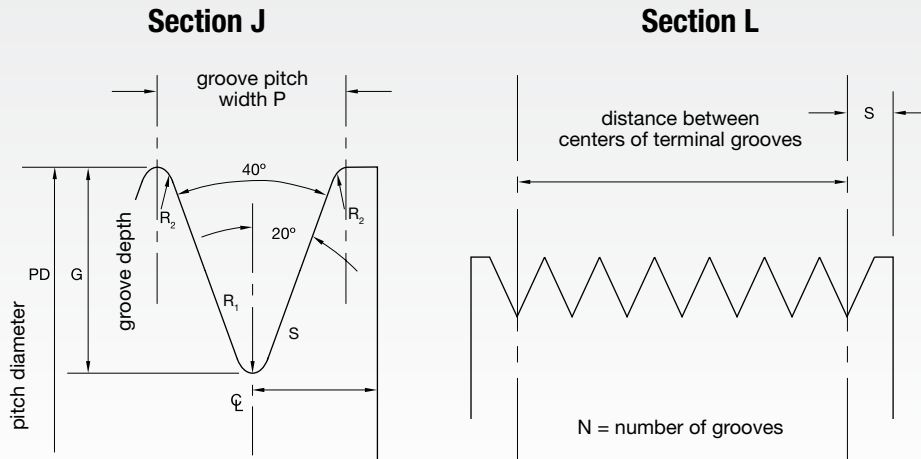

### Groove Dimensions and Tolerances for Sheaves

groove cross section	pitch width (P)	groove depth (G)	minimum radius (R2)	radius (R1)	terminal distance	distance between centers of terminal grooves and maximum accumulated tolerance
J	.092 ±.001	.087 ±.005	.008	.0125 ±.0025	1/8	(N-1).092 ±.010
L	.185 ±.002	.201 ±.005	.015	.0125 ±.0025	3/8	(N-1).185 ±.010

Machining Guidelines

Machining Guidelines for Face Grooving Operations • External

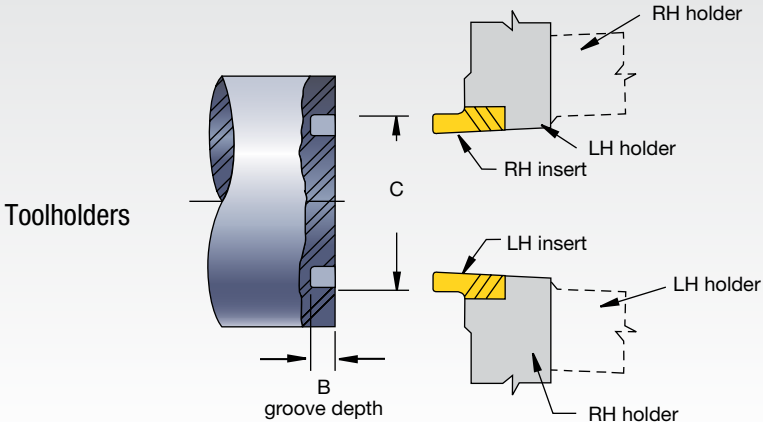

Standard NF/NDF Inserts

insert family	maximum groove depth B		minimum groove diameter C	
	inch	mm	inch	mm
NF-3	.060	1,52	.94	23,9
NF-3	.094	2,39	1.20	30,5
NF-3	.125	3,18	1.42	36,1
NF-3	.150	3,81	1.63	41,3
NFD-3	.250	6,35	1.88	47,6
NFD-4	.375	9,53	2.25	57,2
NFD-4	.500	12,70	2.25	57,2

Machining Guidelines for Face Grooving Operations • External

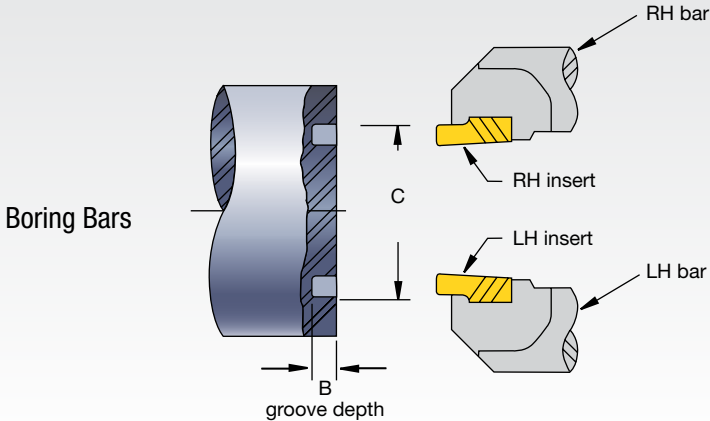

Standard NG/NGD Inserts

insert family	maximum groove depth B		minimum groove diameter C	
	inch	mm	inch	mm
NG-2	.050	1,27	2.13	54,0
NG-2	.110	2,79	3.50	88,9
NG-3	.094	2,39	4.00	101,6
NG-3	.125	3,18	5.00	127,0
NG-3	.150	3,81	5.50	139,7
NGD-3	.250	6,35	6.88	174,6
NG-4	.150	3,81	6.00	152,4
NG-4	.250	6,35	8.25	209,6
NGD-4	.375	9,53	8.75	222,3
NGD-4	.500	12,70	8.75	222,3

INDEXABLE MILLING

SOLID END MILLING

HOLE/MAKING

TAPPING

TURNING

## Machining Guidelines

### Machining Guidelines for Face Grooving Operations • Internal

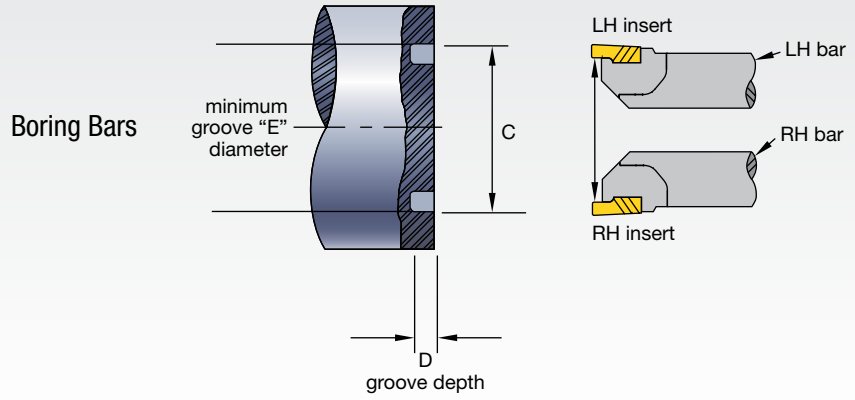

Standard NG/NGD Inserts

insert family	maximum groove depth B		minimum groove diameter C	
	inch	mm	inch	mm
NFD-3-KI	.250	6,35	2.250	63,5

*NOTE: Also check minimum bore diameter of boring bar. See page E430.*



# LG Grooving

## Large-Width Grooving

The LG Grooving platform is designed for large-width grooving using periphery ground inserts for close tolerances. (+/- .05mm)

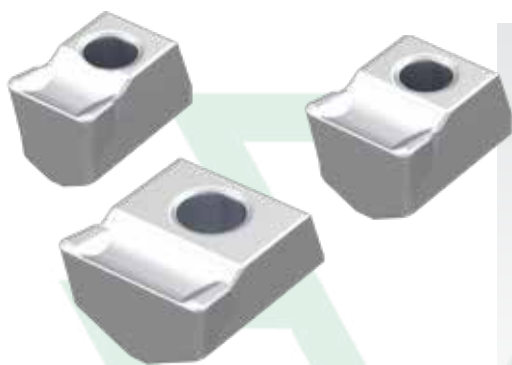

- Inserts available from 8.15–16.20mm.
- Inserts feature a bottom 'V' for secure seating on the pocket seat.
- Grade WU35CT with easy-wear identification.
- The chip groove design with positive rake enables good chip control and reduced forces.



Primarily used in the Energy segment for grooving operations on turbine rotors.

## BENEFITS

### VERSATILITY

Single-sided, versatile grooving and cut-off solution with smooth surface finish.

### STABILITY

Insert seating and clamping mechanism ensures stability and reliability in heavy-duty applications.

## APPLICATIONS



O.D.  
GROOVING



DEEP  
GROOVING

### Grades and Grade Descriptions

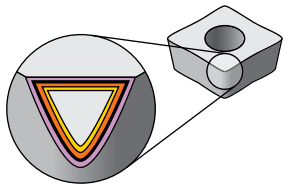

Coatings provide high-speed capability and are engineered for finishing to heavy roughing.

P	Steel
M	Stainless Steel
K	Cast Iron
N	Non-Ferrous
S	High-Temp Alloys
H	Hardened Materials

Grade	Coating	Grade Description	wear resistance ← → toughness														
			05	10	15	20	25	30	35	40	45						
WU95CT		Coated carbide MT-CVD/CVD – TiN-TiCN-Al <sub>2</sub> O <sub>3</sub> -TiN. A good combination of tough substrate and wear-resistant, multi-layer CVD coating. Suitable for rough turning in most steels and also stainless steel.	P														
			M														

### Feed Values for Grooving Inserts

#### LG System • 0



0

...0  
Inserts with wide range of applications in grooving and deep grooving. With additional chip control element for good chip control, even with varying widths of cut.

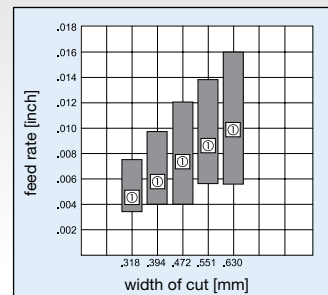

① Recommended Starting Feed

## Recommended Cutting Speeds • Metric

Material Group		Cutting Speed – vc m/min		
		WU35CT		
		min	Start	max
P	0/1	140	175	210
	2	115	145	175
	3	115	145	175
	4	75	100	120
	5	105	140	170
	6	45	60	75
M	1	-	-	-
	2	-	-	-
	3	-	-	-
K	1	-	-	-
	2	-	-	-
	3	-	-	-
N	1	-	-	-
	2	-	-	-
	3	-	-	-
	4	-	-	-
	5	-	-	-
	6	-	-	-
	7	-	-	-
S	1	-	-	-
	2	-	-	-
	3	-	-	-
	4	-	-	-
H	1	-	-	-
	2	-	-	-
	3	-	-	-
	4	-	-	-

## Recommended Cutting Speeds • Inch

Material Group		Cutting Speed – vc SFM		
		WU35CT		
		min	Start	max
P	0 / 1	455	570	685
	2	380	475	575
	3	380	475	575
	4	245	320	390
	5	345	450	555
	6	145	195	245
M	1	-	-	-
	2	-	-	-
	3	-	-	-
K	1	-	-	-
	2	-	-	-
	3	-	-	-
N	1	-	-	-
	2	-	-	-
	3	-	-	-
	4	-	-	-
	5	-	-	-
	6	-	-	-
	7	-	-	-
S	1	-	-	-
	2	-	-	-
	3	-	-	-
	4	-	-	-
H	1	-	-	-
	2	-	-	-
	3	-	-	-
	4	-	-	-

Grooving Inserts • LG LGNO

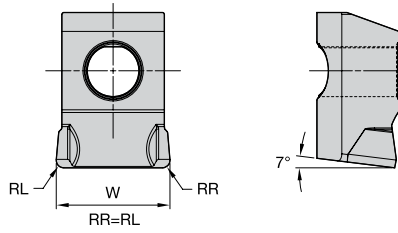

- first choice
- alternate choice

P	●
M	○
K	○
N	○
S	○
H	○
	○

catalog number	W		RR		WU35CT
	mm	in	mm	in	
123568080	8,15	0.32	0,80	0.03	6909025
123568100	10,15	0.40	0,80	0.03	6909026
123568120	12,20	0.48	0,80	0.03	6909027
123568140	14,20	0.56	0,80	0.03	6909028
123568160	16,20	0.64	0,80	0.03	6909029

INDEXABLE MILLING

SOLID END MILLING

HOLE/MAKING

TAPPING

TURNING



Count on the WIDIA™ TopThread system for when high heat, high edge-line load concentrated to a small nose radius, and high feed rates combine to place tremendous demands on carbide threading inserts. TopThread insert technology brings superior chip control to high-demand applications like machining Acme, Buttress, and API threads.



### TOOLHOLDERS

- Reduced inconsistencies and better workpiece finish.
- TopThread inserts are precision-ground to provide accurate edge location and secure locking of the insert in the toolholder pocket.
- Excellent choice for special thread forms and toolholder designs.
- TopThread inserts are available in TN6010™ and TN6025™ grades to withstand the demands placed on the cutting edge of the threading insert.



### INSERTS

- Rigid design for increased stability during threading applications.
- Good quality threads, improved tool life, and improved surface finishes.
- Locking forces in three directions for superior resistance to tangential force.
- Unique 3° insert relief angle for back clearance.
- Available in partial profile inserts for 60° thread forms.

## THE SIMPLE SOLUTION

### VERSATILE



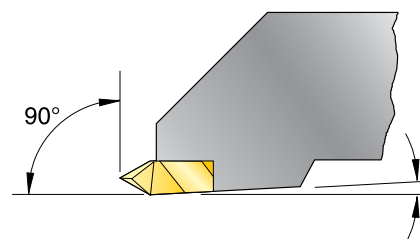

The versatility of the TopThread steel enables you to use both threading and grooving inserts in the same toolholder.



*NOTE: Holders are designed to locate inserts inclined to 3° to provide back clearance down open side.*

# TOP THREAD DEMANDING THREADING APPLICATIONS

## TopThread™

INSERT STYLE	OPTIMUM CUTTING CONDITIONS	FIRST CHOICE	MATERIALS
Chip control or neutral 	<b>TN6010</b> 160–750	<b>TN6025</b> 130–650	<b>P</b>
Chip control or positive 	<b>TN6010</b> 160–600	<b>TN6025</b> 130–450	<b>M</b>
Neutral 	<b>TN6010</b> 230–700	<b>TN6025</b> 200–475	<b>K</b>
Positive 	–	<b>TN6025</b> 160–1150	<b>N</b>
Positive 	<b>TN6010</b> 65–400	<b>TN6025</b> 35–330	<b>S</b>

## INDUSTRY



## Threading Selection Guide

### Step 1 • Select Threading Method and Hand of Tooling

**Required Information:**

- External/internal operation.
- Spindle rotation/hand of thread.
- Feed direction.



**Feed direction toward the chuck • RECOMMENDED**

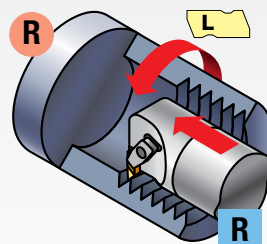
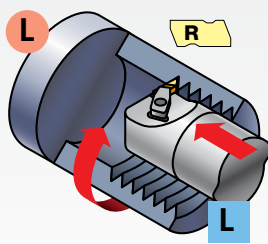
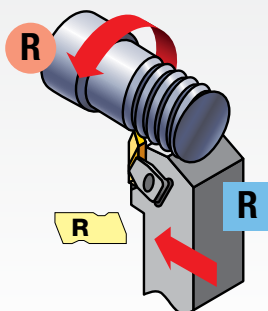
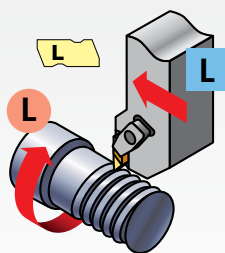

**Feed direction away from the chuck**

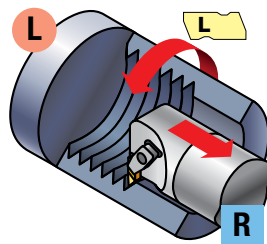
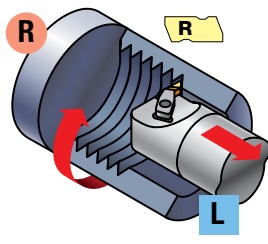
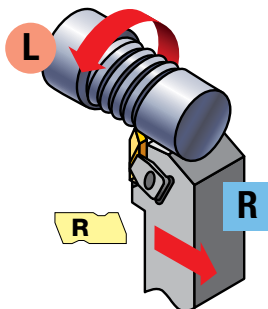
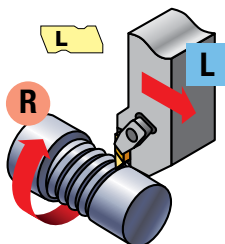

### Step 2 • Select Holder from Catalog Page

The insert size must match the gage insert size of your toolholder selection:

**Required Information:**

- External/internal operation.
- Minimum bore diameter (for internal operations).
- Hand of tool.
- Insert size (gage insert).

catalog number	gage insert
NSR-163D	N.3R
NSR-164D	N.4R

NOTE: TopThread toolholders and boring bars are listed with a gage insert to indicate the size and hand required. They are compatible with both grooving and threading inserts of the same size.

**Select the appropriate holder for the insert size and hand:**

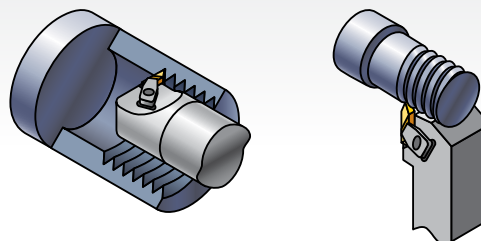

NOTE: Optimize your threading operation by using the proper infeed method and the recommended infeed values.

See the Technical section on pages E506–E507 of this catalog.

For internal threading, minimum bore varies depending on thread type. See page E430 for details.

## Threading Selection Guide



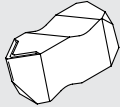

### Step 3 • Choose Insert for Application

- See threading insert overview on page E444.
- Select cresting inserts for fully controlled thread form including diameter control. Cresting inserts eliminate the need for deburring.
- Non-cresting partial profile inserts can cut a variety of thread pitches.
- Note insert size for toolholder selection.

	insert size	catalog number	TN6025	TN6010
	2	NT-2RK	•	•
	3	NT-3RK	•	•
	4	NT-4RK	•	•

### Step 4 • Select Grade and Speed

Recommendations for Grade and Speed Selection — m/min (SFM)

workpiece material	steel	stainless steel	cast iron	non-ferrous metals	high-temp alloys
insert style	chip control or neutral 	chip control or positive 	neutral 	positive 	positive 
optimum cutting conditions	<b>TN6010</b> 50–230n (160–750)	<b>TN6010</b> 50–185 (160–600)	<b>TN6010</b> 70–210 (230–700)	—	<b>TN6010</b> 20–120 (65–400)
first choice	<b>TN6025</b> 40–200 (130–650)	<b>TN6025</b> 40–135 (130–450)	<b>TN6025</b> 60–145 (200–475)	<b>TN6025</b> 50–360 (160–1150)	<b>TN6025</b> 10–100 (35–330)

Examples:

Chip Control: NT-K or NT-CK (partial profile only)

Neutral: NT, NT-C, NTF, NTC, NJ, NJF, NDC-V, NA, NDC, NTB-A/B

Positive: NTP, NTK, NJP, NJK

### TopThread Threading Example:





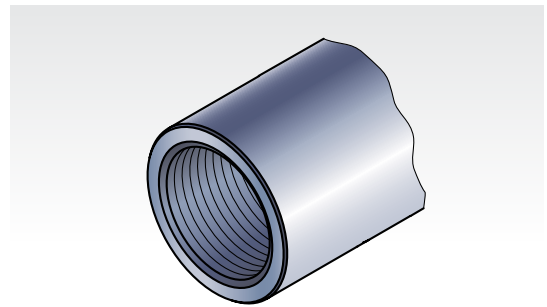





**application:** 8 TPI Acme internal right-hand thread  
**material:** alloy steel  
**workpiece diameter:** 4.5" (114,3mm)  
 good cutting conditions  
 feed towards the chuck

Recommendation:  
**insert:** NA3L8  
**grade:** TN6010  
**insert size:** 3  
**boring bar:** A40NER3  
**gage insert:** N.3L  
**speed:** 500 SFM (150 m/min)  
**infeed passes\*:** 12 passes

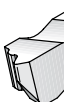

\* Infeed recommendations provided in technical data section on pages E506–E507.

## Insert Overview

chip control — K		style			thread profile	standard	tolerance class	cresting	application	page(s)
		neutral	positive							
NT-K		NT		NTP	Partial Profile 60°	-	-	N	General use for 60° thread forms, such as ISO and UN, where non-cresting inserts are desired to cut a variety of pitches.	E449–E451
NT-CK					Partial Profile 60° — coarse pitch	-	-	N	Coarse pitch 60° thread forms, such as ISO and UN, where non-cresting inserts are desired to cut a variety of pitches.	E452
		NTF		NTK	Partial Profile 60° — fine pitch	-	-	N	Fine pitch 60° thread forms, such as ISO and UN, where non-cresting inserts are desired to cut a variety of pitches — able to thread close to shoulders.	E452–E453
		NTC			American UN	ANSI B1.1:74	2A/2B	Y	Widely used inch-based 60° V-form for all industries.	E454
				NJP	UNJ	SAEA588791	3A/3B	N	Controlled root radius on external threads for military and aerospace industries.	E455
				NJK	UNJ — fine pitch	SAEA588790	3A/3B	N	Controlled root radius on external threads for military and aerospace industries — able to thread close to shoulders.	E455
		NDC-V			NPT	ANSI/ACME B1.201:1983	Standard NPT	Y	National Pipe Thread standard forms for pipe fittings.	custom solution
		NDC-V-M			NPT — multi-tooth	ANSI/ACME B1.201:1983	Standard NPT	Y	High-productivity multi-tooth threading inserts for NPT threads.	custom solution
		NWC-E			Whitworth, BSW, BSP	BS 84:1956, ISO 228/1:1982, DIN 259	Medium Class A	Y	Widely used 55° form for gas and water connections.	E456
		NDC-RD			API Round	API STD. 5B:1979	Standard API RD	Y	60° V-form with large radius for casing, tubing, and line pipe in the oil and gas industry, including 8 and 10 round forms.	E456
		NA			Acme	ANSI B1.5:1988	3G	N	29° truncated thread form for motion applications in a wide variety of industries.	E457
		NAS			Stub Acme	ANSI B1.8:1988	2G	N	Shallow depth 29° truncated thread form for motion applications in a wide variety of industries.	E458
		NTB-B			American Buttress — 45° clearance flank leading (Pull)	ANSI B1.9:1973	Class 2	N	Sawtooth form for axial load bearing applications in a variety of industries — use the “B” style when the 45° clearance flank is the leading flank.	E458

INDEXABLE MILLING

SOLID END MILLING

HOLEMAKING

TAPPING

TURNING

## Grades and Grade Descriptions

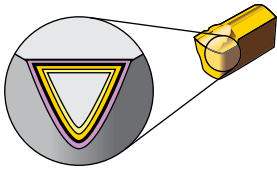

Coatings provide high-speed capability and are engineered for finishing to light roughing.

- Reduce cycle times — high-speed capability.
- Longer tool life — new multilayer coating provides better wear resistance.

P	Steel
M	Stainless Steel
K	Cast Iron
N	Non-Ferrous
S	High-Temp Alloys
H	Hardened Materials

wear resistance ← → toughness

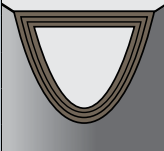
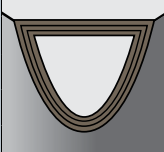
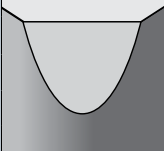

Coating		Grade Description		05	10	15	20	25	30	35	40	45		
Grade TN6010	 HC-P10	An advanced PVD TiAlN coating over a very deformation-resistant unalloyed carbide substrate. TN6010 is ideal for finishing to general machining of most workpiece materials at higher speeds. Excellent for machining most steels, stainless steels, cast irons, non-ferrous materials, and super alloys under stable conditions. It also performs well machining hardened and short chipping materials.	P											
			M											
			K											
			N											
			S											
			H											
Grade TN6025	 HC-P25	An advanced PVD TiAlN-coated grade with a tough, ultra-fine-grain unalloyed substrate. For general-purpose machining of most steels, stainless steels, high-temp alloys, titanium, irons, and non-ferrous materials. Speeds may vary from low to medium and will handle interruptions and high feed rates.	P											
			M											
			K											
			N											
			S											
			H											
Grade THM	 HW-K15	Uncoated carbide for light and medium machining. For cast iron, all non-ferrous metals, and non-metals. Also capable of machining hardened materials at low cutting speeds.	P											
			M											
			K											
			N											
			S											
			H											

- All TopThread inserts are precision-ground to provide accurate edge location and secure locking of the insert in the toolholder pocket.
- TopThread inserts can be used in either toolholders or boring bars.
- All non-cresting-type threading inserts can be used for either external or internal applications. All cresting-type inserts are designated specifically for external or internal use.
- Right-hand TopThread toolholders use right-hand inserts. Left-hand TopThread toolholders use left-hand inserts.

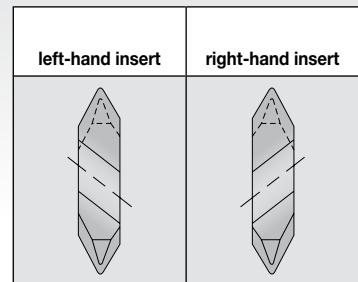
- Right-hand TopThread boring bars use left-hand inserts. Left-hand TopThread boring bars use right-hand inserts.
- See this page for carbide grade selection and more technical information.

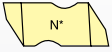
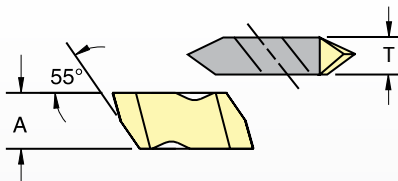

## Catalog Numbering System

<b>N</b>	<b>D</b>	<b>C</b>	<b>3</b>	<b>8RD</b>	<b>R</b>	<b>75</b>																									
Type of Insert	Insert	Additional Information	Insert Size	Industry Thread Identification	Hand of Insert	Definition of Insert	Additional Information																								
<p><b>N</b> – TopThread</p> 		<p><b>B</b> – Buttress</p> <p><b>F</b> – Fine pitch</p> <p><b>S</b> – Stub Acme</p> <p><b>C</b> – Cresting</p> <p><b>P</b> – Positive rake</p> <p><b>K</b> – Fine pitch, positive</p>		<p>Indicates API or drilling industry form designation (e.g., 10RD, 8RD, .038) or controlled root radius threading inserts indicate the root radius in .001" increments (NJ, NJF, NJP, NJK) or M indicates metric ISO thread</p>	<p><b>R</b> – Right hand</p> <p><b>L</b> – Left hand</p>																										
<p><b>A</b> – Acme</p> <p><b>D</b> – API or NPT</p> <p><b>J</b> – UNJ thread</p> <p><b>T</b> – 60° V thread</p> <p><b>W</b> – 55° V Whitworth</p>	 <p>TopThread insert dimensions</p> <table border="1"> <thead> <tr> <th>insert size</th> <th>A mm</th> <th>T mm</th> </tr> </thead> <tbody> <tr><td>1</td><td>2,54</td><td>2,54</td></tr> <tr><td>2</td><td>5,56</td><td>3,81</td></tr> <tr><td>3</td><td>8,74</td><td>4,95</td></tr> <tr><td>4</td><td>11,51</td><td>6,48</td></tr> <tr><td>5</td><td>17,48</td><td>9,65</td></tr> <tr><td>6</td><td>11,51</td><td>9,73</td></tr> <tr><td>8</td><td>7,93</td><td>11,13</td></tr> </tbody> </table>		insert size	A mm	T mm	1	2,54	2,54	2	5,56	3,81	3	8,74	4,95	4	11,51	6,48	5	17,48	9,65	6	11,51	9,73	8	7,93	11,13		<ul style="list-style-type: none"> <li>• Threads per inch or pitch (for metric)</li> <li>• "A" or "B" type Buttress insert</li> <li>• Taper per foot – API threads</li> </ul>			
insert size	A mm	T mm																													
1	2,54	2,54																													
2	5,56	3,81																													
3	8,74	4,95																													
4	11,51	6,48																													
5	17,48	9,65																													
6	11,51	9,73																													
8	7,93	11,13																													
						<p><b>I</b> – Internal thread</p> <p><b>E</b> – External thread (used only if internal and external thread forms are different)</p> <p><b>M</b> – Multiple tooth</p> <p><b>K</b> – Standard chip control</p> <p><b>C</b> – Coarse pitch</p> <p><b>D</b> – Dryseal</p>																									
							<p style="text-align: center;">NJF      NDC-V-M      NTC</p>  <p style="text-align: center;">NA      NT      NT-K</p> 																								

Recommended Cutting Speeds • Metric

Material Group		Cutting Speed – vc m/min								
		TN6010			TN6025			THM		
		min	Start	max	min	Start	max	min	Start	max
P	0/1	140	175	210	130	140	150	90	95	100
	2	115	145	175	110	145	175	75	100	125
	3	115	145	175	110	145	175	75	100	125
	4	75	100	120	75	95	115	55	65	80
	5	105	140	170	100	125	145	70	85	100
	6	45	60	75	40	55	65	30	40	45
M	1	90	115	140	60	75	90	60	75	90
	2	55	70	90	40	50	55	50	60	75
	3	60	80	95	40	50	60	40	50	55
K	1	120	150	180	60	80	90	70	90	100
	2	120	150	180	60	75	85	50	65	80
	3	110	140	170	60	75	90	60	70	80
N	1	600	750	900	600	750	900	600	750	900
	2	535	685	835	535	685	835	500	650	800
	3	230	300	370	230	300	370	600	750	900
	4	135	180	225	135	180	225	500	650	800
	5	70	90	110	70	90	110	230	300	370
	6	445	565	690	445	565	690	150	200	250
	7	550	700	850	550	700	850	150	200	250
S	1	35	40	50	25	35	40	25	35	45
	2	20	20	30	15	20	20	20	30	35
	3	60	70	80	40	60	70	15	25	30
	4	30	35	45	20	30	35	10	15	20
H	1	15	30	60	-	-	-	-	-	-
	2	15	30	60	-	-	-	-	-	-
	3	15	30	60	-	-	-	-	-	-
	4	15	30	60	-	-	-	-	-	-

INDEXABLE MILLING

SOLID END MILLING

HOLEMAKING

TAPPING

TURNING



## Recommended Cutting Speeds • Inch

Material Group		Cutting Speed – vc SFM								
		TN6010			TN6025			THM		
		min	Start	max	min	Start	max	min	Start	max
<b>P</b>	0/1	455	570	685	425	455	490	295	310	325
	2	380	475	575	360	465	575	245	320	405
	3	380	475	575	360	465	575	245	320	405
	4	245	320	390	235	300	365	170	210	260
	5	345	450	555	325	400	475	230	280	330
	6	145	195	245	130	180	210	95	130	145
<b>M</b>	1	295	390	490	195	245	295	180	220	270
	2	180	245	310	130	160	180	115	145	165
	3	195	260	320	130	165	195	225	295	325
<b>K</b>	1	390	490	590	195	255	295	195	255	295
	2	390	490	590	195	240	280	195	240	280
	3	360	455	555	195	245	295	195	245	295
<b>N</b>	1	1965	2460	2950	1965	2460	2950	1805	2295	2785
	2	1750	2240	2730	1750	2240	2730	1805	2295	2785
	3	750	980	1210	750	980	1210	1805	2295	2785
	4	445	590	730	445	590	730	1195	1555	1915
	5	230	295	360	230	295	360	620	820	1015
	6	1450	1855	2260	1450	1855	2260	490	655	820
	7	1805	2295	2785	1805	2295	2785	425	555	690
<b>S</b>	1	110	130	165	75	110	130	75	110	130
	2	55	65	90	40	55	65	60	85	105
	3	195	235	260	135	195	235	45	60	75
	4	95	115	145	65	95	115	35	50	55
<b>H</b>	1	60	100	200	-	-	-	-	-	-
	2	60	100	200	-	-	-	-	-	-
	3	60	100	200	-	-	-	-	-	-
	4	60	100	200	-	-	-	-	-	-

### Threading Inserts • NT-K

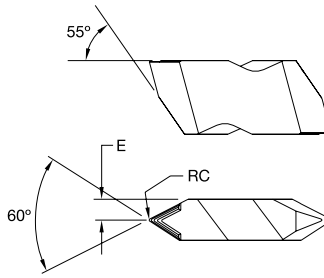
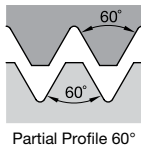
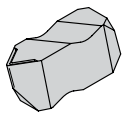

- first choice
- alternate choice

P	●	●	●	●
M	●	●	●	●
K	●	●	○	●
N	●	●	○	○
S	●	●	○	○
H	○	○	○	○

catalog number	RC		E		SSC	external thread pitch mm	internal thread pitch mm	external TPI	internal TPI	TN6010	TN6025	THM
	mm	in	mm	in								
<b>right hand</b>												
NT2RK	0,10	.004	1,90	.075	2	0,70-3,0	1,25-3,5	8-36	7-20	3607651	3607837	—
NT4RK	0,16	.007	3,24	.128	4	1,25-6,25	2,0-6,25	4-20	4-12	—	3607846	—
NT3RK	0,17	.007	2,49	.098	3	1,25-4,0	2,0-5,0	6-20	5-12	3607643	3607824	—
<b>left hand</b>												
NT2LK	0,10	.004	1,90	.075	2	0,70-3,0	1,25-3,5	8-36	7-20	3607674	3607833	—
NT3LK	0,17	.007	2,49	.098	3	1,25-4,0	2,0-5,0	6-20	5-12	3607645	3607828	—

NOTE: SSC = To correspond with the SSC on the toolholder.

### Threading Inserts • NT-1L

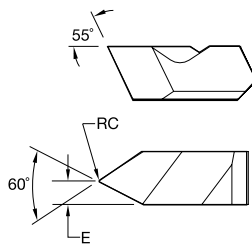
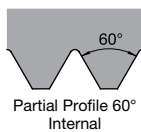
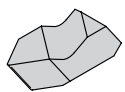

- first choice
- alternate choice

P	●	●	●	●
M	●	●	●	●
K	●	●	○	●
N	●	●	○	○
S	●	●	○	○
H	○	○	○	○

catalog number	RC		E		SSC	external thread pitch mm	internal thread pitch mm	external TPI	internal TPI	TN6010	TN6025	THM
	mm	in	mm	in								
NT1L	0,08	.003	1,09	.043	1	—	1,0-2,0	—	12-24	3636551	3636555	—

NOTE: SSC = To correspond with the SSC on the toolholder.

## Threading Inserts • NT

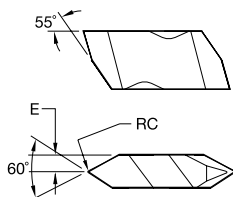
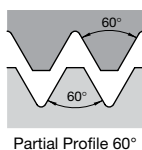
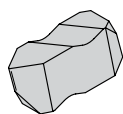

- first choice
- alternate choice

P	●	●	●	●
M	●	●	●	●
K	●	●	○	●
N	●	●	○	○
S	●	●	●	○
H	○	○	○	○

catalog number	RC		E		SSC	external thread pitch mm	internal thread pitch mm	external TPI	internal TPI	TN6010	TN6025	THM
	mm	in	mm	in								
<b>right hand</b>												
<b>NT2R</b>	0,10	.004	1,90	.075	2	0,70-3,0	1,25-3,5	8-36	7-20	3607647	3607843	●
<b>NT3R</b>	0,17	.007	2,49	.098	3	1,25-4,0	2,0-5,0	6-20	5-12	3607630	3607825	●
<b>NT4R</b>	0,17	.007	3,25	.128	4	1,25-6,25	2,0-6,25	4-20	4-12	3607676	3607834	●
<b>left hand</b>												
<b>NT2L</b>	0,10	.004	1,90	.075	2	0,70-3,0	1,25-3,5	8-36	7-20	3607675	3607835	●
<b>NT3L</b>	0,17	.007	2,49	.098	3	1,25-4,0	2,0-5,0	6-20	5-12	3607532	3607826	●
<b>NT4L</b>	0,17	.007	3,25	.128	4	1,25-6,25	2,0-6,25	4-20	4-12	3607649		●

NOTE: SSC = To correspond with the SSC on the toolholder.

INDEXABLE MILLING

SOLID END MILLING

HOLE/MAKING

TAPPING

TURNING

Threading Inserts • NTP

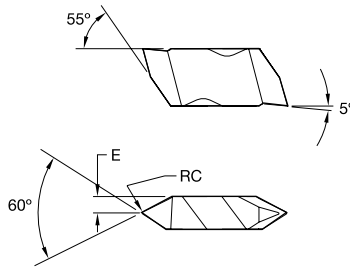
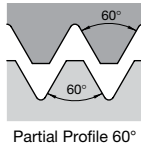
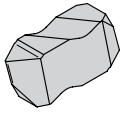

- first choice
- alternate choice

P	●	●	●	●
M	●	●	●	●
K	●	○	○	○
N	●	○	○	○
S	●	○	○	○
H	○	○	○	○

catalog number	RC		E		SSC	external thread pitch mm	internal thread pitch mm	external TPI	internal TPI	TNG610	TNG625	THM
	mm	in	mm	in								
<b>right hand</b>												
NTP2R	0,10	.004	1,91	.075	2	0,70-3,0	1,25-3,5	8-36	7-20	3607677	3607841	●
NTP3R	0,17	.007	2,49	.098	3	1,25-4,0	2,0-5,0	6-20	5-12	3607644	3607823	●
NTP4R	0,17	.007	3,25	.128	4	1,25-6,25	2,0-6,25	4-20	4-12	3607839	3607841	○
<b>left hand</b>												
NTP2L	0,10	.004	1,91	.075	2	0,70-3,0	1,25-3,5	8-36	7-20	3607678	3607840	●
NTP3L	0,17	.007	2,49	.098	3	1,25-4,0	2,0-5,0	6-20	5-12	3607650	3607831	○

NOTE: SSC = To correspond with the SSC on the toolholder.

INDEXABLE MILLING

SOLID END MILLING

HOLE/MAKING

TAPPING

TURNING

## Threading Inserts • NT-CK

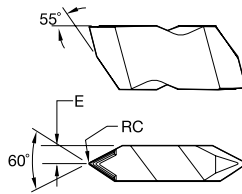
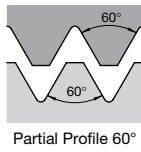
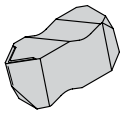

- first choice
- alternate choice

P	●	●	●	●
M	●	●	●	●
K	●	○	○	●
N	●	○	○	○
S	●	●	●	○
H	○	○	○	○

catalog number	RC		E		SSC	external thread pitch mm	internal thread pitch mm	external TPI	internal TPI	TN6010	TN6025	THM
	mm	in	mm	in								
<b>NT3RCK</b>	0,34	.014	2,46	.097	3	2,5-4,0	4,0	6-11	6		3607838	

NOTE: SSC = To correspond with the SSC on the toolholder.

## Threading Inserts • NTF

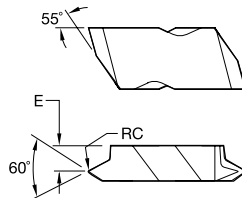
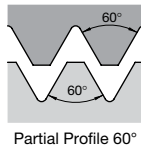
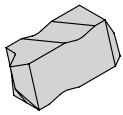

- first choice
- alternate choice

P	●	●	●	●
M	●	●	●	●
K	●	○	○	●
N	●	○	○	○
S	●	●	●	○
H	○	○	○	○

catalog number	RC		E		SSC	external thread pitch mm	internal thread pitch mm	external TPI	internal TPI	TN6010	TN6025	THM
	mm	in	mm	in								
<b>NTF2R</b>	0,08	.003	2,79	.110	2	0,60-1,75	1,0-2,0	14-44	12-24		3607673	
<b>NTF3R</b>	0,08	.003	3,58	.141	3	0,60-2,5	1,0-2,5	10-44	9-24		3607531	3607852
<b>NTF3L</b>	0,08	.003	3,58	.141	3	0,60-2,5	1,0-2,5	10-44	9-24		3607652	3607832

NOTE: SSC = To correspond with the SSC on the toolholder.

### Threading Inserts • NTK

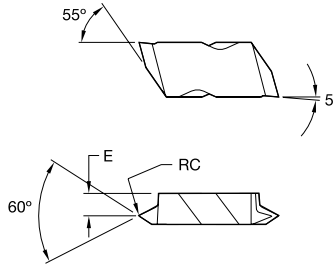
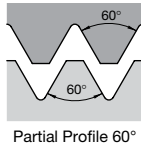
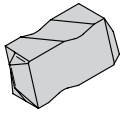

- first choice
- alternate choice

P	●	●	●	●
M	●	●	●	●
K	●	●	●	●
N	●	●	●	●
S	●	●	●	●
H	○	○	○	○

catalog number	RC		E		SSC	external thread pitch mm	internal thread pitch mm	external TPI	internal TPI	TN6010	TN6025	THM
	mm	in	mm	in						TN6010	TN6025	THM
<b>right hand</b>												
NTK2R	0,08	.003	2,79	.110	2	0,60-1,75	1,0-2,0	14-44	12-24	3607646	3607836	—
NTK3R	0,08	.003	3,58	.141	3	0,60-2,50	1,0-2,5	10-44	9-24	3607528	3607827	—
<b>left hand</b>												
NTK3L	0,08	.003	3,58	.141	3	0,60-2,50	1,0-2,5	10-44	9-24	—	3607853	—

NOTE: SSC = To correspond with the SSC on the toolholder.

INDEXABLE MILLING

SOLID END MILLING

HOLE/MAKING

TAPPING

TURNING

## Threading Inserts • NTC-E

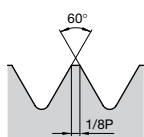
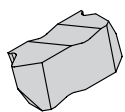

American UN-External

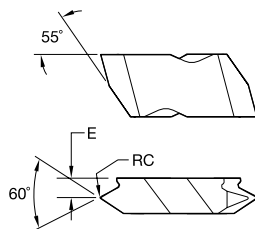

- first choice
- alternate choice

P	●	●	●	●
M	●	●	●	●
K	●	●	○	●
N	●	●	○	○
S	●	●	●	○
H	○	○	○	○

catalog number	RC		E		SSC	external thread pitch mm	internal thread pitch mm	external TPI	internal TPI	TN6010	TN6025	THM
	mm	in	mm	in								
<b>right hand</b>												
NTC3R16E	0,19	.008	3,76	.148	3	—	—	16	—	—	3636557	—
NTC3R14E	0,22	.009	3,76	.148	3	—	—	14	—	3636554	—	—
NTC3R12E	0,25	.010	3,76	.148	3	—	—	12	—	3636549	3636562	—

NOTE: SSC = To correspond with the SSC on the toolholder.

## Threading Inserts • NTC-I

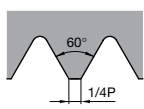
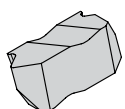

American UN-Internal

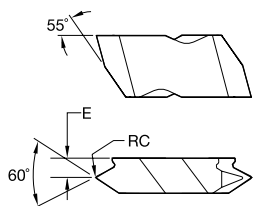

- first choice
- alternate choice

P	●	●	●	●
M	●	●	●	●
K	●	●	○	●
N	●	●	○	○
S	●	●	●	○
H	○	○	○	○

catalog number	RC		E		SSC	external thread pitch mm	internal thread pitch mm	external TPI	internal TPI	TN6010	TN6025	THM
	mm	in	mm	in								
<b>left hand</b>												
NTC3L12I	0,10	.004	3,76	.148	3	—	—	—	12	—	3636556	—

NOTE: SSC = To correspond with the SSC on the toolholder.

### Threading Inserts • NJP

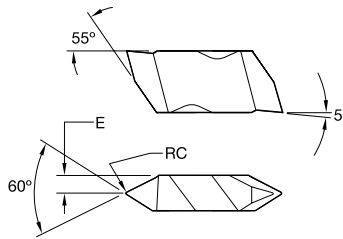
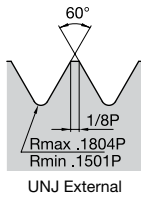
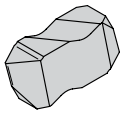

- first choice
- alternate choice

P	●	●	●	●
M	●	●	●	●
K	●	○	○	●
N	●	○	○	○
S	●	●	●	○
H	○	○	○	○

catalog number right hand	RC		E		SSC	external thread pitch mm	internal thread pitch mm	external TPI	internal TPI	TN6010	TN6025	THM
	mm	in	mm	in								
NJP3014R12	0,33	.013	2,49	.098	3	—	—	12	—	—	3607850	—

NOTE: SSC = To correspond with the SSC on the toolholder.

### Threading Inserts • NJK

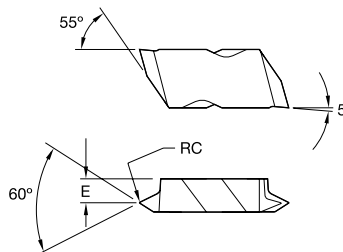
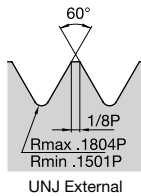
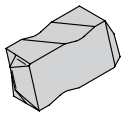

- first choice
- alternate choice

P	●	●	●	●
M	●	●	●	●
K	●	○	○	●
N	●	○	○	○
S	●	●	●	○
H	○	○	○	○

catalog number right hand	RC		E		SSC	external thread pitch mm	internal thread pitch mm	external TPI	internal TPI	TN6010	TN6025	THM
	mm	in	mm	in								
NJK3008R20	0,20	.008	3,58	.141	3	—	—	20	—	3607648	—	—

NOTE: SSC = To correspond with the SSC on the toolholder.



## Threading Inserts • NWC-E

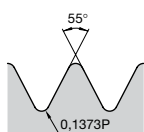
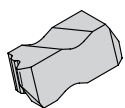

Whitworth BSW,  
BSP-External

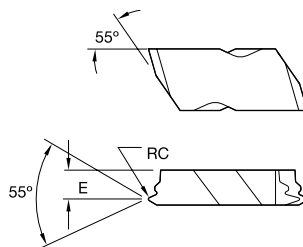

- first choice
- alternate choice

P	●	●	●	●
M	●	●	●	●
K	●	●	●	●
N	●	●	●	●
S	●	●	●	●
H	○	○	○	○

catalog number	RC		E		SSC	TPI	TPF	TN6010	TN6025	THM
	mm	in	mm	in						
<b>right hand</b>										
NWC3R14E	0,24	.009	3,43	.135	3	14	—	—	—	—
NWC3R11E	0,30	.012	3,43	.135	3	11	—	—	—	—

NOTE: SSC = To correspond with the SSC on the toolholder.

## Threading Inserts • NDC-RD

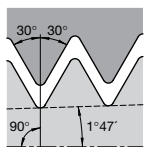
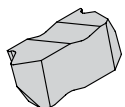

API Round

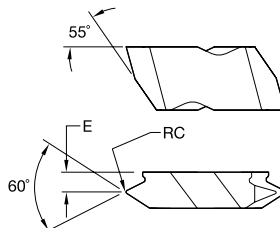

- first choice
- alternate choice

P	●	●	●	●
M	●	●	●	●
K	●	●	●	●
N	●	●	●	●
S	●	●	●	●
H	○	○	○	○

catalog number	RC		E		SSC	TPI	TPF	TN6010	TN6025	THM
	mm	in	mm	in						
<b>right hand</b>										
NDC38RDR75	0,43	.017	3,18	.125	3	8	.750	—	—	—
<b>left hand</b>										
NDC310RDL75	0,36	.014	3,18	.125	3	10	.750	—	—	—
NDC38RDL75	0,43	.017	3,18	.125	3	8	.750	—	—	—

NOTE: SSC = To correspond with the SSC on the toolholder.

Threading Inserts • NA

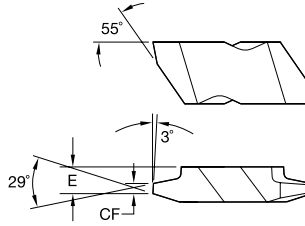
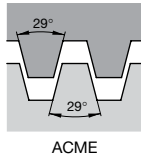
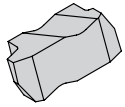

- first choice
- alternate choice

P	●	●	●	●
M	●	●	●	●
K	●	○	○	○
N	●	○	○	○
S	●	○	○	○
H	○	○	○	○

catalog number	CF		E		SSC	TPI	TN6010	TN6025	THM
	mm	in	mm	in					
<b>right hand</b>									
NA3R8	1,04	.041	3,79	.149	3	8	●	●	●
NA3R6	1,44	.057	3,79	.149	3	6	●	●	●
NA3R4	2,22	.088	3,38	.133	3	4	●	●	●
NA4R4	2,22	.088	5,13	.202	4	4	●	●	●
NA6R3	3,01	.118	7,19	.283	6	3	●	●	●
NA6R2	4,58	.180	7,19	.283	6	2	●	●	●
<b>left hand</b>									
NA3L8	1,04	.041	3,79	.149	3	8	●	●	●
NA3L6	1,44	.057	3,79	.149	3	6	●	●	●
NA3L4	2,22	.088	3,38	.133	3	4	●	●	●
NA4L4	2,22	.088	5,13	.202	4	4	●	●	●
NA6L3	3,01	.118	7,19	.283	6	3	●	●	●
NA6L2	4,58	.180	7,19	.283	6	2	●	●	●

NOTE: SSC = To correspond with the SSC on the toolholder.

INDEXABLE MILLING

SOLID END MILLING

HOLE/MAKING

TAPPING

TURNING

INDEXABLE MILLING

SOLID END MILLING

HOLEMAKING

TAPPING

TURNING

## Threading Inserts • NAS

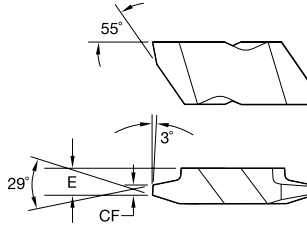
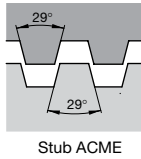
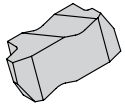

- first choice
- alternate choice

P	●	●	●	●
M	●	●	●	●
K	●	●	●	●
N	●	●	●	●
S	●	●	●	●
H	○	○	○	○

catalog number	CF		E		SSC	TPI	TN6010	TN6025	THM
	mm	in	mm	in					
<b>right hand</b>									
NAS3R8	1,21	.048	3,79	.149	3	8		3607856	
<b>left hand</b>									
NAS3L8	1,21	.048	3,79	.149	3	8		3607845	
NAS3L6	1,66	.065	3,79	.149	3	6		3607829	

NOTE: SSC = To correspond with the SSC on the toolholder.

## Threading Inserts • NTB-B

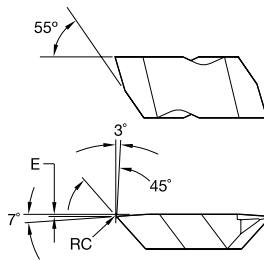
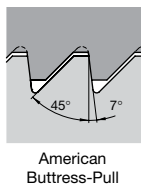
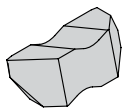

- first choice
- alternate choice

P	●	●	●	●
M	●	●	●	●
K	●	●	●	●
N	●	●	●	●
S	●	●	●	●
H	○	○	○	○

catalog number	RC		E		SSC	TPI	TPF	TN6010	TN6025	THM
	mm	in	mm	in						
<b>left hand</b>										
NTB3LB	0,17	.007	0,31	.012	3	8-16	—		3638563	

NOTE: SSC = To correspond with the SSC on the toolholder.

Threading Inserts • NTU

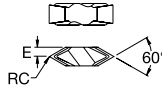
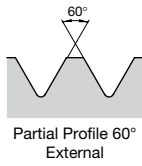
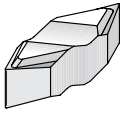

- first choice
- alternate choice

P	●	●	●	●
M	●	●	●	●
K	●	○	○	●
N	●	○	○	○
S	●	●	●	○
H	○	○	○	○

catalog number right hand	RC		E		SSC	external thread pitch mm	internal thread pitch mm	external TPI	internal TPI	TN6010	TN6025	THM
	mm	in	mm	in								
NTU4R	0,11	.005	3,18	.125	4U	1,25-6,25	—	4-20	—	—	—	—

NOTE: SSC = To correspond with the SSC on the toolholder.

INDEXABLE MILLING



SOLID END MILLING

HOLE/MAKING

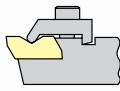
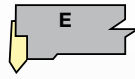
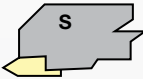
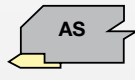
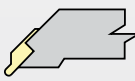
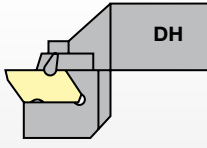

TAPPING

TURNING

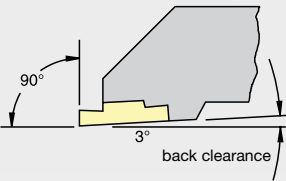
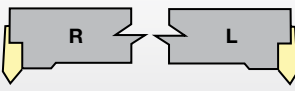
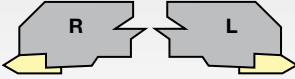
## TopThread • Catalog Numbering System

<b>N</b>	<b>S</b>	<b>R</b>	<b>16</b>	<b>3</b>	<b>D</b>														
Insert Holding Method	Insert Mounting Location	Hand of Tool	Drop Head	Shank Size	Qualified Surface and Length														
<p><b>N</b> – TopThread</p> 	<p>End mount</p>  <p>Side mount Offset</p>  <p>Side mount No offset for swiss machining</p>  <p>NRR undercut</p> 		<p><b>16</b></p> <p>Inch: For shanks 5/8" square and larger, the number represents the number of sixteenths of width and height. For shanks under 5/8" square, the number of sixteenths of cross section is preceded by a zero. For rectangular holders, the first digit represents the number of eighths of width and the second digit the number of quarters of height, except for a toolholder 1-1/4" x 1-1/2", which is given the number 91.</p> 	<p><b>3</b></p> <p>Insert Size</p>  <table border="1"> <thead> <tr> <th>insert size</th> <th>W1</th> </tr> </thead> <tbody> <tr> <td>2</td> <td>.150"</td> </tr> <tr> <td>3</td> <td>.195"</td> </tr> <tr> <td>4</td> <td>.255"</td> </tr> <tr> <td>5</td> <td>.380"</td> </tr> <tr> <td>6</td> <td>.383"</td> </tr> <tr> <td>8</td> <td>.438"</td> </tr> </tbody> </table>	insert size	W1	2	.150"	3	.195"	4	.255"	5	.380"	6	.383"	8	.438"	<p><b>D</b></p> <p>Qualified Surface and Length</p> <p><b>A</b> – Qualified back and end, 4" long</p> <p><b>B</b> – Qualified back and end, 4.5" long</p> <p><b>C</b> – Qualified back and end, 5" long</p> <p><b>D</b> – Qualified back and end, 6" long</p> <p><b>E</b> – Qualified back and end, 7" long</p>  <p>NOTE: Holders are designed to locate insert inclined to 3° to provide back clearance down open side.</p>
insert size	W1																		
2	.150"																		
3	.195"																		
4	.255"																		
5	.380"																		
6	.383"																		
8	.438"																		
	<p>End mount</p>  <p>Side mount</p> 																		

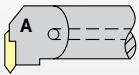
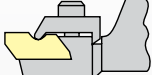
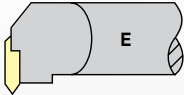
TopThread • Catalog Numbering System

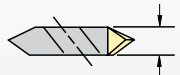
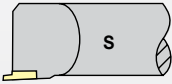
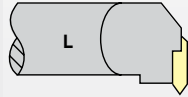
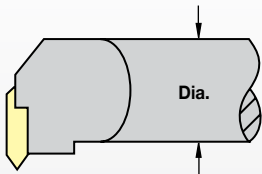
<p><b>A</b></p>	<p><b>32</b></p>	<p><b>N</b></p>	<p><b>E</b></p>	<p><b>R</b></p>	<p><b>3</b></p>																
<p>Bar Type</p>	<p>Bar Diameter</p>	<p>Insert Holding Method</p>	<p>Insert Location</p>	<p>Hand of Tool</p>	<p>Insert Size</p>																
<p>Steel with coolant</p>		<p>N – TopThread*</p>	<p>End mount</p>	<p>Right hand</p>	<p>W1</p>																
																					
		<p>*Proprietary standard only.</p>	<p>Side mount</p>	<p>Left hand</p>	<table border="1"> <thead> <tr> <th>insert size</th> <th>W1</th> </tr> </thead> <tbody> <tr> <td>1</td> <td>.100"</td> </tr> <tr> <td>2</td> <td>.150"</td> </tr> <tr> <td>3</td> <td>.195"</td> </tr> <tr> <td>4</td> <td>.255"</td> </tr> <tr> <td>5</td> <td>.380"</td> </tr> <tr> <td>6</td> <td>.383"</td> </tr> <tr> <td>8</td> <td>.438"</td> </tr> </tbody> </table>	insert size	W1	1	.100"	2	.150"	3	.195"	4	.255"	5	.380"	6	.383"	8	.438"
insert size	W1																				
1	.100"																				
2	.150"																				
3	.195"																				
4	.255"																				
5	.380"																				
6	.383"																				
8	.438"																				
<p>A two-digit number that indicates the bar diameter in 1/16" increments.</p>																					
																					

INDEXABLE MILLING

SOLID END MILLING

HOLE/MAKING

TAPPING

TURNING

Integral Toolholders • NS

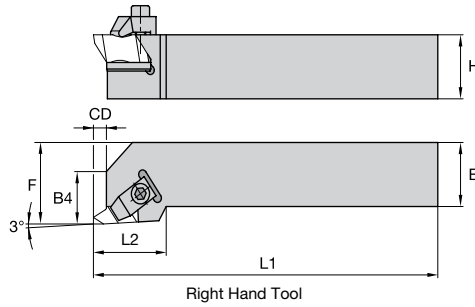
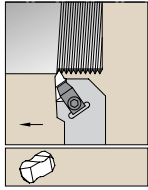

order number	catalog number	SSC	H	B	F	L1	L2	B4	CD	gage insert
<b>right hand</b>										
3632147	NSR062	2	.375	.375	.562	2.50	.75	.35	.138	N.2R
3641660	NSR1212F2	2	.472	.474	.630	3.15	.75	.35	.138	N.2R
3639035	NSR082V	2	.500	.500	.750	3.50	.75	.35	.138	N.2R
3636542	NSR1616H2	2	.630	.630	.787	3.94	.75	.35	.138	N.2R
3639026	NSR122B	2	.750	.750	1.000	4.50	.75	.35	.138	N.2R
3638589	NSR2020K2	2	.787	.787	.984	4.92	.75	.35	.138	N.2R
3638590	NSR2525M2	2	.984	.984	1.260	5.91	.75	.35	.138	N.2R
3639025	NSR162C	2	1.000	1.000	1.250	5.00	.75	.35	.138	N.2R
3639027	NSR123A	3	.750	.750	1.000	4.00	1.25	.50	.210	N.3R
3639023	NSR123B	3	.750	.750	1.000	4.50	1.25	.50	.210	N.3R
3638588	NSR2020K3	3	.787	.787	.984	4.92	1.26	.50	.210	N.3R
3636536	NSR2525M3	3	.984	.984	1.260	5.91	1.26	.50	.210	N.3R
3638592	NSR163C	3	1.000	1.000	1.250	5.00	1.25	.50	.210	N.3R
3638591	NSR163D	3	1.000	1.000	1.250	6.00	1.25	.50	.210	N.3R
3639028	NSR203D	3	1.250	1.250	1.500	6.00	1.25	.50	.210	N.3R
3641666	NSR3232P3	3	1.260	1.260	1.575	6.69	1.26	.50	.210	N.3R
3636540	NSR2525M4	4	.984	.984	1.260	5.91	1.38	.54	.294	N.4R
3641669	NSR3232P4	4	1.260	1.260	1.575	6.69	1.38	.54	.294	N.4R
<b>left hand</b>										
3632145	NSL122B	2	.750	.750	1.000	4.50	.75	.35	.138	N.2L
3639045	NSL2020K2	2	.787	.787	.984	4.92	.75	.35	.138	N.2L
3639047	NSL2525M2	2	.984	.984	1.260	5.91	.75	.35	.138	N.2L
3632138	NSL162C	2	1.000	1.000	1.250	5.00	.75	.35	.138	N.2L
3632152	NSL123A	3	.750	.750	1.000	4.00	1.25	.50	.210	N.3L
3639032	NSL123B	3	.750	.750	1.000	4.50	1.25	.50	.210	N.3L
3639046	NSL2020K3	3	.787	.787	1.260	4.92	1.26	.50	.210	N.3L
3636539	NSL2525M3	3	.984	.984	1.260	5.91	1.26	.50	.210	N.3L
3639029	NSL163C	3	1.000	1.000	1.250	5.00	1.25	.50	.210	N.3L
3639024	NSL163D	3	1.000	1.000	1.250	6.00	1.25	.50	.210	N.3L
3639037	NSL203D	3	1.250	1.250	1.500	6.00	1.25	.50	.210	N.3L
3636544	NSL2525M4	4	.984	.984	1.260	5.91	1.38	.54	.294	N.4L

NOTE: F dimension measured over sharp point of insert.  
SSC = To correspond with the SSC on the insert.

Integral Toolholders • NS • with Shim

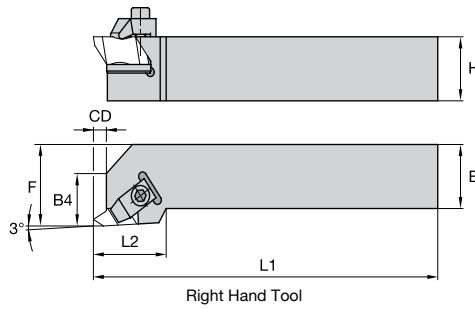
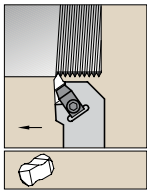

order number	catalog number	SSC	H	B	F	L1	L2	B4	CD	gage insert
<b>right hand</b>										
3639031	NSR164C	2	1.000	1.000	1.250	5.00	1.38	.54	.294	N.4R
3639033	NSR164D	2	1.000	1.000	1.250	6.00	1.38	.54	.294	N.4R
3632153	NSR166D	3	1.000	1.000	1.250	6.00	1.38	.67	.334	N.6R
3637472	NSR206D	3	1.250	1.250	1.500	6.00	1.38	.67	.334	N.6R
3637539	NSR168D	4	1.000	1.000	1.250	6.00	1.25	.72	.225	N.8R
3637526	NSR854D	4	1.250	1.000	1.250	6.00	1.38	.54	.294	N.4R
<b>left hand</b>										
3639036	NSL204D	1	1.250	1.250	1.500	6.00	1.38	.54	.294	N.4L
3639040	NSL164D	6	1.000	1.000	1.250	6.00	1.38	.54	.294	N.4L

NOTE: F dimension measured over sharp point of insert.  
SSC = To correspond with the SSC on the insert.

Integral Toolholders • NAS

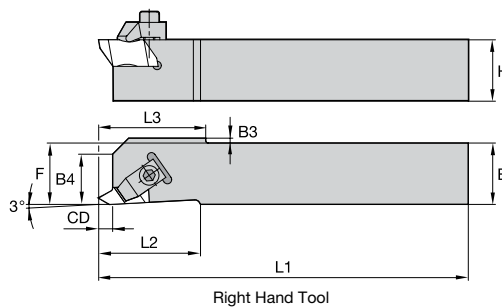
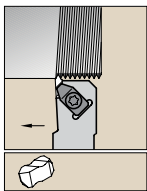

order number	catalog number	SSC	H	B	F	L1	L2	B4	CD	B3	L3	gage insert
<b>right hand</b>												
3636529	NASR082D	2	.500	.500	.500	6.00	.75	.35	.138	—	—	N.2R
3639039	NASR102B	2	.625	.625	.625	4.50	.75	.35	.138	—	—	N.2R
3639042	NASR083D	3	.500	.500	.500	6.00	1.25	.50	.210	.125	1.32	N.3R
3636532	NASR103B	3	.625	.625	.625	4.50	1.25	—	.210	—	—	N.3R
<b>left hand</b>												
3636534	NASL082D	2	.500	.500	.500	6.00	.75	.35	.138	—	—	N.2L
3636524	NASL103B	3	.625	.625	.625	4.50	1.25	—	.210	—	—	N.3L

NOTE: F dimension measured over sharp point of insert.  
SSC = To correspond with the SSC on the insert.

INDEXABLE MILLING

SOLID END MILLING

HOLEMAKING

TAPPING

TURNING



## Integral Toolholders • NS-DH

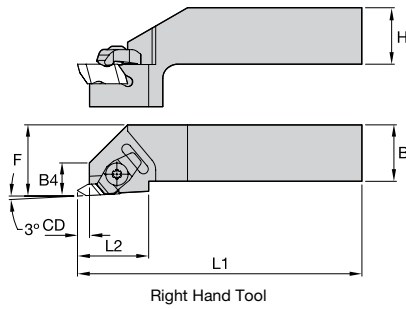
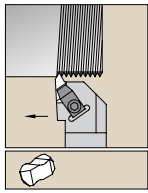

Right Hand Tool

order number	catalog number	SSC	H	B	F	L1	L2	B4	CD	gage insert
<b>right hand</b>										
3637528	NSRDH163D	3	1.000	1.000	1.250	6.00	1.25	.58	.210	N.3R

NOTE: F dimension measured over sharp point of insert.  
SSC = To correspond with the SSC on the insert.

## Integral Toolholders • NE

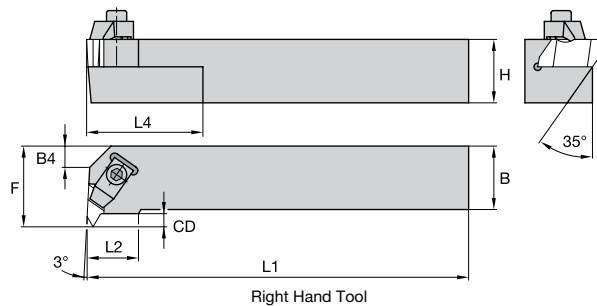
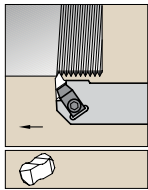

Right Hand Tool

order number	catalog number	SSC	H	B	F	L1	L2	L4	B4	CD	gage insert
<b>right hand</b>											
3637486	NER162C	2	1.000	1.000	1.250	5.00	.50	1.00	.41	.138	N.2L
3632133	NER123B	3	.750	.750	1.125	4.50	.75	2.00	—	.210	N.3L
3639038	NER163C	3	1.000	1.000	1.250	5.00	.75	2.00	—	.210	N.3L
3639030	NER163D	3	1.000	1.000	1.250	6.00	.75	2.00	—	.210	N.3L
3639043	NER164D	4	1.000	1.000	1.375	6.00	.75	2.00	—	.294	N.4L
3637522	NER244D	4	1.500	1.500	2.000	6.00	.75	2.00	.65	.294	N.4L
<b>left hand</b>											
3637503	NEL122B	2	.750	.750	1.000	4.50	.50	1.00	.29	.138	N.2R
3637500	NEL162C	2	1.000	1.000	1.250	5.00	.50	1.00	.41	.138	N.2R
3632155	NEL163C	3	1.000	1.000	1.250	5.00	.75	2.00	—	.210	N.3R
3639041	NEL163D	3	1.000	1.000	1.250	6.00	.75	2.00	—	.210	N.3R
3632159	NEL204D	4	1.250	1.250	1.625	6.00	.75	2.00	.27	.294	N.4R

NOTE: F dimension measured over sharp point of insert.  
SSC = To correspond with the SSC on the insert.

Cutting Units • KM40TS • Steel • NE90° • Metric

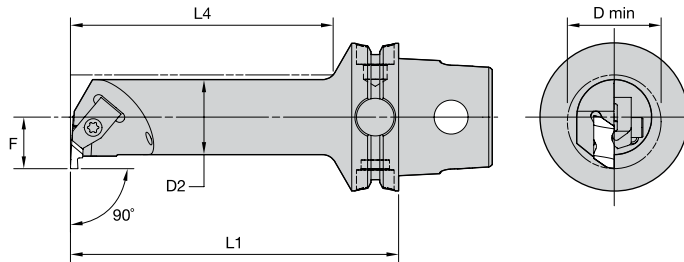

order number	catalog number	D2		D min		F		L4		L1		gage insert	kg	lbs
		mm	in	mm	in	mm	in	mm	in	mm	in			
<b>right hand</b>														
3955481	KM40TSS12ENER2	12	.472	19	.73	11	.433	42	1.65	70	2.756	NG2L	0,27	.58
3955483	KM40TSS16FNER2	16	.630	20	.79	11	.433	56	2.21	80	3.150	NG2L	0,28	.62
3955485	KM40TSS20GNER2	20	.787	25	.98	13	.512	70	2.76	90	3.543	NG2L	0,35	.76
3955487	KM40TSS25ENER2	25	.984	32	1.26	17	.669	55	2.17	70	2.756	NG2L	0,34	.75
3955491	KM40TSS25ENER3	25	.984	34	1.34	17	.669	55	2.17	70	2.756	NG3L	0,35	.77
3955489	KM40TSS25HNER2	25	.984	32	1.26	17	.669	75	2.95	100	3.937	NG2L	0,49	1.08
3955493	KM40TSS25HNER3	25	.984	34	1.34	17	.669	75	2.95	100	3.937	NG3L	0,49	1.09
3955497	KM40TSS32GNER3	32	1.260	40	1.57	22	.866	76	2.99	90	3.543	NG3L	0,55	1.21
3955495	KM40TSS32JNER3	32	1.260	40	1.57	22	.866	96	3.78	110	4.331	NG3L	0,67	1.48
<b>left hand</b>														
3955480	KM40TSS12ENEL2	12	.472	19	.73	11	.433	42	1.65	70	2.756	NG2R	0,27	.59
3955482	KM40TSS16FNEL2	16	.630	20	.79	11	.433	56	2.21	80	3.150	NG2R	0,28	.62
3955484	KM40TSS20GNEL2	20	.787	25	.98	13	.512	70	2.76	90	3.543	NG2R	0,35	.76
3955486	KM40TSS25ENEL2	25	.984	32	1.26	17	.669	55	2.17	70	2.756	NG2R	0,34	.75
3955490	KM40TSS25ENEL3	25	.984	34	1.34	17	.669	55	2.17	70	2.756	NG3R	0,35	.77
3955488	KM40TSS25HNEL2	25	.984	32	1.26	17	.669	75	2.95	100	3.937	NG2R	0,49	1.08
3955492	KM40TSS25HNEL3	25	.984	34	1.34	17	.669	75	2.95	100	3.937	NG3R	0,49	1.09
3955496	KM40TSS32GNEL3	32	1.260	40	1.57	22	.866	76	2.99	90	3.543	NG3R	0,55	1.21
3955494	KM40TSS32JNEL3	32	1.260	40	1.57	22	.866	96	3.78	110	4.331	NG3R	0,67	1.48

INDEXABLE MILLING

SOLID END MILLING

HOLEMAKING

TAPPING

TURNING

## Integral Toolholders • NS

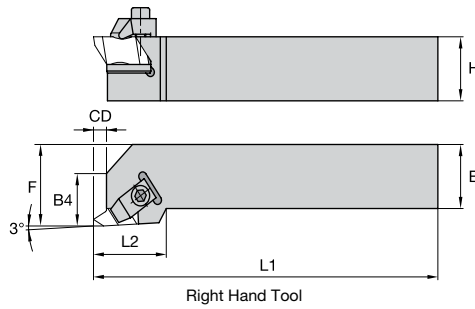
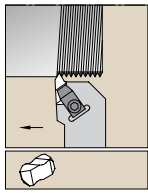

order number	catalog number	SSC	H	B	F	L1	L2	B4	CD	gage insert
<b>right hand</b>										
3632147	NSR062	2	10	10	14	64	19	9	3,5	N.2R
3639035	NSR082V	2	13	13	19	89	19	9	3,5	N.2R
3639026	NSR122B	2	19	19	25	114	19	9	3,5	N.2R
3639025	NSR162C	2	25	25	32	127	19	9	3,5	N.2R
3639027	NSR123A	3	19	19	25	102	32	13	5,3	N.3R
3639023	NSR123B	3	19	19	25	114	32	13	5,3	N.3R
3638592	NSR163C	3	25	25	32	127	32	13	5,3	N.3R
3638591	NSR163D	3	25	25	32	152	32	13	5,3	N.3R
3639028	NSR203D	3	32	32	38	152	32	13	5,3	N.3R
<b>left hand</b>										
3632145	NSL122B	2	19	19	25	114	19	9	3,5	N.2L
3632138	NSL162C	2	25	25	32	127	19	9	3,5	N.2L
3632152	NSL123A	3	19	19	25	102	32	13	5,3	N.3L
3639032	NSL123B	3	19	19	25	114	32	13	5,3	N.3L
3639029	NSL163C	3	25	25	32	127	32	13	5,3	N.3L
3639024	NSL163D	3	25	25	32	152	32	13	5,3	N.3L
3639037	NSL203D	3	32	32	38	152	32	13	5,3	N.3L

NOTE: F dimension measured over sharp point of insert.  
SSC = To correspond with the SSC on the insert.

## Cutting Units • KM40TS • Carbide • NE90° • Metric

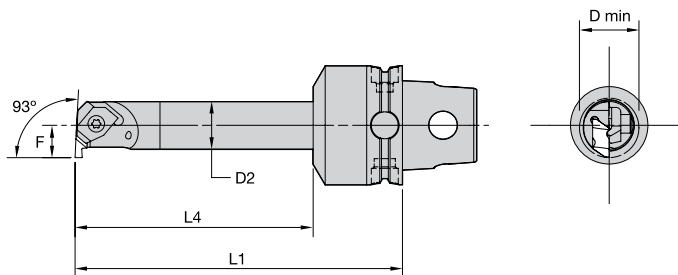
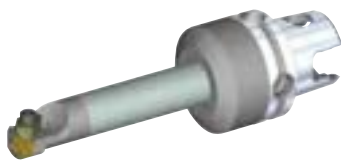

order number	catalog number	D2		D min		F		L4		L1		gage insert	kg	lbs
		mm	in	mm	in	mm	in	mm	in	mm	in			
<b>right hand</b>														
3951836	KM40TSE16JNER2	16	.630	20	.79	11	.433	80	3.15	110	4.331	NG2L	0,41	.90
<b>left hand</b>														
3951835	KM40TSE16JNEL2	16	.630	20	.79	11	.433	80	3.15	110	4.331	NG2R	0,41	.90

Integral I.D. Threading Boring Bars • A-NE

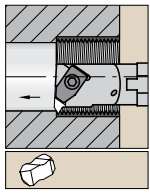

Steel shank with through coolant.

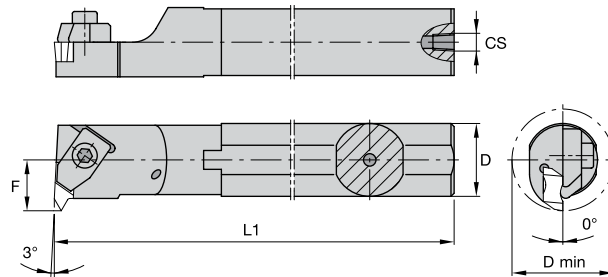

Right Hand Tool

order number	catalog number	SSC	D	D min	F	L1	CS	gage insert
<b>right hand</b>								
3632117	A08NER2	2	.500	.730	.437	8	1/16-27 NPT	N.2L
3632114	A10SNER2	2	.625	1.000	.500	10	1/8-27 NPT	N.2L
3632118	A12SNER2	2	.750	1.125	.562	10	1/8-27 NPT	N.2L
3632130	A16TNER2	2	1.000	1.375	.688	12	1/4-18 NPT	N.2L
3632113	A16NER3	3	1.000	1.375	.688	12	1/4-18 NPT	N.3L
3632116	A20NER3	3	1.250	1.750	.875	14	1/4-18 NPT	N.3L
3632115	A24NER3	3	1.500	2.000	1.000	14	1/4-18 NPT	N.3L
3632122	A32NER3	3	2.000	2.500	1.250	16	1/4-18 NPT	N.3L
3632123	A28NER4	4	1.750	2.500	1.250	14	1/4-18 NPT	N.4L
<b>left hand</b>								
3632131	A08NEL2	2	.500	.730	.437	8	1/16-27 NPT	N.2R
3632127	A10SNEL2	2	.625	1.000	.500	10	1/8-27 NPT	N.2R
3632126	A12SNEL2	2	.750	1.125	.562	10	1/8-27 NPT	N.2R
3632142	A16NEL2	2	1.000	1.375	.688	12	1/4-18 NPT	N.2R
3632120	A16NEL3	3	1.000	1.375	.688	12	1/4-18 NPT	N.3R
3632124	A20NEL3	3	1.250	1.750	.875	14	1/4-18 NPT	N.3R
3632128	A24NEL3	3	1.500	2.000	1.000	14	1/4-18 NPT	N.3R
3632141	A28NEL4	4	1.750	2.500	1.250	14	1/4-18 NPT	N.4R
3632149	A32NEL4	4	2.000	2.750	1.375	16	1/4-18 NPT	N.4R

NOTE: F dimension measured over sharp point of insert.  
SSC = To correspond with the SSC on the insert.

Integral I.D. Threading Boring Bars • A-NE-1

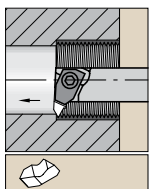

Necked steel shank with through coolant.

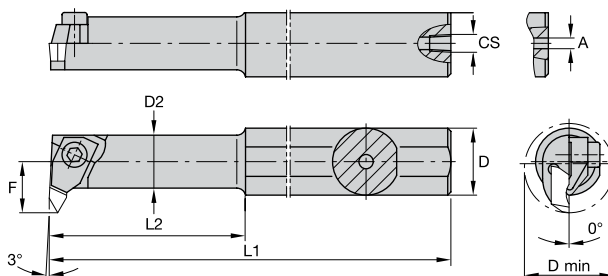

Right Hand Tool

order number	catalog number	SSC	D	D min	D2	L1	L2	F	A	CS	gage insert
<b>right hand</b>											
3632121	A06NER1	1	.375	.440	.312	6	1	.258	.125	—	N.1L
3632119	A08NER1	1	.500	.440	.310	8	1	.258	.094	1/16-27 NPT	N.1L

NOTE: F dimension measured over sharp point of insert.  
SSC = To correspond with the SSC on the insert.

# Laydown Threading

## External and Internal Threading

The Laydown Threading System offers an extensive range of inserts and toolholders, the ideal for all of threading requirements.

- Four insert sizes available to cover a wide range of thread-making operations.
- Ideal for high-helix/multi-start threads and single-point threading in small-diameter bores.
- Maximized tool life and low-profile design for unhindered chip flow and superior performance.
- Precision ground inserts to provide accurate thread forms and indexing.
- TN6025™ premium PVD TiAlN-coated grade outperforms conventional PVD grades.
- Partial- and full-profile insert options available for all common thread forms.



## LAYDOWN THREADING

### RELIABLE

With the WIDIA™ Laydown Threading System, you experience reliable countersunk screw locking for unhindered chip flow and precise insert positioning accuracy.

### PRODUCTIVE

Laydown insert technology, with its wide range of available tools and inserts, guarantees increased tool life, minimized built-up edges, and precise cuts of most common materials.

# EXTERNAL AND INTERNAL THREADING

## INSERTS

FIRST CHOICE	INSERT STYLE	SPEED SELECTION — M/MIN	MATERIALS
TN6025	 Precision ground	40–200 (130–650)	<b>P</b>
		40–135 (130–450)	<b>M</b>
		60–145 (200–475)	<b>K</b>
		50–360 (160–1150)	<b>N</b>
		10–100 (35–330)	<b>S</b>

## APPLICATIONS



THREADING



I.D. INTERNAL  
THREADING

## INDUSTRY



## Insert Selection Guide

### Step 1 • Select Threading Method and Hand of Tooling

**Required Information:**

- External/internal operation.
- Spindle rotation/hand of thread.
- Feed direction.



**Feed direction toward the chuck • standard helix • RECOMMENDED**

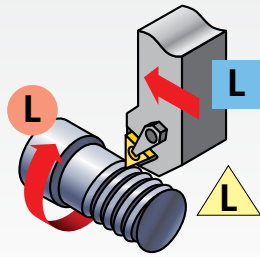

external left-hand thread

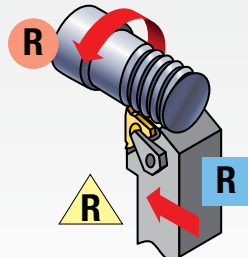

external right-hand thread

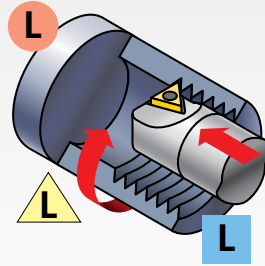

internal left-hand thread

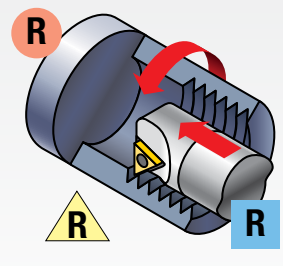

internal right-hand thread

**Feed direction away from the chuck • reverse helix\***

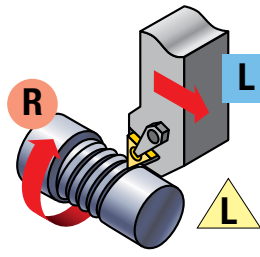

external right-hand thread

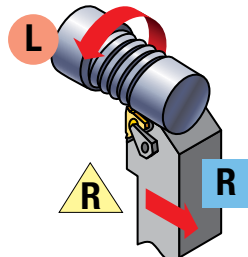

external left-hand thread

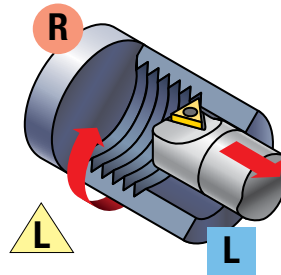

internal right-hand thread

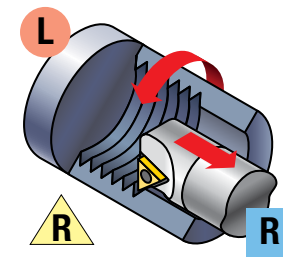

internal left-hand thread

\*Negative shim required

### Step 2 • Select Holder from Catalog Page

**Required Information:**

- External/internal operation.
- Minimum bore diameter (for internal operations).
- Hand of tool.
- Insert size (gage insert).

Select the appropriate holder for the insert size and hand:

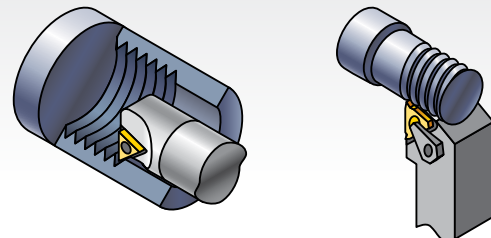

The insert size must match the gage insert size of your toolholder selection:

catalog number	gage insert	minimum bore diameter	shim
S0812LSER2	2IRA60	.650"	—
S2020LSER3	3IR...	1.45"	SM-Y13

## Insert Selection Guide

### Step 3 • Choose Insert for Application

- Select cresting inserts for fully controlled thread form including diameter.
- Cresting inserts eliminate the need for deburring and are optimized for the best tool life at that pitch.
- Non-cresting partial profile inserts offer the flexibility to cut a variety of thread pitches with one insert.
- Note insert size for toolholder selection.

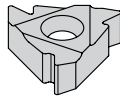
	insert size	catalog number	TN6025
	11	2IRA60	•
	16	3IRAG60	•

See threading insert overview on page E444.

### Step 4 • Select Appropriate Shim

#### Required Information:

- Thread form (TPI or pitch).
- Pitch diameter.
- Helix method (hand of tool, feed direction, hand of thread).
- Number of starts.

Select the proper shim: SMYE... for external RH or internal LH  
SMYI... for internal RH or external LH

**RH thread/RH tooling**      **LH thread/LH tooling**

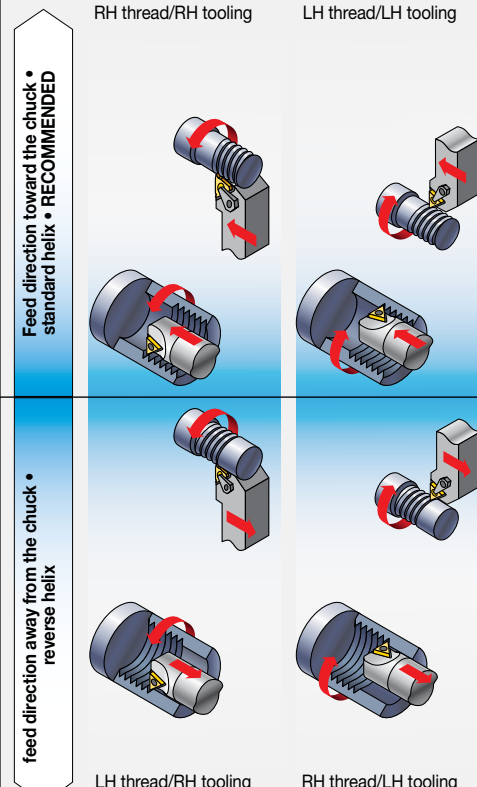

**LH thread/RH tooling**      **RH thread/LH tooling**

**Feed direction toward the chuck • standard helix • RECOMMENDED**

**Feed direction away from the chuck • reverse helix**

insert size	toolholder				shim ordering code (pitch)			
	external	internal	SM-YE-CP	SM-YE-CP	SM-YE-CP	SM-YE-CP	SM-YE-CP	SM-YE-CP
11	SM-YE-CP	SM-YE-CP	SM-YE-CP	SM-YE-CP	SM-YE-CP	SM-YE-CP	SM-YE-CP	SM-YE-CP
16	SM-YE-CP	SM-YE-CP	SM-YE-CP	SM-YE-CP	SM-YE-CP	SM-YE-CP	SM-YE-CP	SM-YE-CP

If recommended shim is different from shim supplied with toolholder, order shim separately.

NOTE: Optimize your threading operation by using the proper infeed angle and the recommended infeed values. See the Technical Section on pages E506–E507. Also see detailed shim selection information on pages E519–E520.

### Step 5 • Select Grade and Speed

Recommendations for Grade and Speed Selection — m/min (SFM)

workpiece material	steel	stainless steel	cast iron	non-ferrous metals	high-temp alloys
insert style	 precision ground				
first choice	TN6025 40–200 (130–650)	TN6025 40–135 (130–450)	TN6025 60–145 (200–475)	TN6025 50–360 (160–1150)	TN6025 10–100 (35–330)

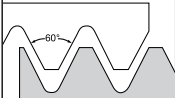
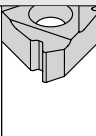
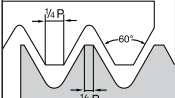
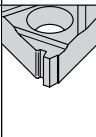
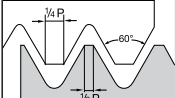
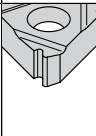
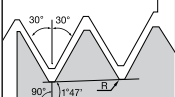
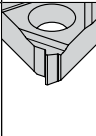
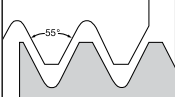
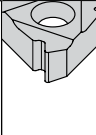
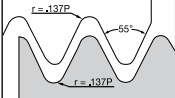
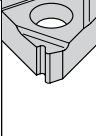
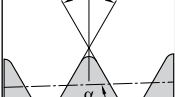
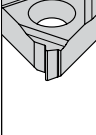
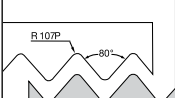
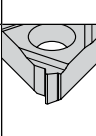
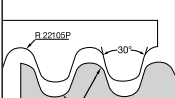
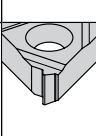
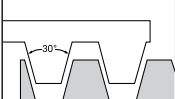
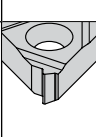

## Insert Overview

style		thread profile	standard	tolerance class	cresting	application	page(s)	
	flat top							
	60		Partial profile 60°	—	—	N	General use for 60° thread forms, such as ISO and UN, where non-cresting inserts are desired to cut a variety of pitches.	E477–E478
	ISO		Metric ISO	ISO R262, DIN 13	6g/6H	Y	Widely used metric 60° V-form for all industries.	E479–E482
	UN		American UN	ANSI B1.1:74	2A/2B	Y	Widely used inch-based 60° V-form for all industries.	E483–E484
	NPT		NPT	ANSI/ASME B1.20.1S1983	Standard NPT	N	National Pipe Thread standard 60° thread form for pipe fittings.	E485
	55		Partial profile 55°	—	—	N	General use for 55° thread forms such as Whitworth, BSW, and BSP where non-cresting inserts are desired to cut a variety of pitches.	E486–E487
	W		Whitworth, BSW, BSF, BSP	BS 84:1956, ISO 228/1:1982, DIN 259	Medium Class A	Y	Widely used 55° form for gas and water connections.	E488–E489
	API-RD		API round	API STD. 5B:1979	Standard API RD	Y	60° V-form with large radius for casing, tubing, and line pipe in the oil and gas industry, including 8 and 10 round forms.	custom solution
	PG		PG	DIN 404B0		Y	80° steel conduit thread.	custom solution
	RD		Round	DIN 405	7e/7H	Y	Round thread form for tube fittings in the chemical and food industries.	E489–E490
	TR		Trapez	DIN 103	7e/7H	N	30° truncated metric thread form for motion applications.	E491–E492

INDEXABLE MILLING

SOLID END MILLING

HOLEMAKING

TAPPING

TURNING

## Grades and Grade Descriptions

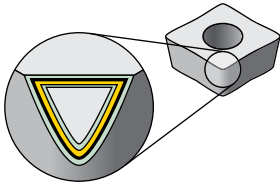

Coatings provide high-speed capability and are engineered for finishing to heavy roughing.

- Reduce cycle times — high speed capability.
- Longer tool life — new multilayer coating provides better wear resistance.

P	Steel
M	Stainless Steel
K	Cast Iron
N	Non-Ferrous
S	High-Temp Alloys
H	Hardened Materials

wear resistance ← → toughness

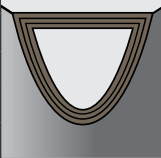
Grade	Coating	Grade Description	Performance Matrix													
				05	10	15	20	25	30	35	40	45				
TN6025	 HC-P25	PVD-TiAlN nano-multilayer coated carbide. General-purpose machining for steels, stainless steels, cast irons, non-ferrous materials, and difficult-to-machine materials. Recommended at low to medium cutting speeds when higher toughness is required.	P													
			M													
			K													
			N													
			S													

### Laydown Threading Thread Form Guide

- All Laydown Threading inserts are precision ground to provide accurate thread forms and indexing.
- Both cresting and non-cresting partial profile inserts are specifically designed for either external or internal threading operations.
- Cresting inserts provide a fully controlled thread form, including major, minor, root, and crest for a given pitch. The need for deburring is eliminated and the inserts are optimized for the best tool life at that pitch.
- Non-cresting partial profile inserts offer the flexibility to cut a variety of thread pitches with one insert.
- Right-hand Laydown Threading toolholders use right-hand inserts. Left-hand Laydown Threading toolholders use left-hand inserts.
- Right-hand Laydown Threading boring bars use right-hand inserts. Left-hand Laydown Threading boring bars use left-hand inserts.

## Catalog Numbering System

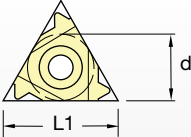
3	E	R	A	ISO															
Insert Size	Insert Type	Hand of Insert	Thread Pitch	Thread Profile	Number of Teeth														
	<p><b>E</b> – External thread</p> <p><b>I</b> – Internal thread</p>	<p><b>R</b> – Right-hand thread</p> <p><b>L</b> – Left-hand thread</p>			<p>Single tooth profile – No symbol</p> <p>Multi-tooth profile – Number of teeth (cutting edge and symbol)</p> <p>Multi-tooth profile with two teeth – 2M</p>														
					<p><b>55</b> Partial Profile 55°</p> <p><b>60</b> Partial Profile 60°</p> <p><b>ISO</b> ISO Metric 60°</p> <p><b>TR</b> Trapez DIN 103°</p> <p><b>UN</b> ISO Inch/American UN 60°</p> <p><b>W</b> Whitworth 55°</p> <p><b>NPT</b> American National Pipe Thread 60°</p> <p><b>RD</b> Round</p> <p><b>PG</b> Steel Conduit</p> <p><b>APIRD</b> API Round</p>														
		Partial profile inserts																	
		<table border="1"> <thead> <tr> <th>symbol</th> <th>mm</th> </tr> </thead> <tbody> <tr> <td>A</td> <td>0,5–1,5</td> </tr> <tr> <td>AG</td> <td>0,5–3,0</td> </tr> <tr> <td>G</td> <td>1,7–3,0</td> </tr> <tr> <td>N</td> <td>3,5–5,0</td> </tr> <tr> <td>Q</td> <td>5,5–6,0</td> </tr> </tbody> </table>	symbol	mm	A	0,5–1,5	AG	0,5–3,0	G	1,7–3,0	N	3,5–5,0	Q	5,5–6,0					
symbol	mm																		
A	0,5–1,5																		
AG	0,5–3,0																		
G	1,7–3,0																		
N	3,5–5,0																		
Q	5,5–6,0																		
		Full profile inserts																	
		<table border="1"> <thead> <tr> <th>symbol</th> <th>mm</th> </tr> </thead> <tbody> <tr> <td>Actual TPI</td> <td>0,5–0,4</td> </tr> </tbody> </table>	symbol	mm	Actual TPI	0,5–0,4													
symbol	mm																		
Actual TPI	0,5–0,4																		
																			
	<table border="1"> <thead> <tr> <th>symbol</th> <th>d</th> <th>L1</th> </tr> </thead> <tbody> <tr> <td>2</td> <td>0.250</td> <td>11</td> </tr> <tr> <td>3</td> <td>0.375</td> <td>16</td> </tr> <tr> <td>4</td> <td>0.500</td> <td>22</td> </tr> <tr> <td>5</td> <td>0.625</td> <td>27</td> </tr> </tbody> </table>	symbol	d	L1	2	0.250	11	3	0.375	16	4	0.500	22	5	0.625	27			
symbol	d	L1																	
2	0.250	11																	
3	0.375	16																	
4	0.500	22																	
5	0.625	27																	

## Recommended Cutting Speeds • Metric

		Cutting Speed – vc m/min		
		TN6025		
Material Group		min	Start	max
P	0/1	130	140	150
	2	110	145	175
	3	110	145	175
	4	75	95	115
	5	100	125	145
	6	40	55	65
M	1	60	75	90
	2	40	50	55
	3	40	50	60
K	1	60	80	90
	2	60	75	85
	3	60	75	90
N	1	600	750	900
	2	535	685	835
	3	230	300	370
	4	135	180	225
	5	70	90	110
	6	445	565	690
	7	550	700	850
S	1	25	35	40
	2	15	20	20
	3	40	60	70
	4	20	30	35

INDEXABLE MILLING

SOLID END MILLING

HOLE/MAKING

TAPPING

TURNING

## Recommended Cutting Speeds • Inch

Material Group		Cutting Speed – vc SFM		
		TN6025		
		min	Start	max
P	0/1	425	455	490
	2	360	465	575
	3	360	465	575
	4	235	300	365
	5	325	400	475
	6	130	180	210
M	1	195	245	295
	2	130	160	180
	3	130	165	195
K	1	195	255	295
	2	195	240	280
	3	195	245	295
N	1	1965	2460	2950
	2	1750	2240	2730
	3	750	980	1210
	4	445	590	730
	5	230	295	360
	6	1450	1855	2260
	7	1805	2295	2785
S	1	75	110	130
	2	40	55	65
	3	135	195	235
	4	65	95	115

INDEXABLE MILLING

SOLID END MILLING

HOLEMAKING

TAPPING

TURNING

Threading Inserts • ER/L-60

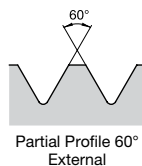
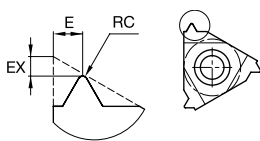
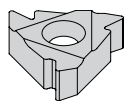

- first choice
- alternate choice

P	●
M	●
K	○
N	○
S	●
H	○

catalog number	RC		EX		E		SSC	thread pitch mm	TPI	TPF	TN6025
	mm	in	mm	in	mm	in					
<b>right hand</b>											
<b>3ERA60</b>	0,05	.002	0,8	.031	0,9	.035	3	0,50-1,50	16-48	—	2018214
<b>2ERA60</b>	0,05	.002	0,9	.035	0,8	.032	2	0,50-1,50	16-48	—	2007404
<b>3ERAG60</b>	0,08	.003	1,2	.047	1,7	.067	3	0,50-3,0	8-48	—	2018246
<b>3ERG60</b>	0,28	.011	1,2	.047	1,7	.067	3	1,75-3,0	8-14	—	2018222
<b>4ERN60</b>	0,53	.021	1,7	.067	2,5	.098	4	3,5-5,0	5-7	—	2018252
<b>left hand</b>											
<b>3ELAG60</b>	0,08	.003	1,2	.047	1,7	.067	3	0,50-3,0	8-48	—	2071904

NOTE: SSC = To correspond with the SSC on the toolholder.

INDEXABLE MILLING

SOLID END MILLING

HOLE/MAKING

TAPPING

TURNING

## Threading Inserts • IR/L-60

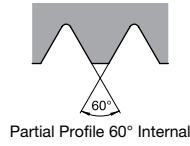
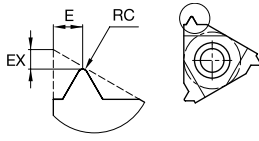
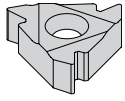

- first choice
- alternate choice

P	●
M	●
K	○
N	○
S	●
H	○

catalog number	RC		EX		E		SSC	thread pitch mm	TPI	TPF	TN6025
	mm	in	mm	in	mm	in					
<b>right hand</b>											
<b>2IRA60</b>	0,05	.002	0,8	.031	0,9	.035	2	0,50-1,50	16-48	—	2018262
<b>3IRA60</b>	0,05	.002	0,8	.031	0,9	.035	3	0,50-1,50	16-48	—	2018272
<b>3IRAG60</b>	0,05	.002	1,2	.047	1,7	.067	3	0,50-3,0	8-48	—	2018284
<b>3IRG60</b>	0,15	.006	1,2	.047	1,7	.067	3	1,75-3,0	8-14	—	2018278
<b>5IRQ60</b>	0,30	.012	1,8	.071	2,7	.106	5	5,5-6,0	4-4.5	—	2018295
<b>4IRN60</b>	0,31	.012	1,7	.067	2,5	.098	4	3,5-5,0	5-7	—	2018290
<b>left hand</b>											
<b>2ILA60</b>	0,05	.002	0,8	.031	0,9	.035	2	0,50-1,50	16-48	—	2021656
<b>3ILAG60</b>	0,05	.002	1,2	.047	1,7	.067	3	0,50-3,0	8-48	—	2008275
<b>4ILN60</b>	0,31	.012	1,7	.067	2,5	.098	4	3,5-5,0	5-7	—	2100489

NOTE: SSC = To correspond with the SSC on the toolholder.

Threading Inserts • ER/L-ISO

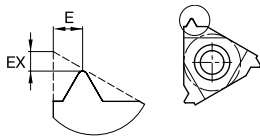
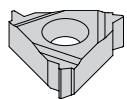

- first choice
- alternate choice

P	●
M	●
K	○
N	○
S	○
H	○

catalog number right hand	EX		E		SSC	thread pitch mm	TPI	TPF	TN6025
	mm	in	mm	in					
3ER05ISO	0,6	.024	0,4	.016	3	0,50	—	—	2018377
3ER07ISO	0,6	.024	0,6	.024	3	0,70	—	—	2018389
3ER075ISO	0,6	.024	0,6	.024	3	0,75	—	—	2018395
3ER08ISO	0,6	.024	0,6	.024	3	0,80	—	—	2018403
3ER10ISO	0,7	.027	0,7	.027	3	1,00	—	—	2018411
3ER125ISO	0,8	.031	0,9	.035	3	1,25	—	—	2018421
3ER15ISO	0,8	.031	1,0	.039	3	1,50	—	—	2018429
3ER175ISO	0,9	.035	1,2	.047	3	1,75	—	—	2018445
3ER20ISO	1,0	.039	1,3	.051	3	2,00	—	—	2018460
3ER25ISO	1,1	.043	1,5	.059	3	2,50	—	—	2018472
3ER30ISO	1,2	.047	1,6	.063	3	3,00	—	—	2008256

INDEXABLE MILLING

SOLID END MILLING

HOLE/MAKING

TAPPING

TURNING



## Threading Inserts • ER/L-ISO

(continued)

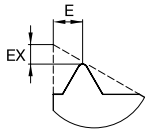
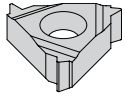

- first choice
- alternate choice

P	●
M	●
K	○
N	○
S	●
H	○

catalog number	EX		E		SSC	thread pitch mm	TPI	TPF	2018495	2018501	2018508	2018517	2018522	2018528	2008187	3122015	2018435	2018466	
	mm	in	mm	in															
4ER35ISO	1,6	.063	2,3	.090	4	3,50	—	—	●	○	○	○	○	○	○	○	○	○	○
4ER40ISO	1,6	.063	2,3	.090	4	4,00	—	—	●	○	○	○	○	○	○	○	○	○	○
4ER45ISO	1,7	.067	2,4	.094	4	4,50	—	—	○	○	○	○	○	○	○	○	○	○	○
4ER50ISO	1,7	.067	2,5	.098	4	5,00	—	—	○	○	○	○	○	○	○	○	○	○	○
5ER55ISO	2,7	.106	1,9	.075	5	5,50	—	—	○	○	○	○	○	○	○	○	○	○	○
5ER60ISO	2,9	.114	2,0	.079	5	6,00	—	—	○	○	○	○	○	○	○	○	○	○	○
left hand																			
3EL10ISO	0,7	.027	0,7	.027	3	1,00	—	—	○	○	○	○	○	○	○	○	○	○	○
3EL035ISO	0,8	.031	0,4	.016	3	0,35	—	—	○	○	○	○	○	○	○	○	○	○	○
3EL15ISO	0,8	.031	1,0	.039	3	1,50	—	—	○	○	○	○	○	○	○	○	○	○	○
3EL20ISO	1,3	.051	1,0	.039	3	2,00	—	—	○	○	○	○	○	○	○	○	○	○	○

NOTE: SSC = To correspond with the SSC on the toolholder.

Threading Inserts • IR/L-ISO

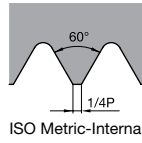
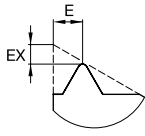
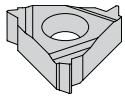

- first choice
- alternate choice

P	●
M	●
K	○
N	○
S	●
H	○

catalog number right hand	EX		E		SSC	thread pitch mm	TPI	TPF	TN6025
	mm	in	mm	in					
3IR05ISO	0,6	.024	0,6	.024	3	0,50	—	—	2018582
3IR075ISO	0,6	.024	0,6	.024	3	0,75	—	—	2018596
3IR10ISO	0,6	.024	0,7	.028	3	1,00	—	—	2018612
3IR125ISO	0,8	.032	0,9	.035	3	1,25	—	—	2018626
2IR15ISO	0,8	.032	1,0	.039	2	1,50	—	—	2018550
3IR15ISO	0,8	.032	1,0	.039	3	1,50	—	—	2018636
3IR175ISO	0,9	.035	1,2	.047	3	1,75	—	—	2018652
3IR20ISO	1,0	.039	1,3	.051	3	2,00	—	—	2018663
3IR25ISO	1,1	.043	1,5	.059	3	2,50	—	—	2018674
3IR30ISO	1,1	.043	1,5	.059	3	3,00	—	—	2018684
4IR35ISO	1,6	.063	2,3	.091	4	3,50	—	—	2018695

INDEXABLE MILLING

SOLID END MILLING

HOLE/MAKING

TAPPING

TURNING

## Threading Inserts • IR/L-ISO

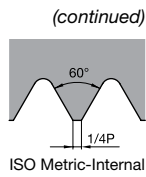
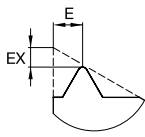
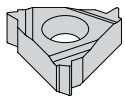

- first choice
- alternate choice

P	●
M	●
K	○
N	○
S	●
H	○

catalog number	EX		E		SSC	thread pitch mm	TPI	TPF	TN6025 2018702 2018714 2021597 2018708 2018720 2018598 2018642 2018688
	mm	in	mm	in					
4IR40ISO	1,6	.063	2,3	.091	4	4,00	—	—	
4IR50ISO	1,6	.063	2,3	.091	4	5,00	—	—	
5IR55ISO	1,6	.063	2,3	.091	5	5,50	—	—	
4IR45ISO	1,6	.063	2,4	.095	4	4,50	—	—	
5IR60ISO	1,8	.071	2,5	.098	5	6,00	—	—	
left hand									
3IL075ISO	0,6	.024	0,6	.024	3	0,75	—	—	
3IL15ISO	0,8	.032	1,0	.039	3	1,50	—	—	
3IL30ISO	1,1	.043	1,5	.059	3	3,00	—	—	

NOTE: SSC = To correspond with the SSC on the toolholder.

Threading Inserts • ER/L-UN

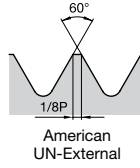
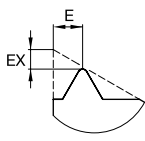
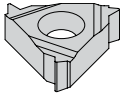

- first choice
- alternate choice

P	●
M	●
K	○
N	○
S	●
H	○

catalog number right hand	EX		E		SSC	thread pitch mm	TPI	TPF	TN6025
	mm	in	mm	in					
3ER32UN	0,6	.024	0,6	.024	3	—	32	—	2018752
3ER28UN	0,6	.024	0,7	.028	3	—	28	—	2018756
3ER24UN	0,7	.028	0,8	.032	3	—	24	—	2018766
3ER20UN	0,8	.032	0,9	.035	3	—	20	—	2018772
3ER18UN	0,8	.032	1,0	.039	3	—	18	—	2018778
3ER16UN	0,9	.035	1,1	.043	3	—	16	—	2018782
3ER14UN	1,0	.039	1,2	.047	3	—	14	—	2018790
3ER12UN	1,1	.043	1,4	.055	3	—	12	—	2018802
3ER11UN	1,1	.043	1,5	.059	3	—	11	—	2018808
3ER10UN	1,1	.043	1,5	.059	3	—	10	—	2018814
3ER8UN	1,2	.047	1,6	.063	3	—	8	—	2018824
3ER13UN	1,3	.051	1,0	.039	3	—	13	—	2018796

NOTE: SSC = To correspond with the SSC on the toolholder.

INDEXABLE MILLING

SOLID END MILLING

HOLE/MAKING

TAPPING

TURNING

INDEXABLE MILLING

SOLID END MILLING

HOLEMAKING

TAPPING

TURNING

## Threading Inserts • IR/L-UN

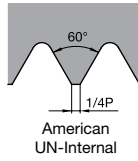
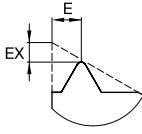
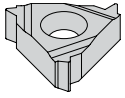

- first choice
- alternate choice

P	●
M	●
K	○
N	○
S	●
H	○

catalog number	EX		E		SSC	thread pitch mm	TPI	TPF	TN6025
	mm	in	mm	in					
<b>right hand</b>									
3IR20UN	0,8	.032	0,9	.035	3	—	20	—	2018938
3IR18UN	0,8	.032	1,0	.039	3	—	18	—	2018944
2IR18UN	0,8	.031	1,0	.039	2	—	18	—	2018882
3IR16UN	0,9	.035	1,1	.043	3	—	16	—	2018950
2IR16UN	0,9	.035	1,1	.043	2	—	16	—	2018886
3IR12UN	1,1	.043	1,4	.055	3	—	12	—	2018966
3IR8UN	1,1	.043	1,5	.059	3	—	8	—	2018990
<b>left hand</b>									
3IL12UN	1,1	.043	1,4	.055	3	—	12	—	2102749

NOTE: SSC = To correspond with the SSC on the toolholder.

Threading Inserts • ER/L-NPT

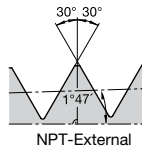
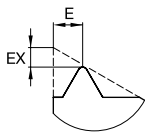
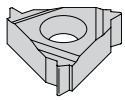

- first choice
- alternate choice

P	●
M	●
K	○
N	○
S	○
H	○

catalog number right hand	EX		E		SSC	thread pitch mm	TPI	TPF	TN6025
	mm	in	mm	in					
3ER18NPT	0,8	.032	1,0	.039	3	—	18	.7500	2019278
3ER14NPT	0,9	.035	1,2	.047	3	—	14	.7500	2019288
3ER115NPT	1,1	.043	1,5	.059	3	—	11.5	.7500	2019298
3ER8NPT	1,3	.051	1,8	.071	3	—	8	.7500	2019305

NOTE: SSC = To correspond with the SSC on the toolholder.

Threading Inserts • IR/L-NPT

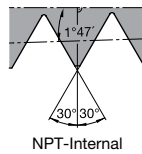
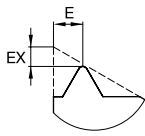
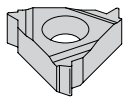

- first choice
- alternate choice

P	●
M	●
K	○
N	○
S	○
H	○

catalog number right hand	EX		E		SSC	thread pitch mm	TPI	TPF	TN6025
	mm	in	mm	in					
3IR14NPT	0,9	.035	1,2	.047	3	—	14	.7500	2019329
3IR115NPT	1,1	.043	1,5	.059	3	—	11.5	.7500	2019335

NOTE: SSC = To correspond with the SSC on the toolholder.

## Threading Inserts • ER/L-55

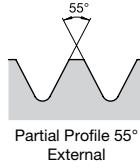
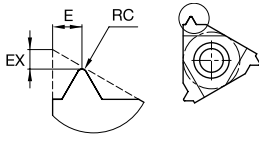
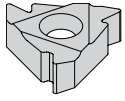

- first choice
- alternate choice

P	●
M	●
K	○
N	○
S	●
H	○

catalog number	RC		EX		E		SSC	thread pitch mm	TPI	TPF	TN6025
	mm	in	mm	in	mm	in					
<b>right hand</b>											
<b>3ERAG55</b>	0,08	.003	1,2	.047	1,7	.067	3	0,50-3,0	8-48	—	2018314
<b>3ERG55</b>	0,20	.008	1,2	.047	1,7	.067	3	1,75-3,0	8-14	—	2018308
<b>4ERN55</b>	0,43	.017	1,7	.067	2,5	.098	4	3,5-5,0	5-7	—	2018320
<b>left hand</b>											
<b>3ELG55</b>	0,20	.008	1,2	.047	1,7	.067	3	1,75-3,0	8-14	—	2008190

NOTE: SSC = To correspond with the SSC on the toolholder.

Threading Inserts • IR/L-55

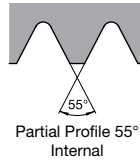
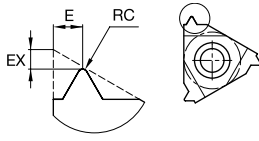
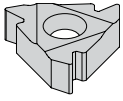

- first choice
- alternate choice

P	●
M	●
K	○
N	○
S	●
H	○

catalog number	RC		EX		E		SSC	thread pitch mm	TPI	TPF	TN6025
	mm	in	mm	in	mm	in					
<b>right hand</b>											
2IRA55	0,05	.002	0,8	.031	0,9	.035	2	0,50-1,50	16-48	—	2018328
3IRA55	0,05	.002	0,8	.031	0,9	.035	3	0,50-1,50	16-48	—	2018334
3IRAG55	0,07	.003	1,2	.047	1,7	.067	3	0,50-3,0	8-48	—	2018346
3IRG55	0,21	.008	1,2	.047	1,7	.067	3	1,75-3,0	8-14	—	2018340
4IRN55	0,43	.017	1,7	.067	2,5	.098	4	3,5-5,0	5-7	—	2018354
<b>left hand</b>											
3ILA55	0,05	.002	0,8	.031	0,9	.035	3	0,50-1,50	16-48	—	3122449

NOTE: SSC = To correspond with the SSC on the toolholder.

INDEXABLE MILLING

SOLID END MILLING

HOLE/MAKING

TAPPING

TURNING



INDEXABLE MILLING

SOLID END MILLING

HOLEMAKING

TAPPING

TURNING

## Threading Inserts • ER/L-W

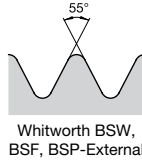
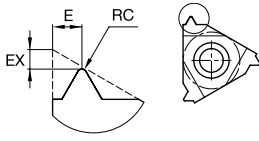
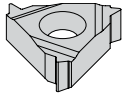

- first choice
- alternate choice

P	●
M	●
K	○
N	○
S	●
H	○

catalog number right hand	RC		EX		E		SSC	thread pitch mm	TPI	TPF	TN6025
	mm	in	mm	in	mm	in					
<b>3ER32W</b>	0,08	.003	0,6	.024	0,6	.024	3	—	32	—	2019023
<b>3ER28W</b>	—	—	0,6	.024	0,7	.028	3	—	28	—	2019029
<b>3ER19W</b>	—	—	0,8	.032	1,0	.039	3	—	19	—	2019055
<b>3ER14W</b>	—	—	1,0	.039	1,2	.047	3	—	14	—	2019071
<b>3ER10W</b>	—	—	1,1	.043	1,5	.059	3	—	10	—	2019089
<b>3ER11W</b>	—	—	1,1	.043	1,5	.059	3	—	11	—	2019083
<b>3ER8W</b>	—	—	1,2	.047	1,5	.059	3	—	8	—	2019101

NOTE: SSC = To correspond with the SSC on the toolholder.

### Threading Inserts • IR/L-W

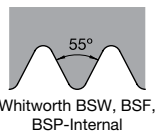
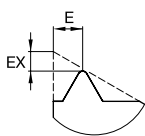
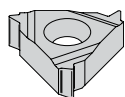

- first choice
- alternate choice

P	●
M	●
K	○
N	○
S	●
H	○

catalog number right hand	EX		E		SSC	thread pitch mm	TPI	TPF	TN6025
	mm	in	mm	in					
2IR14W	0,9	.035	1,1	.043	2	—	14	—	2019136
3IR14W	1,0	.039	1,2	.047	3	—	14	—	2019189
3IR11W	1,1	.043	1,5	.059	3	—	11	—	2019205

NOTE: SSC = To correspond with the SSC on the toolholder.

### Threading Inserts • ER/L-RD

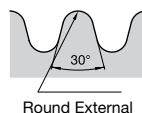
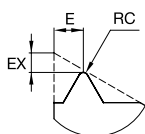
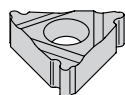

- first choice
- alternate choice

P	●
M	●
K	○
N	○
S	●
H	○

catalog number right hand	RC		EX		E		SSC	thread pitch mm	TPI	TPF	TN6025
	mm	in	mm	in	mm	in					
3ER8RD	0,76	.030	1,4	.055	1,3	.051	3	—	8	—	2019347

NOTE: SSC = To correspond with the SSC on the toolholder.

## Threading Inserts • IR/L-RD

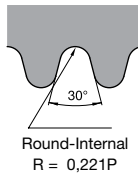
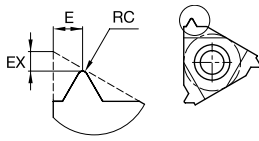
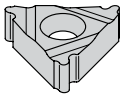

- first choice
- alternate choice

P	●
M	○
K	○
N	○
S	○
H	○

catalog number right hand	RC		EX		E		SSC	thread pitch mm	TPI	TPF	TN6025
	mm	in	mm	in	mm	in					
<b>3IR8RD</b>	0,70	.028	1,4	.055	1,4	.055	3	—	8	—	2019381
<b>4IR4RD</b>	1,40	.055	2,3	.091	2,2	.087	4	—	4	—	2019400

NOTE: SSC = To correspond with the SSC on the toolholder.

## Threading Inserts • ER/L-TR

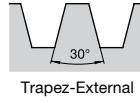
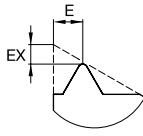
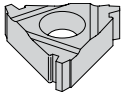

- first choice
- alternate choice

P	●
M	●
K	○
N	○
S	○
H	○

catalog number	EX		E		SSC	thread pitch mm	TPI	TPF	TN16025
	mm	in	mm	in					
<b>right hand</b>									
3ER2TR	1,1	.043	1,3	.051	3	2,00	—	—	2019453
3ER3TR	1,3	.051	1,5	.059	3	3,00	—	—	2019461
4ER4TR	1,7	.067	1,9	.075	4	4,00	—	—	2019469
4ER5TR	2,1	.083	2,5	.098	4	5,00	—	—	2019479
5ER6TR	2,3	.091	2,7	.106	5	6,00	—	—	2019487
<b>left hand</b>									
3EL3TR	1,3	.051	1,5	.059	3	3,00	—	—	2019463

NOTE: SSC = To correspond with the SSC on the toolholder.

INDEXABLE MILLING

SOLID END MILLING

HOLE/MAKING

TAPPING

TURNING

INDEXABLE MILLING

SOLID END MILLING

HOLEMAKING

TAPPING

TURNING

## Threading Inserts • IR/L-TR

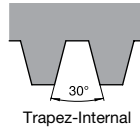
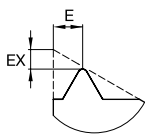
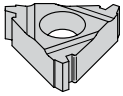

- first choice
- alternate choice

P	<input checked="" type="checkbox"/>
M	<input checked="" type="checkbox"/>
K	<input type="checkbox"/>
N	<input type="checkbox"/>
S	<input checked="" type="checkbox"/>
H	<input type="checkbox"/>
	<input type="checkbox"/>

catalog number right hand	EX		E		SSC	thread pitch mm	TPI	TPF	TN6025
	mm	in	mm	in					
3IR3TR	1,3	.051	1,5	.059	3	3,00	—	—	2019511
4IR4TR	1,7	.067	1,9	.075	4	4,00	—	—	2019520
4IR5TR	2,1	.083	2,5	.098	4	5,00	—	—	2019528
5IR6TR	2,3	.091	2,7	.106	5	6,00	—	—	2019534

NOTE: SSC = To correspond with the SSC on the toolholder.

## Laydown Threading Toolholder • Catalog Numbering System

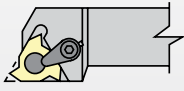
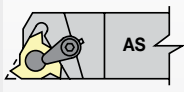
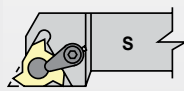
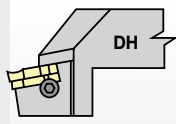
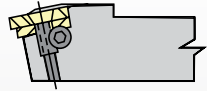
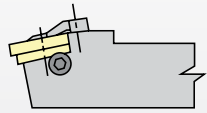
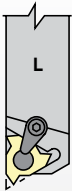
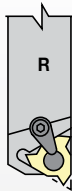
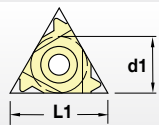
<b>L</b>	<b>S</b>	<b>AS</b>	<b>R</b>		<b>16</b>	<b>3</b>																					
Insert Style	Insert Holding Method	Tool Style	Hand of Tool	Drop Head	Shank Size	Insert Size	Qualified Surface and Length																				
<p><b>L</b> – Laydown triangle</p> 		<p>Straight shank</p>  <p>Offset shank</p> 					<p><b>C</b> – qualified back and end, 5" long</p> <p><b>D</b> – qualified back and end, 6" long</p> <p><b>E</b> – qualified back and end, 7" long</p> <p><b>T</b> – qualified back and end, 3.25" long</p> <p><b>Q</b> – qualified metric holder</p>																				
<p><b>S</b> – Insert screw or clamp only</p>  		<p>Left hand</p>  <p>Right hand</p> 		<p><b>Inch:</b> This shows a two-digit number that indicates the holder cross section. For shanks 5/8" square and over, the number will represent the number of sixteenths of width and height. For shanks under 5/8" square, the number of sixteenths of cross section will be preceded by a zero. For rectangular holders, the first digit represents the number of eighths of width, and the second digit the number of quarters of height, except for a toolholder 1-1/4" x 1-1/2", which is given the number 91.</p>																							
							<p>Size equals number of 1/8" increments of iC.</p> 																				
							<table border="1"> <thead> <tr> <th>inch insert size</th> <th>metric insert size</th> <th>d1 inch</th> <th>L1 mm</th> </tr> </thead> <tbody> <tr> <td>2</td> <td>11</td> <td>1/4</td> <td>11,0</td> </tr> <tr> <td>3</td> <td>16</td> <td>3/8</td> <td>16,5</td> </tr> <tr> <td>4</td> <td>22</td> <td>1/2</td> <td>22,0</td> </tr> <tr> <td>5</td> <td>27</td> <td>5/8</td> <td>27,0</td> </tr> </tbody> </table>	inch insert size	metric insert size	d1 inch	L1 mm	2	11	1/4	11,0	3	16	3/8	16,5	4	22	1/2	22,0	5	27	5/8	27,0
inch insert size	metric insert size	d1 inch	L1 mm																								
2	11	1/4	11,0																								
3	16	3/8	16,5																								
4	22	1/2	22,0																								
5	27	5/8	27,0																								

INDEXABLE MILLING

SOLID END MILLING

HOLE/MAKING

TAPPING

TURNING

## Laydown Threading Boring Bar • Catalog Numbering System

**S**

Bar Type

**E** – Carbide with coolant

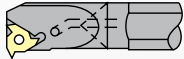

**S** – Steel shank without coolant



**10**

Primary Necked Shank Bar Diameter

**12**

Secondary (mounting) Bar Diameter

**L**

Insert Style

**L** – Laydown triangle

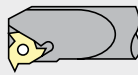

**S**

Insert Holding Method

**S** – Insert screw or clamp only

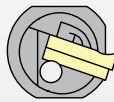
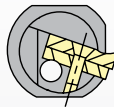

**E**

Bar Style

End cutting edge mount



**R**

Hand of Tool

Left hand

Right hand

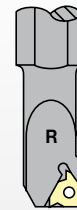

Indicates the primary bar diameter in 1/16" increments.

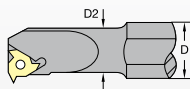

NOTE: Boring bars with primary bar diameters larger than 5/8" are supplied with clamp and insert screw. Secure the insert with either the clamp or insert screw. **Do not use both.**

Indicates the secondary bar diameter in 1/16" increments.

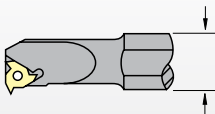

Size equals number of 1/8" increments of iC.

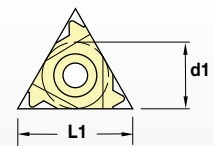

inch insert size	metric insert size	d1 inch	L1 mm
2	11	1/4	11,0
3	16	3/8	16,5
4	22	1/2	22,0

INDEXABLE MILLING

SOLID END MILLING

HOLEMAKING

TAPPING

TURNING

Integral Toolholders • LSAS

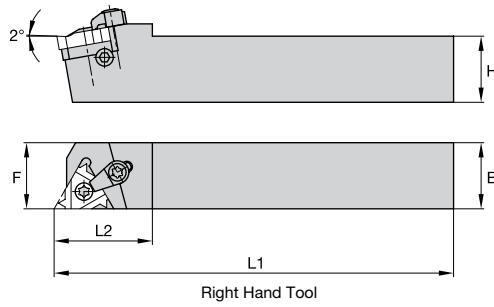
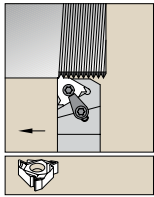

order number	catalog number	SSC	H	B	F	L1	L2	gage insert
<b>right hand</b>								
2968567	LSASR83	3	.500	.500	.500	3.25	.87	LT16ER
2968584	LSASR123	3	.750	.750	.750	5.00	1.20	LT16ER
2968585	LSASR163	3	1.000	1.000	1.000	6.00	1.20	LT16ER
2968586	LSASR164	4	1.000	1.000	1.000	6.00	1.42	LT22ER
<b>left hand</b>								
2968570	LSASL163	3	1.000	1.000	1.000	6.00	1.20	LT16EL

NOTE: SSC = To correspond with the SSC on the insert.

Integral Toolholders • LSS

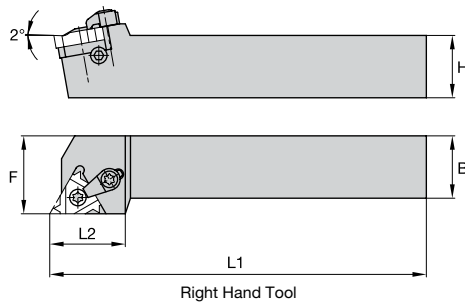
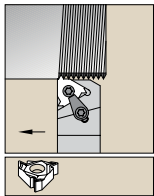

order number	catalog number	SSC	H	B	F	L1	L2	gage insert
<b>right hand</b>								
2968591	LSSR123D	3	.750	.750	1.000	6.00	1.00	LT16ER
2968592	LSSR163D	3	1.000	1.000	1.250	6.00	1.00	LT16ER
2968593	LSSR164D	4	1.000	1.000	1.250	6.00	1.20	LT22ER

NOTE: SSC = To correspond with the SSC on the insert.

INDEXABLE MILLING

SOLID END MILLING

HOLEMAKING

TAPPING

TURNING



## Cutting Units • KM40TS • LSE-N 90° • Internal Only • Metric

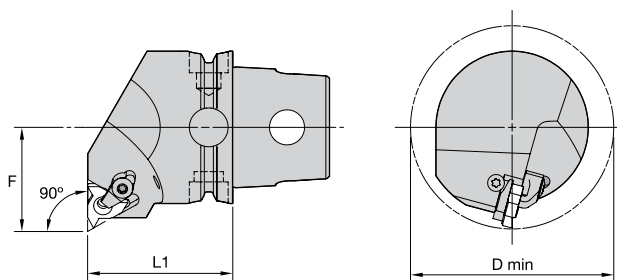

order number	catalog number	L1		F		D min		gage insert	kg	lbs
		mm	in	mm	in	mm	in			
<b>right hand</b>										
3950832	KM40TSLSER16N	40	1.575	27	1.063	54	2.126	LT16NR	0,35	.78
3950854	KM40TSLSER22N	40	1.575	27	1.063	54	2.126	LT22NR	0,35	.77
<b>left hand</b>										
3950831	KM40TSLSEL16N	40	1.575	27	1.063	54	2.126	LT16NL	0,35	.78

NOTE: Cutting units are supplied with insert screw and clamp assembly.  
However, tools are designed to use either the insert screw or the clamp assembly, not both.

## Cutting Units • KM40TS • LSE 90° • Metric

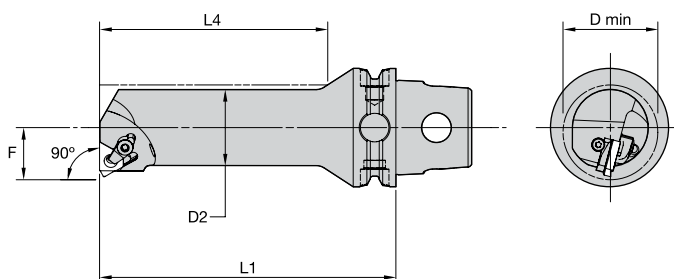

order number	catalog number	D2		D min		F		L4		L1		gage insert	kg	lbs
		mm	in	mm	in	mm	in	mm	in	mm	in			
<b>right hand</b>														
3955464	KM40TSS10DLSER11	10	.394	13	.51	7	.276	35	1.38	60	2.362	LT11NR	0,22	.49
3955466	KM40TSS12ELSER11	12	.472	16	.63	9	.354	42	1.66	70	2.756	LT11NR	0,25	.56
3955468	KM40TSS16FLSER16	16	.630	20	.79	11	.433	56	2.21	80	3.150	LT16NR	0,28	.61
3955470	KM40TSS20GLSER16	20	.787	25	.98	13	.512	70	2.76	90	3.543	LT16NR	0,34	.75
3955472	KM40TSS25HLSER16	25	.984	32	1.26	17	.669	75	2.95	100	3.937	LT16NR	0,50	1.11
3955474	KM40TSS32JLSER16	32	1.260	40	1.57	22	.866	96	3.78	110	4.331	LT16NR	0,72	1.58
3955476	KM40TSS32JLSER22	32	1.260	40	1.57	22	.866	96	3.78	110	4.331	LT22NR	0,71	1.56
<b>left hand</b>														
3955463	KM40TSS10DSEL11	10	.394	13	.51	7	.276	35	1.38	60	2.362	LT11NL	0,22	.49
3955465	KM40TSS12ELSEL11	12	.472	16	.63	9	.354	42	1.65	70	2.756	LT11NL	0,25	.55
3955469	KM40TSS20GLSEL16	20	.787	25	.98	13	.512	70	2.76	90	3.543	LT16NL	0,34	.75
3955471	KM40TSS25HSEL16	25	.984	32	1.26	17	.669	75	2.95	100	3.937	LT16NL	0,50	1.11
3955473	KM40TSS32JLSEL16	32	1.260	40	1.57	22	.866	96	3.78	110	4.331	LT16NL	0,72	1.58
3955475	KM40TSS32JLSEL22	32	1.260	40	1.57	22	.866	96	3.78	110	4.331	LT22NL	0,71	1.56

NOTE: Items listed without a shim are designed for a 1,5° inclination angle.  
Cutting units are supplied with insert screw and clamp assembly. However, tools are designed to use either the insert screw or the clamp assembly, not both.

Integral I.D. Threading Boring Bars • E-LSE

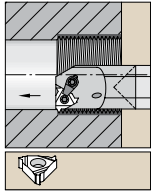

Carbide shank with through coolant.

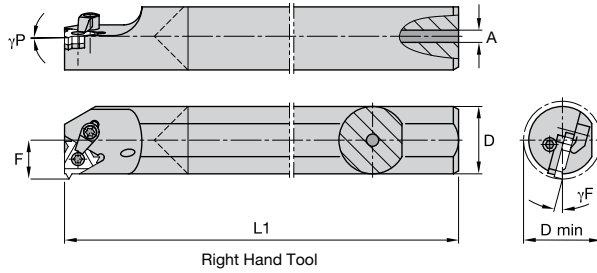

Right Hand Tool

order number	catalog number	SSC	D	D min	F	L1	A	$\gamma F^\circ$	$\gamma P^\circ$	gage insert
<b>right hand</b>										
2892518	E06LSER2	2	.375	.500	.280	6.00	.13	-15.0	-1.50	LT11NR
<b>left hand</b>										
2892519	E06LSEL2	2	.375	.500	.280	6.00	.13	-15.0	-1.50	LT11NL
2892555	E12LSEL3	3	.750	.900	.510	10.00	.22	-15.0	-1.50	LT16NL

NOTE: Items listed without a shim are designed for a 1.5° inclination angle.  
SSC = To correspond with the SSC on the insert.

Integral I.D. Threading Boring Bars • S-LSE

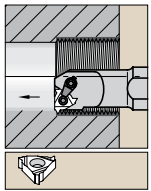

Steel shank without coolant.

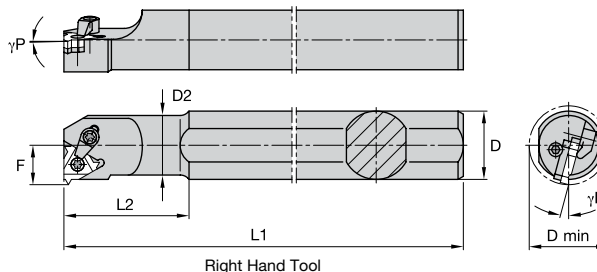

Right Hand Tool

order number	catalog number	SSC	D	D min	D2	F	L1	L2	$\gamma F^\circ$	$\gamma P^\circ$	gage insert
<b>right hand</b>											
2968597	S0612LSER2	2	.750	.500	.375	.280	7.00	1.00	-15.0	-1.50	LT11NR
2968601	S1012LSER3	3	.750	.800	.625	.460	7.00	1.50	-15.0	-1.50	LT16NR
2968763	S1212LSER3	3	.750	.900	—	.510	7.00	1.57	-15.0	-1.50	LT16NR
2968765	S1620LSER3	3	1.250	1.200	1.000	.650	10.00	2.50	-15.0	-1.50	LT16NR

NOTE: Items listed without a shim are designed for a 1.5° inclination angle.  
SSC = To correspond with the SSC on the insert.

INDEXABLE MILLING

SOLID END MILLING

HOLE/MAKING

TAPPING

TURNING

## Hardware

### Laydown Threading Toolholders

In all cases, the proper shim selection is important.

WIDIA™ toolholders are supplied with a shim for a 1.5° lead angle. Change the shim if your thread is more than 1° different. For more details on proper shim selections, see pages E519–E520.

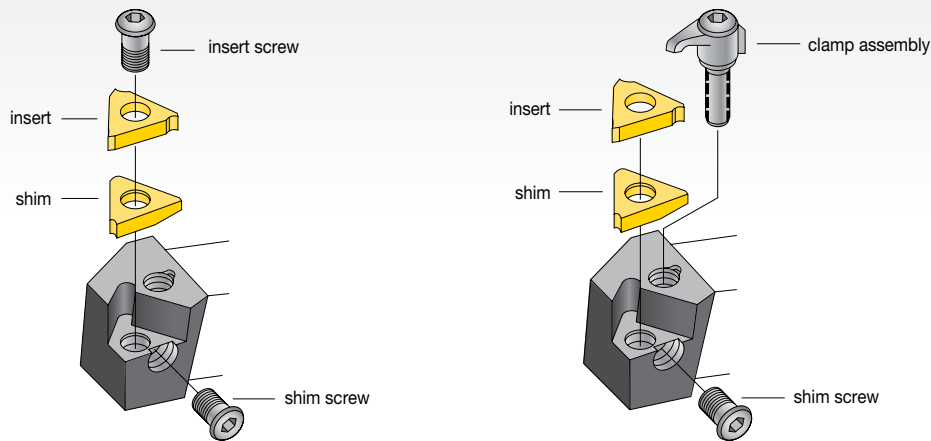

insert size and screw	insert screw	shim	shim screw and washer	clamp assembly
3ER	S-SA3T	SM-YIE3	S-SY3T	CK-C3
3EL	S-SA3T	SM-YI3	S-SY3T	CK-C3
4ER	S-SA4T	SM-YIE4	S-SY4T	CK-C4
4EL	S-SA4T	SM-YI4	S-SY4T	CK-C4
Laydown Threading boring bars				
2IR	S-SN2T	—	—	—
2IL	S-SN2T	—	—	—
3IR	S-SA3T	SM-YI3	S-SY3T	CK-C3
3IL	S-SA3T	SM-YIE3	S-SY3T	CK-C3
4IR	S-SA4T	SM-YI4	S-SY4T	CK-C4
4IL	S-SA4T	SM-YIE4	S-SY4T	CK-C4

**SM**

Shim

—

**Y**

Y-shim for Laydown standard inserts

**E**

**E** — External  
**I** — Internal

**3**

iC — 1/8"

—

**2N**

Shim Angle

2P	2° positive
1P	1° positive
—	0°
1N	1° negative
2N	2° negative
3N	3° negative

## Screw Thread Definitions

resultant angle		3.5°	2.5°	1.5°	0.5°	-0.5°	-1.5°
insert size (iC)	toolholder	shim ordering code					
3/8"	ex. RH/in. LH ex. LH/in. RH	SM-YE3-2P SM-YI3-2P	SM-YE3-1P SM-YI3-1P	SM-YE3 SM-YI3	SM-YE3-1N SM-YI3-1N	SM-YE3-2N SM-YI3-2N	SM-YE3-3N SM-YI3-3N
1/2"	ex. RH/in. LH ex. LH/in. RH	SM-YE4-2P SM-YI4-2P	SM-YE4-1P SM-YI4-1P	SM-YE4 SM-YI4	SM-YE4-1N SM-YI4-1N	SM-YE4-2N SM-YI4-2N	SM-YE4-3N SM-YI4-3N

### Slanted Shim Kit

Because you might occasionally need different shims than those supplied with our standard toolholders, we strongly recommend that shim kits be readily available in every tool shop.

insert size	shim size (D)	ordering code	contains slanted shims
3x	3/8"	ABY3	SM-YE3-2P, 1P, 1N, 2N, 3N SM-YI3-2P, 1P, 1N, 2N, 3N
4x	1/2"	ABY4	SM-YE4-2P, 1P, 1N, 2N, 3N SM-YI4-2P, 1P, 1N, 2N, 3N

### The Helix Angle

Example:  
 $d = 1.892''$  (48,06mm)  $\phi$  = Helix angle  
 $p = .125''$  (3,175mm)  $p$  = pitch  
 $d$  = pitch diameter

$$\phi = \arctan \left( \frac{p * \text{starts}}{\pi * \phi} \right) = 1.13^\circ$$

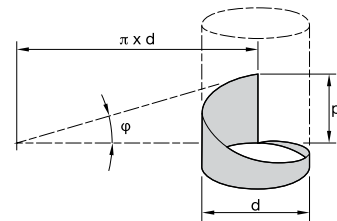

### Screw Thread Definitions

1. Major diameter — The largest diameter of a straight screw thread. This applies to both internal and external threads.
2. Pitch diameter — On a straight thread, it is the diameter which passes through the thread profiles at such points which make the thread width of the groove equal to one-half of the basic pitch. On a "perfect thread," this occurs at the point where the widths of the thread and groove are equal.
3. Thread angle (included) — The included angle between the individual flanks of the thread form.
4. Minor diameter — The smallest diameter of a straight screw thread. This applies to both internal and external threads.
5. Lead angle — On a straight thread, the lead angle is the angle created by the helix of the thread at the pitch diameter with a plane perpendicular to the axis.
6. Lead — The distance a screw thread advances axially in one revolution. On a single start, the pitch and lead are identical. The lead is equal to the pitch times the number of starts.
7. Pitch — The distance from a point on a screw thread to a corresponding point on the next thread measured parallel to the thread axis.
8. Crest — The outermost surface of the thread form which joins the flanks.
9. Root — The innermost surface of the thread form which joins the flanks.

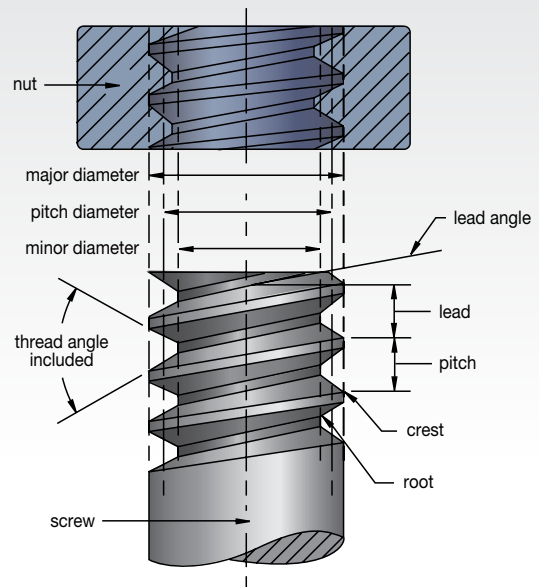

NOTE: Threads per inch (TPI) not shown:  
 The number of threads per inch measured axially.  
 The terms pitch and TPI are often used interchangeably.  $TPI = 1/\text{pitch}$

## Common Thread Forms

NOTE: Taper shown exaggerated.

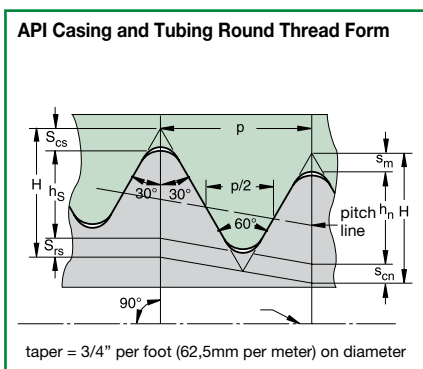
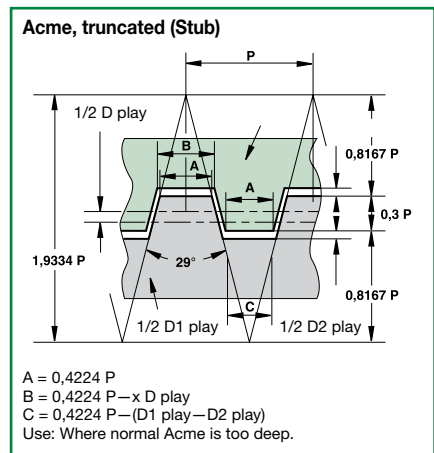
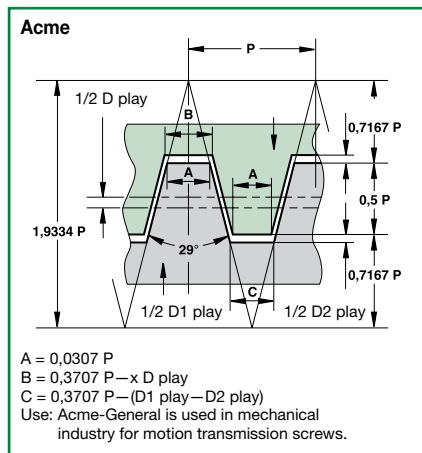
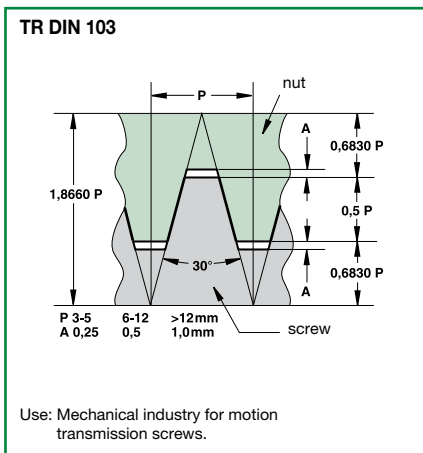
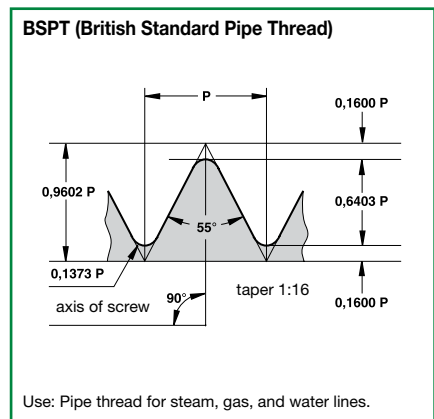
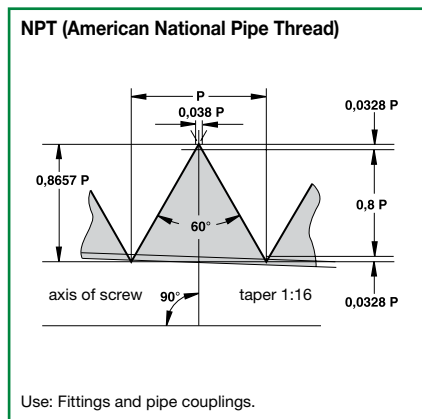
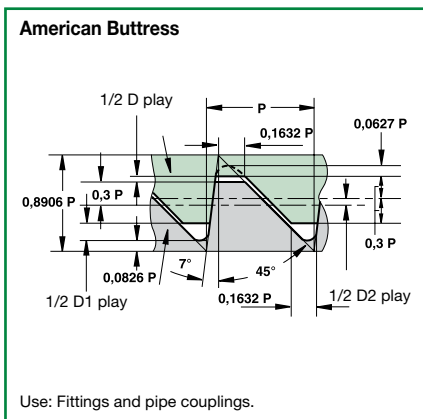
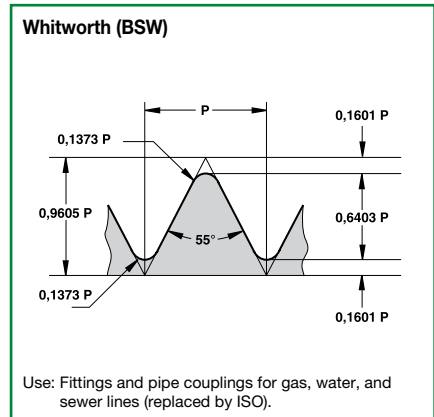
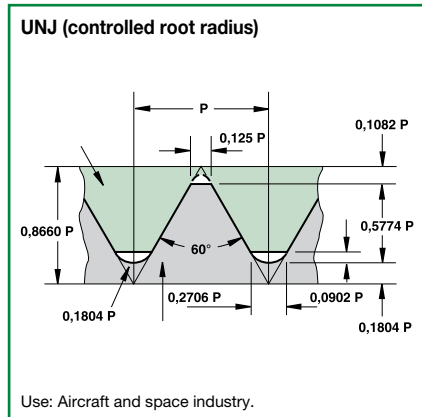
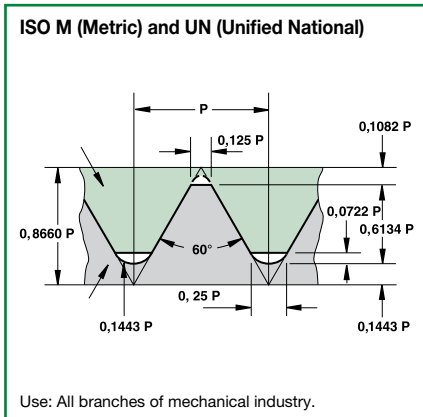

NOTE: Taper shown exaggerated.

Grade Selection Chart







Suggested Grades and Speeds for Threading  
Various Workpiece Materials

workpiece group	workpiece material	recommended surface speed – SFM		
		uncoated	PVD coated	
		THM	TN6010	TN6025
free-machining carbon steel	10L18, 10L45, 1213, 12L13, 12L14, 1140, 1141, 11L44, 1151, 10L50	–	300–650	150–650
plain carbon steel	10063, 1008, 1010, 1015, 1018, 1020, 1025, 1026, 1108, 1117	–	250–650	150–575
alloy steels/tool steels 150–325 HB (up to 35 HRC)	1042, 1045, 1070, 1080, 1085, 1090, 1095, 1541, 1561, 1572, 5140, 8620, W1, O1, S1, P20, H13, D2, A6, H13, L6	–	250–650	125–550
alloy steels/tool steels 330–450 HB (36–47 HRC)		–	200–525	–
martensitic/ferritic stainless/precipitation hardening	416, 420F, 440F, 405, 409, 429, 430, 434, 436, 442, PH	–	150–525	100–400
austenitic stainless steel	201, 202, 301, 302, 303, 304, 304, 305, 321, 347, 348, 310, 314, 316, 316L, 330	200–350	200–650	150–450
gray cast iron 135–270 HB	class 20, 30, 35, 45	200–300	200–775	150–400
gray cast iron 275–450 HB	class 50, 55, 60	150–250	150–575	50–250
alloy/ductile iron	A536, J434C, 60-40-18, 80-55-06, 100-70-03	150–250	150–650	100–525
free-machining aluminum alloys	2024-T4, 2014-T6, 6061-T6 2011-T3, 3003-H18, A2, Alcan, Alcoa® 510, Duralumin	400–800	400–1200	–
high-silicon aluminum alloys	A380, A390, A380-1, A390-1, A380-2	–	–	–
copper/zinc/brass		250–600	250–1000	150–775
non-metallics	Graphite, Nylon, Plastics, Rubbers, Phenolics, Carbon	400–1500	400–1300	150–1000
high-temperature alloys 125–269 HB (up to 27 HRC)	Nickel 200, MONEL®, R405, MONEL K500, INCONEL® 600, INCONEL 625/901x750/718, Waspaloy®, Hastelloy® C	80–120	80–400	40–250
high-temperature alloys 260–450 HB (26–47 HRC)	Rene 95, Waspaloy A286, INCOLOY® 800, Haynes® 188, Stellite™ F, Haynes 25	80–100	100–250	20–200
titanium alloys	Ti-6Al-4V, Ti-5Al-2.5Sn	110–180	110–325	–

NOTE: When workpiece hardness levels are at the top of a range, starting SFM should be at the lower end. Regularly inspect insert clamps for worn flats.

Edge preparation:  
Uncoated – sharp  
PVD coated – light hone except positive top rake, top rake-sharp

## Failure and Solution Guide

problem	cause	possible solution
thread with torn finish 	<ul style="list-style-type: none"> <li>• Burs.</li> <li>• Torn finish.</li> <li>• Steps.</li> <li>• Improper shim.</li> <li>• Improper infeed.</li> </ul>	<ul style="list-style-type: none"> <li>• Use modified flank infeed.</li> <li>• Use full profile insert.</li> <li>• Increase coolant concentration.</li> <li>• Increases SFM.</li> <li>• Check machine "Z" travel axis.</li> <li>• Check insert form.</li> <li>• Check for correct shim in LT system.</li> <li>• Calculate flank clearance.</li> </ul>
chatter 	<ul style="list-style-type: none"> <li>• Poor rigidity.</li> <li>• Insert movement.</li> <li>• Improper infeed.</li> <li>• Off centerline.</li> </ul>	<ul style="list-style-type: none"> <li>• Use modified flank infeed.</li> <li>• Minimize tool overhang.</li> <li>• Check for workpiece deflection.</li> <li>• Check insert and clamp.</li> <li>• Verify that tool cutting position is at workpiece centerline.</li> <li>• Adjust number of passes. Fewer passes reduce chatter.</li> </ul>
built-up edge 	<ul style="list-style-type: none"> <li>• Speed too low.</li> <li>• Insufficient coolant.</li> <li>• Chip load.</li> </ul>	<ul style="list-style-type: none"> <li>• Increase SFM.</li> <li>• Increase coolant concentration and/or flow.</li> <li>• Adjust infeed angle.</li> <li>• Increase depth of cut per pass.</li> </ul>
deformation 	<ul style="list-style-type: none"> <li>• Wrong grade.</li> <li>• Speed too high.</li> <li>• Improper infeed angle.</li> <li>• Insufficient coolant.</li> </ul>	<ul style="list-style-type: none"> <li>• Use modified flank infeed.</li> <li>• Use a more wear-resistant grade (e.g., TN6010™).</li> <li>• Reduce SFM.</li> <li>• Increase coolant flow.</li> </ul>
chipping 	<ul style="list-style-type: none"> <li>• Improper infeed.</li> <li>• Chip load.</li> <li>• Wrong grade.</li> <li>• Incorrect speed.</li> <li>• Poor rigidity.</li> </ul>	<ul style="list-style-type: none"> <li>• Use modified flank infeed.</li> <li>• Increase or decrease number of passes.</li> <li>• Eliminate spring passes.</li> <li>• Use tougher grade (e.g., TN6025™).</li> <li>• Increase SFM if chipping on trailing edge.</li> <li>• Decrease SFM if chipping on leading edge.</li> <li>• Minimize tool overhang.</li> <li>• Check for insert movement/check clamp. Torque screw or clamp to correct value.</li> <li>• Check for possible part deflection.</li> <li>• Calculate flank clearance.</li> <li>• Ensure correct shim.</li> </ul>
broken nose 	<ul style="list-style-type: none"> <li>• Heavy chip load.</li> <li>• Small nose radius.</li> <li>• Wrong grade.</li> <li>• Improper infeed.</li> </ul>	<ul style="list-style-type: none"> <li>• Use modified flank infeed.</li> <li>• Decrease chip load.</li> <li>• Use large nose radius if possible.</li> <li>• Use tougher grade (e.g., TN6025).</li> </ul>
flank wear 	<ul style="list-style-type: none"> <li>• Improper shim.</li> <li>• Wrong grade.</li> <li>• Insufficient coolant.</li> <li>• Off centerline.</li> <li>• Insufficient flank clearance .</li> <li>• Improper infeed angle.</li> </ul>	<ul style="list-style-type: none"> <li>• Ensure correct shim.</li> <li>• Use a more wear-resistant grade (e.g., TN6025).</li> <li>• Increase coolant flow.</li> <li>• Check the centerline height of the tool. (The smaller the diameter, the more critical the need for centerline accuracy.)</li> <li>• Calculate flank clearance and change shim to increase clearance on worn flank.</li> <li>• If wear is on trailing flank, increase infeed angle clearance.</li> </ul>

### Failure and Solution Guide

problem	possible solution																	
	increase SFM	reduce SFM	increase chip load	decrease chip load where failure occurs	use tougher carbide grade	use harder carbide grade	apply coolant	use coated carbide	use topping insert	change infeed angle	check for insert movement and reseat	reduce tool overhang	reselect shim	apply chipbreaker style	reduce DOC	adjust center height	begin cutting threads .472" before workpiece	change infeed method
chatter	•			•							•	•				•		•
bur on crest	•								•									•
short tool life		•	•	•		•		•										•
chipped leading edge			•	•	•													
chipped trailing edge					•					•								
broken nose (first pass)	•														•	•		
broken nose (after first pass)				•	•					•			•					•
built-up on cutting edge	•		•					•	•									•
premature topping													•					
splitting threads																	•	
poor chip evacuation														•				•

INDEXABLE MILLING

SOLID END MILLING

HOLEMAKING

TAPPING

TURNING



## General Machining Guidelines

WIDIA™ insert technology brings chip control to your threading operations with the TopThread™ platform. The proprietary WIDIA recessed chip groove, when used according to our recommendations, controls the chip in most applications. Our positive rake design lowers cutting pressures, which in turn lowers damaging heat generation thus providing better tool life. Long, stringy chips no longer mar the workpiece surface finish. The danger to operators when removing long chips from the workpiece and chuck is eliminated. All of these benefits combine to improve the productivity of your threading operations.

### The Last Pass

Some CNC controls require the last pass to be at a 0° infeed angle because the chip will not break on the last pass. On most carbon and alloy steels, the last pass can remain at .005" (0,127mm) depth of cut and produce an acceptable finish. For some materials, a .001" (0,025mm) to .003" (0,076mm) (spring) pass may be used to improve surface finish, however, chipbreaking action may be compromised.

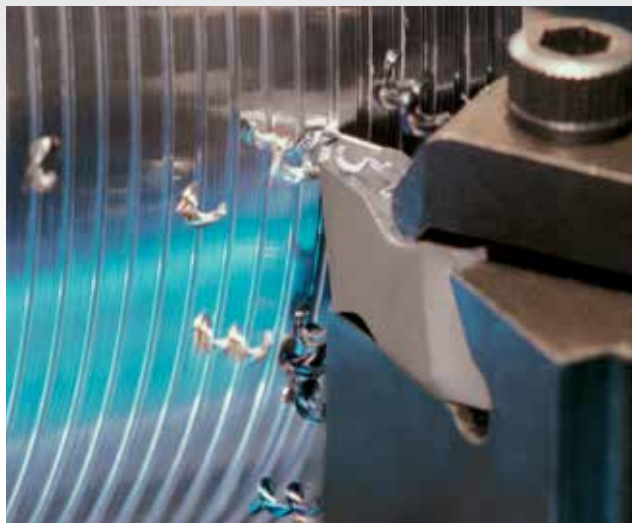

### Machine Programming

Modern CNC controls allow the programmer to easily adjust infeed angle, the number of passes, and depth of cut for each pass. The chip control threading insert performs best at an infeed angle of 29° 30', although 15° to 30° is acceptable. Also, it is important to maintain a minimum of .005" (0,127mm) depth of cut on every pass. In most applications, use of CNC canned cycles produce only marginally successful results. Custom written programs are better and are recommended.

### Infeed Angle

In order to effectively and consistently break the chip, it is important to use an infeed angle between 28° and 29° 30'. Do not apply chip control inserts at infeed angles less than 15°.

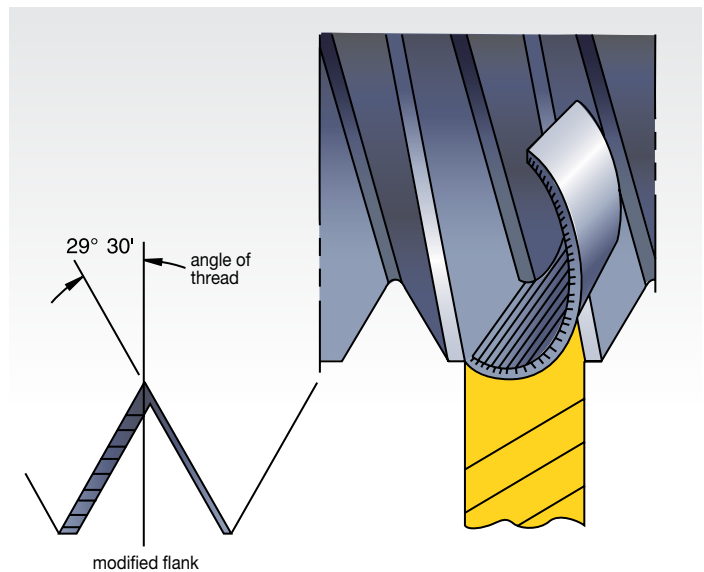

General Machining Guidelines

Radial

modified flank

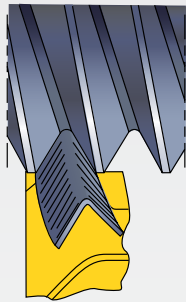
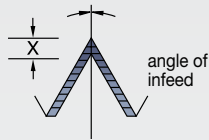

Advantage –

- Cutting on both sides of the thread form places all of the cutting edge in the cut and protects edge from chipping.
- Even wear on the insert.

Disadvantage –

- Tool develops a channel chip that may be difficult to handle.
- Tip chipping occurs when cutting high-tensile materials.
- Bur condition is increased.
- Entire cutting edge is engaged at finish of thread, causing increased tendency to chatter.

Modified flank

modified flank

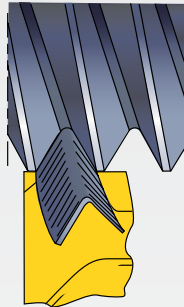
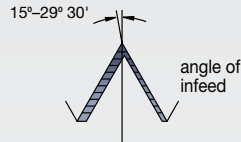

Advantage –

- Tool cuts both sides of thread form, so it is protected from chipping similar to 0° infeed. Channel-type chip develops, but uneven chip thickness helps remove the chip similar to flank infeed.
- This is the preferred method, especially when used with a chip control insert.
- Combined radial and/or alternating flank infeed.
- Results in good tool life, with wear evenly distributed over both flanks.

Disadvantage –

- Similar disadvantages as with 0° infeed, although reduced somewhat in magnitude as cutting forces are better equalized and chip flow is much less of a problem.

Alternating flank

alternating flank

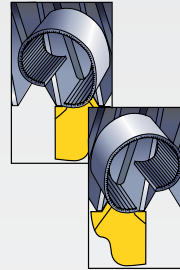
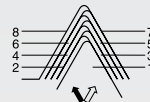

Advantage –

- Increased tool life because both edges are used equally.

NOTE: Some machine tools may require special programming techniques to achieve this method of infeed.

Disadvantage –

- Difficult to cut on conventional machinery.

Reversed modified flank

modified flank

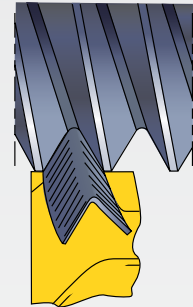
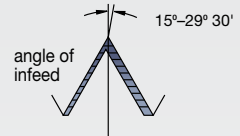

Advantage –

- Tool cuts both sides of thread form, so it is protected from chipping similar to 0° infeed. Channel-type chip develops, but uneven chip thickness helps remove the chip similar to flank infeed.
- This is the preferred method, especially when used with a chip control insert.
- Combined radial and/or alternating flank infeed.
- Results in good tool life, with wear evenly distributed over both flanks.
- As chip flow is the reversed feed direction, it is an excellent choice for internal threading.

Disadvantage –

- Programming needs to be done line by line.

INDEXABLE MILLING

SOLID END MILLING

HOLEMAKING

TAPPING

TURNING

## Threading

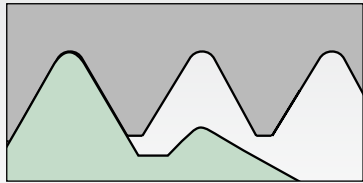
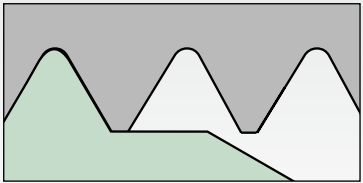
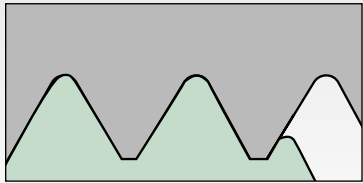
 <p><b>Partial Profile</b></p> <p><b>Tooth profile with universal profile shape:</b></p> <ul style="list-style-type: none"> <li>• Reduced inventory.</li> <li>• For various pitches in a limited range.</li> <li>• Major/minor diameters must be accurately pre-turned.</li> </ul>	 <p><b>Full Profile</b></p> <p><b>Tooth profile with full profile shape including tooth height:</b></p> <ul style="list-style-type: none"> <li>• For bur-free, precise threads in the specified pitch.</li> <li>• General application.</li> <li>• Machining allowance for outside/core diameter around .004–.006".</li> </ul>	 <p><b>Multi-Tooth Profile</b></p> <p><b>Multi-tooth full profile generally with 2–3 teeth:</b></p> <ul style="list-style-type: none"> <li>• Highly productive threading with fewer passes and longer tool life.</li> <li>• Requires a rigid setup and long thread pass through.</li> </ul>
---	--	--

## Formulas

Inch Formula		
to find	given	formula
SFM	D (inch) RPM	$SFM = \frac{\pi \times D}{12"} \times RPM$
RPM	D (inch) SFM	$RPM = \frac{SFM \times 12"}{D \times \pi}$

Metric Formula		
to find	given	formula
m/min	D (mm) RPM	$m/min = \frac{\pi \times D}{1000} \times RPM$
RPM	D (mm) m/min	$RPM = \frac{m/min \times 1000}{D \times \pi}$

## Legend

- IPM = inch per minute
- SFM = surface feet per minute
- m/min = meters per minute
- RPM = revolutions per minute
- D = part diameter
- $\pi$  = 3.1416

## Maximum Cutting Speeds

On older machines cutting speed is often limited by the maximum travel speed (IPM or mm/min) of the tool allowed by the machine. Check your maximum speed with the following formulas:

inch formula: maximum cutting speed (SFM) =  

$$\frac{\text{part diameter (inch)} \times 3.14 \times \text{TPI} \times \text{max IPM}}{12"}$$

metric formula: maximum cutting speed (m/min) =  

$$\frac{\text{part diameter (mm)} \times 3.14 \times (1/\text{pitch}) \times \text{max mm/min}}{1000\text{mm}}$$

## Flank Clearance

- $\gamma$  =  $\arctan(\sin(\beta/2) * \tan(\alpha))$
- g = side (flank) clearance
- $\beta$  = included angle of thread form
- $\alpha$  = radial inclination angle

Thread	Angle	External	Internal
<b>UN &amp; ISO</b>	60	5.3	8
<b>BSW</b>	55	4.8	7.3
<b>TR</b>	30	2.6	4
<b>ACME</b>	29	2.6	3.9
<b>AMBUT</b>	7	.6	.9
<b>AMBUT</b>	45	4	6

## Threading

### Recommendation for Threading Infeed Passes

TPI	48-32	28-24	20-16	14-12	11.5-9	8-6	5-4	3-2
metric pitch (mm)	0,50-0,75	0,80-1	1,25-1,5	1,75-2	2,5-3	3,5-4	4,5-6	8
<b>Thread Type</b>	<b>recommended number of passes</b>							
Common V-thread forms ISO, UN, UNJ, NPT, Whitworth, BSPT, API Rotary Shoulder	4-5	5-6	6-8	8-10	9-12	12-15	14-16	15-25
Acme, Trapez, Round, API Round	—	—	5-6	7-8	10-11	12-13	13-15	18-20
Stub Acme, API Buttress	—	—	5	5-6	7-8	8-10	10-12	14-16
American Buttress	—	—	7-8	9-10	11-12	13-15	17-19	22-24

Maintain minimum .002" (0,05mm) infeed on last passes to avoid work hardening and excessive abrasion of the threading tool.

### Constant Volume Infeed Values for Threading Operations

In most applications, use of CNC canned cycles produces only marginally successful results. For example, an 8-pitch external thread has a depth of .0789" (2mm).

Formula for constant chip load infeed

$$\Delta a_{p_x} = \frac{a_p}{\sqrt{\text{nap}-1}} \cdot \sqrt{\phi}$$

$\Delta a_p$	=	radial infeed
x	=	actual pass (from 1 to the nap)
nap	=	number of passes
$\phi$	=	1st pass, 0,3 2nd pass, 1 3rd pass and up, x-1

### Using Radial Infeed

Bending stress on the cutting edge caused by V-shaped chips from long-chipping steel workpiece materials.

High cutting forces with small cutting thicknesses require sharp edges with high strength.

### Using Flank Infeed

Lower bending stress and stabilized cutting edges produce more favorable chip shapes and larger cutting thicknesses.

Carbides with high hardness, good wear resistance, and temperature stability are advantageous.

## Guidelines for Infeeds —

### How to Determine the Number and the Size of Passes

The number of passes "s" per thread is decisive for successful threading and crest turning. The following tables give standard values for the application condition when machining steel. The proper number of passes must be determined empirically.

If insert breakage occurs, the number of passes must be increased. With increased wear, we recommend decreasing the number of passes. The chip thickness should not be less than .0019" (0,05mm). The allowance at the diameter should not exceed .0078" (0,2mm).

## Threading Infeed Tables

### Metric ISO, External Thread Cutting

thread pitch P (mm)	0,50	0,75	1,00	1,25	1,50	1,75	2,00	2,50	3,00	3,50	4,00	4,50	5,00
<b>T Ap (in)</b>	.012	.018	.024	.030	.036	.042	.048	.060	.072	.085	.097	.109	.121
<b>N Ap</b>	4	4	5	6	6	8	8	10	12	14	15	15	16
values for flank infeed (X/Z)													
order of passes	X/Z	X/Z	X/Z	X/Z	X/Z	X/Z	X/Z	X/Z	X/Z	X/Z	X/Z	X/Z	X/Z
1	0.0038	0.0057	0.0066	0.0073	0.0088	0.0087	0.0099	0.0110	0.0119	0.0129	0.0142	0.0160	0.0171
2	0.0031	0.0047	0.0054	0.0061	0.0073	0.0072	0.0082	0.0090	0.0098	0.0107	0.0117	0.0132	0.0141
3	0.0029	0.0043	0.0050	0.0056	0.0067	0.0066	0.0075	0.0083	0.0090	0.0098	0.0107	0.0121	0.0129
4	0.0022	0.0033	0.0038	0.0043	0.0051	0.0050	0.0058	0.0064	0.0069	0.0075	0.0082	0.0093	0.0099
5			0.0032	0.0036	0.0043	0.0043	0.0049	0.0054	0.0058	0.0063	0.0069	0.0078	0.0084
6				0.0032	0.0038	0.0037	0.0043	0.0047	0.0051	0.0056	0.0061	0.0069	0.0074
7						0.0034	0.0039	0.0043	0.0046	0.0050	0.0055	0.0062	0.0067
8						0.0031	0.0036	0.0039	0.0043	0.0046	0.0051	0.0057	0.0061
9								0.0037	0.0040	0.0043	0.0047	0.0053	0.0057
10								0.0034	0.0037	0.0040	0.0044	0.0050	0.0054
11									0.0035	0.0038	0.0042	0.0047	0.0051
12									0.0034	0.0036	0.0040	0.0045	0.0048
13										0.0035	0.0038	0.0043	0.0046
14										0.0033	0.0037	0.0041	0.0044
15											0.0035	0.0040	0.0043
16													0.0041
<b>T Ap (in)</b>	0.012	0.018	0.024	0.030	0.036	0.042	0.048	0.060	0.072	0.085	0.097	0.109	0.121

NOTE: Always allow .003-.005" extra stock for full profile inserts.

### Metric ISO, Internal Thread Cutting

thread pitch P (mm)	0.50	0.75	1.00	1.25	1.50	1.75	2.00	2.50	3.00	3.50	4.00	4.50	5.00
<b>T Ap</b>	0.011	0.016	0.021	0.027	0.032	0.037	0.043	0.053	0.064	0.075	0.085	0.096	0.107
<b>N Ap</b>	4	4	5	6	6	8	8	10	11	12	14	15	16
values for flank infeed (X/Z)													
order of passes	X/Z	X/Z	X/Z	X/Z	X/Z	X/Z	X/Z	X/Z	X/Z	X/Z	X/Z	X/Z	X/Z
1	0.0035	0.0051	0.0058	0.0066	0.0078	0.0077	0.0089	0.0097	0.0111	0.0124	0.0129	0.0141	0.0151
2	0.0029	0.0042	0.0047	0.0055	0.0065	0.0063	0.0074	0.0080	0.0092	0.0102	0.0107	0.0116	0.0125
3	0.0026	0.0038	0.0043	0.0050	0.0059	0.0058	0.0067	0.0073	0.0084	0.0094	0.0098	0.0106	0.0114
4	0.0020	0.0029	0.0033	0.0038	0.0045	0.0044	0.0052	0.0056	0.0064	0.0072	0.0075	0.0082	0.0088
5			0.0028	0.0032	0.0038	0.0037	0.0044	0.0047	0.0054	0.0061	0.0063	0.0069	0.0074
6				0.0029	0.0034	0.0033	0.0038	0.0042	0.0048	0.0053	0.0056	0.0061	0.0065
7						0.0030	0.0035	0.0038	0.0043	0.0048	0.0050	0.0055	0.0059
8						0.0027	0.0032	0.0035	0.0040	0.0044	0.0046	0.0050	0.0054
9								0.0032	0.0037	0.0041	0.0043	0.0047	0.0050
10								0.0030	0.0035	0.0039	0.0040	0.0044	0.0047
11									0.0033	0.0037	0.0038	0.0042	0.0045
12										0.0035	0.0036	0.0040	0.0043
13											0.0035	0.0038	0.0041
14											0.0033	0.0036	0.0039
15												0.0035	0.0038
16													0.0036
<b>T Ap</b>	0.011	0.016	0.021	0.027	0.032	0.037	0.043	0.053	0.064	0.075	0.085	0.096	0.107

NOTE: Always allow .003-.005" extra stock for full profile inserts.

### Threading Infeed Tables

#### UN Thread, External Thread Cutting

TPI	24	20	18	16	14	12	11	10	9	8	7	6	5
<b>T Ap (in)</b>	0.026	0.031	0.034	0.038	0.036	0.042	0.048	0.060	0.072	0.085	0.097	0.109	0.121
<b>N Ap</b>	5	6	6	7	9	9	10	11	12	13	14	15	16
values for flank infeed (X/Z)													
order of passes	X/Z	X/Z	X/Z	X/Z	X/Z	X/Z	X/Z	X/Z	X/Z	X/Z	X/Z	X/Z	X/Z
1	0.0071	0.0076	0.0083	0.0085	0.0070	0.0081	0.0088	0.0104	0.0119	0.0134	0.0147	0.0160	0.0171
2	0.0059	0.0063	0.0069	0.0070	0.0058	0.0067	0.0072	0.0086	0.0098	0.0111	0.0122	0.0132	0.0141
3	0.0054	0.0057	0.0063	0.0064	0.0053	0.0062	0.0066	0.0079	0.0090	0.0102	0.0111	0.0121	0.0129
4	0.0041	0.0044	0.0048	0.0049	0.0040	0.0047	0.0051	0.0060	0.0069	0.0078	0.0086	0.0093	0.0099
5	0.0035	0.0037	0.0041	0.0042	0.0034	0.0040	0.0043	0.0051	0.0058	0.0066	0.0072	0.0078	0.0084
6		0.0033	0.0036	0.0037	0.0030	0.0035	0.0038	0.0045	0.0051	0.0058	0.0064	0.0069	0.0074
7				0.0033	0.0027	0.0032	0.0034	0.0040	0.0046	0.0052	0.0057	0.0062	0.0067
8					0.0025	0.0029	0.0031	0.0037	0.0043	0.0048	0.0053	0.0057	0.0061
9					0.0023	0.0027	0.0029	0.0035	0.0040	0.0045	0.0049	0.0053	0.0057
10							0.0027	0.0033	0.0037	0.0042	0.0046	0.0050	0.0054
11								0.0031	0.0035	0.0040	0.0044	0.0047	0.0051
12									0.0034	0.0038	0.0042	0.0045	0.0048
13										0.0036	0.0040	0.0043	0.0046
14											0.0038	0.0041	0.0044
15												0.0040	0.0043
16													0.0041
<b>T Ap (in)</b>	0.026	0.031	0.034	0.038	0.036	0.042	0.048	0.060	0.072	0.085	0.097	0.109	0.121

NOTE: Always allow .003-.005" extra stock for full profile inserts.

#### UN Thread, Internal Thread Cutting

TPI	24	20	18	16	14	12	11	10	9	8	7	6	5
<b>T Ap</b>	.023	.027	.030	.034	.039	.045	.049	.054	.060	.068	.077	.090	.108
<b>N Ap</b>	5	6	6	7	8	9	9	10	11	12	13	14	15
values for flank infeed (X/Z)													
order of passes	X/Z	X/Z	X/Z	X/Z	X/Z	X/Z	X/Z	X/Z	X/Z	X/Z	X/Z	X/Z	X/Z
1	0.0063	0.0066	0.0073	0.0076	0.0081	0.0087	0.0095	0.0099	0.0104	0.0112	0.0122	0.0137	0.0158
2	0.0052	0.0055	0.0061	0.0063	0.0067	0.0072	0.0078	0.0081	0.0086	0.0093	0.0101	0.0113	0.0131
3	0.0048	0.0050	0.0056	0.0057	0.0061	0.0066	0.0072	0.0075	0.0079	0.0085	0.0092	0.0103	0.0120
4	0.0037	0.0038	0.0043	0.0044	0.0047	0.0051	0.0055	0.0057	0.0060	0.0065	0.0071	0.0079	0.0092
5	0.0031	0.0032	0.0036	0.0037	0.0039	0.0043	0.0046	0.0048	0.0051	0.0055	0.0060	0.0067	0.0077
6		0.0029	0.0032	0.0033	0.0035	0.0038	0.0041	0.0042	0.0045	0.0048	0.0052	0.0059	0.0068
7				0.0030	0.0031	0.0034	0.0037	0.0038	0.0040	0.0044	0.0047	0.0053	0.0062
8					0.0029	0.0031	0.0034	0.0035	0.0037	0.0040	0.0044	0.0049	0.0057
9						0.0029	0.0032	0.0033	0.0035	0.0037	0.0041	0.0046	0.0053
10								0.0031	0.0033	0.0035	0.0038	0.0043	0.0050
11									0.0031	0.0033	0.0036	0.0041	0.0047
12										0.0032	0.0034	0.0039	0.0045
13											0.0033	0.0037	0.0043
14												0.0031	0.0035
15													0.0039
16													
<b>T Ap</b>	0.023	0.027	0.030	0.034	0.039	0.045	0.049	0.054	0.060	0.068	0.080	0.090	0.108

NOTE: Always allow .003-.005" extra stock for full profile inserts.

INDEXABLE MILLING

SOLID END MILLING

HOLEMAKING

TAPPING

TURNING

## Threading Infeed Tables

### NPT Thread, External, and Internal Machining

TPI	27	18	14	11.5	8
T Ap	0.030	0.044	0.056	0.068	0.098
N Ap	6	8	10	12	14
values for flank infeed (X/Z)					
order of passes	X/Z	X/Z	X/Z	X/Z	X/Z
1	0.0073	0.0091	0.0102	0.0112	0.0149
2	0.0061	0.0075	0.0084	0.0093	0.0123
3	0.0056	0.0069	0.0077	0.0085	0.0113
4	0.0043	0.0053	0.0059	0.0065	0.0086
5	0.0036	0.0045	0.0050	0.0055	0.0073
6	0.0032	0.0039	0.0044	0.0048	0.0064
7		0.0035	0.0040	0.0044	0.0058
8		0.0033	0.0037	0.0040	0.0053
9			0.0034	0.0037	0.0050
10			0.0032	0.0035	0.0047
11				0.0033	0.0044
12				0.0032	0.0042
13					0.0040
14					0.0038
15					
16					
T Ap	0.030	0.044	0.056	0.068	0.098

NOTE: Always allow .003-.005" extra stock for full profile inserts.

### BSPT Thread, External, and Internal Machining

TPI	28	19	14	11
T Ap	0.023	0.034	0.046	0.057
N Ap	5	8	10	12
values for flank infeed (X/Z)				
order of passes	X/Z	X/Z	X/Z	X/Z
1	0.0063	0.0070	0.0084	0.0094
2	0.0052	0.0058	0.0069	0.0078
3	0.0048	0.0053	0.0064	0.0071
4	0.0037	0.0041	0.0049	0.0055
5	0.0031	0.0034	0.0041	0.0046
6		0.0030	0.0036	0.0041
7		0.0027	0.0033	0.0037
8		0.0025	0.0030	0.0034
9			0.0028	0.0031
10			0.0026	0.0029
11				0.0028
12				0.0027
13				
14				
15				
16				
T Ap	0.023	0.034	0.046	0.057

### Trapezoid Thread to DIN 103, External, and Internal Machining

pitch	1.50	2.00	3.00	4.00	5.00
T Ap	0.040	0.049	0.069	0.089	0.108
N Ap	6	8	10	12	14
values for flank infeed (X/Z)					
order of passes	X/Z	X/Z	X/Z	X/Z	X/Z
1	0.0098	0.0101	0.0126	0.0147	0.0164
2	0.0081	0.0084	0.0104	0.0121	0.0135
3	0.0074	0.0077	0.0095	0.0111	0.0124
4	0.0057	0.0059	0.0073	0.0085	0.0095
5	0.0048	0.0050	0.0062	0.0072	0.0080
6	0.0042	0.0044	0.0054	0.0063	0.0071
7		0.0040	0.0049	0.0057	0.0064
8		0.0036	0.0045	0.0053	0.0059
9			0.0042	0.0049	0.0055
10			0.0039	0.0046	0.0051
11				0.0044	0.0049
12				0.0041	0.0046
13					0.0044
14					0.0042
15					
16					
T Ap	0.040	0.049	0.069	0.089	0.108

NOTE: Always allow .003-.005" extra stock for full profile inserts.

### Round Thread to DIN 405, External, and Internal Machining

pitch	10	8	6
T Ap	0.052	0.064	0.085
N Ap	8	10	12
values for flank infeed (X/Z)			
order of passes	X/Z	X/Z	X/Z
1	0.0108	0.0117	0.0140
2	0.0089	0.0096	0.0116
3	0.0081	0.0088	0.0106
4	0.0062	0.0068	0.0081
5	0.0053	0.0057	0.0069
6	0.0046	0.0050	0.0061
7	0.0042	0.0046	0.0055
8	0.0039	0.0042	0.0050
9		0.0039	0.0047
10		0.0037	0.0044
11			0.0042
12			0.0040
13			
14			
15			
16			
T Ap	0.052	0.064	0.085

NOTE: Always allow .003-.005" extra stock for full profile inserts.

### Threading Infeed Tables

#### Whitworth, External, and Internal Thread Cutting

TPI	28	20	19	16	14	12	11	10	9	8	7	6	5
<b>T Ap</b>	0.023	0.032	0.032	0.034	0.040	0.053	0.058	0.064	0.071	0.080	0.091	0.107	0.128
<b>N Ap</b>	5	6	6	8	8	9	9	10	11	12	14	15	16
values for flank infeed (X/Z)													
order of passes	X/Z	X/Z	X/Z	X/Z	X/Z	X/Z	X/Z	X/Z	X/Z	X/Z	X/Z	X/Z	X/Z
1	0.0063	0.0078	0.0078	0.0070	0.0083	0.0103	0.0112	0.0117	0.0123	0.0132	0.0138	0.0157	0.0181
2	0.0052	0.0065	0.0065	0.0058	0.0068	0.0085	0.0093	0.0096	0.0102	0.0109	0.0114	0.0129	0.0149
3	0.0048	0.0059	0.0059	0.0053	0.0063	0.0078	0.0085	0.0088	0.0093	0.0100	0.0105	0.0118	0.0137
4	0.0037	0.0045	0.0045	0.0041	0.0048	0.0060	0.0065	0.0068	0.0071	0.0077	0.0080	0.0091	0.0105
5	0.0031	0.0038	0.0038	0.0034	0.0041	0.0050	0.0055	0.0057	0.0060	0.0065	0.0068	0.0077	0.0089
6		0.0034	0.0034	0.0030	0.0036	0.0044	0.0048	0.0050	0.0053	0.0057	0.0060	0.0068	0.0078
7				0.0027	0.0032	0.0040	0.0044	0.0046	0.0048	0.0051	0.0054	0.0061	0.0071
8				0.0025	0.0030	0.0037	0.0040	0.0042	0.0044	0.0047	0.0050	0.0056	0.0065
9						0.0034	0.0037	0.0039	0.0041	0.0044	0.0046	0.0052	0.0060
10								0.0037	0.0039	0.0041	0.0043	0.0049	0.0057
11									0.0036	0.0039	0.0041	0.0046	0.0054
12										0.0037	0.0039	0.0044	0.0051
13											0.0037	0.0042	0.0049
14											0.0036	0.0040	0.0047
15												0.0039	0.0045
16													0.0043
<b>T Ap</b>	0.023	0.032	0.032	0.034	0.040	0.053	0.058	0.064	0.071	0.080	0.091	0.107	0.128

NOTE: Always allow .003-.005" extra stock for full profile inserts.

#### Multi-Tooth Threads, Internal

type	ISO metric						ISO UN						Whit-	NPT		
	3M	2M	3M	2M	3M	2M	2M	3M	2M	3M	2M	2M	2M	3M	2M	
pitch (mm)	1.0	1.5	1.5	2.0	2.0	3.0	—	—	—	—	—	—	—	—	—	
TPI	—	—	—	—	—	—	16	16	12	12	8	11	11.5	11.5	8	
total depth	.024	.033	.033	.460	.460	.070	.037	.037	.490	.490	.740	.620	.690	.690	.100	
1	.013	.015	.020	.020	.028	.022	.017	.022	.022	.030	.023	.029	.023	.032	.035	
2	.011	.010	.013	.015	.018	.019	.012	.015	.016	.019	.020	.019	.020	.022	.025	
3	—	.008	—	.011	—	.017	.008	—	.011	—	.017	.014	.014	.015	.022	
4	—	—	—	—	—	.012	—	—	—	—	.014	—	.012	—	.018	

#### Recommendations for Steel Workpieces (<300 BHN)

catalog number	insert size	TPI profile	total depth — on radius		
			1st pass	2nd pass	3rd pass
NTC-8R/L8EM	8	8 UN	.048	.064	.079
NTC-8R/L8IM	8	8 UN	.047	.061	.074
NTC-8R/L10EM	8	10 UN	.036	.050	.063
NTC-8R/L10IM	8	10 UN	.035	.048	.060
NTC-8R/L12EM	8	12 UN	.030	.041	.052
NTC-8R/L12IM	8	12 UN	.030	.037	.047
NTC-8R/L14EM	8	14 UN	.027	.037	.044
NTC-8R/L14IM	8	14 UN	.024	.031	.041
NTC-8R/L16EM 8	8	16 UN	.023	.032	.038
NTC-8R/L16IM	8	16 UN	.020	.027	.037
NTC-8R/L18EM	8	18 UN	.019	.026	.034
NTC-8R/L18IM	8	18 UN	.019	.024	.033
NDC-68RDR/L-75M	8	8 round	.058	.065	.073
NDC-61RDR/L-75M	8	10 round	.044	.051	.057
NDC-88RDR/L-75M	8	8 round	.051	.069	.073
NDC-88VR/L-75M	8	8 NPT	.040	.068	.096
NDC-8115VR/L-75M	8	11.5 NPT	.038	.054	.067
NDN-814VR/L-75M	8	14 NPT	.038	.054	.054

NOTE: Always allow .003-.005" extra stock for full profile inserts.



## TopThread™

The following charts list the largest thread pitch that can be applied on internal applications using TopThread threading inserts for 60° V-threading and Acme threading.

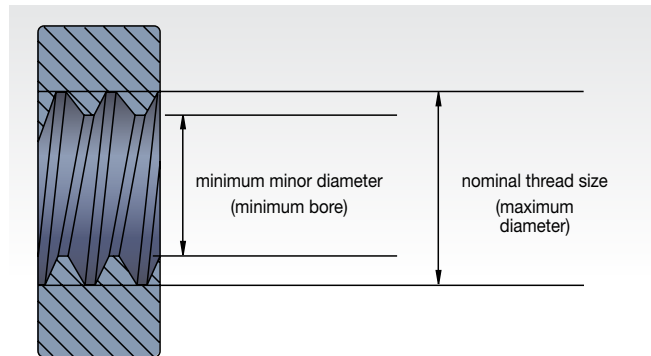

### Inch-Sized 60° V-Threading Limits

internal threading limitations NT-1, NT-2 V-threading inserts

TPI	nominal thread size		minimum minor diameter (inch)	
	NT-1	NT-2	NT-1	NT-2
6	1-7/8	—	1.695	—
7	1-3/4	—	1.595	—
8	1-5/8	—	1.490	—
9	1-9/16	—	1.442	—
10	1-1/2	15/16	1.392	.830
11	1-7/16	15/16	1.339	.830
11-1/2	1-3/8	15/16	1.281	.830
12	1-3/8	9/16	1.285	.472
13	1-5/16	9/16	1.229	.472
14	1-1/4	9/16	1.173	.472
16	1-1/4	9/16	1.182	.472
18	1-1/8	9/16	1.065	.472
20	1-1/8	1/2	1.071	.440
24*	1-1/16	1/2	1.017	.440

\*Twenty-four threads per inch and finer can be cut with an NT-2 insert provided the minor diameter is 1.000" or larger (.440" or larger with NT-1).

internal threading limitations NT-3 and-4 V-threading inserts

TPI	nominal thread size	minimum minor diameter (inch)
4**	3	2.729
4-1/2**	2-7/8	2.634
5	2-3/4	2.534
6	2-1/2	2.320
7	2-1/4	2.095
8	2	1.865
9	1-15/16	1.817
10	1-7/8	1.767
11	1-13/16	1.714
11-1/12	1-3/4	1.656
12	1-3/4	1.660
13	1-5/8	1.542
14	1-9/16	1.485
16*	1-7/16	1.370

\*Sixteen threads per inch and finer can be cut provided minor diameter is 1.370" or larger.

\*\*NT-4 insert only.

### Metric-sized 60° V-Threading Limits

internal threading limitations NT-1, NT-2 60° V-threading inserts

TPI	nominal thread size		minimum thread diameter (inch)	
	NT-1	NT-2	NT-1	NT-2
4,00	M48 x 4.00	—	43,67	—
3,00	M42 x 3.00	—	38,75	—
2,50	M39 x 2.50	M24 x 2,50	36,29	21,29
2,00	M33 x 2.00	M15 x 2,00	30,84	12,84
1,75	M32 x 1.75	M15 x 1,75	30,11	13,11
1,50	M32 x 1.50	M15 x 1,50	30,38	13,38
1,25	M29 x 1.29	M14 x 1,25	27,65	12,65
1,00*	M27 x 1.00	M14 x 1,00	25,92	12,92
0,75	M22 x 0.75	M12 x 0,75	21,19	11,19

\*Thread pitch of 1mm and less can be cut with an NT-2 insert provided the core thread diameter is 25mm or larger (11mm or larger with NT-1).

internal threading limitations NT-3 and NT-4 60° V-threading inserts

TPI	nominal thread size	minimum thread diameter (inch)
6,00**	M76 x 6.00	69,50
5,50**	M73 x 5.50	67,05
5,00	M70 x 5.00	64,59
4,00	M64 x 4.00	59,67
3,00	M52 x 3.00	48,75
2,50	M48 x 2.50	45,29
2,00	M42 x 2.00	39,84
1,75	M40 x 1.75	38,11
1,50*	M38 x 1.50	36,38

\*Thread pitch of 1,5mm and less can be cut provided core thread diameter is 35mm or larger.

\*\*NT-4 insert only.

### Acme Threading Limits

internal threading limitations NA and NAS-2, -3, -4, and -6 Acme threading inserts

TPI	nominal thread size	minimum thread diameter (inch)	
	NT-1	NT-1	NT-2
2**	5	4.500	114.3
2-1/2**	4-1/2	4.100	104.1
3**	4	3.665	93.1
4	3-1/2	3.250	82.6
5	3	2.800	71.1
6	2-1/2	2.333	59.3
8	2-1/4	2.125	54.0
10	2	1.900	48.3
12	1-3/4	1.667	42.4
14	1-5/8	1.554	39.5
16*	1-1/2	1.438	36.5

\*Sixteen threads per inch and finer can be cut provided minor diameter is 36,5mm (1.438") or larger.

\*\*NA-6 insert only.

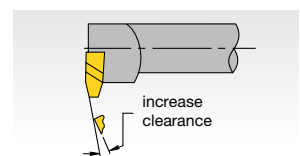

Additional secondary clearance can be ground on leading edge of insert to provide sufficient helical clearance for machining coarser threads and multiple start threads. Modified standard inserts may be furnished for machining threads outside of the limits shown.

TopThread™

60° V-Thread Crest Turning Application Data

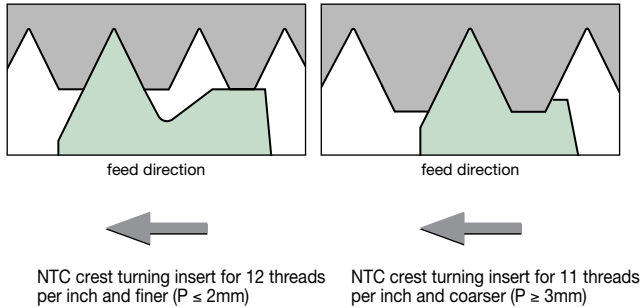

NOTE: NTC inserts automatically control root to crest dimensions. Therefore, in setting up threading operations with NTC inserts, check the O.D. or I.D. at the thread crest for correct dimensions.

60° V-Thread Crest Turning Application Data

insert catalog number	nose radius on insert (inch)	thread radius per MIL-S-8879A (inch)
NJ-3014R/L12	.0125/.0135	.0125/.0150
NJK-3008R/L20	.0075/.0085	.0075/.0090

“J” thread note for catalog

The controlled root radius thread form (SAE8879C) is defined for the external thread only. To machine the corresponding internal thread, choose any insert that will cut a unified class 2B thread, then bore the minor diameter to size. Refer to SAE8879C and MIL-S-8879C and SAEAS8879D for the correct “J” thread minor diameter values.

60° V-Thread Application Data

insert description	insert	D** (inch)	E** (inch)	recommended TPI*		recommended TP*	
				external	internal	external	internal
<p>NT-NTP-</p>	NT-1	.075	.044	-	24-12	-	1,00-2,00
	NT-2	.113	.075	36-8	20-7	0,70-3,00	1,25-3,50
	NT-2-K	.113	.075	36-8	20-7	0,70-3,00	1,25-3,50
	NTF-2	.062	.040	44-14	24-12	0,60-1,75	1,00-2,00
	NTK-2	.062	.040	44-14	24-12	0,60-1,75	1,00-2,00
	NTP-2	.113	.075	36-8	20-7	0,70-3,00	1,25-3,50
	NT-3	.148	.097	20-6	12-5	1,25-4,00	2,00-5,00
	NT-3-K	.148	.097	20-6	12-5	1,25-4,00	2,00-5,00
	NT-3-C	.148	.097	11-6	6 (only)	2,50-4,00	4,00 (only)
	NT-3-CK	.148	.097	11-6	6 (only)	2,50-4,00	4,00 (only)
<p>NTF-NTK-</p>	NTF-3	.083	.054	44-10	24-9	0,60-2,50	1,00-2,50
	NTK-3	.083	.054	44-10	24-9	0,60-2,50	1,00-2,50
	NTP-3	.148	.097	20-6	12-5	1,25-4,00	2,00-5,00
	NT-4	.196	.127	20-4	12-4	1,25-6,25	2,00-6,25
	NT-4-K	.196	.127	20-4	12-4	1,25-6,25	2,00-6,25
	NTP-4	.196	.127	20-4	12-4	1,25-6,25	2,00-6,25

\*Based on maximum insert radius size and class 2A and 2B thread specifications.

## TopThread™

### API Thread Forms • Insert Applications Chart for API Rotary Shouldered Connections

thread form	WIDIA™ insert		tool joint application	minimum box size*
	cresting	non-cresting		
V-.038R 2" TPF 4 TPI	NDC-4038R/L2 4-E/IR4API382	ND-3038R/L	2-3/8 API internal flush 2-7/8 API internal flush 3-1/2 API internal flush 4 API internal flush 4-1/2 API internal flush 5-1/2 API internal flush 6-5/8 API internal flush 4 API full hole API #23, API #26, API #31, API #35, API #38, API #40, API #44, API #46, API #50	API #31 2-7/8 IF
V-.038R 3" TPF 4 TPI	NDC-4038R/L3 4-E/IR4API383	ND-3038R/L	API #56 API #61 API #70 API #77	API #56
V-.050 2" TPF 4 TPI	NDC-4050R/L2 4-E/IR4API502	ND-4050R/L	5-1/2 API full hole 6-5/8 API regular 6-5/8 API full hole	5-1/2 API full hole
V-.050 3" TPF 4 TPI	NDC-4050R/L3 4-E/IR4API503	ND-4050R/L	5-1/2 API regular 7-5/8 API regular 8-5/8 API regular	5-1/2 API regular
V-.040 3" TPF 5 TPI	NDC-3040R/L3 NDC-4040R/L3 4-E/IR5API403	ND-3040R/L ND-4040R/L	2-3/8 API regular 2-7/8 API regular 3-1/2 API regular 4-1/2 API regular	3-1/2 API regular

\*Minimum box size that can be threaded with a standard TopThread insert due to minimum bore equipment.

### API Thread Forms

#### Product Thread Dimensions • Rotary Shouldered Connections (Inch)

threadform	taper inch per ft.	thread height, not truncated H	thread height, truncated $h_n = h_s$	root truncation $S_m = S_{rs}$ $f_m = f_{rs}$	crest truncation $f_{cn} = f_{cs}$	width of flat		root radius $r_m = r_{rs}$	radius at thread corners r	pitch p
						crest $f_{cn} = f_{cs}$	crest $f_m = f_{rs}$			
V-.038R	2	.216005	.121844	.038000	.056161	.065	—	.038	.015	.250
V-.038R	3	.215379	.121381	.038000	.055998	.065	—	.038	.015	.250
V-.040	3	.172303	.117842	.020000	.034461	.040	—	.020	.015	
V-.050	3	.215379	.147303	.025000	.043076	.050	—	.025	.015	.250
V-.050	2	.216005	.147804	.025000	.043201	.050	—	.025	.015	

NOTE: All dimensions in inches.

#### V-.040 and V-.050 Product Thread Form

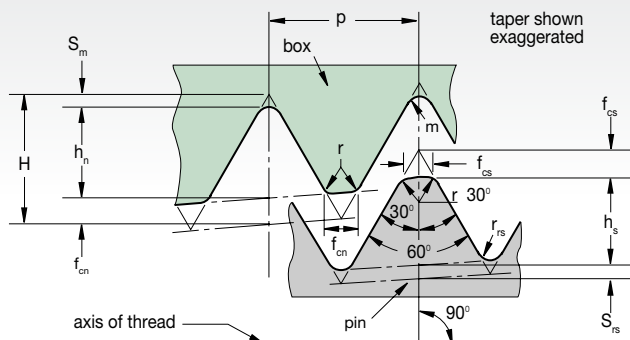

#### Casing and Tubing Round Thread (Height Dimensions)

thread element	10 TPI p= .1000	8 TPI p= .1250
H	= .866p	.08660
$H_s = h_n$	= .626p - .007	.05560
$S_{rs} = S_m$	= .120p + .002	.01400
$S_{cs} = S_{cn}$	= .120p + .005	.01700
		.02000

TopThread™

American Buttress (7° Pressure Flank Leading) NTB-A Inserts • Push Type

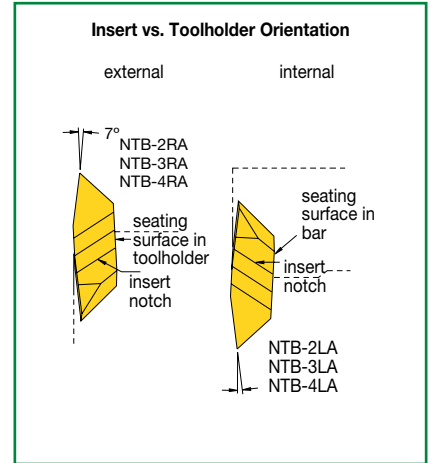
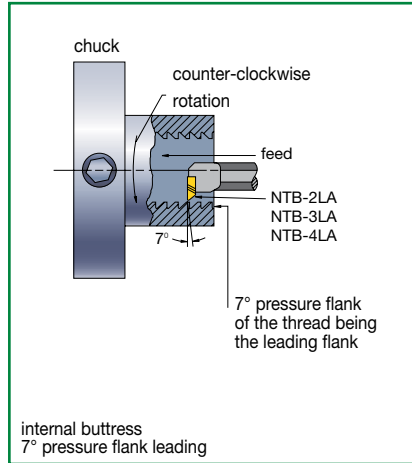
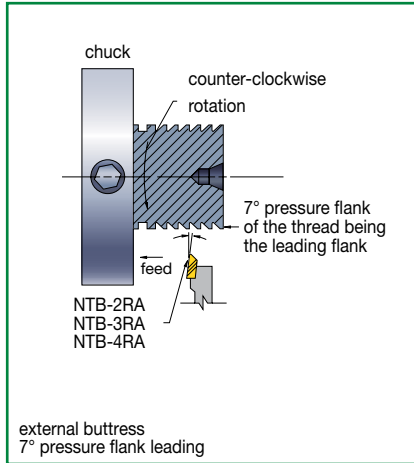

Reference Dimensions

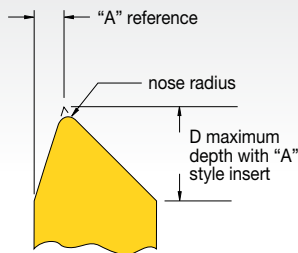

insert	D (inch)	"A" ref. (inch)	nose radius (inch)	pitch based on maximum radius
NTB-2A	.133	.024	.002-.004	16-20 TPI
NTB-3A	.171	.031	.005-.008	8-16 TPI
NTB-4A	.218	.049	.008-.012	4-6 TPI

NOTE: For balanced chip load, 15° infeed angle is suggested.

Infeed Angle vs. Chip Load: 7° Pressure Flank Leading

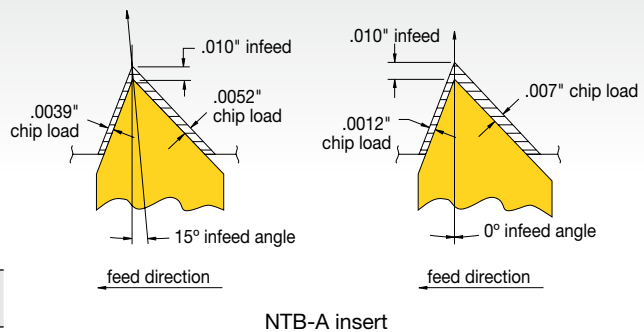

Internal Threading Limitations

internal threading limitations  
NTB-2A Buttress threading inserts

TPI	nominal thread size	minimum minor diameter (inch)
8	1-3/4	1.600
10	1-5/8	1.505
12	1-1/2	1.400
16	1-1/4	1.175
20	1-1/16	1.002

internal threading limitations  
NTB-3 and NTB-4A Buttress threading inserts

TPI	nominal thread size	minimum minor diameter (inch)
4*	2-1/2	2.200
5	2-1/4	2.010
6	2	1.800
8	1-3/4	1.600
10	1-5/8	1.505
12**	1-1/2	1.400

\*NTB-4A insert only.

\*\*Can cut 16 or 20 threads per inch provided minor diameter is 1.375" or larger.

Threads per Inch vs. Maximum Root Radius Chart (Inch)

TPI	20	16	12	10	8	6	5	4	3	2-1/2	2	1-1/2	1-1/4	1
maximum root radius	.0036	.0045	.0059	.0071	.0089	.0119	.0143	.0179	.0238	.0268	.0375	.0476	.0572	.0714

NOTE: Special buttress forms are available upon request.

## TopThread™

### American Buttress (45° Clearance Flank Leading): NTB-B Inserts • Pull Type

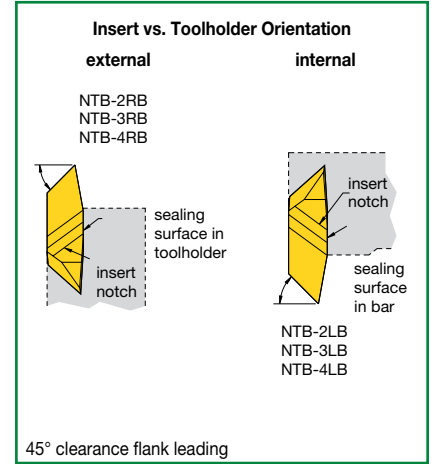
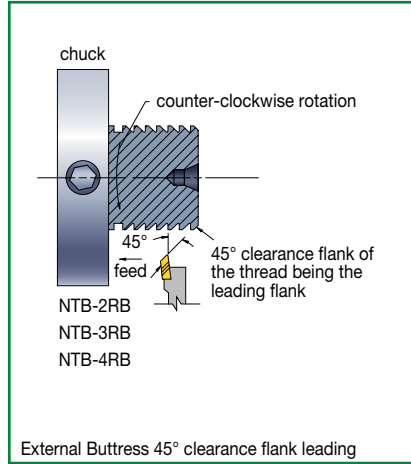
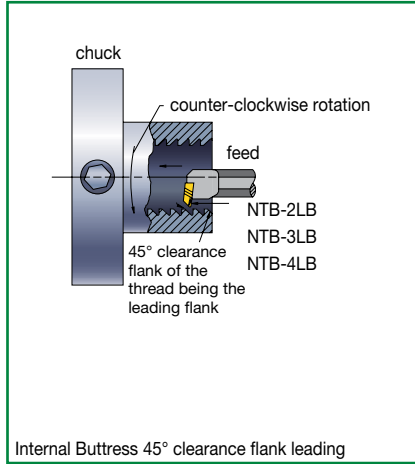

#### Reference Dimensions

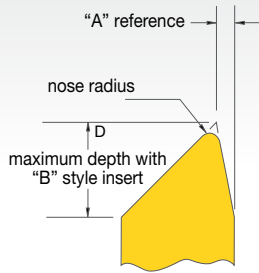

#### Infeed Angle vs. Chip Load: 45° Clearance Flank Leading

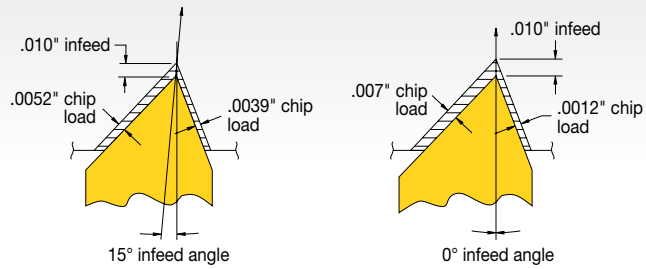

NTB-B insert

insert	D (inch)	"A" reference (inch)	nose radius (inch)	pitch based on maximum radius
NTB-3B	.171	.031	.005-.004	8-16 TPI

NOTE: For balanced chip load, a reverse 15° infeed angle is suggested.

### Internal Threading Limitations

TPI	nominal thread size	minimum minor diameter (inch)
8	1-3/4	1.600
10	1-5/8	1.505
12	1-1/2	1.400
16	1-1/4	1.175
20	1-1/16	1.002

TPI	nominal thread size	minimum minor diameter (inch)
4*	2-7/8	2.575
5	2-3/4	2.510
6	2-3/8	2.175
8	2-1/8	1.975
10	1-7/8	1.755
12	1-5/8	1.525
16	1-1/2	1.407
20	1-7/16	1.378

\*NTB-4B insert only.

## External Laydown Threading

### Required Information

From Part Drawing:

material: 316SS, 200 HB  
 thread form: 8UN  
 tolerance: class 2A  
 operation: external threading  
 pitch diameter: 2.00" x 1.00" deep

From Machine Setup Data:

tooling: .750" x .750"  
 spindle rotation: counter-clockwise  
 feed: toward chuck

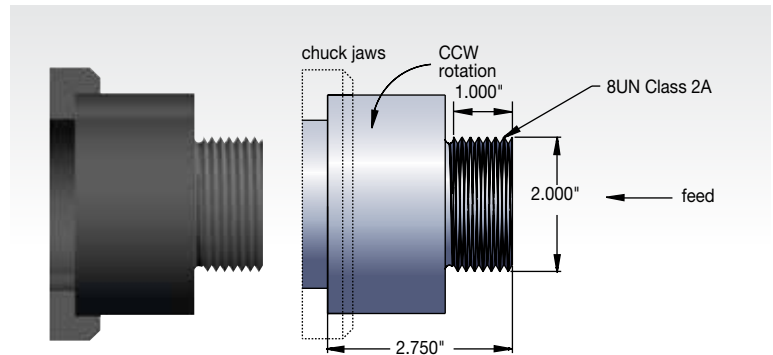

### Steps for a Successful Threading Operation

#### Step 1 • Determine Threading Method

Need to Know:

- Operation (external).
- Spindle rotation (CCW). Counter-clockwise rotation.
- Feed direction (toward chuck).
- Right-hand toolholder.
- Right-hand insert (ER).
- Standard helix method.

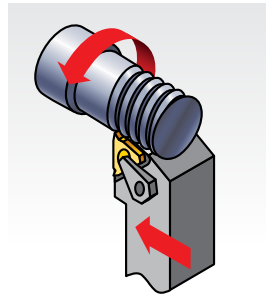

#### Step 2 • Select Insert



Need to Know:

- Thread form (8 UN Class 2A).
- Hand of insert (right hand – ER).

#### Choose the High-Performance Solution

catalog number	insert size	TN6025
3ER8UN	3"	•

#### High-Performance Selection

NOTE: Use insert with largest iC available.

insert: 3ER8UN  
 grade: TN6025  
 speed: 500 SFM

#### Step 3 • Select the Grade and Speed

Need to Know:

- Workpiece material (316SS-200HB).
- Operation (external).

Options: Grade and Speed Selection Guidelines

threading operation	stainless steel
external	general purpose and high performance
	TN6025
	150–450 SFM

#### Step 4 • Select Toolholder

Need to Know:

- External or internal operation (external).
- Pitch diameter to determine minimum bore diameter (N/A).
- Type of tooling – toolholder, boring bar (toolholder).
- Hand of tool (right hand).
- Insert size (3/8").

Options:

catalog number	insert size	shim
LSASR-123	3"	SM-YE3

First choice: LSASR-123 holder

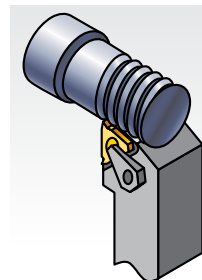

#### Step 5 • Select Shim

Need to Know:

- Thread form – TPI or pitch (8 TPI).
- Pitch diameter (2").
- Helix method (standard). See Laydown Threading (LT) shim selection chart.

Select SM-YE3 shim

NOTE: The SM-YE3 shim is supplied with the selected toolholder.

## Internal Laydown Threading

### Required Information

**From Part Drawing:**

- material: 4140 steel
- thread form: 16 TPI UN
- tolerance: class 2B
- operation: internal threading
- pitch diameter: 1.5" x 2" deep

**From Machine Setup Data:**

- tooling: .075" boring bar
- spindle rotation: clockwise
- feed: away from chuck

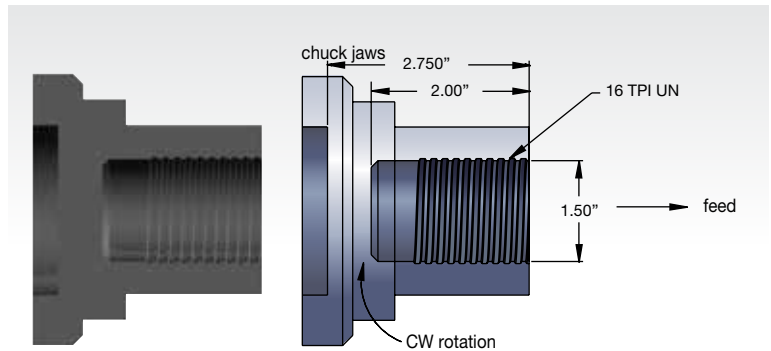

### Steps for a Successful Threading Operation

#### Step 1 • Determine Threading Method

**Need to Know:**

- Operation (internal).
- Spindle rotation (CW). Clockwise rotation.
- Feed direction (away from chuck).
- Left-hand toolholder.
- Left-hand insert (NL).
- Reverse helix method.

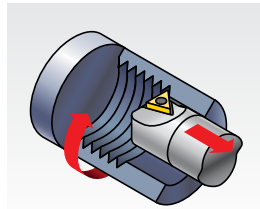

#### Step 2 • Select Insert



**Need to Know:**

- Thread form (16UN Class 2B).
- Hand of insert (left hand – NL).

#### Choose the High-Performance Solution

catalog number	insert size	TN6025
2ILA60	2"	•
3ILA60	3"	•

#### High-Performance Selection

*NOTE: Use insert with largest possible iC to go into the bore.*

insert: 3ILA60  
grade: TN6025  
speed: 450 SFM

#### Step 3 • Select the Grade and Speed

**Need to Know:**

- Workpiece material (4010 steel).
- Operation (internal).

Options: Grade and Speed Selection Guidelines

threading operation	steel
internal	general purpose and high performance
	TN6025
	100–550 SFM

#### Step 4 • Select Toolholder

**Need to Know:**

- External or internal operation (internal).
- Pitch diameter to determine minimum bore diameter for internal operations (1.5").
- Type of tooling – toolholder, boring bar (boring bar).
- Hand of tool (left hand).
- Insert size (3/8").

Options:

catalog number	insert size	minimum bore diameter	shim
S1212-LSEL3	3"	.90	SM-YE3
S0812-LSEL2	2"	.65	–

**First choice: S1212-LSEL3 bar**

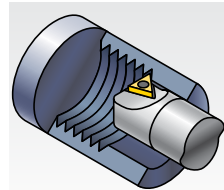

#### Step 5 • Select Shim

**Need to Know:**

- Thread form – TPI or pitch (16 TPI).
- Pitch diameter (1.5").
- Helix method (reverse). See Laydown Threading (LT) shim selection chart.

Select SM-YE3-2N shim

*NOTE: For this application, the standard shim supplied should be replaced with the recommended shim, SM-YE3-2N.*

## Laydown Threading

### Laydown Threading Shim Selection Guidelines

It is essential to select the correct shim to ensure thread quality and maximum tool life. These parameters are needed:

- Pitch
- Pitch diameter
- Number of starts
- Feed direction

NOTE: When considering method of thread cutting, the part's shape and stability and the flow of chips are determining factors in your decision.

### Laydown Selection Chart

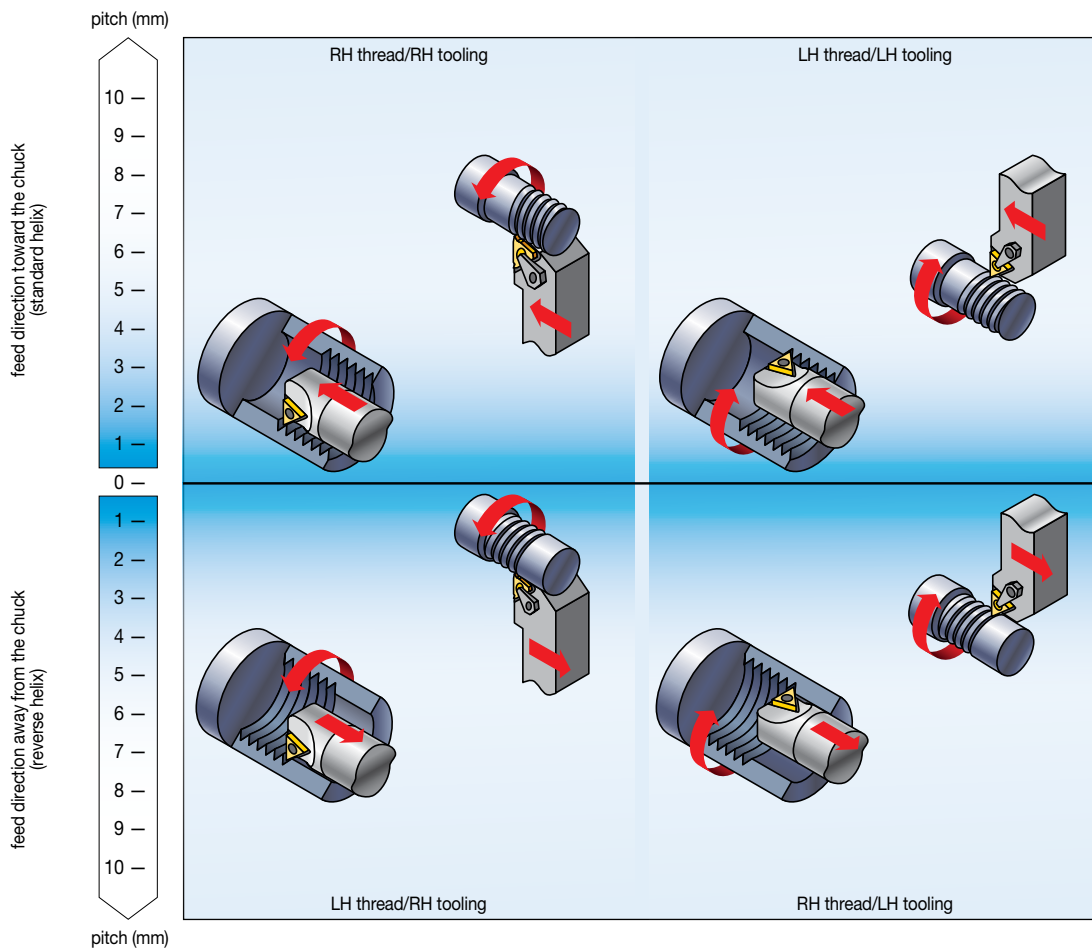

NOTE: For multi-start threads, use the lead value instead of the pitch.

### Diagram of Thread Lead Angles

To calculate the lead angle of a given thread, use this formula:

$$\beta = \text{Arctan} \frac{P \cdot S}{\pi D_e}$$

$\beta$  = thread lead angle  
 $D_e$  = effective pitch diameter of thread wear  
 $P$  = 1/TPI  
 $TPI$  = threads per inch  
 $S$  = number of starts  
 single-start, lead = pitch  
 multiple-start, lead = pitch (x) number of starts

All toolholders are designed with an inclination angle = 1.5°. When turning standard threads with a lead angle of 1–2°, this guarantees adequate clearance at the flanks of the insert's thread tooth. The thread lead angle and the required inclination angle of the insert are given by  $\beta$ .

Cutting edge height is constant at every shim and insert combination. All toolholders are supplied with 1-1/2° lead angle.

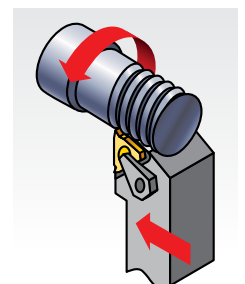



## Laydown Threading

### Laydown Threading Shim Selection Table • Inch

insert size	toolholder		shim ordering code (inch)							
	external	internal				standard				
3 (3/8")	RH	LH	SM-YE3-3P	SM-YE3-2P	SM-YE3-1P	SM-YE3	SM-YE3-1N	SM-YE3-1.5N	SM-YE3-2N	SM-YE3-3N
3 (3/8")	LH	RH	SM-YI3-3P	SM-YI3-2P	SM-YI3-1P	SM-YI3	SM-YI3-1N	SM-YI3-1.5N	SM-YI3-2N	SM-YI3-3N
4 (1/2")	RH	LH	SM-YE4-3P	SM-YE4-2P	SM-YE4-1P	SM-YE4	SM-YE4-1N	SM-YE4-1.5N	SM-YE4-2N	SM-YE4-3N
4 (1/2")	LH	RH	SM-YI4-3P	SM-YI4-2P	SM-YI4-1P	SM-YI4	SM-YI4-1N	SM-YI4-1.5N	SM-YI4-2N	SM-YI4-3N
TPI	pitch (mm)		pitch diameter (inch)							
72	-	-	-	-	-	0.12-0.31	0.32-0.84	>0.84	0.84-0.32	0.31-0.12
-	0,35	-	-	-	-	0.12-0.3	0.31-0.84	>0.84	0.84-0.31	0.3-0.12
64	-	-	-	-	-	0.14-0.35	0.36-0.95	>0.95	0.95-0.36	0.35-0.14
-	0,40	-	-	-	-	0.14-0.35	0.36-0.96	>0.96	0.96-0.36	0.35-0.14
56	-	-	-	-	-	0.16-0.4	0.41-1.09	>1.09	1.09-0.41	0.4-0.16
-	0,50	-	-	-	0.11-0.16	0.17-0.44	0.45-1.2	>1.20	1.2-0.45	0.44-0.17
48	-	-	-	-	0.12-0.17	0.18-0.46	0.47-1.27	>1.27	1.27-0.47	0.46-0.18
44	-	-	-	-	0.13-0.19	0.2-0.51	0.52-1.38	>1.38	1.38-0.52	0.51-0.2
-	0,60	-	0.1-0.12	0.13-0.2	0.21-0.53	0.54-1.44	>1.44	1.44-0.54	0.53-0.21	
40	-	-	0.11-0.13	0.14-0.21	0.22-0.56	0.57-1.52	>1.52	1.52-0.57	0.56-0.22	
-	0,70	-	0.12-0.15	0.16-0.23	0.24-0.62	0.63-1.68	>1.68	1.68-0.63	0.62-0.24	
36	-	-	0.12-0.15	0.16-0.23	0.24-0.62	0.63-1.69	>1.69	1.69-0.63	0.62-0.24	
-	0,75	0.11-0.12	0.13-0.16	0.17-0.25	0.26-0.66	0.67-1.8	>1.80	1.8-0.67	0.66-0.26	
32	-	0.12-0.13	0.14-0.17	0.18-0.26	0.27-0.7	0.71-1.9	>1.90	1.9-0.71	0.7-0.27	
-	0,80	0.12-0.13	0.14-0.17	0.18-0.26	0.27-0.71	0.72-1.91	>1.91	1.91-0.72	0.71-0.27	
28	-	0.14-0.14	0.15-0.19	0.2-0.3	0.31-0.8	0.81-2.17	>2.17	2.17-0.81	0.8-0.31	
27	-	0.14-0.15	0.16-0.2	0.21-0.31	0.32-0.83	0.84-2.25	>2.25	2.25-0.84	0.83-0.32	
-	1,00	0.15-0.16	0.17-0.21	0.22-0.33	0.34-0.89	0.9-2.39	>2.39	2.39-0.9	0.89-0.34	
24	-	0.16-0.17	0.18-0.23	0.24-0.35	0.36-0.94	0.95-2.53	>2.53	2.53-0.95	0.94-0.36	
-	1,25	0.19-0.2	0.21-0.27	0.28-0.42	0.43-1.11	1.12-2.99	>2.99	2.99-1.12	1.11-0.43	
20	-	0.19-0.21	0.22-0.27	0.28-0.42	0.43-1.13	1.14-3.04	>3.04	3.04-1.14	1.13-0.43	
18	-	0.21-0.23	0.24-0.31	0.32-0.47	0.48-1.26	1.27-3.38	>3.38	3.38-1.27	1.26-0.48	
-	1,50	0.22-0.25	0.26-0.33	0.34-0.5	0.51-1.34	1.35-3.59	>3.59	3.59-1.35	1.34-0.51	
16	-	0.24-0.26	0.27-0.35	0.36-0.53	0.54-1.41	1.42-3.8	>3.80	3.8-1.42	1.41-0.54	
-	1,75	0.26-0.29	0.3-0.38	0.39-0.59	0.6-1.56	1.57-4.19	>4.19	4.19-1.57	1.56-0.6	
14	-	0.27-0.3	0.31-0.4	0.41-0.61	0.62-1.62	1.63-4.34	>4.34	4.34-1.63	1.62-0.62	
13	-	0.29-0.32	0.33-0.43	0.44-0.66	0.67-1.74	1.75-4.68	>4.68	4.68-1.75	1.74-0.67	
-	2,00	0.3-0.33	0.34-0.44	0.45-0.67	0.68-1.78	1.79-4.79	>4.79	4.79-1.79	1.78-0.68	
12	-	0.32-0.35	0.36-0.46	0.47-0.71	0.72-1.89	1.9-5.07	>5.07	5.07-1.9	1.89-0.72	
11.5	-	0.33-0.37	0.38-0.49	0.5-0.74	0.75-1.97	1.98-5.29	>5.29	5.29-1.98	1.97-0.75	
11	-	0.34-0.38	0.39-0.51	0.52-0.78	0.79-2.06	2.07-5.53	>5.53	5.53-2.07	2.06-0.79	
-	2,50	0.37-0.42	0.43-0.55	0.56-0.84	0.85-2.23	2.24-5.98	>5.98	5.98-2.24	2.23-0.85	
10	-	0.38-0.42	0.43-0.56	0.57-0.86	0.87-2.27	2.28-6.08	>6.08	6.08-2.28	2.27-0.87	
9	-	0.42-0.47	0.48-0.62	0.63-0.95	0.96-2.52	2.53-6.75	>6.75	6.75-2.53	2.52-0.96	
-	3,00	0.45-0.5	0.51-0.66	0.67-1.02	1.03-2.68	2.69-7.18	>7.18	7.18-2.69	2.68-1.03	
8	-	0.47-0.53	0.54-0.7	0.71-1.08	1.09-2.84	2.85-7.6	>7.60	7.6-2.85	2.84-1.09	
-	3,50	0.52-0.59	0.6-0.77	0.78-1.19	1.2-3.13	3.14-8.38	>8.38	8.38-3.14	3.13-1.2	
7	-	0.524-0.61	0.62-0.8	0.81-1.23	1.24-3.25	3.26-8.68	>8.68	8.68-3.26	3.25-1.24	
-	4,00	0.6-0.67	0.68-0.89	0.9-1.36	1.37-3.58	3.59-9.57	>9.57	9.57-3.59	3.58-1.37	
6	-	0.63-0.71	0.72-0.94	0.95-1.44	1.45-3.79	3.8-10.13	>10.13	10.13-3.8	3.79-1.45	
-	5,00	0.75-0.84	0.85-1.11	1.12-1.7	1.71-4.48	4.49-11.97	>11.97	11.97-4.49	4.48-1.71	
5	-	0.76-0.86	0.87-1.13	1.14-1.73	1.74-4.55	4.56-12.16	>12.16	12.16-4.56	4.55-1.74	
4.5	-	0.84-0.95	0.96-1.26	1.27-1.92	1.93-5.06	5.07-13.51	>13.51	13.51-5.07	5.06-1.93	
-	6,00	0.9-1.01	1.02-1.33	1.34-2.04	2.05-5.37	5.38-14.36	>14.36	14.36-5.38	5.37-2.05	
4	-	0.95-1.07	1.08-1.41	1.42-2.16	2.17-5.69	5.7-15.2	>15.20	15.2-5.7	5.69-2.17	
inclination angle			4.5	3.5	2.5	1.5	0.5	0.0	-0.5	-1.5
			standard helix (feed toward the chuck)				reverse helix (feed away from the chuck)			

1. Select TPI or pitch from the left-hand columns.
2. Follow row to specified pitch diameter and the correct feed direction.
3. Follow the column to the top for the required shim based on the toolholder and insert size.

#### standard helix method:

Used when RH thread is cut with RH tool or LH thread with LH tool.

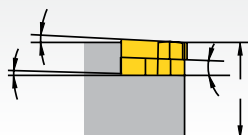

#### reverse helix method:

Used when RH thread is cut with LH tool or when LH thread is cut with RH tool.

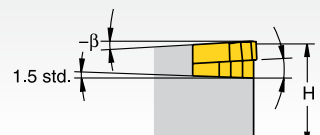



# GET FAST AND RELIABLE ANSWERS TO YOUR TOUGHEST METALCUTTING PROBLEMS.

Our Customer Application Support (CAS) Team is the metalworking industry's leading help desk resource for tooling application solutions and problem resolution.

- Easy access to proven metalworking expertise.
- Service level excellence.
- Best-in-class application support tools and technology.

### Easy access to proven metalworking expertise!

WIDIA™ Customer Application Engineers assist customers and engineering groups throughout the world with expert tool selection and application recommendations for the entire range of WIDIA tooling.

#### Service Level Excellence:

- Fast telephone response.
- Quick technical solutions.
- Efficient case management.

#### Services Provided:

- Tooling selection.
- Operating parameters.
- Troubleshooting.
- Process optimization.
- Hardware support.

#### Best-in-Class Support Tools and Technology:

























- Tooling performance experts.
- Materials database.
- Application calculators.

ORIGINATING COUNTRY	LANGUAGE	TEL	EMAIL
Australia	English	1800 666 667	ap-kmt.techsupport@kennametal.com
Austria	German	0223 63181361	eu.techsupport@widia.com
Belgium	English/French	0279 06 533	eu.techsupport@widia.com
China	Chinese	400-889-2237	w-cn.techsupport@widia.com
Denmark	English	808 89295	na.techsupport@widia.com
Finland	English	0800 919413	na.techsupport@widia.com
France	French	01 60 12 83 30	eu.techsupport@widia.com
Germany	German	06003 8277140	eu.techsupport@widia.com
India	English	1 800 103 5227	in.techsupport@widia.com
Israel	English	03-5562211	na.techsupport@widia.com
Italy	Italian	028 95 96 214	eu.techsupport@widia.com
Japan	English	81-3-4578-9279	ap-kmt.techsupport@kennametal.com
Korea (South)	English	+82 2 21006100	ap-kmt.techsupport@kennametal.com
Malaysia	English	1800 812 990	ap-kmt.techsupport@kennametal.com
Netherlands	English	076 79 95 222	na.techsupport@widia.com
New Zealand	English	0800536626	ap-kmt.techsupport@kennametal.com
Norway	English	800 10081	na.techsupport@widia.com
Poland	Polish	616 656 584	eu.techsupport@widia.com
Russia	Russian	-	eu.techsupport@widia.com
Singapore	English	0800450941	ap-kmt.techsupport@kennametal.com
South Africa	English	+27 11 748 9300	na.techsupport@widia.com
Sweden	English	020798794	na.techsupport@widia.com
Taiwan	English	0800 666 197	ap-kmt.techsupport@kennametal.com
Thailand	English	1800 4417820	ap-kmt.techsupport@kennametal.com
United Kingdom	English	0138 44 08 096	na.techsupport@widia.com
Ukraine	English	-	eu.techsupport@widia.com
USA	English	888 539 5145	na.techsupport@widia.com

## Turning Icons

<p>Shank: KM-TS™ (ISO 26622)</p>	<p>ISO: 26622</p>	<p>Through Coolant: 100 bar</p>	<p>Through Coolant: 1500 psi</p>	<p>Turning</p>
<p>Cut-off</p>	<p>I.D. Turning</p>	<p>I.D. Chamfering</p>	<p>I.D. Grooving</p>	<p>I.D. Face Grooving</p>
<p>I.D. Internal Threading</p>	<p>Profiling</p>	<p>Facing</p>	<p>Face Grooving</p>	<p>Back Boring</p>
<p>Threading</p>	<p>Grooving</p>			

## Indexable Milling Icons

 Countersinking	 Face Milling	 Helical Milling	 Plunge Milling	 Ramping Blank
 Slotting: Ball Nose	 Slotting: Side Milling	 Slotting: Side Milling with AE/AP Dimensions	 Slotting: Square End	 Slotting: T
 Side Milling/Shoulder Milling: Ball Nose	 Side Milling/Shoulder Milling: Square End	 Side Milling: Square End with AE/AP Dimensions	 Chamfer Milling	 Side Milling: Roughing
 3D Profiling	 PCD Tool	 Pocketing	 Plain Shank	 Shell Mill Shank
 Weldon® Shank	 Weldon Shank: 2 Flat	 Screw-On Shank	 Shank	 Through Coolant: Radial: Indexable Milling

## Solid End Milling Icons









































 Plunge Milling	 Ramping Blank	 Slotting: Ball Nose	 Slotting: Ball Nose with AP Dimension	 Slotting: Square End
 Slotting: Square End with AP Dimension	 Trochoidal Milling	 Trochoidal Milling: Ball Nose	 Side Milling/Shoulder Milling: Ball Nose	 Side Milling/Shoulder Milling: Ball Nose with AE/AP Dimension
 Side Milling/Shoulder Milling: Square End	 Side Milling/Shoulder Milling: Square End with AE/AP Dimension	 Chamfer Milling	 Chamfer Milling: Chamfer Milling with AE/AP Dimension	 3D Profiling
 PCD Tool	 HSS-PM Material	 HSS-M42	 Corner Style: Ball Nose	 Corner Style: Corner Chamfer
 Corner Style: Corner Radius	 Corner Style: Square End	 Corner Style: Torus	 Helix Angle: 0°	 Helix Angle: 15°
 Helix Angle: 20°	 Helix Angle: 25°	 Helix Angle: 30°	 Helix Angle: 35°	 Helix Angle: 37°
 Helix Angle: 38°	 Helix Angle: 40°	 Helix Angle: 45°	 Helix Angle: 45°	 Helix Angle: 60°
 Helix Angle: 43°	 DIN 6528	 DIN 844	 DIN 1835/B	 DIN 6527
 Through Coolant: Radial: Drilling	 Through Coolant: Axial: Solid End Mill	 Tool Dimensions: Flute Configuration: X (Variable)	 Tool Dimensions: Flute Configuration: 1	 Tool Dimensions: Flute Configuration: 2
 Tool Dimensions: Flute Configuration: 3	 Tool Dimensions: Flute Configuration: 4	 Tool Dimensions: Flute Configuration: 5	 Tool Dimensions: Flute Configuration: 6	 Tool Dimensions: Flute Configuration: 7
 Manufacturer's Specs: JIS				

## Holemaking Icons

 Countersinking/ Stroke Chamfering	 Drilling	 Chain Drilling	 Drilling: Cross Hole	 Drilling: Half Cylinder
 Drilling: Corner Drilling 45°	 Drilling: Inclined Entry	 Drilling: Inclined Exit	 Drilling: Exit Offset	 Drilling: Stacked Plates
 Drilling: Convex	 Drilled Hole	 Reaming: Through Hole	 Reaming: Blind Hole	 Reaming: Through Cross
 Reaming: Blind and Cross Holes	 Drilling Depth: 3x	 Drilling Depth: 5x	 Drilling Depth: 8x	 Drilling Depth: 12x
 Shank: Cylindrical Plain ≤h6	 Shank: Cylindrical Whistle Notch 2°	 Flat Shank	 Shank: Cylindrical with flat	 KM™ Shank
 Helix Angle 0°	 Helix Angle 30°	 DIN 212	 DIN 6535	 DIN 6537
 Through Coolant: Radial: Drilling	 Through Coolant: Radial: Drilling	 Through Coolant: Radial: Indexable Drilling	 Flood Coolant: Reaming	 Through Coolant: MQL (Minimum Quantity Lubricant): Drilling
 Axial: Drilling	 Through Coolant: Axial Reaming	 Tool Dimensions: 2-Flute/2-Margin/ Coolant	 Tool Dimensions: 2-Flute/4-Margin/ Coolant	



## Tapping Icons

 Tapping: Blind Hole	 Threading: Through Hole	 Threading: Blind Hole	 HSS-E: High-Speed Steel with Cobalt Alloy for Materials with Higher Hardness	 HSS-E-PM: High-Speed Steel with Cobalt Alloy for Materials with Higher Hardness (PM = Power Metal Steel)
 HM: (Carbide)	 Square Shank	 Chamfer Form C (2-3)	 Chamfer Form D (3.5-5)	 Chamfer Form E (1.5-2)
 Plug Chamfer (3-5)	 Tapping Helix: Angle: 0°	 Tapping Helix: Angle: 10°	 Tapping Helix: Angle: L8°	 Tapping Helix: Angle: 15°
 Tapping Helix: Angle: L15°	 Tapping Helix: Angle: 25°	 Tapping Helix: Angle: 30°	 Tapping Helix: Angle: 42°	 Tapping Helix: Angle: 45°
 DIN 371 DIN Number 371	 DIN 374 DIN Number 374	 DIN 2174 DIN Number 2174	 DIN 376 DIN Number 376	 Tapping: Through Coolant
 Flood Coolant: Tapping	 Through Coolant: Axial: Tapping	 ISO 2 ISO 2	 JIS Manufacturer's Specs: JIS	 2B Class of Fit: 2B
 3B Class of Fit: 3B	 6H Class of Fit: 6H	 6HX Class of Fit: 6HX	 6G Class of Fit: 6G	 ANSI ANSI
 UNJC Unified Course Thread: J Profile	 UNJF Unified Fine Thread: J Profile	 UNF Unified Fine Thread	 UNC Unified Course Thread	 M ISO Metric Coarse Thread
 MF ISO Metric Fine Thread				

DIN – German Institute for Standardization

ISO – International Standardization Organization



# ALL-STAR

THE ALL-STAR PROGRAM PROVIDES PROVEN SOLUTIONS THAT ARE EASY TO FIND AND ALWAYS AVAILABLE.

All-Star includes products from our most popular platforms, grades, and sizes grouped into one program and guaranteed to be in stock with same-day shipping on orders placed before 6pm ET.

Visit [widia.com](http://widia.com) to see what products are available for same-day shipping through All-Star.

## Turning



## Tapping



## Holemaking



TO SEE ALL PRODUCT LINES, VISIT OUR DIGITAL RESOURCES



**WIDIA™ Machining Central  
Mobile App**  
Download for iOS or Android™:  
[widia.com/en/featured/  
WidiaMobileApp](http://widia.com/en/featured/WidiaMobileApp)



[www.youtube.com/c/widiatools](http://www.youtube.com/c/widiatools)



[www.linkedin.com/company/widiatools/](http://www.linkedin.com/company/widiatools/)



[www.instagram.com/widiatools/](http://www.instagram.com/widiatools/)



[www.facebook.com/widiatools](http://www.facebook.com/widiatools)

To learn more, visit [widia.com](http://widia.com)



**Proven Solutions**



**Easy to Find**

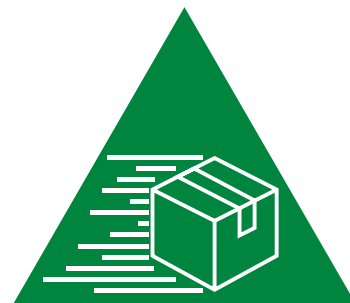

**Always Available**

## **Indexable Milling**



## **Solid End Milling**



# Material Cross Reference • ANSI

<b>P</b> Steel	<b>N</b> Non-Ferrous	<b>H</b> Hardened Materials
<b>M</b> Stainless Steel	<b>S</b> High-Temp Alloys	<b>C</b> CFRP Materials
<b>K</b> Cast Iron		

material group	description	content	tensile strength RM (MPa)*	hardness (HB)	hardness (HRC)	material number
<b>P0</b>	Low-Carbon Steels, Long Chipping	C <0,25%	<530	<125	–	A36, 1008, 1010, 1018 through 1029; 1108, 1117
<b>P1</b>	Low-Carbon Steels, Short Chipping, Free Machining	C <0,25%	<530	<125	–	10L18, 1200 Series, 1213, 12L14
<b>P2</b>	Medium- and High-Carbon Steels	C >0,25%	>530	<220	<25	1035, 1045, 10L45, 1050, 10L50, 1080, 1137, 1144, 11L44, 1525, 1545, 1572
<b>P3</b>	Alloy Steels and Tool Steels	C >0,25%	600–850	<330	<35	1300, 2000, 3000, 4000, 5000, 8000, P20, SAE: A, D, H, O, S, M, T
<b>P4</b>	Alloy Steels and Tool Steels	C >0,25%	850–1400	340–450	35–48	1300, 2000, 3000, 4000, 5000, 8000, P20, SAE: A, D, H, O, S, M, T
<b>P5</b>	Ferritic, Martensitic, and PH Stainless Steels	–	600–900	<330	<35	15–5 PH, 13–8 PH, 17–4 PH, 400 and 500 Series
<b>P6</b>	High-Strength Ferritic, Martensitic, and PH Stainless Steels	–	900–1350	350–450	35–48	15–5 PH, 13–8 PH, 17–4 PH, 400 and 500 Series
<b>M1</b>	Austenitic Stainless Steel	–	<600	130–200	–	200 Series, 301, 302, 304, 304L, 309
<b>M2</b>	High-Strength Austenitic Stainless and Cast Stainless Steels	–	600–800	150–230	<25	310, 316, 316L, 321, 347, 384 ASTM Cast XM-1, XM-5, XM-7, XM-21
<b>M3</b>	Duplex Stainless Steel	–	<800	135–275	<30	323, 329, F55, 2205, S329000
<b>K1</b>	Gray Cast Iron	–	125–500	120–290	<32	class 20, 25, 30, 35, 40, 45, 50, 55, 60, G1800, G3000, G3500, G4000
<b>K2</b>	Low- and Medium-Strength Ductile Irons (Nodular Irons) and Compacted Graphite Irons (CGI)	–	<600	130–260	<28	60-40-18, 65-45-12, 80-55-06; SAE J434: D4018, D4512, D5506; ASTM A47: Grade 32510, 35018; SAE J158: Grade M3210, M4504, M5003, M5503, M7002; ASTM A842: Grade 250, 300, 350, 400, 450
<b>K3</b>	High-Strength Ductile Irons and Austempered Ductile Iron (ADI)	–	>600	180–350	<43	ASTM A536:100-70-03, 120-90-02, SAE J434: D7003, SAE J158: Grade M8501AST A897: 125-80-10, 150-100-7, 175-125-4, 200-150-1, 230-185
<b>N1</b>	Wrought Aluminum	–	–	–	–	2025, 5050, 7050, 1000, 2017
<b>N2</b>	Low-Silicon Aluminum Alloys and Magnesium Alloys	Si <12,2%	–	–	–	2024, 6061, 7075
<b>N3</b>	High-Silicon Aluminum Alloys and Magnesium Alloys	Si >12,2%	–	–	–	–
<b>N4</b>	Copper-, Brass-, Zinc-Based on Machinability Index Range of 70–100	–	–	–	–	C81500
<b>N5</b>	Nylon, Plastics, Rubbers, Phenolics, Resins, Fiberglass	–	–	–	–	–
<b>N6</b>	Carbon, Graphite Composites, CFRP	–	–	–	–	Graphite, CFK, CFRP
<b>N7</b>	Metal Matrix Composites (MMC)	–	–	–	–	C63000
<b>S1</b>	Iron-Based, Heat-Resistant Alloys	–	500–1200	160–260	25–48	A-286, INCOLOY® 800 Series, A608, A567, Discaloy, INVAR®, N-155, 16-25-6, 19-9 DL; Cast: ASTM A-297, A-351, A-567, A-608
<b>S2</b>	Cobalt-Based, Heat-Resistant Alloys	–	1000–1450	250–450	25–48	Haynes® 25 (L605), Haynes 188, J-1570, Stellite™, AiResist 213; Cast: AiResist 13, Haynes 21, MAR-M302, MAR-M509, NASA Co-W-Re, WI-52
<b>S3</b>	Nickel-Based, Heat-Resistant Alloys	–	600–1700	160–450	<48	Astroloy™, Hastelloy® B/C/ C-276 /X, INCONEL® 600 and 700 Series, IN102, INCOLOY 900 Series, Rene 41, Waspalloy, MONEL®, K-500, MAR-M20, NIMONIC®, UDIMET®
<b>S4</b>	Titanium and Titanium Alloys	–	900–1600	300–400	33–48	Pure: Ti 98.8, Ti 98.9, Ti 99.9; Alloyed: Ti 5Al-2.5Sn, Ti6Al-4V, Ti6Al-2Sn-4Zr-2Mo, Ti-3Al-8V-6Cr-4Mo-4Zr, Ti-10V-2Fe-3Al, Ti-13V-11Cr-3Al
<b>H1</b>	Hardened Materials	–	–	–	44–48	Tool Steel H10, H11, H13, D2, D3, 4340, P20
<b>H2</b>	Hardened Materials	–	–	–	48–55	Tool Steel H10, H11, H13, D2, D3, 4340, P20
<b>H3</b>	Hardened Materials	–	–	–	56–60	Tool Steel H10, H11, H13, D2, D3, 4340, P20
<b>H4</b>	Hardened Materials	–	–	–	>60	Tool Steel H10, H11, H13, D2, D3, 4340, P20
<b>C1</b>	CFRP, CFRP/CFRP	–	–	–	–	–
<b>C2</b>	CFRP/Non-Ferrous	–	–	–	–	–
<b>C3</b>	CFRP/High-Temp	–	–	–	–	–
<b>C4</b>	CFRP/Stainless Steel	–	–	–	–	–
<b>C5</b>	CFRP/Non-Ferrous/High-Temp	–	–	–	–	–

<b>P</b>	Steel
<b>M</b>	Stainless Steel
<b>K</b>	Cast Iron

<b>N</b>	Non-Ferrous
<b>S</b>	High-Temp Alloys

<b>H</b>	Hardened Materials
<b>C</b>	CFRP Materials

material group	description	content	tensile strength RM (MPa)*	hardness (HB)	hardness (HRC)	material number
<b>P0</b>	Low-Carbon Steels, Long Chipping	C <0,25%	<530	<125	–	–
<b>P1</b>	Low-Carbon Steels, Short Chipping, Free Machining	C <0,25%	<530	<125	–	C15, Ck22, ST37-2, S235JR, 9SMnPb28, GS38
<b>P2</b>	Medium- and High-Carbon Steels	C >0,25%	>530	<220	<25	ST52, S355JR, C35, GS60, Cf53
<b>P3</b>	Alloy Steels and Tool Steels	C >0,25%	600–850	<330	<35	16MnCr5, Ck45, 21CrMoV5-7, 38SMn28
<b>P4</b>	Alloy Steels and Tool Steels	C >0,25%	850–1400	340–450	35–48	100Cr6, 30CrNiMo8, 42CrMo4, C70W2, S6525, X120Mn12
<b>P5</b>	Ferritic, Martensitic, and PH Stainless Steels	–	600–900	<330	<35	100Cr6, 30CrNiMo8, 42CrMo4, C70W2, S6525, X120Mn12
<b>P6</b>	High-Strength Ferritic, Martensitic, and PH Stainless Steels	–	900–1350	350–450	35–48	X102CrMo17, G-X120Cr29
<b>M1</b>	Austenitic Stainless Steel	–	<600	130–200	–	X5CrNi 18 10, X2CrNiMo 17 13 2, G-X25CrNiSi18 9, X15CrNiSi 20 12
<b>M2</b>	High-Strength Austenitic Stainless and Cast Stainless Steels	–	600–800	150–230	<25	X2CrNiMo 13 4, X5NiCr 32 21, X5CrNiNb 18 10, G-X15CrNi 25-20
<b>M3</b>	Duplex Stainless Steel	–	<800	135–275	<30	X8CrNiMo27 5, X2CrNiMoN22 5 3, X20CrNiSi25 4, G-X40CrNiSi27 4
<b>K1</b>	Gray Cast Iron	–	125–500	120–290	<32	GG15, GG25, GG30, GG40, GTW40
<b>K2</b>	Low- and Medium-Strength Ductile Irons (Nodular Irons) and Compacted Graphite Irons (CGI)	–	<600	130–260	<28	GGG40, GTS35
<b>K3</b>	High-Strength Ductile Irons and Austempered Ductile Iron (ADI)	–	>600	180–350	<43	GGG60, GTW55, GTS65
<b>N1</b>	Wrought Aluminum	–	–	–	–	AlMg1, Al99.5, AlCuMg1, AlCuBiPb, AlMgSi1, AlMgSiPb
<b>N2</b>	Low-Silicon Aluminum Alloys and Magnesium Alloys	Si <12,2%	–	–	–	GAISiCu4, GDAISi10Mg
<b>N3</b>	High-Silicon Aluminum Alloys and Magnesium Alloys	Si >12,2%	–	–	–	G-ALSi12, G-AISi17Cu4, G-AISi21CuNiMg
<b>N4</b>	Copper-, Brass-, Zinc-Based on Machinability Index Range of 70–100	–	–	–	–	CuZn40, Ms60, G-CuSn5ZnPb, CuZn37, CuSi3Mn
<b>N5</b>	Nylon, Plastics, Rubbers, Phenolics, Resins, Fiberglass	–	–	–	–	LEXAN®, Hostalen™, Polystyrol®, MAKROLON®
<b>N6</b>	Carbon, Graphite Composites, CFRP	–	–	–	–	CFK, GFK
<b>N7</b>	Metal Matrix Composites (MMC)	–	–	–	–	–
<b>S1</b>	Iron-Based, Heat-Resistant Alloys	–	500–1200	160–260	25–48	X1NiCrMoCu32 28 7, X12NiCrSi36 16, X5NiCrAlTi31 20, X40CoCrNi20 20
<b>S2</b>	Cobalt-Based, Heat-Resistant Alloys	–	1000–1450	250–450	25–48	Haynes® 188, Stellite™ 6,21,31
<b>S3</b>	Nickel-Based, Heat-Resistant Alloys	–	600–1700	160–450	<48	INCONEL® 690, INCONEL 625, Hastelloy®, NIMONIC® 75
<b>S4</b>	Titanium and Titanium Alloys	–	900–1600	300–400	33–48	Ti1, TiAl5Sn2, TiAl6V4, TiAl4Mo4Sn2
<b>H1</b>	Hardened Materials	–	–	–	44–48	GX260NiCr42, GX330NiCr42, GX300CrNiSi952, GX300CrMo153, Hardox® 400
<b>H2</b>	Hardened Materials	–	–	–	48–55	–
<b>H3</b>	Hardened Materials	–	–	–	56–60	–
<b>H4</b>	Hardened Materials	–	–	–	>60	–
<b>C1</b>	CFRP, CFRP/CFRP	–	–	–	–	–
<b>C2</b>	CFRP/Non-Ferrous	–	–	–	–	–
<b>C3</b>	CFRP/High-Temp	–	–	–	–	–
<b>C4</b>	CFRP/Stainless Steel	–	–	–	–	–
<b>C5</b>	CFRP/Non-Ferrous/High-Temp	–	–	–	–	–



# Find Your Local WIDIA Authorized Distributor

WIDIA™ brand cutting tools are available exclusively through a specialized network of Authorized Distributor partners whom you can count on to deliver much more than products. Our distributors know us, and more importantly, they know you. They know better than anyone in the industry how to put the global power of WIDIA to work for you — in your industry, in your region, and for your business.

WIDIA distributor partners provide technical expertise that you can count on. They will show you how to:

- Significantly reduce cycle time.
- Improve machine tool utilization.
- Achieve measurable productivity improvements.
- Take advantage of proven supply chain solutions.
- Access local inventory and best-in-class technical support.
- Request on-site demonstrations of the latest tooling technology.

And with thousands of turning, milling, holemaking, tapping, and tooling systems products available from WIDIA, you'll find everything you need from one single source.

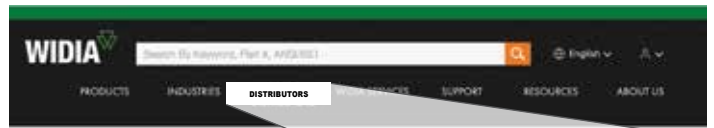

## DISTRIBUTORS

Find your Local WIDIA Authorized Distributor by accessing our distributor finder at [widia.com](http://widia.com).

## IMPORTANT SAFETY INSTRUCTIONS: READ BEFORE USING THE TOOLS IN THIS CATALOG

# METALCUTTING SAFETY

### Projectile and Fragmentation Hazards

Modern metalcutting operations involve high spindle and cutter speeds and high temperatures and cutting forces. Hot metal chips may fly off the workpiece during metalcutting. Although cutting tools are designed and manufactured to withstand high cutting forces and temperatures, they can sometimes fragment, particularly if they are subjected to over-stress, severe impact, or other abuse.

To avoid injury:

- Always wear appropriate personal protective equipment, including safety goggles, when operating metalcutting machines or working nearby.
- Always make sure all machine guards are in place.

For more information, read the applicable Material Safety Data Sheet provided by WIDIA and consult General Industry Safety and Health Regulations, Part 1910, Title 29 of the Code of Federal Regulations.

These safety instructions are general guidelines. Many variables affect machining operations. It is impossible to cover every specific situation. The technical information included in this catalog and recommendations on machining practices may not apply to your particular operation.

For more information, consult the WIDIA Metalcutting Safety booklet, available free from WIDIA at +1 724 539 5747 or fax +1 724 539 5439. For specific product safety and environmental questions, contact our Corporate Environmental Health and Safety Office at +1 724 539 5066 or fax +1 724 539 5372.

### Breathing and Skin Contact Hazards

Grinding carbide or other advanced cutting tool materials produces dust or mist containing metallic particles. Breathing this dust or mist — especially over an extended period — can cause temporary or permanent lung disease or make existing medical conditions worse. Contact with this dust or mist can irritate eyes, skin, and mucous membranes and may make existing skin conditions worse.

To avoid injury:

- Always wear breathing protection and safety goggles when grinding.
- Provide ventilation control and collect and properly dispose of dust, mist, or sludge from grinding.
- Avoid skin contact with dust or mist.

Kennametal, the stylized K, ALUFLASH, CW2015, CW3020, CW5025, ERICKSON, GTD Gun, GUN, Hanita, KM, KM-TS, M100, M370, NOVO, Stellite, SuperFeed, TN6010, TN6025, Top Cut 4, TDMX, TOP DRILL, TOP DRILL M1, TOP DRILL S, TOP DRILL S+, TopGroove, TopThread, TRU-LEDE, VariDrill, VariMill I, VariMill II, VariMill III, VariMill Xtreme, VariTap, Victory, Vision Plus, VSM11, VSM11H, VSM17, VSM22, VSM490, VSM490-10, VSM490-15, VSM890, VSM890-12, VXF, WavCut, WavCut I, WavCut II, WBH10P, WBH20P, WBH30P, WBK40U, WDN00U, WDN25U, WGC, WGC Ranger, WGC Separator, WIDIA, WIDIA-GTD, WK15CM, WK15PD, WM15PD, WMT, WP40PD, WP15PE, WP40PM, WS15PE, WS30PM, WS40PM, WS10PT, WS25PT, WU10HT, WU20PD, WU25PD, WU10PM, WU10PT, X-Feed, and XTREME are trademarks of Kennametal, Inc. and are used as such herein. The absence of a product, service name, or logo from this list does not constitute a waiver of the Kennametal trademark or other intellectual property rights concerning that name or logo.

Alcoa® is a registered trademark of ALCOA, Inc.

Android™ is a trademark of Google LLC.

App Store® is a registered trademark of Apple Inc., registered in the U.S. and other countries.

Astroloy™ is a trademark of Svedala Industries, Inc Corporation.

Facebook™ is a trademark of Meta.

Hardox® is a registered trademark of SSAB Technology AB Corporation.

Hastelloy® and Haynes® are registered trademarks of Haynes International, Inc. Corporation.

Hostalen™ is a trademark of Hoechst GmbH Corporation.

INCOLOY®, INCONEL®, MONEL®, NIMONIC®, and UDIMET® are registered trademarks of Special Metals Corporation.

Instagram™ is a trademark of Meta.

LEXAN® is a registered trademark of Sabic Innovative Plastics IP B.V. Company.

LinkedIn® is a registered trademark of LinkedIn Corporation.

MAKROLON® is a registered trademark of Covestro Deutschland AG.

Polystyrol® is a registered trademark of BASF SE.

Safe-Lock™ is a trademark of Haimer GmbH.

Teflon® is a registered trademark of The Chemours Company FC, LLC

Waspaloy® is a registered trademark of United Technologies Corporation.

Weldon® is a registered trademark of Weldon Tool Company.

YouTube® is a registered trademark of Google LLC.

© Copyright 2022 by Kennametal, Inc., Latrobe, PA 15650. All rights reserved.

**WIDIA** 

# CUTTING TOOLS

---

INCH | 2022

## WORLD HEADQUARTERS

### WIDIA

Kennametal Inc.  
1600 Technology Way  
Latrobe, PA 15650 USA  
Tel: 1 800 979 4342  
w-na.service@widia.com

## EUROPEAN HEADQUARTERS

### WIDIA

Kennametal Europe GmbH  
Rheingoldstrasse 50  
CH 8212 Neuhausen am Rheinfall  
Switzerland  
Tel: +41 52 6750 100  
w-ch.service@widia.com

## ASIA-PACIFIC HEADQUARTERS

### WIDIA

Kennametal (Singapore) Pte. Ltd.  
3A International Business Park  
Unit #01-02/03/05, ICON@IBP  
Singapore 609935  
Tel: +65 6265 9222  
w-sg.service@widia.com

## INDIA HEADQUARTERS

### WIDIA

Kennametal India Limited  
CIN: L27109KA1964PLC001546  
8/9th Mile, Tumkur Road  
Bangalore - 560073  
Tel: +91 80 2839 4321  
w-in.service@widia.com



[widia.com](https://www.widia.com)