

EIGHTH EDITION
FULL-LINE CATALOG

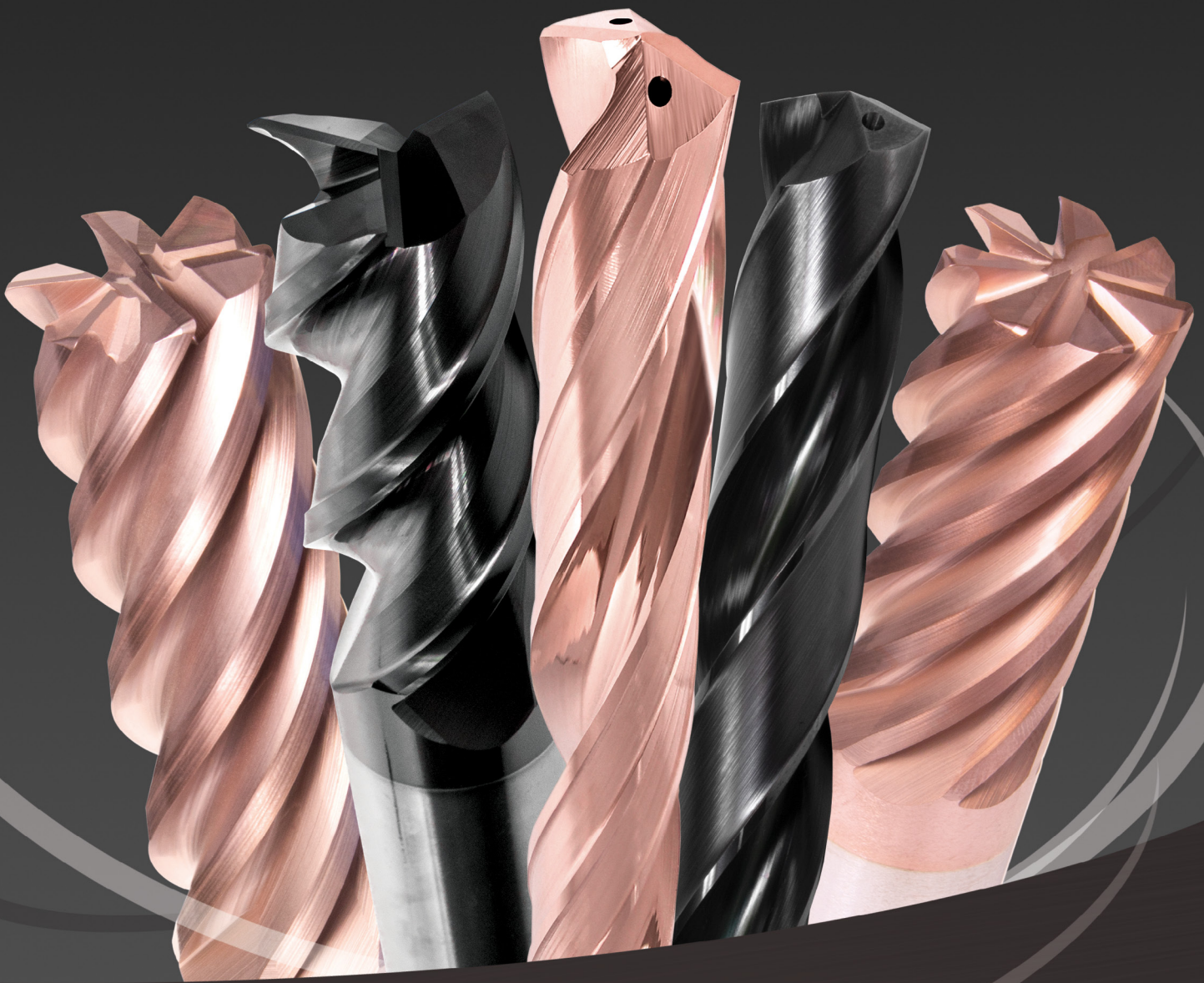

- | Endmills
- | Drills
- | Specials Per Print

PRECISION CUTTING TOOLS
Member IMC Group



INNOVATION

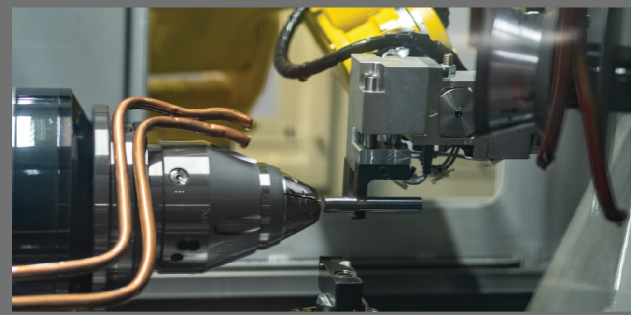

QUALITY

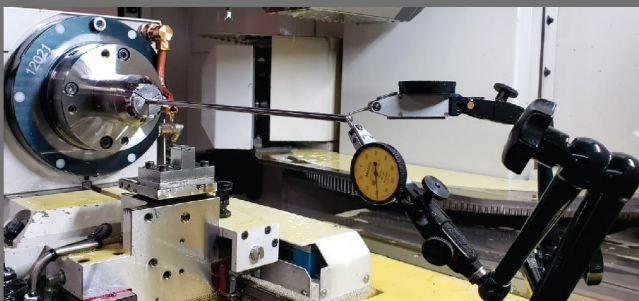
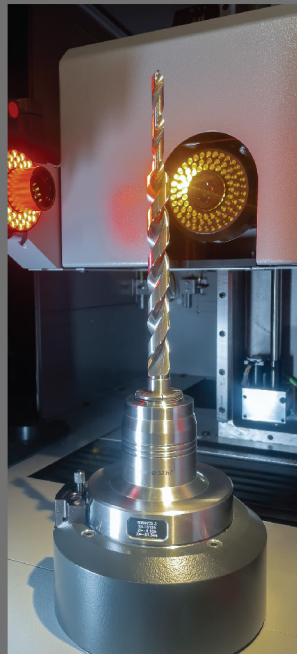

DELIVERY



OVER 50 YEARS
IN THE INDUSTRY

PRECISION CUTTING TOOLS
Member IMC Group



ABOUT PCT

Precision Cutting Tools. (PCT) was founded in 1963 and ever since has specialized in the production of high-quality and high performance cutting tools. Today, with over fifty years of experience, PCT is a leading cutting tool manufacturer that distributes its products all across North America and Europe. We base our company's success on our long-standing commitment to satisfy our customer's needs, by utilizing the finest raw materials, introducing innovative cutting tools and providing excellent customer service. What makes us different from other manufacturers is our pledge to offer the best turnaround times for specials in the industry. While many of our competitors deliver in weeks and months, we deliver it in days.

Precision Cutting Tools was proud to announce in May 2018 that it had become a member of the IMC Group. The partnership between the Sheth Family and the IMC Group continues to operate as an independent brand with our own products and distributor network. PCT moved its operations in late 2020 to a 60,000 square foot facility in La Palma, CA. The new facility allows us to expand our capacity and continue to dedicate ourselves to our core competency of having the best in industry delivery on specials, high performance endmills and long drills.

IN-HOUSE PVD COATING

In 2004, we integrated our own in-house coating facility, to complement our cutting tools and simplify our customers' shopping experience.

SPECIALTIES

Carbide

Endmills | Drills | Specials Per Print

MISSION

Our mission is to satisfy and fulfill the needs of our customers by offering a high performance, high quality tool at a fair price, with the quickest turnaround time in the industry. Through increasing capacity and capabilities by investing in machinery and people, we continue to grow sales while maintaining our delivery times.

VISION

We want the PCT brand to be known for having the quality and performance that you expect from large tool manufacturers, but offer our customers the turnaround time and customer service you expect from a family run company.



MATERIAL CODE

P	1	Low-Carbon Steels - <300 Hb 1018, A36, 12L14
	2	Medium & High Carbon Steels - <300 Hb 1000-1200 Series
	3	Alloy Tool Steels - <300Hb 4130, 4140, 4340, 8620
	4	Alloy Tool Steels - >300Hb A2, P20, S7, H13
	5	Ferritic, Martensitic & PH Stainless Steels - 400's, 15-5, 17-4, Custom 400's
	6	Ferritic, Martensitic & PH Stainless Steels - 400's, pH Types (15-5, 13-8, 17-4) (36-48 HRc)
M	1	Austenitic Stainless Steels - Inox, 200 Series, 300 Series and 304L
	2	Austenitic Stainless Steels & Cast Stainless Steels - 310, 314, 316
	3	Duplex Steels (Austenitic & Ferritic) - 323, 329, F55, 2205
K	1	Gray Cast Iron
	2	Ductile Iron - 60-40-18, 65-45-12 <320 Hb
	3	Ductile Iron - 32510, 35018 >300 Hb
N	1	Wrought Aluminum Alloys 1000-8000 Series, Excludes 4000 Series
	2	High Silicon Aluminum Alloys >12% Si 4000 Series & Castings
	3	Copper, Copper Alloys, Magnesium Alloys - C110, C93200, C95500
	4	Non Metallic ABS, Nylon, Toolboard, Phenolic
S	1	Iron-Based, Heat-Resistant Alloys - A-286, Invar, Discaloy, Incoloy 800-802, Nitronic >200
	2	Cobalt-Based, Heat-Resistant Alloys - Haynes 25, Haynes 188, Stellite, MAR-M302 >180
	3	Nickel-Based, Heat-Resistant Alloys - HAST-C, Rene 41, Waspalloy, Monel, Nimonic, Udimet, INCO 718 >180
	4	Titanium - Ti6AL4V >270
	4	Titanium - Titanium 10-2-3 <390
H	1	Hardened Tool Steels - D2, H13, S7 >360
	2	Hardened Tool Steels - D2, H13, S7 >420
	3	Hardened Tool Steels - D2, H13, S7 >485
	4	Hardened Tool Steels - D2, H13, S7 >560

WHATS NEW

NEW!

NEXT GENERATION ENDMILLS

577 SERIES Endmill

5 Flute Variable Endmill, Eccentric OD for HEM / Dynamic Milling



677 SERIES Endmill

6 Flute Variable Endmill, Eccentric OD for HEM / Dynamic Milling

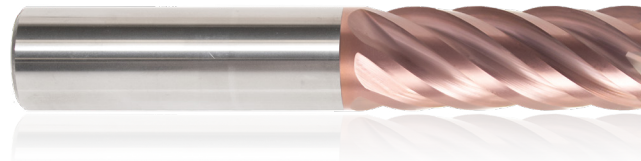

777 SERIES Endmill

7 Flute Variable Endmill, Eccentric OD for HEM / Dynamic Milling

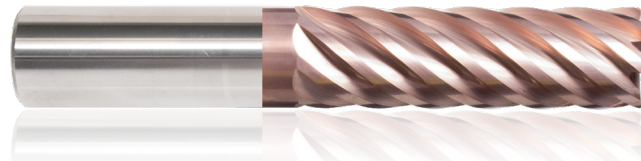

Vulcan Coating

Vulcan® is a PVD coating designed for use on carbide cutting tools, particularly in tough to machine materials. In addition, its high hardness is ideal for High Efficiency machining of hardened steels.

BENEFITS

- High hardness
- Low coefficient of friction
- High oxidation resistance
- Excellent wear resistance
- Increased speeds and feeds
- Suitable for dry, semi-dry & wet machining

EMAIL US

Inquiries : Info@pct-imc.com

Quotes : Quotes@pct-imc.com

Orders : Orders@pct-imc.com

WEBSITE

PCT-IMC.com

Webshop.PCT-IMC.com

CALL US

562-921-7898

HOURS

Monday - Friday

8am - 4:30pm PST

FOLLOW US



@PCTCUTTERS



@PRECISION CUTTING TOOLS

FIND US

We Moved

PCT moved its operations to a 60,000 square foot facility in La Palma, CA.

5572 Fresca Drive, La Palma, CA 90623



Scan the QR Codes for additional information

- Product Literature
- Speeds & Feeds
- Stock & Prices

SERIES AVAILABLE UPON REQUEST



FXC SERIES 2 Flute, Four Margin
5xD - 16xD
130° point angle
N Zircro Plus® Coating



SD SERIES 2 Flute
30° Helix
90°, 120° & 150° point angle
P M K S H N Varianta Supral Coating



337 SERIES 3 Flute
37° Helix
Primary & Secondary
N Exxtral® Carbon Coating



H330 SERIES 3 Flute w/ Coolant Holes
37° Helix
HPM+
N Exxtral® Carbon Coating



429 SERIES 5 & 7 Flute
45° Helix
Medium Pitch Rougher
P M Varianta Supral Coating



430 SERIES 4 & 6 Flute
40° Helix
Negative Rake Angle
S Varianta Supral Coating



423 SERIES 4 Flute
20° Helix
Fine Pitch Rougher
S H Varianta Supral Coating



2060 SERIES 2 Flute
30° Helix
2090 SERIES 60°/ 90° point angle
P M K S H N Varianta Supral Coating

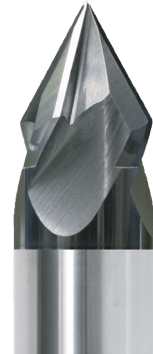

4060 SERIES 4 Flute
30° Helix
4090 SERIES 60°/ 90° point angle
P M K S H N Varianta Supral Coating

PLEASE CONTACT US FOR MORE INFORMATION.

NEW

EDGE CUT™

EdgeCut is a NEW manufacturing process for cutting tools, implemented to provide our customers with superior cutter performance. The EdgeCut process consists of adding a controlled radius on the cutting tool's edge (also known as honing), to create an even and stronger cutting edge. EdgeCut has proven to be a key factor in the success of our cutting tools. Through our extensive testing, cutters with EdgeCut have outperformed tools without any edge preparation.

How does

EDGE CUT™

Improve Performance?

An even and stronger cutting edge...

- Reduces the risk of edge chipping and cracking, resulting in a longer tool life.
- Increases coating adhesion, providing excellent chip evacuation and wear resistance.
- Dissipates stress and force focus, allowing for increased speeds and feeds.
- Provides chatter-free machining, leaving a smooth surface finish on the part.

Before

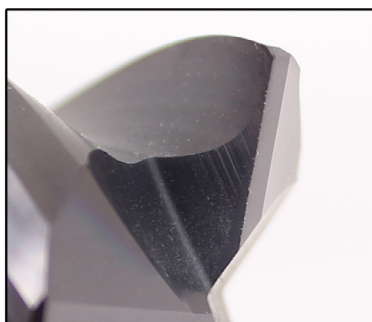

After

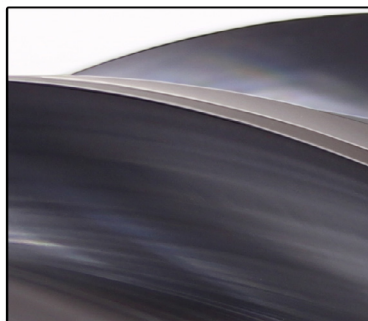
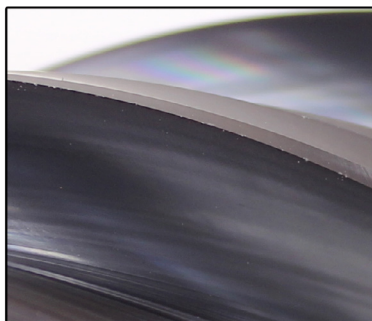
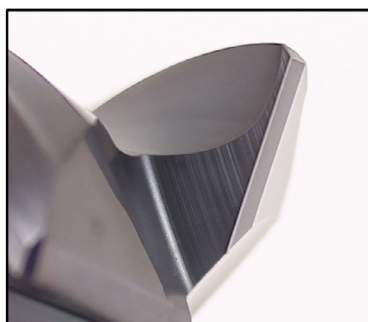

Benefits of

EDGE CUT™

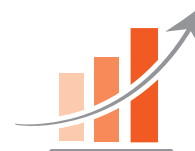

Longer Tool Life



Increased Coating Adhesion

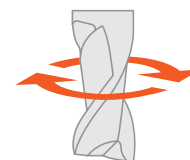

Higher Speeds & Feeds



Improved Surface Finish on the part



Stronger Cutting Edge







Enhanced Chip Evacuation





Reduced Cycle Time

Stronger Edge. Faster Speeds. Longer Life.

ALUMINUM & CAST IRON		*Material	Coolant	Depths	Flutes	Helix	Point	Product Page
		N		3xD-5xD	2	15°	135°	
		N		3xD-50xD	2	15°	135°	
		N K		3xD-5xD	3	30°	130°	
		N K		3xD-5xD	3	30°	130°	
		K		3xD-30xD	2	15°	135°	

HIGH PERFORMANCE/MULTI-PURPOSE		*Material	Coolant	Depths	Flutes	Helix	Point	Product Page
		P M S		3xD-5xD	2	30°	135°	
		P M S		3xD-12xD	2	30°	140°	
		P M S		16xD-50xD	2	30°	135°	

NICKEL-BASED ALLOYS		*Material	Coolant	Depths	Flutes	Helix	Point	Product Page
		S H		3xD-30xD	2	15°	135°	

HARDENED MATERIALS		*Material	Coolant	Depths	Flutes	Helix	Point	Product Page
		P K H		3xD	2	30°	140°	

PILOT DRILLS		*Material	Coolant	Depths	Flutes	Helix	Point	Product Page
		P M K N S		5xD Pilot Drills	2	30°	150°	

**All deep-hole drills 16xD and above must utilize a pilot hole drill

* Material Code refer to page 4

MILLING

ALUMINUM AND NON-FERROUS ALLOYS

FINISHERS	*Material	Flutes	Helix	Product Page
	N	2	45°	
	N	3	45°	
	N	3	45°	
ROUGHERS				
	N	3	37°	
	N	3	45°	
HIGH PERFORMANCE MACHINING +				
	N	2	35°	
	N	3	37°	
FERROUS AND EXOTIC ALLOYS				
HIGH PERFORMANCE - HEM				
	P M K	4	38°	
	P M K S H	4	38°	
	P M K S H	5	35°	
	P M K S H	5	38°	
	P M K S H	6	38°	
	P M K S H	7	40°	
CHIP SPLITTERS				
	P M K	4	38°	

* Material Code refer to page 4





PRECISION CUTTING TOOLS
Member IMC Group

DRILLS

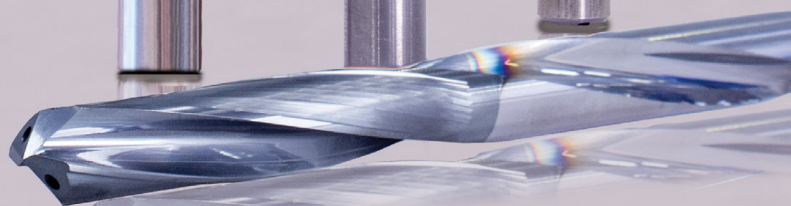



**High Performance
Triple Margin Drill
Non Coolant Thru**
**Ideal for Aluminum and
Non-Ferrous Materials**
3xD-5xD

Refer to page 4



ZircoPlus® provides increased corrosion and abrasion resistance, for maximized machining.



SCAN FOR SPEEDS & FEEDS

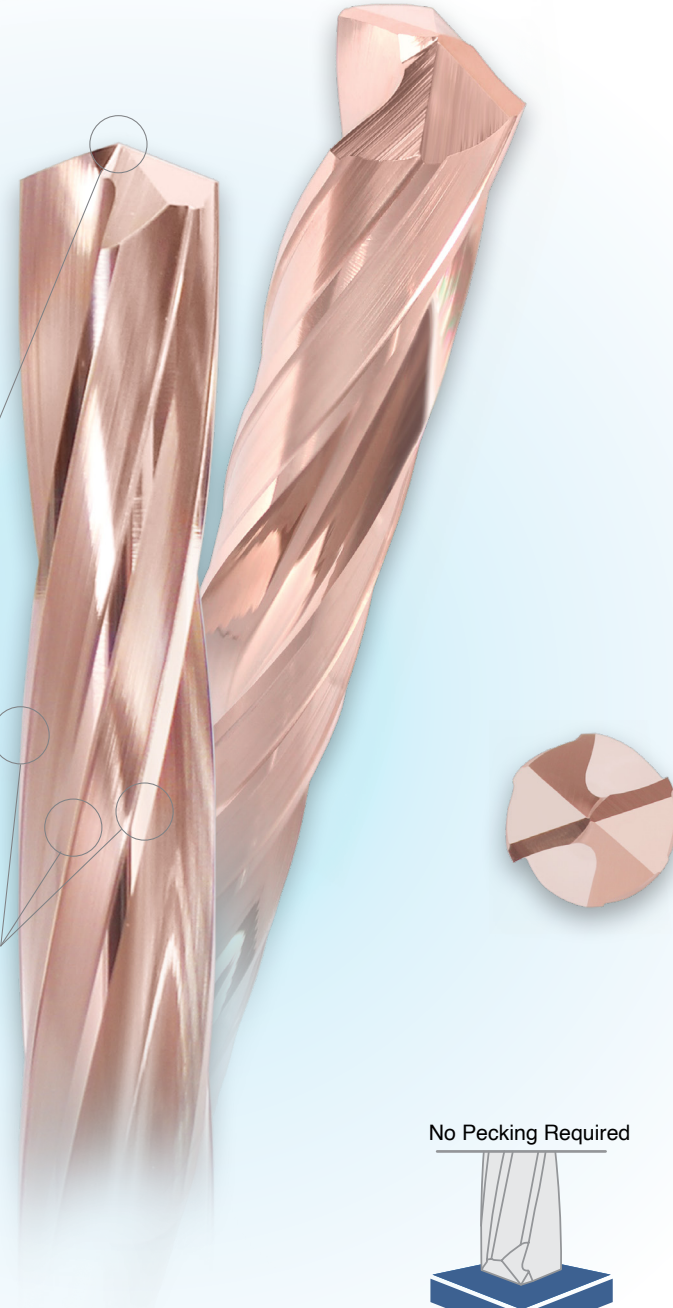

135° Point Geometry - Engineered to provide you with advanced drilling capabilities.

Triple-Margin Design - Ideal for improving surface finish and increasing stability.



No Pecking Required

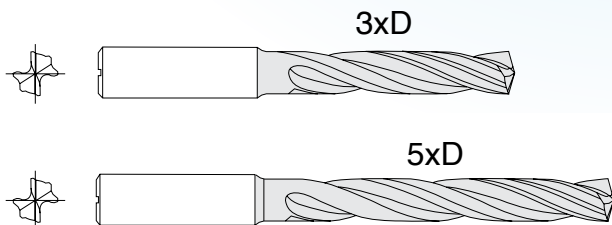
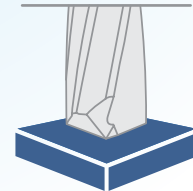

High Performance Drill / 2 Flute / 15° Helix / 135° Point / Non Coolant Thru

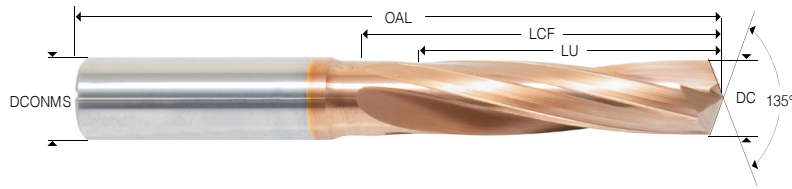

Item Description (Insert 03 or 05 in place of _) *Order Example	**DC Cutting Diameter			DCONMS	3xD Dimensions (mm)				5xD Dimensions (mm)			
	Fraction	Decimal	mm		LU Usable Length	LCF Length Chip Flute	OAL Overall Length	Item Number	LU Usable Length	LCF Length Chip Flute	OAL Overall Length	Item Number
AX0__06250T6	1/16	.0625	1.59	1/8	0.53	5/8	2	9538932	0.66	3/4	2-1/2	9539130
AX0__00520T6	#52	.0635	1.61	1/8	0.59	11/16	2	9538900	0.65	3/4	2-1/2	9539100
AX0__00510T6	#51	.0670	1.70	1/8	0.59	11/16	2	9538899	0.65	3/4	2-1/2	9539099
AX0__00500T6	#50	.0700	1.78	1/8	0.58	11/16	2	9538898	0.77	7/8	2-1/2	9539098
AX0__00490T6	#49	.0730	1.85	1/8	0.58	11/16	2	9538897	0.77	7/8	2-1/2	9539096
AX0__00480T6	#48	.0760	1.93	1/8	0.57	11/16	2	9538896	0.76	7/8	2-1/2	9539095
AX0__07810T6	5/64	.0781	1.98	1/8	0.57	11/16	2	9538948	0.76	7/8	2-1/2	9539140
AX0__00470T6	#47	.0785	1.99	1/8	0.63	3/4	2-1/2	9538895	0.76	7/8	2-1/2	9539094
AX0__07870T6		.0787	2.00	1/8	0.63	3/4	2-1/2	9538949	0.76	7/8	2-1/2	9539141
AX0__00460T6	#46	.0810	2.06	1/8	0.63	3/4	2-1/2	9538894	0.75	7/8	2-1/2	9539093
AX0__00450T6	#45	.0820	2.08	1/8	0.63	3/4	2-1/2	9538893	0.75	7/8	2-1/2	9539092
AX0__00440T6	#44	.0860	2.18	1/8	0.62	3/4	2-1/2	9538892	0.87	1	2-1/2	9539091
AX0__00430T6	#43	.0890	2.26	1/8	0.62	3/4	2-1/2	9538891	0.87	1	2-1/2	9539090
AX0__00420T6	#42	.0935	2.37	1/8	0.61	3/4	2-1/2	9538890	0.86	1	2-1/2	9539089
AX0__09380T6	3/32	.0938	2.38	1/8	0.61	3/4	2-1/2	9538965	0.86	1	2-1/2	9539152
AX0__00410T6	#41	.0960	2.44	1/8	0.67	13/16	2-1/2	9538889	0.86	1	3	9539087
AX0__00400T6	#40	.0980	2.49	1/8	0.67	13/16	2-1/2	9538887	0.85	1	3	9539085
AX0__09840T6		.0984	2.50	1/8	0.66	13/16	2-1/2	9538974	1.10	1-1/4	3	9539156
AX0__00390T6	#39	.0995	2.53	1/8	0.66	13/16	2-1/2	9538886	1.10	1-1/4	3	9539084
AX0__00380T6	#38	.1015	2.58	1/8	0.66	13/16	2-1/2	9538884	1.10	1-1/4	3	9539083
AX0__00370T6	#37	.1040	2.64	1/8	0.66	13/16	2-1/2	9538883	1.09	1-1/4	3	9539082
AX0__00360T6	#36	.1065	2.71	1/8	0.65	13/16	2-1/2	9538882	1.09	1-1/4	3	9539081
AX0__01094T6	7/64	.1094	2.78	1/8	0.65	13/16	2-1/2	9538901	1.09	1-1/4	3	9539104
AX0__00350T6	#35	.1100	2.79	1/8	0.71	7/8	2-1/2	9538881	1.09	1-1/4	3	9539080
AX0__00340T6	#34	.1110	2.82	1/8	0.71	7/8	2-1/2	9538880	1.08	1-1/4	3	9539079
AX0__00330T6	#33	.1130	2.87	1/8	0.71	7/8	2-1/2	9538879	1.08	1-1/4	3	9539077
AX0__00320T6	#32	.1160	2.95	1/8	0.70	7/8	2-1/2	9538878	1.08	1-1/4	3	9539076
AX0__03000T6		.1181	3.00	1/8	0.70	7/8	2-1/2	9538908	1.07	1-1/4	3	9539107
AX0__00310T6	#31	.1200	3.05	1/8	0.70	7/8	2-1/2	9538877	1.07	1-1/4	3	9539075
AX0__03175T6	1/8	.1250	3.18	1/8	0.69	7/8	2-1/2	9538909	1.06	1-1/4	3	9539108
AX0__00300T6	#30	.1285	3.26	3/16	0.74	15/16	2-1/2	9538876	1.06	1-1/4	3	9539074
AX0__00290T6	#29	.1360	3.45	3/16	0.73	15/16	2-1/2	9538875	1.17	1-3/8	3	9539073
AX0__03500T6		.1378	3.50	3/16	0.73	15/16	2-1/2	9538911	1.17	1-3/8	3	9539112
AX0__00280T6	#28	.1405	3.57	3/16	0.73	15/16	2-1/2	9538874	1.16	1-3/8	3	9539072
AX0__03570T6	9/64	.1406	3.57	3/16	0.79	1	2-1/2	9538912	1.16	1-3/8	3	9539113
AX0__00270T6	#27	.1440	3.66	3/16	0.78	1	2-1/2	9538873	1.16	1-3/8	3	9539071
AX0__00260T6	#26	.1470	3.73	3/16	0.78	1	2-1/2	9538872	1.15	1-3/8	3	9539070
AX0__00250T6	#25	.1495	3.80	3/16	0.78	1	2-1/2	9538871	1.15	1-3/8	3	9539069
AX0__00240T6	#24	.1520	3.86	3/16	0.77	1	2-1/2	9538870	1.15	1-3/8	3	9539068
AX0__00230T6	#23	.1540	3.91	3/16	0.77	1	2-1/2	9538869	1.14	1-3/8	3	9539067
AX0__03970T6	5/32	.1562	3.97	3/16	0.77	1	2-1/2	9538915	1.14	1-3/8	3	9539115
AX0__00220T6	#22	.1570	3.99	3/16	0.83	1-1/16	2-1/2	9538868	1.14	1-3/8	3	9539066
AX0__04000T6		.1575	4.00	3/16	0.83	1-1/16	2-1/2	9538916	1.14	1-3/8	3	9539116
AX0__00210T6	#21	.1590	4.04	3/16	0.82	1-1/16	2-1/2	9538867	1.14	1-3/8	3	9539065
AX0__00200T6	#20	.1610	4.09	3/16	0.82	1-1/16	2-1/2	9538865	1.13	1-3/8	3	9539064
AX0__04200T6	4.2	.1654	4.20	3/16	0.81	1-1/16	2-1/2	9538917	1.38	1-5/8	4	9539117
AX0__00190T6	#19	.1660	4.22	3/16	0.81	1-1/16	2-1/2	9538864	1.38	1-5/8	4	9539063
AX0__00180T6	#18	.1695	4.31	3/16	0.81	1-1/16	2-1/2	9538863	1.37	1-5/8	4	9539062
AX0__04370T6	11/64	.1719	4.37	3/16	0.80	1-1/16	2-1/2	9538918	1.37	1-5/8	4	9539118
AX0__00170T6	#17	.1730	4.39	3/16	0.87	1-1/8	3	9538862	1.37	1-5/8	4	9539061
AX0__00160T6	#16	.1770	4.50	3/16	0.86	1-1/8	3	9538861	1.36	1-5/8	4	9539060
AX0__04500T6	4.5	.1772	4.50	3/16	0.86	1-1/8	3	9538920	1.36	1-5/8	4	9539120
AX0__00150T6	#15	.1800	4.57	3/16	0.86	1-1/8	3	9538860	1.36	1-5/8	4	9539059
AX0__00140T6	#14	.1820	4.62	3/16	0.85	1-1/8	3	9538859	1.35	1-5/8	4	9539058
AX0__00130T6	#13	.1850	4.70	3/16	0.85	1-1/8	3	9538858	1.35	1-5/8	4	9539057

***Order Example**

AX0__06250T6 > 3xD >>> AX00306250T6

AX0__00520T6 > 5xD >>> AX00500520T6

**Other Dimensions are Available Upon Request

CARBIDE DRILLS

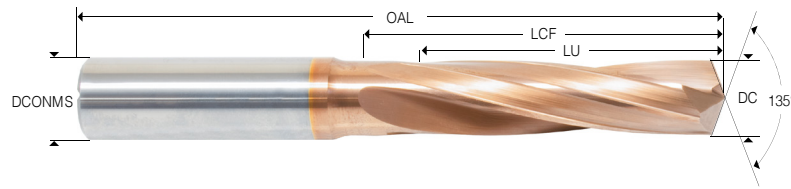

Item Description (Insert 03 or 05 in place of _) *Order Example	**DC Cutting Diameter			DCONMS	3xD Dimensions (mm)				5xD Dimensions (mm)			
	Fraction	Decimal	mm		LU Usable Length	LCF Length Chip Flute	OAL Overall Length	Item Number	LU Usable Length	LCF Length Chip Flute	OAL Overall Length	Item Number
AXO_ _04760T6	3/16	.1875	4.76	3/16	0.84	1-1/8	3	9538922	1.34	1-5/8	4	9539121
AXO_ _00120T6	#12	.1890	4.80	1/4	0.90	1-3/16	3	9538857	1.34	1-5/8	4	9539056
AXO_ _00110T6	#11	.1910	4.85	1/4	0.90	1-3/16	3	9538856	1.34	1-5/8	4	9539055
AXO_ _00100T6	#10	.1935	4.91	1/4	0.90	1-3/16	3	9538855	1.33	1-5/8	4	9539054
AXO_ _00090T6	#9	.1960	4.98	1/4	0.89	1-3/16	3	9538828	1.46	1-3/4	4	9539028
AXO_ _05000T6		.1969	5.00	1/4	0.89	1-3/16	3	9538923	1.45	1-3/4	4	9539122
AXO_ _00080T6	#8	.1990	5.05	1/4	0.89	1-3/16	3	9538827	1.45	1-3/4	4	9539027
AXO_ _05100T6		.2008	5.10	1/4	0.89	1-3/16	3	9538924	-	-	-	-
AXO_ _00070T6	#7	.2010	5.11	1/4	0.89	1-3/16	3	9538825	1.45	1-3/4	4	9539026
AXO_ _05160T6	13/64	.2031	5.16	1/4	0.88	1-3/16	3	9538925	1.45	1-3/4	4	9539124
AXO_ _00060T6	#6	.2040	5.18	1/4	0.94	1-1/4	3	9538823	1.44	1-3/4	4	9539025
AXO_ _00050T6	#5	.2055	5.22	1/4	0.94	1-1/4	3	9538822	1.44	1-3/4	4	9539024
AXO_ _00040T6	#4	.2090	5.31	1/4	0.94	1-1/4	3	9538820	1.44	1-3/4	4	9539023
AXO_ _00030T6	#3	.2130	5.41	1/4	0.93	1-1/4	3	9538819	1.43	1-3/4	4	9539022
AXO_ _02165T6		.2165	5.50	1/4	0.93	1-1/4	3	9538905	1.43	1-3/4	4	9539105
AXO_ _05560T6	7/32	.2188	5.56	1/4	0.92	1-1/4	3	9538927	1.42	1-3/4	4	9539125
AXO_ _00020T6	#2	.2210	5.61	1/4	0.92	1-1/4	3	9538817	1.42	1-3/4	4	9539021
AXO_ _00010T6	#1	.2280	5.79	1/4	0.91	1-1/4	3	9538816	1.41	1-3/4	4	9539020
AXO_ _000A0T6	A	.2340	5.94	1/4	0.90	1-1/4	3	9538829	1.65	2	4	9539029
AXO_ _05950T6	15/64	.2344	5.95	1/4	0.90	1-1/4	3	9538929	1.65	2	4	9539127
AXO_ _06000T6		.2362	6.00	1/4	1.02	1-3/8	3	9538930	1.65	2	4	9539128
AXO_ _000B0T6	B	.2380	6.05	1/4	1.02	1-3/8	3	9538830	1.64	2	4	9539030
AXO_ _000C0T6	C	.2420	6.15	1/4	1.01	1-3/8	3	9538831	1.64	2	4	9539031
AXO_ _000D0T6	D	.2460	6.25	1/4	1.01	1-3/8	3	9538832	1.63	2	4	9539032
AXO_ _06350T6	1/4/E	.2500	6.35	1/4	1.00	1-3/8	3	9538933	1.63	2	4	9539132
AXO_ _06500T6		.2559	6.50	5/16	1.05	1-7/16	3	9538938	1.62	2	4	9539134
AXO_ _000F0T6	F	.2570	6.53	5/16	1.05	1-7/16	3	9538833	1.61	2	4	9539033
AXO_ _000G0T6	G	.2610	6.63	5/16	1.05	1-7/16	3	9538834	1.73	2-1/8	4	9539034
AXO_ _06750T6	17/64	.2656	6.75	5/16	1.04	1-7/16	3	9538939	1.73	2-1/8	4	9539135
AXO_ _000H0T6	H	.2660	6.76	5/16	1.10	1-1/2	3	9538835	1.73	2-1/8	4	9539035
AXO_ _000I0T6	I	.2720	6.91	5/16	1.09	1-1/2	3	9538836	1.72	2-1/8	4	9539036
AXO_ _07000T6		.2756	7.00	5/16	1.09	1-1/2	3	9538941	1.71	2-1/8	4	9539136
AXO_ _000J0T6	J	.2770	7.04	5/16	1.08	1-1/2	3	9538837	1.71	2-1/8	4	9539037
AXO_ _000K0T6	K	.2810	7.14	5/16	1.08	1-1/2	3	9538838	1.70	2-1/8	4	9539038
AXO_ _07140T6	9/32	.2812	7.14	5/16	1.08	1-1/2	3	9538943	1.70	2-1/8	4	9539137
AXO_ _000L0T6	L	.2900	7.37	5/16	1.13	1-9/16	4	9538839	1.69	2-1/8	4	9539039
AXO_ _000M0T6	M	.2950	7.49	5/16	1.12	1-9/16	4	9538840	1.93	2-3/8	4	9539040
AXO_ _07500T6		.2953	7.50	5/16	1.12	1-9/16	4	9538946	1.93	2-3/8	4	9539138
AXO_ _07540T6	19/64	.2969	7.54	5/16	1.12	1-9/16	4	9538947	1.93	2-3/8	4	9539139
AXO_ _000N0T6	N	.3020	7.67	5/16	1.17	1-5/8	4	9538842	1.92	2-3/8	4	9539041
AXO_ _07940T6	5/16	.3125	7.94	5/16	1.16	1-5/8	4	9538950	1.91	2-3/8	4	9539142
AXO_ _08000T6		.3150	8.00	3/8	1.22	1-11/16	4	9538951	1.90	2-3/8	4	9539143
AXO_ _000O0T6	O	.3160	8.03	3/8	1.21	1-11/16	4	9538843	1.90	2-3/8	4	9539042
AXO_ _000P0T6	P	.3230	8.20	3/8	1.20	1-11/16	4	9538844	1.89	2-3/8	4	9539043
AXO_ _08330T6	21/64	.3281	8.33	3/8	1.20	1-11/16	4	9538957	2.01	2-1/2	5	9539145
AXO_ _000Q0T6	Q	.3320	8.43	3/8	1.19	1-11/16	4	9538845	2.00	2-1/2	5	9539044
AXO_ _08500T6		.3346	8.50	3/8	1.19	1-11/16	4	9538958	2.00	2-1/2	5	9539146
AXO_ _000R0T6	R	.3390	8.61	3/8	1.18	1-11/16	4	9538846	1.99	2-1/2	5	9539045
AXO_ _08730T6	11/32	.3438	8.73	3/8	1.17	1-11/16	4	9538959	1.98	2-1/2	5	9539147
AXO_ _000S0T6	S	.3480	8.84	3/8	1.23	1-3/4	4	9538847	1.98	2-1/2	5	9539046
AXO_ _09000T6		.3543	9.00	3/8	1.22	1-3/4	4	9538962	1.97	2-1/2	5	9539149
AXO_ _000T0T6	T	.3580	9.09	3/8	1.21	1-3/4	4	9538848	2.21	2-3/4	5	9539047
AXO_ _09130T6	23/64	.3594	9.13	3/8	1.21	1-3/4	4	9538963	2.21	2-3/4	5	9539151
AXO_ _000U0T6	U	.3680	9.35	3/8	1.26	1-13/16	4	9538849	2.20	2-3/4	5	9539048
AXO_ _09500T6		.3740	9.50	3/8	1.25	1-13/16	4	9538966	2.19	2-3/4	5	9539153

*Order Example

AXO_ _06250T6 > 3xD >>> AX00306250T6

AXO_ _00520T6 > 5xD >>> AX00500520T6

**Other Dimensions are Available Upon Request

CARBIDE DRILLS

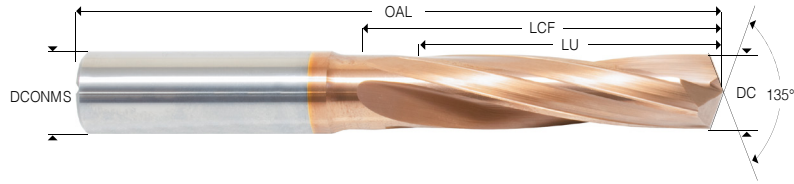

Item Description (Insert 03 or 05 in place of _) *Order Example	**DC Cutting Diameter			DCONMS	3xD Dimensions (mm)				5xD Dimensions (mm)			
	Fraction	Decimal	mm		LU Usable Length	LCF Length Chip Flute	OAL Overall Length	Item Number	LU Usable Length	LCF Length Chip Flute	OAL Overall Length	Item Number
AX0_09520T6	3/8	.3750	9.53	3/8	1.25	1-13/16	4	9538967	2.19	2-3/4	5	9539154
AX0_000V0T6	V	.3770	9.58	7/16	1.31	1-7/8	4	9538850	2.31	2-7/8	5	9539049
AX0_000W0T6	W	.3860	9.80	7/16	1.30	1-7/8	4	9538851	2.30	2-7/8	5	9539050
AX0_09920T6	25/64	.3906	9.92	7/16	1.29	1-7/8	4	9538975	2.29	2-7/8	5	9539157
AX0_10000T6		.3937	10.00	7/16	1.35	1-15/16	4	9538976	2.28	2-7/8	5	9539158
AX0_000X0T6	X	.3970	10.08	7/16	1.34	1-15/16	4	9538852	2.28	2-7/8	5	9539051
AX0_000Y0T6	Y	.4040	10.26	7/16	1.33	1-15/16	4	9538853	2.27	2-7/8	5	9539052
AX0_10320T6	13/32	.4062	10.32	7/16	1.33	1-15/16	4	9538977	2.27	2-7/8	5	9539159
AX0_000Z0T6	Z	.4130	10.49	7/16	1.38	2	4	9538854	2.26	2-7/8	5	9539053
AX0_10500T6		.4134	10.50	7/16	1.38	2	4	9538979	2.25	2-7/8	5	9539160
AX0_10720T6	27/64	.4219	10.72	7/16	1.37	2	4	9538980	2.24	2-7/8	5	9539162
AX0_10800T6		.4252	10.80	7/16	1.36	2	4	9538981	2.24	2-7/8	5	9539163
AX0_11000T6		.4331	11.00	7/16	1.41	2-1/16	4	9538982	2.23	2-7/8	5	9539164
AX0_11110T6	7/16	.4375	11.11	7/16	1.41	2-1/16	4	9538984	2.22	2-7/8	5	9539165
AX0_11500T6		.4528	11.50	1/2	1.45	2-1/8	4	9538986	2.32	3	5	9539166
AX0_11510T6	29/64	.4531	11.51	1/2	1.45	2-1/8	4	9538987	2.32	3	5	9539167
AX0_11910T6	15/32	.4688	11.91	1/2	1.42	2-1/8	4	9538988	2.30	3	5	9539169
AX0_12000T6		.4724	12.00	1/2	1.48	2-3/16	4	9538989	2.29	3	5	9539170
AX0_12300T6	31/64	.4844	12.30	1/2	1.46	2-3/16	4	9538991	2.27	3	5	9539172
AX0_12500T6		.4921	12.50	1/2	1.45	2-3/16	4	9538992	2.26	3	5	9539173
AX0_12700T6	1/2	.5000	12.70	1/2	1.50	2-1/4	4	9538993	2.25	3	5	9539174
AX0_13000T6		.5118	13.00	9/16	1.61	2-3/8	5	9538995	2.48	3-1/4	5	9539177
AX0_13100T6	33/64	.5156	13.10	9/16	1.60	2-3/8	5	9538996	2.48	3-1/4	5	9539178
AX0_13490T6	17/32	.5312	13.49	9/16	1.70	2-1/2	5	9538998	2.45	3-1/4	5	9539179
AX0_13500T6		.5315	13.50	9/16	1.70	2-1/2	5	9538999	2.45	3-1/4	5	9539181
AX0_13890T6	35/64	.5469	13.89	9/16	1.68	2-1/2	5	9539001	2.43	3-1/4	5	9539183
AX0_14000T6		.5512	14.00	9/16	1.67	2-1/2	5	9539002	2.42	3-1/4	5	9539184
AX0_14290T6	9/16	.5625	14.29	9/16	2.16	3	5	9539003	2.41	3-1/4	5	9539185
AX0_14500T6		.5709	14.50	5/8	2.14	3	5	9539004	2.39	3-1/4	5	9539186
AX0_14680T6	37/64	.5781	14.68	5/8	2.13	3	5	9539005	2.63	3-1/2	6	9539187
AX0_15000T6		.5906	15.00	5/8	2.11	3	5	9539006	2.61	3-1/2	6	9539188
AX0_15080T6	19/32	.5938	15.08	5/8	2.11	3	5	9539007	2.61	3-1/2	6	9539189
AX0_15480T6	39/64	.6094	15.48	5/8	2.09	3	5	9539008	2.59	3-1/2	6	9539190
AX0_15500T6		.6102	15.50	5/8	2.08	3	5	9539009	2.58	3-1/2	6	9539191
AX0_15870T6	5/8	.6250	15.88	5/8	2.06	3	5	9539011	2.56	3-1/2	6	9539193
AX0_16000T6		.6299	16.00	5/8	2.06	3	5	9539012	2.56	3-1/2	6	9539194

Order Example

*AX0_09520T6 > 3xD >>> AX00309520T6

AX0_000V0T6 > 5xD >>> AX005000V0T6

**Other Dimensions are Available Upon Request

CARBIDE DRILLS



SCAN FOR SPEEDS & FEEDS



High Performance Triple Margin Drill Coolant Thru
Ideal for Aluminum and Non-Ferrous Materials
3xD-50xD

N Refer to page 4



SCAN FOR SPEEDS & FEEDS

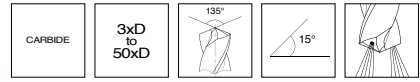

ZircoPlus® provides increased corrosion and abrasion resistance, for maximized machining.

Zirco Plus®

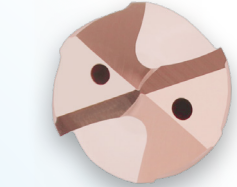

Coolant Holes - Cool the cutting edge and improve chip evacuation.

Mirror Polished Flutes - on 12xD-50xD polish process adds lubricity for better chip evacuation on deep hole drilling.

Triple-Margin Design - Ideal for improving surface finish and increasing stability.

No Pecking Required

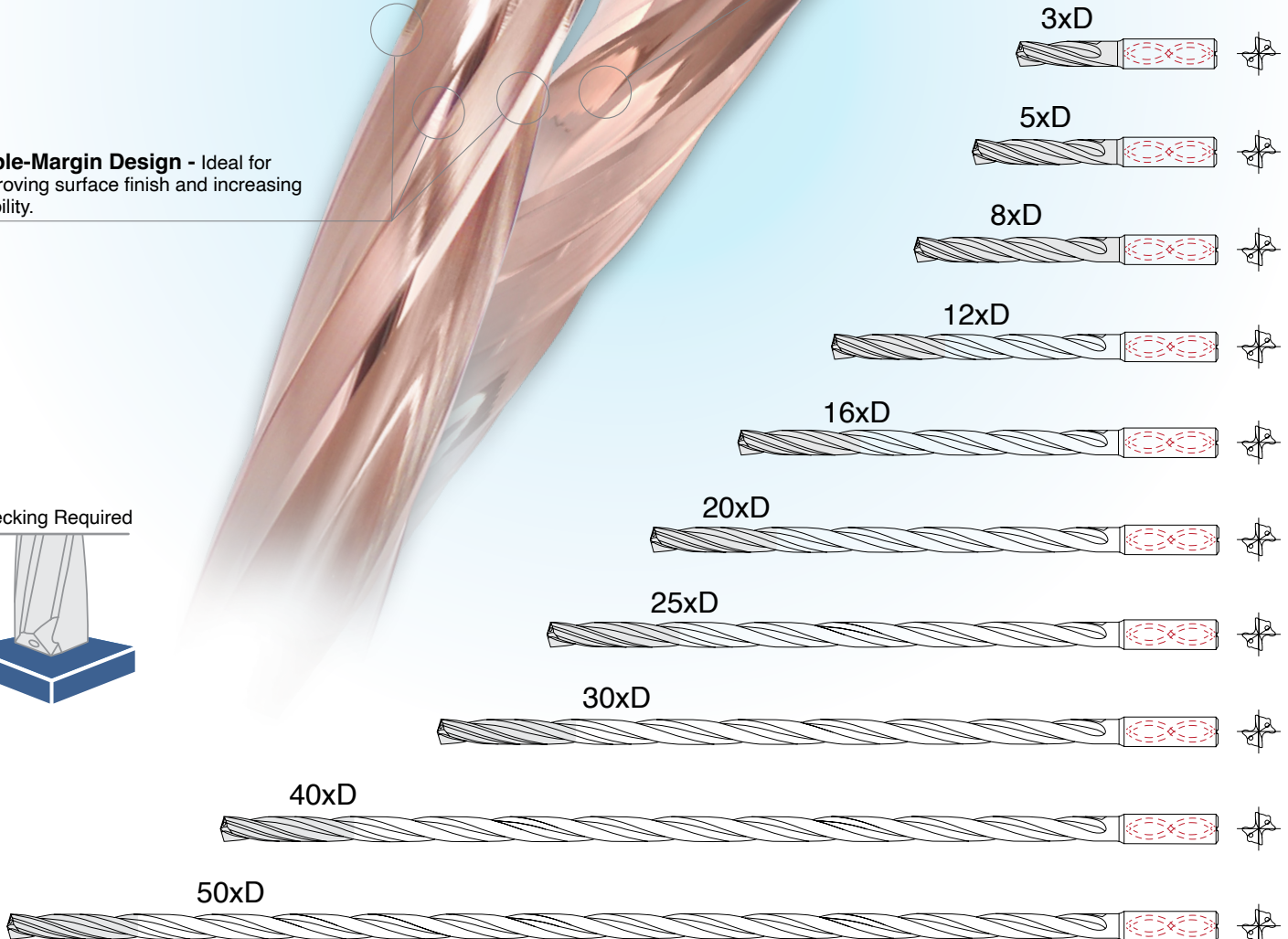
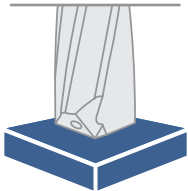

16xD – 30xD must utilize a pilot hole drill. Refer to page 77. 40xD & 50xD should utilize a 20xD intermediary drill along with pilot drill. Refer to page 21



Design – Long spiral-fluted, triple-margin, right-hand cut and internal coolant.
Ideal for – Aluminum and non-ferrous materials

N Refer to page 4



Zirco Plus® provides increased corrosion and abrasion resistance, for maximized machining.

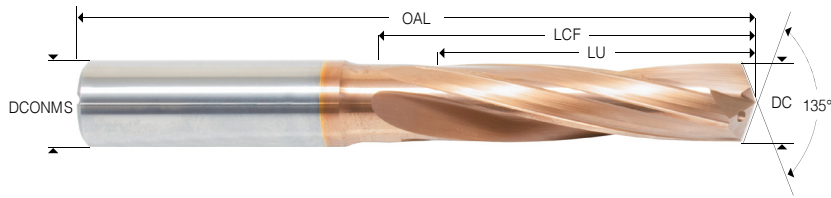

Item Description (Insert 03 or 05 in place of _) *Order Example	**DC Cutting Diameter			DCONMS	3xD Dimensions (mm)				5xD Dimensions (mm)			
	Fraction	Decimal	mm		LU Usable Length	LCF Length Chip Flute	OAL Overall Length	Item Number	LU Usable Length	LCF Length Chip Flute	OAL Overall Length	Item Number
AXC__03000T6		.1181	3.00	6	16	20	62	9539231	24	28	66	9539396
AXC__03100T6		.1220	3.10	6	15	20	62	9539233	23	28	66	9539397
AXC__03175T6	1/8	.1250	3.18	6	15	20	62	9539234	23	28	66	9539398
AXC__03200T6		.1260	3.20	6	15	20	62	9539235	23	28	66	9539399
AXC__03300T6		.1299	3.30	6	15	20	62	9539237	23	28	66	9539400
AXC__03400T6		.1339	3.40	6	15	20	62	9539238	23	28	66	9539402
AXC__03500T6		.1378	3.50	6	15	20	62	9539239	23	28	66	9539403
AXC__03572T6	9/64	.1406	3.57	6	15	20	62	9539240	23	28	66	9539404
AXC__03600T6		.1417	3.60	6	15	20	62	9539241	23	28	66	9539405
AXC__03700T6		.1457	3.70	6	14	20	62	9539242	22	28	66	9539406
AXC__03800T6		.1496	3.80	6	18	24	66	9539246	30	36	74	9539407
AXC__03900T6		.1535	3.90	6	18	24	66	9539247	30	36	74	9539409
AXC__03970T6	5/32	.1563	3.97	6	18	24	66	9539249	30	36	74	9539410
AXC__04000T6		.1575	4.00	6	18	24	66	9539250	30	36	74	9539411
AXC__04100T6		.1614	4.10	6	18	24	66	9539252	30	36	74	9539413
AXC__04200T6		.1654	4.20	6	18	24	66	9539253	30	36	74	9539414
AXC__04300T6		.1693	4.30	6	18	24	66	9539254	30	36	74	9539415
AXC__04370T6	11/64	.1719	4.37	6	17	24	66	9539255	29	36	74	9539417
AXC__04400T6		.1732	4.40	6	17	24	66	9539257	29	36	74	9539419
AXC__04500T6		.1772	4.50	6	17	24	66	9539258	29	36	74	9539420
AXC__04600T6		.1811	4.60	6	17	24	66	9539259	29	36	74	9539421
AXC__04650T6		.1831	4.65	6	17	24	66	9539260	29	36	74	9539422
AXC__00130T6	#13	.1850	4.70	6	17	24	66	9539225	29	36	74	9539392
AXC__04760T6	3/16	.1875	4.76	6	21	28	66	9539261	37	44	82	9539424
AXC__00120T6	#12	.1890	4.80	6	21	28	66	9539224	37	44	82	9539391
AXC__04900T6		.1929	4.90	6	21	28	66	9539263	37	44	82	9539427
AXC__05000T6		.1969	5.00	6	20	28	66	9539264	36	44	82	9539428
AXC__05100T6		.2008	5.10	6	20	28	66	9539265	36	44	82	9539430
AXC__05160T6	13/64	.2031	5.16	6	20	28	66	9539266	36	44	82	9539431
AXC__00060T6	#6	.2040	5.18	6	20	28	66	9539221	36	44	82	9539388
AXC__05200T6		.2047	5.20	6	20	28	66	9539267	36	44	82	9539432
AXC__05300T6		.2087	5.30	6	20	28	66	9539268	36	44	82	9539433
AXC__05400T6		.2126	5.40	6	20	28	66	9539269	36	44	82	9539434
AXC__05500T6		.2165	5.50	6	20	28	66	9539270	36	44	82	9539435
AXC__05550T6		.2185	5.55	6	20	28	66	9539271	36	44	82	9539436
AXC__05560T6	7/32	.2187	5.55	6	20	28	66	9539272	36	44	82	9539437
AXC__05600T6		.2205	5.60	6	20	28	66	9539274	36	44	82	9539438
AXC__05700T6		.2244	5.70	6	19	28	66	9539275	35	44	82	9539439
AXC__05800T6		.2283	5.80	6	19	28	66	9539276	35	44	82	9539440
AXC__05900T6		.2323	5.90	6	19	28	66	9539277	35	44	82	9539441
AXC__05950T6	15/64	.2344	5.95	6	19	28	66	9539278	35	44	82	9539442
AXC__06000T6		.2362	6.00	6	19	28	66	9539279	35	44	82	9539444
AXC__06100T6		.2402	6.10	8	25	34	79	9539280	44	53	91	9539446

***Order Example**

AXC__03000T6 > 3xD >>> AXC0303000T6
 AXC__03100T6 > 5xD >>> AXC0503100T6

CARBIDE DRILLS

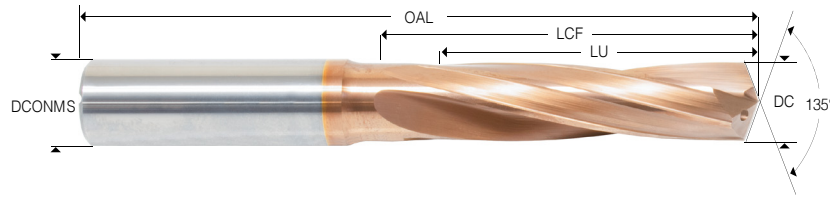

Item Description (Insert 03 or 05 in place of __) *Order Example	**DC Cutting Diameter			DCONMS	3xD Dimensions (mm)				5xD Dimensions (mm)			
	Fraction	Decimal	mm		LU Usable Length	LCF Length Chip Flute	OAL Overall Length	Item Number	LU Usable Length	LCF Length Chip Flute	OAL Overall Length	Item Number
AXC__06200T6		.2441	6.20	8	25	34	79	9539281	44	53	91	9539447
AXC__06300T6		.2480	6.30	8	25	34	79	9539282	44	53	91	9539448
AXC__06350T6	1/4	.2500	6.35	8	24	34	79	9539283	43	53	91	9539449
AXC__06400T6		.2520	6.40	8	24	34	79	9539284	43	53	91	9539455
AXC__06500T6		.2559	6.50	8	24	34	79	9539285	43	53	91	9539457
AXC__06600T6		.2598	6.60	8	24	34	79	9539286	43	53	91	9539458
AXC__06700T6		.2638	6.70	8	24	34	79	9539287	43	53	91	9539459
AXC__06750T6	17/64	.2656	6.75	8	24	34	79	9539288	43	53	91	9539460
AXC__06800T6		.2677	6.80	8	24	34	79	9539289	43	53	91	9539461
AXC__06900T6		.2717	6.90	8	31	41	79	9539290	43	53	91	9539463
AXC__07000T6		.2756	7.00	8	31	41	79	9539291	42	53	91	9539464
AXC__07100T6		.2795	7.10	8	30	41	79	9539292	42	53	91	9539465
AXC__07140T6	9/32	.2813	7.15	8	30	41	79	9539293	42	53	91	9539466
AXC__07200T6		.2835	7.20	8	30	41	79	9539295	42	53	91	9539467
AXC__07300T6		.2874	7.30	8	30	41	79	9539297	42	53	91	9539469
AXC__07400T6		.2913	7.40	8	30	41	79	9539300	42	53	91	9539470
AXC__07500T6		.2953	7.50	8	30	41	79	9539301	42	53	91	9539471
AXC__07540T6	19/64	.2969	7.54	8	30	41	79	9539302	42	53	91	9539472
AXC__07700T6		.3031	7.70	8	29	41	79	9539303	41	53	91	9539473
AXC__07800T6		.3071	7.80	8	29	41	79	9539304	41	53	91	9539474
AXC__07900T6		.3110	7.90	8	29	41	79	9539305	41	53	91	9539475
AXC__07940T6	5/16	.3125	7.94	8	29	41	79	9539306	41	53	91	9539476
AXC__08000T6		.3150	8.00	8	29	41	79	9539307	41	53	91	9539477
AXC__08100T6		.3189	8.10	10	35	47	89	9539308	49	61	103	9539481
AXC__08200T6		.3228	8.20	10	35	47	89	9539309	49	61	103	9539482
AXC__08300T6		.3268	8.30	10	35	47	89	9539310	49	61	103	9539483
AXC__08330T6	21/64	.3281	8.33	10	35	47	89	9539311	49	61	103	9539484
AXC__08400T6		.3307	8.40	10	34	47	89	9539312	48	61	103	9539485
AXC__08500T6		.3346	8.50	10	34	47	89	9539313	48	61	103	9539486
AXC__08600T6		.3386	8.60	10	34	47	89	9539314	48	61	103	9539488
AXC__08700T6		.3425	8.70	10	34	47	89	9539315	48	61	103	9539489
AXC__08730T6	11/32	.3437	8.73	10	34	47	89	9539316	48	61	103	9539490
AXC__08800T6		.3465	8.80	10	34	47	89	9539317	48	61	103	9539492
AXC__09000T6		.3543	9.00	10	34	47	89	9539318	48	61	103	9539495
AXC__09130T6	23/64	.3594	9.13	10	33	47	89	9539319	47	61	103	9539497
AXC__09200T6		.3622	9.20	10	33	47	89	9539320	47	61	103	9539498
AXC__09300T6		.3661	9.30	10	33	47	89	9539322	47	61	103	9539500
AXC__09500T6		.3740	9.50	10	33	47	89	9539324	47	61	103	9539502
AXC__09520T6	3/8	.3750	9.53	10	33	47	89	9539325	47	61	103	9539503
AXC__09600T6		.3780	9.60	10	33	47	89	9539328	47	61	103	9539504
AXC__09800T6		.3858	9.80	10	32	47	89	9539329	46	61	103	9539505
AXC__09900T6		.3898	9.90	10	32	47	89	9539331	46	61	103	9539506
AXC__09920T6	25/64	.3906	9.92	10	32	47	89	9539332	46	61	103	9539507
AXC__10000T6		.3937	10.00	10	32	47	89	9539333	46	61	103	9539510
AXC__10100T6		.3976	10.10	12	40	55	102	9539334	56	71	118	9539513
AXC__10200T6		.4016	10.20	12	40	55	102	9539335	56	71	118	9539514
AXC__10300T6		.4055	10.30	12	40	55	102	9539336	56	71	118	9539515
AXC__10320T6	13/32	.4063	10.32	12	40	55	102	9539337	56	71	118	9539516
AXC__10400T6		.4094	10.40	12	39	55	102	9539338	55	71	118	9539517
AXC__10500T6		.4134	10.50	12	39	55	102	9539339	55	71	118	9539518
AXC__10720T6	27/64	.4219	10.72	12	39	55	102	9539340	55	71	118	9539519
AXC__10800T6		.4252	10.80	12	39	55	102	9539341	55	71	118	9539521
AXC__11000T6		.4331	11.00	12	38	55	102	9539342	55	71	118	9539522
AXC__11100T6		.4370	11.10	12	38	55	102	9539344	54	71	118	9539523

*Order Example

AXC__03000T6 > 3xD >>> AXC0303000T6

AXC__03100T6 > 5xD >>> AXC0503100T6

CARBIDE DRILLS

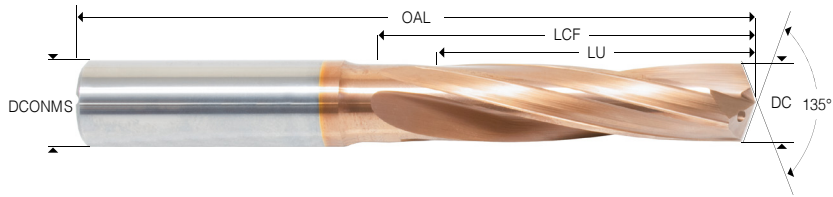

Item Description (Insert 03 or 05 in place of _)	**DC Cutting Diameter			DCONMS	3xD Dimensions (mm)				5xD Dimensions (mm)			
	*Order Example	Fraction	Decimal		mm	LU Usable Length	LCF Length Chip Flute	OAL Overall Length	Item Number	LU Usable Length	LCF Length Chip Flute	OAL Overall Length
AXC__11113T6	7/16	.4375	11.11	12	38	55	102	9539345	54	71	118	9539524
AXC__11200T6		.4409	11.20	12	38	55	102	9539346	54	71	118	9539525
AXC__11500T6		.4528	11.50	12	38	55	102	9539348	54	71	118	9539528
AXC__11510T6	29/64	.4531	11.51	12	38	55	102	9539349	54	71	118	9539529
AXC__11700T6		.4606	11.70	12	37	55	102	9539350	53	71	118	9539530
AXC__11800T6		.4646	11.80	12	37	55	102	9539351	53	71	118	9539531
AXC__11910T6	15/32	.4687	11.90	12	37	55	102	9539352	53	71	118	9539532
AXC__12000T6		.4724	12.00	12	37	55	102	9539353	53	71	118	9539534
AXC__12100T6		.4764	12.10	14	42	60	107	9539355	59	77	124	9539535
AXC__12200T6		.4803	12.20	14	42	60	107	9539356	59	77	124	9539536
AXC__12300T6		.4843	12.30	14	42	60	107	9539357	59	77	124	9539537
AXC__12303T6	31/64	.4844	12.30	14	42	60	107	9539358	59	77	124	9539538
AXC__12500T6		.4921	12.50	14	41	60	107	9539359	58	77	124	9539539
AXC__12600T6		.4961	12.60	14	41	60	107	9539360	58	77	124	9539540
AXC__12700T6	1/2	.5000	12.70	14	41	60	107	9539361	58	77	124	9539541
AXC__13000T6		.5118	13.00	14	41	60	107	9539362	58	77	124	9539545
AXC__13300T6		.5236	13.30	14	40	60	107	9539365	57	77	124	9539548
AXC__13490T6	17/32	.5313	13.50	14	40	60	107	9539366	57	77	124	9539549
AXC__13500T6		.5315	13.50	14	40	60	107	9539367	57	77	124	9539550
AXC__14000T6		.5512	14.00	14	39	60	107	9539368	56	77	124	9539552
AXC__14290T6	9/16	.5625	14.29	16	44	65	115	9539369	62	83	133	9539555
AXC__14500T6		.5709	14.50	16	43	65	115	9539370	61	83	133	9539556
AXC__15000T6		.5906	15.00	16	42	65	115	9539371	60	83	133	9539557
AXC__15500T6		.6102	15.50	16	42	65	115	9539373	60	83	133	9539559
AXC__15870T6	5/8	.6250	15.88	16	41	65	115	9539374	59	83	133	9539560
AXC__16000T6		.6299	16.00	16	41	65	115	9539375	59	83	133	9539561
AXC__16500T6		.6496	16.50	18	48	73	123	9539376	68	93	143	9539562
AXC__17000T6		.6693	17.00	18	48	73	123	9539377	68	93	143	9539563
AXC__17500T6		.6890	17.50	18	47	73	123	9539378	67	93	143	9539569
AXC__18000T6		.7087	18.00	18	46	73	123	9539379	66	93	143	9539570
AXC__18500T6		.7283	18.50	20	51	79	131	9539380	73	101	153	9539571
AXC__19050T6	3/4	.7500	19.05	20	50	79	131	9539381	72	101	153	9539572
AXC__19500T6		.7677	19.50	20	50	79	131	9539382	72	101	153	9539573
AXC__20000T6		.7874	20.00	20	49	79	131	9539383	71	101	153	9539574

***Order Example**

AXC__11113T6 > 3xD >>> AXC0311113T6

AXC__11200T6 > 5xD >>> AXC0511200T6

** Diameters (2.0-2.9mm) and other dimensions are available upon request**



SCAN FOR SPEEDS & FEEDS

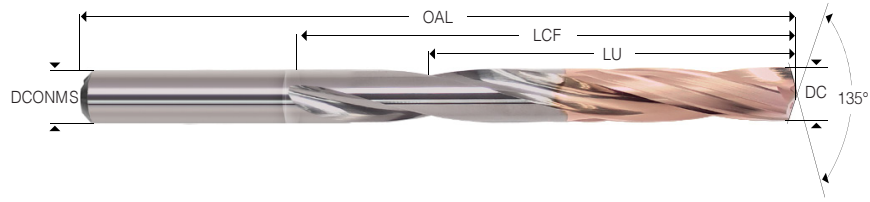

Item Description (Insert 08 or 12 in place of _ _) *Order Example	**DC Cutting Diameter			DCONMS	8xD Dimensions (mm)				12xD Dimensions (mm)			
	Fraction	Decimal	mm		LU Usable Length	LCF Length Chip Flute	OAL Overall Length	Item Number	LU Usable Length	LCF Length Chip Flute	OAL Overall Length	Item Number
AXC__03000T6		0.1181	3.00	6	30	34	72	9539593	49	54	92	9539764
AXC__03100T6		0.1220	3.10	6	29	34	72	9539594	49	54	92	9539765
AXC__03175T6	1/8	0.1250	3.18	6	29	34	72	9539596	49	54	92	9539766
AXC__03200T6		0.1260	3.20	6	29	34	72	9539597	49	54	92	9539767
AXC__03300T6		0.1299	3.30	6	29	34	72	9539598	49	54	92	9539768
AXC__03400T6		0.1339	3.40	6	29	34	72	9539599	49	54	92	9539769
AXC__03500T6		0.1378	3.50	6	29	34	72	9539600	49	54	92	9539770
AXC__03572T6	9/64	0.1406	3.57	6	29	34	72	9539601	49	54	92	9539771
AXC__03600T6		0.1417	3.60	6	29	34	72	9539602	49	54	92	9539772
AXC__03700T6		0.1457	3.70	6	28	34	72	9539603	48	54	92	9539773
AXC__03800T6		0.1496	3.80	6	37	43	81	9539604	58	64	102	9539774
AXC__03900T6		0.1535	3.90	6	37	43	81	9539605	58	64	102	9539776
AXC__03970T6	5/32	0.1563	3.97	6	37	43	81	9539606	58	64	102	9539778
AXC__04000T6		0.1575	4.00	6	37	43	81	9539607	58	64	102	9539779
AXC__04100T6		0.1614	4.10	6	37	43	81	9539608	58	64	102	9539780
AXC__04200T6		0.1654	4.20	6	37	43	81	9539609	58	64	102	9539781
AXC__04300T6		0.1693	4.30	6	37	43	81	9539610	58	64	102	9539782
AXC__04370T6	11/64	0.1719	4.37	6	36	43	81	9539611	57	64	102	9539783
AXC__04400T6		0.1732	4.40	6	36	43	81	9539613	57	64	102	9539785
AXC__04500T6		0.1772	4.50	6	36	43	81	9539615	57	64	102	9539786
AXC__04600T6		0.1811	4.60	6	36	43	81	9539616	57	64	102	9539787
AXC__04650T6		0.1831	4.65	6	36	43	81	9539617	57	64	102	9539788
AXC__00130T6	#13	0.1850	4.70	6	36	43	81	9539591	57	64	102	9539763
AXC__04760T6	3/16	0.1875	4.76	6	50	57	95	9539618	71	78	116	9539789
AXC__00120T6	#12	0.1890	4.80	6	50	57	95	9539590	71	78	116	9539762
AXC__04900T6		0.1929	4.90	6	50	57	95	9539622	71	78	116	9539791
AXC__05000T6		0.1969	5.00	6	49	57	95	9539624	70	78	116	9539792
AXC__05100T6		0.2008	5.10	6	49	57	95	9539625	70	78	116	9539796
AXC__05160T6	13/64	0.2031	5.16	6	49	57	95	9539626	70	78	116	9539798
AXC__00060T6	#6	0.2040	5.18	6	49	57	95	9539589	70	78	116	9539761
AXC__05200T6		0.2047	5.20	6	49	57	95	9539627	70	78	116	9539799
AXC__05300T6		0.2087	5.30	6	49	57	95	9539628	70	78	116	9539800
AXC__05400T6		0.2126	5.40	6	49	57	95	9539629	70	78	116	9539801
AXC__05500T6		0.2165	5.50	6	49	57	95	9539630	70	78	116	9539802
AXC__05550T6		0.2185	5.55	6	49	57	95	9539631	70	78	116	9539803
AXC__05560T6	7/32	0.2187	5.55	6	49	57	95	9539632	70	78	116	9539804
AXC__05600T6		0.2205	5.60	6	49	57	95	9539633	70	78	116	9539805
AXC__05700T6		0.2244	5.70	6	48	57	95	9539635	69	78	116	9539806
AXC__05800T6		0.2283	5.80	6	48	57	95	9539636	69	78	116	9539808
AXC__05900T6		0.2323	5.90	6	48	57	95	9539637	69	78	116	9539809
AXC__05950T6	15/64	0.2344	5.95	6	48	57	95	9539638	69	78	116	9539810
AXC__06000T6		0.2362	6.00	6	48	57	95	9539639	69	78	116	9539811
AXC__06100T6		0.2402	6.10	8	67	76	114	9539640	99	108	146	9539812
AXC__06200T6		0.2441	6.20	8	67	76	114	9539641	99	108	146	9539813
AXC__06300T6		0.2480	6.30	8	67	76	114	9539642	99	108	146	9539814
AXC__06350T6	1/4	0.2500	6.35	8	66	76	114	9539643	98	108	146	9539815
AXC__06400T6		0.2520	6.40	8	66	76	114	9539645	98	108	146	9539816
AXC__06500T6		0.2559	6.50	8	66	76	114	9539646	98	108	146	9539817
AXC__06600T6		0.2598	6.60	8	66	76	114	9539647	98	108	146	9539819
AXC__06700T6		0.2638	6.70	8	66	76	114	9539649	98	108	146	9539820
AXC__06750T6	17/64	0.2656	6.75	8	66	76	114	9539650	98	108	146	9539821
AXC__06800T6		0.2677	6.80	8	66	76	114	9539651	98	108	146	9539822
AXC__06900T6		0.2717	6.90	8	66	76	114	9539652	98	108	146	9539823
AXC__07000T6		0.2756	7.00	8	65	76	114	9539653	98	108	146	9539824
AXC__07100T6		0.2795	7.10	8	65	76	114	9539654	97	108	146	9539826
AXC__07140T6	9/32	0.2813	7.15	8	65	76	114	9539655	97	108	146	9539827
AXC__07200T6		0.2835	7.20	8	65	76	114	9539656	97	108	146	9539828
AXC__07300T6		0.2874	7.30	8	65	76	114	9539657	97	108	146	9539830
AXC__07400T6		0.2913	7.40	8	65	76	114	9539658	97	108	146	9539831
AXC__07500T6		0.2953	7.50	8	65	76	114	9539659	97	108	146	9539832
AXC__07540T6	19/64	0.2969	7.54	8	65	76	114	9539660	97	108	146	9539833
AXC__07700T6		0.3031	7.70	8	64	76	114	9539661	96	108	146	9539834
AXC__07800T6		0.3071	7.80	8	64	76	114	9539662	96	108	146	9539835
AXC__07900T6		0.3110	7.90	8	64	76	114	9539663	96	108	146	9539836
AXC__07940T6	5/16	0.3125	7.94	8	64	76	114	9539664	96	108	146	9539837
AXC__08000T6		0.3150	8.00	8	64	76	114	9539666	96	108	146	9539838

*Order Example

AXC__03000T6 > 08xD >>> AXC0803000T6

AXC__03100T6 > 12xD >>> AXC1203100T6

** Diameters (2.0-2.9mm) and other dimensions are available upon request**

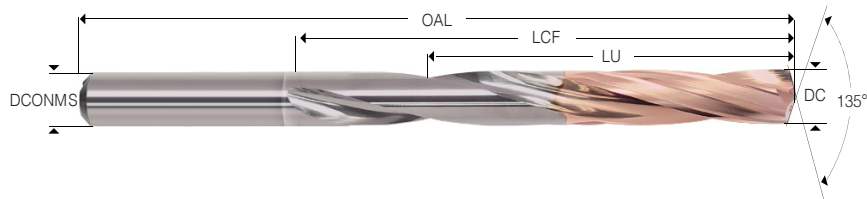

Item Description (Insert 08 or 12 in place of _)	**DC Cutting Diameter			DCONMS	8xD Dimensions (mm)				12xD Dimensions (mm)				
	*Order Example	Fraction	Decimal		mm	LU Usable Length	LCF Length Chip Flute	OAL Overall Length	Item Number	LU Usable Length	LCF Length Chip Flute	OAL Overall Length	Item Number
AXC_08100T6			0.3189	8.10	10	83	95	142	9539668	108	120	162	9539840
AXC_08200T6			0.3228	8.20	10	83	95	142	9539669	108	120	162	9539841
AXC_08300T6			0.3268	8.30	10	83	95	142	9539670	108	120	162	9539842
AXC_08330T6	21/64		0.3281	8.33	10	82	95	142	9539671	108	120	162	9539843
AXC_08400T6			0.3307	8.40	10	82	95	142	9539672	107	120	162	9539844
AXC_08500T6			0.3346	8.50	10	82	95	142	9539673	107	120	162	9539845
AXC_08600T6			0.3386	8.60	10	82	95	142	9539675	107	120	162	9539846
AXC_08700T6			0.3425	8.70	10	82	95	142	9539676	107	120	162	9539847
AXC_08730T6	11/32		0.3437	8.73	10	82	95	142	9539677	107	120	162	9539848
AXC_08800T6			0.3465	8.80	10	82	95	142	9539678	107	120	162	9539849
AXC_09000T6			0.3543	9.00	10	82	95	142	9539680	107	120	162	9539850
AXC_09130T6	23/64		0.3594	9.13	10	81	95	142	9539682	106	120	162	9539851
AXC_09200T6			0.3622	9.20	10	81	95	142	9539683	106	120	162	9539852
AXC_09300T6			0.3661	9.30	10	81	95	142	9539684	106	120	162	9539853
AXC_09500T6			0.3740	9.50	10	81	95	142	9539687	106	120	162	9539854
AXC_09520T6	3/8		0.3750	9.53	10	81	95	142	9539688	106	120	162	9539855
AXC_09600T6			0.3780	9.60	10	81	95	142	9539689	106	120	162	9539856
AXC_09800T6			0.3858	9.80	10	80	95	142	9539691	105	120	162	9539857
AXC_09900T6			0.3898	9.90	10	80	95	142	9539692	105	120	162	9539859
AXC_09920T6	25/64		0.3906	9.92	10	80	95	142	9539693	105	120	162	9539860
AXC_10000T6			0.3937	10.00	10	80	95	142	9539694	105	120	162	9539861
AXC_10100T6			0.3976	10.10	12	99	114	162	9539695	141	156	204	9539862
AXC_10200T6			0.4016	10.20	12	99	114	162	9539696	141	156	204	9539863
AXC_10300T6			0.4055	10.30	12	99	114	162	9539697	141	156	204	9539864
AXC_10320T6	13/32		0.4063	10.32	12	99	114	162	9539698	141	156	204	9539865
AXC_10400T6			0.4094	10.40	12	98	114	162	9539699	140	156	204	9539866
AXC_10500T6			0.4134	10.50	12	98	114	162	9539700	140	156	204	9539868
AXC_10720T6	27/64		0.4219	10.72	12	98	114	162	9539701	140	156	204	9539869
AXC_10800T6			0.4252	10.80	12	98	114	162	9539702	140	156	204	9539870
AXC_11000T6			0.4331	11.00	12	98	114	162	9539703	139	156	204	9539871
AXC_11100T6			0.4370	11.10	12	97	114	162	9539704	139	156	204	9539872
AXC_11113T6	7/16		0.4375	11.11	12	97	114	162	9539705	139	156	204	9539873
AXC_11200T6			0.4409	11.20	12	97	114	162	9539707	139	156	204	9539874
AXC_11500T6			0.4528	11.50	12	97	114	162	9539708	139	156	204	9539875
AXC_11510T6	29/64		0.4531	11.51	12	97	114	162	9539709	139	156	204	9539876
AXC_11700T6			0.4606	11.70	12	96	114	162	9539710	138	156	204	9539877
AXC_11800T6			0.4646	11.80	12	96	114	162	9539711	138	156	204	9539878
AXC_11910T6	15/32		0.4687	11.90	12	96	114	162	9539712	138	156	204	9539879
AXC_12000T6			0.4724	12.00	12	96	114	162	9539714	138	156	204	9539880
AXC_12100T6			0.4764	12.10	14	113	131	178	9539715	164	182	230	9539882
AXC_12200T6			0.4803	12.20	14	113	131	178	9539716	164	182	230	9539883
AXC_12300T6			0.4843	12.30	14	113	131	178	9539717	164	182	230	9539884
AXC_12303T6	31/64		0.4844	12.30	14	113	131	178	9539718	164	182	230	9539885
AXC_12500T6			0.4921	12.50	14	112	131	178	9539719	163	182	230	9539886
AXC_12600T6			0.4961	12.60	14	112	131	178	9539720	163	182	230	9539887
AXC_12700T6	1/2		0.5000	12.70	14	112	131	178	9539722	163	182	230	9539888
AXC_13000T6			0.5118	13.00	14	112	131	178	9539724	163	182	230	9539889
AXC_13300T6			0.5236	13.30	14	111	131	178	9539728	162	182	230	9539891
AXC_13490T6	17/32		0.5313	13.50	14	111	131	178	9539729	162	182	230	9539892
AXC_13500T6			0.5315	13.50	14	111	131	178	9539730	162	182	230	9539893
AXC_14000T6			0.5512	14.00	14	110	131	178	9539732	161	182	230	9539895
AXC_14290T6	9/16		0.5625	14.29	16	131	152	203	9539734	187	208	260	9539897
AXC_14500T6			0.5709	14.50	16	130	152	203	9539735	186	208	260	9539898
AXC_15000T6			0.5906	15.00	16	129	152	203	9539737	185	208	260	9539900
AXC_15500T6			0.6102	15.50	16	129	152	203	9539738	185	208	260	9539901
AXC_15870T6	5/8		0.6250	15.88	16	128	152	203	9539739	184	208	260	9539902
AXC_16000T6			0.6299	16.00	16	128	152	203	9539740	184	208	260	9539903
AXC_16500T6			0.6496	16.50	18	146	171	222	9539743	209	234	285	9539904
AXC_17000T6			0.6693	17.00	18	146	171	222	9539744	209	234	285	9539910
AXC_17500T6			0.6890	17.50	18	145	171	222	9539745	208	234	285	9539912
AXC_18000T6			0.7087	18.00	18	144	171	222	9539746	207	234	285	9539913
AXC_18500T6			0.7283	18.50	20	162	190	243	9539750	230	258	310	9539914
AXC_19050T6	3/4		0.7500	19.05	20	161	190	243	9539752	229	258	310	9539916
AXC_19500T6			0.7677	19.50	20	161	190	243	9539753	229	258	310	9539919
AXC_20000T6			0.7874	20.00	20	160	190	243	9539754	228	258	310	9539920

*Order Example

AXC_08100T6 > 08xD >>> AXC0808100T6

AXC_08200T6 > 12xD >>> AXC1208200T6

** Diameters (2.0-2.9mm) and other dimensions are available upon request**

CARBIDE DRILLS



Design – Long spiral-fluted, triple-margin, right-hand cut and internal coolant.

Ideal for – Aluminum and non-ferrous materials

N Refer to page 4

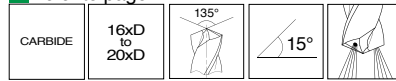

Zirco Plus® provides increased corrosion and abrasion resistance, for maximized machining.

■ This drill should utilize a pilot hole drill. (Refer to page 77)

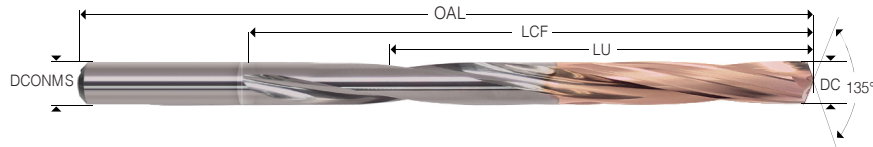

Item Description (Insert 16 or 20 in place of _) *Order Example	**DC Cutting Diameter			DCONMS	16xD Dimensions (mm)				20xD Dimensions (mm)			
	Fraction	Decimal	mm		LU Usable Length	LCF Length Chip Flute	OAL Overall Length	Item Number	LU Usable Length	LCF Length Chip Flute	OAL Overall Length	Item Number
AXC__03000T6		.1181	3.00	6	56	60	100	9539929	76	80	120	9540082
AXC__03175T6	1/8	.1250	3.18	6	55	60	100	9539931	75	80	120	9540088
AXC__03200T6		.1260	3.20	6	55	60	100	9539932	75	80	120	9540090
AXC__03300T6		.1299	3.30	6	55	60	100	9539933	75	80	120	9540091
AXC__03500T6		.1378	3.50	6	55	60	100	9539935	75	80	120	9540093
AXC__03572T6	9/64	.1406	3.57	6	70	75	115	9539936	85	90	130	9540094
AXC__03800T6		.1496	3.80	6	69	75	115	9539939	84	90	130	9540098
AXC__03970T6	5/32	.1563	3.97	6	69	75	115	9539942	84	90	130	9540101
AXC__04000T6		.1575	4.00	6	69	75	115	9539943	84	90	130	9540104
AXC__04200T6		.1654	4.20	6	69	75	115	9539945	104	110	160	9540106
AXC__04370T6	11/64	.1719	4.37	6	83	90	130	9539948	103	110	160	9540108
AXC__04500T6		.1772	4.50	6	83	90	130	9539951	103	110	160	9540111
AXC__00130T6	#13	.1850	4.70	6	83	90	130	9539928	113	120	160	9540081
AXC__04760T6	3/16	.1875	4.76	6	83	90	130	9539954	113	120	160	9540114
AXC__00120T6	#12	.1890	4.80	6	83	90	130	9539927	113	120	160	9540080
AXC__05000T6		.1969	5.00	6	82	90	130	9539957	112	120	160	9540117
AXC__05160T6	13/64	.2031	5.16	6	100	108	150	9539959	132	140	185	9540119
AXC__00060T6	#6	.2040	5.18	6	100	108	150	9585956	132	140	185	9540079
AXC__05500T6		.2165	5.50	6	100	108	150	9539964	132	140	185	9540123
AXC__05560T6	7/32	.2187	5.55	6	100	108	150	9539966	132	140	185	9540125
AXC__05800T6		.2283	5.80	6	99	108	150	9539969	131	140	185	9540128
AXC__05950T6	15/64	.2344	5.95	6	99	108	150	9539971	131	140	185	9540130
AXC__06000T6		.2362	6.00	6	99	108	150	9539973	131	140	185	9540132
AXC__06350T6	1/4	.2500	6.35	8	115	125	165	9539977	150	160	210	9540139
AXC__06500T6		.2559	6.50	8	115	125	165	9539979	150	160	210	9540142
AXC__06750T6	17/64	.2656	6.75	8	115	125	165	9539983	150	160	210	9540146
AXC__06800T6		.2677	6.80	8	115	125	165	9539984	150	160	210	9540149
AXC__07000T6		.2756	7.00	8	115	125	165	9539986	149	160	210	9540153
AXC__07140T6	9/32	.2813	7.15	8	129	140	180	9539988	169	180	230	9540155
AXC__07500T6		.2953	7.50	8	129	140	180	9539992	169	180	230	9540159
AXC__07540T6	19/64	.2969	7.54	8	129	140	180	9539993	169	180	230	9540160
AXC__07800T6		.3071	7.80	8	128	140	180	9539995	168	180	230	9540162
AXC__07940T6	5/16	.3125	7.94	8	128	140	180	9539997	168	180	230	9540164
AXC__08000T6		.3150	8.00	8	128	140	180	9539998	168	180	230	9540165
AXC__08330T6	21/64	.3281	8.33	10	148	160	205	9540002	183	195	260	9540169
AXC__08500T6		.3346	8.50	10	147	160	205	9540004	182	195	260	9540171
AXC__08730T6	11/32	.3437	8.73	10	147	160	205	9540007	217	230	290	9540175
AXC__08800T6		.3465	8.80	10	147	160	205	9540009	217	230	290	9540177
AXC__09000T6		.3543	9.00	10	147	160	205	9540010	217	230	290	9540178
AXC__09130T6	23/64	.3594	9.13	10	166	180	225	9540013	216	230	290	9540179
AXC__09520T6	3/8	.3750	9.53	10	166	180	225	9540018	216	230	290	9540183
AXC__09800T6		.3858	9.80	10	165	180	225	9540021	215	230	290	9540188
AXC__09920T6	25/64	.3906	9.92	10	165	180	225	9540023	215	230	290	9540190
AXC__10000T6		.3937	10.00	10	165	180	225	9540024	215	230	290	9540191

***Order Example**

AXC__03000T6 > 16xD >>> AXC1603000T6

AXC__03175T6 > 20xD >>> AXC2008200T6

** Diameters (2.0-2.9mm) and other dimensions are available upon request**

CARBIDE DRILLS

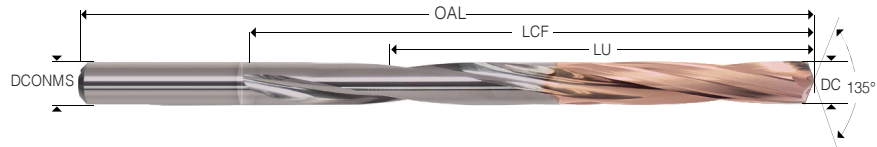

Item Description (Insert 16 or 20 in place of __) *Order Example	**DC Cutting Diameter			DCONMS	16xD Dimensions (mm)				20xD Dimensions (mm)			
	Fraction	Decimal	mm		LU Usable Length	LCF Length Chip Flute	OAL Overall Length	Item Number	LU Usable Length	LCF Length Chip Flute	OAL Overall Length	Item Number
AXC_10200T6		.4016	10.20	12	175	190	240	9540026	253	268	315	9540193
AXC_10320T6	13/32	.4063	10.32	12	175	190	240	9540029	253	268	315	9540195
AXC_10720T6	27/64	.4219	10.72	12	174	190	240	9540033	252	268	315	9540199
AXC_10800T6		.4252	10.80	12	174	190	240	9540034	252	268	315	9540200
AXC_11000T6		.4331	11.00	12	173	190	240	9540035	252	268	315	9540201
AXC_11113T6	7/16	.4375	11.11	12	198	215	265	9540037	251	268	315	9540203
AXC_11500T6		.4528	11.50	12	198	215	265	9540039	251	268	315	9540206
AXC_11510T6	29/64	.4531	11.51	12	198	215	265	9540040	251	268	315	9540207
AXC_11910T6	15/32	.4687	11.90	12	197	215	265	9540043	250	268	315	9540211
AXC_12000T6		.4724	12.00	12	197	215	265	9540044	250	268	315	9540213
AXC_12300T6		.4843	12.30	14	212	230	280	9540047	262	280	325	9540216
AXC_12303T6	31/64	.4844	12.30	14	212	230	280	9540048	262	280	325	9540217
AXC_12700T6	1/2	.5000	12.70	14	211	230	280	9540051	261	280	325	9540220
AXC_13000T6		.5118	13.00	14	210	230	280	9540053	260	280	325	9540223
AXC_13300T6		.5236	13.30	14	225	245	295	9540056	285	305	325	9540224
AXC_13490T6	17/32	.5313	13.50	14	225	245	295	9540057	285	305	325	9540225
AXC_13500T6		.5315	13.50	14	225	245	295	9540058	285	305	325	9540226
AXC_14000T6		.5512	14.00	14	224	245	295	9540059	284	305	325	9540227
AXC_14290T6	9/16	.5625	14.29	16	234	255	305	9540060				
AXC_14500T6		.5709	14.50	16	233	255	305	9540062				
AXC_15000T6		.5906	15.00	16	232	255	305	9540065				
AXC_15500T6		.6102	15.50	16	252	275	325	9540066				
AXC_15870T6	5/8	.6250	15.88	16	251	275	325	9540067				
AXC_16000T6		.6299	16.00	16	251	275	325	9540068				
AXC_18500T6		.7283	18.50	20	302	330	380	9540074				
AXC_19050T6	3/4	.7500	19.05	20	301	330	380	9540075				

***Order Example**

AXC_10200T6 > 16xD >>> AXC1610200T6
 AXC_03175T6 > 20xD >>> AXC2008200T6



SCAN FOR SPEEDS & FEEDS



Design – Long spiral-fluted, triple-margin, right-hand cut and internal coolant.

Ideal for – Aluminum and non-ferrous materials

Refer to page 4

This drill must utilize a pilot hole drill.
(Refer to page 77)

CARBIDE **25xD to 30xD** **135°** **15°** **Zirco Plus®** ZircoPlus® provides increased corrosion and abrasion resistance, for maximized machining.



Item Description (Insert 25 or 30 in place of _)	**DC Cutting Diameter			DCONMS	25xD Dimensions (mm)			30xD Dimensions (mm)				
	Fraction	Decimal	mm		LU Usable Length	LCF Length Chip Flute	OAL Overall Length	Item Number	LU Usable Length	LCF Length Chip Flute	OAL Overall Length	Item Number
AXC_03000T6		.1181	3.00	6	93	98	135	9540237	101	105	150	9540365
AXC_03175T6	1/8	.1250	3.18	6	93	98	135	9540239	100	105	150	9540368
AXC_03200T6		.1260	3.20	6	93	98	135	9540240	100	105	150	9540369
AXC_03300T6		.1299	3.30	6	93	98	135	9540242	130	135	185	9540371
AXC_03500T6		.1378	3.50	6	93	98	135	9540244	130	135	185	9540373
AXC_03572T6	9/64	.1406	3.57	6	115	120	160	9540245	130	135	185	9540374
AXC_03800T6		.1496	3.80	6	114	120	160	9540248	129	135	185	9540377
AXC_03970T6	5/32	.1563	3.97	6	114	120	160	9540250	129	135	185	9540380
AXC_04000T6		.1575	4.00	6	114	120	160	9540251	129	135	185	9540381
AXC_04200T6		.1654	4.20	6	114	120	160	9540253	129	135	185	9540383
AXC_04370T6	11/64	.1719	4.37	6	128	131	180	9540255	158	165	215	9540386
AXC_04500T6		.1772	4.50	6	128	131	180	9540259	158	165	215	9540388
AXC_00130T6	#13	.1850	4.70	6	128	131	180	9540236	158	165	215	9540363
AXC_04760T6	3/16	.1875	4.76	6	128	131	180	9540263	158	165	215	9540391
AXC_00120T6	#12	.1890	4.80	6	128	131	180	9540235	158	165	215	9540362
AXC_05000T6		.1969	5.00	6	127	131	180	9540267	158	165	215	9540394
AXC_05160T6	13/64	.2031	5.16	6	160	168	205	9540270	172	180	230	9540397
AXC_00060T6	#6	.2040	5.18	6	160	168	205	9540234	172	180	230	9540361
AXC_05500T6		.2165	5.50	6	160	168	205	9540275	172	180	230	9540401
AXC_05560T6	7/32	.2187	5.55	6	160	168	205	9540277	172	180	230	9540403
AXC_05800T6		.2283	5.80	6	159	168	205	9540280	171	180	230	9540406
AXC_05950T6	15/64	.2344	5.95	6	159	168	205	9540282	171	180	230	9540409
AXC_06000T6		.2362	6.00	6	159	168	205	9540283	171	180	230	9540411
AXC_06350T6	1/4	.2500	6.35	8	190	200	240	9540288	205	215	280	9540416
AXC_06500T6		.2559	6.50	8	190	200	240	9540290	205	215	280	9540420
AXC_06750T6	17/64	.2656	6.75	8	190	200	240	9540293	220	230	280	9540423
AXC_06800T6		.2677	6.80	8	190	200	240	9540294	220	230	280	9540426
AXC_07000T6		.2756	7.00	8	190	200	240	9540296	220	230	280	9540428
AXC_07140T6	9/32	.2813	7.15	8	209	220	260	9540299	219	230	280	9540430
AXC_07500T6		.2953	7.50	8	209	220	260	9540303	219	230	280	9540435
AXC_07540T6	19/64	.2969	7.54	8	209	220	260	9540304	254	265	315	9540436
AXC_07800T6		.3071	7.80	8	208	220	260	9540306	253	265	315	9540438
AXC_07940T6	5/16	.3125	7.94	8	208	220	260	9540308	253	265	315	9540440
AXC_08000T6		.3150	8.00	8	208	220	260	9540309	253	265	315	9540441
AXC_08330T6	21/64	.3281	8.33	10	228	240	285	9540314	280	295	350	9540446
AXC_08500T6		.3346	8.50	10	227	240	285	9540316	307	295	350	9540448
AXC_08730T6	11/32	.3437	8.73	10	255	268	310	9540320	317	330	380	9540451
AXC_08800T6		.3465	8.80	10	255	268	310	9540322	317	330	380	9540452
AXC_09000T6		.3543	9.00	10	255	268	310	9540323	317	330	380	9540453
AXC_09130T6	23/64	.3594	9.13	10	254	268	310	9540325	316	330	380	9540454
AXC_09520T6	3/8	.3750	9.53	10	254	268	310	9540329	316	330	380	9540458
AXC_09800T6		.3858	9.80	10	253	268	310	9540333	315	330	380	9540463
AXC_09920T6	25/64	.3906	9.92	10	253	268	310	9540335	315	330	380	9540465
AXC_10000T6		.3937	10.00	10	253	268	310	9540336	315	330	380	9540466

*Order Example

AXC_10200T6 > 25xD >>> AXC2510200T6

AXC_03175T6 > 30xD >>> AXC3008200T6

CARBIDE DRILLS

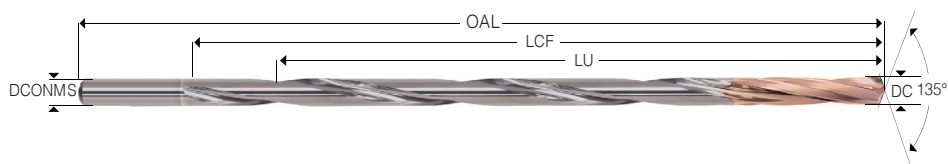

Item Description (Insert 25 in place of _)	**DC Cutting Diameter			DCONMS	25xD Dimensions (mm)			Item Number	
	*Order Example	Fraction	Decimal		mm	LU Usable Length	LCF Length Chip Flute		OAL Overall Length
AXC_ _10200T6			.4016	10.20	12	310	325	375	9540338
AXC_ _10320T6	13/32		.4063	10.32	12	305	300	350	9540339
AXC_ _10720T6	27/64		.4219	10.72	12	304	300	350	9540342
AXC_ _10800T6			.4252	10.80	12	309	325	375	9540343
AXC_ _11000T6			.4331	11.00	12	303	325	375	9540344
AXC_ _11113T6	7/16		.4375	11.11	12	303	325	375	9540345
AXC_ _11500T6			.4528	11.50	12	303	325	375	9540347
AXC_ _11510T6	29/64		.4531	11.51	12	303	325	375	9540348
AXC_ _11910T6	15/32		.4687	11.90	12	302	325	375	9540349
AXC_ _12000T6			.4724	12.00	12	302	325	375	9540350

*Order Example

AXC_ _10200T6 > 25xD >>> AXC2510200T6

** Diameters (2.0-2.9mm) and other dimensions are available upon request**



SCAN FOR SPEEDS & FEEDS



Design – Long spiral-fluted, triple-margin, right-hand cut and internal coolant.

Ideal for – Aluminum and non-ferrous materials

Refer to page 4

This drill must utilize a pilot hole drill.
(Refer to page 77)

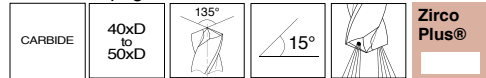

Zirco Plus® provides increased corrosion and abrasion resistance, for maximized machining.



Item Description (Insert 40 or 50 in place of _ _) *Order Example	**DC Cutting Diameter			DCONMS	40xD Dimensions (mm)				50xD Dimensions (mm)			
	Fraction	Decimal	mm		LU Usable Length	LCF Length Chip Flute	OAL Overall Length	Item Number	LU Usable Length	LCF Length Chip Flute	OAL Overall Length	Item Number
AXC_ _03000T6		.1181	3.00	6	136	140	190	9540484				
AXC_ _03175T6	1/8	.1250	3.18	6	135	140	190	9540486				
AXC_ _03572T6	9/64	.1406	3.57	6	175	180	230	9540491				
AXC_ _03800T6		.1496	3.80	6	174	180	230	9540494				
AXC_ _03970T6	5/32	.1563	3.97	6	174	180	230	9540496				
AXC_ _04000T6		.1575	4.00	6	174	180	230	9540497	219	225	270	9540575
AXC_ _04200T6		.1654	4.20	6	174	180	230	9540499	219	225	270	9540577
AXC_ _04370T6	11/64	.1719	4.37	6	213	220	270	9540501	268	275	320	9540579
AXC_ _04500T6		.1772	4.50	6	213	220	270	9540503	268	275	320	9540581
AXC_ _00130T6	#13	.1850	4.70	6	213	220	270	9540481	268	275	320	9540560
AXC_ _04760T6	3/16	.1875	4.76	6	213	220	270	9540506	268	275	320	9540584
AXC_ _00120T6	#12	.1890	4.80	6	213	220	270	9540480	268	275	320	9540559
AXC_ _05000T6		.1969	5.00	6	212	220	270	9540509	268	275	320	9540586
AXC_ _05160T6	13/64	.2031	5.16	6	232	240	290	9540511	302	310	360	9540588
AXC_ _00060T6	#6	.2040	5.18	6	232	240	290	9540479	302	310	360	9540558
AXC_ _05500T6	5.5	.2165	5.50	6	232	240	290	9540515	302	310	360	9540592
AXC_ _05560T6	7/32	.2187	5.55	6	232	240	290	9540517	302	310	360	9540594
AXC_ _05800T6	5.8	.2283	5.80	6	231	240	290	9540520	301	310	360	9540597
AXC_ _05950T6	15/64	.2344	5.95	6	231	240	290	9540522	301	310	360	9540599
AXC_ _06000T6		.2362	6.00	6	231	240	290	9540523	301	310	360	9540600
AXC_ _06350T6	1/4	.2500	6.35	8	280	290	340	9540528	330	340	385	9540601
AXC_ _06500T6		.2559	6.50	8	280	290	340	9540532				
AXC_ _06750T6	17/64	.2656	6.75	8	310	320	370	9540535				
AXC_ _06800T6		.2677	6.80	8	310	320	370	9540536				
AXC_ _07000T6		.2756	7.00	8	309	320	370	9540538				
AXC_ _07140T6	9/32	.2813	7.15	8	309	320	370	9540540				
AXC_ _07500T6		.2953	7.50	8	309	320	370	9540545				
AXC_ _07540T6	19/64	.2969	7.54	8	339	350	400	9540546				
AXC_ _07800T6		.3071	7.80	8	338	350	400	9540548				
AXC_ _07940T6	5/16	.3125	7.94	8	338	350	400	9540551				
AXC_ _08000T6		.3150	8.00	8	338	350	400	9540552				

*Order Example

AXC_ _03000T6 > 40xD >>> AXC4003000T6

AXC_ _03175T6 > 50xD >>> AXC5008200T6

** Diameters (2.0-2.9mm) and other dimensions are available upon request**

CARBIDE DRILLS



SCAN FOR SPEEDS & FEEDS





**High Performance
Single Margin Drill
Non Coolant Thru
Ideal for Aluminum &
Cast Materials
3xD-5xD**

Refer to page 4



SCAN FOR SPEEDS & FEEDS

Design – Spiral-fluted, right-hand cut, with external coolant and a cylindrical shank.



ZircoPlus® provides increased corrosion and abrasion resistance, for maximized machining.



130° Point Geometry
Self Centering - Ideal for faster drilling and high feed rates.

Single-Margin Design -
For drilling accuracy.

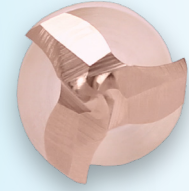
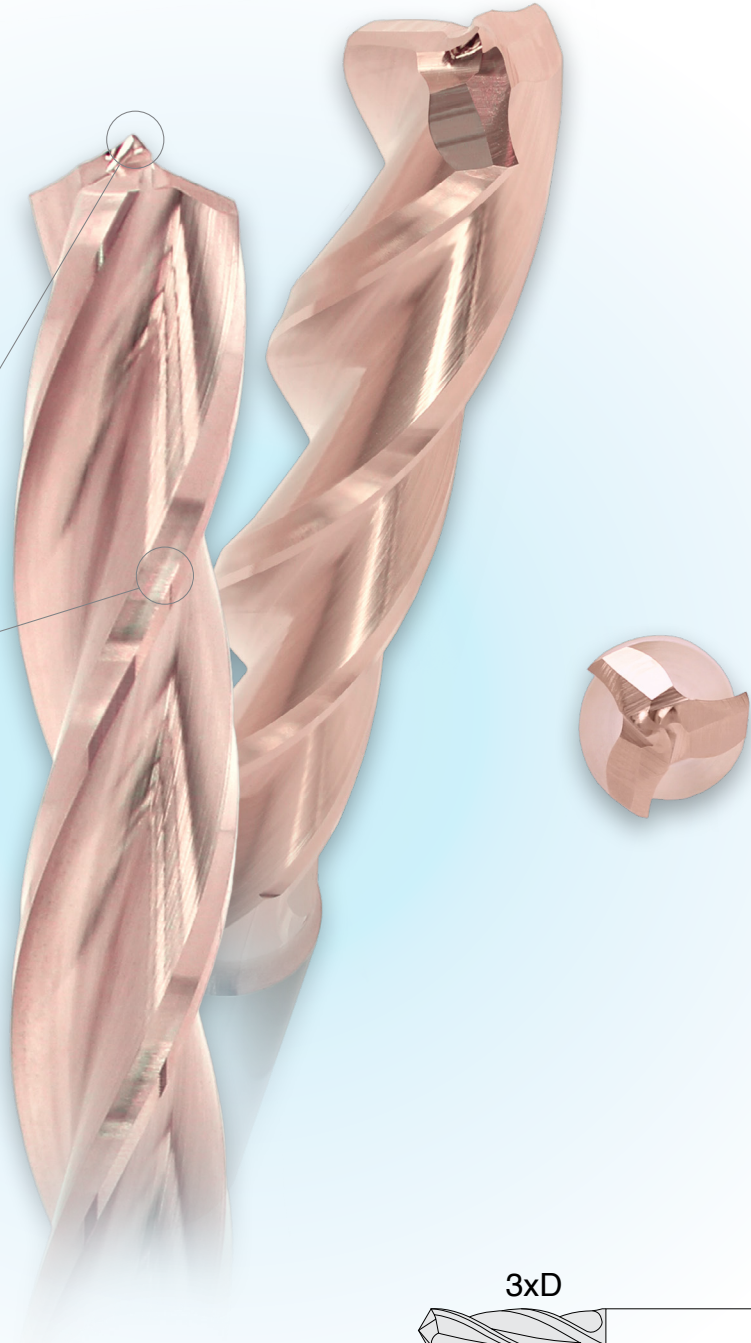

No Pecking Required

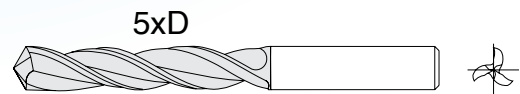
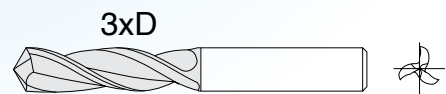
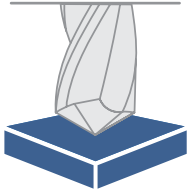

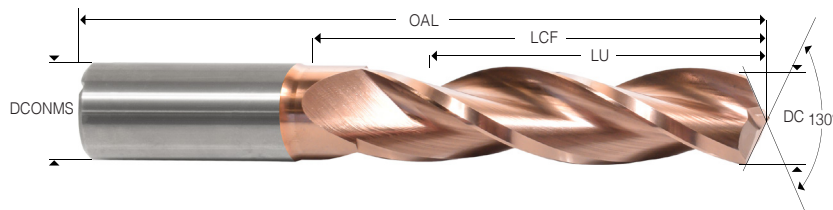

Item Description (Insert 03 or 05 in place of _) *Order Example	**DC Cutting Diameter			DCONMS	3xD Dimensions (mm)				5xD Dimensions (mm)			
	Fraction	Decimal	mm		LU Usable Length	LCF Length Chip Flute	OAL Overall Length	Item Number	LU Usable Length	LCF Length Chip Flute	OAL Overall Length	Item Number
CX0_06250T6	1/16	.0625	1.59	1/8	0.53	5/8	2	9542361	0.66	3/4	2-1/2	9542600
CX0_00520T6	#52	.0635	1.61	1/8	0.59	11/16	2	9542310	0.65	3/4	2-1/2	9542544
CX0_00510T6	#51	.0670	1.70	1/8	0.59	11/16	2	9542309	0.65	3/4	2-1/2	9542543
CX0_00500T6	#50	.0700	1.78	1/8	0.58	11/16	2	9542308	0.77	7/8	2-1/2	9542542
CX0_00490T6	#49	.0730	1.85	1/8	0.58	11/16	2	9542307	0.77	7/8	2-1/2	9542541
CX0_00480T6	#48	.0760	1.93	1/8	0.57	11/16	2	9542306	0.76	7/8	2-1/2	9542538
CX0_07810T6	5/64	.0781	1.98	1/8	0.57	11/16	2	9542384	0.76	7/8	2-1/2	9542618
CX0_00470T6	#47	.0785	1.99	1/8	0.63	3/4	2-1/2	9542305	0.76	7/8	2-1/2	9542537
CX0_07870T6		.0787	2.00	1/8	0.63	3/4	2-1/2	9542386	0.76	7/8	2-1/2	9542619
CX0_00460T6	#46	.0810	2.06	1/8	0.63	3/4	2-1/2	9542304	0.75	7/8	2-1/2	9542536
CX0_00450T6	#45	.0820	2.08	1/8	0.63	3/4	2-1/2	9542303	0.75	7/8	2-1/2	9542535
CX0_00440T6	#44	.0860	2.18	1/8	0.62	3/4	2-1/2	9542302	0.87	1	2-1/2	9542534
CX0_00430T6	#43	.0890	2.26	1/8	0.62	3/4	2-1/2	9542301	0.87	1	2-1/2	9542533
CX0_00420T6	#42	.0935	2.37	1/8	0.61	3/4	2-1/2	9542300	0.86	1	2-1/2	9542532
CX0_09380T6	3/32	.0938	2.38	1/8	0.61	3/4	2-1/2	9542397	0.86	1	2-1/2	9542636
CX0_00410T6	#41	.0960	2.44	1/8	0.67	13/16	2-1/2	9542299	0.86	1	3	9542531
CX0_00400T6	#40	.0980	2.49	1/8	0.67	13/16	2-1/2	9542297	0.85	1	3	9542529
CX0_09840T6		.0984	2.50	1/8	0.66	13/16	2-1/2	9542403	0.85	1	3	9542647
CX0_00390T6	#39	.0995	2.53	1/8	0.66	13/16	2-1/2	9542296	1.10	1-1/4	3	9542528
CX0_00380T6	#38	.1015	2.58	1/8	0.66	13/16	2-1/2	9542295	1.10	1-1/4	3	9542526
CX0_00370T6	#37	.1040	2.64	1/8	0.66	13/16	2-1/2	9542294	1.09	1-1/4	3	9542524
CX0_00360T6	#36	.1065	2.71	1/8	0.65	13/16	2-1/2	9542293	1.09	1-1/4	3	9542523
CX0_01094T6	7/64	.1094	2.78	1/8	0.65	13/16	2-1/2	9542311	1.09	1-1/4	3	9542545
CX0_00350T6	#35	.1100	2.79	1/8	0.71	7/8	2-1/2	9542292	1.09	1-1/4	3	9542522
CX0_00340T6	#34	.1110	2.82	1/8	0.71	7/8	2-1/2	9542291	1.08	1-1/4	3	9542521
CX0_00330T6	#33	.1130	2.87	1/8	0.71	7/8	2-1/2	9542290	1.08	1-1/4	3	9542520
CX0_00320T6	#32	.1160	2.95	1/8	0.70	7/8	2-1/2	9542289	1.08	1-1/4	3	9542519
CX0_03000T6		.1181	3.00	1/8	0.70	7/8	2-1/2	9542329	1.07	1-1/4	3	9542553
CX0_00310T6	#31	.1200	3.05	1/8	0.70	7/8	2-1/2	9542288	1.07	1-1/4	3	9542517
CX0_03175T6	1/8	.1250	3.18	1/8	0.69	7/8	2-1/2	9542331	1.06	1-1/4	3	9542556
CX0_00300T6	#30	.1285	3.26	3/16	0.74	15/16	2-1/2	9542285	1.18	1-3/8	3	9542516
CX0_00290T6	#29	.1360	3.45	3/16	0.73	15/16	2-1/2	9542282	1.17	1-3/8	3	9542514
CX0_03500T6		.1378	3.50	3/16	0.73	15/16	2-1/2	9542335	1.17	1-3/8	3	9542563
CX0_00280T6	#28	.1405	3.57	3/16	0.73	15/16	2-1/2	9542281	1.16	1-3/8	3	9542513
CX0_03570T6	9/64	.1406	3.57	3/16	0.79	1	2-1/2	9542337	1.16	1-3/8	3	9542567
CX0_00270T6	#27	.1440	3.66	3/16	0.78	1	2-1/2	9542280	1.16	1-3/8	3	9542511
CX0_00260T6	#26	.1470	3.73	3/16	0.78	1	2-1/2	9542279	1.15	1-3/8	3	9542510
CX0_00250T6	#25	.1495	3.80	3/16	0.78	1	2-1/2	9542278	1.15	1-3/8	3	9542507
CX0_00240T6	#24	.1520	3.86	3/16	0.77	1	2-1/2	9542277	1.15	1-3/8	3	9542506
CX0_00230T6	#23	.1540	3.91	3/16	0.77	1	2-1/2	9542276	1.14	1-3/8	3	9542505
CX0_03970T6	5/32	.1562	3.97	3/16	0.77	1	2-1/2	9542340	1.14	1-3/8	3	9542576
CX0_00220T6	#22	.1570	3.99	3/16	0.83	1-1/16	2-1/2	9542275	1.14	1-3/8	3	9542504
CX0_04000T6		.1575	4.00	3/16	0.83	1-1/16	2-1/2	9542341	1.14	1-3/8	3	9542578
CX0_00210T6	#21	.1590	4.04	3/16	0.82	1-1/16	2-1/2	9542274	1.14	1-3/8	3	9542502
CX0_00200T6	#20	.1610	4.09	3/16	0.82	1-1/16	2-1/2	9542273	1.13	1-3/8	3	9542501
CX0_04200T6		.1654	4.20	3/16	0.81	1-1/16	2-1/2	9542343	1.38	1-5/8	4	9584732
CX0_00190T6	#19	.1660	4.22	3/16	0.81	1-1/16	2-1/2	9542271	1.38	1-5/8	4	9542500
CX0_00180T6	#18	.1695	4.31	3/16	0.81	1-1/16	2-1/2	9542270	1.37	1-5/8	4	9542499
CX0_04370T6	11/64	.1719	4.37	3/16	0.80	1-1/16	2-1/2	9542344	1.37	1-5/8	4	9542582
CX0_00170T6	#17	.1730	4.39	3/16	0.87	1-1/8	3	9542269	1.37	1-5/8	4	9542498
CX0_00160T6	#16	.1770	4.50	3/16	0.86	1-1/8	3	9542268	1.36	1-5/8	4	9542496
CX0_04500T6		.1772	4.50	3/16	0.86	1-1/8	3	9542346	1.36	1-5/8	4	9542585

*Order Example

CX0_06250T6 > 03xD >>> CX00306250T6

CX0_00520T6 > 05xD >>> CX00500520T6

CARBIDE DRILLS

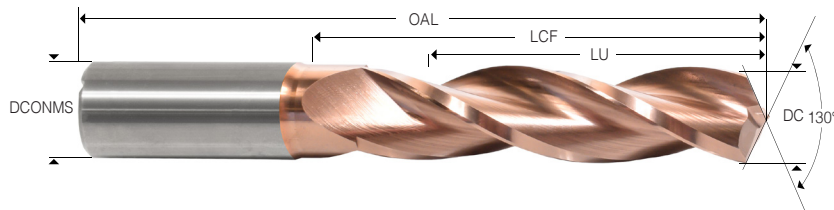

Item Description (Insert 03 or 05 in place of _) *Order Example	**DC Cutting Diameter			DCONMS	3xD Dimensions (mm)				5xD Dimensions (mm)			
	Fraction	Decimal	mm		LU Usable Length	LCF Length Chip Flute	OAL Overall Length	Item Number	LU Usable Length	LCF Length Chip Flute	OAL Overall Length	Item Number
CX0_00150T6	#15	.1800	4.57	3/16	0.86	1-1/8	3	9542267	1.36	1-5/8	4	9542493
CX0_00140T6	#14	.1820	4.62	3/16	0.85	1-1/8	3	9542266	1.35	1-5/8	4	9542492
CX0_00130T6	#13	.1850	4.70	3/16	0.85	1-1/8	3	9542265	1.35	1-5/8	4	9542491
CX0_04760T6	3/16	.1875	4.76	3/16	0.84	1-1/8	3	9542349	1.34	1-5/8	4	9542588
CX0_00120T6	#12	.1890	4.80	1/4	0.90	1-3/16	3	9542264	1.34	1-5/8	4	9542490
CX0_00110T6	#11	.1910	4.85	1/4	0.90	1-3/16	3	9542262	1.34	1-5/8	4	9542489
CX0_00100T6	#10	.1935	4.91	1/4	0.90	1-3/16	3	9542261	1.46	1-3/4	4	9542488
CX0_00090T6	#9	.1960	4.98	1/4	0.89	1-3/16	3	9542232	1.46	1-3/4	4	9542459
CX0_05000T6		.1969	5.00	1/4	0.89	1-3/16	3	9542350	1.45	1-3/4	4	9542590
CX0_00080T6	#8	.1990	5.05	1/4	0.89	1-3/16	3	9542230	1.45	1-3/4	4	9542458
CX0_05100T6		.2008	5.10	1/4	0.89	1-3/16	3	9542351	1.45	1-3/4	4	9592572
CX0_00070T6	#7	.2010	5.11	1/4	0.89	1-3/16	3	9542229	1.45	1-3/4	4	9542457
CX0_05160T6	13/64	.2031	5.16	1/4	0.88	1-3/16	3	9542352	1.45	1-3/4	4	9542592
CX0_00060T6	#6	.2040	5.18	1/4	0.94	1-1/4	3	9542228	1.44	1-3/4	4	9542456
CX0_00050T6	#5	.2055	5.22	1/4	0.94	1-1/4	3	9542226	1.44	1-3/4	4	9542455
CX0_00040T6	#4	.2090	5.31	1/4	0.94	1-1/4	3	9542224	1.44	1-3/4	4	9542454
CX0_00030T6	#3	.2130	5.41	1/4	0.93	1-1/4	3	9542223	1.43	1-3/4	4	9542452
CX0_02165T6		.2165	5.50	1/4	0.93	1-1/4	3	9542321	1.43	1-3/4	4	9542549
CX0_05560T6	7/32	.2188	5.56	1/4	0.92	1-1/4	3	9542355	1.42	1-3/4	4	9542595
CX0_00020T6	#2	.2210	5.61	1/4	0.98	1-5/16	3	9542222	1.42	1-3/4	4	9542451
CX0_00010T6	#1	.2280	5.79	1/4	0.97	1-5/16	3	9542221	1.41	1-3/4	4	9542450
CX0_000A0T6	A	.2340	5.94	1/4	0.96	1-5/16	3	9542233	1.65	2	4	9542460
CX0_05950T6	15/64	.2344	5.95	1/4	0.96	1-5/16	3	9542359	1.65	2	4	9542598
CX0_06000T6		.2362	6.00	1/4	1.02	1-3/8	3	9542360	1.65	2	4	9542599
CX0_000B0T6	B	.2380	6.05	1/4	1.02	1-3/8	3	9542234	1.64	2	4	9542462
CX0_000C0T6	C	.2420	6.15	1/4	1.01	1-3/8	3	9542235	1.64	2	4	9542463
CX0_000D0T6	D	.2460	6.25	1/4	1.01	1-3/8	3	9542236	1.63	2	4	9542464
CX0_06350T6	1/4/E	.2500	6.35	1/4	1.00	1-3/8	3	9542366	1.63	2	4	9542604
CX0_06500T6		.2559	6.50	5/16	1.05	1-7/16	3	9542372	1.62	2	4	9542608
CX0_000F0T6	F	.2570	6.53	5/16	1.05	1-7/16	3	9542237	1.61	2	4	9542465
CX0_000G0T6	G	.2610	6.63	5/16	1.05	1-7/16	3	9542238	1.73	2-1/8	4	9542468
CX0_06750T6	17/64	.2656	6.75	5/16	1.04	1-7/16	3	9542374	1.73	2-1/8	4	9542610
CX0_000H0T6	H	.2660	6.76	5/16	1.10	1-1/2	3	9542240	1.73	2-1/8	4	9542469
CX0_000I0T6	I	.2720	6.91	5/16	1.09	1-1/2	3	9542241	1.72	2-1/8	4	9542470
CX0_07000T6		.2756	7.00	5/16	1.09	1-1/2	3	9542377	1.71	2-1/8	4	9542611
CX0_000J0T6	J	.2770	7.04	5/16	1.08	1-1/2	3	9542242	1.71	2-1/8	4	9542471
CX0_000K0T6	K	.2810	7.14	5/16	1.08	1-1/2	3	9542243	1.70	2-1/8	4	9542472
CX0_07140T6	9/32	.2812	7.14	5/16	1.08	1-1/2	3	9542379	1.70	2-1/8	4	9542613
CX0_000L0T6	L	.2900	7.37	5/16	1.13	1-9/16	4	9542244	1.69	2-1/8	4	9542473
CX0_000M0T6	M	.2950	7.49	5/16	1.12	1-9/16	4	9542245	1.93	2-3/8	4	9542474
CX0_07500T6		.2953	7.50	5/16	1.12	1-9/16	4	9542382	1.93	2-3/8	4	9542616
CX0_07540T6	19/64	.2969	7.54	5/16	1.12	1-9/16	4	9542383	1.93	2-3/8	4	9542617
CX0_000N0T6	N	.3020	7.67	5/16	1.17	1-5/8	4	9542246	1.92	2-3/8	4	9542475
CX0_07940T6	5/16	.3125	7.94	5/16	1.16	1-5/8	4	9542388	1.91	2-3/8	4	9542623
CX0_08000T6		.3150	8.00	3/8	1.22	1-11/16	4	9542389	1.90	2-3/8	4	9542625
CX0_000O0T6	O	.3160	8.03	3/8	1.21	1-11/16	4	9542248	1.90	2-3/8	4	9542476
CX0_000P0T6	P	.3230	8.20	3/8	1.20	1-11/16	4	9542249	1.89	2-3/8	4	9542477
CX0_08330T6	21/64	.3281	8.33	3/8	1.20	1-11/16	4	9542391	2.01	2-1/2	5	9542628
CX0_000Q0T6	Q	.3320	8.43	3/8	1.19	1-11/16	4	9542250	2.00	2-1/2	5	9542478
CX0_08500T6		.3346	8.50	3/8	1.19	1-11/16	4	9542392	2.00	2-1/2	5	9542629
CX0_000R0T6	R	.3390	8.61	3/8	1.18	1-11/16	4	9542251	1.99	2-1/2	5	9542479
CX0_08730T6	11/32	.3438	8.73	3/8	1.17	1-11/16	4	9542394	1.98	2-1/2	5	9542630
CX0_000S0T6	S	.3480	8.84	3/8	1.23	1-3/4	4	9542252	1.98	2-1/2	5	9542480
CX0_09000T6	9	.3543	9.00	3/8	1.22	1-3/4	4	9542395	1.72	2-3/4	5	9542634

*Order Example

CX0_00150T6 > 03xD >>> CX00300150T6

CX0_00150T6 > 05xD >>> CX00500150T6

CARBIDE DRILLS

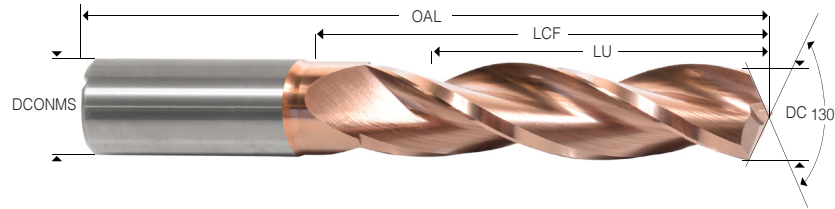

Item Description (Insert 03 or 05 in place of __) *Order Example	**DC Cutting Diameter			DCONMS	3xD Dimensions (mm)				5xD Dimensions (mm)			
	Fraction	Decimal	mm		LU Usable Length	LCF Length Chip Flute	OAL Overall Length	Item Number	LU Usable Length	LCF Length Chip Flute	OAL Overall Length	Item Number
CX0_000T0T6	T	.3580	9.09	3/8	1.21	1-3/4	4	9542253	2.21	2-3/4	5	9542481
CX0_09130T6	23/64	.3594	9.13	3/8	1.21	1-3/4	4	9542396	2.21	2-3/4	5	9542635
CX0_000U0T6	U	.3680	9.35	3/8	1.26	1-13/16	4	9542254	2.20	2-3/4	5	9542482
CX0_09500T6		.3740	9.50	3/8	1.25	1-13/16	4	9542399	2.19	2-3/4	5	9542638
CX0_09520T6	3/8	.3750	9.53	3/8	1.25	1-13/16	4	9542400	2.19	2-3/4	5	9542643
CX0_000V0T6	V	.3770	9.58	7/16	1.31	1-7/8	4	9542255	2.31	2-7/8	5	9542483
CX0_000W0T6	W	.3860	9.80	7/16	1.30	1-7/8	4	9542256	2.30	2-7/8	5	9542484
CX0_09920T6	25/64	.3906	9.92	7/16	1.29	1-7/8	4	9542404	2.29	2-7/8	5	9542648
CX0_10000T6		.3937	10.00	7/16	1.35	1-15/16	4	9542407	2.28	2-7/8	5	9542649
CX0_000X0T6	X	.3970	10.08	7/16	1.34	1-15/16	4	9542257	2.28	2-7/8	5	9542485
CX0_000Y0T6	Y	.4040	10.26	7/16	1.33	1-15/16	4	9542258	2.27	2-7/8	5	9542486
CX0_10320T6	13/32	.4062	10.32	7/16	1.33	1-15/16	4	9542408	2.27	2-7/8	5	9542650
CX0_000Z0T6	Z	.4130	10.49	7/16	1.38	2	4	9542259	2.26	2-7/8	5	9542487
CX0_10500T6		.4134	10.50	7/16	1.38	2	4	9542409	2.25	2-7/8	5	9542651
CX0_10720T6	27/64	.4219	10.72	7/16	1.37	2	4	9542410	2.24	2-7/8	5	9542652
CX0_10800T6		.4252	10.80	7/16	1.36	2	4	9542411	2.24	2-7/8	5	9542653
CX0_11000T6		.4331	11.00	7/16	1.41	2-1/16	4	9542412	2.23	2-7/8	5	9542654
CX0_11110T6	7/16	.4375	11.11	7/16	1.41	2-1/16	4	9542413	2.22	2-7/8	5	9542655
CX0_11500T6		.4528	11.50	1/2	1.45	2-1/8	4	9542414	2.32	3	5	9542657
CX0_11510T6	29/64	.4531	11.51	1/2	1.45	2-1/8	4	9542415	2.32	3	5	9542658
CX0_11910T6	15/32	.4688	11.91	1/2	1.42	2-1/8	4	9542416	2.30	3	5	9542661
CX0_12000T6		.4724	12.00	1/2	1.48	2-3/16	4	9542418	2.29	3	5	9542662
CX0_12300T6	31/64	.4844	12.30	1/2	1.46	2-3/16	4	9542419	2.27	3	5	9542664
CX0_12500T6		.4921	12.50	1/2	1.45	2-3/16	4	9542420	2.26	3	5	9542666
CX0_12700T6	1/2	.5000	12.70	1/2	1.50	2-1/4	5	9542421	2.25	3	5	9542669
CX0_13000T6		.5118	13.00	9/16	2.48	2-3/8	5	9542424	2.48	3-1/4	5	9542670
CX0_13100T6	33/64	.5156	13.10	9/16	2.48	2-3/8	5	9542425	2.48	3-1/4	5	9542671
CX0_13490T6	17/32	.5312	13.49	9/16	2.45	2-3/8	5	9542428	2.45	3-1/4	5	9542673
CX0_13500T6		.5315	13.50	9/16	2.45	2-1/2	5	9542430	2.45	3-1/4	5	9542674
CX0_13890T6	35/64	.5469	13.89	9/16	1.70	3-1/4	5	9584733	2.43	3-1/4	5	9542675
CX0_14000T6		.5512	14.00	9/16	2.42	2-1/2	5	9542433	2.42	3-1/4	5	9542677
CX0_14290T6	9/16	.5625	14.29	9/16	2.41	3	5	9542434	2.41	3-1/4	5	9542680
CX0_14500T6	14.5	.5709	14.50	5/8	2.39	3	5	9584734	2.39	3-1/4	5	9542682
CX0_14680T6	37/64	.5781	14.68	5/8	2.63	3	5	9542435	2.63	3-1/2	6	9542684
CX0_15000T6		.5906	15.00	5/8	2.61	3	5	9584735	2.61	3-1/2	6	9542685
CX0_15080T6	19/32	.5938	15.08	5/8	2.61	3	5	9584736	2.61	3-1/2	6	9542687
CX0_15480T6	39/64	.6094	15.48	5/8	2.59	3	5	9542437	2.59	3-1/2	6	9542688
CX0_15500T6		.6102	15.50	5/8	2.58	3	5	9584737	2.58	3-1/2	6	9542689
CX0_15870T6	5/8	.6250	15.88	5/8	2.56	3	5	9542441	2.56	3-1/2	6	9542693
CX0_16000T6		.6299	16.00	3/4	2.56	3	5	9542444	2.56	3-1/2	6	9542694

***Order Example**

CX0_000T0T6 > 03xD >>> CX003000T0T6

CX0_000T0T6 > 05xD >>> CX005000T0T6

****Other Dimensions are Available Upon Request****

CARBIDE DRILLS



SCAN FOR SPEEDS & FEEDS



**High Performance
Single Margin
Coolant Thru Drill**
**Ideal for Aluminum &
Cast Materials**
3xD-5xD

K N Refer to page 4



SCAN FOR SPEEDS & FEEDS

CARBIDE	3xD to 5xD	130°	30°	
ZircoPlus® provides increased corrosion and abrasion resistance, for maximized machining.				Zirco Plus®

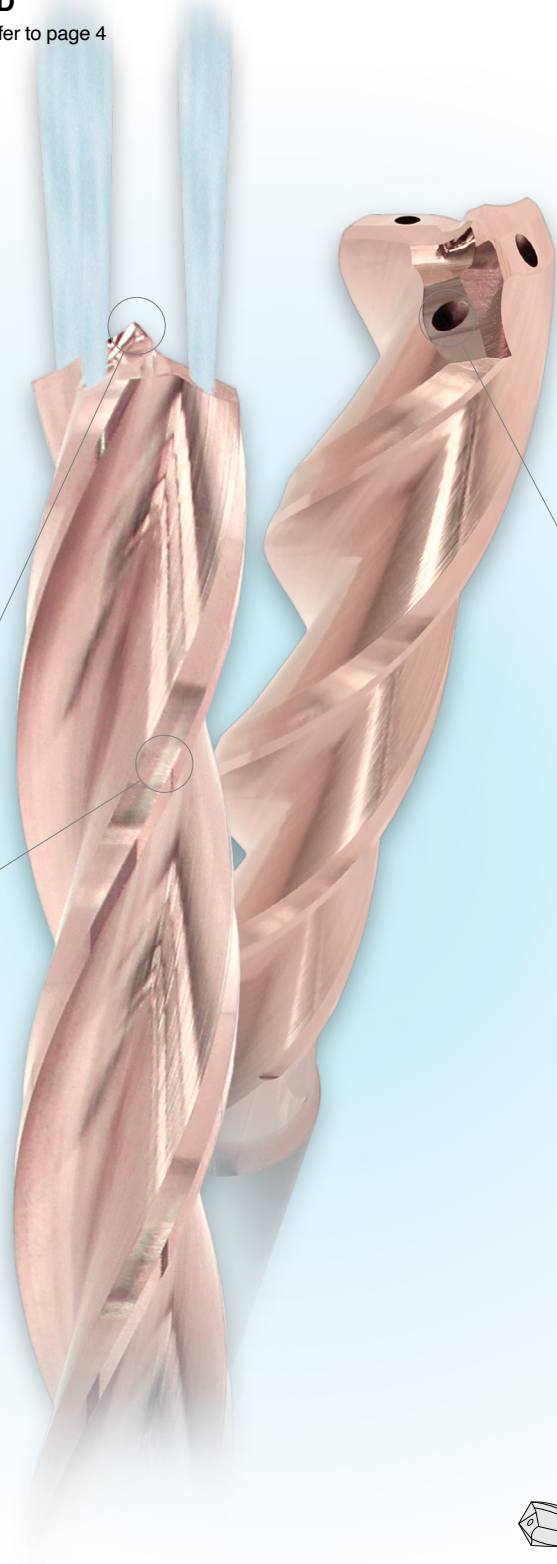

**130° Point Geometry
Self Centering** - Ideal for faster drilling and high feed rates.

Single-Margin Design - For drilling accuracy.

Coolant Holes - Cool the cutting edge and improve chip evacuation.

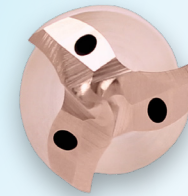

No Pecking Required

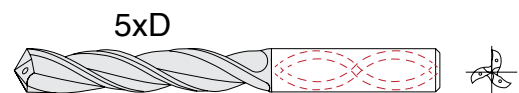
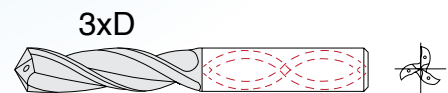
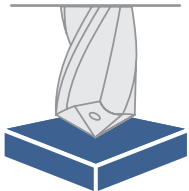



Design – Spiral-fluted, right-hand cut, with internal coolant
Ideal for – Aluminum, cast materials and non ferrous materials
 K N Refer to page 4

CARBIDE **3xD to 5xD** **130°** **30°** **Zirco Plus®** **ZircoPlus®** provides increased corrosion and abrasion resistance, for maximized machining.

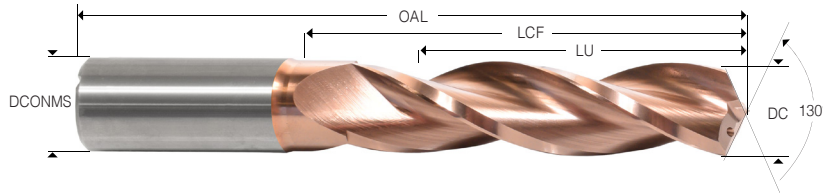

Item Description (Insert 03 or 05 in place of _) *Order Example	**DC Cutting Diameter			DCONMS	3xD Dimensions (mm)				5xD Dimensions (mm)			
	Fraction	Decimal	mm		LU Usable Length	LCF Length Chip Flute	OAL Overall Length	Item Number	LU Usable Length	LCF Length Chip Flute	OAL Overall Length	Item Number
CXC_ _03572T6	9/64	.1406	3.57	6	15	20	62	9542729	23	28	66	9542879
CXC_ _03600T6		.1417	3.60	6	15	20	62	9542730	23	28	66	9542880
CXC_ _03700T6		.1457	3.70	6	14	20	62	9542731	22	28	66	9542882
CXC_ _03800T6		.1496	3.80	6	18	24	66	9542732	30	36	74	9542883
CXC_ _03900T6		.1535	3.90	6	18	24	66	9542733	30	36	74	9542884
CXC_ _03970T6	5/32	.1563	3.97	6	18	24	66	9542734	30	36	74	9542885
CXC_ _04000T6		.1575	4.00	6	18	24	66	9542735	30	36	74	9542886
CXC_ _04100T6		.1614	4.10	6	18	24	66	9542736	30	36	74	9542887
CXC_ _04200T6		.1654	4.20	6	18	24	66	9542737	30	36	74	9542888
CXC_ _04300T6		.1693	4.30	6	18	24	66	9542739	30	36	74	9542890
CXC_ _04370T6	11/64	.1719	4.37	6	17	24	66	9542740	29	36	74	9542891
CXC_ _04400T6		.1732	4.40	6	17	24	66	9542742	29	36	74	9542893
CXC_ _04500T6		.1772	4.50	6	17	24	66	9542743	29	36	74	9542894
CXC_ _04600T6		.1811	4.60	6	17	24	66	9542744	29	36	74	9542896
CXC_ _04650T6		.1831	4.65	6	17	24	66	9542745	29	36	74	9542898
CXC_ _00130T6	#13	.1850	4.70	6	17	24	66	9542720	29	36	74	9542870
CXC_ _04760T6	3/16	.1875	4.76	6	21	28	66	9542746	37	44	82	9542899
CXC_ _00120T6	#12	.1890	4.80	6	21	28	66	9542719	37	44	82	9542869
CXC_ _04900T6		.1929	4.90	6	21	28	66	9542748	37	44	82	9542901
CXC_ _05000T6		.1969	5.00	6	20	28	66	9542749	36	44	82	9542902
CXC_ _05100T6		.2008	5.10	6	20	28	66	9542750	36	44	82	9542905
CXC_ _05160T6	13/64	.2031	5.16	6	20	28	66	9542751	36	44	82	9542906
CXC_ _00060T6	#6	.2040	5.18	6	20	28	66	9542718	36	44	82	9542868
CXC_ _05200T6		.2047	5.20	6	20	28	66	9542752	36	44	82	9542907
CXC_ _05300T6		.2087	5.30	6	20	28	66	9542753	36	44	82	9542908
CXC_ _05400T6		.2126	5.40	6	20	28	66	9542754	36	44	82	9542909
CXC_ _05500T6		.2165	5.50	6	20	28	66	9542755	36	44	82	9542910
CXC_ _05550T6		.2185	5.55	6	20	28	66	9542756	36	44	82	9542911
CXC_ _05560T6	7/32	.2187	5.55	6	20	28	66	9542757	36	44	82	9542912
CXC_ _05600T6		.2205	5.60	6	20	28	66	9542758	36	44	82	9542913
CXC_ _05700T6		.2244	5.70	6	19	28	66	9542759	35	44	82	9542914
CXC_ _05800T6		.2283	5.80	6	19	28	66	9542760	35	44	82	9542915
CXC_ _05900T6		.2323	5.90	6	19	28	66	9542762	35	44	82	9542916
CXC_ _05950T6	15/64	.2344	5.95	6	19	28	66	9542763	35	44	82	9542917
CXC_ _06000T6		.2362	6.00	6	19	28	66	9542764	35	44	82	9542918
CXC_ _06100T6		.2402	6.10	8	25	34	79	9542765	44	53	91	9542919
CXC_ _06200T6		.2441	6.20	8	25	34	79	9542766	44	53	91	9542920
CXC_ _06300T6		.2480	6.30	8	25	34	79	9542767	44	53	91	9542921
CXC_ _06350T6	1/4	.2500	6.35	8	24	34	79	9542769	43	53	91	9542923
CXC_ _06400T6		.2520	6.40	8	24	34	79	9542770	43	53	91	9542924
CXC_ _06500T6		.2559	6.50	8	24	34	79	9542772	43	53	91	9542926
CXC_ _06600T6		.2598	6.60	8	24	34	79	9542773	43	53	91	9542927
CXC_ _06700T6		.2638	6.70	8	24	34	79	9542774	43	53	91	9542928

***Order Example**

CXC_ _03572T6 > 03xD >>> CXC0303572T6

CXC_ _03572T6 > 05xD >>> CXC0503572T6

Other Dimensions are Available Upon Request

CARBIDE DRILLS

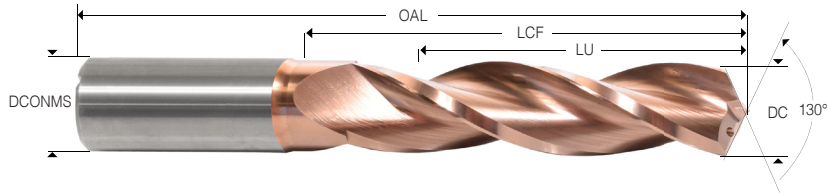

Item Description (Insert 03 or 05 in place of _ _) *Order Example	**DC Cutting Diameter			DCONMS	3xD Dimensions (mm)				5xD Dimensions (mm)			
	Fraction	Decimal	mm		LU Usable Length	LCF Length Chip Flute	OAL Overall Length	Item Number	LU Usable Length	LCF Length chip flute	OAL Overall Length	Item Number
CXC_06750T6	17/64	.2656	6.75	8	24	34	79	9542775	43	53	91	9542929
CXC_06800T6		.2677	6.80	8	24	34	79	9542777	43	53	91	9542930
CXC_06900T6		.2717	6.90	8	31	41	79	9542778	43	53	91	9542931
CXC_07000T6		.2756	7.00	8	31	41	79	9542779	42	53	91	9542932
CXC_07100T6		.2795	7.10	8	30	41	79	9542780	42	53	91	9542933
CXC_07140T6	9/32	.2813	7.15	8	30	41	79	9542781	42	53	91	9542934
CXC_07200T6		.2835	7.20	8	30	41	79	9542782	42	53	91	9542935
CXC_07300T6		.2874	7.30	8	30	41	79	9542783	42	53	91	9542936
CXC_07400T6		.2913	7.40	8	30	41	79	9542784	42	53	91	9542938
CXC_07500T6		.2953	7.50	8	30	41	79	9542785	42	53	91	9542939
CXC_07540T6	19/64	.2969	7.54	8	30	41	79	9542786	42	53	91	9542940
CXC_07700T6		.3031	7.70	8	29	41	79	9542787	41	53	91	9542941
CXC_07800T6		.3071	7.80	8	29	41	79	9542788	41	53	91	9542942
CXC_07900T6		.3110	7.90	8	29	41	79	9542789	41	53	91	9542943
CXC_07940T6	5/16	.3125	7.94	8	29	41	79	9542790	41	53	91	9542944
CXC_08000T6		.3150	8.00	8	29	41	79	9542791	41	53	91	9542945
CXC_08100T6		.3189	8.10	10	35	47	89	9542792	49	61	103	9542947
CXC_08200T6		.3228	8.20	10	35	47	89	9542793	49	61	103	9542948
CXC_08300T6		.3268	8.30	10	35	47	89	9542795	49	61	103	9542949
CXC_08330T6	21/64	.3281	8.33	10	35	47	89	9542796	49	61	103	9542950
CXC_08400T6		.3307	8.40	10	34	47	89	9542797	48	61	103	9542951
CXC_08500T6		.3346	8.50	10	34	47	89	9542798	48	61	103	9542952
CXC_08600T6		.3386	8.60	10	34	47	89	9542799	48	61	103	9542953
CXC_08700T6		.3425	8.70	10	34	47	89	9542800	48	61	103	9542954
CXC_08730T6	11/32	.3437	8.73	10	34	47	89	9542801	48	61	10	9542955
CXC_08800T6		.3465	8.80	10	34	47	89	9542802	48	61	103	9542956
CXC_09000T6		.3543	9.00	10	34	47	89	9542803	48	61	103	9542957
CXC_09130T6	23/64	.3594	9.13	10	33	47	89	9542804	47	61	103	9542958
CXC_09200T6		.3622	9.20	10	33	47	89	9542805	47	61	103	9542959
CXC_09300T6	9.35	.3661	9.30	10	33	47	89	9542806	47	61	103	9542961
CXC_09500T6		.3740	9.50	10	33	47	89	9542807	47	61	103	9542963
CXC_09520T6	3/8	.3750	9.53	10	33	47	89	9542808	47	61	103	9542964
CXC_09600T6		.3780	9.60	10	33	47	89	9542811	47	61	103	9542965
CXC_09800T6		.3858	9.80	10	32	47	89	9542812	46	61	103	9542966
CXC_09900T6		.3898	9.90	10	32	47	89	9542813	46	61	103	9542967
CXC_09920T6	25/64	.3906	9.92	10	32	47	89	9542814	46	61	103	9542968
CXC_10000T6		.3937	10.00	10	32	47	89	9542815	46	61	103	9542969
CXC_10100T6		.3976	10.10	12	40	55	102	9542816	56	71	118	9542970
CXC_10200T6		.4016	10.20	12	40	55	102	9542817	56	71	118	9542971
CXC_10300T6		.4055	10.30	12	40	55	102	9542818	56	71	118	9542972
CXC_10320T6	13/32	.4063	10.32	12	40	55	102	9542819	56	71	118	9542974
CXC_10400T6		.4094	10.40	12	39	55	102	9542820	55	71	118	9542975
CXC_10500T6		.4134	10.50	12	39	55	102	9542821	55	71	118	9542976
CXC_10720T6	27/64	.4219	10.72	12	39	55	102	9542822	55	71	118	9542977
CXC_10800T6		.4252	10.80	12	39	55	102	9542823	55	71	118	9542979
CXC_11000T6		.4331	11.00	12	38	55	102	9542825	55	71	118	9542980
CXC_11100T6		.4370	11.10	12	38	55	102	9542826	54	71	118	9542981
CXC_11113T6	7/16	.4375	11.11	12	38	55	102	9542827	54	71	118	9542982
CXC_11200T6		.4409	11.20	12	38	55	102	9542828	54	71	118	9542983
CXC_11500T6		.4528	11.50	12	38	55	102	9542829	54	71	118	9542984
CXC_11510T6	29/64	.4531	11.51	12	38	55	102	9542830	54	71	118	9542986

*Order Example

CXC_06750T6 > 03xD >>> CXC0306750T6

CXC_06750T6 > 05xD >>> CXC0506750T6

Other Dimensions are Available Upon Request

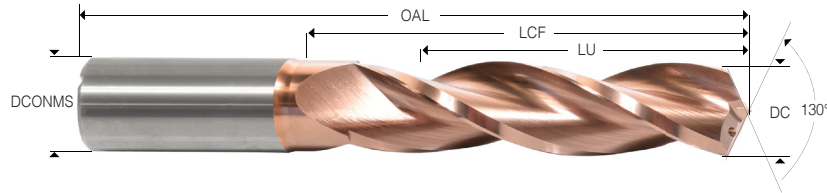

Item Description (Insert 03 or 05 in place of _) *Order Example	**DC Cutting Diameter			DCONMS	3xD Dimensions (mm)				5xD Dimensions (mm)			
	Fraction	Decimal	mm		LU Usable Length	LCF Length Chip Flute	OAL Overall Length	Item Number	LU Usable Length	LCF Length Chip Flute	OAL Overall Length	Item Number
CXC_ _11700T6		.4606	11.70	12	37	55	102	9542831	53	71	118	9542987
CXC_ _11800T6		.4646	11.80	12	37	55	102	9542832	53	71	118	9542988
CXC_ _11910T6	15/32	.4687	11.90	12	37	55	102	9542833	53	71	118	9542989
CXC_ _12000T6		.4724	12.00	12	37	55	102	9542834	53	71	118	9542990
CXC_ _12100T6		.4764	12.10	14	42	60	107	9542835	59	71	124	9542991
CXC_ _12200T6		.4803	12.20	14	42	60	107	9542836	59	77	124	9542992
CXC_ _12300T6		.4843	12.30	14	42	60	107	9542837	59	77	124	9542993
CXC_ _12303T6	31/64	.4844	12.30	14	42	60	107	9542838	59	77	124	9542994
CXC_ _12500T6		.4921	12.50	14	41	60	107	9542839	58	77	124	9542995
CXC_ _12600T6		.4961	12.60	14	41	60	107	9542840	58	77	124	9542996
CXC_ _12700T6	1/2	.5000	12.70	14	41	60	107	9542842	58	77	124	9542997
CXC_ _13000T6		.5118	13.00	14	41	60	107	9542845	58	77	124	9542998
CXC_ _13300T6		.5236	13.30	14	40	60	107	9542846	57	77	124	9543000
CXC_ _13490T6	17/32	.5313	13.50	14	40	60	107	9542847	57	77	124	9543001
CXC_ _13500T6		.5315	13.50	14	40	60	107	9542848	57	77	124	9543002
CXC_ _14000T6		.5512	14.00	14	39	60	107	9542849	56	77	124	9543004
CXC_ _14290T6	9/16	.5625	14.29	16	44	65	115	9542850	62	83	133	9543005
CXC_ _14500T6		.5709	14.50	16	43	65	115	9542851	61	83	133	9543006
CXC_ _15000T6		.5906	15.00	16	42	65	115	9542852	60	83	133	9543007
CXC_ _15500T6		.6102	15.50	16	42	65	115	9542853	60	83	133	9543008
CXC_ _15870T6	5/8	.6250	15.88	16	41	65	115	9542854	59	83	133	9543009
CXC_ _16000T6		.6299	16.00	16	41	65	115	9542855	59	83	133	9543010
CXC_ _16500T6		.6496	16.50	18	48	73	123	9542856	68	93	143	9543012
CXC_ _17000T6		.6693	17.00	18	48	73	123	9542858	68	93	143	9543014
CXC_ _17500T6		.6890	17.50	18	47	73	123	9542860	67	93	143	9543016
CXC_ _18000T6		.7087	18.00	18	46	73	123	9542861	66	93	143	9543017
CXC_ _18500T6		.7283	18.50	20	51	79	131	9542863	73	101	153	9543018
CXC_ _19050T6	3/4	.7500	19.05	20	50	79	131	9542864	72	101	153	9543019
CXC_ _19500T6		.7677	19.50	20	50	79	131	9542865	72	101	153	9543020
CXC_ _20000T6		.7874	20.00	20	49	79	131	9542866	71	101	153	9543021

*Order Example

CXC_ _11700T6 > 03xD >>> CXC0311700T6

CXC_ _11700T6 > 05xD >>> CXC0511700T6

Other Dimensions are Available Upon Request

CARBIDE DRILLS



SCAN FOR SPEEDS & FEEDS



High Performance Triple Margin Coolant Thru Drill
Ideal for Gray Cast Iron and Ductile Iron
3xD-30xD

K Refer to page 4



SCAN FOR SPEEDS & FEEDS

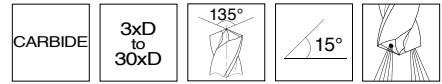

Varianta® Supral Provides a low coefficient of friction, reducing tool wear and resulting in a longer tool life.

Varianta® Supral

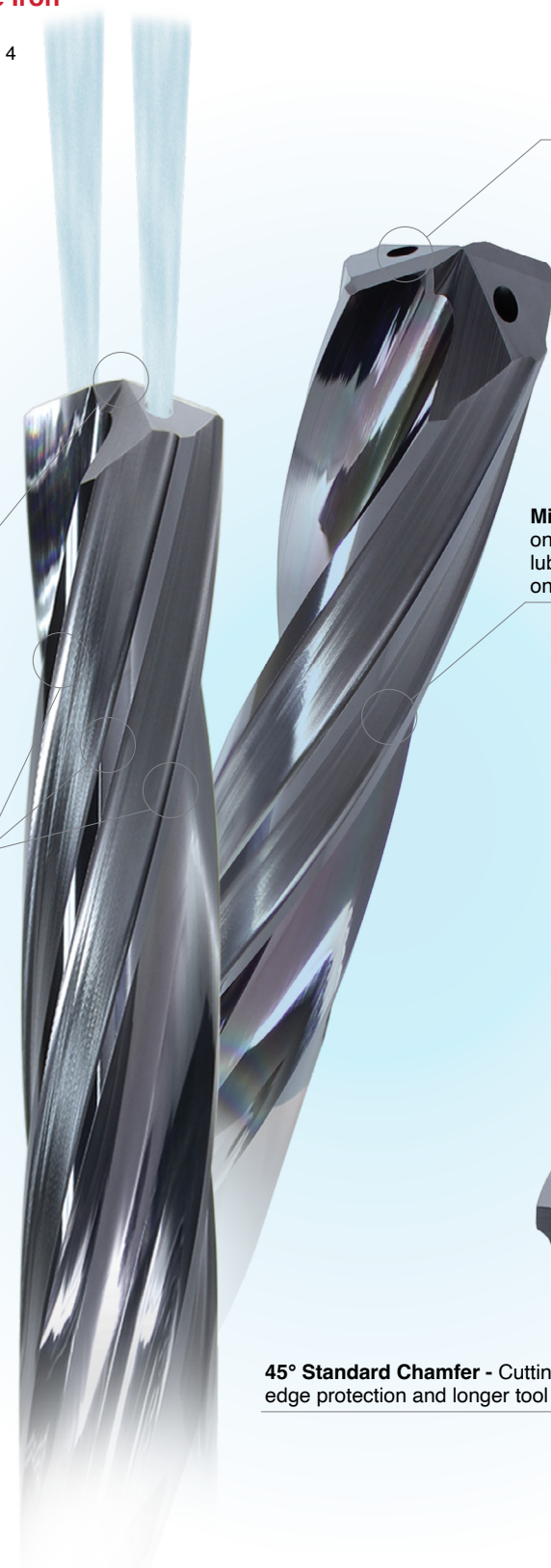

Coolant Holes - Cool the cutting edge and improve chip evacuation.

135° Point Geometry - Split-point geometry for superior drill penetration and accuracy.

Mirror Polished Flutes - on 12xD-30xD polish process adds lubricity for better chip evacuation on deep hole drilling.

Triple-Margin Design - Ideal for improving surface finish and increasing stability.

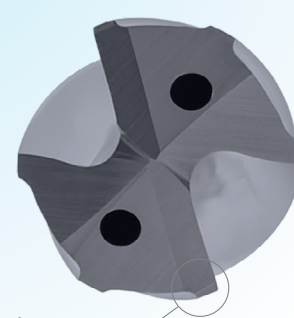

45° Standard Chamfer - Cutting edge protection and longer tool life.

Design – Long spiral-fluted, 45° corner chamfer, triple-margin, right-hand cut and internal coolant.

Ideal for – Gray cast iron and ductile iron

K Refer to page 4

No Pecking Required

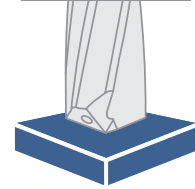

3xD

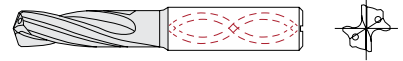

5xD

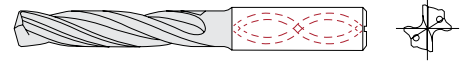

8xD



12xD



16xD



20xD

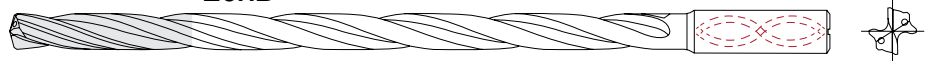

25xD



30xD

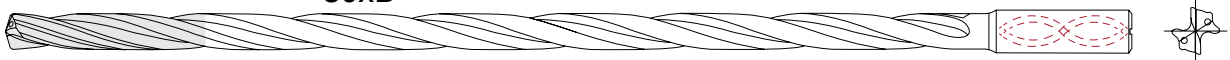

16xD – 30xD must utilize a pilot hole drill. Refer to page 77



Design – Long spiral-fluted, 45° corner chamfer, triple-margin, right-hand cut and internal coolant.
Ideal for – Gray cast iron and ductile iron

Refer to page 4



Varianta® Supral Provides a low coefficient of friction, reducing tool wear and resulting in a longer tool life.

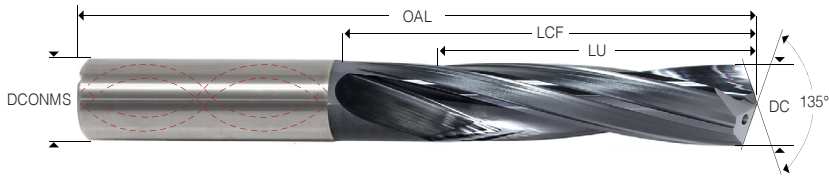

Item Description (Insert 03 or 05 in place of _) *Order Example	**DC Cutting Diameter			DCONMS	3xD Dimensions (mm)				5xD Dimensions (mm)			
	Fraction	Decimal	mm		LU Usable Length	LCF Length Chip Flute	OAL Overall Length	Item Number	LU Usable Length	LCF Length Chip Flute	OAL Overall Length	Item Number
IXC__03000T9		.1181	3.00	6	16	20	62	9549476	24	28	66	9549620
IXC__03100T9		.1220	3.10	6	15	20	62	9549477	23	28	66	9549621
IXC__03175T9	1/8	.1250	3.18	6	15	20	62	9549478	23	28	66	9549622
IXC__03200T9		.1260	3.20	6	15	20	62	9549479	23	28	66	9549623
IXC__03300T9		.1299	3.30	6	15	20	62	9549480	23	28	66	9549624
IXC__03400T9		.1339	3.40	6	15	20	62	9549481	23	28	66	9549625
IXC__03500T9		.1378	3.50	6	15	20	62	9549482	23	28	66	9549626
IXC__03572T9	9/64	.1406	3.57	6	15	20	62	9549483	23	28	66	9549627
IXC__03600T9		.1417	3.60	6	15	20	62	9549484	23	28	66	9549628
IXC__03700T9		.1457	3.70	6	14	20	62	9549485	22	28	66	9549629
IXC__03800T9		.1496	3.80	6	18	24	66	9549486	30	36	74	9549630
IXC__03900T9		.1535	3.90	6	18	24	66	9549487	30	36	74	9549631
IXC__03970T9	5/32	.1563	3.97	6	18	24	66	9549488	30	36	74	9549632
IXC__04000T9		.1575	4.00	6	18	24	66	9549489	30	36	74	9549633
IXC__04100T9		.1614	4.10	6	18	24	66	9549490	30	36	74	9549634
IXC__04200T9		.1654	4.20	6	18	24	66	9549491	30	36	74	9549635
IXC__04300T9		.1693	4.30	6	18	24	66	9549492	30	36	74	9549636
IXC__04370T9	11/64	.1719	4.37	6	17	24	66	9549493	29	36	74	9549637
IXC__04400T9		.1732	4.40	6	17	24	66	9549495	29	36	74	9549639
IXC__04500T9		.1772	4.50	6	17	24	66	9549496	29	36	74	9549640
IXC__04600T9		.1811	4.60	6	17	24	66	9549497	29	36	74	9549641
IXC__04650T9		.1831	4.65	6	17	24	66	9549498	29	36	74	9549642
IXC__00130T9	#13	.1850	4.70	6	17	24	66	9549475	29	36	74	9549619
IXC__04760T9	3/16	.1875	4.76	6	21	28	66	9549499	37	44	82	9549643
IXC__00120T9	#12	.1890	4.80	6	21	28	66	9549474	37	44	82	9549618
IXC__04900T9		.1929	4.90	6	21	28	66	9549501	37	44	82	9549645
IXC__05000T9		.1969	5.00	6	20	28	66	9549502	36	44	82	9549646
IXC__05100T9		.2008	5.10	6	20	28	66	9549503	36	44	82	9549647
IXC__05160T9	13/64	.2031	5.16	6	20	28	66	9549504	36	44	82	9549648
IXC__00060T9	#6	.2040	5.18	6	20	28	66	9549473	36	44	82	9549617
IXC__05200T9		.2047	5.20	6	20	28	66	9549505	36	44	82	9549649
IXC__05300T9		.2087	5.30	6	20	28	66	9549506	36	44	82	9549650
IXC__05400T9		.2126	5.40	6	20	28	66	9549507	36	44	82	9549651
IXC__05500T9		.2165	5.50	6	20	28	66	9549508	36	44	82	9549652
IXC__05550T9		.2185	5.55	6	20	28	66	9549509	36	44	82	9549653
IXC__05560T9	7/32	.2187	5.55	6	20	28	66	9549510	36	44	82	9549654
IXC__05600T9		.2205	5.60	6	20	28	66	9549511	36	44	82	9549655
IXC__05700T9		.2244	5.70	6	19	28	66	9549512	35	44	82	9549656
IXC__05800T9		.2283	5.80	6	19	28	66	9549513	35	44	82	9549657
IXC__05900T9		.2323	5.90	6	19	28	66	9549514	35	44	82	9549658
IXC__05950T9	15/64	.2344	5.95	6	19	28	66	9549515	35	44	82	9549659
IXC__06000T9		.2362	6.00	6	19	28	66	9549516	35	44	82	9549660
IXC__06100T9		.2402	6.10	8	25	34	79	9549517	44	53	91	9549661

*Order Example

IXC__03000T9 > 03xD >>> IXC0303000T9

IXC__03000T9 > 05xD >>> IXC0503000T9

** Diameters (2.0-2.9mm) and other dimensions are available upon request**

CARBIDE DRILLS

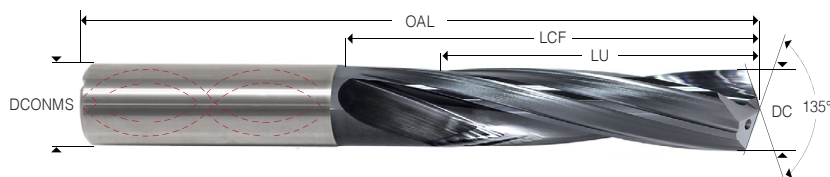

Item Description (Insert 03 or 05 in place of _)	**DC Cutting Diameter		DCONMS	3xD Dimensions (mm)				5xD Dimensions (mm)				
	Fraction	Decimal		mm	LU Usable Length	LCF Length Chip Flute	OAL Overall Length	Item Number	LU Usable Length	LCF Length Chip Flute	OAL Overall Length	Item Number
IXC_06200T9		.2441	6.20	8	25	34	79	9549518	44	53	91	9549662
IXC_06300T9		.2480	6.30	8	25	34	79	9549519	44	53	91	9549663
IXC_06350T9	1/4	.2500	6.35	8	24	34	79	9549520	43	53	91	9549664
IXC_06400T9		.2520	6.40	8	24	34	79	9549521	43	53	91	9549665
IXC_06500T9		.2559	6.50	8	24	34	79	9549522	43	53	91	9549666
IXC_06600T9		.2598	6.60	8	24	34	79	9549523	43	53	91	9549667
IXC_06700T9		.2638	6.70	8	24	34	79	9549524	43	53	91	9549668
IXC_06750T9	17/64	.2656	6.75	8	24	34	79	9549525	43	53	91	9549669
IXC_06800T9		.2677	6.80	8	24	34	79	9549526	43	53	91	9549670
IXC_06900T9		.2717	6.90	8	31	41	79	9549528	43	53	91	9549671
IXC_07000T9		.2756	7.00	8	31	41	79	9549529	42	53	91	9549672
IXC_07100T9		.2795	7.10	8	30	41	79	9549531	42	53	91	9549673
IXC_07140T9	9/32	.2813	7.15	8	30	41	79	9549532	42	53	91	9549674
IXC_07200T9		.2835	7.20	8	30	41	79	9549533	42	53	91	9549675
IXC_07300T9		.2874	7.30	8	30	41	79	9549534	42	53	91	9549676
IXC_07400T9		.2913	7.40	8	30	41	79	9549535	42	53	91	9549677
IXC_07500T9		.2953	7.50	8	30	41	79	9549536	42	53	91	9549678
IXC_07540T9	19/64	.2969	7.54	8	30	41	79	9549537	42	53	91	9549679
IXC_07700T9		.3031	7.70	8	29	41	79	9549538	41	53	91	9549680
IXC_07800T9		.3071	7.80	8	29	41	79	9549540	41	53	91	9549681
IXC_07900T9		.3110	7.90	8	29	41	79	9549541	41	53	91	9549682
IXC_07940T9	5/16	.3125	7.94	8	29	41	79	9549543	41	53	91	9549683
IXC_08000T9		.3150	8.00	8	29	41	79	9549544	41	53	91	9549684
IXC_08100T9		.3189	8.10	10	35	47	89	9549545	49	61	103	9549685
IXC_08200T9		.3228	8.20	10	35	47	89	9549546	49	61	103	9549686
IXC_08300T9		.3268	8.30	10	35	47	89	9549547	49	61	103	9549687
IXC_08330T9	21/64	.3281	8.33	10	35	47	89	9549548	49	61	103	9549688
IXC_08400T9		.3307	8.40	10	34	47	89	9549549	48	61	103	9549689
IXC_08500T9		.3346	8.50	10	34	47	89	9549550	48	61	103	9549690
IXC_08600T9		.3386	8.60	10	34	47	89	9549552	48	61	103	9549691
IXC_08700T9		.3425	8.70	10	34	47	89	9549554	48	61	103	9549692
IXC_08730T9	11/32	.3437	8.73	10	34	47	89	9549555	48	61	103	9549693
IXC_08800T9		.3465	8.80	10	34	47	89	9549556	48	61	103	9549694
IXC_09000T9		.3543	9.00	10	34	47	89	9549557	48	61	103	9549695
IXC_09130T9	23/64	.3594	9.13	10	33	47	89	9549558	47	61	103	9549696
IXC_09200T9		.3622	9.20	10	33	47	89	9549559	47	61	103	9549697
IXC_09300T9		.3661	9.30	10	33	47	89	9549560	47	61	103	9549698
IXC_09500T9		.3740	9.50	10	33	47	89	9549561	47	61	103	9549699
IXC_09520T9	3/8	.3750	9.53	10	33	47	89	9549562	47	61	103	9549700
IXC_09600T9		.3780	9.60	10	33	47	89	9549563	47	61	103	9549701
IXC_09800T9		.3858	9.80	10	32	47	89	9549564	46	61	103	9549702
IXC_09900T9		.3898	9.90	10	32	47	89	9549565	46	61	103	9549703
IXC_09920T9	25/64	.3906	9.92	10	32	47	89	9549566	46	61	103	9549704
IXC_10000T9		.3937	10.00	10	32	47	89	9549567	46	61	103	9549705
IXC_10100T9		.3976	10.10	12	40	55	102	9549568	56	71	118	9549706
IXC_10200T9		.4016	10.20	12	40	55	102	9549569	56	71	118	9549707
IXC_10300T9		.4055	10.30	12	40	55	102	9549570	56	71	118	9549708
IXC_10320T9	13/32	.4063	10.32	12	40	55	102	9549571	56	71	118	9549709
IXC_10400T9		.4094	10.40	12	39	55	102	9549572	55	71	118	9549710
IXC_10500T9		.4134	10.50	12	39	55	102	9549573	55	71	118	9549711
IXC_10720T9	27/64	.4219	10.72	12	39	55	102	9549574	55	71	118	9549712
IXC_10800T9		.4252	10.80	12	39	55	102	9549576	55	71	118	9549714

***Order Example**

IXC_06200T9 > 03xD >>> IXC0306200T9

IXC_06200T9 > 05xD >>> IXC0506200T9

** Diameters (2.0-2.9mm) and other dimensions are available upon request**

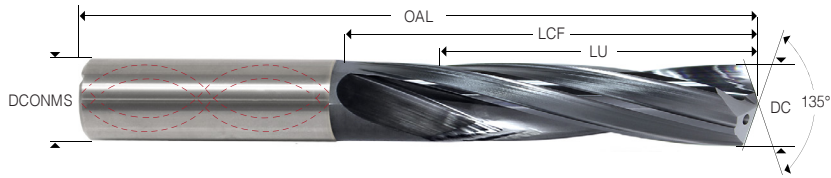

Item Description (Insert 03 or 05 in place of _)	**DC Cutting Diameter			DCONMS	3xD Dimensions (mm)				5xD Dimensions (mm)			
	Fraction	Decimal	mm		LU Usable Length	LCF Length Chip Flute	OAL Overall Length	Item Number	LU Usable Length	LCF Length Chip Flute	OAL Overall Length	Item Number
IXC_ _11000T9		.4331	11.00	12	38	55	102	9549577	55	71	118	9549717
IXC_ _11100T9		.4370	11.10	12	38	55	102	9549578	54	71	118	9549718
IXC_ _11113T9	7/16	.4375	11.11	12	38	55	102	9549579	54	71	118	9549719
IXC_ _11200T9		.4409	11.20	12	38	55	102	9549580	54	71	118	9549720
IXC_ _11500T9		.4528	11.50	12	38	55	102	9549581	54	71	118	9549721
IXC_ _11510T9	29/64	.4531	11.51	12	38	55	102	9549582	54	71	118	9549722
IXC_ _11700T9		.4606	11.70	12	37	55	102	9549583	53	71	118	9549723
IXC_ _11800T9		.4646	11.80	12	37	55	102	9549584	53	71	118	9549724
IXC_ _11910T9	15/32	.4687	11.90	12	37	55	102	9549585	53	71	118	9549725
IXC_ _12000T9		.4724	12.00	12	37	55	102	9549586	53	71	118	9549726
IXC_ _12100T9		.4764	12.10	14	42	60	107	9549587	59	77	124	9549728
IXC_ _12200T9		.4803	12.20	14	42	60	107	9549588	59	77	124	9549729
IXC_ _12300T9		.4843	12.30	14	42	60	107	9549589	59	77	124	9549730
IXC_ _12303T9	31/64	.4844	12.30	14	42	60	107	9549590	59	77	124	9549731
IXC_ _12500T9		.4921	12.50	14	41	60	107	9549591	58	77	124	9549732
IXC_ _12600T9		.4961	12.60	14	41	60	107	9549592	58	77	124	9549733
IXC_ _12700T9	1/2	.5000	12.70	14	41	60	107	9549593	58	77	124	9549734
IXC_ _13000T9		.5118	13.00	14	41	60	107	9549594	58	77	124	9549735
IXC_ _13300T9		.5236	13.30	14	40	60	107	9549595	57	77	124	9549736
IXC_ _13490T9	17/32	.5313	13.50	14	40	60	107	9549596	57	77	124	9549737
IXC_ _13500T9		.5315	13.50	14	40	60	107	9549597	57	77	124	9549738
IXC_ _14000T9		.5512	14.00	14	39	60	107	9549598	56	77	124	9549739
IXC_ _14290T9	9/16	.5625	14.29	16	44	65	115	9549600	62	83	133	9549740
IXC_ _14500T9		.5709	14.50	16	43	65	115	9549601	61	83	133	9549741
IXC_ _15000T9		.5906	15.00	16	42	65	115	9549602	60	83	133	9549742
IXC_ _15500T9		.6102	15.50	16	42	65	115	9549603	60	83	133	9549743
IXC_ _15870T9	5/8	.6250	15.88	16	41	65	115	9549604	59	83	133	9549744
IXC_ _16000T9		.6299	16.00	16	41	65	115	9549605	59	83	133	9549745
IXC_ _16500T9		.6496	16.50	18	48	73	123	9549606	68	93	143	9549746
IXC_ _17000T9		.6693	17.00	18	48	73	123	9549607	68	93	143	9549747
IXC_ _17500T9		.6890	17.50	18	47	73	123	9549609	67	93	143	9549748
IXC_ _18000T9		.7087	18.00	18	46	73	123	9549610	66	93	143	9549749
IXC_ _18500T9		.7283	18.50	20	51	79	131	9549611	73	101	153	9549750
IXC_ _19050T9	3/4	.7500	19.05	20	50	79	131	9549612	72	101	153	9549751
IXC_ _19500T9		.7677	19.50	20	50	79	131	9549614	72	101	153	9549752
IXC_ _20000T9		.7874	20.00	20	49	79	131	9549615	71	101	153	9549753

***Order Example**

IXC_ _11000T9 > 03xD >>> IXC0306200T9

IXC_ _11000T9 > 05xD >>> IXC0506200T9

** Diameters (2.0-2.9mm) and other dimensions are available upon request**

CARBIDE DRILLS



SCAN FOR SPEEDS & FEEDS

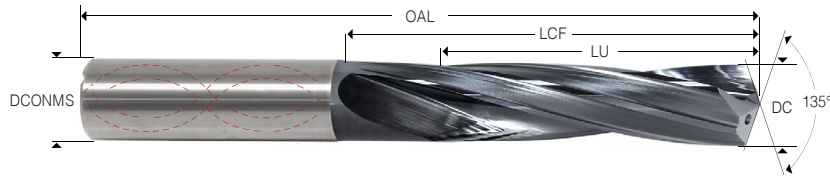

Item Description (Insert 08 or 12 in place of _ _) *Order Example	**DC Cutting Diameter		DCONMS	8xD Dimensions (mm)				12xD Dimensions (mm)				
	Fraction	Decimal		mm	LU Usable Length	LCF Length Chip Flute	OAL Overall Length	Item Number	LU Usable Length	LCF Length Chip Flute	OAL Overall Length	Item Number
IXC_03000T9		.1181	3.00	6	30	34	72	9549758	49	54	92	9549899
IXC_03100T9		.1220	3.10	6	29	34	72	9549759	49	54	92	9549900
IXC_03175T9	1/8	.1250	3.18	6	29	34	72	9549760	49	54	92	9549901
IXC_03200T9		.1260	3.20	6	29	34	72	9549761	49	54	92	9549902
IXC_03300T9		.1299	3.30	6	29	34	72	9549762	49	54	92	9549903
IXC_03400T9		.1339	3.40	6	29	34	72	9549763	49	54	92	9549904
IXC_03500T9		.1378	3.50	6	29	34	72	9549764	49	54	92	9549905
IXC_03572T9	9/64	.1406	3.57	6	29	34	72	9549765	49	54	92	9549906
IXC_03600T9		.1417	3.60	6	29	34	72	9549766	49	54	92	9549907
IXC_03700T9		.1457	3.70	6	28	34	72	9549767	48	54	92	9549908
IXC_03800T9		.1496	3.80	6	37	43	81	9549768	58	64	102	9549909
IXC_03900T9		.1535	3.90	6	37	43	81	9549769	58	64	102	9549910
IXC_03970T9	5/32	.1563	3.97	6	37	43	81	9549770	58	64	102	9549911
IXC_04000T9		.1575	4.00	6	37	43	81	9549771	58	64	102	9549912
IXC_04100T9		.1614	4.10	6	37	43	81	9549773	58	64	102	9549913
IXC_04200T9		.1654	4.20	6	37	43	81	9549774	58	64	102	9549914
IXC_04300T9		.1693	4.30	6	37	43	81	9549775	58	64	102	9549915
IXC_04370T9	11/64	.1719	4.37	6	36	43	81	9549776	57	64	102	9549916
IXC_04400T9		.1732	4.40	6	36	43	81	9549778	57	64	102	9549918
IXC_04500T9		.1772	4.50	6	36	43	81	9549779	57	64	102	9549919
IXC_04600T9		.1811	4.60	6	36	43	81	9549780	57	64	102	9549920
IXC_04650T9		.1831	4.65	6	36	43	81	9549781	57	64	102	9549921
IXC_00130T9	#13	.1850	4.70	6	36	43	81	9549757	57	64	102	9549898
IXC_04760T9	3/16	.1875	4.76	6	50	57	95	9549782	71	78	116	9549922
IXC_00120T9	#12	.1890	4.80	6	50	57	95	9549756	71	78	116	9549897
IXC_04900T9		.1929	4.90	6	50	57	95	9549784	71	78	116	9549924
IXC_05000T9		.1969	5.00	6	49	57	95	9549785	70	78	116	9549925
IXC_05100T9		.2008	5.10	6	49	57	95	9549786	70	78	116	9549926
IXC_05160T9	13/64	.2031	5.16	6	49	57	95	9549787	70	78	116	9549927
IXC_00060T9	#6	.2040	5.18	6	49	57	95	9549755	70	78	116	9549895
IXC_05200T9		.2047	5.20	6	49	57	95	9549788	70	78	116	9549928
IXC_05300T9		.2087	5.30	6	49	57	95	9549789	70	78	116	9549929
IXC_05400T9		.2126	5.40	6	49	57	95	9549790	70	78	116	9549930
IXC_05500T9		.2165	5.50	6	49	57	95	9549791	70	78	116	9549931
IXC_05550T9		.2185	5.55	6	49	57	95	9549792	70	78	116	9549932
IXC_05560T9	7/32	.2187	5.55	6	49	57	95	9549793	70	78	116	9549933
IXC_05600T9		.2205	5.60	6	49	57	95	9549794	70	78	116	9549934
IXC_05700T9		.2244	5.70	6	48	57	95	9549795	69	78	116	9549935
IXC_05800T9		.2283	5.80	6	48	57	95	9549796	69	78	116	9549936
IXC_05900T9		.2323	5.90	6	48	57	95	9549797	69	78	116	9549937
IXC_05950T9	15/64	.2344	5.95	6	48	57	95	9549798	69	78	116	9549938
IXC_06000T9		.2362	6.00	6	48	57	95	9549799	69	78	116	9549939
IXC_06100T9		.2402	6.10	8	67	76	114	9549800	99	108	146	9549940
IXC_06200T9		.2441	6.20	8	67	76	114	9549801	99	108	146	9549941
IXC_06300T9		.2480	6.30	8	67	76	114	9549802	99	108	146	9549942
IXC_06350T9	1/4	.2500	6.35	8	66	76	114	9549803	98	108	146	9549943
IXC_06400T9		.2520	6.40	8	66	76	114	9549804	98	108	146	9549944
IXC_06500T9		.2559	6.50	8	66	76	114	9549805	98	108	146	9549945
IXC_06600T9		.2598	6.60	8	66	76	114	9549806	98	108	146	9549946
IXC_06700T9		.2638	6.70	8	66	76	114	9549807	98	108	146	9549947
IXC_06750T9	17/64	.2656	6.75	8	66	76	114	9549808	98	108	146	9549948
IXC_06800T9		.2677	6.80	8	66	76	114	9549809	98	108	146	9549949

*Order Example

IXC_03000T9 > 08xD >>> IXC0803000T9

IXC_03000T9 > 12xD >>> IXC1203000T9

** Diameters (2.0-2.9mm) and other dimensions are available upon request**

CARBIDE DRILLS

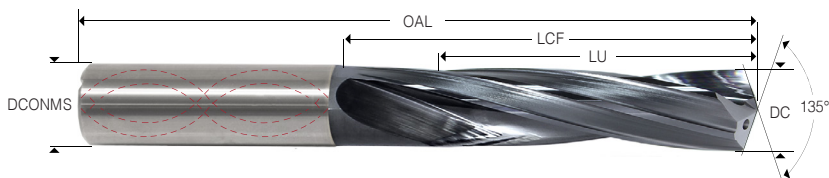

Item Description (Insert 08 or 12 in place of __) *Order Example	**DC Cutting Diameter		DCONMS	8xD Dimensions (mm)				12xD Dimensions (mm)				
	Fraction	Decimal		mm	LU Usable Length	LCF Length Chip Flute	OAL Overall Length	Item Number	LU Usable Length	LCF Length Chip Flute	OAL Overall Length	Item Number
IXC__06900T9		.2717	6.90	8	66	76	114	9549810	98	108	146	9549950
IXC__07000T9		.2756	7.00	8	65	76	114	9549811	98	108	146	9549951
IXC__07100T9		.2795	7.10	8	65	76	114	9549812	97	108	146	9549952
IXC__07140T9	9/32	.2813	7.15	8	65	76	114	9549813	97	108	146	9549953
IXC__07200T9		.2835	7.20	8	65	76	114	9549814	97	108	146	9549954
IXC__07300T9		.2874	7.30	8	65	76	114	9549815	97	108	146	9549956
IXC__07400T9		.2913	7.40	8	65	76	114	9549817	97	108	146	9549957
IXC__07500T9		.2953	7.50	8	65	76	114	9549818	97	108	146	9549958
IXC__07540T9	19/64	.2969	7.54	8	65	76	114	9549819	97	108	146	9549959
IXC__07700T9		.3031	7.70	8	64	76	114	9549820	96	108	146	9549960
IXC__07800T9		.3071	7.80	8	64	76	114	9549821	96	108	146	9549961
IXC__07900T9		.3110	7.90	8	64	76	114	9549822	96	108	146	9549962
IXC__07940T9	5/16	.3125	7.94	8	64	76	114	9549823	96	108	146	9549963
IXC__08000T9		.3150	8.00	8	64	76	114	9549824	96	108	146	9549964
IXC__08100T9		.3189	8.10	10	83	95	142	9549825	108	120	162	9549965
IXC__08200T9		.3228	8.20	10	83	95	142	9549826	108	120	162	9549966
IXC__08300T9		.3268	8.30	10	83	95	142	9549827	108	120	162	9549967
IXC__08330T9	21/64	.3281	8.33	10	82	95	142	9549828	108	120	162	9549968
IXC__08400T9		.3307	8.40	10	82	95	142	9549829	107	120	162	9549969
IXC__08500T9		.3346	8.50	10	82	95	142	9549830	107	120	162	9549970
IXC__08600T9		.3386	8.60	10	82	95	142	9549831	107	120	162	9549971
IXC__08700T9		.3425	8.70	10	82	95	142	9549832	107	120	162	9549972
IXC__08730T9	11/32	.3437	8.73	10	82	95	142	9549833	107	120	162	9549973
IXC__08800T9		.3465	8.80	10	82	95	142	9549834	107	120	162	9549974
IXC__09000T9		.3543	9.00	10	82	95	142	9549835	107	120	162	9549975
IXC__09130T9	23/64	.3594	9.13	10	81	95	142	9549836	106	120	162	9549976
IXC__09200T9		.3622	9.20	10	81	95	142	9549837	106	120	162	9549977
IXC__09300T9		.3661	9.30	10	81	95	142	9549838	106	120	162	9549978
IXC__09500T9		.3740	9.50	10	81	95	142	9549839	106	120	162	9549979
IXC__09520T9	3/8	.3750	9.53	10	81	95	142	9549840	106	120	162	9549980
IXC__09600T9		.3780	9.60	10	81	95	142	9549841	106	120	162	9549981
IXC__09800T9		.3858	9.80	10	80	95	142	9549842	105	120	162	9549982
IXC__09900T9		.3898	9.90	10	80	95	142	9549843	105	120	162	9549983
IXC__09920T9	25/64	.3906	9.92	10	80	95	142	9549844	105	120	162	9549984
IXC__10000T9		.3937	10.00	10	80	95	142	9549845	105	120	162	9549985
IXC__10100T9		.3976	10.10	12	99	114	162	9549846	141	156	204	9549986
IXC__10200T9		.4016	10.20	12	99	114	162	9549847	141	156	204	9549987
IXC__10300T9		.4055	10.30	12	99	114	162	9549848	141	156	204	9549988
IXC__10320T9	13/32	.4063	10.32	12	99	114	162	9549849	141	156	204	9549989
IXC__10400T9		.4094	10.40	12	98	114	162	9549850	140	156	204	9549990
IXC__10500T9		.4134	10.50	12	98	114	162	9549851	140	156	204	9549991
IXC__10720T9	27/64	.4219	10.72	12	98	114	162	9549852	140	156	204	9549992
IXC__10800T9		.4252	10.80	12	98	114	162	9549854	140	156	204	9549993
IXC__11000T9		.4331	11.00	12	98	114	162	9549855	139	156	204	9549994
IXC__11100T9		.4370	11.10	12	97	114	162	9549856	139	156	204	9549995
IXC__11113T9	7/16	.4375	11.11	12	97	114	162	9549857	139	156	204	9549996
IXC__11200T9		.4409	11.20	12	97	114	162	9549858	139	156	204	9549997
IXC__11500T9		.4528	11.50	12	97	114	162	9549859	139	156	204	9549998
IXC__11510T9	29/64	.4531	11.51	12	97	114	162	9549860	139	156	204	9549999
IXC__11700T9		.4606	11.70	12	96	114	162	9549861	138	156	204	9550000
IXC__11800T9		.4646	11.80	12	96	114	162	9549862	138	156	204	9550001
IXC__11910T9	15/32	.4687	11.90	12	96	114	162	9549863	138	156	204	9550002

*Order Example

IXC__06900T9 > 08xD >>> IXC0806900T9

IXC__06900T9 > 12xD >>> IXC1206900T9

** Diameters (2.0-2.9mm) and other dimensions are available upon request**

CARBIDE DRILLS

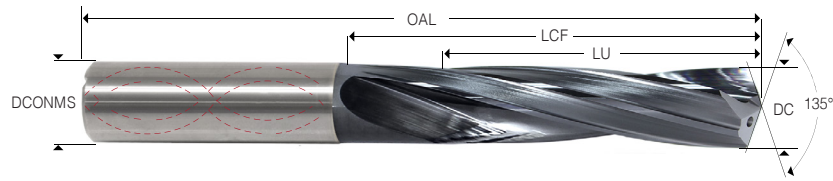

Item Description (Insert 08 or 12 in place of _)	**DC Cutting Diameter			DCONMS	8xD Dimensions (mm)				12xD Dimensions (mm)			
	Fraction	Decimal	mm		LU Usable Length	LCF Length Chip Flute	OAL Overall Length	Item Number	LU Usable Length	LCF Length Chip Flute	OAL Overall Length	Item Number
IXC_12000T9		.4724	12.00	12	96	114	162	9549864	138	156	204	9550003
IXC_12100T9		.4764	12.10	14	113	131	178	9549865	164	182	230	9550004
IXC_12200T9		.4803	12.20	14	113	131	178	9549866	164	182	230	9550005
IXC_12300T9		.4843	12.30	14	113	131	178	9549867	164	182	230	9550006
IXC_12303T9	31/64	.4844	12.30	14	113	131	178	9549868	164	182	230	9550007
IXC_12500T9		.4921	12.50	14	112	131	178	9549869	163	182	230	9550008
IXC_12600T9		.4961	12.60	14	112	131	178	9549870	163	182	230	9550009
IXC_12700T9	1/2	.5000	12.70	14	112	131	178	9549871	163	182	230	9550010
IXC_13000T9		.5118	13.00	14	112	131	178	9549872	163	182	230	9550011
IXC_13300T9		.5236	13.30	14	111	131	178	9549873	162	182	230	9550012
IXC_13490T9	17/32	.5313	13.50	14	111	131	178	9549874	162	182	230	9550013
IXC_13500T9		.5315	13.50	14	111	131	178	9549875	162	182	230	9550014
IXC_14000T9		.5512	14.00	14	110	131	178	9549876	161	182	230	9550015
IXC_14290T9	9/16	.5625	14.29	16	131	152	203	9549877	187	208	260	9550016
IXC_14500T9		.5709	14.50	16	130	152	203	9549878	186	208	260	9550017
IXC_15000T9		.5906	15.00	16	129	152	203	9549879	185	208	260	9550018
IXC_15500T9		.6102	15.50	16	129	152	203	9549880	185	208	260	9550019
IXC_15870T9	5/8	.6250	15.88	16	128	152	203	9549881	184	208	260	9550020
IXC_16000T9		.6299	16.00	16	128	152	203	9549882	184	208	260	9550021
IXC_16500T9		.6496	16.50	18	146	171	222	9549883	209	234	285	9550022
IXC_17000T9		.6693	17.00	18	146	171	222	9549884	209	234	285	9550023
IXC_17500T9		.6890	17.50	18	145	171	222	9549886	208	234	285	9550024
IXC_18000T9		.7087	18.00	18	144	171	222	9549887	207	234	285	9550025
IXC_18500T9		.7283	18.50	20	162	190	243	9549888	230	258	310	9550026
IXC_19050T9	3/4	.7500	19.05	20	161	190	243	9549890	229	258	310	9550027
IXC_19500T9		.7677	19.50	20	161	190	243	9549891	229	258	310	9550028
IXC_20000T9		.7874	20.00	20	160	190	243	9549892	228	258	310	9550029

***Order Example**

IXC_06900T9 > 08xD >>> IXC0806900T9
 IXC_06900T9 > 12xD >>> IXC1206900T9

** Diameters (2.0-2.9mm) and other dimensions are available upon request**

CARBIDE DRILLS



SCAN FOR SPEEDS & FEEDS



Design – Long spiral-fluted, 45° corner chamfer, triple-margin, right-hand cut and internal coolant.

Ideal for – Gray cast iron and ductile iron

K Refer to page 4

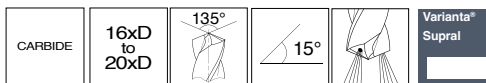

Varianta® Supral Provides a low coefficient of friction, reducing tool wear and resulting in a longer tool life.



Item Description (Insert 16 or 20 in place of _) * Order Example	**DC Cutting Diameter			DCONMS	16xD Dimensions (mm)				20xD Dimensions (mm)			
	Fraction	Decimal	mm		LU Usable Length	LCF Length Chip Flute	OAL Overall Length	Item Number	LU Usable Length	LCF Length Chip Flute	OAL Overall Length	Item Number
IXC_ _03000T9		.1181	3.00	6	56	60	100	9550033	76	80	120	9550112
IXC_ _03175T9	1/8	.1250	3.18	6	55	60	100	9550034	75	80	120	9550113
IXC_ _03200T9		.1260	3.20	6	55	60	100	9550035	75	80	120	9550114
IXC_ _03300T9		.1299	3.30	6	55	60	100	9550036	75	80	120	9550115
IXC_ _03500T9		.1378	3.50	6	55	60	100	9550037	75	80	120	9550116
IXC_ _03572T9	9/64	.1406	3.57	6	70	75	115	9550038	85	90	130	9550117
IXC_ _03800T9		.1496	3.80	6	69	75	115	9550039	84	90	130	9550118
IXC_ _03970T9	5/32	.1563	3.97	6	69	75	115	9550040	84	90	130	9550119
IXC_ _04000T9		.1575	4.00	6	69	75	115	9550041	84	90	130	9550120
IXC_ _04200T9		.1654	4.20	6	69	75	115	9550042	104	110	160	9550121
IXC_ _04370T9	11/64	.1719	4.37	6	83	90	130	9550043	103	110	160	9550122
IXC_ _04500T9		.1772	4.50	6	83	90	130	9550044	103	110	160	9550123
IXC_ _00130T9	#13	.1850	4.70	6	83	90	130	9550032	113	120	160	9550111
IXC_ _04760T9	3/16	.1875	4.76	6	83	90	130	9550045	113	120	160	9550124
IXC_ _00120T9	#12	.1890	4.80	6	83	90	130	9550031	113	120	160	9550110
IXC_ _05000T9		.1969	5.00	6	82	90	130	9550046	112	120	160	9550125
IXC_ _05160T9	13/64	.2031	5.16	6	100	108	150	9550047	132	140	185	9550126
IXC_ _00060T9	#6	.2040	5.18	6	100	108	150	9584738	132	140	185	9584740
IXC_ _05500T9		.2165	5.50	6	100	108	150	9550048	132	140	185	9550127
IXC_ _05560T9	7/32	.2187	5.55	6	100	108	150	9550049	132	140	185	9550128
IXC_ _05800T9		.2283	5.80	6	99	108	150	9550050	131	140	185	9550129
IXC_ _05950T9	15/64	.2344	5.95	6	99	108	150	9550051	131	140	185	9550130
IXC_ _06000T9		.2362	6.00	6	99	108	150	9550052	131	140	185	9550131
IXC_ _06350T9	1/4	.2500	6.35	8	115	125	165	9550053	150	160	210	9550132
IXC_ _06500T9	6.5	.2559	6.50	8	115	125	165	9550054	150	160	210	9550133
IXC_ _06750T9	17/64	.2656	6.75	8	115	125	165	9550055	150	160	210	9550134
IXC_ _06800T9		.2677	6.80	8	115	125	165	9550056	150	160	210	9550135
IXC_ _07000T9		.2756	7.00	8	115	125	165	9550057	149	160	210	9550136
IXC_ _07140T9	9/32	.2813	7.15	8	129	140	180	9550058	169	180	230	9550137
IXC_ _07500T9		.2953	7.50	8	129	140	180	9550059	169	180	230	9550138
IXC_ _07540T9	19/64	.2969	7.54	8	129	140	180	9550060	169	180	230	9550139
IXC_ _07800T9		.3071	7.80	8	128	140	180	9550061	168	180	230	9550140
IXC_ _07940T9	5/16	.3125	7.94	8	128	140	180	9550062	168	180	230	9550141
IXC_ _08000T9		.3150	8.00	8	128	140	180	9550063	168	180	230	9550142
IXC_ _08330T9	21/64	.3281	8.33	10	148	160	205	9550064	183	195	260	9550143
IXC_ _08500T9		.3346	8.50	10	147	160	205	9550065	182	195	260	9550144
IXC_ _08730T9	11/32	.3437	8.73	10	147	160	205	9550066	217	230	290	9550145
IXC_ _08800T9		.3465	8.80	10	147	160	205	9550067	217	230	290	9550146
IXC_ _09000T9		.3543	9.00	10	147	160	205	9550068	217	230	290	9550148
IXC_ _09130T9	23/64	.3594	9.13	10	166	180	225	9550069	216	230	290	9550149

***Order Example**

IXC_ _03000T9 > 16xD >>> IXC1603000T9

IXC_ _03000T9 > 20xD >>> IXC2003000T9

** Diameters (2.0-2.9mm) and other dimensions are available upon request**

CARBIDE DRILLS

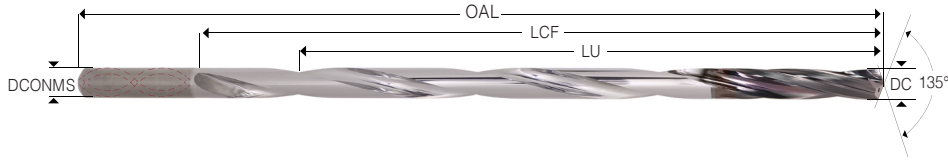

Item Description (Insert 16 or 20 in place of _)	**DC Cutting Diameter			DCONMS	16xD Dimensions (mm)				20xD Dimensions (mm)			
	Fraction	Decimal	mm		LU Usable Length	LCF Length Chip Flute	OAL Overall Length	Item Number	LU Usable Length	LCF Length Chip Flute	OAL Overall Length	Item Number
IXC_09520T9	3/8	.3750	9.53	10	166	180	225	9550072	216	230	290	9550150
IXC_09800T9	9.8	.3858	9.80	10	165	180	225	9550073	215	230	290	9550151
IXC_09920T9	25/64	.3906	9.92	10	165	180	225	9550074	215	230	290	9550152
IXC_10000T9		.3937	10.00	10	165	180	225	9550075	215	230	290	9550153
IXC_10200T9		.4016	10.20	12	175	190	240	9550076	253	268	315	9550154
IXC_10320T9	13/32	.4063	10.32	12	175	190	240	9550077	253	268	315	9550155
IXC_10720T9	27/64	.4219	10.72	12	174	190	240	9550079	252	268	315	9550156
IXC_10800T9		.4252	10.80	12	174	190	240	9550080	252	268	315	9550157
IXC_11000T9		.4331	11.00	12	173	190	240	9584739	252	268	315	9550158
IXC_11113T9	7/16	.4375	11.11	12	198	215	265	9550081	251	268	315	9550159
IXC_11500T9		.4528	11.50	12	198	215	265	9550083	251	268	315	9550160
IXC_11510T9	29/64	.4531	11.51	12	198	215	265	9550084	251	268	315	9550161
IXC_11910T9	15/32	.4687	11.90	12	197	215	265	9550085	250	268	315	9550162
IXC_12000T9		.4724	12.00	12	197	215	265	9550086	250	268	315	9550163
IXC_12300T9		.4843	12.30	14	212	230	280	9550087	257	275	325	9550164
IXC_12303T9	31/64	.4844	12.30	14	212	230	280	9550088	257	275	325	9550165
IXC_12700T9	1/2	.5000	12.70	14	211	230	280	9550089	256	275	325	9550166
IXC_13000T9		.5118	13.00	14	210	230	280	9550090	256	275	325	9550167
IXC_13300T9		.5236	13.30	14	225	245	295	9550091	285	305	355	9550168
IXC_13490T9	17/32	.5313	13.50	14	225	245	295	9550092	285	305	355	9550169
IXC_13500T9	13.5	.5315	13.50	14	225	245	295	9550093	285	305	355	9550170
IXC_14000T9		.5512	14.00	14	224	245	295	9550094	284	305	355	9550171
IXC_14290T9	9/16	.5625	14.29	16	234	255	305	9550096				
IXC_14500T9		.5709	14.50	16	233	255	305	9550097				
IXC_15000T9		.5906	15.00	16	232	255	305	9550098				
IXC_15500T9		.6102	15.50	16	252	275	325	9550099				
IXC_15870T9	5/8	.6250	15.88	16	251	275	325	9550100				
IXC_16000T9		.6299	16.00	16	251	275	325	9550101				

***Order Example**

IXC_09520T9 > 16xD >>> IXC1609520T9

IXC_09520T9 > 20xD >>> IXC2009520T9

** Diameters (2.0-2.9mm) and other dimensions are available upon request**

CARBIDE DRILLS



SCAN FOR SPEEDS & FEEDS



Design – Long spiral-fluted, 45° corner chamfer, triple-margin, right-hand cut and internal coolant.

Ideal for – Gray cast iron and ductile iron

K Refer to page 4

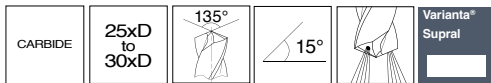

Varianta® Supral Provides a low coefficient of friction, reducing tool wear and resulting in a longer tool life.



Item Description (Insert 25 or 30in place of _)	**DC Cutting Diameter			DCONMS	25xD Dimensions (mm)				30xD Dimensions (mm)			
	*Order Example Fraction	Decimal	mm		LU Usable Length	LCF Length Chip Flute	OAL Overall Length	Item Number	LU Usable Length	LCF Length Chip Flute	OAL Overall Length	Item Number
IXC_ _03000T9		.1181	3.00	6	94	98	135	9550181	101	105	150	9550235
IXC_ _03175T9	1/8	.1250	3.18	6	93	98	135	9550182	100	105	150	9550236
IXC_ _03200T9		.1260	3.20	6	93	98	135	9550183	100	105	150	9550237
IXC_ _03300T9		.1299	3.30	6	93	98	135	9550184	130	135	185	9550238
IXC_ _03500T9		.1378	3.50	6	93	98	135	9550185	130	135	185	9550239
IXC_ _03572T9	9/64	.1406	3.57	6	115	120	160	9550186	130	135	185	9550240
IXC_ _03800T9		.1496	3.80	6	114	120	160	9550187	129	135	185	9550241
IXC_ _03970T9	5/32	.1563	3.97	6	114	120	160	9550188	129	135	185	9550242
IXC_ _04000T9		.1575	4.00	6	114	120	160	9550189	129	135	185	9550243
IXC_ _04200T9		.1654	4.20	6	114	120	160	9550190	129	135	185	9550244
IXC_ _04370T9	11/64	.1719	4.37	6	128	135	180	9550191	158	165	215	9550245
IXC_ _04500T9		.1772	4.50	6	128	135	180	9550192	158	165	215	9550246
IXC_ _00130T9	#13	.1850	4.70	6	128	135	180	9550180	158	165	215	9550234
IXC_ _04760T9	3/16	.1875	4.76	6	128	135	180	9550193	158	165	215	9550247
IXC_ _00120T9	#12	.1890	4.80	6	128	135	180	9550179	158	165	215	9550233
IXC_ _05000T9		.1969	5.00	6	128	135	180	9550194	158	165	215	9550248
IXC_ _05160T9	13/64	.2031	5.16	6	160	168	205	9550195	172	180	230	9550249
IXC_ _00060T9	#6	.2040	5.18	6	160	168	205	9550178	172	180	230	9550232
IXC_ _05500T9		.2165	5.50	6	160	168	205	9550196	172	180	230	9550250
IXC_ _05560T9	7/32	.2187	5.55	6	160	168	205	9550197	172	180	230	9550251
IXC_ _05800T9		.2283	5.80	6	159	168	205	9550198	171	180	230	9550252
IXC_ _05950T9	15/64	.2344	5.95	6	159	168	205	9550199	171	180	230	9550253
IXC_ _06000T9		.2362	6.00	6	159	168	205	9550200	171	180	230	9550254
IXC_ _06350T9	1/4	.2500	6.35	8	190	200	240	9550201	205	215	280	9550255
IXC_ _06500T9		.2559	6.50	8	190	200	240	9550202	205	215	280	9550256
IXC_ _06750T9	17/64	.2656	6.75	8	190	200	240	9550203	220	230	280	9550257
IXC_ _06800T9		.2677	6.80	8	190	200	240	9550204	220	230	280	9550258
IXC_ _07000T9		.2756	7.00	8	189	200	240	9550205	219	230	280	9550259
IXC_ _07140T9	9/32	.2813	7.15	8	209	220	260	9550206	219	230	280	9550260
IXC_ _07500T9		.2953	7.50	8	209	220	260	9550207	219	230	280	9550261
IXC_ _07540T9	19/64	.2969	7.54	8	209	220	260	9550208	254	265	315	9550262
IXC_ _07800T9		.3071	7.80	8	208	220	260	9550209	253	265	315	9550263
IXC_ _07940T9	5/16	.3125	7.94	8	208	220	260	9550210	253	265	315	9550264
IXC_ _08000T9		.3150	8.00	8	208	220	260	9550211	253	265	315	9550265
IXC_ _08330T9	21/64	.3281	8.33	10	228	240	285	9550212	283	295	350	9550266
IXC_ _08500T9		.3346	8.50	10	227	240	285	9550213	282	295	350	9550267
IXC_ _08730T9	11/32	.3437	8.73	10	255	268	310	9550214	317	330	380	9550268
IXC_ _08800T9		.3465	8.80	10	255	268	310	9550215	317	330	380	9550269
IXC_ _09000T9		.3543	9.00	10	255	268	310	9550216	317	330	380	9550270
IXC_ _09130T9	23/64	.3594	9.13	10	254	268	310	9550217	316	330	380	9550271

***Order Example**

IXC_ _03000T9 > 25xD >>> IXC2503000T9

IXC_ _03000T9 > 30xD >>> IXC3003000T9

** Diameters (2.0-2.9mm) and other dimensions are available upon request**

CARBIDE DRILLS

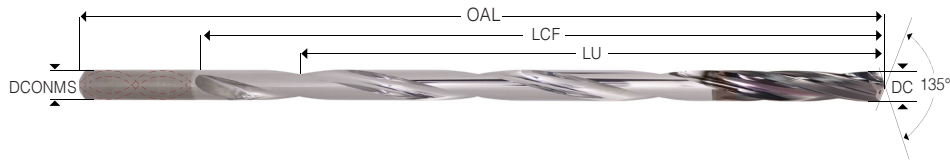

Item Description (Insert 25 or 30 in place of _)	**DC Cutting Diameter			DCONMS	25xD Dimensions (mm)				30xD Dimensions (mm)			
	Fraction	Decimal	mm		LU Usable Length	LCF Length Chip Flute	OAL Overall Length	Item Number	LU Usable Length	LCF Length Chip Flute	OAL Overall Length	Item Number
IXC_09520T9	3/8	.3750	9.53	10	254	268	310	9550218	316	330	380	9550272
IXC_09800T9		.3858	9.80	10	253	268	310	9550219	315	330	380	9550273
IXC_09920T9	25/64	.3906	9.92	10	253	268	310	9550220	315	330	380	9550274
IXC_10000T9		.3937	10.00	10	253	268	310	9550221	315	330	380	9550275
IXC_10200T9		.4016	10.20	12	285	300	350	9584741				
IXC_10320T9	13/32	.4063	10.32	12	285	300	350	9550222				
IXC_10720T9	27/64	.4219	10.72	12	284	300	350	9550223				
IXC_10800T9		.4252	10.80	12	284	300	350	9584742				
IXC_11000T9		.4331	11.00	12	283	300	350	9550224				
IXC_11113T9	7/16	.4375	11.11	12	313	330	380	9550225				
IXC_11500T9		.4528	11.50	12	313	330	380	9550226				
IXC_11510T9	29/64	.4531	11.51	12	313	330	380	9550227				
IXC_11910T9	15/32	.4687	11.90	12	312	330	380	9550228				
IXC_12000T9		.4724	12.00	12	312	330	380	9550229				

***Order Example**

IXC_09520T9 > 25xD >>> IXC2509520T9

IXC_09520T9 > 30xD >>> IXC3009520T9

** Diameters (2.0-2.9mm) and other dimensions are available upon request**

CARRIBIDE DRILLS



SCAN FOR SPEEDS & FEEDS



**Single Margin Drill
Non Coolant Thru
Ideal for General
Purpose Drilling
3xD-5xD**

P M S Refer to page 4



SCAN FOR SPEEDS & FEEDS

CARBIDE	3xD to 5xD	135°	30°
---------	------------------	------	-----

Varianta® Supral Provides a low coefficient of friction, reducing tool wear and resulting in a longer tool life.

Varianta® Supraal

135° Point Geometry - Split-point geometry for superior drill penetration and accuracy.

Single-Margin Design - For drilling accuracy.

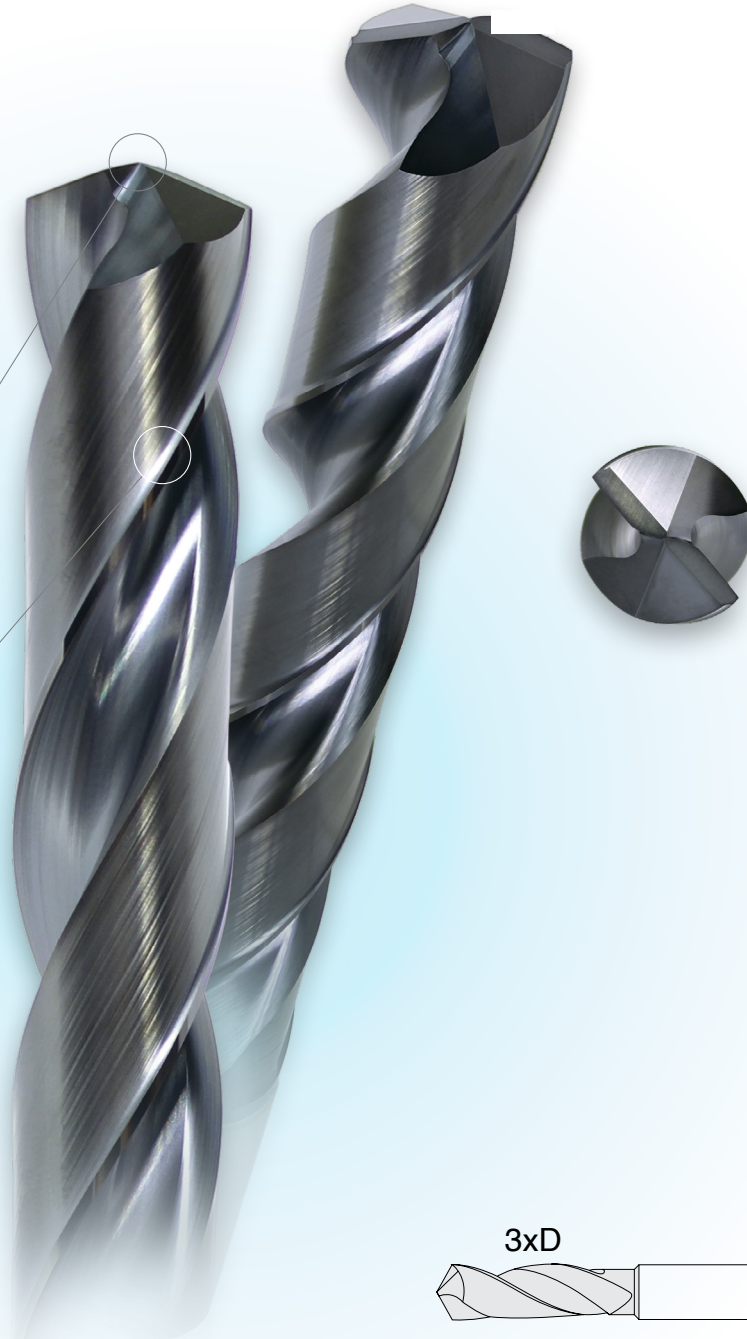

No Pecking Required

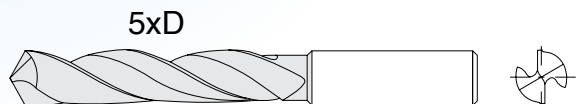
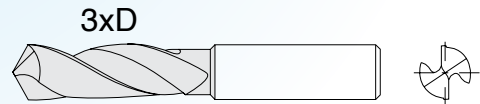
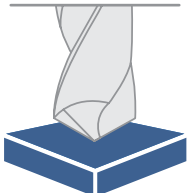



Design – Spiral-fluted, right-hand cut, with external coolant.

Ideal for – General Purpose Drilling

P M K S Refer to page 4

CARBIDE	3xD to 5xD	135°	30°	Varianta® Supral	Varianta® Supral Provides a low coefficient of friction, reducing tool wear and resulting in a longer tool life.
---------	------------	------	-----	------------------	--

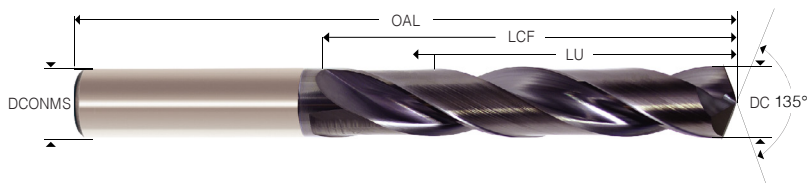

Item Description (Insert 03 or 05 in place of __) *Order Example	**DC Cutting Diameter			DCONMS	3xD Dimensions (mm)				5xD Dimensions (mm)			
	Fraction	Decimal	mm		LU Usable Length	LCF Length chip flute	OAL Overall Length	Item Number	LU Usable Length	LCF Length chip flute	OAL Overall Length	Item Number
SX0_06250T9	1/16	.0625	1.59	1/8	0.53	5/8	2	9571766	0.66	3/4	2-1/2	9572012
SX0_00520T9	#52	.0635	1.61	1/8	0.59	11/16	2	9571675	0.65	3/4	2-1/2	9571963
SX0_00510T9	#51	.0670	1.70	1/8	0.59	11/16	2	9571674	0.65	3/4	2-1/2	9571961
SX0_00500T9	#50	.0700	1.78	1/8	0.58	11/16	2	9571673	0.77	7/8	2-1/2	9571960
SX0_00490T9	#49	.0730	1.85	1/8	0.58	11/16	2	9571672	0.77	7/8	2-1/2	9571959
SX0_00480T9	#48	.0760	1.93	1/8	0.57	11/16	2	9571671	0.76	7/8	2-1/2	9571958
SX0_07810T9	5/64	.0781	1.98	1/8	0.57	11/16	2	9571789	0.76	7/8	2-1/2	9572026
SX0_00470T9	#47	.0785	1.99	1/8	0.63	3/4	2	9571670	0.76	7/8	2-1/2	9571957
SX0_07870T9		.0787	2.00	1/8	0.63	3/4	2-1/2	9571790	0.76	7/8	2-1/2	9572027
SX0_00460T9	#46	.0810	2.06	1/8	0.63	3/4	2-1/2	9571669	0.75	7/8	2-1/2	9571956
SX0_00450T9	#45	.0820	2.08	1/8	0.63	3/4	2-1/2	9571668	0.75	7/8	2-1/2	9571955
SX0_00440T9	#44	.0860	2.18	1/8	0.62	3/4	2-1/2	9571666	0.87	1	2-1/2	9571954
SX0_00430T9	#43	.0890	2.26	1/8	0.62	3/4	2-1/2	9571664	0.87	1	2-1/2	9571953
SX0_00420T9	#42	.0935	2.37	1/8	0.61	3/4	2-1/2	9571663	0.86	1	2-1/2	9571952
SX0_09380T9	3/32	.0938	2.38	1/8	0.61	3/4	2-1/2	9571810	0.86	1	2-1/2	9572046
SX0_00410T9	#41	.0960	2.44	1/8	0.67	13/16	2-1/2	9571661	0.86	1	2-1/2	9571951
SX0_00400T9	#40	.0980	2.49	1/8	0.67	13/16	2-1/2	9571658	0.85	1	2-1/2	9571949
SX0_09840T9		.0984	2.50	1/8	0.66	13/16	2-1/2	9571817	1.10	1-1/4	3	9572050
SX0_00390T9	#39	.0995	2.53	1/8	0.66	13/16	2-1/2	9571656	1.10	1-1/4	3	9571948
SX0_00380T9	#38	.1015	2.58	1/8	0.66	13/16	2-1/2	9571654	1.10	1-1/4	3	9571947
SX0_00370T9	#37	.1040	2.64	1/8	0.66	13/16	2-1/2	9571653	1.09	1-1/4	3	9571946
SX0_00360T9	#36	.1065	2.71	1/8	0.65	13/16	2-1/2	9571651	1.09	1-1/4	3	9571945
SX0_01094T9	7/64	.1094	2.78	1/8	0.65	13/16	2-1/2	9571683	1.09	1-1/4	3	9571968
SX0_00350T9	#35	.1100	2.79	1/8	0.71	7/8	2-1/2	9571650	1.09	1-1/4	3	9571944
SX0_00340T9	#34	.1110	2.82	1/8	0.71	7/8	2-1/2	9571648	1.08	1-1/4	3	9571943
SX0_00330T9	#33	.1130	2.87	1/8	0.71	7/8	2-1/2	9571646	1.08	1-1/4	3	9571942
SX0_00320T9	#32	.1160	2.95	1/8	0.70	7/8	2-1/2	9571644	1.08	1-1/4	3	9571941
SX0_03000T9		.1181	3.00	1/8	0.70	7/8	2-1/2	9571712	1.07	1-1/4	3	9571978
SX0_00310T9	#31	.1200	3.05	1/8	0.70	7/8	2-1/2	9571641	1.07	1-1/4	3	9571940
SX0_03175T9	1/8	.1250	3.18	1/8	0.69	7/8	2-1/2	9571716	1.06	1-1/4	3	9571980
SX0_00300T9	#30	.1285	3.26	3/16	0.74	15/16	2-1/2	9571638	1.06	1-1/4	3	9571937
SX0_00290T9	#29	.1360	3.45	3/16	0.73	15/16	2-1/2	9571637	1.17	1-3/8	3	9571936
SX0_03500T9		.1378	3.50	3/16	0.73	15/16	2-1/2	9571723	1.17	1-3/8	3	9571987
SX0_00280T9	#28	.1405	3.57	3/16	0.73	15/16	2-1/2	9571636	1.16	1-3/8	3	9571935
SX0_03570T9	9/64	.1406	3.57	3/16	0.79	1	2-1/2	9571725	1.16	1-3/8	3	9571988
SX0_00270T9	#27	.1440	3.66	3/16	0.78	1	2-1/2	9571635	1.16	1-3/8	3	9571934
SX0_00260T9	#26	.1470	3.73	3/16	0.78	1	2-1/2	9571634	1.15	1-3/8	3	9571933
SX0_00250T9	#25	.1495	3.80	3/16	0.78	1	2-1/2	9571631	1.15	1-3/8	3	9571932
SX0_00240T9	#24	.1520	3.86	3/16	0.77	1	2-1/2	9571630	1.15	1-3/8	3	9571931
SX0_00230T9	#23	.1540	3.91	3/16	0.77	1	2-1/2	9571629	1.14	1-3/8	3	9571930
SX0_03970T9	5/32	.1562	3.97	3/16	0.77	1	2-1/2	9571730	1.14	1-3/8	3	9571992
SX0_00220T9	#22	.1570	3.99	3/16	0.83	1-1/16	2-1/2	9571628	1.14	1-3/8	3	9571929
SX0_04000T9		.1575	4.00	3/16	0.83	1-1/16	2-1/2	9571732	1.14	1-3/8	3	9571993
SX0_00210T9	#21	.1590	4.04	3/16	0.82	1-1/16	2-1/2	9571626	1.14	1-3/8	3	9571928
SX0_00200T9	#20	.1610	4.09	3/16	0.82	1-1/16	2-1/2	9571625	1.13	1-3/8	3	9571926
SX0_04200T9		.1654	4.20	3/16	0.81	1-1/16	2-1/2	9571736	1.38	1-5/8	4	9584749

***Order Example**

SX0_06250T9 > 03xD >>> SX00306250T9

SX0_06250T9 > 05xD >>> SX00506250T9

** Diameters (2.0-2.9mm) and other dimensions are available upon request**

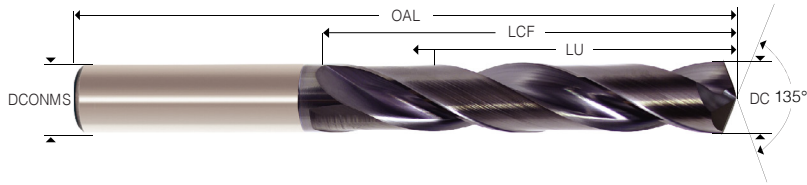

Item Description (Insert 03 or 05 in place of _ _) *Order Example	**DC Cutting Diameter			DCONMS	3xD Dimensions (mm)				5xD Dimensions (mm)			
	Fraction	Decimal	mm		LU Usable Length	LCF Length Chip Flute	OAL Overall Length	Item Number	LU Usable Length	LCF Length Chip Flute	OAL Overall Length	Item Number
SX0__00190T9	#19	.1660	4.22	3/16	0.81	1-1/16	2-1/2	9571623	1.38	1-5/8	4	9571925
SX0__00180T9	#18	.1695	4.31	3/16	0.81	1-1/16	2-1/2	9571622	1.37	1-5/8	4	9571924
SX0__04370T9	11/64	.1719	4.37	3/16	0.80	1-1/16	2-1/2	9571738	1.37	1-5/8	4	9571996
SX0__00170T9	#17	.1730	4.39	3/16	0.87	1-1/8	3	9571621	1.37	1-5/8	4	9571923
SX0__00160T9	#16	.1770	4.50	3/16	0.86	1-1/8	3	9571620	1.36	1-5/8	4	9571922
SX0__04500T9		.1772	4.50	3/16	0.86	1-1/8	3	9571742	1.36	1-5/8	4	9571999
SX0__00150T9	#15	.1800	4.57	3/16	0.86	1-1/8	3	9571617	1.36	1-5/8	4	9571921
SX0__00140T9	#14	.1820	4.62	3/16	0.85	1-1/8	3	9571616	1.35	1-5/8	4	9571920
SX0__00130T9	#13	.1850	4.70	3/16	0.85	1-1/8	3	9571615	1.35	1-5/8	4	9571919
SX0__04760T9	3/16	.1875	4.76	3/16	0.84	1-1/8	3	9571745	1.34	1-5/8	4	9572000
SX0__00120T9	#12	.1890	4.80	1/4	0.90	1-3/16	3	9571613	1.34	1-5/8	4	9571918
SX0__00110T9	#11	.1910	4.85	1/4	0.90	1-3/16	3	9571612	1.34	1-5/8	4	9571917
SX0__00100T9	#10	.1935	4.91	1/4	0.90	1-3/16	3	9571611	1.33	1-5/8	4	9571916
SX0__00090T9	#9	.1960	4.98	1/4	0.89	1-3/16	3	9571582	1.46	1-3/4	4	9571888
SX0__05000T9		.1969	5.00	1/4	0.89	1-3/16	3	9571750	1.20	1-1/2	4	9572002
SX0__00080T9	#8	.1990	5.05	1/4	0.89	1-3/16	3	9571581	1.20	1-1/2	4	9571887
SX0__05100T9		.2008	5.10	1/4	0.89	1-3/16	3	9571752	1.45	1-3/4	4	9572005
SX0__00070T9	#7	.2010	5.11	1/4	0.89	1-3/16	3	9571580	1.45	1-3/4	4	9571885
SX0__05160T9	13/64	.2031	5.16	1/4	0.88	1-3/16	3	9571755	1.45	1-3/4	4	9572006
SX0__00060T9	#6	.2040	5.18	1/4	0.94	1-1/4	3	9571579	1.44	1-3/4	4	9571883
SX0__00050T9	#5	.2055	5.22	1/4	0.94	1-1/4	3	9571578	1.44	1-3/4	4	9571882
SX0__00040T9	#4	.2090	5.31	1/4	0.94	1-1/4	3	9571577	1.44	1-3/4	4	9571881
SX0__00030T9	#3	.2130	5.41	1/4	0.93	1-1/4	3	9571576	1.43	1-3/4	4	9571879
SX0__02165T9		.2165	5.50	1/4	0.93	1-1/4	3	9571691	1.43	1-3/4	4	9571972
SX0__05560T9	7/32	.2188	5.56	1/4	0.92	1-1/4	3	9571758	1.42	1-3/4	4	9572008
SX0__00020T9	#2	.2210	5.61	1/4	0.98	1-5/16	3	9571575	1.42	1-3/4	4	9571878
SX0__00010T9	#1	.2280	5.79	1/4	0.97	1-5/16	3	9571573	1.41	1-3/4	4	9571877
SX0__000A0T9	A	.2340	5.94	1/4	0.96	1-5/16	3	9571584	1.65	2	4	9571889
SX0__05950T9	15/64	.2344	5.95	1/4	0.96	1-5/16	3	9571760	1.65	2	4	9572009
SX0__06000T9		.2362	6.00	1/4	1.02	1-3/8	3	9571761	1.65	2	4	9572010
SX0__000B0T9	B	.2380	6.05	1/4	1.02	1-3/8	3	9571585	1.64	2	4	9571890
SX0__000C0T9	C	.2420	6.15	1/4	1.01	1-3/8	3	9571586	1.64	2	4	9571891
SX0__000D0T9	D	.2460	6.25	1/4	1.01	1-3/8	3	9571587	1.63	2	4	9571892
SX0__06350T9	1/4/E	.2500	6.35	1/4	1.00	1-3/8	3	9571768	1.63	2	4	9572013
SX0__06500T9		.2559	6.50	5/16	1.05	1-7/16	3	9571772	1.62	2	4	9572015
SX0__000F0T9	F	.2570	6.53	5/16	1.05	1-7/16	3	9571588	1.61	2	4	9571893
SX0__000G0T9	G	.2610	6.63	5/16	1.05	1-7/16	3	9571589	1.73	2-1/8	4	9571895
SX0__06750T9	17/64	.2656	6.75	5/16	1.04	1-7/16	3	9571776	1.73	2-1/8	4	9572019
SX0__000H0T9	H	.2660	6.76	5/16	1.10	1-1/2	3	9571590	1.73	2-1/8	4	9571896
SX0__000I0T9	I	.2720	6.91	5/16	1.09	1-1/2	3	9571591	1.72	2-1/8	4	9571897
SX0__07000T9	7	.2756	7.00	5/16	1.09	1-1/2	3	9571781	1.71	2-1/8	4	9572020
SX0__000J0T9	J	.2770	7.04	5/16	1.08	1-1/2	3	9571592	1.71	2-1/8	4	9571899
SX0__000K0T9	K	.2810	7.14	5/16	1.08	1-1/2	3	9571593	1.70	2-1/8	4	9571900
SX0__07140T9	9/32	.2812	7.14	5/16	1.08	1-1/2	3	9571782	1.70	2-1/8	4	9572022
SX0__000L0T9	L	.2900	7.37	5/16	1.13	1-9/16	4	9571594	1.69	2-1/8	4	9571901
SX0__000M0T9	M	.2950	7.49	5/16	1.12	1-9/16	4	9571595	1.93	2-3/8	4	9571902
SX0__07500T9		.2953	7.50	5/16	1.12	1-9/16	4	9571783	1.93	2-3/8	4	9572024
SX0__07540T9	19/64	.2969	7.54	5/16	1.12	1-9/16	4	9571784	1.93	2-3/8	4	9572025
SX0__000N0T9	N	.3020	7.67	5/16	1.17	1-5/8	4	9571596	1.92	2-3/8	4	9571903
SX0__07940T9	5/16	.3125	7.94	5/16	1.16	1-5/8	4	9571791	1.91	2-3/8	4	9572031
SX0__08000T9		.3150	8.00	3/8	1.22	1-11/16	4	9571797	1.90	2-3/8	4	9572033
SX0__000O0T9	O	.3160	8.03	3/8	1.21	1-11/16	4	9571597	1.90	2-3/8	4	9571904
SX0__000P0T9	P	.3230	8.20	3/8	1.20	1-11/16	4	9571598	1.89	2-3/8	4	9571905

*Order Example

SX0__00200T9 > 03xD >>> SX00300200T9

SX0__00200T9 > 05xD >>> SX00500200T9

** Diameters (2.0-2.9mm) and other dimensions are available upon request**

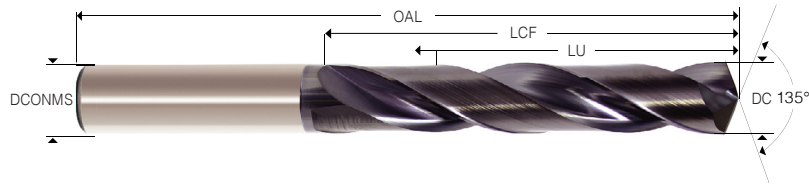

Item Description (Insert 03 or 05 in place of _ _) * Order Example	**DC Cutting Diameter			DCONMS	3xD Dimensions (mm)				5xD Dimensions (mm)			
	Fraction	Decimal	mm		LU Usable Length	LCF Length Chip Flute	OAL Overall Length	Item Number	LU Usable Length	LCF Length Chip Flute	OAL Overall Length	Item Number
SX0_08330T9	21/64	.3281	8.33	3/8	1.20	1-11/16	4	9571801	2.01	2-1/2	5	9572035
SX0_000Q0T9	Q	.3320	8.43	3/8	1.19	1-11/16	4	9571599	2.00	2-1/2	5	9571906
SX0_08500T9	8.5	.3346	8.50	3/8	1.19	1-11/16	4	9571802	2.00	2-1/2	5	9572037
SX0_000R0T9	R	.3390	8.61	3/8	1.18	1-11/16	4	9571600	1.99	2-1/2	5	9571907
SX0_08730T9	11/32	.3438	8.73	3/8	1.17	1-11/16	4	9571804	1.98	2-1/2	5	9572042
SX0_000S0T9	S	.3480	8.84	3/8	1.23	1-3/4	4	9571601	1.98	2-1/2	5	9571908
SX0_09000T9	9	.3543	9.00	3/8	1.22	1-3/4	4	9571806	1.97	2-1/2	5	9572044
SX0_000T0T9	T	.3580	9.09	3/8	1.21	1-3/4	4	9571602	2.21	2-3/4	5	9571909
SX0_09130T9	23/64	.3594	9.13	3/8	1.21	1-3/4	4	9571809	2.21	2-3/4	5	9572045
SX0_000U0T9	U	.3680	9.35	3/8	1.26	1-13/16	4	9571603	2.20	2-3/4	5	9571910
SX0_09500T9		.3740	9.50	3/8	1.25	1-13/16	4	9571812	2.19	2-3/4	5	9572047
SX0_09520T9	3/8	.3750	9.53	3/8	1.25	1-13/16	4	9571813	2.19	2-3/4	5	9572048
SX0_000V0T9	V	.3770	9.58	7/16	1.31	1-7/8	4	9571605	2.31	2-7/8	5	9571911
SX0_000W0T9	W	.3860	9.80	7/16	1.30	1-7/8	4	9571607	2.30	2-7/8	5	9571912
SX0_09920T9	25/64	.3906	9.92	7/16	1.29	1-7/8	4	9571818	2.29	2-7/8	5	9572051
SX0_10000T9		.3937	10.00	7/16	1.35	1-15/16	4	9571821	2.28	2-7/8	5	9572052
SX0_000X0T9	X	.3970	10.08	7/16	1.34	1-15/16	4	9571608	2.28	2-7/8	5	9571913
SX0_000Y0T9	Y	.4040	10.26	7/16	1.33	1-15/16	4	9571609	2.27	2-7/8	5	9571914
SX0_10320T9	13/32	.4062	10.32	7/16	1.33	1-15/16	4	9571825	2.27	2-7/8	5	9572054
SX0_000Z0T9	Z	.4130	10.49	7/16	1.38	2	4	9571610	2.26	2-7/8	5	9571915
SX0_10500T9		.4134	10.50	7/16	1.38	2	4	9571827	2.25	2-7/8	5	9572055
SX0_10720T9	27/64	.4219	10.72	7/16	1.37	2	4	9571830	2.24	2-7/8	5	9572056
SX0_10800T9		.4252	10.80	7/16	1.36	2	4	9571831	2.24	2-7/8	5	9572057
SX0_11000T9		.4331	11.00	7/16	1.41	2-1/16	4	9571832	2.23	2-7/8	5	9572058
SX0_11110T9	7/16	.4375	11.11	7/16	1.41	2-1/16	4	9571833	2.22	2-7/8	5	9572059
SX0_11500T9		.4528	11.50	1/2	1.45	2-1/8	4	9571835	2.32	3	5	9572060
SX0_11510T9	29/64	.4531	11.51	1/2	1.45	2-1/8	4	9571836	2.32	3	5	9572061
SX0_11910T9	15/32	.4688	11.91	1/2	1.42	2-1/8	4	9571837	2.30	3	5	9572063
SX0_12000T9		.4724	12.00	1/2	1.48	2-3/16	4	9571838	2.29	3	5	9572064
SX0_12300T9	31/64	.4844	12.30	1/2	1.46	2-3/16	4	9571842	2.27	3	5	9572065
SX0_12500T9		.4921	12.50	1/2	1.45	2-3/16	4	9571844	2.26	3	5	9572067
SX0_12700T9	1/2	.5000	12.70	1/2	1.50	2-1/4	4	9571846	2.25	3	5	9572068
SX0_13000T9		.5118	13.00	9/16	1.61	2-3/8	5	9571850	2.48	3-1/4	5	9572070
SX0_13100T9	33/64	.5156	13.10	9/16	1.60	2-3/8	5	9571851	2.48	3-1/4	5	9572071
SX0_13490T9	17/32	.5312	13.49	9/16	1.70	2-1/2	5	9571852	2.45	3-1/4	5	9572072
SX0_13500T9		.5315	13.50	9/16	1.70	2-1/2	5	9571854	2.45	3-1/4	5	9572073
SX0_13890T9	35/64	.5469	13.89	9/16	1.68	2-1/2	5	9584745	2.43	3-1/4	5	9572075
SX0_14000T9		.5512	14.00	9/16	1.67	2-1/2	5	9571855	2.42	3-1/4	5	9572076
SX0_14290T9	9/16	.5625	14.29	9/16	2.16	3	5	9571857	2.41	3-1/4	5	9572079
SX0_14500T9		.5709	14.50	5/8	2.14	3	5	9571859	2.39	3-1/4	5	9572081
SX0_14680T9	37/64	.5781	14.68	5/8	2.13	3	5	9571860	2.63	3-1/2	6	9572082
SX0_15000T9		.5906	15.00	5/8	2.11	3	5	9571861	2.61	3-1/2	6	9572083
SX0_15080T9	19/32	.5938	15.08	5/8	2.11	3	5	9584746	2.61	3-1/2	6	9572084
SX0_15480T9	39/64	.6094	15.48	5/8	2.09	3	5	9584747	2.59	3-1/2	6	9572085
SX0_15500T9		.6102	15.50	5/8	2.08	3	5	9584748	2.58	3-1/2	6	9572086
SX0_15870T9	5/8	.6250	15.88	5/8	2.06	3	5	9571862	2.56	3-1/2	6	9572087
SX0_16000T9		.6299	16.00	3/4	2.06	3	5	9571864	2.56	3-1/2	6	9572088

*Order Example

SX0_00200T9 > 03xD >>> SX00300200T9

SX0_00200T9 > 05xD >>> SX00500200T9

** Diameters (2.0-2.9mm) and other dimensions are available upon request**



SCAN FOR SPEEDS & FEEDS



**High Performance
Double Margin
Coolant Thru Drill
3xD-12xD**
**Ideal for – Steels,
Stainless, & Titanium**

Refer to page 4



SCAN FOR SPEEDS & FEEDS

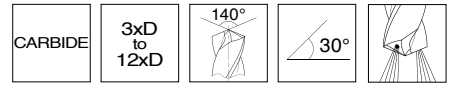

Varianta® Supral Provides a low coefficient of friction, reducing tool wear and resulting in a longer tool life. Varianta® Supral

140° Point Geometry - Split-point geometry for superior drill penetration and accuracy.

Double Margin Design - For improved drilling stability and smooth surface finish.

Coolant Holes - Cool the cutting edge and improve chip evacuation.

Mirror Polished Flutes - on 12xD polish process adds lubricity for better chip evacuation on deep hole drilling.

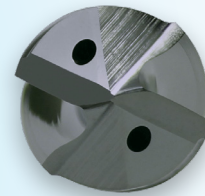

No Pecking Required

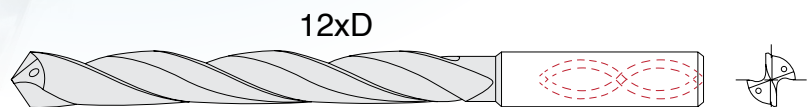
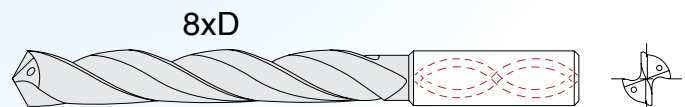
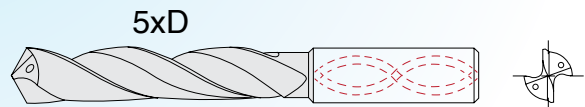
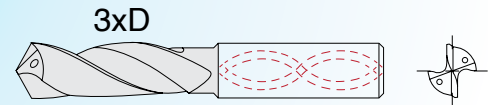
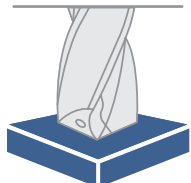



Design – Spiral fluted, right-hand cut, with internal coolant and a cylindrical shank.

Refer to page 4



3xD
to
5xD



Varianta® Supral Provides a low coefficient of friction, reducing tool wear and resulting in a longer tool life.

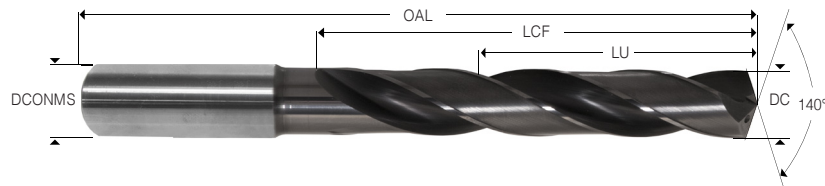

Item Description (Insert 03 or 05 in place of __) *Order Example	**DC Cutting Diameter			DCONMS	3xD Dimensions (mm)				5xD Dimensions (mm)			
	Fraction	Decimal	mm		LU Usable Length	LCF Length Chip Flute	OAL Overall Length	Item Number	LU Usable Length	LCF Length Chip Flute	OAL Overall Length	Item Number
DXC_08100T9		.1181	3.000	6	16	20	62	9544480	24	28	66	9544634
DXC_08200T9		.1220	3.099	6	15	20	62	9544481	23	28	66	9544635
DXC_08300T9	1/8	.1250	3.175	6	15	20	62	9544482	23	28	66	9544637
DXC_08330T9		.1260	3.200	6	15	20	62	9544483	23	28	66	9544638
DXC_08400T9		.1299	3.299	6	15	20	62	9544484	23	28	66	9544639
DXC_08500T9		.1339	3.401	6	15	20	62	9544485	23	28	66	9544640
DXC_08600T9		.1378	3.500	6	15	20	62	9544486	23	28	66	9544641
DXC_08700T9	9/64	.1406	3.571	6	15	20	62	9544487	23	28	66	9544642
DXC_08730T9		.1417	3.599	6	15	20	62	9544488	23	28	66	9544643
DXC_08800T9		.1457	3.701	6	14	20	62	9544489	22	28	66	9544644
DXC_08900T9		.1496	3.800	6	18	24	66	9544490	30	36	74	9544645
DXC_09000T9		.1535	3.899	6	18	24	66	9544491	30	36	74	9544646
DXC_09100T9	5/32	.1563	3.970	6	18	24	66	9544492	30	36	74	9544647
DXC_09130T9		.1575	4.001	6	18	24	66	9544494	30	36	74	9544648
DXC_09200T9		.1614	4.100	6	18	24	66	9544495	30	36	74	9544649
DXC_09300T9		.1654	4.201	6	18	24	66	9544496	30	36	74	9544650
DXC_09400T9		.1693	4.300	6	18	24	66	9544498	30	36	74	9544651
DXC_09500T9	11/64	.1719	4.366	6	17	24	66	9544499	29	36	74	9544652
DXC_09520T9		.1732	4.399	6	17	24	66	9544500	29	36	74	9544654
DXC_09600T9		.1772	4.501	6	17	24	66	9544501	29	36	74	9544656
DXC_09700T9		.1811	4.600	6	17	24	66	9544502	29	36	74	9544657
DXC_09800T9		.1831	4.651	6	17	24	66	9544503	29	36	74	9544658
DXC_09900T9	#13	.1850	4.699	6	17	24	66	9544479	29	36	74	9544633
DXC_09920T9	3/16	.1875	4.763	6	21	28	66	9544504	37	44	82	9544660
DXC_10000T9	#12	.1890	4.801	6	21	28	66	9544478	37	44	82	9544632
DXC_10100T9		.1929	4.900	6	21	28	66	9544506	37	44	82	9544661
DXC_10200T9		.1969	5.001	6	20	28	66	9544507	36	44	82	9544662
DXC_10300T9		.2008	5.100	6	20	28	66	9544508	36	44	82	9544663
DXC_10320T9	13/64	.2031	5.159	6	20	28	66	9544509	36	44	82	9544664
DXC_10400T9	#6	.2040	5.182	6	20	28	66	9544477	36	44	82	9544631
DXC_10500T9		.2047	5.199	6	20	28	66	9544510	36	44	82	9544665
DXC_10600T9		.2087	5.301	6	20	28	66	9544511	36	44	82	9544666
DXC_10700T9		.2126	5.400	6	20	28	66	9544512	36	44	82	9544667
DXC_10720T9		.2165	5.499	6	20	28	66	9544513	36	44	82	9544668
DXC_10800T9		.2185	5.550	6	20	28	66	9544514	36	44	82	9544669
DXC_10900T9	7/32	.2187	5.555	6	20	28	66	9544515	36	44	82	9544670
DXC_11000T9		.2205	5.601	6	20	28	66	9544516	36	44	82	9544671
DXC_11100T9		.2244	5.700	6	19	28	66	9544517	35	44	82	9544672
DXC_11113T9		.2283	5.799	6	19	28	66	9544518	35	44	82	9544673
DXC_11200T9		.2323	5.900	6	19	28	66	9544520	35	44	82	9544676
DXC_11300T9	15/64	.2344	5.954	6	19	28	66	9544521	35	44	82	9544677
DXC_11400T9		.2362	5.999	6	19	28	66	9544522	35	44	82	9544678
DXC_11500T9		.2402	6.101	8	25	34	79	9544524	44	53	91	9544679
DXC_11510T9		.2441	6.200	8	25	34	79	9544525	44	53	91	9544680
DXC_11600T9		.2480	6.299	8	25	34	79	9544526	44	53	91	9544681

***Order Example**

DXC_03000T9 > 03xD >>> DXC0303000T9

DXC_03000T9 > 05xD >>> DXC0503000T9

** Diameters (2.0-2.9mm) and other dimensions are available upon request**

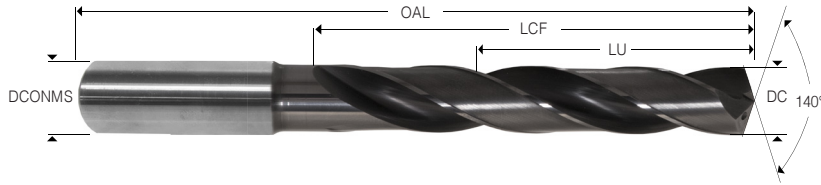

Item Description (Insert 03 or 05 in place of _ _) *Order Example	**DC Cutting Diameter			DCONMS	3xD Dimensions (mm)				5xD Dimensions (mm)			
	Fraction	Decimal	mm		LU Usable Length	LCF Length Chip Flute	OAL Overall Length	Item Number	LU Usable Length	LCF Length Chip Flute	OAL Overall Length	Item Number
DXC_ _11700T9		.2500	6.350	8	24	34	79	9544527	43	53	91	9544682
DXC_ _11800T9		.2520	6.401	8	24	34	79	9544530	43	53	91	9544683
DXC_ _11900T9		.2559	6.500	8	24	34	79	9544531	43	53	91	9544684
DXC_ _11910T9		.2598	6.599	8	24	34	79	9544533	43	53	91	9544685
DXC_ _12000T9		.2638	6.701	8	24	34	79	9544534	43	53	91	9544686
DXC_ _12100T9	17/64	.2656	6.746	8	24	34	79	9544535	43	53	91	9544687
DXC_ _12200T9		.2677	6.800	8	24	34	79	9544536	43	53	91	9544688
DXC_ _12300T9		.2717	6.901	8	31	41	79	9544538	43	53	91	9544689
DXC_ _12303T9		.2756	7.000	8	31	41	79	9544541	42	53	91	9544690
DXC_ _12400T9		.2795	7.099	8	30	41	79	9544542	42	53	91	9544691
DXC_ _12500T9	9/32	.2813	7.145	8	30	41	79	9544543	42	53	91	9544692
DXC_ _12600T9		.2835	7.201	8	30	41	79	9544544	42	53	91	9544693
DXC_ _12700T9		.2874	7.300	8	30	41	79	9544545	42	53	91	9544694
DXC_ _12800T9		.2913	7.399	8	30	41	79	9544546	42	53	91	9544695
DXC_ _12900T9		.2953	7.501	8	30	41	79	9544547	42	53	91	9544696
DXC_ _13000T9	19/64	.2969	7.541	8	30	41	79	9544548	42	53	91	9544697
DXC_ _13300T9		.2992	7.600	8	30	41	79	9593286	42	53	91	9593227
DXC_ _13490T9		.3031	7.699	8	29	41	79	9544549	41	53	91	9544698
DXC_ _13500T9		.3071	7.800	8	29	41	79	9544550	41	53	91	9544699
DXC_ _14000T9		.3110	7.899	8	29	41	79	9544551	41	53	91	9544700
DXC_ _14290T9	5/16	.3125	7.938	8	29	41	79	9544552	41	53	91	9544701
DXC_ _14500T9		.3150	8.001	8	29	41	79	9544554	41	53	91	9544702
DXC_ _15000T9		.3189	8.100	10	35	47	89	9544555	49	61	103	9544703
DXC_ _15500T9		.3228	8.199	10	35	47	89	9544556	49	61	103	9544704
DXC_ _15870T9		.3268	8.301	10	35	47	89	9544557	49	61	103	9544705
DXC_ _16000T9	21/64	.3281	8.334	10	35	47	89	9544558	49	61	103	9544706
DXC_ _16500T9		.3307	8.400	10	34	47	89	9544559	48	61	103	9544707
DXC_ _17000T9		.3346	8.499	10	34	47	89	9544560	48	61	103	9544708
DXC_ _17460T9		.3386	8.600	10	34	47	89	9544561	48	61	103	9544709
DXC_ _17500T9		.3425	8.700	10	34	47	89	9544562	48	61	103	9544710
DXC_ _18000T9	11/32	.3437	8.730	10	34	47	89	9544563	48	61	103	9544711
DXC_ _18500T9		.3465	8.801	10	34	47	89	9544564	48	61	103	9544712
DXC_ _19000T9		.3504	8.900	10	34	47	89	9593209	48	61	103	9593228
DXC_ _19050T9		.3543	8.999	10	34	47	89	9544566	48	61	103	9544713
DXC_ _19500T9		.3583	9.101	10	33	47	89	9593210	47	61	103	9593229
DXC_ _20000T9	23/64	.3594	9.129	10	33	47	89	9544567	47	61	103	9544714
DXC_ _03000T9		.3622	9.200	10	33	47	89	9544568	47	61	103	9544715
DXC_ _03100T9		.3661	9.299	10	33	47	89	9544569	47	61	103	9544716
DXC_ _03175T9		.3700	9.398	10	33	47	89	9593211	47	61	103	9593230
DXC_ _03200T9		.3740	9.500	10	33	47	89	9544570	47	61	103	9544717
DXC_ _03300T9		.3750	9.525	10	33	47	89	9544571	47	61	103	9544718
DXC_ _03400T9		.3780	9.601	10	33	47	89	9544573	47	61	103	9544719
DXC_ _03500T9		.3819	9.700	10	32	47	89	9593212	46	61	103	9593231
DXC_ _03572T9		.3858	9.799	10	32	47	89	9544574	46	61	103	9544720
DXC_ _03600T9		.3898	9.901	10	32	47	89	9544575	46	61	103	9544721
DXC_ _03700T9	25/64	.3906	9.921	10	32	47	89	9544576	46	61	103	9544722
DXC_ _03800T9		.3937	10.000	10	32	47	89	9544577	46	61	103	9544723
DXC_ _03900T9		.3976	10.099	12	40	55	102	9544578	56	71	118	9544724
DXC_ _03970T9		.4016	10.201	12	40	55	102	9544579	56	71	118	9544725
DXC_ _04000T9		.4055	10.300	12	40	55	102	9544580	56	71	118	9544726
DXC_ _04100T9	13/32	.4063	10.320	12	40	55	102	9544581	56	71	118	9544727
DXC_ _04200T9		.4094	10.399	12	39	55	102	9544582	55	71	118	9544728
DXC_ _04300T9		.4134	10.500	12	39	55	102	9544583	55	71	118	9544729
DXC_ _04370T9		.4173	10.599	12	39	55	102	9593213	55	71	118	9593232
DXC_ _04400T9		.4213	10.701	12	39	55	102	9593214	55	71	118	9593233

*Order Example

DXC_ _05900T9 > 03xD >>> DXC0305900T9

DXC_ _05900T9 > 05xD >>> DXC0505900T9

** Diameters (2.0-2.9mm) and other dimensions are available upon request**

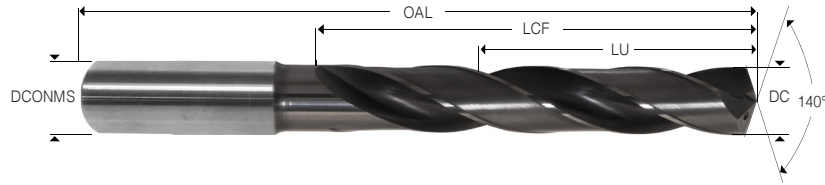

Item Description (Insert 03 or 05 in place of _)	**DC Cutting Diameter			DCONMS	3xD Dimensions (mm)				5xD Dimensions (mm)			
	Fraction	Decimal	mm		LU Usable Length	LCF Length Chip Flute	OAL Overall Length	Item Number	LU Usable Length	LCF Length Chip Flute	OAL Overall Length	Item Number
DXC_04500T9	27/64	.4219	10.716	12	39	55	102	9544584	55	71	118	9544730
DXC_04600T9		.4252	10.800	12	39	55	102	9544585	55	71	118	9544732
DXC_04650T9		.4291	10.899	12	39	55	102	9593215	55	71	118	9593234
DXC_00130T9		.4331	11.001	12	38	55	102	9544586	55	71	118	9544733
DXC_04760T9		.4370	11.100	12	38	55	102	9544587	54	71	118	9544734
DXC_00120T9		.4375	11.113	12	38	55	102	9544588	54	71	118	9544735
DXC_04900T9		.4409	11.199	12	38	55	102	9544590	54	71	118	9544736
DXC_05000T9		.4449	11.300	12	38	55	102	9593216	54	71	118	9593235
DXC_05100T9		.4488	11.400	12	38	55	102	9593217	54	71	118	9593221
DXC_05160T9		.4528	11.501	12	38	55	102	9544591	54	71	118	9544737
DXC_00060T9	29/64	.4531	11.509	12	38	55	102	9544592	54	71	118	9544738
DXC_05200T9		.4567	11.600	12	38	55	102	9593218	54	71	118	9593222
DXC_05300T9		.4606	11.699	12	37	55	102	9544593	53	71	118	9544739
DXC_05400T9		.4646	11.801	12	37	55	102	9544594	53	71	118	9544740
DXC_05500T9		.4685	11.900	12	37	55	102	9593219	53	71	118	9593223
DXC_05550T9	15/32	.4687	11.905	12	37	55	102	9544595	53	71	118	9544741
DXC_05560T9		.4724	11.999	12	37	55	102	9544596	53	71	118	9544742
DXC_05600T9		.4764	12.101	14	42	60	107	9544597	59	77	124	9544743
DXC_05700T9		.4803	12.200	14	42	60	107	9544598	59	77	124	9544744
DXC_05800T9		.4843	12.301	14	42	60	107	9544599	59	77	124	9544745
DXC_05900T9	31/64	.4844	12.304	14	42	60	107	9544600	59	77	124	9544746
DXC_05950T9		.4882	12.400	14	41	60	107	9544601	58	77	124	9593668
DXC_06000T9		.4921	12.499	14	41	60	107	9544602	58	77	124	9544747
DXC_06100T9		.4961	12.601	14	41	60	107	9544603	58	77	124	9544748
DXC_06200T9	1/2	.5000	12.700	14	41	60	107	9544604	58	77	124	9544749
DXC_06300T9		.5039	12.799	14	41	60	107	9593664	58	77	124	9593669
DXC_06350T9		.5079	12.901	14	41	60	107	9593665	58	77	124	9593670
DXC_06400T9		.5118	13.000	14	41	60	107	9544606	58	77	124	9544750
DXC_06500T9		.5236	13.299	14	40	60	107	9544607	57	77	124	9544751
DXC_06600T9	17/32	.5313	13.495	14	40	60	107	9544608	57	77	124	9544752
DXC_06700T9		.5315	13.500	14	40	60	107	9544609	57	77	124	9544753
DXC_06750T9		.5512	14.000	14	39	60	107	9544610	56	77	124	9544754
DXC_06800T9		.5625	14.288	16	44	65	115	9544611	62	83	133	9544755
DXC_06900T9		.5709	14.501	16	43	65	115	9544613	61	83	133	9544756
DXC_07000T9		.5906	15.001	16	42	65	115	9544614	60	83	133	9544757
DXC_07100T9		.6102	15.499	16	42	65	115	9544615	60	83	133	9544758
DXC_07140T9		.6250	15.875	16	41	65	115	9544616	59	83	133	9544759
DXC_07200T9		.6299	15.999	16	41	65	115	9544618	59	83	133	9544760
DXC_07300T9		.6496	16.500	18	48	73	123	9544619	68	93	143	9544761
DXC_07400T9		.6693	17.000	18	48	73	123	9544621	68	93	143	9544762
DXC_07500T9	11/16	.6875	17.463	18	47	73	123	9593220	67	93	143	9593224
DXC_07540T9		.6890	17.501	18	47	73	123	9544622	67	93	143	9544763
DXC_07700T9		.7087	18.001	18	46	73	123	9544623	66	93	143	9544764
DXC_07800T9		.7283	18.499	20	51	79	131	9544624	73	101	153	9544765
DXC_07900T9		.7480	18.999	20	50	79	131	9593226	72	101	153	9593225
DXC_07940T9	3/4	.7500	19.050	20	50	79	131	9544625	72	101	153	9544766
DXC_08000T9		.7677	19.500	20	50	79	131	9544627	72	101	153	9544767
DXC_07600T9		.7874	20.000	20	49	79	131	9544628	71	101	153	9544768

CARBIDE DRILLS

***Order Example**

DXC_10300T99 > 03xD >>> DXC0310300T9
 DXC_10300T99 > 05xD >>> DXC0510300T9

** Diameters (2.0-2.9mm) and other dimensions are available upon request**



SCAN FOR SPEEDS & FEEDS

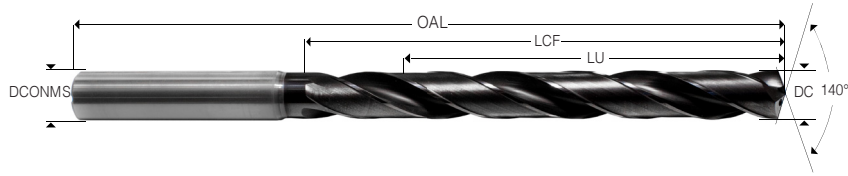

Item Description (Insert 08 or 12 in place of _)	**DC Cutting Diameter			DCONMS	8xD			12xD				
	Fraction	Decimal	mm		Dimensions (mm)			Item Number	Dimensions (mm)			Item Number
					LU Usable Length	LCF Length Chip Flute	OAL Overall Length		LU Usable Length	LCF Length Chip Flute	OAL Overall Length	
DXC_03000T9		.1181	3.00	6	30	34	72	9544774	49	54	92	9544910
DXC_03100T9		.1220	3.10	6	29	34	72	9544775	49	54	92	9544911
DXC_03175T9	1/8	.1250	3.18	6	29	34	72	9544776	49	54	92	9544912
DXC_03200T9		.1260	3.20	6	29	34	72	9544777	49	54	92	9544913
DXC_03300T9		.1299	3.30	6	29	34	72	9544778	49	54	92	9544914
DXC_03400T9		.1339	3.40	6	29	34	72	9544779	49	54	92	9544915
DXC_03500T9		.1378	3.50	6	29	34	72	9544780	49	54	92	9544916
DXC_03572T9	9/64	.1406	3.57	6	29	34	72	9544781	49	54	92	9544917
DXC_03600T9		.1417	3.60	6	29	34	72	9544782	49	54	92	9544918
DXC_03700T9		.1457	3.70	6	28	34	72	9544783	48	54	92	9544919
DXC_03800T9		.1496	3.80	6	37	41	81	9544784	58	64	102	9544920
DXC_03900T9		.1535	3.90	6	37	41	81	9544785	58	64	102	9544921
DXC_03970T9	5/32	.1563	3.97	6	37	41	81	9544786	58	64	102	9544922
DXC_04000T9		.1575	4.00	6	37	41	81	9544787	58	64	102	9544923
DXC_04100T9		.1614	4.10	6	37	41	81	9544788	58	64	102	9544924
DXC_04200T9		.1654	4.20	6	37	41	81	9544789	58	64	102	9544925
DXC_04300T9		.1693	4.30	6	37	41	81	9544791	58	64	102	9544926
DXC_04370T9	11/64	.1719	4.37	6	36	41	81	9544792	57	64	102	9544927
DXC_04400T9		.1732	4.40	6	36	41	81	9544793	57	64	102	9544928
DXC_04500T9		.1772	4.50	6	36	41	81	9544794	57	64	102	9544929
DXC_04600T9		.1811	4.60	6	36	43	81	9544795	57	64	102	9544930
DXC_04650T9		.1831	4.65	6	36	43	81	9544796	57	64	102	9544931
DXC_00130T9	#13	.1850	4.70	6	36	43	81	9544772	57	64	102	9544909
DXC_04760T9	3/16	.1875	4.76	6	50	57	95	9544797	71	78	116	9544932
DXC_00120T9	#12	.1890	4.80	6	50	57	95	9544771	71	78	116	9544908
DXC_04900T9		.1929	4.90	6	50	57	95	9544798	71	78	116	9544933
DXC_05000T9		.1969	5.00	6	49	57	95	9544799	70	78	116	9544934
DXC_05100T9		.2008	5.10	6	49	57	95	9544800	70	78	116	9544935
DXC_05160T9	13/64	.2031	5.16	6	49	57	95	9544801	70	78	116	9544936
DXC_00060T9	#6	.2040	5.18	6	49	57	95	9544770	70	78	116	9544907
DXC_05200T9		.2047	5.20	6	49	57	95	9544802	70	78	116	9544937
DXC_05300T9		.2087	5.30	6	49	57	95	9544803	70	78	116	9544938
DXC_05400T9		.2126	5.40	6	49	57	95	9544804	70	78	116	9544939
DXC_05500T9		.2165	5.50	6	49	57	95	9544805	70	78	116	9544940
DXC_05550T9		.2185	5.55	6	49	57	95	9544806	70	78	116	9544941
DXC_05560T9	7/32	.2187	5.55	6	49	57	95	9544807	70	78	116	9544942
DXC_05600T9		.2205	5.60	6	49	57	95	9544808	70	78	116	9544943
DXC_05700T9		.2244	5.70	6	48	57	95	9544809	69	78	116	9544944
DXC_05800T9		.2283	5.80	6	48	57	95	9544810	69	78	116	9544945
DXC_05900T9		.2323	5.90	6	48	57	95	9544811	69	78	116	9544946
DXC_05950T9	15/64	.2344	5.95	6	48	57	95	9544812	69	78	116	9544947
DXC_06000T9		.2362	6.00	6	48	57	95	9544813	69	78	116	9544948
DXC_06100T9		.2402	6.10	8	67	76	114	9544814	99	108	146	9544949
DXC_06200T9		.2441	6.20	8	67	76	114	9544815	99	108	146	9544950
DXC_06300T9		.2480	6.30	8	67	76	114	9544816	99	108	146	9544951
DXC_06350T9	1/4	.2500	6.35	8	66	76	114	9544817	98	108	146	9544952
DXC_06400T9		.2520	6.40	8	66	76	114	9544819	98	108	146	9544953
DXC_06500T9		.2559	6.50	8	66	76	114	9544820	98	108	146	9544954
DXC_06600T9		.2598	6.60	8	66	76	114	9544821	98	108	146	9544955
DXC_06700T9		.2638	6.70	8	66	76	114	9544822	98	108	146	9544956
DXC_06750T9	17/64	.2656	6.75	8	66	76	114	9544823	98	108	146	9544957
DXC_06800T9		.2677	6.80	8	66	76	114	9544824	98	108	146	9544958
DXC_06900T9		.2717	6.90	8	66	76	114	9544825	98	108	146	9544959
DXC_07000T9		.2756	7.00	8	65	76	114	9544826	98	108	146	9544960
DXC_07100T9		.2795	7.10	8	65	76	114	9544827	97	108	146	9544961
DXC_07140T9	9/32	.2813	7.15	8	65	76	114	9544828	97	108	146	9544962
DXC_07200T9		.2835	7.20	8	65	76	114	9544829	97	108	146	9544963
DXC_07300T9		.2874	7.30	8	65	76	114	9544830	97	108	146	9592568
DXC_07400T9		.2913	7.40	8	65	76	114	9544831	97	108	146	9592569
DXC_07500T9		.2953	7.50	8	65	76	114	9544832	97	108	146	9544964
DXC_07540T9	19/64	.2969	7.54	8	65	76	114	9544833	97	108	146	9544965
DXC_07700T9		.3031	7.70	8	64	76	114	9544834	96	108	146	9544966
DXC_07800T9		.3071	7.80	8	64	76	114	9544835	96	108	146	9544967
DXC_07900T9		.3110	7.90	8	64	76	114	9544836	96	108	146	9544968
DXC_07940T9	5/16	.3125	7.94	8	64	76	114	9544837	96	120	162	9544969
DXC_08000T9		.3150	8.00	8	64	76	114	9544838	96	120	162	9544970
DXC_08100T9		.3189	8.10	10	83	95	142	9544839	108	120	162	9544971

***Order Example**

DXC_03000T9 > 08xD >>> DXC0803000T9

DXC_03000T9 > 12xD >>> DXC1203000T9

** Diameters (2.0-2.9mm) and other dimensions are available upon request**

CARBIDE DRILLS

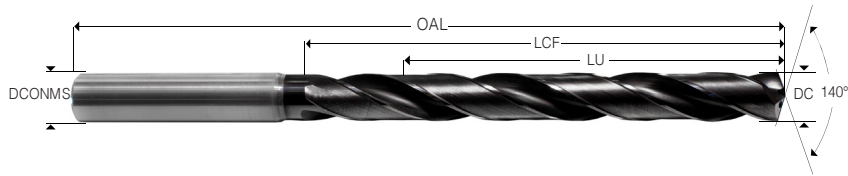

Item Description (Insert 08 or 12 in place of _) *Order Example	**DC Cutting Diameter			DCONMS	8xD Dimensions (mm)				12xD Dimensions (mm)			
	Fraction	Decimal	mm		LU Usable Length	LCF Length Chip Flute	OAL Overall Length	Item Number	LU Usable Length	LCF Length Chip Flute	OAL Overall Length	Item Number
DXC_08200T9		.3228	8.20	10	83	95	142	9544840	108	120	162	9544972
DXC_08300T9		.3268	8.30	10	83	95	142	9544841	108	120	162	9544973
DXC_08330T9	21/64	.3281	8.33	10	82	95	142	9544842	108	120	162	9544974
DXC_08400T9		.3307	8.40	10	82	95	142	9544843	107	120	162	9544975
DXC_08500T9		.3346	8.50	10	82	95	142	9544844	107	120	162	9544976
DXC_08600T9		.3386	8.60	10	82	95	142	9544845	107	120	162	9544977
DXC_08700T9		.3425	8.70	10	82	95	142	9544846	107	120	162	9544978
DXC_08730T9	11/32	.3437	8.73	10	82	95	142	9544847	107	120	162	9544979
DXC_08800T9		.3465	8.80	10	82	95	142	9544848	107	120	162	9544980
DXC_09000T9		.3543	9.00	10	82	95	142	9544849	107	120	162	9544981
DXC_09130T9	23/64	.3594	9.13	10	81	95	142	9544850	106	120	162	9544982
DXC_09200T9		.3622	9.20	10	81	95	142	9544851	106	120	162	9544983
DXC_09300T9		.3661	9.30	10	81	95	142	9544852	106	120	162	9544984
DXC_09500T9		.3740	9.50	10	81	95	142	9544853	106	120	162	9544985
DXC_09520T9	3/8	.3750	9.53	10	81	95	142	9544854	106	120	162	9544986
DXC_09600T9		.3780	9.60	10	81	95	142	9544855	106	120	162	9544987
DXC_09800T9		.3858	9.80	10	80	95	142	9544856	105	120	162	9544988
DXC_09900T9		.3898	9.90	10	80	95	142	9544857	105	120	162	9544989
DXC_09920T9	25/64	.3906	9.92	10	80	95	142	9544858	105	156	204	9544990
DXC_10000T9		.3937	10.00	10	80	95	142	9544859	105	156	204	9544991
DXC_10100T9		.3976	10.10	12	99	114	162	9544860	141	156	204	9544992
DXC_10200T9		.4016	10.20	12	99	114	162	9544861	141	156	204	9544993
DXC_10300T9		.4055	10.30	12	99	114	162	9544862	141	156	204	9544994
DXC_10320T9	13/32	.4063	10.32	12	99	114	162	9544863	141	156	204	9544995
DXC_10400T9		.4094	10.40	12	98	114	162	9544864	140	156	204	9544996
DXC_10500T9		.4134	10.50	12	98	114	162	9544865	140	156	204	9544997
DXC_10720T9	27/64	.4219	10.72	12	98	114	162	9544866	140	156	204	9544998
DXC_10800T9		.4252	10.80	12	98	114	162	9544868	140	156	204	9544999
DXC_11000T9		.4331	11.00	12	98	114	162	9544869	139	156	204	9545000
DXC_11100T9		.4370	11.10	12	97	114	162	9544870	139	156	204	9545001
DXC_11113T9	7/16	.4375	11.11	12	97	114	162	9544871	139	156	204	9545002
DXC_11200T9		.4409	11.20	12	97	114	162	9544872	139	156	204	9545003
DXC_11500T9		.4528	11.50	12	97	114	162	9544873	139	156	204	9545004
DXC_11510T9	29/64	.4531	11.51	12	97	114	162	9544874	139	156	204	9545005
DXC_11700T9		.4606	11.70	12	96	114	162	9544875	138	156	204	9545006
DXC_11800T9		.4646	11.80	12	96	114	162	9544876	138	156	204	9545007
DXC_11910T9	15/32	.4687	11.90	12	96	114	162	9544877	138	182	230	9545008
DXC_12000T9		.4724	12.00	12	96	114	162	9544878	138	230	280	9545009
DXC_12100T9		.4764	12.10	14	113	131	178	9544879	164	230	280	9545010
DXC_12200T9		.4803	12.20	14	113	131	178	9544880	164	182	230	9545011
DXC_12300T9		.4843	12.30	14	113	131	178	9544881	164	182	230	9545012
DXC_12303T9	31/64	.4844	12.30	14	113	131	178	9544882	164	182	230	9545013
DXC_12500T9		.4921	12.50	14	112	131	178	9544883	163	182	230	9545014
DXC_12600T9		.4961	12.60	14	112	131	178	9544884	163	182	230	9545015
DXC_12700T9	1/2	.5000	12.70	14	112	131	178	9544885	163	182	230	9545016
DXC_13000T9		.5118	13.00	14	112	131	178	9544886	163	182	230	9545017
DXC_13300T9		.5236	13.30	14	111	131	178	9544887	162	182	230	9545018
DXC_13490T9	17/32	.5313	13.50	14	111	131	178	9544888	162	182	230	9545019
DXC_13500T9		.5315	13.50	14	111	131	178	9544889	162	182	230	9545020
DXC_14000T9		.5512	14.00	14	110	131	178	9544890	161	182	230	9545021
DXC_14290T9	9/16	.5625	14.29	16	131	152	203	9544891	187	208	260	9545022
DXC_14500T9		.5709	14.50	16	130	152	203	9544892	186	208	260	9545023
DXC_15000T9		.5906	15.00	16	129	152	203	9544893	185	208	260	9545024
DXC_15500T9		.6102	15.50	16	129	152	203	9544894	185	208	260	9545025
DXC_15870T9	5/8	.6250	15.88	16	128	152	203	9544895	184	208	260	9545026
DXC_16000T9		.6299	16.00	16	128	152	203	9544896	184	208	260	9545027
DXC_16500T9		.6496	16.50	18	146	171	222	9544898	209	234	285	9545028
DXC_17000T9		.6693	17.00	18	146	171	222	9544899	209	234	285	9545029
DXC_17500T9		.6890	17.50	18	145	171	222	9544900	208	234	285	9545030
DXC_18000T9		.7087	18.00	18	144	171	222	9544901	207	234	285	9545031
DXC_18500T9		.7283	18.50	20	162	190	243	9544902	230	258	310	9545032
DXC_19050T9	3/4	.7500	19.05	20	161	190	243	9544903	229	258	310	9545033
DXC_19500T9		.7677	19.50	20	161	190	243	9544904	229	258	310	9545034
DXC_20000T9		.7874	20.00	20	160	190	243	9544905	228	258	310	9545035

CARBIDE DRILLS

***Order Example**

DXC_06900T9 > 08xD >>> DXC0806900T9

DXC_06900T9 > 12xD >>> DXC1206900T9

** Diameters (2.0-2.9mm) and other dimensions are available upon request**



SCAN FOR SPEEDS & FEEDS



**High Performance
Double Margin
Coolant Thru Drill**
Ideal for Steels, Stainless,
and Titanium
16xD-50xD



SCAN FOR SPEEDS & FEEDS

CARBIDE	16xD to 50xD	135°	30°	 Varianta® Supral
---------	--------------------	------	-----	--

Varianta® Supral Provides a low coefficient of friction, reducing tool wear and resulting in a longer tool life.



135° Point Geometry - Split-point geometry for superior drill penetration and accuracy.

Double-Margin Design - For improved drilling stability and smooth surface finish.

Coolant Holes - Cool the cutting edge and improve chip evacuation.

Mirror Polished Flutes - on 16xD-50xD polish process adds lubricity for better chip evacuation on deep hole drilling.

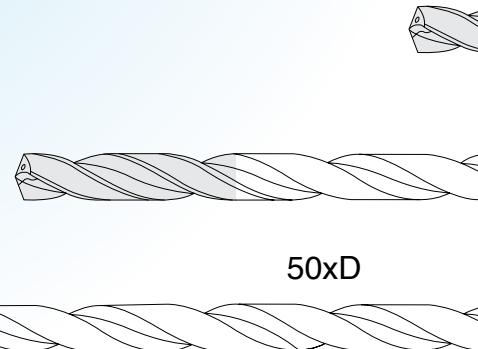
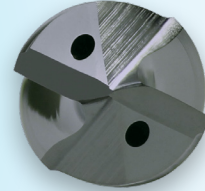

Design – Long spiral-fluted, right-hand cut, double-margin and internal coolant.

P M S Refer to page 4

No Pecking Required

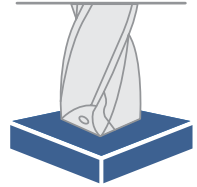

16xD



20xD



25xD

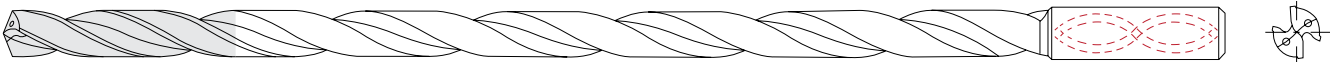

30xD



40xD



16xD – 30xD should utilize a pilot hole drill. Refer to page 77. 40xD & 50xD must utilize a 20xD intermediary drill along with pilot drill. Refer to page 52.



Design – Long spiral-fluted, right-hand cut, double-margin and internal coolant.

P M K S Refer to page 4



Varianta® Supral Provides a low coefficient of friction, reducing tool wear and resulting in a longer tool life.

■ 16xD–30xD must utilize a pilot hole drill. (Refer to page 77)



Item Description (Insert 16 or 20 in place of _)	**DC Cutting Diameter			DCONMS	16xD Dimensions (mm)				20xD Dimensions (mm)				
	*Order Example	Fraction	Decimal		mm	LU Usable Length	LCF Length Chip Flute	OAL Overall Length	Item Number	LU Usable Length	LCF Length Chip Flute	OAL Overall Length	Item Number
SXC_03000T9			.1181	3.00	6	56	60	100	9572420	76	80	120	9572626
SXC_03175T9	1/8		.1250	3.18	6	55	60	100	9572422	75	80	120	9572633
SXC_03200T9			.1260	3.20	6	55	60	100	9572423	75	80	120	9572634
SXC_03300T9			.1299	3.30	6	55	60	100	9572425	75	80	120	9572636
SXC_03500T9			.1378	3.50	6	55	60	100	9572429	75	80	120	9572640
SXC_03572T9	9/64		.1406	3.57	6	70	75	115	9572431	85	90	130	9572641
SXC_03800T9			.1496	3.80	6	69	75	115	9572434	84	90	130	9572644
SXC_03970T9	5/32		.1563	3.97	6	69	75	115	9572437	84	90	130	9572647
SXC_04000T9			.1575	4.00	6	69	75	115	9572438	84	90	130	9572648
SXC_04100T9			.1614	4.10	6	69	75	115	9572440	104	110	160	9572655
SXC_04200T9			.1654	4.20	6	69	75	115	9572441	-	-	-	-
SXC_04370T9	11/64		.1719	4.37	6	83	90	130	9572444	103	110	160	9572657
SXC_04500T9			.1772	4.50	6	83	90	130	9572448	103	110	160	9572660
SXC_00130T9	#13		.1850	4.70	6	83	90	130	9572414	113	120	160	9572612
SXC_04760T9	3/16		.1875	4.76	6	83	90	130	9572454	113	120	160	9572663
SXC_00120T9	#12		.1890	4.80	6	83	90	130	9572413	113	120	160	9572611
SXC_05000T9			.1969	5.00	6	82	90	130	9572457	112	120	160	9572668
SXC_05160T9	13/64		.2031	5.16	6	100	108	150	9572462	132	140	185	9572671
SXC_00060T9	#6		.2040	5.18	6	100	108	150	9572412	132	140	185	9572609
SXC_05500T9			.2165	5.50	6	100	108	150	9572466	132	140	185	9572676
SXC_05560T9	7/32		.2187	5.55	6	100	108	150	9572469	132	140	185	9572678
SXC_05800T9			.2283	5.80	6	99	108	150	9572472	131	140	185	9572681
SXC_05950T9	15/64		.2344	5.95	6	99	108	150	9572476	131	140	185	9572685
SXC_06000T9			.2362	6.00	6	99	108	150	9572477	131	140	185	9572686
SXC_06350T9	1/4		.2500	6.35	8	115	125	165	9572482	150	160	210	9572691
SXC_06500T9			.2559	6.50	8	115	125	165	9572486	150	160	210	9572693
SXC_06750T9	17/64		.2656	6.75	8	115	125	165	9572491	150	160	210	9572697
SXC_06800T9			.2677	6.80	8	115	125	165	9572492	150	160	210	9572698
SXC_07000T9			.2756	7.00	8	115	125	165	9572494	149	160	210	9572700
SXC_07140T9	9/32		.2813	7.15	8	129	140	180	9572497	169	180	230	9572703
SXC_07500T9			.2953	7.50	8	129	140	180	9572501	169	180	230	9572707
SXC_07540T9	19/64		.2969	7.54	8	129	140	180	9572502	169	180	230	9572708
SXC_07800T9			.3071	7.80	8	128	140	180	9572504	168	180	230	9572710
SXC_07940T9	5/16		.3125	7.94	8	128	140	180	9572506	168	180	230	9572714
SXC_08000T9			.3150	8.00	8	128	140	180	9572508	168	180	230	9572715
SXC_08330T9	21/64		.3281	8.33	10	148	160	205	9572512	183	195	260	9572720
SXC_08500T9			.3346	8.50	10	147	160	205	9572515	182	195	260	9572722
SXC_08730T9	11/32		.3437	8.73	10	147	160	205	9572518	217	230	290	9572726
SXC_08800T9			.3465	8.80	10	147	160	205	9572519	217	230	290	9572728
SXC_09000T9			.3543	9.00	10	147	160	205	9572520	217	230	290	9572729
SXC_09130T9	23/64		.3594	9.13	10	166	180	225	9572522	216	230	290	9572730
SXC_09520T9	3/8		.3750	9.53	10	166	180	225	9572527	216	230	290	9572734
SXC_09800T9			.3858	9.80	10	165	180	225	9572533	215	230	290	9572738
SXC_09920T9	25/64		.3906	9.92	10	165	180	225	9572535	215	230	290	9572740

***Order Example**

SXC_03000T9 > 16xD >>> SXC1603000T9

SXC_03000T9 > 20xD >>> SXC2003000T9

** Diameters (2.0-2.9mm) and other dimensions are available upon request**

CARBIDE DRILLS



Item Description (Insert 16 or 20 in place of _ _) *Order Example	**DC Cutting Diameter			DCONMS	16xD Dimensions (mm)				20xD Dimensions (mm)			
	Fraction	Decimal	mm		LU Usable Length	LCF Length Chip Flute	OAL Overall Length	Item Number	LU Usable Length	LCF Length Chip Flute	OAL Overall Length	Item Number
SXC_10000T9		.3937	10.00	10	165	180	225	9572536	215	230	290	9572741
SXC_10200T9		.4016	10.20	12	175	190	240	9572539	253	268	315	9572745
SXC_10320T9	13/32	.4063	10.32	12	175	190	240	9572541	253	268	315	9572747
SXC_10720T9	27/64	.4219	10.72	12	174	190	240	9572545	252	268	315	9572750
SXC_10800T9		.4252	10.80	12	174	190	240	9572546	252	268	315	9572751
SXC_11000T9		.4331	11.00	12	173	190	240	9572547	252	268	315	9572753
SXC_11113T9	7/16	.4375	11.11	12	198	215	265	9572549	251	268	315	9572756
SXC_11500T9		.4528	11.50	12	198	215	265	9572552	251	268	315	9572758
SXC_11510T9	29/64	.4531	11.51	12	198	215	265	9572553	251	268	315	9572759
SXC_11910T9	15/32	.4687	11.90	12	197	215	265	9572556	250	268	315	9572762
SXC_12000T9		.4724	12.00	12	197	215	265	9572558	250	268	315	9572763
SXC_12300T9		.4843	12.30	14	212	230	280	9572562	262	280	325	9572766
SXC_12303T9	31/64	.4844	12.30	14	212	230	280	9572563	262	280	325	9572767
SXC_12700T9	1/2	.5000	12.70	14	211	230	280	9572567	261	280	325	9572772
SXC_13000T9		.5118	13.00	14	210	230	280	9572570	260	280	325	9572776
SXC_13300T9		.5236	13.30	14	225	245	295	9572572	285	305	355	9572777
SXC_13490T9	17/32	.5313	13.50	14	225	245	295	9572573	285	305	355	9572778
SXC_13500T9		.5315	13.50	14	225	245	295	9572574	285	305	355	9572779
SXC_14000T9		.5512	14.00	14	224	245	295	9572575	284	305	355	9572780
SXC_14290T9	9/16	.5625	14.29	16	234	255	305	9572578				
SXC_14500T9		.5709	14.50	16	233	255	305	9572579				
SXC_15000T9		.5906	15.00	16	232	255	305	9572582				
SXC_15500T9		.6102	15.50	16	252	275	325	9572586				
SXC_15870T9	5/8	.6250	15.88	16	251	275	325	9572588				
SXC_16000T9		.6299	16.00	16	251	275	325	9572590				

*Order Example

SXC_10000T9 > 16xD >>> SXC1610000T9

SXC_10000T9 > 20xD >>> SXC2010000T9

** Diameters (2.0-2.9mm) and other dimensions are available upon request**

CARBIDE DRILLS



SCAN FOR SPEEDS & FEEDS



Item Description (Insert 25 or 30 in place of _)	**DC Cutting Diameter			DCONMS	25xD Dimensions (mm)				30xD Dimensions (mm)			
	Fraction	Decimal	mm		LU Usable Length	LCF Length Chip Flute	OAL Overall Length	Item Number	LU Usable Length	LCF Length Chip Flute	OAL Overall Length	Item Number
SXC_ _03000T9		.1181	3.00	6	94	98	135	9572808	101	105	150	9572937
SXC_ _03175T9		.1250	3.18	6	93	98	135	9572810	100	105	150	9572939
SXC_ _03200T9	1/8	.1260	3.20	6	93	98	135	9572811	100	105	150	9572940
SXC_ _03300T9		.1299	3.30	6	93	98	135	9572812	130	135	185	9572941
SXC_ _03500T9		.1378	3.50	6	93	98	135	9572818	130	135	185	9572944
SXC_ _03572T9		.1406	3.57	6	115	120	160	9572819	130	135	185	9572945
SXC_ _03800T9	9/64	.1496	3.80	6	114	120	160	9572822	129	135	185	9572949
SXC_ _03970T9		.1563	3.97	6	114	120	160	9572824	129	135	185	9572952
SXC_ _04000T9	5/32	.1575	4.00	6	114	120	160	9572825	129	135	185	9572954
SXC_ _04200T9		.1654	4.20	6	114	120	160	9572828	129	135	185	9572957
SXC_ _04370T9		.1719	4.37	6	128	135	180	9572830	158	165	215	9572960
SXC_ _04500T9	11/64	.1772	4.50	6	128	135	180	9572833	158	165	215	9572962
SXC_ _00130T9		.1850	4.70	6	128	135	180	9572804	158	165	215	9572931
SXC_ _04760T9	#13	.1875	4.76	6	128	135	180	9572838	158	165	215	9572965
SXC_ _00120T9	3/16	.1890	4.80	6	128	135	180	9572803	158	165	215	9572930
SXC_ _05000T9	#12	.1969	5.00	6	128	135	180	9572841	158	165	215	9572968
SXC_ _05160T9		.2031	5.16	6	160	168	205	9572843	172	180	230	9572970
SXC_ _00060T9	13/64	.2040	5.18	6	160	168	205	9572800	172	180	230	9572929
SXC_ _05500T9	#6	.2165	5.50	6	160	168	205	9572848	172	180	230	9572975
SXC_ _05560T9		.2187	5.55	6	160	168	205	9572850	172	180	230	9572977
SXC_ _05800T9	7/32	.2283	5.80	6	159	168	205	9572853	171	180	230	9572980
SXC_ _05950T9		.2344	5.95	6	159	168	205	9572855	171	180	230	9572982
SXC_ _06000T9	15/64	.2362	6.00	6	159	168	205	9572858	171	180	230	9572983
SXC_ _06350T9		.2500	6.35	8	190	200	240	9572863	205	215	280	9572987
SXC_ _06500T9	1/4	.2559	6.50	8	190	200	240	9572866	205	215	280	9572990
SXC_ _06750T9		.2656	6.75	8	190	200	240	9572869	220	230	280	9572994
SXC_ _06800T9	17/64	.2677	6.80	8	190	200	240	9572870	220	230	280	9572995
SXC_ _07000T9		.2756	7.00	8	189	200	240	9572874	219	230	280	9572998
SXC_ _07140T9		.2813	7.15	8	209	220	260	9572876	219	230	280	9573001
SXC_ _07500T9	9/32	.2953	7.50	8	209	220	260	9572880	219	230	280	9573005
SXC_ _07540T9		.2969	7.54	8	209	220	260	9572881	254	265	315	9573006
SXC_ _07800T9	19/64	.3071	7.80	8	208	220	260	9572883	253	265	315	9573008
SXC_ _07940T9		.3125	7.94	8	208	220	260	9572885	253	265	315	9573010
SXC_ _08000T9	5/16	.3150	8.00	8	208	220	260	9572886	253	265	315	9573011
SXC_ _08330T9		.3281	8.33	10	228	240	285	9572892	283	295	350	9573015
SXC_ _08500T9	21/64	.3346	8.50	10	227	240	285	9572894	282	295	350	9573017
SXC_ _08730T9		.3437	8.73	10	255	268	310	9572897	317	330	380	9573020
SXC_ _08800T9	11/32	.3465	8.80	10	255	268	310	9572898	317	330	380	9573021
SXC_ _09000T9		.3543	9.00	10	255	268	310	9572899	317	330	380	9573023
SXC_ _09130T9		.3594	9.13	10	254	268	310	9572900	316	330	380	9573025
SXC_ _09520T9	23/64	.3750	9.53	10	254	268	310	9572904	316	330	380	9573029
SXC_ _09800T9	3/8	.3858	9.80	10	253	268	310	9572906	315	330	380	9573031
SXC_ _09920T9		.3906	9.92	10	253	268	310	9572908	315	330	380	9573033
SXC_ _10000T9	25/64	.3937	10.00	10	253	268	310	9572909	315	330	380	9573034
SXC_ _10200T9		.4016	10.20	12	310	325	375	9572912				
SXC_ _10320T9		.4063	10.32	12	310	325	350	9572913				
SXC_ _10720T9	13/32	.4219	10.72	12	309	325	375	9572916				
SXC_ _10800T9	27/64	.4252	10.80	12	309	325	375	9572917				
SXC_ _11000T9		.4331	11.00	12	309	325	375	9572918				
SXC_ _11113T9		.4375	11.11	12	308	325	375	9572920				
SXC_ _11500T9	7/16	.4528	11.50	12	308	325	375	9572922				
SXC_ _11510T9		.4531	11.51	12	308	325	375	9572923				
SXC_ _11910T9	29/64	.4687	11.90	12	307	325	375	9572924				
SXC_ _12000T9	15/32	.4724	12.00	12	307	325	375	9572925				

***Order Example**

SXC_ _03000T9 > 25xD >>> SXC2503000T9

SXC_ _03000T9 > 30xD >>> SXC3003000T9

** Diameters (2.0-2.9mm) and other dimensions are available upon request**

CARBIDE DRILLS



Design – Long spiral-fluted, right-hand cut, double-margin and internal coolant.

P M K S Refer to page 4

CARBIDE
40xD
to
50xD



Varianta®
Supral

Varianta® Supral Provides a low coefficient of friction, reducing tool wear and resulting in a longer tool life.

40xD & 50xD should utilize a 20xD intermediary drill along with pilot drill. (Refer to page 52 and 77)

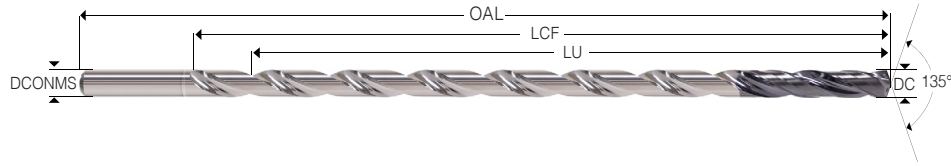

Item Description (Insert 40 or 50 in place of _) *Order Example	**DC Cutting Diameter			DCONMS	40xD Dimensions (mm)				50xD Dimensions (mm)			
	Fraction	Decimal	mm		LU Usable Length	LCF Length Chip Flute	OAL Overall Length	Item Number	LU Usable Length	LCF Length Chip Flute	OAL Overall Length	Item Number
SXC_03000T9		.1181	3.00	6	136	140	190	9573064	-	-	-	-
SXC_03175T9	1/8	.1250	3.18	6	135	140	190	9573066	-	-	-	-
SXC_03572T9	9/64	.1406	3.57	6	175	180	230	9573072	-	-	-	-
SXC_03800T9		.1496	3.80	6	174	180	230	9573075	-	-	-	-
SXC_03970T9	5/32	.1563	3.97	6	174	180	230	9573077	-	-	-	-
SXC_04000T9		.1575	4.00	6	174	180	230	9573078	219	225	270	9573171
SXC_04200T9		.1654	4.20	6	174	180	230	9573084	219	225	270	9573176
SXC_04370T9	11/64	.1719	4.37	6	213	220	270	9573086	268	275	320	9573178
SXC_04500T9		.1772	4.50	6	213	220	270	9573088	268	275	320	9573180
SXC_00130T9	#13	.1850	4.70	6	213	220	270	9573061	268	275	320	9573154
SXC_04760T9	3/16	.1875	4.76	6	213	220	270	9573092	268	275	320	9573184
SXC_00120T9	#12	.1890	4.80	6	213	220	270	9573060	268	275	320	9573153
SXC_05000T9		.1969	5.00	6	212	220	270	9573094	268	275	320	9573186
SXC_05160T9	13/64	.2031	5.16	6	232	240	290	9573097	302	310	360	9573188
SXC_00060T9	#6	.2040	5.18	6	232	240	290	9573059	302	310	360	9573152
SXC_05500T9		.2165	5.50	6	232	240	290	9573102	302	310	360	9573192
SXC_05560T9	7/32	.2187	5.55	6	232	240	290	9573104	302	310	360	9573194
SXC_05800T9		.2283	5.80	6	231	240	290	9573107	301	310	360	9573197
SXC_05950T9	15/64	.2344	5.95	6	231	240	290	9573109	301	310	360	9573199
SXC_06000T9		.2362	6.00	6	231	240	290	9573110	301	310	360	9573200
SXC_06350T9	1/4	.2500	6.35	8	280	290	340	9573116	330	340	385	9573201
SXC_06500T9		.2559	6.50	8	280	290	340	9573119	-	-	-	-
SXC_06750T9	17/64	.2656	6.75	8	310	320	370	9573122	-	-	-	-
SXC_06800T9		.2677	6.80	8	310	320	370	9573123	-	-	-	-
SXC_07000T9		.2756	7.00	8	309	320	370	9573126	-	-	-	-
SXC_07140T9	9/32	.2813	7.15	8	309	320	370	9573129	-	-	-	-
SXC_07500T9		.2953	7.50	8	309	320	370	9573133	-	-	-	-
SXC_07540T9	19/64	.2969	7.54	8	339	350	400	9573134	-	-	-	-
SXC_07800T9		.3071	7.80	8	338	350	400	9573136	-	-	-	-
SXC_07940T9	5/16	.3125	7.94	8	338	350	400	9573138	-	-	-	-
SXC_08000T9		.3150	8.00	8	338	350	400	9573139	-	-	-	-

***Order Example**

SXC_03000T9 > 40xD >>> SXC4003000T9

SXC_03000T9 > 50xD >>> SXC5003000T9

** Diameters (2.0-2.9mm) and other dimensions are available upon request**



SCAN FOR SPEEDS & FEEDS





**High Performance
Double Margin
Coolant Thru Drill
Ideal for Nickel Based Alloys
3xD-30xD**

Refer to page 4

CARBIDE	3xD to 30xD	135°	15°	
---------	-------------	------	-----	--

Sistral® Its nanostructure composition provides both high heat and oxidation resistance. Ideal for dry and high-speed cutting applications of materials.



SCAN FOR SPEEDS & FEEDS

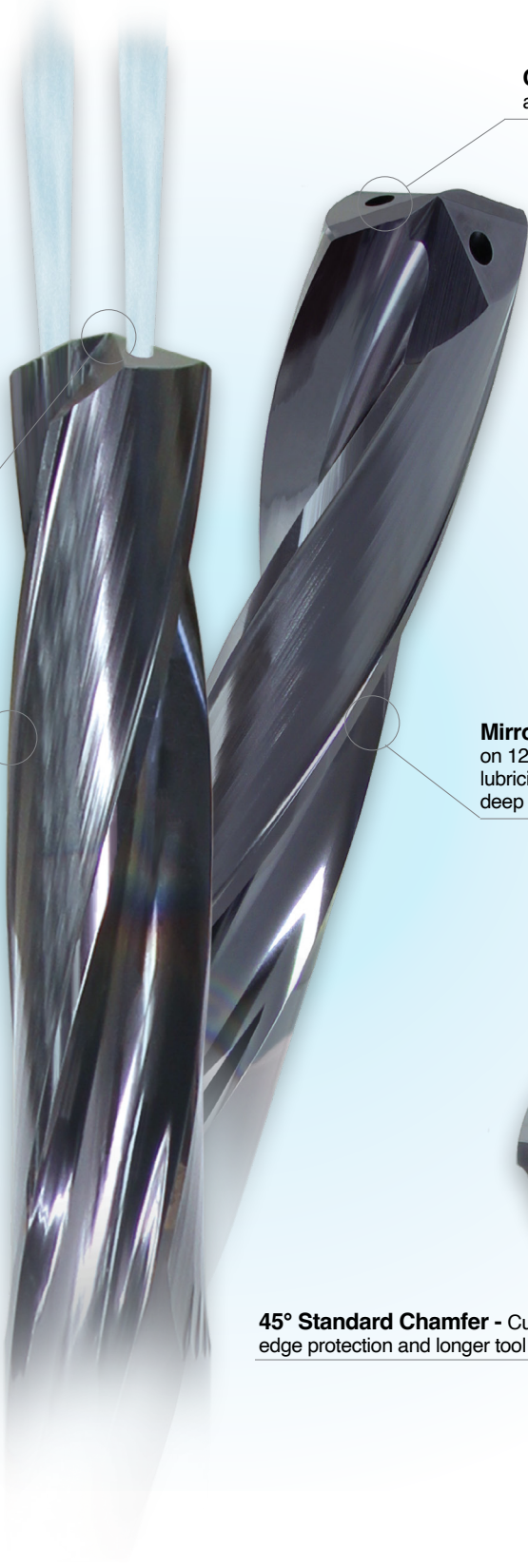

Coolant Holes - Cool the cutting edge and improve chip evacuation.

135° Point Geometry - Split-point geometry for superior drill penetration and accuracy.

Mirror Polished Flutes - on 12xD-30xD polish process adds lubricity for better chip evacuation on deep hole drilling.

Double Margin Design - For improved drilling stability and smooth surface finish.

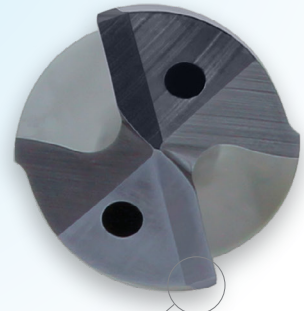

45° Standard Chamfer - Cutting edge protection and longer tool life.

Design – Long spiral fluted, 45° corner chamfer, right hand cut, double-margin and internal coolant.

Ideal for – Nickel-based alloys

S H Refer to page 4

No Pecking Required

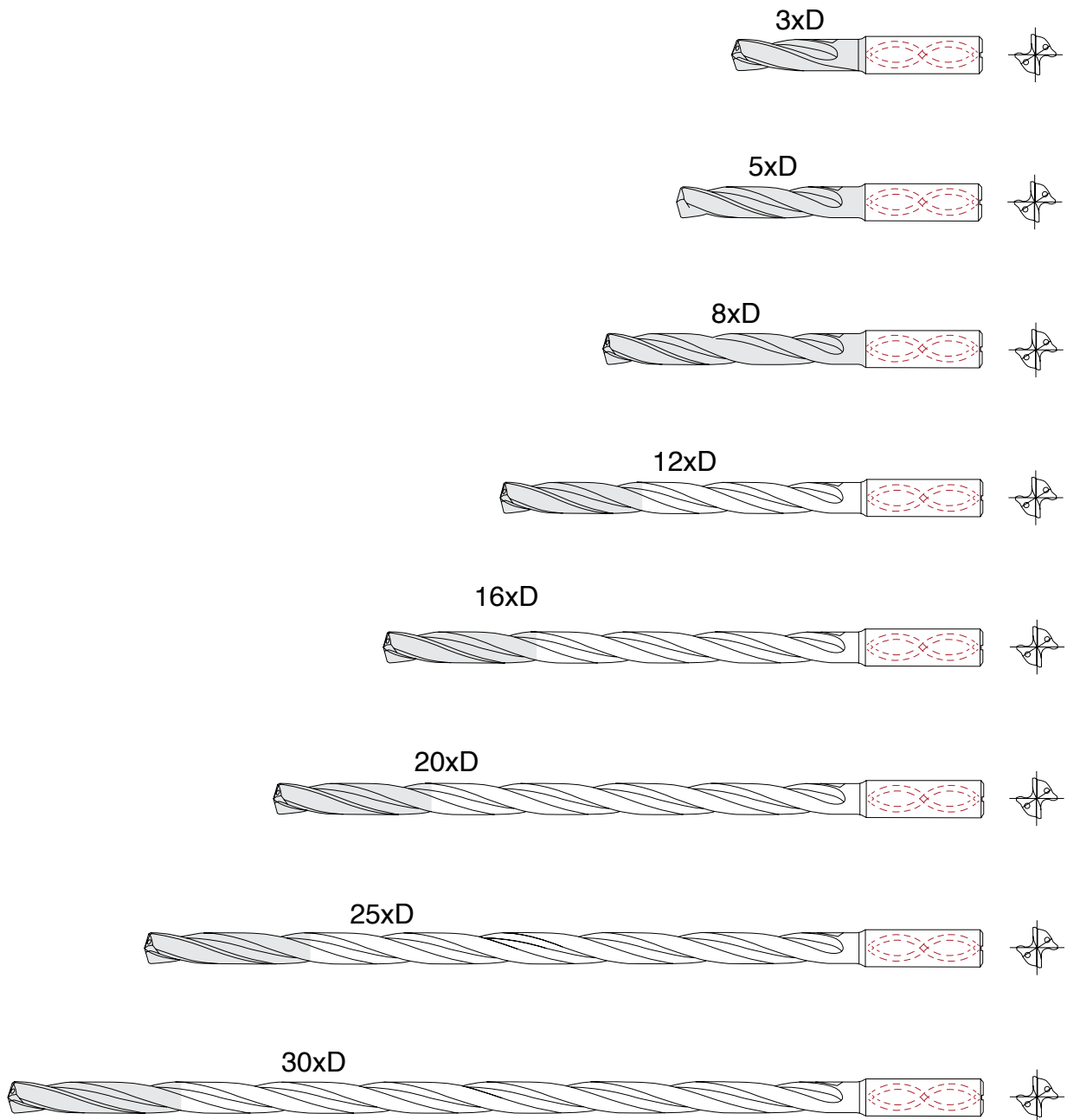
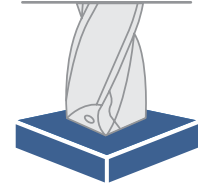

Must utilize a pilot hole drill when using 16xD - 30xD. Refer to page 77

CARBIDE DRILLS



Design – Long spiral-fluted, 45° corner chamfer, right hand cut, double margin and internal coolant.

Ideal for – Nickel based alloys

S H Refer to page 4



Sistral® Its nanostructure composition provides both high heat and oxidation resistance. Ideal for machining and drilling HRSA's.

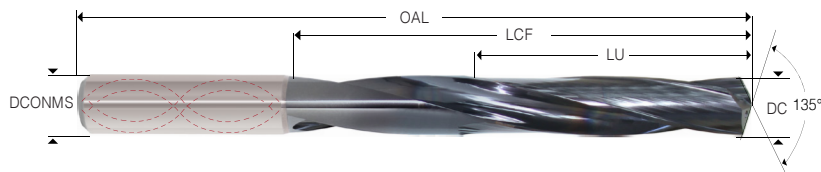

Item Description (Insert 03 or 05 in place of _)	**DC Cutting Diameter			DCONMS	3xD Dimensions (mm)				5xD Dimensions (mm)			
	Fraction	Decimal	mm		LU	LCF	OAL	Item Number	LU	LCF	OAL	Item Number
NXC__03000T7		.1181	3.00	6	16	20	62	9553209	24	28	66	9553345
NXC__03100T7		.1220	3.10	6	15	20	62	9553210	23	28	66	9553346
NXC__03175T7	1/8	.1250	3.18	6	15	20	62	9553211	23	28	66	9553347
NXC__03200T7		.1260	3.20	6	15	20	62	9553212	23	28	66	9553348
NXC__03300T7		.1299	3.30	6	15	20	62	9553213	23	28	66	9553349
NXC__03400T7		.1339	3.40	6	15	20	62	9553214	23	28	66	9553350
NXC__03500T7		.1378	3.50	6	15	20	62	9553215	23	28	66	9553351
NXC__03572T7	9/64	.1406	3.57	6	15	20	62	9553216	23	28	66	9553352
NXC__03600T7		.1417	3.60	6	15	20	62	9553217	23	28	66	9553353
NXC__03700T7		.1457	3.70	6	14	20	62	9553218	22	28	66	9553354
NXC__03800T7		.1496	3.80	6	18	24	66	9553219	30	36	74	9553355
NXC__03900T7		.1535	3.90	6	18	24	66	9553220	30	36	74	9553356
NXC__03970T7	5/32	.1563	3.97	6	18	24	66	9553221	30	36	74	9553357
NXC__04000T7		.1575	4.00	6	18	24	66	9553222	30	36	74	9553358
NXC__04100T7		.1614	4.10	6	18	24	66	9553223	30	36	74	9553359
NXC__04200T7		.1654	4.20	6	18	24	66	9553224	30	36	74	9553360
NXC__04300T7		.1693	4.30	6	18	24	66	9553225	30	36	74	9553361
NXC__04370T7	11/64	.1719	4.37	6	17	24	66	9553226	29	36	74	9553362
NXC__04400T7		.1732	4.40	6	17	24	66	9553227	29	36	74	9553363
NXC__04500T7		.1772	4.50	6	17	24	66	9553228	29	36	74	9553364
NXC__04600T7		.1811	4.60	6	17	24	66	9553229	29	36	74	9553365
NXC__04650T7		.1831	4.65	6	17	24	66	9553230	29	36	74	9553366
NXC__00130T7	#13	.1850	4.70	6	17	24	66	9553208	29	36	74	9553344
NXC__04760T7	3/16	.1875	4.76	6	21	28	66	9553231	37	44	82	9553367
NXC__00120T7	#12	.1890	4.80	6	21	28	66	9553207	37	44	82	9553343
NXC__04900T7		.1929	4.90	6	21	28	66	9553232	37	44	82	9553368
NXC__05000T7		.1969	5.00	6	20	28	66	9553233	36	44	82	9553369
NXC__05100T7		.2008	5.10	6	20	28	66	9553234	36	44	82	9553370
NXC__05160T7	13/64	.2031	5.16	6	20	28	66	9553236	36	44	82	9553371
NXC__00060T7	#6	.2040	5.18	6	20	28	66	9553206	36	44	82	9553341
NXC__05200T7		.2047	5.20	6	20	28	66	9553237	36	44	82	9553372
NXC__05300T7		.2087	5.30	6	20	28	66	9553238	36	44	82	9553373
NXC__05400T7		.2126	5.40	6	20	28	66	9553239	36	44	82	9553374
NXC__05500T7		.2165	5.50	6	20	28	66	9553240	36	44	82	9553375
NXC__05550T7		.2185	5.55	6	20	28	66	9553241	36	44	82	9553376
NXC__05560T7	7/32	.2187	5.55	6	20	28	66	9553242	36	44	82	9553377
NXC__05600T7		.2205	5.60	6	20	28	66	9553243	36	44	82	9553378
NXC__05700T7		.2244	5.70	6	19	28	66	9553244	35	44	82	9553379
NXC__05800T7		.2283	5.80	6	19	28	66	9553245	35	44	82	9553380
NXC__05900T7		.2323	5.90	6	19	28	66	9553246	35	44	82	9553381
NXC__05950T7	15/64	.2344	5.95	6	19	28	66	9553247	35	44	82	9553382
NXC__06000T7		.2362	6.00	6	19	28	66	9553248	35	44	82	9553383
NXC__06100T7		.2402	6.10	8	25	34	79	9553249	44	53	91	9553384

***Order Example**

DXC__06900T9 > 03xD >>> DXC0306900T9

DXC__06900T9 > 05xD >>> DXC0506900T9

** Diameters (2.0-2.9mm) and other dimensions are available upon request**

CARBIDE DRILLS



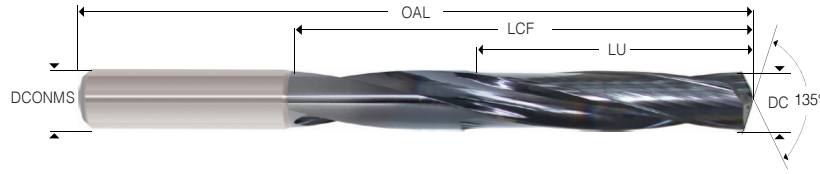

Item Description (Insert 03 or 05 in place of _ _) *Order Example	**DC Cutting Diameter		DCONMS	3xD Dimensions (mm)				5xD Dimensions (mm)				
	Fraction	Decimal		mm	LU Usable Length	LCF Length Chip Flute	OAL Overall Length	Item Number	LU Usable Length	LCF Length Chip Flute	OAL Overall Length	Item Number
NXC_06200T7		.2441	6.20	8	25	34	79	9553250	44	53	91	9553385
NXC_06300T7		.2480	6.30	8	25	34	79	9553251	44	53	91	9553386
NXC_06350T7	1/4	.2500	6.35	8	24	34	79	9553252	43	53	91	9553387
NXC_06400T7		.2520	6.40	8	24	34	79	9553253	43	53	91	9553388
NXC_06500T7		.2559	6.50	8	24	34	79	9553254	43	53	91	9553389
NXC_06600T7		.2598	6.60	8	24	34	79	9553255	43	53	91	9553390
NXC_06700T7		.2638	6.70	8	24	34	79	9553256	43	53	91	9553391
NXC_06750T7	17/64	.2656	6.75	8	24	34	79	9553257	43	53	91	9553392
NXC_06800T7		.2677	6.80	8	24	34	79	9553258	43	53	91	9553393
NXC_06900T7		.2717	6.90	8	31	41	79	9553259	43	53	91	9553394
NXC_07000T7		.2756	7.00	8	31	41	79	9553260	42	53	91	9553395
NXC_07100T7		.2795	7.10	8	30	41	79	9553261	42	53	91	9553396
NXC_07140T7	9/32	.2813	7.15	8	30	41	79	9553262	42	53	91	9553397
NXC_07200T7		.2835	7.20	8	30	41	79	9553263	42	53	91	9553398
NXC_07300T7		.2874	7.30	8	30	41	79	9553264	42	53	91	9553399
NXC_07400T7		.2913	7.40	8	30	41	79	9553265	42	53	91	9553400
NXC_07500T7		.2953	7.50	8	30	41	79	9553266	42	53	91	9553401
NXC_07540T7	19/64	.2969	7.54	8	30	41	79	9553267	42	53	91	9553402
NXC_07700T7		.3031	7.70	8	29	41	79	9553268	41	53	91	9553403
NXC_07800T7		.3071	7.80	8	29	41	79	9553269	41	53	91	9553404
NXC_07900T7		.3110	7.90	8	29	41	79	9553270	41	53	91	9553405
NXC_07940T7	5/16	.3125	7.94	8	29	41	79	9553271	41	53	91	9553406
NXC_08000T7		.3150	8.00	8	29	41	79	9553272	41	53	91	9553407
NXC_08100T7		.3189	8.10	10	35	47	89	9553273	49	61	103	9553408
NXC_08200T7		.3228	8.20	10	35	47	89	9553274	49	61	103	9553409
NXC_08300T7		.3268	8.30	10	35	47	89	9553275	49	61	103	9553410
NXC_08330T7	21/64	.3281	8.33	10	35	47	89	9553276	49	61	103	9553411
NXC_08400T7		.3307	8.40	10	34	47	89	9553277	48	61	103	9553412
NXC_08500T7		.3346	8.50	10	34	47	89	9553279	48	61	103	9553413
NXC_08600T7		.3386	8.60	10	34	47	89	9553280	48	61	103	9553414
NXC_08700T7		.3425	8.70	10	34	47	89	9553281	48	61	103	9553415
NXC_08730T7	11/32	.3437	8.73	10	34	47	89	9553282	48	61	103	9553416
NXC_08800T7		.3465	8.80	10	34	47	89	9553283	48	61	103	9553417
NXC_09000T7		.3543	9.00	10	34	47	89	9553284	48	61	103	9553418
NXC_09130T7	23/64	.3594	9.13	10	33	47	89	9553285	47	61	103	9553419
NXC_09200T7		.3622	9.20	10	33	47	89	9553286	47	61	103	9553420
NXC_09300T7		.3661	9.30	10	33	47	89	9553287	47	61	103	9553421
NXC_09500T7		.3740	9.50	10	33	47	89	9553288	47	61	103	9553422
NXC_09520T7	3/8	.3750	9.53	10	33	47	89	9553289	47	61	103	9553423
NXC_09600T7		.3780	9.60	10	33	47	89	9553290	47	61	103	9553424
NXC_09800T7		.3858	9.80	10	32	47	89	9553291	46	61	103	9553425
NXC_09900T7		.3898	9.90	10	32	47	89	9553292	46	61	103	9553426
NXC_09920T7	25/64	.3906	9.92	10	32	47	89	9553293	46	61	103	9553427
NXC_10000T7		.3937	10.00	10	32	47	89	9553294	46	61	103	9553428
NXC_10100T7		.3976	10.10	12	40	55	102	9553295	56	71	118	9553429
NXC_10200T7		.4016	10.20	12	40	55	102	9553296	56	71	118	9553430
NXC_10300T7		.4055	10.30	12	40	55	102	9553297	56	71	118	9553431
NXC_10320T7	13/32	.4063	10.32	12	40	55	102	9553298	56	71	118	9553432
NXC_10400T7		.4094	10.40	12	39	55	102	9553299	55	71	118	9553433
NXC_10500T7		.4134	10.50	12	39	55	102	9553300	55	71	118	9553434
NXC_10720T7	27/64	.4219	10.72	12	39	55	102	9553301	55	71	118	9553435
NXC_10800T7		.4252	10.80	12	39	55	102	9553302	55	71	118	9553436
NXC_11000T7		.4331	11.00	12	38	55	102	9553303	55	71	118	9553437
NXC_11100T7		.4370	11.10	12	38	55	102	9553304	54	71	118	9553438

***Order Example**

NXC_06200T7 > 03xD >>> NXC0306200T7

NXC_06200T7 > 05xD >>> NXC0506200T7

** Diameters (2.0-2.9mm) and other dimensions are available upon request**

CARBIDE DRILLS

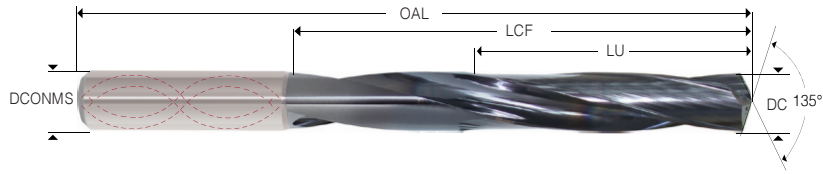

Item Description (Insert 03 or 05 in place of _) *Order Example	**DC Cutting Diameter			DCONMS	3xD Dimensions (mm)				5xD Dimensions (mm)			
	Fraction	Decimal	mm		LU Usable Length	OAL Overall Length	Item Number	LU Usable Length	LCF Length Chip Flute	OAL Overall Length	Item Number	
NXC__11113T7	0.43	.4375	11.11	12	38	55	102	9553305	54	71	118	9553439
NXC__11200T7		.4409	11.20	12	38	55	102	9553306	54	71	118	9553440
NXC__11500T7		.4528	11.50	12	38	55	102	9553307	54	71	118	9553441
NXC__11510T7	29/64	.4531	11.51	12	38	55	102	9553308	54	71	118	9553442
NXC__11700T7		.4606	11.70	12	37	55	102	9553310	53	71	118	9553443
NXC__11800T7		.4646	11.80	12	37	55	102	9553311	53	71	118	9553444
NXC__11910T7	15/32	.4687	11.90	12	37	55	102	9553312	53	71	118	9553445
NXC__12000T7		.4724	12.00	12	37	55	102	9553313	53	71	118	9553447
NXC__12100T7		.4764	12.10	14	42	60	107	9553314	59	77	124	9553448
NXC__12200T7		.4803	12.20	14	42	60	107	9553315	59	77	124	9553449
NXC__12300T7		.4843	12.30	14	42	60	107	9553316	59	77	124	9553450
NXC__12303T7	0.48	.4844	12.30	14	42	60	107	9553317	59	77	124	9553451
NXC__12500T7		.4921	12.50	14	41	60	107	9553318	58	77	124	9553452
NXC__12600T7		.4961	12.60	14	41	60	107	9553319	58	77	124	9553453
NXC__12700T7	1/2	.5000	12.70	14	41	60	107	9553320	58	77	124	9553454
NXC__13000T7		.5118	13.00	14	41	60	107	9553321	58	77	124	9553455
NXC__13300T7		.5236	13.30	14	40	60	107	9553322	57	77	124	9553457
NXC__13490T7	17/32	.5313	13.50	14	40	60	107	9553323	57	77	124	9553458
NXC__13500T7		.5315	13.50	14	40	60	107	9553324	57	77	124	9553459
NXC__14000T7		.5512	14.00	14	39	60	107	9553325	56	77	124	9553460
NXC__14290T7	9/16	.5625	14.29	16	44	65	115	9553326	62	83	133	9553461
NXC__14500T7		.5709	14.50	16	43	65	115	9553327	61	83	133	9553462
NXC__15000T7		.5906	15.00	16	42	65	115	9553328	60	83	133	9553463
NXC__15500T7		.6102	15.50	16	42	65	115	9553329	60	83	133	9553464
NXC__15870T7	5/8	.6250	15.88	16	41	65	115	9553330	59	83	133	9553465
NXC__16000T7		.6299	16.00	16	41	65	115	9553331	59	83	133	9553466
NXC__16500T7		.6496	16.50	18	48	73	123	9553332	68	93	143	9553467
NXC__17000T7		.6693	17.00	18	48	73	123	9553333	68	93	143	9553468
NXC__17500T7		.6890	17.50	18	47	73	123	9553334	67	93	143	9553469
NXC__18000T7		.7087	18.00	18	46	73	123	9553335	66	93	143	9553470
NXC__18500T7		.7283	18.50	20	51	79	131	9553336	73	101	153	9553471
NXC__19050T7	3/4	.7500	19.05	20	50	79	131	9553337	72	101	153	9553472
NXC__19500T7		.7677	19.50	20	50	79	131	9553338	72	101	153	9553473
NXC__20000T7		.7874	20.00	20	49	79	131	9553339	71	101	153	9553474

*Order Example

NXC__11113T7 > 03xD >>> NXC0311113T7

NXC__11113T7 > 05xD >>> NXC0511113T7

** Diameters (2.0-2.9mm) and other dimensions are available upon request**



SCAN FOR SPEEDS & FEEDS

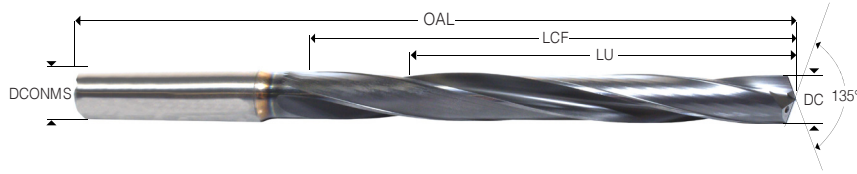

CARBIDE DRILLS

Item Description (Insert 08 or 12 in place of _) *Order Example	**DC Cutting Diameter			DCONMS	8xD Dimensions (mm)				12xD Dimensions (mm)			
	Fraction	Decimal	mm		LU Usable Length	LCF Length Chip Flute	OAL Overall Length	Item Number	LU Usable Length	LCF Length Chip Flute	OAL Overall Length	Item Number
NXC_03000T7		.1181	3.00	6	30	29.50	72	9553478	49	54	92	9553609
NXC_03100T7		.1220	3.10	6	29	29.35	72	9553479	49	54	92	9553610
NXC_03175T7	1/8	.1250	3.18	6	29	29.24	72	9553480	49	54	92	9553611
NXC_03200T7		.1260	3.20	6	29	29.20	72	9553481	49	54	92	9553612
NXC_03300T7		.1299	3.30	6	29	29.05	72	9553482	49	54	92	9553613
NXC_03400T7		.1339	3.40	6	29	28.90	72	9553483	49	54	92	9553614
NXC_03500T7		.1378	3.50	6	29	28.75	72	9553484	49	54	92	9553615
NXC_03572T7	9/64	.1406	3.57	6	29	28.64	72	9553485	49	54	92	9553616
NXC_03600T7		.1417	3.60	6	29	28.60	72	9553486	49	54	92	9553617
NXC_03700T7		.1457	3.70	6	28	28.45	72	9553487	48	54	92	9553618
NXC_03800T7		.1496	3.80	6	37	37.30	81	9553488	58	64	102	9553619
NXC_03900T7		.1535	3.90	6	37	37.15	81	9553489	58	64	102	9553620
NXC_03970T7	5/32	.1563	3.97	6	37	37.05	81	9553490	58	64	102	9553621
NXC_04000T7		.1575	4.00	6	37	37.00	81	9553491	58	64	102	9553622
NXC_04100T7		.1614	4.10	6	37	36.85	81	9553492	58	64	102	9553623
NXC_04200T7		.1654	4.20	6	37	36.70	81	9553493	58	64	102	9553624
NXC_04300T7		.1693	4.30	6	37	36.55	81	9553494	58	64	102	9553625
NXC_04370T7	11/64	.1719	4.37	6	36	36.45	81	9553495	57	64	102	9553626
NXC_04400T7		.1732	4.40	6	36	36.40	81	9553496	57	64	102	9553627
NXC_04500T7		.1772	4.50	6	36	36.25	81	9553497	57	64	102	9553628
NXC_04600T7		.1811	4.60	6	36	36.10	81	9553498	57	64	102	9553629
NXC_04650T7		.1831	4.65	6	36	36.02	81	9553499	57	64	102	9553630
NXC_00130T7	#13	.1850	4.70	6	36	35.95	81	9553477	57	64	102	9553608
NXC_04760T7	3/16	.1875	4.76	6	50	49.86	95	9553500	71	78	116	9553631
NXC_00120T7	#12	.1890	4.80	6	50	49.80	95	9553476	71	78	116	9553607
NXC_04900T7		.1929	4.90	6	50	49.65	95	9553501	71	78	116	9553632
NXC_05000T7		.1969	5.00	6	49	49.50	95	9553502	70	78	116	9553633
NXC_05100T7		.2008	5.10	6	49	49.35	95	9553503	70	78	116	9553634
NXC_05160T7	13/64	.2031	5.16	6	49	49.26	95	9553504	70	78	116	9553635
NXC_00060T7	#6	.2040	5.18	6	49	49.23	95	9553475	70	78	116	9553606
NXC_05200T7		.2047	5.20	6	49	49.20	95	9553505	70	78	116	9553636
NXC_05300T7		.2087	5.30	6	49	49.05	95	9553506	70	78	116	9553637
NXC_05400T7		.2126	5.40	6	49	48.90	95	9553507	70	78	116	9553638
NXC_05500T7		.2165	5.50	6	49	48.75	95	9553508	70	78	116	9553639
NXC_05550T7		.2185	5.55	6	49	48.67	95	9553509	70	78	116	9553640
NXC_05560T7	7/32	.2187	5.55	6	49	48.67	95	9553510	70	78	116	9553641
NXC_05600T7		.2205	5.60	6	49	48.60	95	9553511	70	78	116	9553642
NXC_05700T7		.2244	5.70	6	48	48.45	95	9553512	69	78	116	9553643
NXC_05800T7		.2283	5.80	6	48	48.30	95	9553513	69	78	116	9553644
NXC_05900T7		.2323	5.90	6	48	48.15	95	9553514	69	78	116	9553645
NXC_05950T7	15/64	.2344	5.95	6	48	48.07	95	9553515	69	78	116	9553646
NXC_06000T7		.2362	6.00	6	48	48.00	95	9553516	69	78	116	9553647
NXC_06100T7		.2402	6.10	8	67	66.85	114	9553517	99	108	146	9553648
NXC_06200T7		.2441	6.20	8	67	66.70	114	9553518	99	108	146	9553649
NXC_06300T7		.2480	6.30	8	67	66.55	114	9553519	99	108	146	9553650
NXC_06350T7	1/4	.2500	6.35	8	66	66.47	114	9553520	98	108	146	9553651
NXC_06400T7		.2520	6.40	8	66	66.40	114	9553521	98	108	146	9553652
NXC_06500T7		.2559	6.50	8	66	66.25	114	9553522	98	108	146	9553653
NXC_06600T7		.2598	6.60	8	66	66.10	114	9553523	98	108	146	9553654
NXC_06700T7		.2638	6.70	8	66	65.95	114	9553524	98	108	146	9553655
NXC_06750T7	17/64	.2656	6.75	8	66	65.88	114	9553525	98	108	146	9553656
NXC_06800T7		.2677	6.80	8	66	65.80	114	9553526	98	108	146	9553657
NXC_06900T7		.2717	6.90	8	66	65.65	114	9553527	98	108	146	9553658
NXC_07000T7		.2756	7.00	8	65	65.50	114	9553528	98	108	146	9553659
NXC_07100T7		.2795	7.10	8	65	65.35	114	9553529	97	108	146	9553660
NXC_07140T7	9/32	.2813	7.15	8	65	65.28	114	9553530	97	108	146	9553661
NXC_07200T7		.2835	7.20	8	65	65.20	114	9553531	97	108	146	9553662
NXC_07300T7		.2874	7.30	8	65	65.05	114	9553532	97	108	146	9553663
NXC_07400T7		.2913	7.40	8	65	64.90	114	9553533	97	108	146	9553664
NXC_07500T7		.2953	7.50	8	65	64.75	114	9553534	97	108	146	9553665
NXC_07540T7	19/64	.2969	7.54	8	65	64.69	114	9553535	97	108	146	9553666
NXC_07700T7		.3031	7.70	8	64	64.45	114	9553536	96	108	146	9553667
NXC_07800T7		.3071	7.80	8	64	64.30	114	9553537	96	108	146	9553668
NXC_07900T7		.3110	7.90	8	64	64.15	114	9553538	96	108	146	9553669
NXC_07940T7	5/16	.3125	7.94	8	64	64.09	114	9553539	96	108	146	9553670
NXC_08000T7		.3150	8.00	8	64	64.00	114	9553540	96	108	146	9553671
NXC_08100T7		.3189	8.10	10	83	82.85	142	9553541	108	120	162	9553672

*Order Example

NXC_03000T7 > 08xD >>> NXC0803000T7

NXC_03000T7 > 12xD >>> NXC1203000T7

** Diameters (2.0-2.9mm) and other dimensions are available upon request**

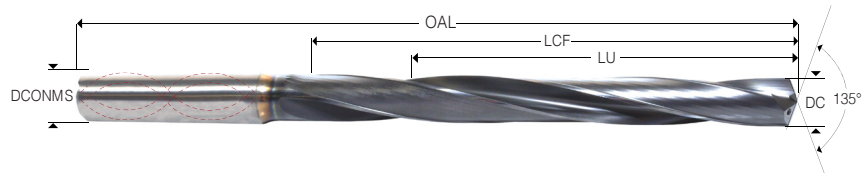

Item Description (Insert 08 or 12 in place of _) *Order Example	**DC Cutting Diameter			DCONMS	8xD Dimensions (mm)				12xD Dimensions (mm)			
	Fraction	Decimal	mm		LU Usable Length	LCF Length Chip Flute	OAL Overall Length	Item Number	LU Usable Length	LCF Length Chip Flute	OAL Overall Length	Item Number
NXC__08200T7		.3228	8.20	10	83	82.70	142	9553542	108	120	162	9553673
NXC__08300T7		.3268	8.30	10	83	82.55	142	9553543	108	120	162	9553674
NXC__08330T7	21/64	.3281	8.33	10	82	82.50	142	9553544	108	120	162	9553675
NXC__08400T7		.3307	8.40	10	82	82.40	142	9553545	107	120	162	9553676
NXC__08500T7		.3346	8.50	10	82	82.25	142	9553546	107	120	162	9553677
NXC__08600T7		.3386	8.60	10	82	82.10	142	9553547	107	120	162	9553678
NXC__08700T7		.3425	8.70	10	82	81.95	142	9553548	107	120	162	9553679
NXC__08730T7	11/32	.3437	8.73	10	82	81.90	142	9553549	107	120	162	9553680
NXC__08800T7		.3465	8.80	10	82	81.80	142	9553550	107	120	162	9553681
NXC__09000T7		.3543	9.00	10	82	81.50	142	9553551	107	120	162	9553682
NXC__09130T7	23/64	.3594	9.13	10	81	81.31	142	9553552	106	120	162	9553683
NXC__09200T7		.3622	9.20	10	81	81.20	142	9553553	106	120	162	9553684
NXC__09300T7		.3661	9.30	10	81	81.05	142	9553554	106	120	162	9553685
NXC__09500T7		.3740	9.50	10	81	80.75	142	9553555	106	120	162	9553686
NXC__09520T7	3/8	.3750	9.53	10	81	80.71	142	9553556	106	120	162	9553687
NXC__09600T7		.3780	9.60	10	81	80.60	142	9553557	106	120	162	9553688
NXC__09800T7		.3858	9.80	10	80	80.30	142	9553558	105	120	162	9553689
NXC__09900T7		.3898	9.90	10	80	80.15	142	9553559	105	120	162	9553690
NXC__09920T7	25/64	.3906	9.92	10	80	80.12	142	9553560	105	120	162	9553691
NXC__10000T7		.3937	10.00	10	80	80.00	142	9553561	105	120	162	9553692
NXC__10100T7		.3976	10.10	12	99	98.85	162	9553562	141	156	204	9553693
NXC__10200T7		.4016	10.20	12	99	98.70	162	9553563	141	156	204	9553694
NXC__10300T7		.4055	10.30	12	99	98.55	162	9553564	141	156	204	9553695
NXC__10320T7	13/32	.4063	10.32	12	99	98.52	162	9553565	141	156	204	9553696
NXC__10400T7		.4094	10.40	12	98	98.40	162	9553566	140	156	204	9553697
NXC__10500T7		.4134	10.50	12	98	98.25	162	9553567	140	156	204	9553698
NXC__10720T7	27/64	.4219	10.72	12	98	97.93	162	9553568	140	156	204	9553699
NXC__10800T7		.4252	10.80	12	98	97.80	162	9553569	140	156	204	9553700
NXC__11000T7		.4331	11.00	12	98	97.50	162	9553570	139	156	204	9553701
NXC__11100T7		.4370	11.10	12	97	97.35	162	9553571	139	156	204	9553702
NXC__11113T7	7/16	.4375	11.11	12	97	97.33	162	9553572	139	156	204	9553703
NXC__11200T7		.4409	11.20	12	97	97.20	162	9553573	139	156	204	9553704
NXC__11500T7		.4528	11.50	12	97	96.75	162	9553574	139	156	204	9553705
NXC__11510T7	29/64	.4531	11.51	12	97	96.74	162	9553575	139	156	204	9553706
NXC__11700T7		.4606	11.70	12	96	96.45	162	9553576	138	156	204	9553707
NXC__11800T7		.4646	11.80	12	96	96.30	162	9553577	138	156	204	9553708
NXC__11910T7	15/32	.4687	11.90	12	96	96.14	162	9553578	138	156	204	9553709
NXC__12000T7		.4724	12.00	12	96	96.00	162	9553579	138	156	204	9553710
NXC__12100T7		.4764	12.10	14	113	112.85	178	9553580	164	182	230	9553711
NXC__12200T7		.4803	12.20	14	113	112.70	178	9553581	164	182	230	9553712
NXC__12300T7	12.3	.4843	12.30	14	113	112.55	178	9553582	164	182	230	9553713
NXC__12303T7	31/64	.4844	12.30	14	113	112.54	178	9553583	164	182	230	9553714
NXC__12500T7		.4921	12.50	14	112	112.25	178	9553584	163	182	230	9553715
NXC__12600T7		.4961	12.60	14	112	112.10	178	9553585	163	182	230	9553716
NXC__12700T7	1/2	.5000	12.70	14	112	111.95	178	9553586	163	182	230	9553717
NXC__13000T7		.5118	13.00	14	112	111.50	178	9553587	163	182	230	9553718
NXC__13300T7		.5236	13.30	14	111	111.05	178	9553588	162	182	230	9553719
NXC__13490T7	17/32	.5313	13.50	14	111	110.76	178	9553589	162	182	230	9553720
NXC__13500T7		.5315	13.50	14	111	110.75	178	9553590	162	182	230	9553721
NXC__14000T7		.5512	14.00	14	110	110.00	178	9553591	161	182	230	9553722
NXC__14290T7	9/16	.5625	14.29	16	131	130.57	203	9553592	187	208	260	9553723
NXC__14500T7		.5709	14.50	16	130	130.25	203	9553593	186	208	260	9553724
NXC__15000T7		.5906	15.00	16	129	129.50	203	9553594	185	208	260	9553725
NXC__15500T7		.6102	15.50	16	129	128.75	203	9553595	185	208	260	9553726
NXC__15870T7	5/8	.6250	15.88	16	128	128.19	203	9553596	184	208	260	9553727
NXC__16000T7		.6299	16.00	16	128	128.00	203	9553597	184	208	260	9553728
NXC__16500T7		.6496	16.50	18	146	146.25	222	9553598	209	234	285	9553730
NXC__17000T7		.6693	17.00	18	146	145.50	222	9553599	209	234	285	9553731
NXC__17500T7		.6890	17.50	18	145	144.75	222	9553600	208	234	285	9553732
NXC__18000T7		.7087	18.00	18	144	144.00	222	9553601	207	234	285	9553733
NXC__18500T7		.7283	18.50	20	162	162.25	243	9553602	230	258	310	9553734
NXC__19050T7	3/4	.7500	19.05	20	161	161.42	243	9553603	229	258	310	9553735
NXC__19500T7		.7677	19.50	20	161	160.75	243	9553604	229	258	310	9553736
NXC__20000T7		.7874	20.00	20	160	160.00	243	9553605	228	258	310	9553739

***Order Example**

NXC__08200T7 > 08xD >>> NXC0808200T7

NXC__08200T7 > 12xD >>> NXC1208200T7

** Diameters (2.0-2.9mm) and other dimensions are available upon request**

CARBIDE DRILLS



Design – Long spiral-fluted, 45° corner chamfer, right hand cut, double margin and internal coolant.

Ideal for – Nickel based alloys

■ This drill must utilize a pilot hole drill. (Refer to page 77)

S H Refer to page 4



Sistral® Its nanostructure composition provides both high heat and oxidation resistance. Ideal for machining and drilling HRSAs.

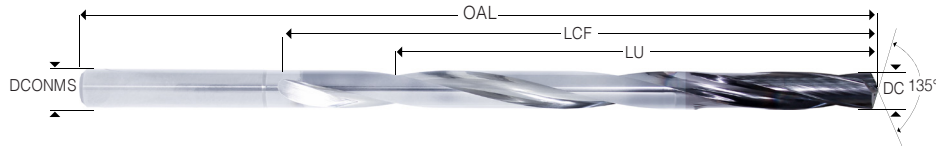

Item Description (Insert 16 or 20 in place of _) *Order Example	**DC Cutting Diameter			DCONMS	16xD Dimensions (mm)				20xD Dimensions (mm)			
	Fraction	Decimal	mm		LU Usable Length	LCF Length Chip Flute	OAL Overall Length	Item Number	LU Usable Length	LCF Length Chip Flute	OAL Overall Length	Item Number
NXC_03000T7		.1181	3.00	6	56	60	100	9553743	76	80	120	9553820
NXC_03175T7	1/8	.1250	3.18	6	55	60	100	9553744	75	80	120	9553821
NXC_03200T7		.1260	3.20	6	55	60	100	9553745	75	80	120	9553822
NXC_03300T7		.1299	3.30	6	55	60	100	9553746	75	80	120	9553823
NXC_03500T7		.1378	3.50	6	55	60	100	9553747	75	80	120	9553824
NXC_03572T7	9/64	.1406	3.57	6	70	75	115	9553748	85	90	130	9553825
NXC_03800T7		.1496	3.80	6	69	75	115	9553749	84	90	130	9553826
NXC_03970T7	5/32	.1563	3.97	6	69	75	115	9553750	84	90	130	9553827
NXC_04000T7		.1575	4.00	6	69	75	115	9553751	84	90	130	9553828
NXC_04200T7		.1654	4.20	6	69	75	115	9553752	104	110	160	9553829
NXC_04370T7	11/64	.1719	4.37	6	83	90	130	9553753	103	110	160	9553830
NXC_04500T7		.1772	4.50	6	83	90	130	9553754	103	110	160	9553831
NXC_00130T7	#13	.1850	4.70	6	83	90	130	9553742	113	120	160	9553819
NXC_04760T7	3/16	.1875	4.76	6	83	90	130	9553755	113	120	160	9553832
NXC_00120T7	#12	.1890	4.80	6	83	90	130	9553741	113	120	160	9553818
NXC_05000T7		.1969	5.00	6	82	90	130	9553756	112	120	160	9553833
NXC_05160T7	13/64	.2031	5.16	6	100	108	150	9553757	132	140	185	9553834
NXC_00060T7	#6	.2040	5.18	6	100	108	150	9584743	132	140	185	9584744
NXC_05500T7		.2165	5.50	6	100	108	150	9553758	132	140	185	9553835
NXC_05560T7	7/32	.2187	5.55	6	100	108	150	9553759	132	140	185	9553836
NXC_05800T7		.2283	5.80	6	99	108	150	9553760	131	140	185	9553837
NXC_05950T7	15/64	.2344	5.95	6	99	108	150	9553761	131	140	185	9553838
NXC_06000T7		.2362	6.00	6	99	108	150	9553762	131	140	185	9553839
NXC_06350T7	1/4	.2500	6.35	8	115	125	165	9553763	150	160	210	9553840
NXC_06500T7		.2559	6.50	8	115	125	165	9553764	150	160	210	9553841
NXC_06750T7	17/64	.2656	6.75	8	115	125	165	9553765	150	160	210	9553842
NXC_06800T7		.2677	6.80	8	115	125	165	9553766	150	160	210	9553843
NXC_07000T7		.2756	7.00	8	115	125	165	9553768	149	160	210	9553844
NXC_07140T7	9/32	.2813	7.15	8	129	140	180	9553769	169	180	230	9553845
NXC_07500T7		.2953	7.50	8	129	140	180	9553770	169	180	230	9553846
NXC_07540T7	19/64	.2969	7.54	8	129	140	180	9553771	169	180	230	9553847
NXC_07800T7		.3071	7.80	8	128	140	180	9553772	168	180	230	9553848
NXC_07940T7	5/16	.3125	7.94	8	128	140	180	9553773	168	180	230	9553849
NXC_08000T7		.3150	8.00	8	128	140	180	9553774	168	180	230	9553850
NXC_08330T7	21/64	.3281	8.33	10	148	160	205	9553775	183	195	260	9553851
NXC_08500T7		.3346	8.50	10	147	160	205	9553776	182	195	260	9553852
NXC_08730T7	11/32	.3437	8.73	10	147	160	205	9553777	217	230	290	9553854
NXC_08800T7		.3465	8.80	10	147	160	205	9553778	217	230	290	9553855
NXC_09000T7		.3543	9.00	10	147	160	205	9553779	217	230	290	9553856
NXC_09130T7	23/64	.3594	9.13	10	166	180	225	9553780	216	230	290	9553857
NXC_09520T7	3/8	.3750	9.53	10	166	180	225	9553781	216	230	290	9553858
NXC_09800T7		.3858	9.80	10	165	180	225	9553782	215	230	290	9553859

***Order Example**

NXC_08200T7 > 16xD >>> NXC1608200T7

NXC_08200T7 > 20xD >>> NXC2008200T7

** Diameters (2.0-2.9mm) and other dimensions are available upon request**

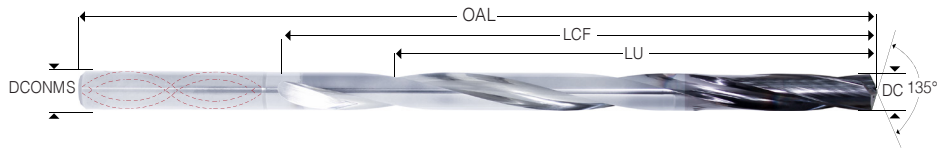

Item Description (Insert 16 or 20 in place of _)	**DC Cutting Diameter			DCONMS	16xD Dimensions (mm)				20xD Dimensions (mm)			
	Fraction	Decimal	mm		LU Usable Length	LCF Length Chip Flute	OAL Overall Length	Item Number	LU Usable Length	LCF Length Chip Flute	OAL Overall Length	Item Number
NXC__09920T7	25/64	.3906	9.92	10	165	180	225	9553783	215	230	290	9553860
NXC__10000T7		.3937	10.00	10	165	180	225	9553784	215	230	290	9553861
NXC__10200T7		.4016	10.20	12	175	190	240	9553785	253	268	315	9553862
NXC__10320T7	13/32	.4063	10.32	12	175	190	240	9553786	253	268	315	9553863
NXC__10720T7	27/64	.4219	10.72	12	174	190	240	9553787	252	268	315	9553864
NXC__10800T7		.4252	10.80	12	174	190	240	9553788	252	268	315	9553865
NXC__11000T7		.4331	11.00	12	173	190	240	9553789	252	268	315	9553866
NXC__11113T7	7/16	.4375	11.11	12	198	215	265	9553790	251	268	315	9553867
NXC__11500T7		.4528	11.50	12	198	215	265	9553791	251	268	315	9553868
NXC__11510T7	29/64	.4531	11.51	12	198	215	265	9553792	251	268	315	9553869
NXC__11910T7	15/32	.4687	11.90	12	197	215	265	9553793	250	268	315	9553870
NXC__12000T7		.4724	12.00	12	197	215	265	9553794	250	268	315	9553871
NXC__12300T7		.4843	12.30	14	212	230	280	9553795	257	275	325	9553872
NXC__12303T7	31/64	.4844	12.30	14	212	230	280	9553796	257	275	325	9553873
NXC__12700T7	1/2	.5000	12.70	14	211	230	280	9553797	256	275	325	9553874
NXC__13000T7		.5118	13.00	14	210	230	280	9553798	256	275	325	9553875
NXC__13300T7		.5236	13.30	14	225	245	295	9553799	285	305	355	9553876
NXC__13490T7	17/32	.5313	13.50	14	225	245	295	9553800	285	305	355	9553877
NXC__13500T7		.5315	13.50	14	225	245	295	9553801	285	305	355	9553878
NXC__14000T7		.5512	14.00	14	224	245	295	9553802	284	305	355	9553879
NXC__14290T7	9/16	.5625	14.29	16	234	255	305	9553803				
NXC__14500T7		.5709	14.50	16	233	255	305	9553804				
NXC__15000T7		.5906	15.00	16	232	255	305	9553806				
NXC__15500T7		.6102	15.50	16	252	275	325	9553807				
NXC__15870T7	5/8	.6250	15.88	16	251	275	325	9553808				
NXC__16000T7		.6299	16.00	16	251	275	325	9553809				

***Order Example**

NXC__09920T7 > 16xD >>> NXC1609920T7

NXC__09920T7 > 20xD >>> NXC2009920T7

** Diameters (2.0-2.9mm) and other dimensions are available upon request**

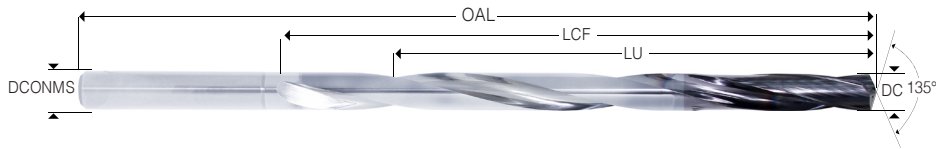

Item Description (Insert 25 or 30 in place of __) *Order Example	**DC Cutting Diameter			DCONMS	25xD Dimensions (mm)				30xD Dimensions (mm)			
	Fraction	Decimal	mm		LU Usable Length	LCF Length Chip Flute	OAL Overall Length	Item Number	LU Usable Length	LCF Length Chip Flute	OAL Overall Length	Item Number
NXC__03000T7		.1181	3.00	6	94	98	135	9553889	101	105	150	9553941
NXC__03175T7	1/8	.1250	3.18	6	93	98	135	9553890	100	105	150	9553942
NXC__03200T7		.1260	3.20	6	93	98	135	9553891	100	105	150	9553943
NXC__03300T7		.1299	3.30	6	93	98	135	9553892	130	135	185	9553944
NXC__03500T7		.1378	3.50	6	93	98	135	9553893	130	135	185	9553945
NXC__03572T7	9/64	.1406	3.57	6	115	120	160	9553894	130	135	185	9553946
NXC__03800T7		.1496	3.80	6	114	120	160	9553895	129	135	185	9553947
NXC__03970T7	5/32	.1563	3.97	6	114	120	160	9553896	129	135	185	9553948
NXC__04000T7		.1575	4.00	6	114	120	160	9553897	129	135	185	9553949
NXC__04200T7		.1654	4.20	6	114	120	160	9553898	129	135	185	9553950
NXC__04370T7	11/64	.1719	4.37	6	128	135	180	9553899	158	165	215	9553951
NXC__04500T7		.1772	4.50	6	128	135	180	9553900	158	165	215	9553952
NXC__00130T7	#13	.1850	4.70	6	128	135	180	9553888	158	165	215	9553940
NXC__04760T7	3/16	.1875	4.76	6	128	135	180	9553901	158	165	215	9553954
NXC__00120T7	#12	.1890	4.80	6	128	135	180	9553887	158	165	215	9553939
NXC__05000T7		.1969	5.00	6	128	135	180	9553902	158	165	215	9553955
NXC__05160T7	13/64	.2031	5.16	6	160	168	205	9553903	172	180	230	9553956
NXC__00060T7	#6	.2040	5.18	6	160	168	205	9553886	172	180	230	9553938
NXC__05500T7		.2165	5.50	6	160	168	205	9553904	172	180	230	9553957
NXC__05560T7	7/32	.2187	5.55	6	160	168	205	9553905	172	180	230	9553958
NXC__05800T7		.2283	5.80	6	159	168	205	9553906	171	180	230	9553959
NXC__05950T7	15/64	.2344	5.95	6	159	168	205	9553907	171	180	230	9553960
NXC__06000T7		.2362	6.00	6	159	168	205	9553908	171	180	230	9553961
NXC__06350T7	1/4	.2500	6.35	8	190	200	240	9553909	205	215	280	9553962
NXC__06500T7		.2559	6.50	8	190	200	240	9553910	205	215	280	9553963
NXC__06750T7	17/64	.2656	6.75	8	190	200	240	9553911	220	230	280	9553964
NXC__06800T7		.2677	6.80	8	190	200	240	9553912	220	230	280	9553965
NXC__07000T7		.2756	7.00	8	189	200	240	9553913	219	230	280	9553966
NXC__07140T7	9/32	.2813	7.15	8	209	220	260	9553914	219	230	280	9553967
NXC__07500T7		.2953	7.50	8	209	220	260	9553915	219	230	280	9553968
NXC__07540T7	19/64	.2969	7.54	8	209	220	260	9553916	254	265	315	9553969
NXC__07800T7		.3071	7.80	8	208	220	260	9553917	253	265	315	9553970
NXC__07940T7	5/16	.3125	7.94	8	208	220	260	9553918	253	265	315	9553971
NXC__08000T7		.3150	8.00	8	208	220	260	9553919	253	265	315	9553972
NXC__08330T7	21/64	.3281	8.33	10	228	240	285	9553920	283	295	350	9553973
NXC__08500T7		.3346	8.50	10	227	240	285	9553921	282	295	350	9553974
NXC__08730T7	11/32	.3437	8.73	10	255	268	310	9553922	317	330	380	9553975
NXC__08800T7		.3465	8.80	10	255	268	310	9553923	317	330	380	9553976
NXC__09000T7		.3543	9.00	10	255	26	310	9553924	317	330	380	9553977
NXC__09130T7	23/64	.3594	9.13	10	254	268	310	9553925	316	330	380	9553978
NXC__09520T7	3/8	.3750	9.53	10	254	268	310	9553926	316	330	380	9553979
NXC__09800T7		.3858	9.80	10	253	268	310	9553927	315	330	380	9553980
NXC__09920T7	25/64	.3906	9.92	10	253	268	310	9553928	315	330	380	9553981
NXC__10000T7		.3937	10.00	10	253	268	310	9553929	315	330	380	9553982
NXC__10320T7	13/32	.4063	10.32	12	285	300	350	9553930				
NXC__10720T7	27/64	.4219	10.72	12	284	300	350	9553931				
NXC__11000T7		.4331	11.00	12	283	300	350	9553932				
NXC__11113T7	7/16	.4375	11.11	12	313	330	380	9553933				
NXC__11500T7		.4528	11.50	12	313	330	380	9553934				
NXC__11510T7	29/64	.4531	11.51	12	313	330	380	9553935				
NXC__11910T7	15/32	.4687	11.90	12	312	330	380	9553936				
NXC__12000T7		.4724	12.00	12	312	330	380	9553937				

***Order Example**

NXC__03000T7 > 25xD >>> NXC2503000T7
 NXC__09920T7 > 30xD >>> NXC3009920T7

** Diameters (2.0-2.9mm) and other dimensions are available upon request**



SCAN FOR SPEEDS & FEEDS

CARBIDE DRILLS



**High Performance
Single Margin
Coolant Thru Drill
Ideal Hardened
Materials
3xD**

S H Refer to page 4

Design – Spiral-fluted, right-hand cut, with internal coolant and a cylindrical shank.

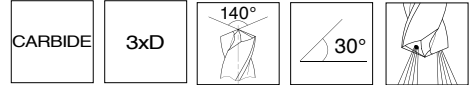

Sistral® Its nanostructure composition provides both high heat and oxidation resistance. Ideal for machining and drilling HRSA's™



SCAN FOR SPEEDS & FEEDS



140° Point Geometry - Designed for low-cutting force and chip evacuation.

Coolant Holes - Cool the cutting edge and improve chip evacuation.

Single-Margin Design -Reduces contact with surface hole limiting heat

S-Point - Stronger point edge & corner protection.

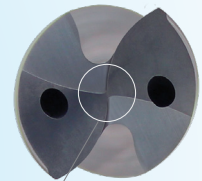

No Pecking Required

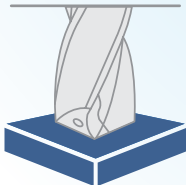

3xD

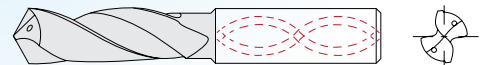



Design – Spiral-fluted, right-hand cut, with internal coolant and a cylindrical shank.

Ideal for – Hardened Materials

S H Refer to page 4



Sistral® Its nanostructure composition provides both high heat and oxidation resistance. Ideal for machining and drilling HRSAs.

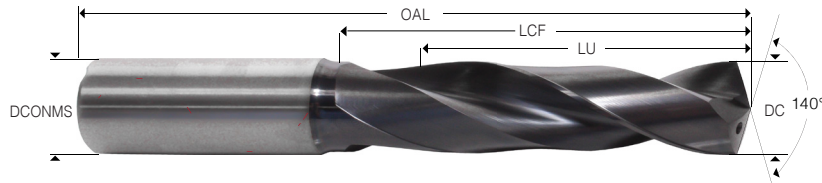

Item Description	**DC Cutting Diameter			DCONMS	3xD Dimensions (mm)			Item Number
	Fraction	Decimal	mm		LU Usable Length	LCF Length Chip Flute	OAL Overall Length	
HXC0303000T7		.1181	3.00	6	16	20	62	9549090
HXC0303100T7		.1220	3.10	6	15	20	62	9549091
HXC0303175T7	1/8	.1250	3.18	6	15	20	62	9549092
HXC0303200T7		.1260	3.20	6	15	20	62	9549093
HXC0303300T7		.1299	3.30	6	15	20	62	9549094
HXC0303400T7		.1339	3.40	6	15	20	62	9549095
HXC0303500T7		.1378	3.50	6	15	20	62	9549096
HXC0303572T7	9/64	.1406	3.57	6	15	20	62	9549097
HXC0303600T7		.1417	3.60	6	15	20	62	9549098
HXC0303700T7		.1457	3.70	6	14	20	62	9549099
HXC0303800T7		.1496	3.80	6	18	24	66	9549100
HXC0303900T7		.1535	3.90	6	18	24	66	9549101
HXC0303970T7	5/32	.1563	3.97	6	18	24	66	9549102
HXC0304000T7		.1575	4.00	6	18	24	66	9549103
HXC0304100T7		.1614	4.10	6	18	24	66	9549104
HXC0304200T7		.1654	4.20	6	18	24	66	9549105
HXC0304300T7		.1693	4.30	6	18	24	66	9549106
HXC0304370T7	11/64	.1719	4.37	6	17	24	66	9549107
HXC0304400T7		.1732	4.40	6	17	24	66	9549109
HXC0304500T7		.1772	4.50	6	17	24	66	9549110
HXC0304600T7		.1811	4.60	6	17	24	66	9549111
HXC0304650T7		.1831	4.65	6	17	24	66	9549113
HXC0300130T7	#13	.1850	4.70	6	17	24	66	9549089
HXC0304760T7	3/16	.1875	4.76	6	21	28	66	9549114
HXC0300120T7	#12	.1890	4.80	6	21	28	66	9549088
HXC0304900T7		.1929	4.90	6	21	28	66	9549116
HXC0305000T7		.1969	5.00	6	20	28	66	9549117
HXC0305100T7		.2008	5.10	6	20	28	66	9549118
HXC0305160T7	13/64	.2031	5.16	6	20	28	66	9549119
HXC0300060T7	#6	.2040	5.18	6	20	28	66	9549087
HXC0305200T7		.2047	5.20	6	20	28	66	9549120
HXC0305300T7		.2087	5.30	6	20	28	66	9549121
HXC0305400T7		.2126	5.40	6	20	28	66	9549122
HXC0305500T7		.2165	5.50	6	20	28	66	9549123
HXC0305550T7		.2185	5.55	6	20	28	66	9549124
HXC0305560T7	7/32	.2187	5.55	6	20	28	66	9549125
HXC0305600T7		.2205	5.60	6	20	28	66	9549126
HXC0305700T7		.2244	5.70	6	19	28	66	9549127
HXC0305800T7		.2283	5.80	6	19	28	66	9549128
HXC0305900T7		.2323	5.90	6	19	28	66	9549129
HXC0305950T7	15/64	.2344	5.95	6	19	28	66	9549130
HXC0306000T7		.2362	6.00	6	19	28	66	9549131
HXC0306100T7		.2402	6.10	8	25	34	79	9549132
HXC0306200T7		.2441	6.20	8	25	34	79	9549134
HXC0306300T7		.2480	6.30	8	25	34	79	9549136
HXC0306350T7	1/4	.2500	6.35	8	24	34	79	9549138
HXC0306400T7		.2520	6.40	8	24	34	79	9549140
HXC0306500T7		.2559	6.50	8	24	34	79	9549142
HXC0306600T7		.2598	6.60	8	24	34	79	9549144
HXC0306700T7		.2638	6.70	8	24	34	79	9549146
HXC0306750T7	17/64	.2656	6.75	8	24	34	79	9549147
HXC0306800T7		.2677	6.80	8	24	34	79	9549148
HXC0306900T7		.2717	6.90	8	31	41	79	9549149
HXC0307000T7		.2756	7.00	8	31	41	79	9549150
HXC0307100T7		.2795	7.10	8	30	41	79	9549151
HXC0307140T7	9/32	.2813	7.15	8	30	41	79	9549152
HXC0307200T7		.2835	7.20	8	30	41	79	9549153
HXC0307300T7		.2874	7.30	8	30	41	79	9549154
HXC0307400T7		.2913	7.40	8	30	41	79	9549155
HXC0307500T7		.2953	7.50	8	30	41	79	9549156
HXC0307540T7	19/64	.2969	7.54	8	30	41	79	9549157
HXC0307700T7		.3031	7.70	8	29	41	79	9549158
HXC0307800T7		.3071	7.80	8	29	41	79	9549159
HXC0307900T7		.3110	7.90	8	29	41	79	9549160
HXC0307940T7	5/16	.3125	7.94	8	29	41	79	9549162

** Diameters (2.0-2.9mm) and other dimensions are available upon request**

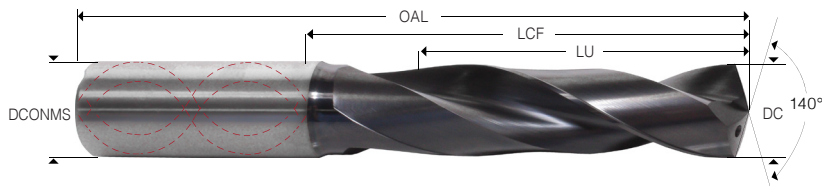

Item Description	**DC Cutting Diameter			DCONMS	3xD Dimensions (mm)			Item Number
	Fraction	Decimal	mm		LU Usable Length	LCF Length Chip Flute	OAL Overall Length	
HXC0308000T7		.3150	8.00	8	29	41	79	9549163
HXC0308100T7		.3189	8.10	10	35	47	89	9549164
HXC0308200T7		.3228	8.20	10	35	47	89	9549165
HXC0308300T7		.3268	8.30	10	35	47	89	9549166
HXC0308330T7	21/64	.3281	8.33	10	35	47	89	9549167
HXC0308400T7		.3307	8.40	10	34	47	89	9549168
HXC0308500T7		.3346	8.50	10	34	47	89	9549169
HXC0308600T7		.3386	8.60	10	34	47	89	9549170
HXC0308700T7		.3425	8.70	10	34	47	89	9549171
HXC0308730T7	11/32	.3437	8.73	10	34	47	89	9549172
HXC0308800T7		.3465	8.80	10	34	47	89	9549173
HXC0309000T7		.3543	9.00	10	34	47	89	9549174
HXC0309130T7	23/64	.3594	9.13	10	33	47	89	9549175
HXC0309200T7		.3622	9.20	10	33	47	89	9549176
HXC0309300T7		.3661	9.30	10	33	47	89	9549177
HXC0309500T7		.3740	9.50	10	33	47	89	9549178
HXC0309520T7	3/8	.3750	9.53	10	33	47	89	9549180
HXC0309600T7		.3780	9.60	10	33	47	89	9549181
HXC0309800T7		.3858	9.80	10	32	47	89	9549182
HXC0309900T7		.3898	9.90	10	32	47	89	9549183
HXC0309920T7	25/64	.3906	9.92	10	32	47	89	9549184
HXC0310000T7		.3937	10.00	10	32	47	89	9549185
HXC0310100T7		.3976	10.10	12	40	55	102	9549186
HXC0310200T7		.4016	10.20	12	40	55	102	9549187
HXC0310300T7		.4055	10.30	12	40	55	102	9549188
HXC0310320T7	13/32	.4063	10.32	12	40	55	102	9549189
HXC0310400T7		.4094	10.40	12	39	55	102	9549190
HXC0310500T7		.4134	10.50	12	39	55	102	9549191
HXC0310720T7	27/64	.4219	10.72	12	39	55	102	9549192
HXC0310800T7		.4252	10.80	12	39	55	102	9549193
HXC0311000T7		.4331	11.00	12	38	55	102	9549194
HXC0311100T7		.4370	11.10	12	38	55	102	9549195
HXC0311113T7	7/16	.4375	11.11	12	38	55	102	9549196
HXC0311200T7		.4409	11.20	12	38	55	102	9549197
HXC0311500T7		.4528	11.50	12	38	55	102	9549198
HXC0311510T7	29/64	.4531	11.51	12	38	55	102	9549199
HXC0311700T7		.4606	11.70	12	37	55	102	9549200
HXC0311800T7		.4646	11.80	12	37	55	102	9549201
HXC0311910T7	15/32	.4687	11.90	12	37	55	102	9549202
HXC0312000T7		.4724	12.00	12	37	55	102	9549203
HXC0312100T7		.4764	12.10	14	42	60	107	9549204
HXC0312200T7		.4803	12.20	14	42	60	107	9549205
HXC0312300T7		.4843	12.30	14	42	60	107	9549206
HXC0312303T7	31/64	.4844	12.30	14	42	60	107	9549207
HXC0312500T7		.4921	12.50	14	41	60	107	9549208
HXC0312600T7		.4961	12.60	14	41	60	107	9549209
HXC0312700T7	1/2	.5000	12.70	14	41	60	107	9549210
HXC0313000T7		.5118	13.00	14	41	60	107	9549211
HXC0313300T7		.5236	13.30	14	40	60	107	9549212
HXC0313490T7	17/32	.5313	13.50	14	40	60	107	9549213
HXC0313500T7		.5315	13.50	14	40	60	107	9549214
HXC0314000T7		.5512	14.00	14	39	60	107	9549215
HXC0314290T7	9/16	.5625	14.29	16	44	65	115	9549216
HXC0314500T7		.5709	14.50	16	43	65	115	9549217
HXC0315000T7		.5906	15.00	16	42	65	115	9549219
HXC0315500T7		.6102	15.50	16	42	65	115	9549220
HXC0315870T7	5/8	.6250	15.88	16	41	65	115	9549221
HXC0316000T7		.6299	16.00	16	41	65	115	9549223
HXC0316500T7		.6496	16.50	18	48	73	123	9549224
HXC0317000T7		.6693	17.00	18	48	73	123	9549225
HXC0317500T7		.6890	17.50	18	47	73	123	9549227
HXC0318000T7		.7087	18.00	18	46	73	123	9549229
HXC0318500T7		.7283	18.50	20	51	79	131	9549230
HXC0319050T7	3/4	.7500	19.05	20	50	79	131	9549231
HXC0319500T7		.7677	19.50	20	50	79	131	9549232
HXC0320000T7		.7874	20.00	20	49	79	131	9549233

** Diameters (2.0-2.9mm) and other dimensions are available upon request**



SCAN FOR SPEEDS & FEEDS

Manual for Pilot Drill

All deep-hole drills must utilize a pilot hole drill.

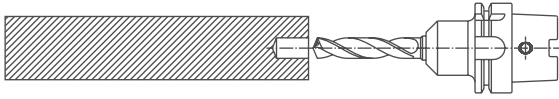

Utilize a pilot hole drill to a minimum pilot depth of 1 to 1.5 x D. The pilot drill must be .00078 inches (.02mm) bigger in diameter than the diameter of the long drill.



Introduce the long drill in the hole at a speed of 300 RPM.

Use low pressure coolant until the drill reaches full RPM

Then turn on high pressure coolant

You might need to add a G4 for a couple of seconds for the coolant to reach full pressure.

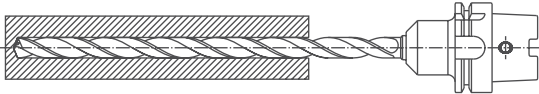

After entering the hole, increase to the recommended feedrate.

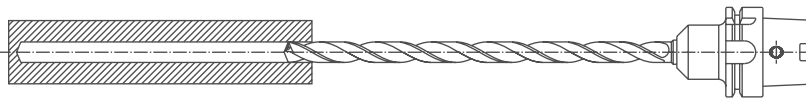

Before taking the drill out of the hole, reduce the speed back to 300 RPM and withdraw the long drill.

Use the same feedrate to retract to start point and Reduce the coolant pressure. Do not use a rapid move.

Coolant Fed:

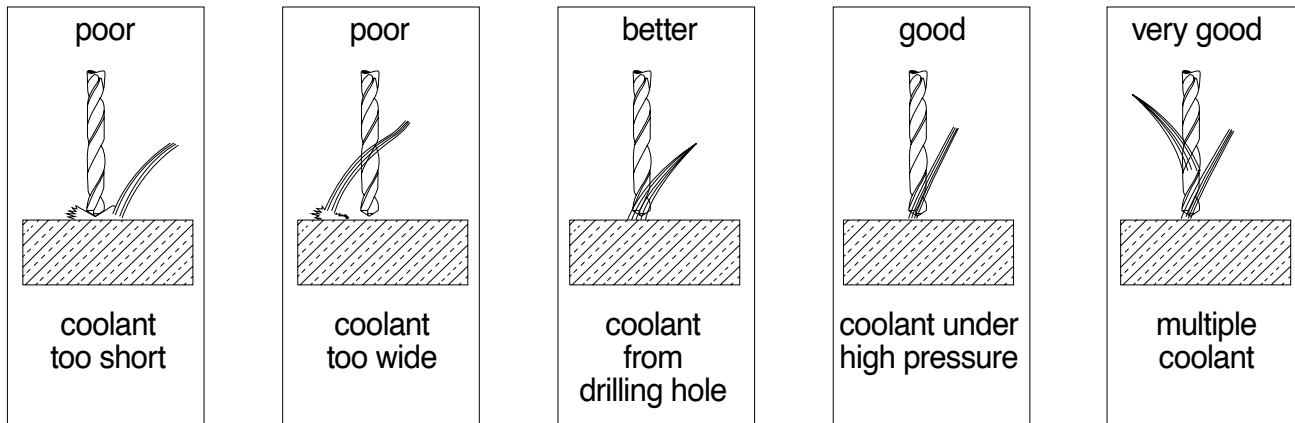



Pilot Coolant Thru Drill
Recommended for Drills 16xD and Above.

P M K N S Material Code: Refer to Page 4



Varianta® Supral Provides a low coefficient of friction, reducing tool wear and resulting in a longer tool life.



SCAN FOR SPEEDS & FEEDS

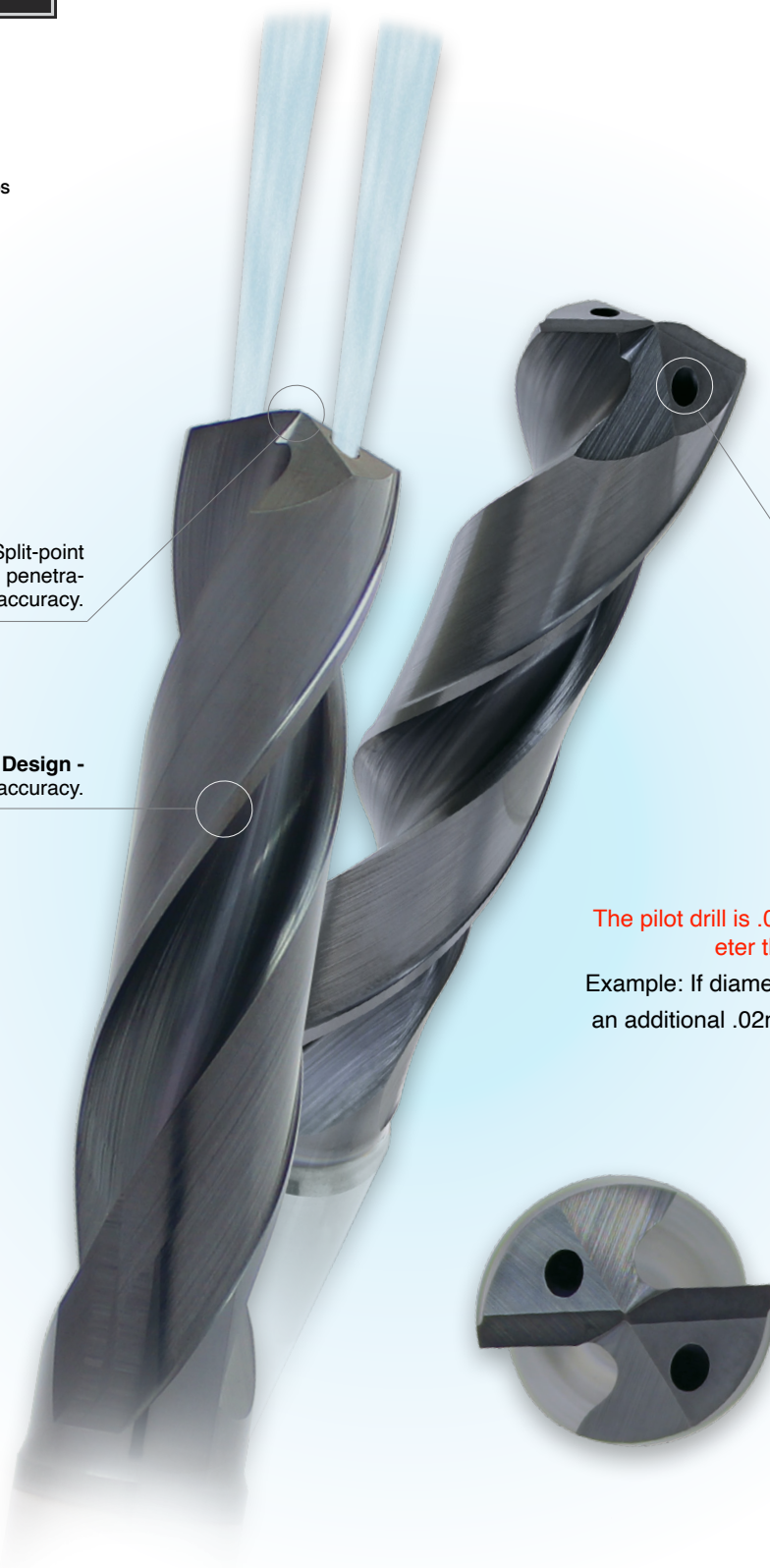

150° Point Geometry - Split-point geometry for superior drill penetration and accuracy.

Coolant Holes - Cool the cutting edge and improve chip evacuation.

Single-Margin Design - For drilling accuracy.

The pilot drill is .00078 in (.02mm) larger in diameter than the diameter of the long drill

Example: If diameter is shown as 3.00mm we add an additional .02mm in diameter to make it a pilot drill.
 (3.00mm + .02mm = 3.02mm)

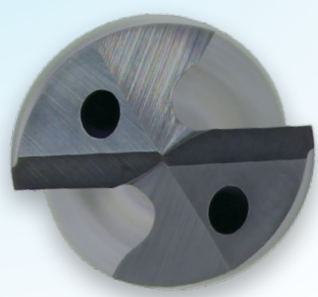

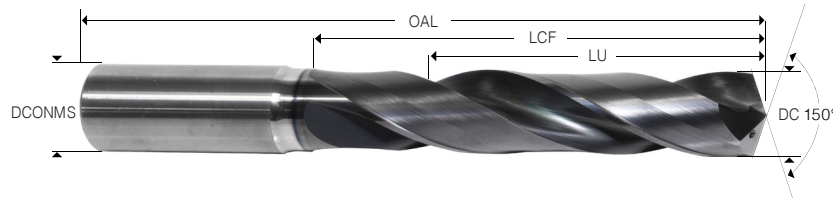

Item Description	**DC Cutting Diameter			DCONMS	5xD Dimensions (mm)			Item Number
	Fraction	Decimal	mm		LU Usable Length	LCF Length Chip Flute	OAL Overall Length	
PXC0503000T9	-	.1181	3.00	6	24	28	66	9565691
PXC0503175T9	1/8	.1250	3.18	6	23	28	66	9565695
PXC0503200T9	-	.1260	3.20	6	23	28	66	9565697
PXC0503300T9	-	.1299	3.30	6	23	28	66	9565698
PXC0503500T9	-	.1378	3.50	6	22	28	66	9565705
PXC0503572T9	9/64	.1406	3.57	6	23	28	66	9565707
PXC0503800T9	#25	.1496	3.80	6	30	36	74	9565710
PXC0503970T9	5/32	.1563	3.97	6	30	36	74	9565714
PXC0504000T9	-	.1575	4.00	6	30	36	74	9565715
PXC0504200T9	-	.1654	4.20	6	30	36	74	9565718
PXC0504370T9	11/64	.1719	4.37	6	30	36	74	9565721
PXC0504500T9	-	.1772	4.50	6	29	36	74	9565724
PXC0500130T9	#13	.1850	4.70	6	29	36	74	9565686
PXC0504760T9	3/16	.1875	4.76	6	37	44	82	9565728
PXC0500120T9	#12	.1890	4.80	6	37	44	82	9565685
PXC0505000T9	-	.1969	5.00	6	37	44	82	9565732
PXC0505160T9	13/64	.2031	5.16	6	36	44	82	9565734
PXC0500060T9	#6	.2040	5.18	6	36	44	82	9565684
PXC0505500T9	-	.2165	5.50	6	36	44	82	9565742
PXC0505560T9	7/32	.2187	5.55	6	36	44	82	9565744
PXC0505800T9	-	.2283	5.80	6	35	44	82	9565747
PXC0505950T9	15/64	.2344	5.95	6	35	44	82	9565749
PXC0506000T9	-	.2362	6.00	8	35	44	82	9565750
PXC0506350T9	1/4	.2500	6.35	8	44	53	91	9565754
PXC0506500T9	-	.2559	6.50	8	43	53	91	9565759
PXC0506750T9	17/64	.2656	6.75	8	43	53	91	9565766
PXC0506800T9	-	.2677	6.80	8	43	53	91	9565767
PXC0507000T9	-	.2756	7.00	8	43	53	91	9565769
PXC0507140T9	9/32	.2813	7.15	8	43	53	91	9565772
PXC0507500T9	-	.2953	7.50	8	42	53	91	9565776
PXC0507540T9	19/64	.2969	7.54	8	42	53	91	9565777
PXC0507800T9	-	.3071	7.80	8	41	53	91	9565779
PXC0507940T9	5/16	.3125	7.94	8	41	53	91	9565782
PXC0508000T9	-	.3150	8.00	10	41	53	91	9565783
PXC0508330T9	21/64	.3281	8.33	10	49	61	103	9565789
PXC0508500T9	-	.3346	8.50	10	48	61	103	9565791
PXC0508600T9	-	.3386	8.60	10	48	61	103	9565792
PXC0508700T9	-	.3425	8.70	10	48	61	103	9565793
PXC0508730T9	11/32	.3437	8.73	10	48	61	103	9565794
PXC0508800T9	-	.3465	8.80	10	48	61	103	9565795
PXC0509000T9	-	.3543	9.00	10	48	61	103	9565797
PXC0509130T9	23/64	.3594	9.13	10	47	61	103	9565798
PXC0509520T9	3/8	.3750	9.53	10	47	61	103	9565803
PXC0509600T9	-	.3780	9.60	10	47	61	103	9565805
PXC0509800T9	-	.3858	9.80	10	46	61	103	9565807
PXC0509920T9	25/64	.3906	9.92	10	46	61	103	9565809
PXC0515500T9	-	.6102	15.50	16	60	83	133	9565862
PXC0519050T9	3/4	.7500	19.05	20	72	101	153	9565876

** Diameters (2.0-2.9mm) and other dimensions are available upon request**

CARBIDE DRILLS



SCAN FOR SPEEDS & FEEDS



PRECISION CUTTING TOOLS
Member IMC Group

ENDMILLS



GET A STRONGER GRIP

WITH WELDON FLAT & FIRM HOLD SHANK



Weldon Flat screw clamping prevents the tool from pulling out or twisting. It provides reliable and safe clamping

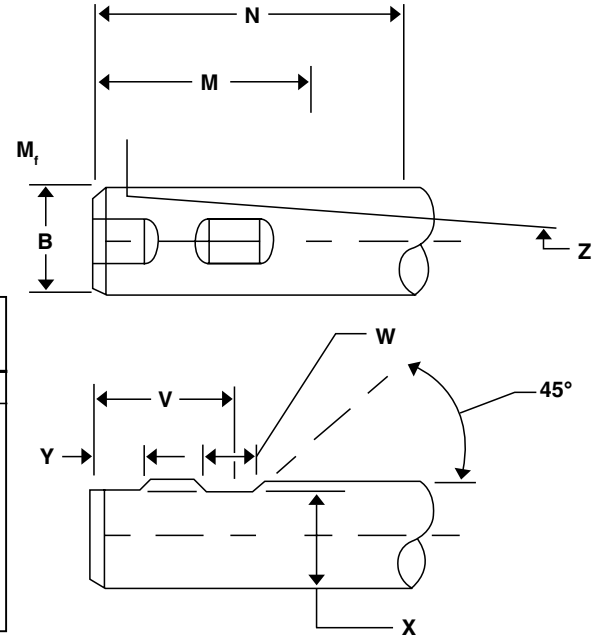

NOMINAL SHANK DIA. REF	MODIFIED WELDON FLAT DIMENSIONS				BASIC CONFIGURATION ANGULAR FLAT DIMENSIONS			HARDNESS CHECK POINT
	B	V	W	X	Y	M	M1	Z (+.015/- .000)
0.3750	0.781	0.280	0.325	-	1.00	0.300	0.100	1.12
0.5000	0.891	0.330	0.440	-	1.06		0.100	1.25
0.6250	0.953	0.400	0.560	-	1.19		0.110	1.25
0.7500	1.015	0.455	0.675	-	1.25		0.130	1.25
0.8750	1.015	0.455	0.810	0.50	1.25		0.130	1.25
1.0000	1.141	0.515	0.925	0.50	1.44		0.180	1.62
1.2500	1.141	0.515	1.156	0.50	1.44		0.180	1.62

BEFORE

AFTER



The **Firm Hold Shank** can be applied to any of our standard endmills or special tools. The shank is diamond blasted, to create an overall stronger grip and maximize tool performance.

BENEFITS

- Reduces Tool Pull-Out
- Creates Greater Torsional Resistance
- Increase Productivity With Higher-Feed Rates



2 FLUTE HIGH PERFORMANCE

224 SERIES

Advanced Geometry; Wiper Flat, E-Cut Polish and Controlled Land, will Provide Better Chip Evacuation and a Superior Part Finish

Available Upon Request:
Flats, Firm Hold Shank and Additional PVD Coatings.

N Material Code: Refer to Page 4

CARBIDE

2 Flutes

45°

Extral Carbon®

Extral Carbon® 3-4 times more tool life compared to ZrN.

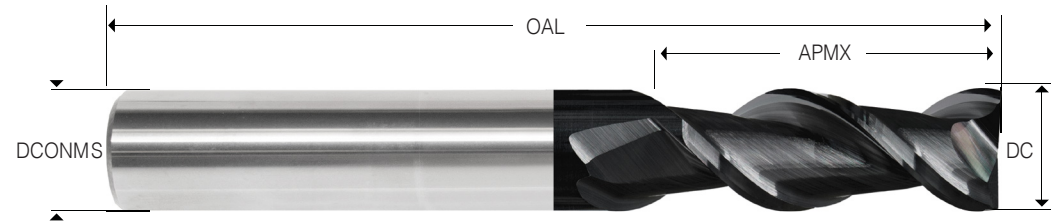

SCAN FOR SPEEDS & FEEDS

Fractional

DC	DCONMS	APMX	OAL	SQUARE	.015 RAD	.030 RAD	.060 RAD	.090 RAD	.125 RAD	BALL
3/16	3/16	5/16	2	9519515	9501370	9503480				9519516
3/16	3/16	9/16	2	9519517	9581382	9503481				9519519
1/4	1/4	1/2	2	9519524	9501371	9503482				9519525
1/4	1/4	3/4	2-1/2	9519530	9501373	9503489				9519532
1/4	1/4	1	3	9519535	9581384	9503490				9519536
1/4	1/4	1-1/4	4	9519537	9581385	9503495				9519538
5/16	5/16	7/8	2-1/2	9519540	9581388	9581635				9519550
5/16	5/16	1-1/4	4	9519545	9581386	9581638				9519542
5/16	5/16	1-5/8	4	9519547	9581387	9581639				9519546
5/16	5/16	7/16	2	9519549	9501374	9581640				9519548
3/8	3/8	1/2	2	9519551	9581389	9581641	9506944	9584938	9585164	9519552
3/8	3/8	1	2-1/2	9519561	9501376	9581642	9581926	9509282	9585166	9519563
3/8	3/8	1-1/8	3	9519565	9581392	9581643	9581927	9584941	9585167	9519567
3/8	3/8	1-1/2	4	9519569	9501377	9581644	9581928	9509283	9585168	9519571
7/16	7/16	9/16	2-3/4	9519574	9581393	9581646	9581929	9584942	9585169	9519575
7/16	7/16	1	2-3/4	9519576	9581394	9581647	9581930	9584943	9585170	9519577
7/16	7/16	2	4	9519578	9581395	9581648	9581931	9584944	9585171	9519579
1/2	1/2	5/8	2-1/2	9519580	9581396	9581649	9581932	9584945	9585172	9519581
1/2	1/2	1-1/4	3	9519598	9581400	9581650	9506945	9584949	9511558	9519600
1/2	1/2	1-1/2	4	9519602	9581401	9581651	9506946	9584950	9511559	9519603
1/2	1/2	1-1/2	6	9519604	9501379	9581652	9506947	9509284	9511561	9519607
1/2	1/2	2	4	9519606	9581402	9581656	9581937	9584951	9511560	9519605
1/2	1/2	3-1/8	6	9519611	9581403	9581657	9506948	9584952	9511563	9519612
5/8	5/8	3/4	3	9519613	9581404	9581658	9581938	9584953	9585175	9585362
5/8	5/8	1-1/2	6	9519621	9581408	9581659	9581943	9584958	9585180	9519624
5/8	5/8	1-5/8	3-1/2	9519623	9581409	9581663	9581944	9584959	9584051	9519626
5/8	5/8	2	4	9519625	9581410	9581664	9581945	9584960	9585181	9519628
5/8	5/8	2-1/4	5	9519627	9581407	9581665	9581942	9584957	9585179	9519622
5/8	5/8	3	6	9519629	9581411	9581666	9581946	9584961	9585182	9519630
3/4	3/4	1	3	9519631	9581412	9581667	9581947	9584962	9585183	9519632
3/4	3/4	1-1/2	6	9519649	9581416	9581668	9581952	9584967	9585188	9519652
3/4	3/4	1-5/8	4	9519651	9581417	9581669	9506949	9584968	9511565	9519654
3/4	3/4	2-1/4	5	9519653	9581415	9581670	9581951	9584966	9585187	9519650
3/4	3/4	3-1/4	6	9519655	9581418	9581671	9581953	9584969	9585189	9519656
3/4	3/4	4	7	9519657	9501382	9581672	9581954	9584970	9585190	9519658
1	1	1-1/4	4	9519659	9581419	9581673	9581955	9584971	9585191	9519660
1	1	1-1/2	6	9519668	9581424	9581675	9581958	9509285	9585195	9519672
1	1	2	4-1/2	9519671	9581425	9581677	9506952	9584976	9585196	9519676
1	1	2-1/4	5	9519675	9581421	9581678	9581956	9584973	9585192	9519669
1	1	2-5/8	6	9519677	9581426	9581679	9581959	9584977	9511567	9519678
1	1	3-1/4	6	9519680	9581427	9581680	9581960	9584978	9585197	9519682
1	1	4-1/8	7	9519683	9501383	9581681	9581961	9584979	9585198	9519684

Other Dimensions are Available Upon Request



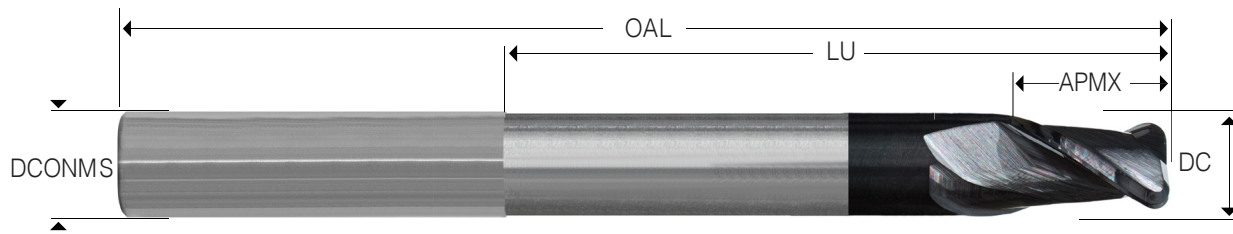

Extended Reach provides a more stable and stronger option for deep pocketing applications.

Extended Neck

DC	DCONMS	APMX	LU	OAL	SQUARE	.015 RAD	.030 RAD	.060 RAD	.090 RAD	.125 RAD	BALL
1/4	1/4	1/2	1-1/4	3	9519526	9581383	9581636				9519527
1/4	1/4	1/2	2-1/8	4	9519528	9501372	9581637				9519529
3/8	3/8	3/4	1-1/4	3	9585356	9581390	9581645	9581924	9584939	9585165	9585357
3/8	3/8	3/4	2-1/8	4	9585358	9581391	9503483	9581925	9584940	9511556	9519559
1/2	1/2	7/8	1-3/8	3	9519589	9581397	9581653	9581933	9584946	9511557	9585359
1/2	1/2	7/8	2-1/8	4	9519590	9501378	9503487	9581934	9584947	9585173	9519591
1/2	1/2	7/8	3-1/8	5	9519592	9581398	9581654	9581935	9586034	9585669	9586162
1/2	1/2	7/8	4-1/8	6	9585360	9581399	9581655	9581936	9584948	9585174	9585361
5/8	5/8	1	2	4	9585363	9501380	9581660	9581939	9584954	9585176	9585364
5/8	5/8	1	3	5	9585365	9581405	9581661	9581940	9584955	9585177	9519620
5/8	5/8	1	4	6	9585366	9581406	9581662	9581941	9584956	9585178	9585367
3/4	3/4	1-1/4	2	4	9519643	9581413	9503491	9581948	9584963	9585184	9519644
3/4	3/4	1-1/4	3	5	9519645	9501381	9503492	9581949	9584964	9585185	9519646
3/4	3/4	1-1/4	4	6	9585368	9581414	9503493	9581950	9584965	9585186	9519647
1	1	1-1/2	3	5	9585369	9581420	9581674	9506950	9584972	9511566	9585370
1	1	1-1/2	4	6	9585371	9581422	9503496	9506951	9584974	9585193	9585372
1	1	1-1/2	5	7	9585373	9581423	9581676	9581957	9584975	9585194	9585374



SCAN FOR SPEEDS & FEEDS

3 FLUTE HIGH PERFORMANCE



Variable Design Allows for Chatter Free Machining at Higher Speed and Feeds. Ideal for Heavy Profile and Slotting applications.

Available Upon Request:
Flats, Firm Hold Shank and
Additional PVD Coatings.

N Material Code: Refer to Page 4



Exxtral Carbon® 3-4 times more tool life compared to ZrN.

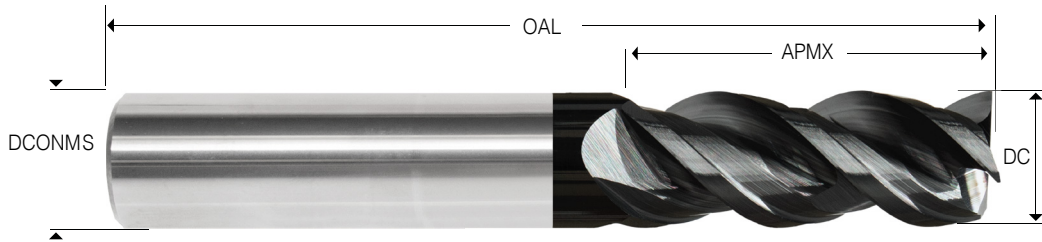

SCAN FOR SPEEDS & FEEDS

Fractional

DC	DCONMS	APMX	OAL	SQUARE	.015 RAD	.030 RAD	.060 RAD	.090 RAD	.125 RAD	BALL
1/4	1/4	1/2	2	9525188	9501569	9504108	9507485			9525187
1/4	1/4	3/4	2-1/2	9525195	9501572	9504111	9507488			9525194
5/16	5/16	1/2	2	9525199	9581455	9581717	9584758			9525198
5/16	5/16	3/4	2-1/2	9525201	9501573	9504112	9507489			9525200
3/8	3/8	1/2	2	9525203	9501574	9504113	9585964	9586042	9586086	9586168
3/8	3/8	1	2-1/2	9525221	9501579	9504117	9507492	9509468	9512293	9525220
1/2	1/2	5/8	2-1/2	9525228	9581457	9581718	9584759	9509469	9585224	9525227
1/2	1/2	1-1/4	3	9525251	9501586	9504125	9507499	9509473	9512302	9525250
5/8	5/8	3/4	3	9525257	9581460	9581719	9584760	9585020	9585226	9525256
5/8	5/8	1-5/8	3-1/2	9525276	9585959	9585961	9585965	9586044	9586087	9586169
3/4	3/4	1	3	9525279	9501589	9581723	9584763	9585024	9512308	9525278
3/4	3/4	1-5/8	4	9525299	9501596	9504136	9507506	9509475	9512315	9525298
7/8	7/8	1-1/2	4	9525305	9501598	9581725	9584765	9585028	9585228	9525304
1	1	1-1/2	4	9525311	9501599	9581726	9507508	9585029	9512316	9525310

Other Dimensions are Available Upon Request

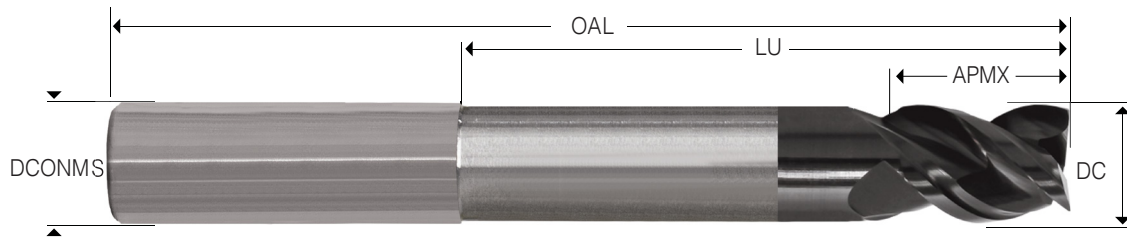

Extended Reach provides a more stable and stronger option for deep pocketing applications.

Extended Neck

DC	DCONMS	APMX	LU	OAL	SQUARE	.015 RAD	.030 RAD	.060 RAD	.090 RAD	.125 RAD	BALL
1/4	1/4	1/2	1-1/4	3	9525190	9501570	9504109	9507486			9525189
1/4	1/4	1/2	2-1/8	4	9525193	9501571	9504110	9507487			9525192
3/8	3/8	3/4	1-1/4	3	9525214	9501578	9504115	9507490	9509467	9512291	9525213
3/8	3/8	3/4	2-1/8	4	9525216	9581456	9504116	9507491	9585018	9512292	9525215
1/2	1/2	7/8	1-3/8	3	9525238	9501583	9504120	9507494	9585019	9512295	9525237
1/2	1/2	7/8	2-1/8	4	9525240	9501584	9504121	9507495	9509470	9512297	9525239
1/2	1/2	7/8	3-1/8	5	9525241	9581458	9504122	9507496	9586043	9512298	9583819
1/2	1/2	7/8	4-1/8	6	9525244	9581459	9504123	9507497	9509471	9585225	9525243
5/8	5/8	1	2	4	9525266	9581461	9581720	9507500	9585021	9512305	9585431
5/8	5/8	1	3	5	9525269	9581462	9581721	9584761	9585022	9512306	9525268
5/8	5/8	1	4	6	9525271	9581463	9581722	9584762	9585023	9585227	9525270
3/4	3/4	1-1/4	2	4	9525290	9501591	9581724	9584764	9585025	9512311	9525289
3/4	3/4	1-1/4	3	5	9525292	9501592	9504133	9507503	9585026	9512312	9525291
3/4	3/4	1-1/4	4	6	9525294	9581465	9504134	9507504	9585027	9512313	9525293
1	1	1-1/2	3	5	9525313	9501600	9581727	9507509	9585030	9512317	9585432
1	1	1-1/2	4	6	9525315	9581466	9581728	9584766	9585031	9585229	9525314
1	1	1-1/2	5	7	9525317	9581467	9581729	9507510	9585032	9512318	9525316



SCAN FOR SPEEDS & FEEDS

3 FLUTE HIGH PERFORMANCE

345 SERIES

Advanced Geometry; Wiper Flat, E-cut Polish and Controlled Land, will Provide Better Chip Evacuation and a Superior Part Finish

Available Upon Request:
Flats, Firm Hold Shank and Additional PVD Coatings.

N Material Code: Refer to Page 4



Exxtral Carbon® 3-4 times more tool life compared to ZrN.

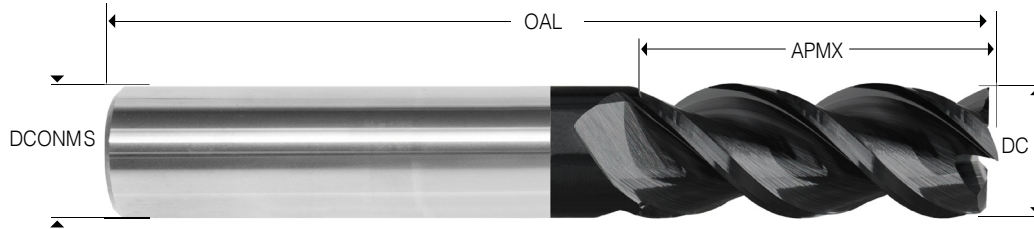

SCAN FOR SPEEDS & FEEDS

Fractional

DC	DCONMS	APMX	OAL	SQUARE	.015 RAD	.030 RAD	.060 RAD	.090 RAD	.125 RAD	BALL
1/8	1/8	1/4	1-1/2	9524614	9581429					9524615
1/8	1/8	1/2	1-1/2	9524617	9501499					9524618
3/16	3/16	5/16	2	9524627	9501501					9524628
3/16	3/16	9/16	2	9524629	9501502					9524631
1/4	1/4	3/8	2	9524632	9501503	9503998				9524633
1/4	1/4	3/4	2-1/2	9524642	9501507	9504000				9524643
1/4	1/4	1	3	9524646	9501508	9504001				9524647
1/4	1/4	1-1/4	4	9524649	9581430	9581689				9524650
5/16	5/16	1/2	2	9524652	9581431	9581690				9524653
5/16	5/16	7/8	2-1/2	9524654	9581432	9581691				9524655
5/16	5/16	1	3	9524656	9501509	9581692				9524657
5/16	5/16	1-1/4	4	9524658	9581433	9581693				9524659
3/8	3/8	1/2	2	9524660	9501510	9504002	9507401	9584980	9585199	9524662
3/8	3/8	1	2-1/2	9524671	9501512	9504004	9507403	9584982	9512177	9524672
3/8	3/8	1	3	9524673	9581435	9504005	9507404	9509433	9585201	9524674
3/8	3/8	1-1/2	4	9524676	9501513	9504006	9507405	9509434	9512178	9524677
7/16	7/16	1	2-3/4	9524681	9501514	9581695	9581968	9584983	9585202	9524682
7/16	7/16	1-1/2	4	9524683	9581436	9581696	9581969	9584984	9585203	9524684
7/16	7/16	2	4	9524685	9501516	9581697	9581970	9584985	9585204	9524686
1/2	1/2	5/8	2-1/2	9524687	9501517	9504007	9507406	9509435	9512179	9524688
1/2	1/2	1-1/4	3	9524702	9501520	9504011	9507407	9509437	9512182	9524704
1/2	1/2	1-1/2	4	9524706	9501521	9504012	9581975	9584988	9512184	9524708
1/2	1/2	2	4	9524709	9501522	9581700	9581976	9584989	9585205	9524710
1/2	1/2	2-1/2	5	9524713	9501523	9504013	9507408	9583805	9512186	9524714
1/2	1/2	1-1/2	6	9524715	9501524	9504014	9507409	9584990	9512188	9524716
1/2	1/2	3-1/8	6	9524717	9501525	9581701	9507410	9509438	9585206	9524718
5/8	5/8	3/4	3	9524719	9581439	9581702	9581977	9584991	9585207	9524720
5/8	5/8	1-1/4	3-1/2	9524727	9501526	9504015	9581981	9584995	9585211	9524728
5/8	5/8	2	4	9524731	9501527	9581706	9581982	9584996	9585212	9524732
5/8	5/8	2-1/4	5	9524733	9501528	9581707	9581983	9584997	9512189	9524734
5/8	5/8	1-1/2	6	9524735	9581443	9581708	9581984	9584998	9585213	9524736
5/8	5/8	3	6	9524738	9501529	9504016	9581985	9584999	9585214	9524739
3/4	3/4	1	3	9524741	9501530	9504017	9507411	9585000	9512190	9524743
3/4	3/4	1-5/8	4	9524753	9501532	9581710	9581988	9585003	9512194	9524754
3/4	3/4	2-1/4	5	9524755	9581446	9504022	9507415	9585004	9512195	9524756
3/4	3/4	1-1/2	6	9524758	9501533	9504023	9507416	9585005	9512197	9524760
3/4	3/4	3	6	9524762	9501534	9504024	9507417	9509440	9512198	9524763
3/4	3/4	4	7	9524764	9581447	9581711	9507418	9585006	9585215	9524765
1	1	1-1/2	4	9524773	9501536	9504025	9581989	9585007	9585216	9524774
1	1	2	4-1/2	9524775	9581448	9581712	9581991	9585009	9585218	9524777
1	1	2-1/4	5	9524779	9581451	9504028	9507419	9509441	9585220	9524780
1	1	1-1/2	6	9524781	9581452	9504029	9584752	9585012	9585221	9524782
1	1	2-5/8	6	9524783	9501538	9581714	9584753	9585013	9585222	9524784
1	1	3	6	9524785	9501539	9504030	9584754	9585014	9512200	9524786
1	1	4	7	9524787	9501540	9581715	9584755	9585015	9512201	9524788
1-1/4	1-1/4	2	4-1/2	9524790	9581453	9581716	9584756	9585016	9512202	9524791
1-1/4	1-1/4	3	6	9524792	9581454	9504031	9584757	9585017	9585223	9524793

Other Dimensions are Available Upon Request

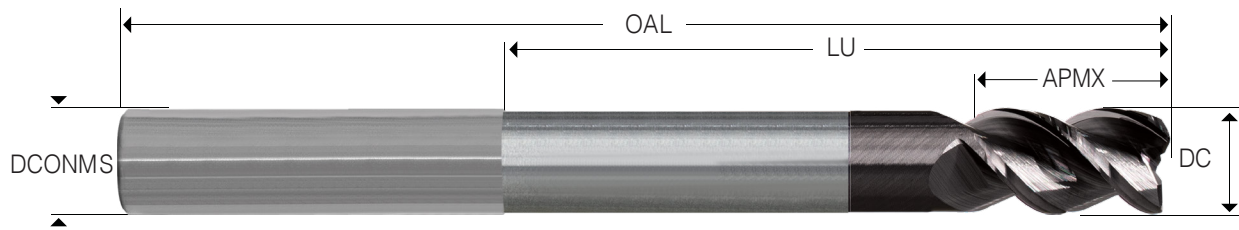

Extended Reach provides a more stable and stronger option for deep pocketing applications.

Extended Neck

DC	DCONMS	APMX	LU	OAL	SQUARE	.015 RAD	.030 RAD	.060 RAD	.090 RAD	.125 RAD	BALL
1/4	1/4	1/2	1-1/4	3	9524638	9501505	9503999	9507396			9524639
1/4	1/4	1/2	2-1/8	4	9524640	9501506	9581688	9507397			9524641
3/8	3/8	3/4	1-1/4	3	9524667	9501511	9504003	9581967	9584019	9585200	9524668
3/8	3/8	3/4	2-1/8	4	9524669	9581434	9581694	9507402	9584981	9512176	9524670
1/2	1/2	7/8	1-3/8	3	9524695	9581437	9504009	9581971	9584986	9581380	9524696
1/2	1/2	7/8	2-1/8	4	9524697	9501518	9504010	9581972	9509436	9512180	9524698
1/2	1/2	7/8	4-1/8	6	9586166	9581438	9581698	9581973	9586041	9586085	9586167
1/2	1/2	7/8	3-1/8	5	9524699	9501519	9581699	9581974	9584987	9581994	9524700
5/8	5/8	1	2	4	9585417	9581440	9581703	9581978	9584992	9585208	9585418
5/8	5/8	1	3	5	9585419	9581441	9581704	9581979	9584993	9585209	9585420
5/8	5/8	1	4	6	9524726	9581442	9581705	9581980	9584994	9585210	9585421
3/4	3/4	1-1/4	2	4	9585422	9581444	9504020	9581986	9509439	9512191	9585423
3/4	3/4	1-1/4	3	5	9524751	9581445	9504021	9507413	9585001	9512192	9585424
3/4	3/4	1-1/4	4	6	9524752	9501531	9581709	9581987	9585002	9512193	9585425
1	1	1-1/2	3	5	9585426	9501537	9504026	9581990	9585008	9585217	9585427
1	1	1-1/2	4	6	9524776	9581449	9581713	9581992	9585010	9585219	9585428
1	1	1-1/2	5	7	9585429	9581450	9504027	9581993	9585011	9512199	9585430



SCAN FOR SPEEDS & FEEDS

3 FLUTE COARSE PITCH ROUGHER

**338
SERIES**

**Coarse Pitch Design
for Heavy Roughing
Applications. Featured with
Standard Corner Radius.**

Available Upon Request:
Flats, Firm Hold Shank and
Additional PVD Coatings.

Material Code: Refer to Page 4

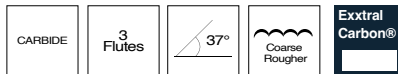

Exxtral Carbon® 3-4
times more tool life
compared to ZrN.

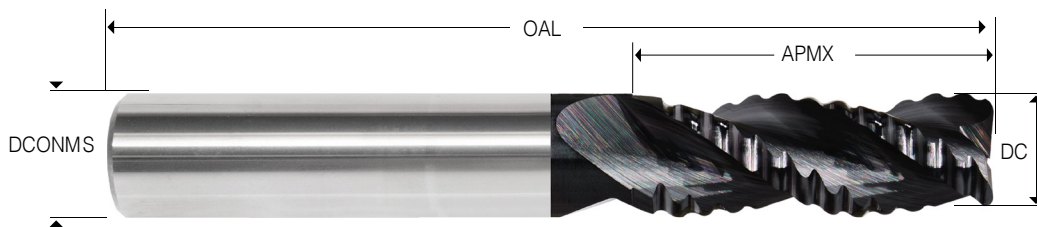

SCAN FOR SPEEDS & FEEDS

Fractional

DC	DCONMS	APMX	OAL	Radius	Part Number	Ball
1/4	1/4	3/8	2	.030	9503893	9523701
1/4	1/4	3/4	2-1/2	.030	9503898	9523707
1/4	1/4	1	3	.030	9503899	9523709
1/4	1/4	1-1/4	4	.030	9503900	9523711
5/16	5/16	1/2	2	.030	9581683	9585402
5/16	5/16	7/8	2-1/2	.030	9581684	9523714
5/16	5/16	1	3	.030	9581685	9523716
5/16	5/16	1-1/4	4	.030	9581686	9523718
3/8	3/8	1/2	2	.030	9503901	9523720
3/8	3/8	1	2-1/2	.030	9503904	9523726
3/8	3/8	1	3	.030	9503906	9523728
3/8	3/8	1-1/2	4	.030	9503907	9523730
7/16	7/16	1	2-3/4	.060	9581963	9523732
7/16	7/16	2	4	.060	9507284	9523734
1/2	1/2	5/8	2-1/2	.060	9507285	9523736
1/2	1/2	1-1/4	3	.060	9507288	9523745
1/2	1/2	1-1/2	4	.060	9507290	9523747
1/2	1/2	2	4	.060	9507291	9523749
1/2	1/2	2-1/2	5	.060	9507292	9523751
1/2	1/2	1-1/2	6	.060	9507293	9523753
1/2	1/2	3-1/8	6	.060	9507294	9523755
5/8	5/8	3/4	3	.060	9507295	9523757
5/8	5/8	1-1/4	3-1/2	.060	9507300	9523765
5/8	5/8	2	4	.060	9507301	9523767
5/8	5/8	2-1/4	5	.060	9507302	9523769
5/8	5/8	1-1/2	6	.060	9581966	9523771
5/8	5/8	3	6	.060	9507303	9523773
3/4	3/4	1	3	.090	9509407	9523775
3/4	3/4	1-1/2	4	.090	9509408	9523783
3/4	3/4	2-1/4	5	.090	9509410	9523785
3/4	3/4	1-1/2	6	.090	9509411	9523787
3/4	3/4	3	6	.090	9586039	9523789
3/4	3/4	4	7	.090	9586040	9523791
1	1	1-1/2	4	0.125	9512072	9523801
1	1	2-1/4	5	0.125	9586082	9523804
1	1	1-1/2	6	0.125	9512076	9523808
1	1	3	6	0.125	9512077	9523810
1	1	4	7	0.125	9512078	9523812
1-1/4	1-1/4	2	4-1/2	0.125	9586084	9523815
1-1/4	1-1/4	3	6	0.125	9512079	9523818

Other Dimensions are Available Upon Request

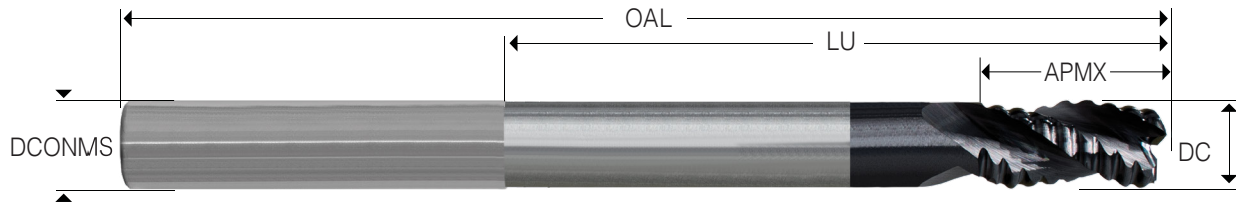

Extended Reach provides a more stable and stronger option for deep pocketing applications.

Extended Neck

DC	DCONMS	APMX	LU	OAL	Radius	Part Number	Ball
1/4	1/4	1/2	1-1/4	3	0.030	9503896	9585400
1/4	1/4	1/2	2-1/8	4	0.030	9503897	9585401
3/8	3/8	3/4	1-1/4	3	0.030	9581687	9585403
3/8	3/8	3/4	2-1/8	4	0.030	9503903	9585404
1/2	1/2	7/8	1-3/8	3	0.060	9507286	9585405
1/2	1/2	7/8	2-1/8	4	0.060	9507287	9585406
1/2	1/2	7/8	4-1/8	6	0.060	9581964	9586165
1/2	1/2	7/8	3-1/8	5	0.060	9581965	9585407
5/8	5/8	1	2	4	0.060	9507297	9585408
5/8	5/8	1	3	5	0.060	9507298	9585409
5/8	5/8	1	4	6	0.060	9507299	9585410
3/4	3/4	1-1/4	2	4	0.090	9586036	9585411
3/4	3/4	1-1/4	3	5	0.090	9586037	9585412
3/4	3/4	1-1/4	4	6	0.090	9586038	9585413
1	1	1-1/2	3	5	0.125	9586081	9585414
1	1	1-1/2	4	6	0.125	9512074	9585415
1	1	1-1/2	5	7	0.125	9586083	9585416

ALUMINUM AND NON-FERROUS ALLOYS >>> ENDMILLS



SCAN FOR SPEEDS & FEEDS

3 FLUTE CHIP BREAKER



Adapted from the 360 Series, the 363 Features an Advance Chipbreaker Design which Provided Less Machine Load and Better Chip Control

Available Upon Request: Flats, Firm Hold Shank and Additional PVD Coatings.

N Material Code: Refer to Page 4



Exxtral Carbon® 3-4 times more tool life compared to ZrN.

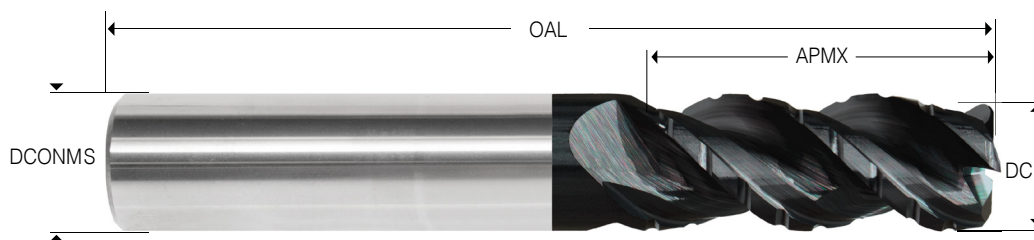

SCAN FOR SPEEDS & FEEDS

Fractional

DC	DCONMS	APMX	OAL	.030 RAD	.060 RAD	.090 RAD	.125 RAD	Ball
1/4	1/4	1/2	2	9504215	9584767			9525573
1/4	1/4	3/4	2-1/2	9504218	9507565			9525575
5/16	5/16	1/2	2	9581730	9584770			9525576
5/16	5/16	3/4	2-1/2	9581731	9584771			9525577
3/8	3/8	1/2	2	9504219	9585966			9586170
3/8	3/8	1	2-1/2	9504223	9507567			9525583
1/2	1/2	5/8	2-1/2	9504224	9584773	9585033	9585230	9525585
1/2	1/2	1-1/4	3	9504233	9507569	9586046	9512385	9586171
5/8	5/8	3/4	3	9581732	9584777	9585037	9585233	9525598
5/8	5/8	1-1/4	3-1/2	9504236	9584781	9585038	9585237	9525602
3/4	3/4	1	3		9584782	9585039	9585238	9525605
3/4	3/4	1-5/8	4		9507575	9586053	9512387	9586172
7/8	7/8	1-1/2	4		9584783	9585040	9585241	9525617
1	1	1-1/2	4		9507576	9509501	9512390	9525620

Other Dimensions are Available Upon Request

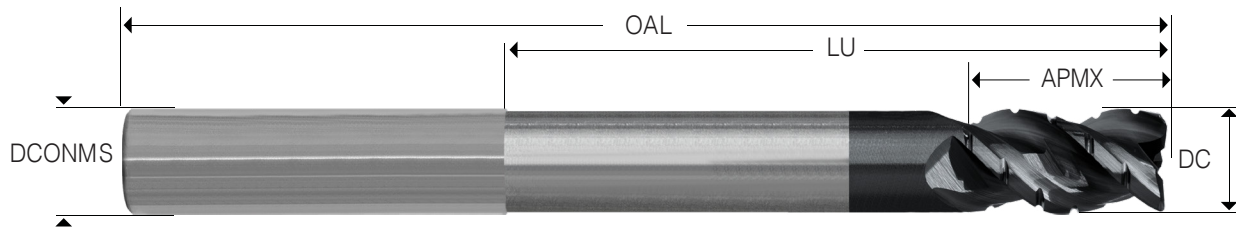

Extended Reach provides a more stable and stronger option for deep pocketing applications.

Extended Neck

DC	DCONMS	APMX	LU	OAL	.030 RAD	.060 RAD	.090 RAD	.125 RAD	Ball
1/4	1/4	1/2	1-1/4	3	9504216	9584768			9585433
1/4	1/4	1/2	2-1/8	4	9504217	9584769			9585434
3/8	3/8	3/4	1-1/4	3	9504221	9584772			9585435
3/8	3/8	3/4	2-1/8	4	9504222	9507566			9585436
1/2	1/2	7/8	1-3/8	3	9504228	9584774	9585034	9585231	9585437
1/2	1/2	7/8	2-1/8	4	9504229	9584775	9585035	9512383	9585438
1/2	1/2	7/8	4-1/8	6	9504230	9585967	9586045	9586088	9525591
1/2	1/2	7/8	3-1/8	5	9504231	9584776	9585036	9585232	9585439
5/8	5/8	1	2	4	9581733	9584778	9586047	9585234	9585440
5/8	5/8	1	3	5	9504235	9584779	9586048	9585235	9585441
5/8	5/8	1	4	6	9581734	9584780	9586049	9585236	9585442
3/4	3/4	1-1/4	2	4		9507571	9586050	9512386	9585443
3/4	3/4	1-1/4	3	5		9507572	9586051	9585239	9585444
3/4	3/4	1-1/4	4	6		9507573	9586052	9585240	9585445
1	1	1-1/2	3	5		9584784	9586054	9585242	9585446
1	1	1-1/2	4	6		9507578	9586055	9512391	9585447
1	1	1-1/2	5	7		9584785	9585041	9585243	9585448

ALUMINUM AND NON-FERROUS ALLOYS >>> ENDMILLS



SCAN FOR SPEEDS & FEEDS



N Material Code: Refer to Page 4

HPM+ in 2 flute and 3 flute are engineered specifically for applications reaching 15,000 to 30,000 RPM. The design features a special flute grind that leaves the cutter well-balanced and mirror polish on the flutes for better chip evacuation. Shrink fit style tooling only.



Exxtral Carbon® 3-4 times more tool life compared to ZrN.

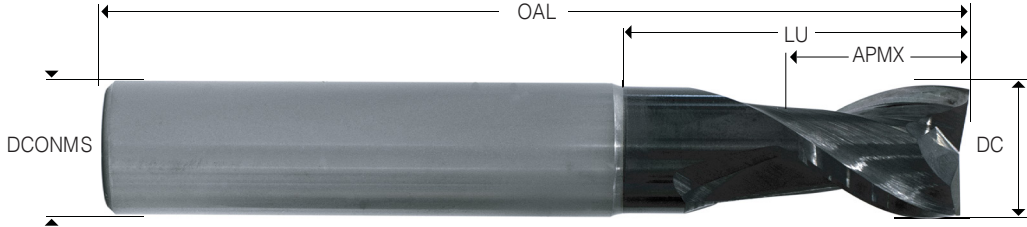

SCAN FOR SPEEDS & FEEDS

2 Flute High Performance - EdgeCut™ Extended Neck

DC	DCONMS	APMX	LU	OAL	Square	.030 RAD	.060 RAD	.125 RAD	Ball
3/8	3/8	1/2	1-1/8	3	9548328	9505718	9508642	9513518	9548329
3/8	3/8	1/2	2-1/8	4	9548330	9505719	9508643	9513520	9548331
1/2	1/2	5/8	1-3/8	3	9548334	9581902	9508645	9513521	9548335
1/2	1/2	5/8	2-1/8	4	9548338	9581903	9586012	9586113	9548339
1/2	1/2	5/8	3-3/8	6	9548342	9581904	9586013	9586114	9548343
5/8	5/8	3/4	1-5/8	4	9548344	9581905	9586014	9586115	9548345
5/8	5/8	3/4	2-3/8	5	9548346	9581906	9586015	9586116	9548347
5/8	5/8	3/4	3-3/8	6	9548348	9581907	9586016	9586117	9548349
3/4	3/4	1	2	4	9548350	9581908	9586017	9586118	9548351
3/4	3/4	1	2-1/2	5	9548352	9581909	9586018	9586119	9548353
3/4	3/4	1	3-3/8	6	9548356	9581910	9586019	9586120	9548357
1	1	1-1/4	2-5/8	5	9548358	9581911	9586020	9586121	9548359
1	1	1-1/4	3-3/8	6	9548361	9581912	9586021	9586122	9548362
1	1	1-1/4	4-3/8	7	9548364	9581913	9586022	9586123	9548365

Other Dimensions are Available Upon Request

ENDMILLS ALUMINUM AND NON-FERROUS ALLOYS



Material Code: Refer to Page 4

HPM+ in 2 flute and 3 flute are engineered specifically for applications reaching 15,000 to 30,000 RPM. The design features a special flute grind that leaves the cutter well-balanced and mirror polish on the flutes for better chip evacuation. Shrink fit style tooling only.



Extral Carbon® 3-4 times more tool life compared to ZrN.

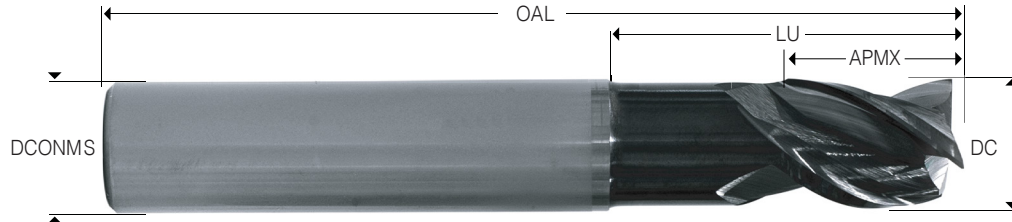

SCAN FOR SPEEDS & FEEDS

3 Flute High Performance - EdgeCut™ Extended Neck

DC	DCONMS	APMX	LU	OAL	Sqaure	.030 RAD	.060 RAD	.125 RAD	Ball
3/8	3/8	1/2	1-1/8	3	9548429	9505728	9508661	9513525	9548430
3/8	3/8	1/2	2-1/8	4	9548431	9505729	9508663	9513526	9548432
1/2	1/2	5/8	1-3/8	3	9548433	9505730	9508665	9586124	9548434
1/2	1/2	5/8	2-1/8	4	9548435	9505731	9586023	9586125	9548436
1/2	1/2	5/8	3-3/8	6	9548437	9581914	9586024	9586126	9548438
5/8	5/8	3/4	1-5/8	4	9548439	9581915	9586025	9586127	9548440
5/8	5/8	3/4	2-3/8	5	9548441	9581916	9586026	9586128	9548442
5/8	5/8	3/4	3-3/8	6	9548443	9581917	9586027	9586129	9548444
3/4	3/4	1	2	4	9548445	9581918	9586028	9586130	9548446
3/4	3/4	1	3	5	9548447	9581919	9586029	9586131	9548448
3/4	3/4	1	4	6	9548449	9581920	9586030	9586132	9548450
1	1	1-1/4	2-1/4	5	9548452	9581921	9586031	9586133	9548453
1	1	1-1/4	3-1/2	6	9548454	9581922	9586032	9586134	9548455
1	1	1-1/4	4-3/8	7	9548456	9581923	9586033	9586135	9548457

PRECISION CUTTING TOOLS CAN CUSTOMIZE THE HPM TOOLS TO YOUR SET LENGTHS

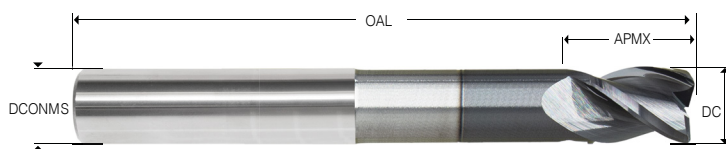

E[SPECIALY]
MADE FOR YOU

4 FLUTE VARIABLE

451 SERIES

Variable Design Allows for Chatter Free Machining at higher Speed and Feeds. Ideal for Heavy Profile and Slotting applications

Available Upon Request:
Flats, Firm Hold Shank and
Additional PVD Coatings.

P M K Material Code: Refer to Page 4

CARBIDE

4
Flutes

38°

Vulcan®

Vulcan® Coating Nanolayered structure provides exceptional wear resistance and lubricity

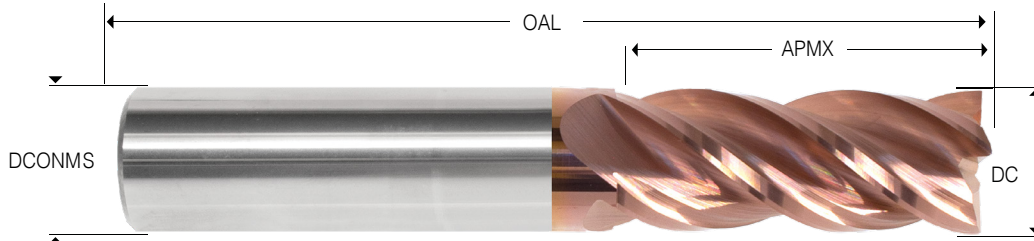

SCAN FOR SPEEDS & FEEDS

Fractional

DC	DCONMS	APMX	OAL	Square	.015 RAD	.030 RAD	.060 RAD	.090 RAD	.125 RAD	Ball
1/8	1/8	1/2	1-1/2	9500254	9500005	9500065				9500253
3/16	3/16	5/8	2	9500256	9500006	9500066				9500255
1/4	1/4	3/8	2	9500258	9500007	9500067	9500125			9500257
1/4	1/4	3/4	2-1/2	9500264	9500010	9500070	9500128			9500263
1/4	1/4	1	3	9500266	9500011	9500071	9500129			9500265
1/4	1/4	1-1/4	4	9500268	9500012	9500072	9500130			9500267
1/4	1/4	1-3/4	4	9500270	9500013	9500073	9500131			9500269
5/16	5/16	1/2	2	9500272	9500014	9500074	9500132			9500271
5/16	5/16	7/8	2-1/2	9500274	9500015	9500075	9500133			9500273
5/16	5/16	1	3	9500276	9500016	9500076	9500134			9500275
5/16	5/16	1-1/4	4	9500278	9500017	9500077	9500135			9500277
5/16	5/16	1-5/8	4	9500280	9500018	9500078	9500136			9500279
3/8	3/8	1/2	2	9500282	9500019	9500079	9500137			9500281
3/8	3/8	1	2-1/2	9500288	9500022	9500082	9500140			9500287
3/8	3/8	1	3	9500290	9500023	9500083	9500141			9500289
3/8	3/8	1-1/2	4	9500292	9500024	9500084	9500142			9500291
3/8	3/8	2-1/2	5	9500294	9500025	9500085	9500143			9500293
7/16	7/16	5/8	2-3/4	9500296	9500026	9500086	9500144			9500295
7/16	7/16	1	2-3/4	9500298	9500027	9500087	9500145			9500297
7/16	7/16	1-1/2	4	9500300	9500028	9500088	9500146			9500299
7/16	7/16	3	6	9500302	9500029	9500089	9500147			9500301
1/2	1/2	5/8	2-1/2	9500304	9500030	9500090	9500148	9500183	9500218	9500303
1/2	1/2	1	3	9500312	9500034	9500094	9500152	9500187	9500222	9500311
1/2	1/2	1-1/4	3	9500314	9500035	9500095	9500153	9500188	9500223	9500313
1/2	1/2	1-1/2	4	9500316	9500036	9500096	9500154	9500189	9500224	9500315
1/2	1/2	2	4	9500318	9500037	9500097	9500155	9500190	9500225	9500317
1/2	1/2	2-1/2	5	9500320	9500038	9500098	9500156	9500191	9500226	9500319
1/2	1/2	3	6	9500322	9500039	9500099	9500157	9500192	9500227	9500321
5/8	5/8	3/4	3	9500324	9500040	9500100	9500158	9500193	9500228	9500323
5/8	5/8	1-1/4	3-1/2	9500332	9500044	9500104	9500162	9500197	9500232	9500331
5/8	5/8	1-3/4	4	9500334	9500045	9500105	9500163	9500198	9500233	9500333
5/8	5/8	2-1/4	5	9500336	9500046	9500106	9500164	9500199	9500234	9500335
5/8	5/8	3	6	9500338	9500047	9500107	9500165	9500200	9500235	9500337
3/4	3/4	7/8	3	9500340	9500048	9500108	9500166	9500201	9500236	9500339
3/4	3/4	1-1/2	4	9500348	9500052	9500112	9500170	9500205	9500240	9500347
3/4	3/4	1-5/8	4	9500350	9500053	9500113	9500171	9500206	9500241	9500349
3/4	3/4	2-1/4	5	9500352	9500054	9500114	9500172	9500207	9500242	9500351
3/4	3/4	3	6	9500354	9500055	9500115	9500173	9500208	9500243	9500353
3/4	3/4	4	7	9500356	9500056	9500116	9500174	9500209	9500244	9500355
1	1	1-1/2	4	9500358	9500057	9500117	9500175	9500210	9500245	9500357
1	1	2	4-1/2	9500366	9500061	9500121	9500179	9500214	9500249	9500365
1	1	2-1/4	5	9500368	9500062	9500122	9500180	9500215	9500250	9500367
1	1	3	6	9500370	9500063	9500123	9500181	9500216	9500251	9500369
1	1	4	7	9500372	9500064	9500124	9500182	9500217	9500252	9500371

Other Dimensions are Available Upon Request

ENDMILLS

FERROUS AND EXOTIC ALLOYS



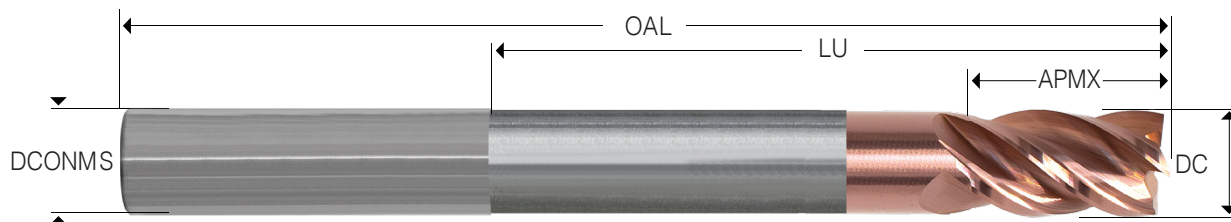

Extended Reach provides a more stable and stronger option for deep pocketing applications.

Extended Neck

DC	DCONMS	APMX	LU	OAL	Sqaure	.015 RAD	.030 RAD	.060 RAD	.090 RAD	.125 RAD	Ball
1/4	1/4	1/2	1-1/4	3	9500260	9500008	9500068	9500126			9500259
1/4	1/4	1/2	2-1/8	4	9500262	9500009	9500069	9500127			9500261
3/8	3/8	3/4	1-1/4	3	9500284	9500020	9500080	9500138			9500283
3/8	3/8	3/4	2-1/8	4	9500286	9500021	9500081	9500139			9500285
1/2	1/2	7/8	1-3/8	3	9500306	9500031	9500091	9500149	9500184	9500219	9500305
1/2	1/2	7/8	2-1/8	4	9500308	9500032	9500092	9500150	9500185	9500220	9500307
1/2	1/2	7/8	3-1/8	5	9586177	9581505	9504759	9507951	9586058	9586091	9529326
1/2	1/2	7/8	4-1/8	6	9500310	9500033	9500093	9500151	9500186	9500221	9500309
5/8	5/8	1	2	4	9500326	9500041	9500101	9500159	9500194	9500229	9500325
5/8	5/8	1	3	5	9500328	9500042	9500102	9500160	9500195	9500230	9500327
5/8	5/8	1	4	6	9500330	9500043	9500103	9500161	9500196	9500231	9500329
3/4	3/4	1-1/4	2	4	9500342	9500049	9500109	9500167	9500202	9500237	9500341
3/4	3/4	1-1/4	3	5	9500344	9500050	9500110	9500168	9500203	9500238	9500343
3/4	3/4	1-1/4	4	6	9500346	9500051	9500111	9500169	9500204	9500239	9500345
1	1	1-1/2	3	5	9500360	9500058	9500118	9500176	9500211	9500246	9500359
1	1	1-1/2	4	6	9500362	9500059	9500119	9500177	9500212	9500247	9500361
1	1	1-1/2	5	7	9500364	9500060	9500120	9500178	9500213	9500248	9500363

*Customers may receive Varianta Supral (Gray) coated tools until stock is depleted

NEW
COATING UPGRADE



SCAN FOR SPEEDS & FEEDS

4 FLUTE VARIABLE

452 SERIES

Variable Indexed with Eccentric OD; Provides a Tougher Cutting Edge for Chatter Free Machining and Maximum Metal Removal Rates

P M K S Material Code: Refer to Page 4

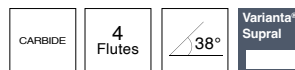

Varianta[®] Supral Provides a low coefficient of friction, reducing tool wear and resulting in a longer tool life.

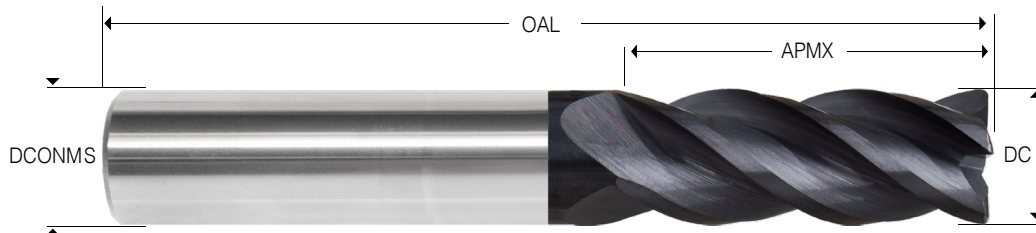

SCAN FOR SPEEDS & FEEDS

Fractional

DC	DCONMS	APMX	OAL	Sqaure	.015 RAD	.030 RAD	.060 RAD	.090 RAD	.125 RAD	Ball
1/4	1/4	3/8	2	9529720	9581507	9504848	9584823			9585509
1/4	1/4	3/4	2-1/2	9529723	9581510	9581792	9584826			9529722
1/4	1/4	1	3	9585515	9502027	9581793	9584827			9585514
1/4	1/4	1-1/4	4	9529724	9581511	9581794	9584828			9585516
1/4	1/4	1-3/4	4	9529725	9581512	9581795	9584829			9585517
5/16	5/16	1/2	2	9585519	9502028	9581796	9584830			9585518
5/16	5/16	7/8	2-1/2	9529727	9502029	9581797	9584831			9529726
5/16	5/16	1	3	9585521	9502030	9581798	9584832			9585520
5/16	5/16	1-1/4	4	9529728	9581513	9581799	9584833			9585522
5/16	5/16	1-5/8	4	9529729	9581514	9581800	9584834			9585523
3/8	3/8	1/2	2	9529730	9502031	9504850	9584835			9585524
3/8	3/8	1	2-1/2	9529733	9502032	9581803	9584838			9529732
3/8	3/8	1	3	9585529	9502033	9581804	9584839			9585528
3/8	3/8	1-1/2	4	9584157	9502034	9581805	9584840			9585530
3/8	3/8	2-1/2	5	9585532	9581517	9581806	9584841			9585531
7/16	7/16	5/8	2-3/4	9585534	9502035	9504851	9584842			9585533
7/16	7/16	1	2-3/4	9585536	9581518	9581807	9584843			9585535
7/16	7/16	1-1/2	4	9585537	9502036	9581808	9584844			9529735
7/16	7/16	3	6	9585539	9581519	9581809	9584845			9585538
1/2	1/2	5/8	2-1/2	9529736	9581520	9581810	9584846	9585074	9585272	9585540
1/2	1/2	1	3	9529738	9502037	9504853	9584850	9585078	9585276	9529737
1/2	1/2	1-1/4	3	9529739	9502039	9504854	9508001	9509701	9585277	9585547
1/2	1/2	1-1/2	4	9529740	9581525	9504856	9584851	9585079	9585278	9585548
1/2	1/2	2	4	9529741	9581526	9581815	9585984	9509702	9585279	9585549
1/2	1/2	2-1/2	5	9585551	9502040	9504857	9584852	9585080	9585280	9585550
1/2	1/2	3	6	9585553	9581527	9581816	9584853	9585081	9585281	9585552
5/8	5/8	3/4	3	9585555	9581528	9581817	9584854	9585082	9585282	9585554
5/8	5/8	1-1/4	3-1/2	9529747	9581532	9581821	9584858	9585086	9585286	9529746
5/8	5/8	1-3/4	4	9585562	9581533	9581822	9584859	9585087	9585287	9585561
5/8	5/8	2-1/4	5	9585563	9581534	9504858	9584860	9585088	9585288	9529748
5/8	5/8	3	6	9585565	9581535	9581823	9508002	9585089	9586093	9585564
3/4	3/4	7/8	3	9585567	9502041	9581824	9584861	9585090	9585289	9585566
3/4	3/4	1-1/2	4	9529750	9581539	9581828	9584865	9585094	9585293	9529749
3/4	3/4	1-5/8	4	9529752	9581540	9504860	9508003	9585095	9585294	9585574
3/4	3/4	2-1/4	5	9529755	9581541	9504862	9584866	9585096	9585295	9585575
3/4	3/4	3	6	9529757	9502043	9504864	9508004	9585097	9585296	9585576
3/4	3/4	4	7	9529760	9502044	9581829	9584867	9585098	9585297	9585577
1	1	1-1/2	4	9585579	9581542	9581830	9584868	9585099	9585298	9585578
1	1	2	4-1/2	9585587	9581545	9581834	9584872	9585103	9585302	9585586
1	1	2-1/4	5	9585589	9581546	9581835	9584873	9585104	9585303	9585588
1	1	3	6	9585591	9581547	9581836	9584874	9585105	9585304	9585590
1	1	4	7	9585593	9581548	9581837	9584875	9585106	9585305	9585592

Other Dimensions are Available Upon Request

ENDMILLS

FERROUS AND EXOTIC ALLOYS

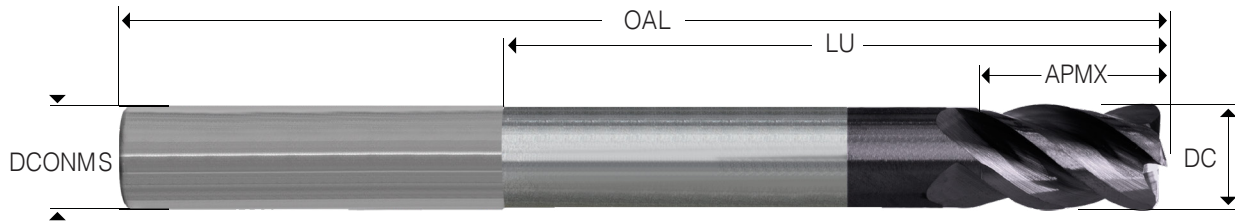

Extended Neck

Extended Reach provides a more stable and stronger option for deep pocketing applications.

DC	DCONMS	APMX	LU	OAL	Sqaure	.015 RAD	.030 RAD	.060 RAD	.090 RAD	.125 RAD	Ball
1/4	1/4	1/2	1-1/4	3	9585511	9581508	9581790	9584824			9585510
1/4	1/4	1/2	2-1/8	4	9585513	9581509	9581791	9584825			9585512
3/8	3/8	3/4	1-1/4	3	9585526	9581515	9581801	9584836			9585525
3/8	3/8	3/4	2-1/8	4	9585527	9581516	9581802	9584837			9529731
1/2	1/2	7/8	1-3/8	3	9585542	9581521	9581811	9584847	9585075	9585273	9585541
1/2	1/2	7/8	2-1/8	4	9585544	9581522	9581812	9584848	9585076	9585274	9585543
1/2	1/2	7/8	3-1/8	5	9586179	9581523	9581813	9585983	9586059	9586092	9586178
1/2	1/2	7/8	4-1/8	6	9585546	9581524	9581814	9584849	9585077	9585275	9585545
5/8	5/8	1	2	4	9585556	9581529	9581818	9584855	9585083	9585283	9529745
5/8	5/8	1	3	5	9585558	9581530	9581819	9584856	9585084	9585284	9585557
5/8	5/8	1	4	6	9585560	9581531	9581820	9584857	9585085	9585285	9585559
3/4	3/4	1-1/4	2	4	9585569	9581536	9581825	9584862	9585091	9585290	9585568
3/4	3/4	1-1/4	3	5	9585571	9581537	9581826	9584863	9585092	9585291	9585570
3/4	3/4	1-1/4	4	6	9585573	9581538	9581827	9584864	9585093	9585292	9585572
1	1	1-1/2	3	5	9585581	9502045	9581831	9584869	9585100	9585299	9585580
1	1	1-1/2	4	6	9585583	9581543	9581832	9584870	9585101	9585300	9585582
1	1	1-1/2	5	7	9585585	9581544	9581833	9584871	9585102	9585301	9585584



SCAN FOR SPEEDS & FEEDS

5 FLUTE VARIABLE



Variable Indexed with Eccentric OD; Provides a Tougher Cutting Edge for Chatter Free Machining and Maximum Metal Removal Rates

Available Upon Request:
Flats, Firm Hold Shank and
Additional PVD Coatings.

P M K S Material Code: Refer to Page 4



Exxtral Silver® is ideal for machining abrasive and gummy materials.

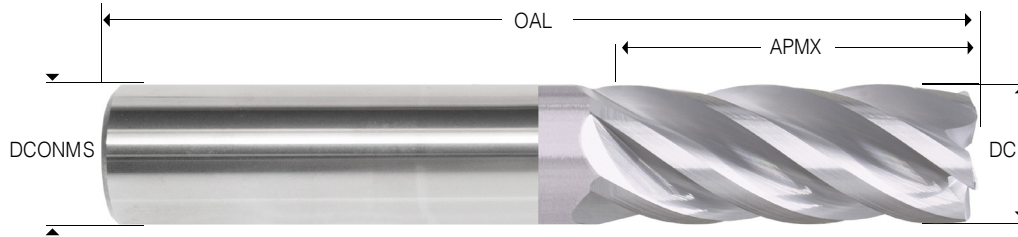

SCAN FOR SPEEDS & FEEDS

Fractional

DC	DCONMS	APMX	OAL	Square	.015 RAD	.030 RAD	.060 RAD	.090 RAD	.125 RAD	.188 RAD	.250 RAD	Ball
1/4	1/4	1/2	2	9531113	9502272	9505225	9508248					9531115
1/4	1/4	3/4	2-1/2	9531118	9502274	9505228	9508252					9531120
1/4	1/4	1	3	9531123	9502275	9505229	9508254					9531125
1/4	1/4	1-1/2	4	9531130	9585960	9585963	9585992					9531131
1/4	1/4	2	4	9531133	9581559	9581848	9585993					9586186
5/16	5/16	1/2	2	9531134	9502278	9505233	9508255					9531136
5/16	5/16	7/8	2-1/2	9531138	9502280	9505237	9508258					9531140
5/16	5/16	1-1/4	3	9531143	9502282	9505239	9585996					9531144
5/16	5/16	1-5/8	4	9531149	9581562	9581851	9585997					9586190
5/16	5/16	2-1/8	4	9586191	9581563	9581852	9508260					9586192
3/8	3/8	1/2	2	9531153	9502287	9505242	9508261	9509827	9586099			9531157
3/8	3/8	1	2-1/2	9531173	9502296	9505251	9508271	9509830	9512996			9531175
3/8	3/8	1	3	9531177	9502298	9505252	9508272	9509831	9512997			9531179
3/8	3/8	1-1/2	4	9531184	9502300	9505256	9508277	9509832	9513001			9531186
3/8	3/8	2	4	9531187	9581567	9505258	9585998	9586065	9586100			9586194
3/8	3/8	2-1/2	6	9586195	9581568	9581854	9585999	9586066	9586101			9586196
7/16	7/16	1	2-3/4	9531189	9502301	9505260	9584892	9587587	9586975			9531191
7/16	7/16	2	4	9531201	9502302	9505263	9584893	9586988	9586986			9531202
1/2	1/2	5/8	2-1/2	9531203	9502303	9505264	9508284	9509833	9513004			9531205
1/2	1/2	1-1/4	3	9531233	9502317	9505284	9508297	9509839	9513016			9531236
1/2	1/2	1-5/8	4	9531247	9502321	9505289	9508301	9586069	9513024			9531249
1/2	1/2	2	4	9531253	9502322	9505290	9508302	9509841	9513027			9531255
1/2	1/2	2-1/2	5	9531259	9502323	9505292	9508304	9585124	9513030			9531261
1/2	1/2	3-1/8	6	9531262	9502324	9505293	9508305	9585125	9513032			9531265
5/8	5/8	3/4	3	9531266	9502325	9505294	9508307	9509842	9513034			9531267
5/8	5/8	1-5/8	3-1/2	9531282	9502329	9505314	9508315	9509847	9513042			9531284
5/8	5/8	2-1/8	4	9531288	9581576	9581860	9586004	9586071	9513043			9586203
5/8	5/8	2-1/2	5	9531289	9502331	9505320	9508316	9509849	9583918			9531291
5/8	5/8	3	6	9531293	9502333	9505322	9508317	9509850	9513045			9531294
3/4	3/4	1	3	9531299	9502334	9505329	9508319	9509851	9513048	9586136	9516137	9531301
3/4	3/4	1-5/8	4	9531334	9502338	9505344	9508332	9509857	9513062	9514678	9516142	9531337
3/4	3/4	2-1/4	5	9531346	9502342	9505348	9508335	9509859	9513068	9514679	9516145	9531348
3/4	3/4	3-1/4	6	9531357	9502346	9505354	9508337	9509860	9513071	9586141	9516146	9531360
3/4	3/4	4-1/8	7	9586207	9581582	9581864	9586007	9586074	9586107	9514681	9516149	9586208
1	1	1-1/2	4	9531394	9502357	9505368	9508348	9509867	9513085	9514682	9516153	9531396
1	1	2	4-1/2	9531409	9502360	9505375	9508358	9509870	9513092	9514685	9516154	9531412
1	1	2-1/4	5	9531418	9502361	9505379	9508362	9509871	9513095	9586147	9516158	9531420
1	1	2-5/8	6	9531421	9502362	9505382	9508365	9509872	9513097	9586148	9516160	9531422
1	1	3-1/4	6	9531424	9502363	9505383	9508366	9509873	9513098	9586149	9516164	9531425
1	1	4-1/8	7	9531428	9502364	9505384	9508367	9509874	9513101	9586150	9516167	9531429
1-1/4	1-1/4	2	4-1/2	9531436	9502366	9505386	9508370	9509875	9513103	9586151	9516168	9531437
1-1/4	1-1/4	3	6	9531438	9502367	9505388	9508372	9509876	9513105	9586152	9516171	9531439

Other Dimensions & Radii are Available Upon Request

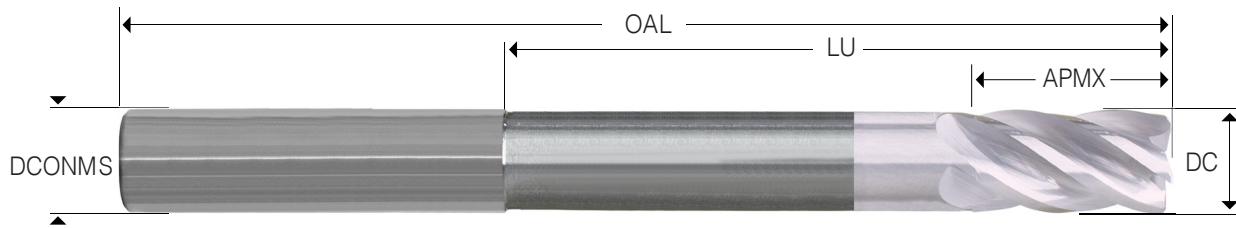

Extended Reach provides a more stable and stronger option for deep pocketing applications.

Extended Neck

DC	DCONMS	APMX	LU	OAL	Square	.015 RAD	.030 RAD	.060 RAD	.090 RAD	.125 RAD	.188 RAD	.250 RAD	Ball
1/4	1/4	1/2	1-1/4	3	9531116	9502273	9505226	9508250					9585608
1/4	1/4	1/2	2-1/8	4	9585609	9581556	9505227	9508251					9585610
1/4	1/4	1/2	3-1/8	5	9586183	9581557	9581846	9585990					9586184
1/4	1/4	1/2	4-1/8	6	9531117	9581558	9581847	9585991					9586185
1/4	1/4	9/16	2-1/8	4	9531137	9581560	9581849	9585994					9586187
1/4	1/4	9/16	4-1/8	6	9586188	9581561	9581850	9585995					9586189
3/8	3/8	3/4	1-1/4	3	9531166	9502295	9505248	9508267					9531167
3/8	3/8	3/4	2-1/8	4	9531168	9581564	9581853	9508268					9531169
3/8	3/8	3/4	3-1/8	5	9586193	9581565	9505249	9508269					9531170
3/8	3/8	3/4	4-1/8	6	9531171	9581566	9505250	9508270					9531172
1/2	1/2	7/8	1-3/8	3	9531221	9502312	9505277	9584894	9585122	9585326			9585611
1/2	1/2	7/8	2-1/8	4	9531222	9502314	9505278	9508291	9585123	9513009			9531223
1/2	1/2	7/8	3-1/8	5	9531224	9581569	9505279	9586000	9509836	9513011			9531225
1/2	1/2	7/8	4-1/8	6	9531226	9502315	9581855	9508292	9509837	9513012			9531227
1/2	1/2	7/8	5-1/8	7	9586197	9581570	9581856	9586001	9586067	9586102			9586198
1/2	1/2	7/8	6-1/8	8	9586199	9581571	9581857	9586002	9586068	9586103			9586200
5/8	5/8	1	2	4	9531277	9581572	9581858	9584895	9585126	9513037			9585612
5/8	5/8	1	3	5	9531278	9581573	9505304	9508312	9585127	9513038			9585613
5/8	5/8	1	4	6	9531279	9581574	9505306	9584896	9585128	9585327			9585614
5/8	5/8	1	6	8	9586201	9581575	9581859	9586003	9586070	9586104			9586202
3/4	3/4	1-1/4	2	4	9531318	9581577	9581861	9584897	9585129	9513055	9586137	9586153	9585615
3/4	3/4	1-1/4	3	5	9531320	9581578	9505340	9508329	9585130	9513057	9514677	9516139	9531321
3/4	3/4	1-1/4	4	6	9531323	9581579	9505341	9508330	9509855	9513058	9586138	9586154	9531324
3/4	3/4	1-1/4	5	7	9531325	9581580	9581862	9586005	9586072	9586105	9586139	9586155	9586204
3/4	3/4	1-1/4	6	8	9586205	9581581	9581863	9586006	9586073	9586106	9586140	9586156	9586206
1	1	1-1/2	2	4	9586209	9581583	9581865	9586008	9586075	9586108	9586142	9586157	9586210
1	1	1-1/2	3	5	9531398	9581584	9505369	9508349	9585131	9513087	9586143	9586158	9531399
1	1	1-1/2	4	6	9531402	9502358	9505370	9508352	9585132	9513089	9586144	9586159	9531403
1	1	1-1/2	5	7	9531406	9581585	9581866	9508354	9585133	9585328	9586145	9586160	9585616
1	1	1-1/2	6	8	9586211	9581586	9581867	9508356	9586076	9586109	9586146	9586161	9586212

FERROUS AND EXOTIC ALLOYS

ENDMILLS



SCAN FOR SPEEDS & FEEDS

5 FLUTE VARIABLE

577 SERIES

HEM / Dynamic Milling and Finishing.
Increased cutter stability and reduced chatter. Has perfect balance of hardness and toughness

Available Upon Request:
Flats, Firm Hold Shank and Additional PVD Coatings.

P M K S Material Code: Refer to Page 4

CARBIDE 5 Flutes 38° Vulcan® Coating Nanolayered structure provides exceptional wear resistance and lubricity

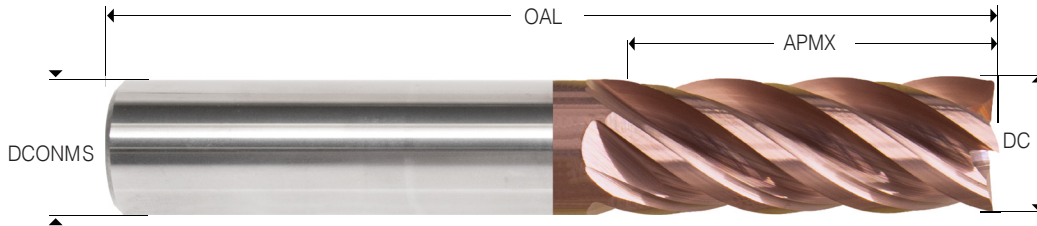

SCAN FOR SPEEDS & FEEDS

Fractional

DC	DCONMS	APMX	OAL	Square	.015 RAD	.030 RAD	.060 RAD	.090 RAD	.125 RAD	Ball
1/4	1/4	1/2	2	9584054	9584059	9584060	9584061			9584058
1/4	1/4	3/4	2-1/2	9584053	9584105	9584251	9584337			9584576
1/4	1/4	1	3	9584577	9584168	9584252	9584338			9584578
3/8	3/8	1/2	2	9584579	9584169	9584257	9584339	9584419	9584494	9584583
3/8	3/8	1	2-1/2	9584584	9584171	9584258	9584340	9584420	9584495	9584585
3/8	3/8	1	3	9584586	9584172	9584259	9584341	9584421	9584496	9584590
3/8	3/8	1-1/2	4	9584591	9584173	9584260	9584342	9584422	9584500	9584592
1/2	1/2	5/8	2-1/2	9584593	9584174	9584261	9584345	9584424	9584501	9584594
1/2	1/2	1-1/4	3	9584598	9584179	9505397	9584346	9584425	9584502	9584599
1/2	1/2	1-5/8	4	9584600	9584180	9584265	9584347	9584426	9584503	9584601
1/2	1/2	2	4	9584602	9584181	9584266	9584348	9584428	9584505	9584603
1/2	1/2	2-1/2	5	9584606	9584182	9584267	9584349	9584429	9584507	9584607
1/2	1/2	3-1/8	6	9584608	9584183	9584271	9584350	9584430	9584508	9584609
5/8	5/8	3/4	3	9584610	9584187	9505398	9584353	9584431	9584509	9584611
5/8	5/8	1-5/8	3-1/2	9584614	9584188	9505399	9584354	9584436	9513108	9584615
5/8	5/8	2-1/2	5	9584616	9584189	9584272	9584355	9584437	9584514	9584617
5/8	5/8	3	6	9584618	9584190	9584273	9584356	9584438	9584515	9584619
3/4	3/4	1	3	9584620	9584194	9584277	9584357	9584439	9584516	9584621
3/4	3/4	1-5/8	4	9584630	9584195	9505400	9584358	9584440	9584517	9584631
3/4	3/4	2-1/4	5	9584632	9584196	9584278	9584359	9584444	9584518	9584633
3/4	3/4	3-1/4	6	9584634	9584197	9584279	9584360	9584445	9584522	9584635
3/4	3/4	4-1/8	7	9584636	9584198	9584280	9584369	9584446	9584523	9584637
1	1	1-1/2	4	9584638	9584202	9584285	9584370	9584447	9584524	9584639
1	1	2	4-1/2	9584646	9584203	9584286	9584371	9584451	9584525	9584647
1	1	2-1/4	5	9584648	9584204	9584287	9584372	9584452	9584529	9584649
1	1	3-1/4	6	9584650	9584205	9584288	9584373	9584453	9584530	9584651
1	1	4-1/8	7	9584652	9584206	9584289	9584374	9584454	9584531	9584653

Other Dimensions & Radii are Available Upon Request

NEW
NEXT GENERATION ENDMILLS

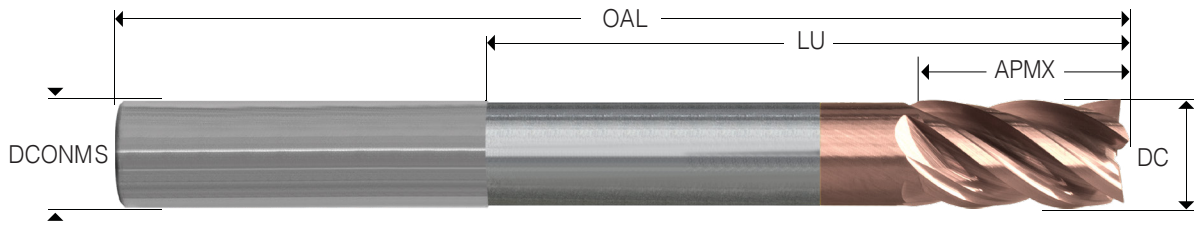

Extended Neck

DC	DCONMS	APMX	LU	OAL	Sqaure	.015 RAD	.030 RAD	.060 RAD	.090 RAD	.125 RAD	Ball
1/4	1/4	1/2	2-1/8	4	9584343	9584160	9584207	9584247			9584344
3/8	3/8	3/4	2-1/8	4	9584351	9584170	9584211	9584249			9584352
1/2	1/2	7/8	1-3/8	3	9584361	9584175	9584216	9584253	9584281	9584312	9584362
1/2	1/2	7/8	2-1/8	4	9584363	9584176	9584217	9584254	9584282	9584313	9584364
1/2	1/2	7/8	4-1/8	6	9584367	9584177	9584219	9584255	9584283	9584314	9584366
1/2	1/2	7/8	3-1/8	5	9584365	9584178	9584218	9584256	9584284	9584315	9584368
5/8	5/8	1	2	4	9584379	9584184	9584225	9584262	9584290	9584320	9584380
5/8	5/8	1	3	5	9584381	9584185	9584226	9584263	9584291	9584321	9584382
5/8	5/8	1	4	6	9584383	9584186	9584227	9584264	9584292	9584322	9584384
3/4	3/4	1-1/4	2	4	9584392	9584191	9584232	9584268	9584297	9584327	9584393
3/4	3/4	1-1/4	3	5	9584394	9584192	9584233	9584269	9584298	9584328	9584395
3/4	3/4	1-1/4	4	6	9584396	9584193	9584234	9584270	9584299	9584329	9584397
1	1	1-1/2	3	5	9584408	9584199	9584240	9584274	9584304	9584334	9584409
1	1	1-1/2	4	6	9584410	9584200	9584241	9584275	9584305	9584335	9584411
1	1	1-1/2	5	7	9584412	9584201	9584242	9584276	9584306	9584336	9584413



SCAN FOR SPEEDS & FEEDS

6 FLUTE VARIABLE

677 SERIES

HEM / Dynamic Milling and Finishing. Increased cutter stability and reduced chatter. Has perfect balance of hardness and toughness

Available Upon Request:
Flats, Firm Hold Shank and Additional PVD Coatings.

P M K S Material Code: Refer to Page 4

CARBIDE

6 Flutes

138°

Vulcan®

Vulcan® Coating Nanolayered structure provides exceptional wear resistance and lubricity

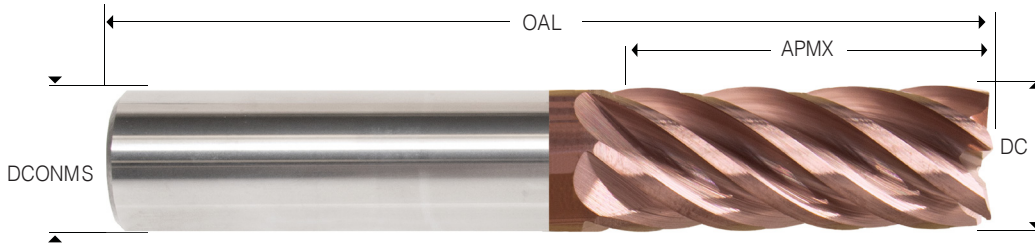

SCAN FOR SPEEDS & FEEDS

Fractional

DC	DCONMS	APMX	OAL	Square	.015 RAD	.030 RAD	.060 RAD	.090 RAD	.125 RAD	Ball
1/4	1/4	1/2	2	9584660	9584208	9584293	9584375			9584661
1/4	1/4	3/4	2-1/2	9584662	9584209	9584294	9584376			9584663
1/4	1/4	1	3	9584664	9584210	9584295	9584377			9584665
3/8	3/8	1/2	2	9584666	9584212	9584296	9584378	9584455	9584532	9584667
3/8	3/8	1	2-1/2	9584668	9584213	9584300	9584385	9584459	9584533	9584669
3/8	3/8	1	3	9584676	9584214	9584301	9584386	9584460	9584537	9584677
3/8	3/8	1-1/2	4	9584678	9584215	9584302	9584387	9584461	9584538	9584679
1/2	1/2	5/8	2-1/2	9584680	9584220	9584303	9584388	9584462	9584539	9584681
1/2	1/2	1-1/4	3	9532344	9584221	9505495	9508424	9584463	9584540	9532345
1/2	1/2	1-5/8	4	9584682	9584222	9584307	9584389	9584465	9584541	9584683
1/2	1/2	2	4	9584684	9584223	9584308	9584390	9584466	9584546	9584685
1/2	1/2	2-1/2	5	9584686	9584224	9584309	9584391	9584467	9584547	9584687
1/2	1/2	3-1/8	6	9584688	9584228	9584310	9584398	9584469	9584548	9584689
5/8	5/8	3/4	3	9584690	9584229	9584311	9584399	9584470	9584549	9584691
5/8	5/8	1-5/8	3-1/2	9584692	9584230	9584316	9584400	9584471	9584550	9584693
5/8	5/8	2-1/2	5	9584694	9584231	9584317	9584401	9584472	9584554	9584695
5/8	5/8	3	6	9584696	9584235	9584318	9584402	9584477	9584555	9584697
3/4	3/4	1	3	9584698	9584236	9505497	9584403	9584478	9584556	9584699
3/4	3/4	1-5/8	4	9584700	9584237	9584319	9584404	9584479	9584557	9584701
3/4	3/4	2-1/4	5	9584702	9584238	9584323	9584405	9584480	9584561	9584703
3/4	3/4	3-1/4	6	9584704	9584239	9584324	9584406	9584481	9584562	9584705
3/4	3/4	4-1/8	7	9584706	9584243	9584325	9584407	9584485	9584563	9584707
1	1	1-1/2	4	9584708	9584244	9584326	9584414	9584486	9584564	9584709
1	1	2	4-1/2	9584710	9584245	9584330	9584415	9584487	9584565	9584711
1	1	2-1/4	5	9584712	9584246	9584331	9584416	9584488	9584569	9584713
1	1	3-1/4	6	9584714	9584248	9584332	9584417	9584492	9584570	9584715
1	1	4-1/8	7	9584716	9584250	9584333	9584418	9584493	9584571	9584717

Other Dimensions & Radii are Available Upon Request

NEW
NEXT GENERATION ENDMILLS

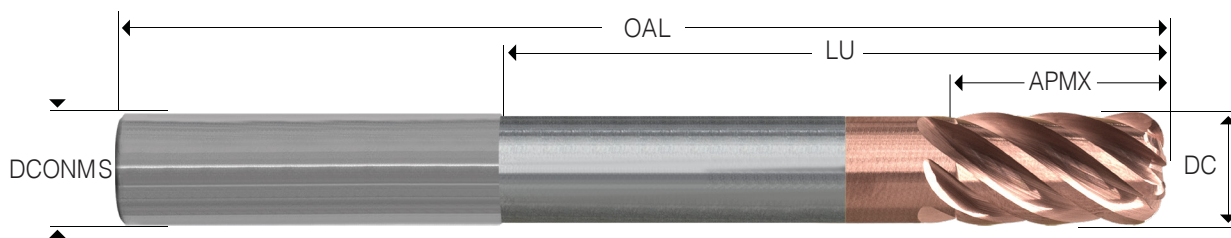

Extended Reach provides a more stable and stronger option for deep pocketing applications.

Extended Neck

DC	DCONMS	APMX	LU	OAL	Sqaure	.015 RAD	.030 RAD	.060 RAD	.090 RAD	.125 RAD	Ball
1/4	1/4	1/2	2-1/8	4	9584604	9584423	9584464	9584504			9584605
3/8	3/8	3/4	2-1/8	4	9584612	9584427	9584468	9584506			9584613
1/2	1/2	7/8	1-3/8	3	9584622	9584432	9584473	9584510	9584542	9584572	9584623
1/2	1/2	7/8	2-1/8	4	9584624	9584433	9584474	9584511	9584543	9584573	9584625
1/2	1/2	7/8	3-1/8	5	9584626	9584434	9584475	9584512	9584544	9584574	9584627
1/2	1/2	7/8	4-1/8	6	9584628	9584435	9584476	9584513	9584545	9584575	9584629
5/8	5/8	1	2	4	9584640	9584441	9584482	9584519	9584551	9584580	9584641
5/8	5/8	1	3	5	9584642	9584442	9584483	9584520	9584552	9584581	9584643
5/8	5/8	1	4	6	9584644	9584443	9584484	9584521	9584553	9584582	9584645
3/4	3/4	1-1/4	2	4	9584654	9584448	9584489	9584526	9584558	9584587	9584655
3/4	3/4	1-1/4	3	5	9584656	9584449	9584490	9584527	9584559	9584588	9584657
3/4	3/4	1-1/4	4	6	9584658	9584450	9584491	9584528	9584560	9584589	9584659
1	1	1-1/2	3	5	9584670	9584456	9584497	9584534	9584566	9584595	9584671
1	1	1-1/2	4	6	9584672	9584457	9584498	9584535	9584567	9584596	9584673
1	1	1-1/2	5	7	9584674	9584458	9584499	9584536	9584568	9584597	9584675

FERROUS AND EXOTIC ALLOYS

ENDMILLS



SCAN FOR SPEEDS & FEEDS

7 FLUTE VARIABLE



HEM / Dynamic Milling and Finishing.
Increased cutter stability and reduced chatter. Has perfect balance of hardness and toughness

Available Upon Request:
Flats, Firm Hold Shank and
Additional PVD Coatings.

P M K S Material Code: Refer to Page 4

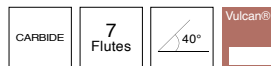

Vulcan® Coating Nanolayered structure provides exceptional wear resistance and lubricity

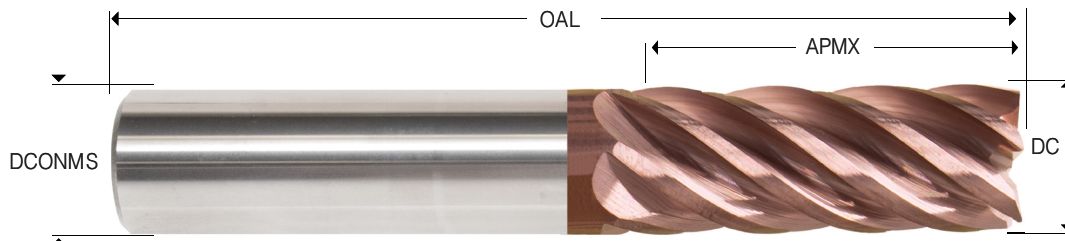

SCAN FOR SPEEDS & FEEDS

Fractional

DC	DCONMS	APMX	OAL	Sqaure	.015 RAD	.030 RAD	.060 RAD	.090 RAD	.125 RAD
1/4	1/4	1/2	2	9585617	9581587	9505517	9508433		
1/4	1/4	3/4	2-1/2	9585620	9581590	9581870	9508434		
1/4	1/4	1	3	9532376	9581591	9581871	9584900		
1/4	1/4	1-1/4	4	9585621	9581592	9581872	9584901		
5/16	5/16	1/2	2	9585622	9581593	9581873	9584902		
5/16	5/16	7/8	2-1/2	9585623	9581594	9581874	9584903		
5/16	5/16	1	3	9585624	9581595	9581875	9584904		
5/16	5/16	1-1/4	4	9585625	9581596	9581876	9584905		
3/8	3/8	1/2	2	9532379	9502391	9505518	9584906		
3/8	3/8	1	2-1/2	9585628	9581599	9505519	9508435		
3/8	3/8	1	3	9532380	9581600	9505520	9584909		
3/8	3/8	1-1/2	4	9585629	9581601	9505521	9584910		
7/16	7/16	1	2-3/4	9585630	9581602	9581879	9584911		
7/16	7/16	2	4	9585631	9581603	9581880	9584912		
1/2	1/2	5/8	2-1/2	9585632	9502392	9505522	9508436	9585134	9585329
1/2	1/2	1-1/4	3	9532381	9581608	9505524	9508438	9509895	9585332
1/2	1/2	2	4	9532382	9502393	9505526	9508439	9585136	9585333
1/2	1/2	2-1/2	5	9585635	9502394	9505527	9584914	9585137	9585334
1/2	1/2	3-1/8	6	9585636	9581609	9505528	9584915	9585138	9585335
5/8	5/8	3/4	3	9532383	9581610	9581884	9584916	9585139	9513218
5/8	5/8	1-5/8	3-1/2	9532385	9581613	9505531	9584920	9585143	9513219
5/8	5/8	2-1/2	5	9585640	9581614	9581887	9584921	9585144	9585339
5/8	5/8	3	6	9585641	9581615	9581888	9584922	9585145	9585340
3/4	3/4	1	3	9585642	9581616	9505532	9508440	9585146	9513221
3/4	3/4	1-5/8	4	9532387	9581619	9505535	9508441	9509896	9513222
3/4	3/4	2-1/4	5	9532388	9581620	9505536	9584926	9585150	9585344
3/4	3/4	3-1/4	6	9532389	9581621	9581890	9584927	9585151	9585345
3/4	3/4	4	7	9532390	9581622	9581891	9584928	9585152	9585346
1	1	1-1/4	4	9532391	9581623	9505537	9508442	9585153	9585347
1	1	2	4-1/2	9585649	9581627	9581895	9584931	9585156	9585349
1	1	2-1/4	5	9585650	9581628	9581896	9584932	9585157	9585350
1	1	2-5/8	6	9585651	9581629	9581897	9584933	9585158	9513223
1	1	3-1/4	6	9585652	9581630	9581898	9584934	9585159	9585351
1	1	4-1/8	7	9585653	9581631	9581899	9584935	9585160	9585352
1-1/4	1-1/4	2	4-1/2	9585654	9581632	9581900	9584936	9585161	9585353
1-1/4	1-1/4	3	6	9532392	9581633	9581901	9508443	9585162	9585354
1-1/4	1-1/4	5	8	9532393	9581634	9505538	9584937	9585163	9585355

Other Dimensions are Available Upon Request

NEW
NEXT GENERATION ENDMILLS

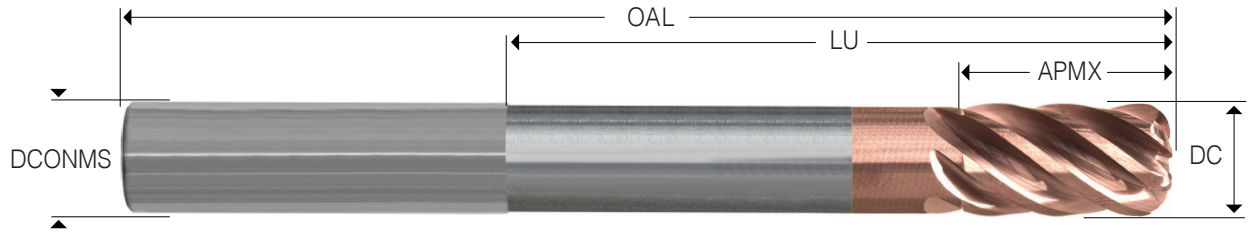

Extended Reach provides a more stable and stronger option for deep pocketing applications.

Extended Neck

DC	DCONMS	APMX	LU	OAL	Sqaure	.015 RAD	.030 RAD	.060 RAD	.090 RAD	.125 RAD
1/4	1/4	1/2	1-1/4	3	9585618	9581588	9581868	9584898		
1/4	1/4	1/2	2-1/8	4	9585619	9581589	9581869	9584899		
3/8	3/8	3/4	1-1/4	3	9585626	9581597	9581877	9584907		
3/8	3/8	3/4	2-1/8	4	9585627	9581598	9581878	9584908		
1/2	1/2	7/8	1-3/8	3	9585633	9581604	9581881	9584913	9585135	9585330
1/2	1/2	7/8	2-1/8	4	9585634	9581605	9505523	9508437	9509894	9585331
1/2	1/2	7/8	3-1/8	5	9586241	9581606	9581882	9586009	9586077	9586110
1/2	1/2	7/8	4-1/8	6	9586242	9581607	9581883	9586010	9586078	9586111
5/8	5/8	1	2	4	9585637	9502395	9505530	9584917	9585140	9585336
5/8	5/8	1	3	5	9585638	9581611	9581885	9584918	9585141	9585337
5/8	5/8	1	4	6	9585639	9581612	9581886	9584919	9585142	9585338
3/4	3/4	1-1/4	2	4	9585643	9581617	9505533	9584923	9585147	9585341
3/4	3/4	1-1/4	3	5	9585644	9502396	9581889	9584924	9585148	9585342
3/4	3/4	1-1/4	4	6	9585645	9581618	9505534	9584925	9585149	9585343
1	1	1-1/2	3	5	9585646	9581624	9581892	9586011	9586079	9586112
1	1	1-1/2	4	6	9585647	9584750	9584751	9584929	9585154	9584152
1	1	1-1/2	5	7	9585648	9581626	9581894	9584930	9585155	9585348



SCAN FOR SPEEDS & FEEDS

4 FLUTE VARIABLE



Adapted from the 451 Series, the 453 features and advanced chip splitter design which provided less machine load and better chip control

Available Upon Request:
Flats, Firm Hold Shank and Additional PVD Coatings.

P M K Material Code: Refer to Page 4

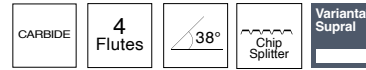

Varianta® Supral Provide a low coefficient of friction, reducing tool wear and resulting in a longer tool life.

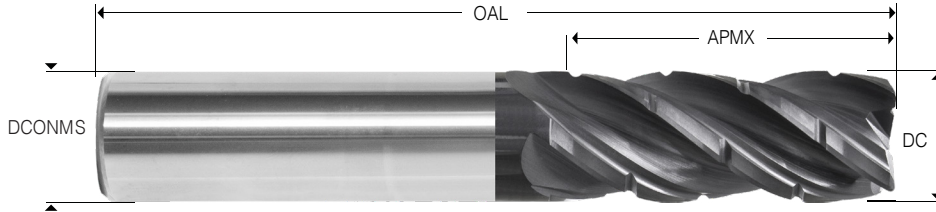

SCAN FOR SPEEDS & FEEDS

Fractional

DC	DCONMS	APMX	OAL	.015 RAD	.030 RAD	.060 RAD	.090 RAD	.125 RAD	Ball
1/4	1/4	3/8	2	9502046	9504865				9529769
1/4	1/4	3/4	2-1/2	9502050	9504869				9529777
1/4	1/4	1	3	9502051	9504870				9529779
1/4	1/4	1-1/4	4	9502052	9504871				9529783
1/4	1/4	1-3/4	4	9502053	9504872				9529785
5/16	5/16	1/2	2	9502054	9504873				9529787
5/16	5/16	7/8	2-1/2	9502055	9504874				9529789
5/16	5/16	1	3	9502056	9504875				9529791
5/16	5/16	1-1/4	4	9502057	9504876				9529795
5/16	5/16	1-5/8	4	9502058	9504877	9584878			9529797
3/8	3/8	1/2	2	9502059	9504878	9584881			9529799
3/8	3/8	1	2-1/2	9502062	9504881	9508006			9529807
3/8	3/8	1	3	9502063	9504882	9584882			9529809
3/8	3/8	1-1/2	4	9502064	9504883	9584883			9529812
3/8	3/8	2-1/2	5	9502065	9504884	9508007			9529816
1/2	1/2	5/8	2-1/2		9504889	9585985	9585107	9585306	9529827
1/2	1/2	1	3		9504896	9508011	9509703	9585310	9529837
1/2	1/2	1-1/4	3		9504898	9508012	9585111	9585311	9529839
1/2	1/2	1-1/2	4		9504899	9508013	9585112	9512737	9529842
1/2	1/2	2	4		9504901	9508014	9585113	9585312	9529846
1/2	1/2	2-1/2	5		9504902	9508016	9585114	9585313	9529850
1/2	1/2	3	6		9504903	9508017	9585115	9585314	9529852
5/8	5/8	3/4	3		9504904	9508018	9509704	9585315	9529854
5/8	5/8	1-1/4	3-1/2		9504910	9508022	9509708	9585319	9529865
5/8	5/8	1-3/4	4		9504911	9508023	9509709	9585320	9529867
5/8	5/8	2-1/4	5		9504912	9508024	9509710	9585321	9529869
5/8	5/8	3	6		9504913	9508025	9509711	9585322	9529873
3/4	3/4	7/8	3			9508026	9509712	9512738	9529879
3/4	3/4	1-1/2	4			9508032	9509716	9512742	9529896
3/4	3/4	1-5/8	4			9508034	9509717	9512743	9529898
3/4	3/4	2-1/4	5			9508036	9509718	9512744	9529903
3/4	3/4	3	6			9508037	9509719	9512745	9529905
3/4	3/4	4	7			9508038	9509720	9512746	9529910
1	1	1-1/2	4			9508042	9509724	9512750	9529922
1	1	2	4-1/2			9508043	9509725	9512751	9529925
1	1	2-1/4	5			9508044	9509726	9512752	9529929
1	1	3	6			9508045	9509727	9512753	9529932
1	1	4	7			9508046	9509728	9512754	9529936

Other Dimensions are Available Upon Request

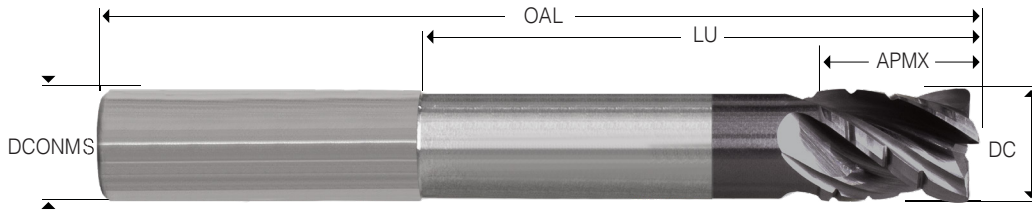

Extended Reach provides a more stable and stronger option for deep pocketing applications.

Extended Neck

DC	DCONMS	APMX	LU	OAL	.015 RAD	.030 RAD	.060 RAD	.090 RAD	.125 RAD	Ball
1/4	1/4	1/2	1-1/4	3	9581549	9581838	9584876			9585594
1/4	1/4	1/2	2-1/8	4	9581550	9581839	9584877			9585595
3/8	3/8	3/4	1-1/4	3	9581551	9581840	9584879			9585596
3/8	3/8	3/4	2-1/8	4	9581552	9581841	9584880			9585597
1/2	1/2	7/8	1-3/8	3		9504893	9584884	9585108	9585307	9585598
1/2	1/2	7/8	2-1/8	4		9504894	9584885	9585109	9585308	9529834
1/2	1/2	7/8	3-1/8	5		9581842	9585985	9586060	9586094	9586180
1/2	1/2	7/8	4-1/8	6		9504895	9584886	9585110	9585309	9585599
5/8	5/8	1	2	4		9581843	9584887	9585116	9585316	9585600
5/8	5/8	1	3	5		9504908	9584888	9585117	9585317	9529863
5/8	5/8	1	4	6		9504909	9584889	9585118	9585318	9585601
3/4	3/4	1-1/4	2	4			9584890	9585119	9585323	9585602
3/4	3/4	1-1/4	3	5			9508031	9585120	9585324	9585603
3/4	3/4	1-1/4	4	6			9584891	9585121	9585325	9585604
1	1	1-1/2	3	5			9585986	9586061	9586095	9585605
1	1	1-1/2	4	6			9585987	9586062	9586096	9585606
1	1	1-1/2	5	7			9585988	9586063	9586097	9585607



SCAN FOR SPEEDS & FEEDS



HAIMER USA and Precision Cutting Tools Form Safe-Lock™ Partnership

Precision Cutting Tools (PCT), a U.S. carbide round tool manufacturer, and HAIMER USA, a market leader in tool holding technology, have recently signed a U.S. licensing agreement for HAIMER's patented Safe-Lock™ anti-pullout system.

Ever since their beginning in 1963, PCT has specialized in the production of high performance and high quality cutting tools. They pride themselves on providing excellent customer service and by introducing innovative cutting tools. PCT and HAIMER have very similar company morals, which makes it easy to work together. "It is my pleasure to welcome PCT as an official U.S. Safe-Lock™ Licensee," stated Brendt Holden, President of HAIMER USA. "The Safe-Lock™ system was specifically designed for aggressive machining applications and high speeds, and many of PCT's customers are already utilizing the Safe-Lock™ technology. It is for this reason that I believe that the Safe-Lock™ system will be well received by PCT customers across the U.S."

At PCT, customers were realizing that increased productivity would reduce overall costs. With the use of Safe-Lock™, customers feel comfort knowing that their tools are secure and will not pull out and potentially scrap a part. "At PCT, we consider ourselves a solutions provider for the end user," CEO of PCT Nikhil Sheth said. "Partnering with HAIMER has allowed us to provide this sort of assurance against tool slippage."

Since its creation, the Safe-Lock™ system has continued to grow rapidly in the U.S. market across all industrial sectors. The success of the system has largely been fueled by its popularity as more and more manufacturers recognize increased productivity due to the pull out protection Safe-Lock™ provides. Safe-Lock™, which emerged from the requirements of heavy-duty machining, initially made a name for itself in the aerospace and energy industries. However, cost and time savings are not solely restricted to typical aerospace applications and have also been found in typical milling applications. In particular, the increase in customers utilizing the modern high efficiency dynamic milling strategies available from the CAM software companies, have found Safe-Lock™ to be an absolute necessity.

To learn more about Safe-Lock™, visit haimer-usa.com or call 630-833-1500.
HAIMER USA and Precision Cutting Tools Form Safe-Lock™ Partnership



E[SPECIAL]LY

MADE FOR YOU

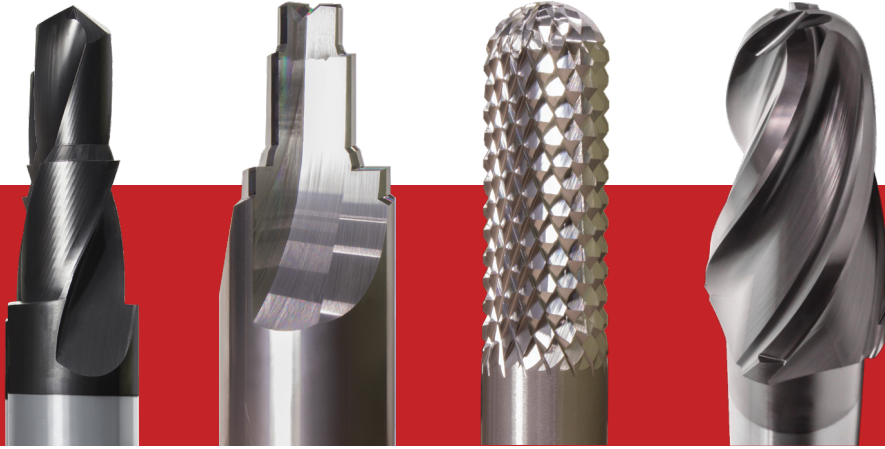

CUSTOMIZABLE OPTIONS:

- Radius
- Chamfer
- Ball End
- Tolerance
- Flat Bottom
- Weldon Flats
- Whistle Notch
- Clearance Angles
- Length & Diameters

Precision Cutting Tools will create a tool especially made for you! Send it to quotes@pct-ipc.com to get a quote in hour! Check www.pct-ipc.com for over 40 pre-made designs on our website!

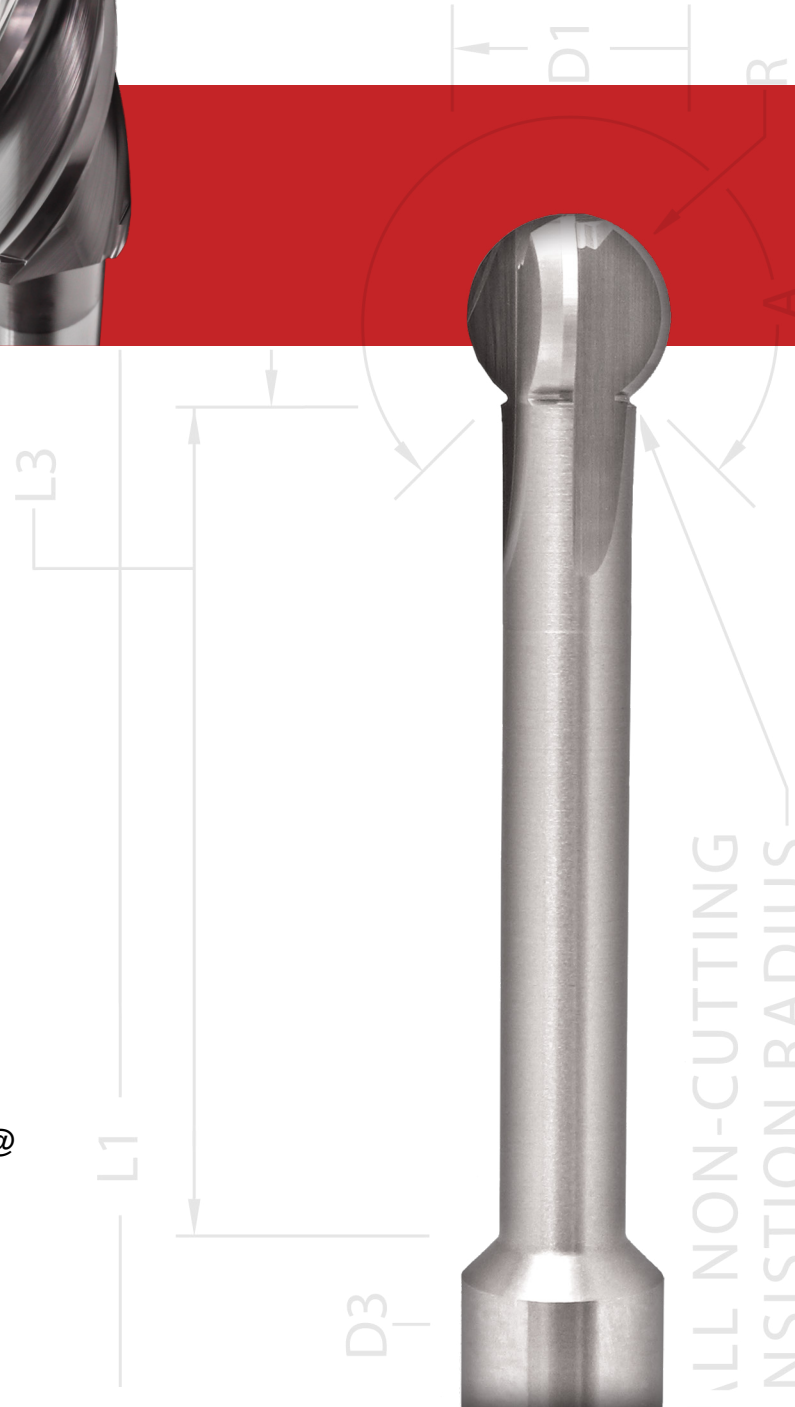

IN-HOUSE COATING

PCT offers a variety of coatings for all your cutting tools through its in-house coating facility. Our experts will help you choose the proper coating for your specific needs and will have your tools coated within a 24-48 hr. time frame.

PVD Coatings	TiN®	Z-Power®	ZircoPlus®	TiCN
Coating Material	Titanium Nitride	Zirconium Nitride	Zirconium Carbo-Nitride	Titanium Carbo-Nitride
	TiN	ZrN	ZrCN	TiCN (ML)
Micro-hardness HV 0.05	2300	2800	3100	3500
Friction Coefficient Against Steel (Dry)	0.6	0.5	0.5	0.2
Coating Thickness* (µm)	2-4	1-4	1-4	2-4
Thermal Threshold	500°C 900°F	600°C 1100°F	600°C 1100°F	400°C 750°F
Color of the Coating	Gold	Pale Gold	Pale Yellow, Rose	Blue Gray
Key characteristics	Standard, all-purpose coating, biocompatible	Good wear and corrosion resistance, biocompatible	Low friction high corrosion resistance, biocompatible	High hardness, good wear resistance, enhanced toughness
Primary Applications	For use on cutting tools that are used for machining Iron(Fe) alloys and steels Low-chemical reactivity against iron and steel Metal forming Plastic molding	Ideal for machining aluminum, brass, nickel, fiberglass, nylon and most polymer materials Corrosion and adhesion resistant properties Forming and punching - reduced cold re-welding Medical applications - biocompatible & corrosion resistant	For use on carbide cutting tools, HSS and other materials below 450°C/842°F Ideal for Aluminum Alloys with high Silicon(Si) content Averts light metals from welding together Excellent for non-ferrous applications	Applied to HSS cutting tools for high speed machining of steels Ideal for interrupted cutting operations of steels Helps maintain the sharp edges and corners on the cutting tool Excellent for metal forming (stainless steel)

PROPERTIES AND APPLICATIONS OF OUR PVD COATINGS

Exxtral Plus®	Exxtral Silver®	Exxtral Carbon®	Exxtral Black®	Sistral®	WC/C	Vulcan®	Varianta® Supral	CrN CrCN
Aluminum Titanium Nitride	Aluminum Titanium Chromium Nitride	Tetrahedral Amorphous Carbon (Diamond)	Aluminum Chromium Nitride	Aluminum Titanium Nitride (w/additions)	Tungsten Carbide-Carbon	Titanium Aluminum Carbo-Nitride	Titanium Aluminium Carbo-Nitride	Chromium Nitride Carbo-Nitride
AlTiN (stacked)	AlTiCrN	Ta-C	AlCrN	AlTiN (nanostructured)	a-C : Me	TiAlCN	TiAlCN (ML)	CrN CrCN
3300	3300	5500-6000	3200	3500	1000-2200	3500	3500	2000 2300
0.7	0.4	0.1	0.45	0.7	0.2-0.25	0.2	0.7 <0.5	0.3-0.4 0.2-0.3
1-3	2-4	0.5-1.5	2-5	1-3	1-2	2-4	2-4	2-6
800°C 1470°F	800°C 1470°F	500°C 900°F	1100°C 2012°F	900°C 1650°F	400°C 750°F	800°C 1470°F	800°C 1470°F	600°C 1100°F
Anthracite, Dark Gray	Silver	Rainbow Gray	Slate Gray	Anthracite (Black)	Dark Gray	Copper, Old Rose	Anthracite (Black)	Silver-Gray
High hardness very good oxidation resistance	High hardness and oxidation resistance	High thermal stability, excellent tribological properties, and a long cutting life	High heat hardness, wear resistance and oxidation resistance	Extreme wear and oxidation resistance at high temperatures	High lubricity, low tendency for adhesive wear	Low friction, high oxidation resistance	High hardness, very good oxidation resistance low friction	Low stress/ good adhesion, high toughness and corrosion resistance
Machining of hardened steel work	For use on carbide cutting tools for machining titanium, inconel, stainless steels and cast iron	Ideal for machining of Aluminum and non-ferrous materials.	Intended for use on high temperature applications	Best choice for cutting under extreme conditions (hard, abrasive materials, high speed, dry cutting)	Precision components	Coating for a wide range of carbide, cermet and HSS and other steels, Machining under dry as well as wet conditions	Coating for a wide range of carbide, cermet and high speed steel tooling Machining of cast iron and nickel- based high temperature alloys	Machining copper and other non- ferrous materials
For use on carbide end mills		Can also be used on plastic and rubber	Increased adhesion and advanced oxidation resistance	Machining of hardened steel (>54 HRC)]	Punching & forming, minimal lubrication or dry	Excellent for drilling in steel	High speed operations, semi-dry or dry machining	Metal forming
High speed operations, semi-dry or dry machining	Machining abrasive and gummy materials	Extremely extends the life of the cutting tool, and provides a sharper cutting edge.	Excellent for cutting steels and high speeds, dry or semi-dry machining	Inconel machining	Plastic injection & molding	Drawing, stamping, punching, forming tools for processing of high and low alloy steel	Excellent for drilling operations in steel (up to 45 HRC)	Plastic molding (improved demolding)
Metal cutting tasks where other coatings reach their limits of thermal and mechanical load	CrN surface reduces the cold welding tendency			Helps maintain high cutting forces and tool life	Moving parts, dry			Aluminum and magnesium die casting

*Depends on size of tools; for micro tools thinner coatings.

TOLERANCES

Endmills

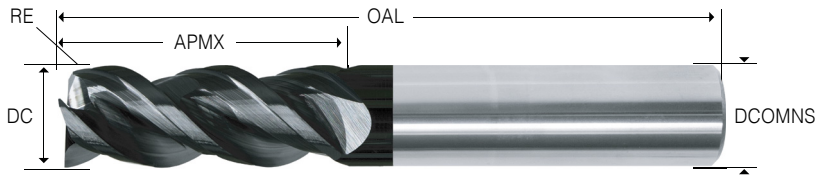

Cutting Diameter DC (f8): $\pm 0.000/-0.002$
 Shank Diameter DCONMS (h6): $\pm 0.0001/-0.0004$
 Corner Radius RE: ± 0.003
 Overall Length OAL: ± 0.062
 Length of cut APMX: $\pm 0.062/-0.000$
 Total Indicated Runout TIR: $.0005$ max.

ROUGHERS

DC (e9): $<0.750 +0.00/-0.003$
 $\geq 0.750 -0.005$

EXTENDED NECK ENDMILLS

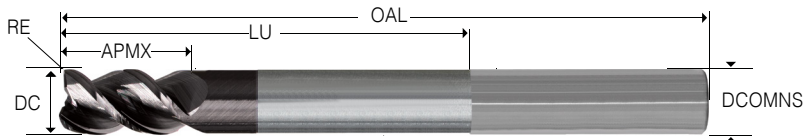

Neck DIA Tolerances

Cutting dia.	Neck dia.	Tolerance
1/8"-3/16"	-0.010	(+0/-0.005)
1/4"-3/8"	-0.015	(+0/-0.005)
7/16"-1/2"	-0.020	(+0/-0.005)
5/8"-3/4"	-0.030	(+0/-0.005)
7/8"-1"	-0.035	(+0/-0.010)
1-1/4"-1-1/2"	-0.040	(+0/-0.010)

Drills

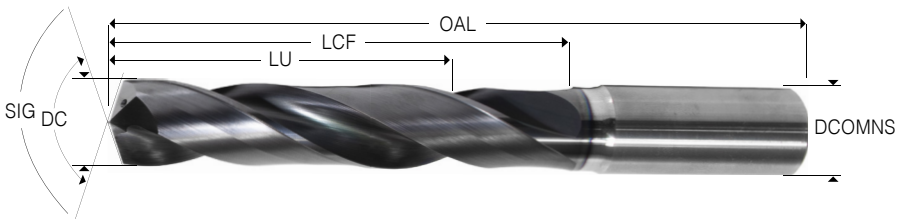

OAL: $\pm 0.062 / -0.030$ (MM $+1.575 / - .762$)
 LU: $\pm 0.062 / -0$ (MM $+1.575 / - 0.0$)
 SIG: $\pm 1^\circ$ (unless otherwise specified)

Drill Diameter (h7) (In)

.0000-.1181: $\pm 0/-0.00039$
 .1182-.2362: $\pm 0/-0.00047$
 .2363-.3937: $\pm 0/-0.00059$
 .3938-.7087: $\pm 0/-0.00071$

Drill Diameter (h7) (mm)

0-3: $0/-0.010$
 3.01-6: $\pm 0/-0.012$
 6.01-10.0: $\pm 0/-0.015$
 10.01-18.0: $\pm 0/-0.018$

Shank Diameter (h6) (in)

.0000-.1181: $\pm 0/-0.00024$
 .1182-.2362: $\pm 0/-0.00031$
 .2363-.3937: $\pm 0/-0.00035$
 .3938-.7087: $0/-0.00043$

Shank Diameter (h6) (mm)

0-3: $\pm 0/-0.006$
 3.01-6: $\pm 0/-0.008$
 6.01-10.0: $\pm 0/-0.009$
 10.01-18.0: $\pm 0/-0.011$

PXC Series add ± 0.00078 (± 0.020 MM) to diameter and then standard tolerance for drill apply.

Dual Dimensioning and Combination Units

$$\frac{31.318 \pm 0.076}{(1.233 \pm .003)} \quad \frac{31.394}{31.242} \quad \frac{31.318 \pm 0.076}{(1.233 \pm .003)}$$

Conversions:

IN = MM / 25.4
 MM = IN X 25.4



PRECISION CUTTING TOOLS
Member IMC Group

Precision Cutting Tools
5572 Fresca Drive
La Palma, CA 90623
www.pct-imc.com

E: info@pct-imc.com
T: (562) 921-7898
F: (562) 926-0156