



Turning Tools & Inserts



Leitz Metalworking Technology Group
**BELIN • BILZ • BOEHLERIT •
FETTE • KIENINGER • ONSRUD**

Leitz Metalworking Technology Group

Under the name LMT – Leitz Metalworking Technology Group the companies Böhlerit, Fette, Kieninger, Onsrud, Bilz and Belin work together. The joint forces of these six well-known companies in the metal working industry offer our customers an opportunity to improve efficiency in productivity, quality and service.



BÖHLERIT GmbH & Co. KG
Kapfenberg, Austria

Böhlerit is the base of the firm group in the development and production of carbide materials. The delivery program encloses standard and special tools and tool systems for cutting and noncutting shaping as also carbide materials for toolmakers and wear parts.



FETTE has a world-wide leading position in the production of precision tools for the metal machining. Main points are the milling, the production of gears and the thread rolling. Fette also manufactures the pelleting press for the pharmaceutical and chemical industries.



Fette GmbH
Schwarzenbek, Germany



Kieninger GmbH
Lahr, Germany

Kieninger, active since 1960, is the specialist for carbide and diamond tools for the metal working. Kieninger offers innovative solutions for the mold and die industry, as well as complex tooling for the engine industry for machining of boreholes. This group offers a complete line of milling cutters for high speed milling.



ONSRUD exclusively produces carbide and HSS shank tools, which are especially used for the aircraft industry to machine light alloys, plastics and light alloys-plastics composites. Molds for the machining of profile woods are also produced.



ONSRUD Cutter Inc.
Libertyville, Illinois USA



Bilz Werkzeuge GmbH & Co.,
Germany

BILZ is known because of its innovative spanning systems and thermatic clamping systems. It has a world-wide leading position in the production of thread-cutting linings.



BELIN is an appreciated manufacturer of tungsten carbide tools as also PCD-, CBN and carbide hard-faced tools especially for the production and machining of bores in metal.



BELIN Yvon S.A.,
France



Table of contents

<p>Material groups</p> <table border="1"> <thead> <tr> <th></th> <th>Rough</th> <th>Medium</th> <th>Fine</th> </tr> </thead> <tbody> <tr> <td>Steel</td> <td>Blue</td> <td>Light Blue</td> <td>White</td> </tr> <tr> <td>Stainless steel</td> <td>Yellow</td> <td>Light Green</td> <td>White</td> </tr> <tr> <td>Iron casting</td> <td>Orange</td> <td>Light Green</td> <td>White</td> </tr> <tr> <td>Non-ferrous metal</td> <td>Green</td> <td>Light Green</td> <td>White</td> </tr> <tr> <td>High-temperature alloys</td> <td>Red</td> <td>Light Green</td> <td>White</td> </tr> <tr> <td>Hardened materials</td> <td>White</td> <td>Light Green</td> <td>White</td> </tr> </tbody> </table> <p>Machining mode</p>		Rough	Medium	Fine	Steel	Blue	Light Blue	White	Stainless steel	Yellow	Light Green	White	Iron casting	Orange	Light Green	White	Non-ferrous metal	Green	Light Green	White	High-temperature alloys	Red	Light Green	White	Hardened materials	White	Light Green	White	<p>i Information 2</p> <ul style="list-style-type: none"> Tool Index Chart Insert Geometries Turning and Boring Insert Identification System Grades & Color Guide
	Rough	Medium	Fine																										
Steel	Blue	Light Blue	White																										
Stainless steel	Yellow	Light Green	White																										
Iron casting	Orange	Light Green	White																										
Non-ferrous metal	Green	Light Green	White																										
High-temperature alloys	Red	Light Green	White																										
Hardened materials	White	Light Green	White																										
	<p>◆ Inserts 18</p>																												
<p>5° E C Right hand sh Left hand e</p>	<p>M Multiple Lock Toolholders 50</p>																												
<p>32° 3° F E Right hand sh Left be</p>	<p>S Screw-on Toolholders 54</p>																												
<p>E</p>	<p>MB Multiple Lock Boring Bars 57</p>																												
<p>F</p>	<p>SB Screw-on Boring Bars 59</p>																												
	<p>T Parts and Accessories 62</p>																												
	<p>T Technical Information 64</p>																												

Range of Toolholders Indexable Inserts External

Tool Holder	MCLN R/L	MCRN R/L	MDJN R/L	MDPNN N	MSDNN N	MSKN R/L
Setting Angle	-5° end or side	15° side	-3° side	27.5° side	45° side	15° end
Cutting Direction						
Page No.	Page 50	Page 50	Page 50	Page 51	Page 51	Page 51
Indexable Inserts	CNMA... CNMG... CNMM... CNMX...	CNMA... CNMG... CNMM... CNMX...	DNMA... DNMG... DNMM...	DNMA... DNMG... DNMM...	SNMA... SNMG... SNMM... SNMX...	SNMA... SNMG... SNMM... SNMX...
Page No.	Page 18–23	Page 18–23	Page 24–27	Page 24–27	Page 32–37	Page 32–37
Tool Holder	MTAN R/L	MTEN	MTFN R/L	MTGN	MTJN	MVJN R/L
Setting Angle	0° side	30° side	0° end	0° side	-30° side	-3° side
Cutting Direction						
Page No.	Page 52	Page 52	Page 52	Page 53	Page 53	Page 53
Indexable Inserts	TNMA... TNMG... TNMM... TNMX...	TNMA... TNMG... TNMM... TNMX...	TNMA... TNMG... TNMM... TNMX...	TNMA... TNMG... TNMM... TNMX...	TNMA... TNMG... TNMM... TNMX...	VNMG...
Page No.	Page 38–41	Page 38–41	Page 38–41	Page 38–41	Page 38–41	Page 42–43
Tool Holder	MWLN R/L	SCLC R/L	SDJC R/L	SRCC R/L	SRGC R/L	SROC N
Setting Angle	-5° end or side	-5° end or side	-3° side	-5° end or side	-5° end or side	-3° side
Cutting Direction						
Page No.	Page 54	Page 54	Page 54	Page 55	Page 55	Page 55
Indexable Inserts	WNMG...	CCGT... CCMT... CCMW...	DCGT... DCMT... DCMW...	RCGT... RCMT...	RCGT... RCMT...	RCGT... RCMT...
Page No.	Page 44–45	Page 18–19	Page 24–25	Page 30–31	Page 30–31	Page 30–31
Tool Holder	SSDCN N	SVJC N	SWLC R/L			
Setting Angle	45° side	-3° side	-5° end or side			
Cutting Direction						
Page No.	Page 56	Page 56	Page 56			
Indexable Inserts	SCGT... SCMT... SCMW...	VCGT... VCMT... VCMN...	WCGT... WCMT...			
Page No.	Page 32–33	Page 42–43	Page 44–45			











Range of Toolholders Indexable Inserts **Internal**

Tool Holder	S-MCLN R/L	S-MDUN R/L	S-MTFN R/L	S-MTUN R/L	S-MVUN R/L
Setting Angle	-5° end or side	-3° end	-0° end	-3 end	-3° end
Cutting Direction					
Page No.	Page 57	Page 57	Page 57	Page 58	Page 58
Indexable Inserts	CNMA... CNMG... CNMM... CNMX...	DNMA... DNMG... DNMM...	TNMA... TNMG... TNMM... TNMX...	TNMA... TNMG... TNMM... TNMX...	VNMG...
Page No.	Page 18–23	Page 24–27	Page 38–41	Page 38–41	Page 42–43
Tool Holder	S-MWLN R/L	S-SCLC R/L	S-SDUC R/L	S-STFC R/L	STUC R/L
Setting Angle	-5° end or side	-5° end or side	-3° end	0° end	-3° end
Cutting Direction					
Page No.	Page 58	Page 59	Page 59	Page 59	Page 60
Indexable Inserts	WNMG...	CCGT... CCMT... CCMN...	DCGT... DCMT... DCMW...	TCGT... TCMT...	TCGT... TCMT...
Page No.	Page 44–45	Page 18–19	Page 24–25	Page 38–39	Page 38–39
Tool Holder	S-SVUC R/L	S-SWUC R/L	SCLC R/L	S-STUC R/L	
Setting Angle	-3° end	-3° end	-5° end or side	-3° end	
Cutting Direction					
Page No.	Page 60	Page 60	Page 61	Page 61	
Indexable Inserts	VCGT... VCMT... VCMN...	WCGT... WCMT...	CCGT... CCMT... CCMW...	TCGT... TCMT...	
Page No.	Page 42–43	Page 44–45	Page 18–19	Page 38–39	

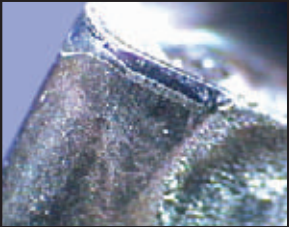
LC215B, LC225C and LC235C

The new generation of turning grades LC“200”









Before	Technological advantages	LC215B LC225C LC235C	Advantage for the customer
	New coating technology results in extremely smooth and wear-resistant layer structure and smooth layer surface		Top cutting speeds. Reduction of production costs coupled with universal application.
	New sinter technology ensures a tough safety zone in the cutting edge areas		Reduced tendency to stick during interrupted cutting.
	Smooth and golden colored TiN top coat		Simple wear recognition coupled with a reduced tendency of built-up edges.
	Modern micro and macro-geometry, surface ground after coating. Heat carry-off zone due to ground surface		Safe, vibration-free support with improved dynamic cutting behavior at top speeds. Little heat development in the workpiece in dry processing due to higher heat transfer to the tool.

Summary:

The combination of new ideas and production technologies makes LC 215B, LC225C and LC235C the economical choice for efficient working on an extremely wide range of steel materials in wet and dry machining

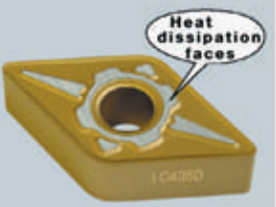

Turning stainless steels made easy with LC435D

Technological Advantages		Advantages for the Customer	
	New cutting technology affords even coating build up and extremely smooth insert surface finish.		Reduced built up edges when machining austenitic stainless steels .
	Gradient sinter gives increased protection to the cutting edge.		More positive micro-geometry compared to conventional grades eliminates work hardening of the machined austenitic stainless steels.
	Ground heat dissipation faces through seat grinding after coating.		Reduced heat transfer from cutting assembly to the work-piece, heat dissipation increased into the tool holding system.
 <ul style="list-style-type: none"> -BFMS Böhlerit Finishing/Medium Stainless Steel -BMS Böhlerit Medium Stainless Steel -BMRS Böhlerit Medium/Roughing Stainless Steel -BSMS Böhlerit ISO-S Medium Stainless Steel 	Four specialized chip breakers for Austenitic Stainless Steel		Optimized chip breaking over a wide application base.

Aluminum machining with state-of-the-art high performance coating
Plasma CVD

LMT-FETTE reaps the benefits of Plasma CVD coating technology in the latest grade developed: the LC610M-specially designed for the machining of aluminum.

The wafer-thin 1.5 µm TiAlN coating guarantees convincing results from this revolutionary development.







Above all, in the machining of aluminum materials and other nonferrous metals.

The ultra-thin coating also makes finish-machining on steel and stainless steels possible.

The new

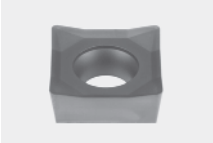
BAL (Böhlerit ALuminum)-

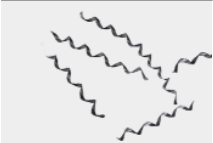
chip breaker with wave-shape cutting edge guarantees even shorter chips in a wide range of applications, thanks to improved transverse compression.

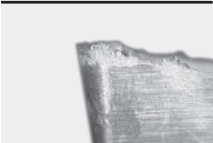
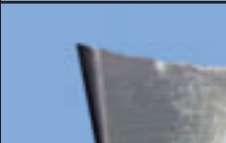
Up to now	The innovation	LC610M	Customer benefits
	<ul style="list-style-type: none"> Ultra smooth insert surface due to the micro-thin coating structure 		<ul style="list-style-type: none"> Greatly reduced sticking tendency, and no edge build-up
	<ul style="list-style-type: none"> Geometry BAL (Böhlerit ALuminum) with wafer-thin (1.5 µm) coating - sharp cutting edge 		<ul style="list-style-type: none"> Excellent workpiece surface
	<ul style="list-style-type: none"> Wave shaped highly positive chip breaker BAL geometry 		<ul style="list-style-type: none"> Optimum chip breaking, short chips
	<ul style="list-style-type: none"> Coated indexable inserts for aluminum machining 		<ul style="list-style-type: none"> Considerably less flank wear, no edge build-up on the clearance face, even more economical

The outstanding qualities of LC610M

The low coating temperature prevents base material embrittlement; thereby considerably increasing machining reliability. More economic through reduced wear (increased tool life) at higher cutting speeds (reduced machining time). Prevents edge build-up.

LC610M with BAL - geometry

The BEST way to machine aluminum



Geometries for negative inserts (ISO M-clamping system)

Chipbreaker geometries for the turning of steels

For negative indexable inserts suitable for ISO M clamping systems

Chip control over a broad range of applications from roughing to finishing

Main Geometries

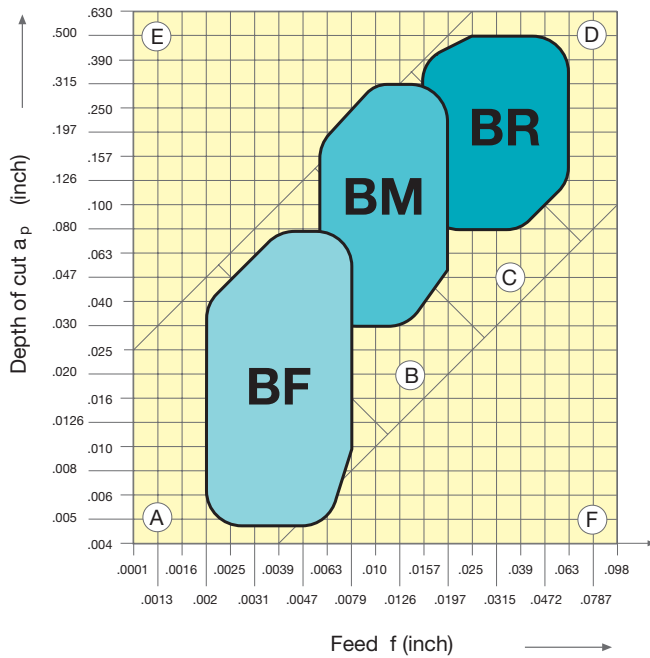

“BR” roughing geometry
(Böhlerit **R**oughing)



Universal **“BM”** geometry
(Böhlerit **M**edium)



“BF” finishing geometry
(Böhlerit **F**inishing)



Intermediate Geometries

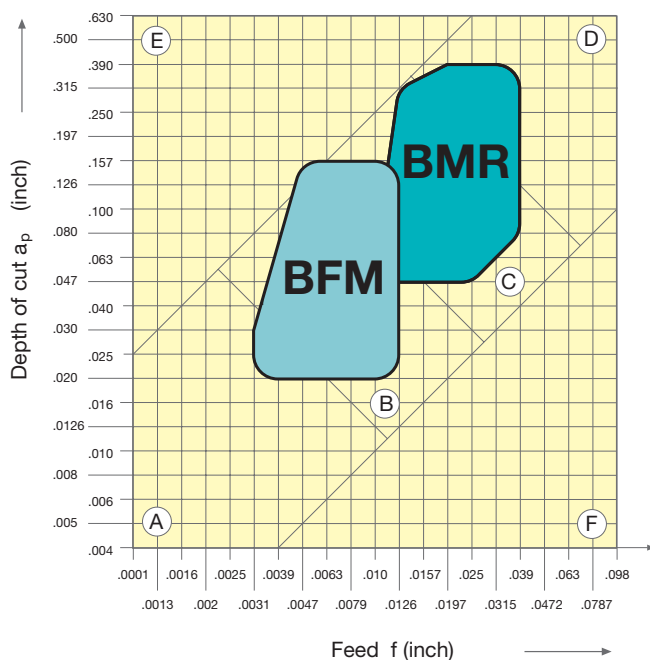

“BMR” rough intermediate geometry
(Böhlerit **M**edium/**R**oughing)



Preferably for cast materials

“BFM” fine intermediate geometry
(Böhlerit **F**inishing/**M**edium)



Geometries for positive inserts (ISO S-clamping system)

Chipbreaker geometries for turning steel

Chip control over a broad range of applications from roughing to finishing

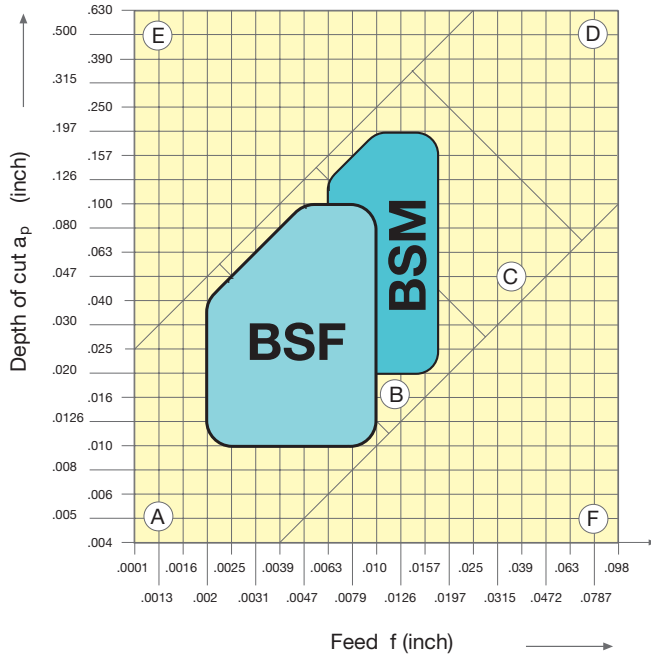

Universal “BSM” geometry
(Böhlerit ISO S system Medium)



“BSF” finishing geometry
(Böhlerit ISO S system Finishing)

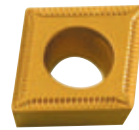

Geometry for copy turning, negative inserts

Chip groove geometries for turning steel

For negative indexable inserts suitable for ISO M clamping systems

Chip control over a broad range of applications from roughing to finishing

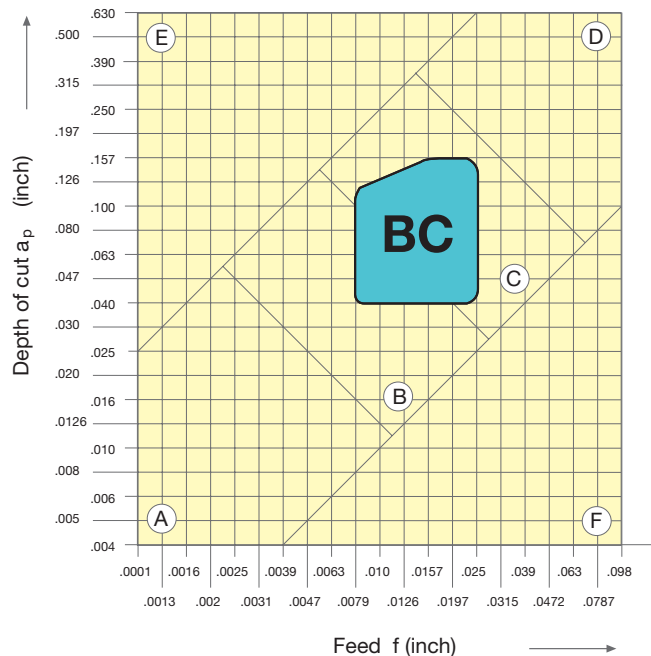

Geometry for copy turning “BC”
(Böhlerit Copying)





Geometries for negative inserts (ISO M-clamping system)

Chipbreaker geometries for turning stainless steel

Chip control combined with reduced built up edge formation over a wide applications base for Stainless Steel turning operations

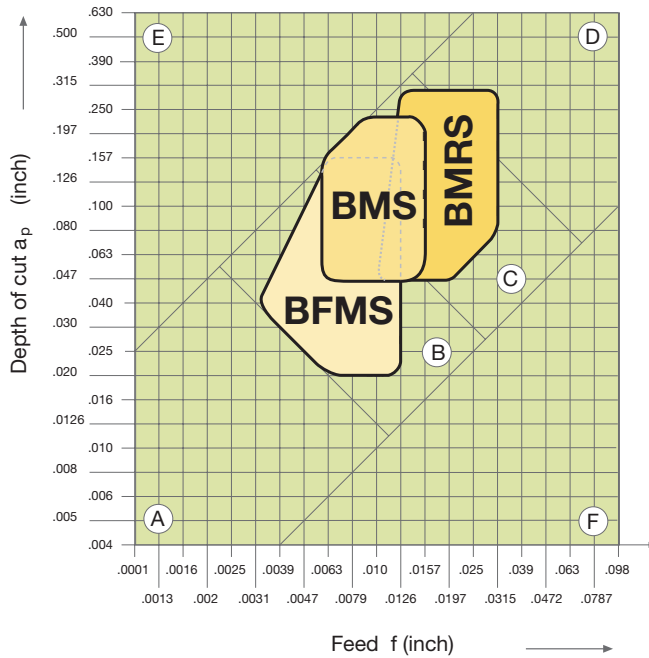

Roughing Geometry "BMRS"
(Böhlerit Medium/Roughing Stainless Steel)



Universal Geometry "BMS"
(Böhlerit Medium Stainless Steel)



Finishing Geometry "BFMS"
(Böhlerit Finishing/Medium Stainless Steel)

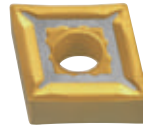

Geometry for positive inserts (ISO S-clamping system)

Chipbreaker geometries for turning stainless steel

Chip control combined with reduced built up edge formation over a wide applications base for Stainless Steel turning operations

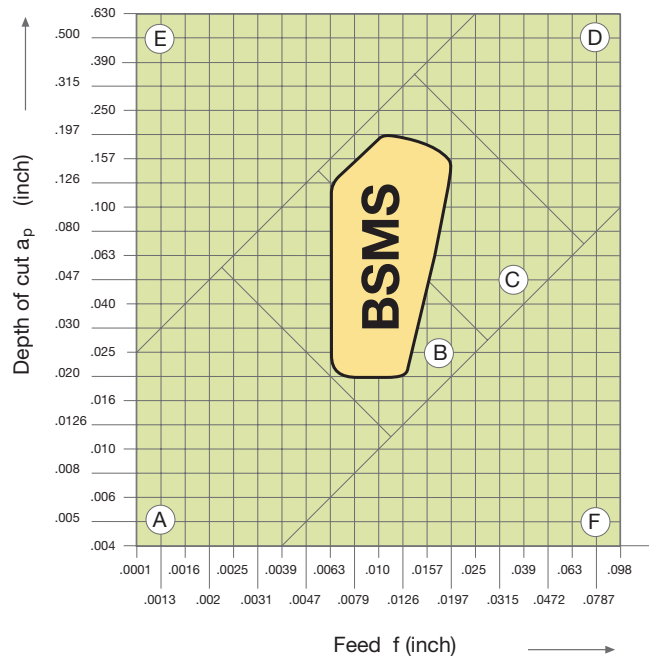

Universal Geometry "BSMS"
(Böhlerit ISO-S Medium Stainless Steel)





Geometry for positive inserts (ISO S-clamping system)

Chipbreaker geometries for turning nonferrous materials

Chip control qualities combined with reduced built up edge formation over a wide application base for nonferrous turning operations

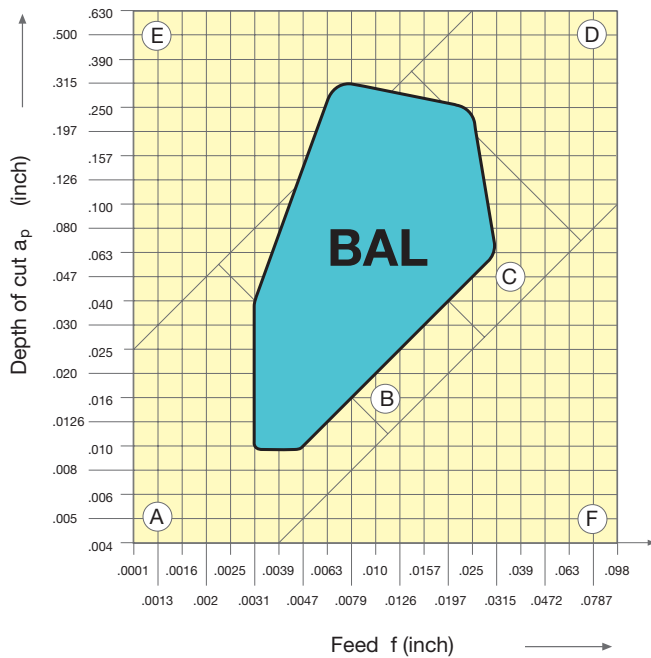

Geometry "BAL"
(Böhlerit ALuminum)





The Color Guide

Find the right indexable insert easily and quickly: LMT-FETTE / Böhlerit's Turning **colorguide**

Böhlerit's **colorguide** leads you through our wide range of indexable inserts. It establishes unexpected order in your tool-shop and accelerates the choice of your tools.

Indexable inserts are highly specialized tools which are hard to distinguish in their variety by simply looking at them. In order to accelerate the search for the right insert, Böhlerit has developed **colorguide** which helps you find the right

colorguide



The perfect colour guide for finding the right indexable insert

Material groups

	ROUGH	MEDIUM	FINE
Steel	Blue	Light Blue	Very Light Blue
Stainless steel	Yellow	Light Yellow	Very Light Yellow
Iron casting	Red	Light Red	Very Light Red
Non-ferrous metal	Green	Light Green	Very Light Green
High-temperature alloys	Orange	Light Orange	Very Light Orange
Hardened materials	White	Light Grey	Very Light Grey

Machining mode

	Feed f (mm)	Depth of cut a_p (mm)
ROUGH	0,6 - 1,2	5 - 15
MEDIUM	0,25 - 0,6	1,5 - 5
FINE	0,05 - 0,25	0,1 - 1,5

Application areas

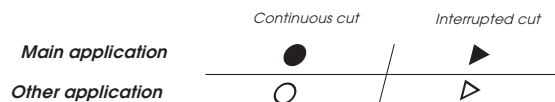

Example

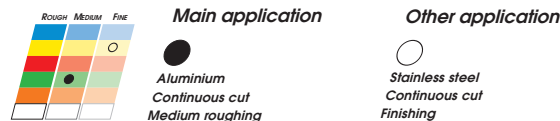

indexable insert quickly and without any difficulties. **colorguide** saves time, avoids wrong applications and thus ensures the economic efficiency of your metal processing.



Turning Grades Overview

Grade	ISO	Range of applications 01 05 10 15 20 25 30 35 40 45 50	Group of materials						Application					
			P Steel	M Stainless	K Gray cast iron	N Nonferrous materials (Al, etc.)	S High temperature materials	H Hard materials	T Turning	M Milling	D Drilling	S Threading	G Grooving	P Parting
LC215B	HC-P15		■						●					
	HC-K15				□				●					
LC225C	HC-P25		■						●					
	HC-M25			■					●					
LC235C	HC-P35		■						●					
	HC-M35			■					●					
LC435D	HC-M35			■					●					
	HC-P35		□						●					
LC610A	HC-K10					■			●	●				
LC610M	HC-K10		□	■	□	■			●	●				
LW610	HW-K10				■	□			●	●	●	●	●	●

Application peak

Full range to ISO 513

■ Main application

□ Further applications

● Standard grade

Insert Grade Designation

The LMT-FETTE grade designation system constitutes a simple key. In accordance with the ISO norm, it describes the material in an application-oriented way.

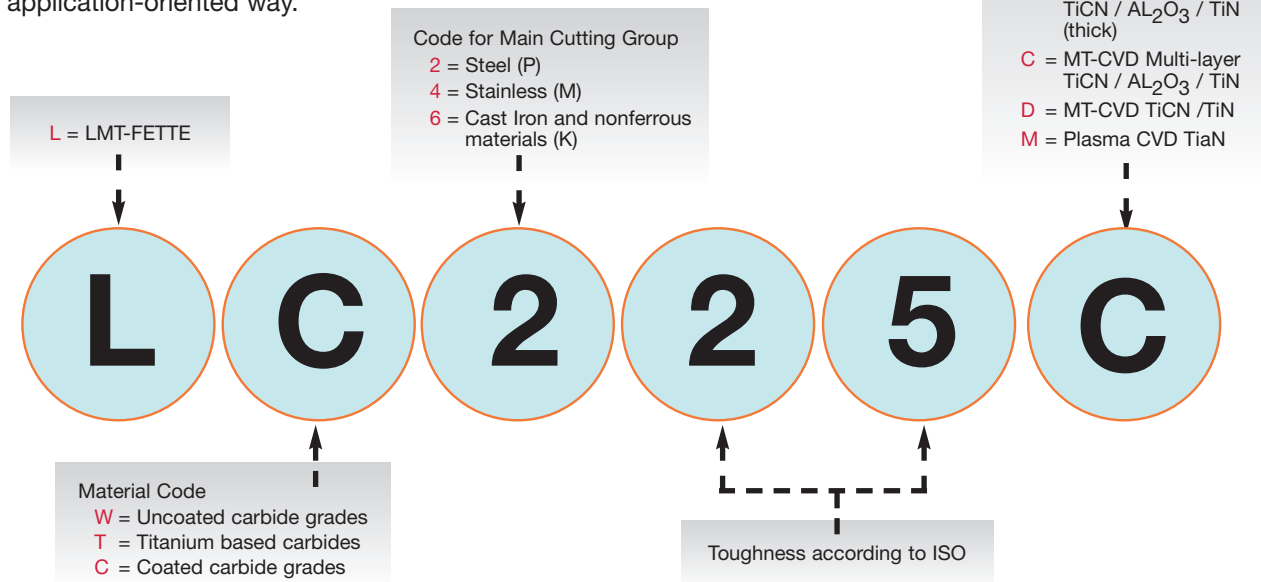

Turning Grades Overview

COATED GRADES

LC215B (HC-P15, HC-K15)

(Turbo Turning Grade)

Preferred grade for the **highest cutting speeds** for light to medium turning work on structural steel, alloyed steel and spheroidal irons, even with occasionally interrupted cutting. Additional area of application; also suitable for working grey cast iron. Recommended cutting data for LC215B can be found on page 64.

LC225C (HC-P25, HC-M25)

(Global Turning Grade)

Main grade for machining steel materials and easily machinable stainless steels at **medium cutting speeds**, including interrupted cutting work. This general purpose grade is characterized by the properties of high durability and excellent toughness across a wide range of applications. Recommended cutting data for LC225C can be found on page 65.

LC235C (HC-P35, HC-M35)

Grade for turning of steel and cast steel under unfavorable conditions and at **medium to low cutting speed**. Suitable for machining of stainless steels. Recommended cutting data for LC235C can be found on page 66.

LC435D (HC-M35, HC-P35)

Main grade for turning of austenitic stainless steel at **medium to high cutting speed**. Additional application for super alloys. Recommended cutting data for LC435C can be found on page 67.

LC610A (HC-K10) Diamond Coated

Specially suitable for machining of synthetic materials (glass fiber and carbon fiber composites) as well as aluminum-silicon alloys. Recommended cutting data for LC610A can be found on page 69.

LC610M (HC-K10, HC-M10)

The ideal grade for working aluminum materials and other non-ferrous metals. Thanks to a very thin plasma CVD TiAlN coating it is also excellent for finish machining of stainless steels and grey cast iron. Recommended cutting data for LC610M can be found on page 68.

UNCOATED GRADE

LW610 (K10)

Classic hard metal grade for turning short-chipping materials, standard grade for drilling, countersinking and reaming steel. Also for channelling chilled cast iron cylinders. Recommended cutting data for LW610 can be found on page 69.

Turning and Boring Insert Identification System

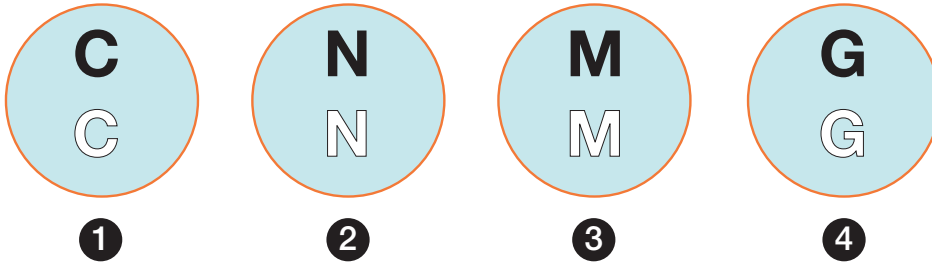

1

Insert Shape

- A
- B
- C
- D
- E
- H
- K
- L
- M
- O
- P
- R
- S
- T
- V
- W

2

Clearance Angle

α_n

- A 3°
- B 5°
- C 7°
- D 15°
- E 20°
- F 25°
- G 30°
- N 0°
- P 11°
- O Normal clearance angles, which require a special description.

3

Tolerances (inches)

	m	s	d
A	±0.0002 ³⁾	±0.001	±0.001
C	±0.0005		
E	±0.001		
F	±0.0002 ³⁾	±0.0005	±0.0005
G	±0.001		
H	±0.0005	±0.001	See Table 5
J	±0.0002 ³⁾		
K	±0.0005 ³⁾		
L	±0.001		
M	See Table 4	±0.005	

Indexable insert with unequal number of sides.

Indexable insert with equal number of sides.

3) generally used for indexable inserts with ground face cutting edges.

Table 4-m

d		M	U
Over .154	Up to .394	±0.003	±0.005
.394	.590	±0.005	±0.008
.590	.787	±0.006	±0.011
.787	1.024	±0.007	±0.015
1.024	1.260	±0.008	±0.015

Table 5-d

d		J, K, L, M	U
Over .154	Up to .394	±0.002	±0.003
.394	.590	±0.003	±0.005
.590	.787	±0.004	±0.007
.787	1.024	±0.005	±0.001
1.024	1.260	±0.006	±0.001

Note 1: In case of more than one angle, always use smallest angle.

4

Cutting Face, Clamp Style

<p>A </p> <p>Without chip breaker with cylindrical fixation hole.</p>	<p>N </p> <p>Without chip breakers, without fixation hole.</p>	<p>U </p> <p>Chip breakers at both sides with fixation hole conical from both sides.</p>
<p>F </p> <p>Chip breakers at both sides without fixation hole.</p>	<p>Q </p> <p>Without chip breakers, with fixation hole, conical from both sides.</p>	<p>W </p> <p>Without chip breaker with conical fixation hole.</p>
<p>G </p> <p>Chip breakers at both sides, with cylindrical fixation hole.</p>	<p>R </p> <p>Chip breakers at one side, without fixation hole.</p>	<p>X With special feature to approval drawing</p>
<p>M </p> <p>Chip breaker at one side with cylindrical fixation hole.</p>	<p>T </p> <p>Chip breakers at one side, with fixation hole.</p>	

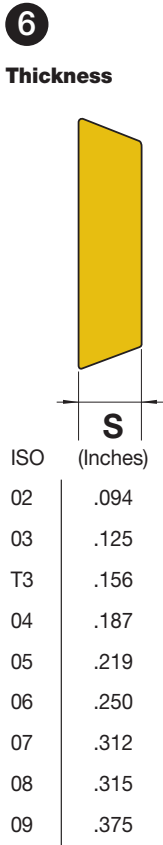
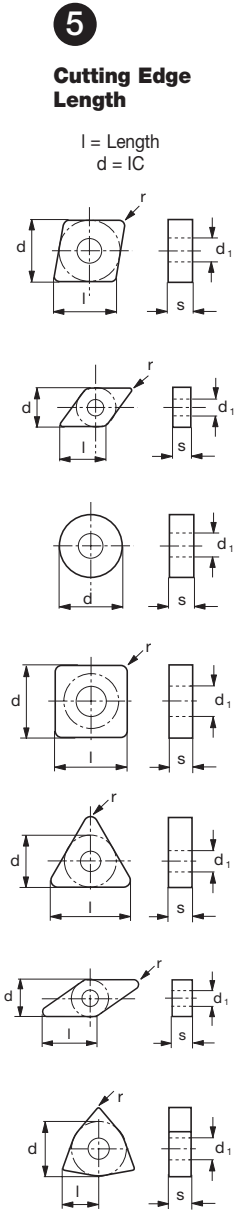
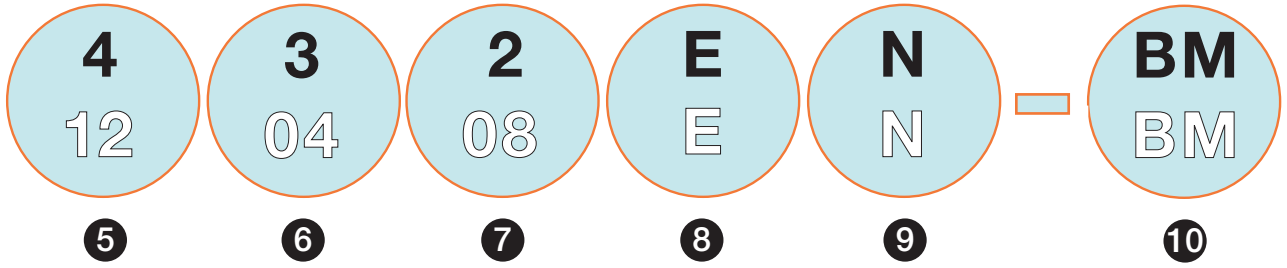

7 Nose Radius

Radius inserts

ISO	Corner radius-r (Inches)
00	sharp-edged
02	0.007 (1/128)
04	0.015 (1/64)
08	0.031 (1/32)
12	0.047 (3/64)
16	0.062 (1/16)
20	0.078 (5/64)
24	0.094 (3/32)
28	0.109 (7/64)
32	0.125 (1/8)

8 Cutting Edge Corner*

All LMT inserts are supplied with standard factory hone.



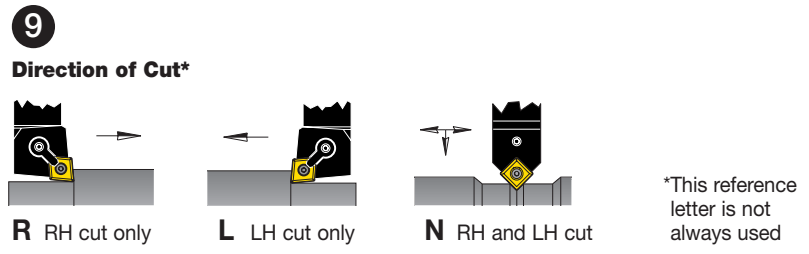



F	Sharp-edged
E	Rounded
T	Chamfered
S	Chamfered and Rounded
K	Doubled Chamfered
P	Double Chamfered and Rounded

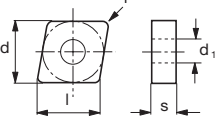

10 Chip Breaker

Steel	BR	BMR	BM	BFM	BF	BSM	BSF
Stainless		BMRS	BMS	BFMS		BSMS	
Cast Iron	A	BMR					
Non Ferrous	BAL						

Indexable Inserts

C.... 	Ordering Code ANSI *)	Sizes in inch						Grade																	
		l edge length	d IC	s thick- ness	d ₁ hole size	r radius	HC	HC	HC				HC				HC	HW	HC						
							LC215B	LC225C	LC235C				LC435D				LC610M	LW610	LC610A						
CCGT-BAL 	CCGT 2 (1.5) (0.5)-BAL	.252	1/4	3/32	.110	1/128											●	●							
	CCGT 2 (1.5) 1-BAL	.252	1/4	3/32	.110	1/64											●	●							
	CCGT 3 (2.5) (0.5)-BAL	.382	5/16	5/32	.173	1/128											●	●							
	CCGT 3 (2.5) 1-BAL	.382	5/16	5/32	.173	1/64											●	●	●						
	CCGT 3 (2.5) 2-BAL	.382	5/16	5/32	.173	1/32											●	●							
	CCGT 431-BAL	.501	1/2	3/16	.217	1/64											●	●	●						
	CCGT 432-BAL	.501	1/2	3/16	.217	1/32											●	●	●						
CCMT-BSF 	CCMT 2 (1.5) (0.5)-BSF	.252	1/4	3/32	.110	1/128	●	●																	
	CCMT 2 (1.5) 1-BSF	.252	1/4	3/32	.110	1/64	●	●																	
	CCMT 2 (1.5) 2-BSF	.252	1/4	3/32	.110	1/32	●	●																	
	CCMT 3 (2.5) 1-BSF	.382	5/16	5/32	.173	1/64	●	●																	
	CCMT 3 (2.5) 2-BSF	.382	5/16	5/32	.173	1/32	●	●																	
	CCMT 431-BSF	.501	1/2	3/16	.217	1/64	●	●																	
	CCMT 432-BSF	.501	1/2	3/16	.217	1/32	●	●																	
CCMT-BSM 	CCMT 2 (1.5) (0.5)-BSM	.252	1/4	3/32	.110	1/128	●	●																	
	CCMT 2 (1.5) 1-BSM	.252	1/4	3/32	.110	1/64	●	●																	
	CCMT 2 (1.5) 2-BSM	.252	1/4	3/32	.110	1/32	●	●																	
	CCMT 3 (2.5) 1-BSM	.382	5/16	5/32	.173	1/64	●	●	●																
	CCMT 3 (2.5) 2-BSM	.382	5/16	5/32	.173	1/32	●	●	●																
	CCMT 431-BSM	.501	1/2	3/16	.217	1/64	●	●	●																
	CCMT 432-BSM	.501	1/2	3/16	.217	1/32	●	●	●																
CCMT-BSMS 	CCMT 3 (2.5) 1-BSMS	.382	5/16	5/32	.173	1/64							●												
	CCMT 3 (2.5) 2-BSMS	.382	5/16	5/32	.173	1/32							●												
	CCMT 431-BSMS	.501	1/2	3/16	.217	1/64							●												
	CCMT 432-BSMS	.501	1/2	3/16	.217	1/32							●												
CNMA 	CNMA 432	.501	1/2	3/16	.203	1/32	●																		
	CNMA 433	.501	1/2	3/16	.203	3/64	●																		

Order example: Pkg. Qty. 10 CCMT 2 (1.5) 1-BSM LC610M

Toolholders: pages 50-61

Cutting data recommendations: pages 64-69

*) Insert Identification System: pages 16-17







● : Available from stock

Indexable Inserts

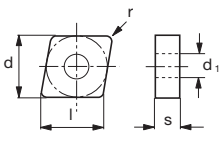
Ordering Code ANSI	Ordering numbers														
	HC	HC	HC				HC			HC	HW	HC			
	LC215B	LC225C	LC235C				LC435D			LC610M	LW610	LC610A			
CCGT 2 (1.5) (0.5)-BAL										89325	74083				
CCGT 2 (1.5) 1-BAL										89326	74084				
CCGT 3 (2.5) (0.5)-BAL										89327	74085				
CCGT 3 (2.5) 1-BAL										89328	74086	74087			
CCGT 3 (2.5) 2-BAL										89329	74088				
CCGT 431-BAL										89330	74089	10558			
CCGT 432-BAL										89267	74091	10523			
CCMT 2 (1.5) (0.5)-BSF	74093	74094													
CCMT 2 (1.5) 1-BSF	74097	74098													
CCMT 2 (1.5) 2-BSF	74101	74102													
CCMT 3 (2.5) 1-BSF	74105	74106													
CCMT 3 (2.5) 2-BSF	74111	74112													
CCMT 431-BSF	74117	74118													
CCMT 432-BSF	74123	74124													
CCMT 2 (1.5) (0.5)-BSM	74095	74096													
CCMT 2 (1.5) 1-BSM	74099	74100													
CCMT 2 (1.5) 2-BSM	74103	74104													
CCMT 3 (2.5) 1-BSM	74107	74108	74109												
CCMT 3 (2.5) 2-BSM	74113	51081	74115												
CCMT 431-BSM	74119	74120	74121												
CCMT 432-BSM	74125	74126	74127												
CCMT 3 (2.5) 1-BSMS							74110								
CCMT 3 (2.5) 2-BSMS							74116								
CCMT 431-BSMS							74122								
CCMT 432-BSMS							74128								
CNMA 432	74129														
CNMA 433	17452														

Order example: Pkg. Qty. 10 EDP 12345

Indexable Inserts

C.... 	Ordering Code ANSI *)	Sizes in inch					Grade													
		l <i>edge length</i>	d <i>IC</i>	s <i>thick-ness</i>	d ₁ <i>hole size</i>	r <i>radius</i>	HC	HC	HC			HC		HC	HW	HC				
							LC215B	LC225C	LC235C			LC435D		LC610M	LW610	LC610A				
CNMG-BF 	CNMG 321-BF	.382	5/16	1/8	.150	1/64	●													
	CNMG 431-BF	.501	1/2	3/16	.203	1/64	●													
	CNMG 432-BF	.501	1/2	3/16	.203	1/32	●	●												
	CNMG 433-BF	.501	1/2	3/16	.203	3/64	●													
CNMG-BFM 	CNMG 321-BFM	.382	5/16	1/8	.150	1/64	●	●	●											
	CNMG 431-BFM	.501	1/2	3/16	.203	1/64	●	●	●											
	CNMG 432-BFM	.501	1/2	3/16	.203	1/32	●	●	●											
	CNMG 433-BFM	.501	1/2	3/16	.203	3/64	●	●	●											
CNMG-BFMS 	CNMG 321-BFMS	.382	5/16	1/8	.150	1/64							●							
	CNMG 431-BFMS	.501	1/2	3/16	.203	1/64							●							
	CNMG 432-BFMS	.501	1/2	3/16	.203	1/32							●							
	CNMG 433-BFMS	.501	1/2	3/16	.203	3/64							●							
CNMG-BM 	CNMG 321-BM	.382	5/16	1/8	.150	1/64	●	●	●											
	CNMG 322-BM	.382	5/16	1/8	.150	1/32	●	●	●											
	CNMG 432-BM	.501	1/2	3/16	.203	1/32	●	●	●											
	CNMG 433-BM	.501	1/2	3/16	.203	3/64	●	●	●											
	CNMG 434-BM	.501	1/2	3/16	.203	1/16	●	●	●											
	CNMG 542-BM	.634	5/8	1/4	.250	1/32	●	●	●											
	CNMG 543-BM	.634	5/8	1/4	.250	3/64	●	●	●											
	CNMG 544-BM	.634	5/8	1/4	.250	1/16	●	●	●											
	CNMG 643-BM	.760	3/4	1/4	.312	3/64	●	●	●											
	CNMG 644-BM	.760	3/4	1/4	.312	1/16	●	●	●											
CNMG-BMR 	CNMG 432-BMR	.501	1/2	3/16	.203	1/32	●	●	●											
	CNMG 433-BMR	.501	1/2	3/16	.203	3/64	●	●	●											
	CNMG 434-BMR	.501	1/2	3/16	.203	1/16	●	●	●											
	CNMG 543-BMR	.634	5/8	1/4	.250	3/64	●	●	●											
	CNMG 544-BMR	.634	5/8	1/4	.250	1/16	●	●	●											
	CNMG 642-BMR	.760	3/4	1/4	.312	1/32	●	●	●											
	CNMG 643-BMR	.760	3/4	1/4	.312	3/64	●	●	●											
	CNMG 644-BMR	.760	3/4	1/4	.312	1/16	●	●	●											

Order example: Pkg. Qty. 10 CCMT 2 (1.5) 1-BSM LC610M

Toolholders: pages 50–61

Cutting data recommendations: pages 64–69

*) Insert Identification System: pages 16–17





● : Available from stock

Indexable Inserts

Ordering Code ANSI	Ordering numbers														
	HC	HC	HC				HC			HC	HW	HC			
	LC215B	LC225C	LC235C				LC435D			LC610M	LW610	LC610A			
CNMG 321-BF	74130														
CNMG 431-BF	74141														
CNMG 432-BF	74145	74146													
CNMG 433-BF	59847														
CNMG 321-BFM	74131	74132	74133												
CNMG 431-BFM	74142	74143	74144												
CNMG 432-BFM	74147	74148	74149												
CNMG 433-BFM	74154	74155	74156												
CNMG 321-BFMS							74134								
CNMG 431-BFMS							10308								
CNMG 432-BFMS							74150								
CNMG 433-BFMS							74157								
CNMG 321-BM	74135	74136	74137												
CNMG 322-BM	74138	74139	74140												
CNMG 432-BM	18403	18404	74151												
CNMG 433-BM	18405	18406	74158												
CNMG 434-BM	74164	74165	74166												
CNMG 542-BM	74169	74170	74171												
CNMG 543-BM	74172	74173	74174												
CNMG 544-BM	74179	74180	74181												
CNMG 643-BM	59848	59849	59850												
CNMG 644-BM	74189	74190	74191												
CNMG 432-BMR	51403	74152	74153												
CNMG 433-BMR	74159	74160	74161												
CNMG 434-BMR	59851	59852	59853												
CNMG 543-BMR	51404	74175	74176												
CNMG 544-BMR	74182	74183	74184												
CNMG 642-BMR	74185	74186	74187												
CNMG 643-BMR	18323	18198	74188												
CNMG 644-BMR	74192	74193	74194												

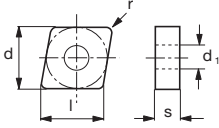
Order example: Pkg. Qty. 10 EDP 12345

Indexable Inserts

C.... 	Ordering Code ANSI *)	Sizes in inch					Grade													
		l <i>edge length</i>	d <i>IC</i>	s <i>thick-ness</i>	d ₁ <i>hole size</i>	r <i>radius</i>	HC	HC	HC			HC		HC	HW	HC				
							LC215B	LC225C	LC235C			LC435D		LC610M	LW610	LC610A				
CNMG-BMRS 	CNMG 432-BMRS	.501	1/2	3/16	.203	1/32							●							
	CNMG 433-BMRS	.501	1/2	3/16	.203	3/64							●							
	CNMG 434-BMRS	.501	1/2	3/16	.203	1/16							●							
	CNMG 543-BMRS	.634	5/8	1/4	.250	3/64							●							
	CNMG 544-BMRS	.634	5/8	1/4	.250	1/16							●							
	CNMG 643-BMRS	.760	3/4	1/4	.312	3/64							●							
	CNMG 644-BMRS	.760	3/4	1/4	.312	1/16							●							
CNMG-BMS 	CNMG 432-BMS	.501	1/2	3/16	.203	1/32							●							
	CNMG 433-BMS	.501	1/2	3/16	.203	3/64							●							
	CNMG 434-BMS	.501	1/2	3/16	.203	1/16							●							
	CNMG 543-BMS	.634	5/8	1/4	.250	3/64							●							
	CNMG 544-BMS	.634	5/8	1/4	.250	1/16							●							
CNMM-BR 	CNMM 432-BR	.501	1/2	3/16	.203	1/32	●	●	●											
	CNMM 433-BR	.501	1/2	3/16	.203	3/64	●	●	●											
	CNMM 434-BR	.501	1/2	3/16	.203	1/16	●	●	●											
	CNMM 543-BR	.634	5/8	1/4	.250	3/64	●	●	●											
	CNMM 544-BR	.634	5/8	1/4	.250	1/16	●	●	●											
	CNMM 643-BR	.760	3/4	1/4	.312	3/64	●	●	●											
	CNMM 644-BR	.760	3/4	1/4	.312	1/16	●	●	●											
	CNMM 646-BR	.760	3/4	1/4	.312	3/32	●	●	●											

Order example: Pkg. Qty. 10 CCMT 2 (1.5) 1-BSM LC610M

Toolholders: pages 50–61

Cutting data recommendations: pages 64–69

*) Insert Identification System: pages 16–17

● : Available from stock

Indexable Inserts

Ordering Code ANSI	Ordering numbers															
	HC	HC	HC				HC			HC	HW	HC				
	LC215B	LC225C	LC235C				LC435D			LC610M	LW610	LC610A				
CNMG 432-BMRS							10309									
CNMG 433-BMRS							74162									
CNMG 434-BMRS							74167									
CNMG 543-BMRS							74177									
CNMG 544-BMRS							51244									
CNMG 643-BMRS							51472									
CNMG 644-BMRS							74195									
CNMG 432-BMS							50732									
CNMG 433-BMS							74163									
CNMG 434-BMS							74168									
CNMG 543-BMS							74178									
CNMG 544-BMS							51243									
CNMM 432-BR	18399	18400	74196													
CNMM 433-BR	18401	18402	74197													
CNMM 434-BR	74198	74199	74200													
CNMM 543-BR	74201	50667	74202													
CNMM 544-BR	74203	74204	74205													
CNMM 643-BR	89226	74206	74207													
CNMM 644-BR	74208	74209	74210													
CNMM 646-BR	59854	59855	59856													

Order example: Pkg. Qty. 10 EDP 12345

Indexable Inserts

D.... 	Ordering Code ANSI *)	Sizes in inch					Grade																	
		l <i>edge length</i>	d <i>IC</i>	s <i>thick-ness</i>	d ₁ <i>hole size</i>	r <i>radius</i>	HC	HC	HC			HC		HC	HW	HC								
DCGT-BAL 	DCGT 2 (1.5) (0.5)-BAL	.305	1/4	3/32	.110	1/128									●	●								
	DCGT 2 (1.5) 1-BAL	.305	1/4	3/32	.110	1/64									●	●								
	DCGT 3 (2.5) (0.5)-BAL	.457	3/8	5/32	.173	1/128									●	●								
	DCGT 3 (2.5) 1-BAL	.457	3/8	5/32	.173	1/64									●	●	●							
	DCGT 3 (2.5) 2-BAL	.457	3/8	5/32	.173	1/32									●	●	●							
DCMT 	DCMT 432	.610	1/2	3/16	.217	1/32	●	●	●															
	DCMT 433	.610	1/2	3/16	.217	3/64	●	●	●															
DCMT-BSF 	DCMT 2 (1.5) (0.5)-BSF	.305	1/4	3/32	.110	1/128	●	●																
	DCMT 2 (1.5) 1-BSF	.305	1/4	3/32	.110	1/64	●	●																
	DCMT 3 (2.5) 1-BSF	.457	3/8	5/32	.173	1/64	●	●																
	DCMT 3 (2.5) 2-BSF	.457	3/8	5/32	.173	1/32	●	●																
DCMT-BSM 	DCMT 2 (1.5) (0.5)-BSM	.305	1/4	3/32	.110	1/128	●	●																
	DCMT 2 (1.5) 1-BSM	.305	1/4	3/32	.110	1/64	●	●																
	DCMT 2 (1.5) 2-BSM	.305	1/4	3/32	.110	1/32	●	●																
	DCMT 3 (2.5) 1-BSM	.457	3/8	5/32	.173	1/64	●	●	●															
	DCMT 3 (2.5) 2-BSM	.457	3/8	5/32	.173	1/32	●	●	●															
DCMT-BSMS 	DCMT 3 (2.5) 1-BSMS	.457	3/8	5/32	.173	1/64							●											
	DCMT 3 (2.5) 2-BSMS	.457	3/8	5/32	.173	1/32							●											
DNMA 	DNMA 442	.610	1/2	1/4	.203	1/32	●																	
DNMG-BF 	DNMG 331-BF	.457	3/8	3/16	.156	1/64	●																	
	DNMG 332-BF	.457	3/8	3/16	.156	1/32	●																	
	DNMG 333-BF	.457	3/8	3/16	.156	3/64	●																	
	DNMG 431-BF	.610	1/2	3/16	.203	1/64	●	●																
	DNMG 432-BF	.610	1/2	3/16	.203	1/32	●	●																
	DNMG 433-BF	.610	1/2	3/16	.203	3/64	●																	
	DNMG 441-BF	.610	1/2	1/4	.203	1/64	●																	
	DNMG 442-BF	.610	1/2	1/4	.203	1/32	●																	

cont. on page 26 & 27

Order example: Pkg. Qty. 10 CCMT 2 (1.5) 1-BSM LC610M

Toolholders: pages 50–61

Cutting data recommendations: pages 64–69

*) Insert Identification System: pages 16–17

● : Available from stock

Indexable Inserts

Ordering Code ANSI	Ordering numbers															
	HC	HC	HC				HC			HC	HW	HC				
	LC215B	LC225C	LC235C				LC435D			LC610M	LW610	LC610A				
DCGT 2 (1.5) (0.5)-BAL										89305	74214					
DCGT 2 (1.5) 1-BAL										89306	74216					
DCGT 3 (2.5) (0.5)-BAL										89331	74219					
DCGT 3 (2.5) 1-BAL										89332	74220	74221				
DCGT 3 (2.5) 2-BAL										89307	74222	74223				
DCMT 432	74243	74244	74245													
DCMT 433	74246	74247	59857													
DCMT 2 (1.5) (.5)-BSF	74224	74225														
DCMT 2 (1.5) 1-BSF	74228	74229														
DCMT 3 (2.5) 1-BSF	74232	74233														
DCMT 3 (2.5) 2-BSF	74238	18325														
DCMT 2 (1.5) (0.5)-BSM	74226	74227														
DCMT 2 (1.5) 1-BSM	74230	74231														
DCMT 2 (1.5) 2-BSM	60675	60676														
DCMT 3 (2.5) 1-BSM	74234	74235	74236													
DCMT 3 (2.5) 2-BSM	74239	74240	74241													
DCMT 3 (2.5) 1-BSMS							74237									
DCMT 3 (2.5) 2-BSMS							74242									
DNMA 442	74248															
DNMG 331-BF	74253															
DNMG 332-BF	74258															
DNMG 333-BF	74266															
DNMG 431-BF	74291	74292														
DNMG 432-BF	74301	74302														
DNMG 433-BF	74315															
DNMG 441-BF	59859															
DNMG 442-BF	59860															

Order example: Pkg. Qty. 10 EDP 12345

Indexable Inserts

D.... 	Ordering Code ANSI *)	Sizes in inch					Grade													
		l <i>edge length</i>	d <i>IC</i>	s <i>thick-ness</i>	d ₁ <i>hole size</i>	r <i>radius</i>	HC	HC	HC			HC		HC	HW	HC				
							LC215B	LC225C	LC235C			LC435D		LC610M	LW610	LC610A				
DNMG-BF cont. from page 24 & 25	DNMG 443-BF	.610	1/2	1/4	.203	3/64	●													
DNMG-BFM 	DNMG 331-BFM	.457	3/8	3/16	.156	1/64	●	●	●											
	DNMG 332-BFM	.457	3/8	3/16	.156	1/32	●	●	●											
	DNMG 333-BFM	.457	3/8	3/16	.156	3/64	●	●	●											
	DNMG 431-BFM	.610	1/2	3/16	.203	1/64	●	●	●											
	DNMG 432-BFM	.610	1/2	3/16	.203	1/32	●	●	●											
	DNMG 433-BFM	.610	1/2	3/16	.203	3/64	●	●	●											
	DNMG 441-BFM	.610	1/2	1/4	.203	1/64	●	●	●											
	DNMG 442-BFM	.610	1/2	1/4	.203	1/32	●	●	●											
	DNMG 443-BFM	.610	1/2	1/4	.203	3/64	●	●	●											
DNMG-BFMS 	DNMG 331-BFMS	.457	3/8	3/16	.156	1/64							●							
	DNMG 431-BFMS	.610	1/2	3/16	.203	1/64							●							
	DNMG 432-BFMS	.610	1/2	3/16	.203	1/32							●							
	DNMG 433-BFMS	.610	1/2	3/16	.203	3/64							●							
	DNMG 441-BFMS	.610	1/2	1/4	.203	1/64							●							
	DNMG 442-BFMS	.610	1/2	1/4	.203	1/32							●							
	DNMG 443-BFMS	.610	1/2	1/4	.203	3/64							●							
DNMG-BM 	DNMG 332-BM	.457	3/8	3/16	.156	1/32	●	●	●											
	DNMG 333-BM	.457	3/8	3/16	.156	3/64	●	●	●											
	DNMG 432-BM	.610	1/2	3/16	.203	1/32	●	●	●											
	DNMG 433-BM	.610	1/2	3/16	.203	3/64	●	●	●											
	DNMG 434-BM	.610	1/2	3/16	.203	1/16	●	●	●											
	DNMG 442-BM	.610	1/2	1/4	.203	1/32	●	●	●											
	DNMG 443-BM	.610	1/2	1/4	.203	3/64	●	●	●											
	DNMG 444-BM	.610	1/2	1/4	.203	1/16	●	●	●											
DNMG-BMR 	DNMG 432-BMR	.610	1/2	3/16	.203	1/32	●	●	●											
	DNMG 433-BMR	.610	1/2	3/16	.203	3/64	●	●	●											
	DNMG 434-BMR	.610	1/2	3/16	.203	1/16	●	●	●											
	DNMG 442-BMR	.610	1/2	1/4	.203	1/32	●	●	●											
	DNMG 443-BMR	.610	1/2	1/4	.203	3/64	●	●	●											
	DNMG 444-BMR	.610	1/2	1/4	.203	1/16	●	●	●											

Order example: Pkg. Qty. 10 CCMT 2 (1.5) 1-BSM LC610M

Toolholders: pages 50–61

Cutting data recommendations: pages 64–69

*) Insert Identification System: pages 16–17





● : Available from stock

Indexable Inserts

Ordering Code ANSI	Ordering numbers															
	HC	HC	HC				HC			HC	HW	HC				
	LC215B	LC225C	LC235C				LC435D			LC610M	LW610	LC610A				
DNMG 443-BF	59861															
DNMG 331-BFM	74254	74255	74256													
DNMG 332-BFM	74259	74260	74261													
DNMG 333-BFM	74267	74268	74269													
DNMG 431-BFM	74293	74294	74295													
DNMG 432-BFM	74303	74304	74305													
DNMG 433-BFM	74316	74317	74318													
DNMG 441-BFM	59862	59863	59864													
DNMG 442-BFM	59865	59866	59867													
DNMG 443-BFM	59868	59869	59870													
DNMG 331-BFMS							74257									
DNMG 431-BFMS							74296									
DNMG 432-BFMS							74306									
DNMG 433-BFMS							74319									
DNMG 441-BFMS							59871									
DNMG 442-BFMS							59872									
DNMG 443-BFMS							10435									
DNMG 332-BM	74262	74263	74264													
DNMG 333-BM	74270	74271	74272													
DNMG 432-BM	74307	74308	74309													
DNMG 433-BM	74320	74321	74322													
DNMG 434-BM	74328	74329	74330													
DNMG 442-BM	59874	59875	59876													
DNMG 443-BM	10434	59878	59879													
DNMG 444-BM	59880	59881	59882													
DNMG 432-BMR	74310	74311	74312													
DNMG 433-BMR	74323	74324	74325													
DNMG 434-BMR	74331	74332	74333													
DNMG 442-BMR	59883	59884	59885													
DNMG 443-BMR	59886	59887	59888													
DNMG 444-BMR	59889	59890	59891													

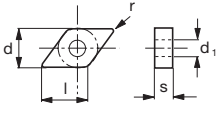
Order example: Pkg. Qty. 10 EDP 12345

Indexable Inserts

D.... 	Ordering Code ANSI *)	Sizes in inch					Grade																					
		l <i>edge length</i>	d <i>IC</i>	s <i>thick-ness</i>	d ₁ <i>hole size</i>	r <i>radius</i>	HC	HC	HC				HC			HC	HW	HC										
DNMG-BMRS 	DNMG 432-BMRS	.610	1/2	3/16	.203	1/32									●													
	DNMG 433-BMRS	.610	1/2	3/16	.203	3/64									●													
	DNMG 434-BMRS	.610	1/2	3/16	.203	1/16									●													
	DNMG 442-BMRS	.610	1/2	1/4	.203	1/32									●													
	DNMG 443-BMRS	.610	1/2	1/4	.203	3/64									●													
	DNMG 444-BMRS	.610	1/2	1/4	.203	1/16									●													
DNMG-BMS 	DNMG 332-BMS	.457	3/8	3/16	.156	1/32									●													
	DNMG 432-BMS	.610	3/8	3/16	.203	1/32									●													
	DNMG 433-BMS	.610	3/8	3/16	.203	3/64									●													
	DNMG 434-BMS	.610	3/8	3/16	.203	1/16									●													
	DNMG 442-BMS	.610	1/2	1/4	.203	1/32									●													
	DNMG 443-BMS	.610	1/2	1/4	.203	3/64									●													
	DNMG 444-BMS	.610	1/2	1/4	.203	1/16									●													
DNMG..E.-BC 	DNMG 331EL-BC	.457	3/8	3/16	.156	1/64	●	●	●																			
	DNMG 331ER-BC	.457	3/8	3/16	.156	1/64	●	●	●																			
	DNMG 332EL-BC	.457	3/8	3/16	.156	1/32	●	●	●																			
	DNMG 332ER-BC	.457	3/8	3/16	.156	1/32	●	●	●																			
	DNMG 431EL-BC	.610	1/2	3/16	.203	1/64	●	●	●																			
	DNMG 431ER-BC	.610	1/2	3/16	.203	1/64	●	●	●																			
	DNMG 432EL-BC	.610	1/2	3/16	.203	1/32	●	●	●																			
	DNMG 432ER-BC	.610	1/2	3/16	.203	1/32	●	●	●																			
	DNMG 441EL-BC	.610	1/2	1/4	.203	1/64	●	●	●																			
	DNMG 441ER-BC	.610	1/2	1/4	.203	1/64	●	●	●																			
	DNMG 442EL-BC	.610	1/2	1/4	.203	1/32	●	●	●																			
	DNMG 442ER-BC	.610	1/2	1/4	.203	1/32	●	●	●																			
DNMM-BR 	DNMM 432-BR	.610	1/2	3/16	.203	1/32	●	●	●																			
	DNMM 433-BR	.610	1/2	3/16	.203	3/64	●	●	●																			
	DNMM 442-BR	.610	1/2	1/4	.203	1/32	●	●	●																			
	DNMM 443-BR	.610	1/2	1/4	.203	3/64	●	●	●																			

Order example: Pkg. Qty. 10 CCMT 2 (1.5) 1-BSM LC610M

Toolholders: pages 50–61

Cutting data recommendations: pages 64–69

*) Insert Identification System: pages 16–17



● : Available from stock

Indexable Inserts

Ordering Code ANSI	Ordering numbers														
	HC	HC	HC				HC			HC	HW	HC			
	LC215B	LC225C	LC235C				LC435D			LC610M	LW610	LC610A			
DNMG 432-BMRS							74313								
DNMG 433-BMRS							74326								
DNMG 434-BMRS							74334								
DNMG 442-BMRS							59892								
DNMG 443-BMRS							59893								
DNMG 444-BMRS							59894								
DNMG 332-BMS							74265								
DNMG 432-BMS							74314								
DNMG 433-BMS							74327								
DNMG 434-BMS							74335								
DNMG 442-BMS							59898								
DNMG 443-BMS							59899								
DNMG 444-BMS							59900								
DNMG 331EL-BC	74249	74250	59901												
DNMG 331ER-BC	74251	74252	59902												
DNMG 332EL-BC	59903	59904	59905												
DNMG 332ER-BC	59906	59907	59908												
DNMG 431EL-BC	74287	74288	59909												
DNMG 431ER-BC	74289	74290	59910												
DNMG 432EL-BC	74297	74298	59911												
DNMG 432ER-BC	74299	74300	59912												
DNMG 441EL-BC	59913	59914	59915												
DNMG 441ER-BC	59916	59917	59918												
DNMG 442EL-BC	59919	59920	59921												
DNMG 442ER-BC	59922	59923	59924												
DNMM 432-BR	59925	59926	59927												
DNMM 433-BR	59928	59929	59930												
DNMM 442-BR	59931	59932	59933												
DNMM 443-BR	59934	59935	59936												

Order example: Pkg. Qty. 10 EDP 12345

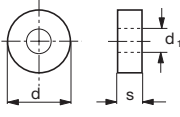
Indexable Inserts

R.... 	Ordering Code ANSI *)	Sizes					Grade															
		d mm <i>edge length</i>	d inch <i>IC</i>	s inch <i>thick-ness</i>	d ₁ inch <i>hole size</i>	r radius	HC	HC	HC			HC		HC	HW	HC						
RCGT-BAL 	RCGT 0602M0-BAL	6.0	.236	3/32	.110										●	●						
	RCGT 0803M0-BAL	8.0	.315	1/8	.134										●	●	●					
	RCGT 1003M0-BAL	10.0	.394	1/8	.157										●	●						
RCMX 	RCMX 1003M0	10.0	.394	1/8	.142				●													
	RCMX 1204M0	12.0	.472	3/16	.165				●													
	RCMX 1606M0	16.0	.630	1/4	.205				●													
	RCMX 2006M0	20.0	.787	1/4	.256			●	●													
	RCMX 2507M0	25.0	.984	5/16	.283			●	●													
	RCMX 3209M0	32.0	1.260	3/8	.374			●														

Order example: Pkg. Qty. 10 CCMT 2 (1.5) 1-BSM LC610M

Toolholders: pages 50–61

Cutting data recommendations: pages 64–69

*) Insert Identification System: pages 16–17







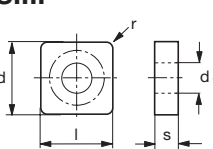

● : Available from stock

Indexable Inserts

Ordering Code ANSI	Ordering numbers															
	HC	HC	HC				HC			HC	HW	HC				
	LC215B	LC225C	LC235C				LC435D			LC610M	LW610	LC610A				
RCGT 0602M0-BAL										89333	74336					
RCGT 0803M0-BAL										89334	74337	74338				
RCGT 1003M0-BAL										89335	74339					
RCMX 1003M0			59937													
RCMX 1204M0			59938													
RCMX 1606M0			59939													
RCMX 2006M0		59940	59941													
RCMX 2507M0		59942	59943													
RCMX 3209M0		51465														

Order example: Pkg. Qty. 10 EDP 12345

Indexable Inserts

S.... 	Ordering Code ANSI *)	Sizes in inch					Grade												
		l <i>edge length</i>	d <i>IC</i>	s <i>thick-ness</i>	d ₁ <i>hole size</i>	r <i>radius</i>	HC	HC	HC			HC		HC	HW	HC			
SCGT-BAL 	SCGT 432-BAL	.500	1/2	3/16	.217	1/32	LC215B	LC225C	LC235C			LC435D		LC610M	LW610	LC610A			
SCMT 	SCMT 431	.500	1/2	3/16	.217	1/64		●											
SCMT-BSF 	SCMT 3 (2.5) 1-BSF	.375	3/8	5/32	.173	1/64	●	●											
	SCMT 431-BSF	.500	1/2	3/16	.217	1/64	●	●											
SCMT-BSM 	SCMT 3 (2.5) 2-BSM	.375	3/8	5/32	.173	1/32	●	●	●										
	SCMT 432-BSM	.500	1/2	3/16	.217	1/32	●	●	●										
	SCMT 433-BSM	.500	1/2	3/16	.217	3/64	●	●	●										
SCMT-BSMS 	SCMT 432-BSMS	.500	1/2	3/16	.217	1/32					●								
SNMA 	SNMA 432	.500	1/2	3/16	.203	1/32													
	SNMA 433	.500	1/2	3/16	.203	3/64	●												
	SNMA 643	.750	3/4	1/4	.312	3/64	●												
	SNMA 644	.750	3/4	1/4	.312	1/16													
SNMG-BF 	SNMG 431-BF	.500	1/2	3/16	.203	1/64	●												
SNMG-BFM 	SNMG 321-BFM	.375	3/8	1/8	.150	1/64	●	●	●										

Order example: Pkg. Qty. 10 CCMT 2 (1.5) 1-BSM LC610M

Toolholders: pages 50–61

Cutting data recommendations: pages 64–69

*) Insert Identification System: pages 16–17

● : Available from stock

Indexable Inserts

Ordering Code ANSI	Ordering numbers														
	HC	HC	HC				HC			HC	HW	HC			
	LC215B	LC225C	LC235C				LC435D			LC610M	LW610	LC610A			
SCGT 432-BAL										89336	74340				
SCMT 431			59945												
SCMT 3 (2.5) 1-BSF	74341	74342													
SCMT 431-BSF	74344	74345													
SCMT 3 (2.5) 2-BSM	60677	60678	74343												
SCMT 432-BSM	74346	74347	74348												
SCMT 433-BSM	74350	74351	74352												
SCMT 432-BSMS							74349								
SNMA 432															
SNMA 433	17453														
SNMA 643	74353														
SNMA 644															
SNMG 431-BF	74358														
SNMG 321-BFM	74354	74355	74356												

Order example: Pkg. Qty. 10 EDP 12345

Indexable Inserts

S.... 	Ordering Code ANSI *)	Sizes in inch					Grade																	
		l <i>edge length</i>	d <i>IC</i>	s <i>thick-ness</i>	d ₁ <i>hole size</i>	r <i>radius</i>	HC	HC	HC				HC				HC	HW	HC					
SNMG-BFMS 	SNMG 321-BFMS	.375	3/8	1/8	.150	1/64									●									
SNMG-BM 	SNMG 432-BM	.500	1/2	3/16	.203	1/32	●	●	●															
	SNMG 433-BM	.500	1/2	3/16	.203	3/64	●	●	●															
	SNMG 434-BM	.500	1/2	3/16	.203	1/16	●	●	●															
	SNMG 542-BM	.625	5/8	1/4	.250	1/32	●	●	●															
	SNMG 643-BM	.750	3/4	1/4	.312	3/64	●	●	●															
SNMG-BMR 	SNMG 432-BMR	.500	1/2	3/16	.203	1/32	●	●	●															
	SNMG 433-BMR	.500	1/2	3/16	.203	3/64	●	●	●															
	SNMG 543-BMR	.625	5/8	1/4	.250	3/64	●	●	●															
	SNMG 643-BMR	.750	3/4	1/4	.312	3/64	●	●	●															
	SNMG 644-BMR	.750	3/4	1/4	.312	1/16	●	●	●															
SNMG-BMRS 	SNMG 432-BMRS	.500	1/2	3/16	.203	1/32									●									
	SNMG 433-BMRS	.500	1/2	3/16	.203	3/64									●									
	SNMG 543-BMRS	.625	5/8	1/4	.250	3/64									●									
	SNMG 544-BMRS	.625	5/8	1/4	.250	1/16									●									
	SNMG 643-BMRS	.750	3/4	1/4	.312	3/64									●									
	SNMG 644-BMRS	.750	3/4	1/4	.312	1/16									●									
SNMG-BMS 	SNMG 432-BMS	.500	1/2	3/16	.203	1/32									●									
	SNMG 433-BMS	.500	1/2	3/16	.203	3/64									●									
SNMM-BR 	SNMM 432-BR	.500	1/2	3/16	.203	1/32	●	●	●															
	SNMM 433-BR	.500	1/2	3/16	.203	3/64	●	●	●															
	SNMM 543-BR	.625	5/8	1/4	.250	3/64	●	●	●															
	SNMM 643-BR	.750	3/4	1/4	.312	3/64	●	●	●															
	SNMM 644-BR	.750	3/4	1/4	.312	1/16	●	●	●															
	SNMM 646-BR	.750	3/4	1/4	.312	3/32		●	●															

Order example: Pkg. Qty. 10 CCMT 2 (1.5) 1-BSM LC610M

Toolholders: pages 50–61

Cutting data recommendations: pages 64–69

*) Insert Identification System: pages 16–17



● : Available from stock

Indexable Inserts

Ordering Code ANSI	Ordering numbers															
	HC	HC	HC				HC			HC	HW	HC				
	LC215B	LC225C	LC235C				LC435D			LC610M	LW610	LC610A				
SNMG 321-BFMS							74357									
SNMG 432-BM	89224	74359	74360													
SNMG 433-BM	74366	74367	74368													
SNMG 434-BM	74374	74375	74376													
SNMG 542-BM	59946	59947	59948													
SNMG 643-BM	74385	74386	74387													
SNMG 432-BMR	74361	74362	74363													
SNMG 433-BMR	74369	74370	74371													
SNMG 543-BMR	74380	74381	74382													
SNMG 643-BMR	74388	74389	74390													
SNMG 644-BMR	74392	74393	74394													
SNMG 432-BMRS							74364									
SNMG 433-BMRS							74372									
SNMG 543-BMRS							74383									
SNMG 544-BMRS							74384									
SNMG 643-BMRS							74391									
SNMG 644-BMRS							74395									
SNMG 432-BMS							74365									
SNMG 433-BMS							74373									
SNMM 432-BR	59950	74396	74397													
SNMM 433-BR	74398	74399	74400													
SNMM 543-BR	74401	74402	74403													
SNMM 643-BR	74404	74405	74406													
SNMM 644-BR	74407	74408	74409													
SNMM 646-BR		59951	59952													

Order example: Pkg. Qty. 10 EDP 12345

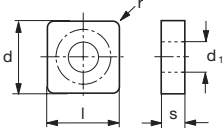
Indexable Inserts

S.... 	Ordering Code ANSI *)	Sizes in inch					Grade												
		l <i>edge length</i>	d <i>IC</i>	s <i>thick-ness</i>	d ₁ <i>hole size</i>	r <i>radius</i>	HC	HC	HC			HC		HC	HW	HC			
SNMM 	SNMM 854	1.000	1	5/16	.359	1/16		●											
	SNMM 856	1.000	1	5/16	.359	3/32		●											
SPMR-FM 	SPMR 321-FM	.375	3/8	1/8	-	1/64	●	●	●										
	SPMR 322-FM	.375	3/8	1/8	-	1/32	●	●	●										
	SPMR 421-FM	.500	1/2	1/8	-	1/64	●	●											
	SPMR 422-FM	.500	1/2	1/8	-	1/32	●	●	●										
	SPMR 423-FM	.500	1/2	1/8	-	3/64	●	●	●										

Order example: Pkg. Qty. 10 CCMT 2 (1.5) 1-BSM LC610M

Toolholders: pages 50–61

Cutting data recommendations: pages 64–69

*) Insert Identification System: pages 16–17







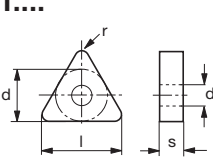

● : Available from stock

Indexable Inserts

Ordering Code ANSI	Ordering numbers															
	HC	HC	HC				HC			HC	HW	HC				
	LC215B	LC225C	LC235C				LC435D			LC610M	LW610	LC610A				
SNMM 854			59953													
SNMM 856			59954													
SPMR 321-FM	59955	59956	59957													
SPMR 322-FM	59958	59959	59960													
SPMR 421-FM	59961	59962														
SPMR 422-FM	59963	59964	59965													
SPMR 423-FM	59966	59967	59968													

Order example: Pkg. Qty. 10 EDP 12345

Indexable Inserts

T.... 	Ordering Code ANSI *)	Sizes in inch					Grade																
		l <i>edge length</i>	d <i>IC</i>	s <i>thick-ness</i>	d ₁ <i>hole size</i>	r <i>radius</i>	HC	HC	HC				HC				HC	HW	HC				
TCGT-BAL 	TCGT 2 (1.5) 1-BAL	.433	1/4	3/32	.110	1/64											●	●	●				
	TCGT 3 (2.5) 1-BAL	.650	3/8	5/32	.173	1/64											●	●	●				
TCMT-BSF 	TCMT 2 (1.5) (0.5)-BSF	.433	1/4	3/32	.110	1/128	●	●															
	TCMT 2 (1.5) 1-BSF	.433	1/4	3/32	.110	1/64	●	●															
	TCMT 2 (1.5) 2-BSF	.433	1/4	3/32	.110	1/32	●	●															
	TCMT 3 (2.5) 1-BSF	.650	3/8	5/32	.173	1/64	●	●															
	TCMT 3 (2.5) 2-BSF	.650	3/8	5/32	.173	1/32	●	●															
TCMT-BSM 	TCMT 2 (1.5) (0.5)-BSM	.433	1/4	3/32	.110	1/128	●	●															
	TCMT 2 (1.5) 1-BSM	.433	1/4	3/32	.110	1/64	●	●	●														
	TCMT 2 (1.5) 2-BSM	.433	1/4	3/32	.110	1/32	●	●	●														
	TCMT 3 (2.5) 1-BSM	.650	3/8	5/32	.173	1/64	●	●	●														
	TCMT 3 (2.5) 2-BSM	.650	3/8	5/32	.173	1/32	●	●	●														
TCMT-BSMS 	TCMT 2 (1.5) 1-BSMS	.433	1/4	3/32	.110	1/64										●							
	TCMT 2 (1.5) 2-BSMS	.433	1/4	3/32	.110	1/32										●							
	TCMT 3 (2.5) 1-BSMS	.650	3/8	5/32	.173	1/64										●							
	TCMT 3 (2.5) 2-BSMS	.650	3/8	5/32	.173	1/32										●							
TNMA 	TNMA 331	.650	3/8	3/16	.150	1/64																	
	TNMA 333	.650	3/8	3/16	.150	3/64	●																
	TNMA 433	.866	1/2	3/16	.203	3/64	●																
TNMG-BF 	TNMG 331-BF	.650	3/8	3/16	.150	1/64	●																
TNMG-BFM 	TNMG 331-BFM	.650	3/8	3/16	.150	1/64	●	●	●														
	TNMG 332-BFM	.650	3/8	3/16	.150	1/32	●	●	●														
	TNMG 333-BFM	.650	3/8	3/16	.150	3/64	●	●	●														

Order example: Pkg. Qty. 10 CCMT 2 (1.5) 1-BSM LC610M

Toolholders: pages 50–61

Cutting data recommendations: pages 64–69

*) Insert Identification System: pages 16–17

● : Available from stock

Indexable Inserts

Ordering Code ANSI	Ordering numbers														
	HC	HC	HC				HC			HC	HW	HC			
	LC215B	LC225C	LC235C				LC435D			LC610M	LW610	LC610A			
TCGT 2 (1.5) 1-BAL										89309	74412	74413			
TCGT 3 (2.5) 1-BAL										89337	74414	10634			
TCMT 2 (1.5) (0.5)-BSF	74416	74417													
TCMT 2 (1.5) 1-BSF	74420	74421													
TCMT 2 (1.5) 2-BSF	74426	74427													
TCMT 3 (2.5) 1-BSF	74432	74433													
TCMT 3 (2.5) 2-BSF	18090	74437													
TCMT 2 (1.5) (0.5)-BSM	74418	74419													
TCMT 2 (1.5) 1-BSM	74422	74423	74424												
TCMT 2 (1.5) 2-BSM	74428	74429	74430												
TCMT 3 (2.5) 1-BSM	74434	51459	74435												
TCMT 3 (2.5) 2-BSM	74438	74439	74440												
TCMT 2 (1.5) 1-BSMS							74425								
TCMT 2 (1.5) 2-BSMS							51060								
TCMT 3 (2.5) 1-BSMS							74436								
TCMT 3 (2.5) 2-BSMS							74441								
TNMA 331															
TNMA 333	74442														
TNMA 433	74443														
TNMG 331-BF	74444														
TNMG 331-BFM	74445	74446	74447												
TNMG 332-BFM	74449	74450	74451												
TNMG 333-BFM	74460	74461	74462												

Order example: Pkg. Qty. 10 EDP 12345

Indexable Inserts

T.... 	Ordering Code ANSI *)	Sizes in inch					Grade													
		l <i>edge length</i>	d <i>IC</i>	s <i>thick-ness</i>	d ₁ <i>hole size</i>	r <i>radius</i>	HC	HC	HC			HC		HC	HW	HC				
TNMG-BFMS 	TNMG 331-BFMS	.650	3/8	3/16	.150	1/64														
	TNMG 332-BFMS	.650	3/8	3/16	.150	1/32														
TNMG-BM 	TNMG 332-BM	.650	3/8	3/16	.150	1/32	●	●	●											
	TNMG 333-BM	.650	3/8	3/16	.150	3/64	●	●	●											
	TNMG 432-BM	.866	1/2	3/16	.203	1/32	●	●	●											
	TNMG 433-BM	.866	1/2	3/16	.203	3/64	●	●	●											
TNMG-BMR 	TNMG 332-BMR	.650	3/8	3/16	.150	1/32	●	●	●											
	TNMG 333-BMR	.650	3/8	3/16	.150	3/64	●	●	●											
	TNMG 433-BMR	.866	1/2	3/16	.203	3/64	●	●	●											
	TNMG 434-BMR	.866	1/2	3/16	.203	1/16	●	●	●											
TNMG-BMS 	TNMG 332-BMS	.650	3/8	3/16	.150	1/32							●							
	TNMG 333-BMS	.650	3/8	3/16	.150	3/64							●							
	TNMG 432-BMS	.866	1/2	3/16	.203	1/32							●							
	TNMG 433-BMS	.866	1/2	3/16	.203	3/64							●							
TNMM-BR 	TNMM 332-BR	.650	3/8	3/16	.150	1/64	●	●	●											
	TNMM 333-BR	.650	3/8	3/16	.150	1/32	●	●	●											
	TNMM 432-BR	.650	3/8	3/16	.150	3/64	●	●	●											
	TNMM 433-BR	.866	1/2	3/16	.203	1/32	●	●	●											
TPMR-FM 	TPMR (1.8) (0.5) 1-FM	.375	7/32	3/32	-	1/64	●	●	●											
	TPMR 221-FM	.433	1/4	1/8	-	1/64	●	●	●											
	TPMR 222-FM	.433	1/4	1/8	-	1/32	●	●	●											
	TPMR 321-FM	.650	3/8	1/8	-	1/64	●	●	●											
	TPMR 322-FM	.650	3/8	1/8	-	1/32	●	●	●											
	TPMR 323-FM	.650	3/8	1/8	-	3/64	●	●	●											

Order example: Pkg. Qty. 10 CCMT 2 (1.5) 1-BSM LC610M

Toolholders: pages 50–61

Cutting data recommendations: pages 64–69

*) Insert Identification System: pages 16–17

● : Available from stock

Indexable Inserts

Ordering Code ANSI	Ordering numbers															
	HC	HC	HC				HC			HC	HW	HC				
	LC215B	LC225C	LC235C				LC435D			LC610M	LW610	LC610A				
TNMG 331-BFMS							74448									
TNMG 332-BFMS							74452									
TNMG 332-BM	74453	74454	74455													
TNMG 333-BM	74463	74464	74465													
TNMG 432-BM	74470	74471	74472													
TNMG 433-BM	74474	74475	74476													
TNMG 332-BMR	74456	74457	74458													
TNMG 333-BMR	74466	74467	74468													
TNMG 433-BMR	74477	74478	74479													
TNMG 434-BMR	74481	74482	74483													
TNMG 332-BMS							74459									
TNMG 333-BMS							74469									
TNMG 432-BMS							74473									
TNMG 433-BMS							74480									
TNMM 332-BR	74484	74485	74486													
TNMM 333-BR	74487	74488	74489													
TNMM 432-BR	74490	74491	74492													
TNMM 433-BR	74493	74494	74495													
TPMR (1.8) (1.5) 1-FM	59969	59970	59971													
TPMR 221-FM	59972	59973	59974													
TPMR 222-FM	59975	59976	59977													
TPMR 321-FM	59978	59979	59980													
TPMR 322-FM	59981	59982	59983													
TPMR 323-FM	59984	59985	59986													

Order example: Pkg. Qty. 10 EDP 12345

Indexable Inserts

V.... 	Ordering Code ANSI *)	Sizes in inch					Grade																			
		l <i>edge length</i>	d <i>IC</i>	s <i>thick-ness</i>	d ₁ <i>hole size</i>	r <i>radius</i>	HC	HC	HC			HC														
							LC215B	LC225C	LC235C			LC435D					LC610M	LW610	LC610A							
VBMT 	VBMT 331	.654	3/8	3/16	.173	1/64	●	●																		
	VBMT 332	.654	3/8	3/16	.173	1/32	●	●																		
	VBMT 333	.654	3/8	3/16	.173	3/64	●	●																		
VCGT-BAL 	VCGT 220 (0.5)-BAL	.437	1/4	1/8	.110	1/128														●	●					
	VCGT 221-BAL	.437	1/4	1/8	.110	1/64															●	●	●			
	VCGT 330 (0.5)-BAL	.654	3/8	3/16	.173	1/128															●	●				
	VCGT 331-BAL	.654	3/8	3/16	.173	1/64															●	●	●			
	VCGT 332-BAL	.654	3/8	3/16	.173	1/32															●	●	●			
	VCGT 333-BAL	.654	3/8	3/16	.173	3/64															●	●	●			
	VCGT 4 (3.5) (8)-BAL	.870	1/2	7/32	.217	.118															●	●	●			
VCMT-BSF 	VCMT 220 (0.5)-BSF	.437	1/4	1/8	.110	1/128	●	●																		
	VCMT 221-BSF	.437	1/4	1/8	.110	1/64	●	●																		
	VCMT 331-BSF	.654	3/8	3/16	.173	1/64	●	●																		
	VCMT 332-BSF	.654	3/8	3/16	.173	1/32	●	●																		
VCMT-BSM 	VCMT 331-BSM	.654	3/8	3/16	.173	1/64	●	●	●																	
	VCMT 332-BSM	.654	3/8	3/16	.173	1/32	●	●	●																	
VNMG-BF 	VNMG 331-BF	.654	3/8	3/16	.150	1/64	●																			
VNMG-BM 	VNMG 332-BM	.654	3/8	3/16	.150	1/32	●	●	●																	
	VNMG 333-BM	.654	3/8	3/16	.150	3/64	●	●	●																	
VPGT-BAL 	VPGT 221-BAL	.437	1/4	1/8	.110	1/64														●	●					
	VPGT 333-BAL	.654	3/8	3/16	.173	3/64														●	●					
	VPGT 4 (3.5) 4-BAL	.870	1/2	7/32	.217	1/16														●	●					

Order example: Pkg. Qty. 10 CCMT 2 (1.5) 1-BSM LC610M

Toolholders: pages 50–61

Cutting data recommendations: pages 64–69

*) Insert Identification System: pages 16–17







● : Available from stock

Indexable Inserts

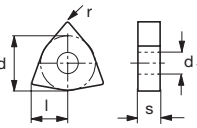
Ordering Code ANSI	Ordering numbers														
	HC	HC	HC				HC			HC	HW	HC			
	LC215B	LC225C	LC235C				LC435D			LC610M	LW610	LC610A			
VBMT 331	74496	74497													
VBMT 332	74498	74499													
VBMT 333	74500	74501													
VCGT 220 (0.5)-BAL										89262	74502				
VCGT 221-BAL										89338	74503	74504			
VCGT 330 (0.5)-BAL										89316	74505				
VCGT 331-BAL										89339	74507	74508			
VCGT 332-BAL										89234	74509	74510			
VCGT 333-BAL										89340	74511	74512			
VCGT 4 (3.5) (8)-BAL										59987	59988	59989			
VCMT 220 (0.5)-BSF	74516	74517													
VCMT 221-BSF	74518	74519													
VCMT 331-BSF	74520	74521													
VCMT 332-BSF	74525	74526													
VCMT 331-BSM	74522	74523	74524												
VCMT 332-BSM	74527	74528	74529												
VNMG 331-BF	74530														
VNMG 332-BM	74531	74532	74533												
VNMG 333-BM	59992	59993	59994												
VPGT 221-BAL										59783	59782				
VPGT 333-BAL										59781	59780				
VPGT 4 (3.5) 4-BAL										74535	74534				

Order example: Pkg. Qty. 10 EDP 12345

Indexable Inserts

W.... 	Ordering Code ANSI *)	Sizes in inch					Grade																	
		l <i>edge length</i>	d <i>IC</i>	s <i>thick-ness</i>	d ₁ <i>hole size</i>	r <i>radius</i>	HC	HC	HC			HC												
							LC215B	LC225C	LC235C			LC435D					LC610M	LW610	LC610A					
WCGT-BAL 	WCGT 3 (2.5) (0.5)-BAL	.256	3/8	5/32	.173	1/128																		● ●
	WCGT 3 (2.5) 1-BAL	.256	3/8	5/32	.173	1/64																		● ●
	WCGT 3 (2.5) 2-BAL	.256	3/8	5/32	.173	1/32																		● ●
	WCGT 431-BAL	.339	1/2	3/16	.217	1/64																		● ●
	WCGT 432-BAL	.339	1/2	3/16	.217	1/32																		● ●
WCMT-BSF 	WCMT 3 (2.5) (0.5)-BSF	.256	3/8	5/32	.173	1/128	● ●																	
	WCMT 3 (2.5) 1-BSF	.256	3/8	5/32	.173	1/64	● ●																	
	WCMT 3 (2.5) 2-BSF	.256	3/8	5/32	.173	1/32	● ●																	
	WCMT 431-BSF	.339	1/2	3/16	.217	1/64	● ●																	
	WCMT 432-BSF	.339	1/2	3/16	.217	1/32	● ●																	
WCMT-BSM 	WCMT 3 (2.5) (0.5)-BSM	.256	3/8	3/16	.173	1/128	● ●																	
	WCMT 3 (2.5) 1-BSM	.256	3/8	5/32	.173	1/64	● ●																	
	WCMT 3 (2.5) 2-BSM	.256	3/8	5/32	.173	1/32	● ●																	
	WCMT 431-BSM	.339	1/2	3/16	.217	1/64	● ● ●																	
	WCMT 432-BSM	.339	1/2	3/16	.217	1/32	● ● ●																	
WNMG-BF 	WNMG 331-BF	.256	3/8	3/16	.150	1/64	●																	
	WNMG 332-BF	.256	3/8	3/16	.150	1/32	●																	
	WNMG 333-BF	.256	3/8	3/16	.150	3/64	●																	
	WNMG 431-BF	.339	1/2	3/16	.203	1/64	●																	
	WNMG 432-BF	.339	1/2	3/16	.203	1/32	●																	
	WNMG 433-BF	.339	1/2	3/16	.203	3/64	●																	
WNMG-BFM 	WNMG 331-BFM	.256	3/8	3/16	.150	1/64	● ● ●																	
	WNMG 332-BFM	.256	3/8	3/16	.150	1/32	● ● ●																	
	WNMG 333-BFM	.256	3/8	3/16	.150	3/64	● ● ●																	
	WNMG 431-BFM	.339	1/2	3/16	.203	1/64	● ● ●																	
	WNMG 432-BFM	.339	1/2	3/16	.203	1/32	● ● ●																	
	WNMG 433-BFM	.339	1/2	3/16	.203	3/64	● ● ●																	
WNMG-BFMS 	WNMG 331-BFMS	.256	3/8	3/16	.150	1/64																		●
	WNMG 431-BFMS	.339	1/2	3/16	.203	1/64																		●
	WNMG 432-BFMS	.339	1/2	3/16	.203	1/32																		●

Order example: Pkg. Qty. 10 CCMT 2 (1.5) 1-BSM LC610M

Toolholders: pages 50–61

Cutting data recommendations: pages 64–69

*) Insert Identification System: pages 16–17





● : Available from stock

Indexable Inserts

Ordering Code ANSI	Ordering numbers														
	HC	HC	HC				HC			HC	HW	HC			
	LC215B	LC225C	LC235C				LC435D			LC610M	LW610	LC610A			
WCGT 3 (2.5) (0.5)-BAL										89342	74536				
WCGT 3 (2.5) 1-BAL										89343	74537				
WCGT 3 (2.5) 2-BAL										89344	74538				
WCGT 431-BAL										89345	74539				
WCGT 432-BAL										89346	74540				
WCMT 3 (2.5) (0.5)-BSF	74541	74542													
WCMT 3 (2.5) 1-BSF	74545	74546													
WCMT 3 (2.5) 2-BSF	74549	74550													
WCMT 431-BSF	74553	74554													
WCMT 432-BSF	74558	74559													
WCMT 3 (2.5) (0.5)-BSM	74543	74544													
WCMT 3 (2.5) 1-BSM	74547	74548													
WCMT 3 (2.5) 2-BSM	74551	74552													
WCMT 431-BSM	74555	74556	74557												
WCMT 432-BSM	74560	74561	74562												
WNMG 331-BF	74571														
WNMG 332-BF	74576														
WNMG 333-BF	74584														
WNMG 431-BF	74591														
WNMG 432-BF	74595														
WNMG 433-BF	74606														
WNMG 331-BFM	74572	74573	74574												
WNMG 332-BFM	74577	74578	74579												
WNMG 333-BFM	74585	74586	74587												
WNMG 431-BFM	74592	74593	74594												
WNMG 432-BFM	74596	74597	74598												
WNMG 433-BFM	59995	59996	59997												
WNMG 331-BFMS							74575								
WNMG 431-BFMS							50733								
WNMG 432-BFMS							74599								

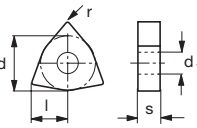
Order example: Pkg. Qty. 10 EDP 12345

Indexable Inserts

W.... 	Ordering Code ANSI *)	Sizes in inch					Grade																			
		l <i>edge length</i>	d <i>IC</i>	s <i>thick-ness</i>	d ₁ <i>hole size</i>	r <i>radius</i>	HC	HC	HC			HC														
							LC215B	LC225C	LC235C			LC435D					LC610M	LW610	LC610A							
	W.NMG 332-BM	.256	3/8	3/16	.150	1/32	●	●	●																	
	W.NMG 333-BM	.256	3/8	3/16	.150	3/64	●	●	●																	
	W.NMG 432-BM	.339	1/2	3/16	.203	1/32	●	●	●																	
	W.NMG 433-BM	.339	1/2	3/16	.203	3/64	●	●	●																	
	W.NMG 434-BM	.339	1/2	3/16	.203	1/16	●	●	●																	
	W.NMG 432-BMR	.339	1/2	3/16	.203	1/32	●	●	●																	
	W.NMG 433-BMR	.339	1/2	3/16	.203	3/64	●	●	●																	
	W.NMG 434-BMR	.339	1/2	3/16	.203	1/16	●	●	●																	
	W.NMG 432-BMRS	.339	1/2	3/16	.203	1/32																				
	W.NMG 433-BMRS	.339	1/2	3/16	.203	3/64																				
	W.NMG 434-BMRS	.339	1/2	3/16	.203	1/16																				
	W.NMG 332-BMS	.256	3/8	3/16	.150	1/32																				
	W.NMG 432-BMS	.339	1/2	3/16	.203	1/32																				
	W.NMG 433-BMS	.339	1/2	3/16	.203	3/64																				
	W.NMG 434-BMS	.339	1/2	3/16	.203	1/16																				

Order example: Pkg. Qty. 10 CCMT 2 (1.5) 1-BSM LC610M

● : Available from stock

Toolholders: pages 50–61
 Cutting data recommendations: pages 64–69
 *) Insert Identification System: pages 16–17

Indexable Inserts

Ordering Code ANSI	Ordering numbers														
	HC	HC	HC				HC			HC	HW	HC			
	LC215B	LC225C	LC235C				LC435D			LC610M	LW610	LC610A			
WNMG 332-BM	74580	74581	74582												
WNMG 333-BM	74588	74589	74590												
WNMG 432-BM	89227	74600	74601												
WNMG 433-BM	74607	74608	74609												
WNMG 434-BM	74615	74616	74617												
WNMG 432-BMR	74602	74603	74604												
WNMG 433-BMR	74610	74611	74612												
WNMG 434-BMR	74618	74619	74620												
WNMG 432-BMRS							74605								
WNMG 433-BMRS							74613								
WNMG 434-BMRS							74621								
WNMG 332-BMS							74583								
WNMG 432-BMS							50734								
WNMG 433-BMS							74614								
WNMG 434-BMS							74622								

Order example: Pkg. Qty. 10 EDP 12345

Tool Holder Identification System

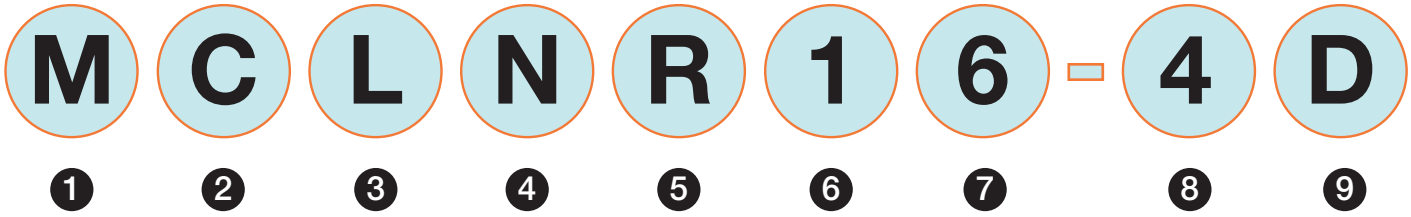

1 Holding Method

M - Multiple Lock

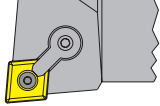

S - Screw Lock

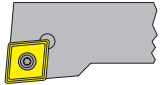

2 Insert Shape

C - 80° Diamond



D - 55° Diamond

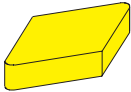

R - Round

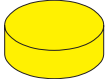

S - Square



T - Triangle

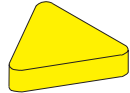

W - 80° Trigon



V - 35° Diamond

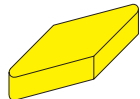

3 Tool Style

A - Straight Shank
0° Side Cutting Edge Angle

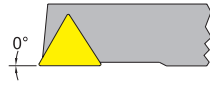

B - Straight Shank
15° Side Cutting Edge Angle

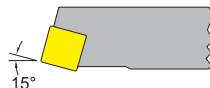

C - Straight Shank
0° End Cutting Edge Angle

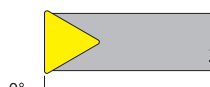

D - Straight Shank
45° Side Cutting Edge Angle

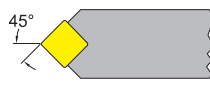

E - Straight Shank
30° Side Cutting Edge Angle

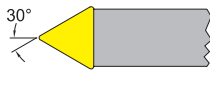

F - Offset Shank
0° End Cutting Edge Angle

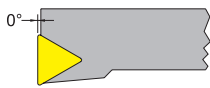

G - Offset Shank
0° Side Cutting Edge Angle

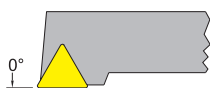

J - Offset Shank
3° Side Cutting Edge Angle

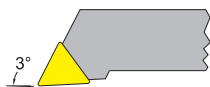

K - Offset Shank
15° End Cutting Edge Angle

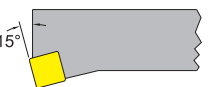

L - Offset Shank
5° End or Side Cut Edge Angle

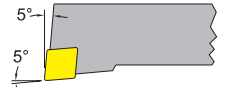

M - Straight Shank
40° Side Cutting Edge Angle

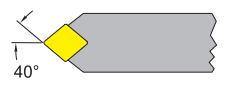

N - Straight Shank
3° Side Cutting Edge Angle

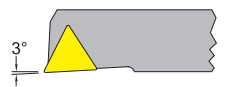

P - Straight Shank
27.5° Side Cutting Edge Angle

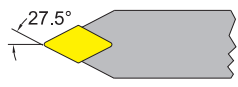

Q - Offset Shank
Convex Radius Cutting Edge



R - Offset Shank
15° Side Cutting Edge Angle



S - Offset Shank
45° Side Cutting Edge Angle



V - Straight Shank
17.5° Side Cutting Edge Angle

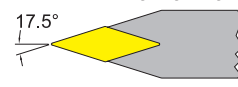

X - Offset Shank
10° Side Cutting Edge Angle



Y - Straight Shank
50° Side Cutting Edge Angle

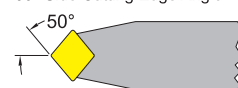

4 Insert Clearance Angle

B - 5° Positive



E - 20° Positive



C - 7° Positive



N - 0° Negative



D - 15° Positive



P - 11° Positive



5 Hand of Tool

R - Right Hand

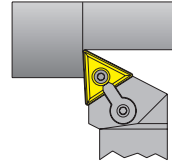

L - Left Hand

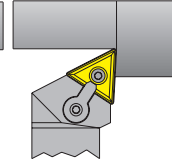

N - Neutral

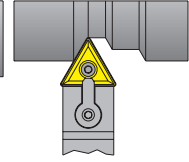

6 7 Shank Size

Square Shanks:

(A) & (B) shown in 1/16 inch increments

Rectangle Shanks:

Position six (6): (A) shown in 1/8 inch increments



8 Insert Size I.C.

Insert I.C.:
(I.C.) shown in 1/8 inch increments

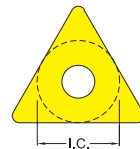

9 Tool Length

- J - 3-1/2"
- A - 4.0"
- B - 4-1/2"
- C - 5.0"
- D - 6.0
- E - 7.0
- F - 8.0

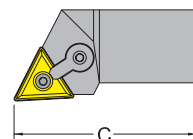



Boring Bar Identification System

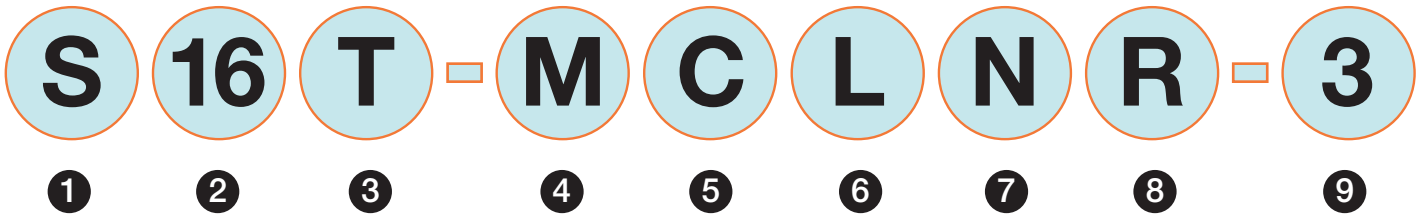

1 Bar type

C - Carbide
S - Steel

2 Bar Diameter

Round Shanks:
(D) shown in 1/16 inch

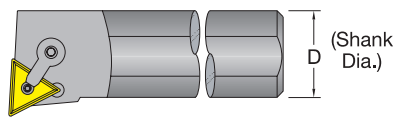

3 Bar Length

- H - 4.0
- J - 4-1/2
- K - 5.0
- M - 6.0
- R - 8.0
- S - 10.0
- T - 12.0
- U - 14.0
- V - 16.0
- Y - 18.0

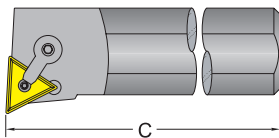

4 Holding Method

M - Multiple Lock

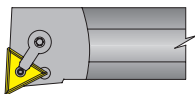

S - Screw Lock

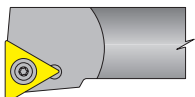

5 Insert Shape

C - 80° Diamond

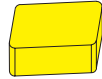

T - Triangle



D - 55° Diamond

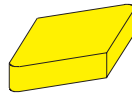

W - 80° Trigon



R - Round



V - 35° Diamond

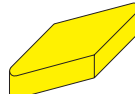

S - Square

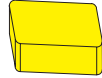

7 Insert Clearance Angle

B - 5° Positive



C - 7° Positive



E - 20° Positive



N - 0° Negative



P - 11° Positive



6 Bar Type

F - Offset Shank
0° End Cutting Edge Angle

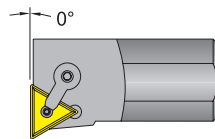

L - Offset Shank
5° End or Side Cut Edge Angle

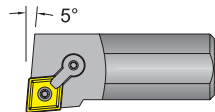

U - Offset Shank
3° End Cutting Edge Angle

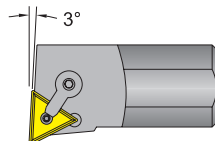

X - Offset Shank
5° Back Cutting Edge Angle

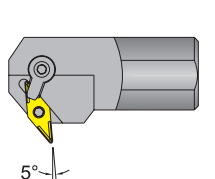

8 Hand of Tool

R - Right Hand

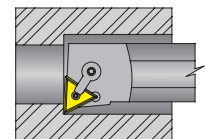

L - Left Hand

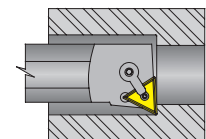

9 Insert Size I.C.

Insert I.C.:
(I.C.) shown in 1/8
inch increments

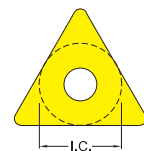

MCLN R/L Toolholder

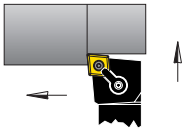

Style L - Negative 5° End or Side Cutting Edge Angle for negative 80° diamond CNMG inserts

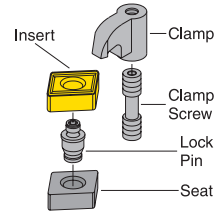
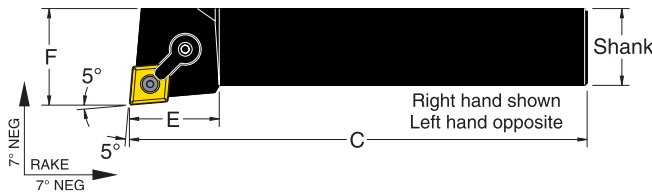

Multiple Lock Negative 80° Diamond Toolholders

Description	EDP No.		Shank Width	Shank Height	C	E	F	CNMG Insert	Seat	Lock Pin	Clamp	Clamp Screw	Seat Screw
	Right Hand	Left Hand											
MCLNR/L10-4B	30579	30581	.625	.625	4.5	1.250	1.00						
MCLNR/L12-4B	30582	30583	.750	.750	4.5	1.250	1.00						
MCLNR/L16-4C	30584	30585	1.00	1.00	5.0	1.250	1.25	43	ICSN-433	NL-46	CL-20	XNS-48	S-46
MCLNR/L16-4D	30586	30587	1.00	1.00	6.0	1.250	1.25						
MCLNR/L20-4D	30588	30589	1.25	1.25	6.0	1.250	1.50						
MCLNR/L16-5D	30590	30591	1.00	1.00	6.0	1.375	1.25	54	ICSN-533	NL-58	CL-12	XNS-510	S-58
MCLNR/L20-5D	30592	30593	1.25	1.25	6.0	1.375	1.50						
MCLNR/L24-6E	30594	30595	1.50	1.50	7.0	1.500	2.0	64	ICSN-633	NL-68	CL-12	XNS-510	S-68

MCRN R/L Toolholder

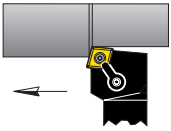

Style R - 15° Side Cutting Edge Angle for negative 80° diamond CNMG inserts

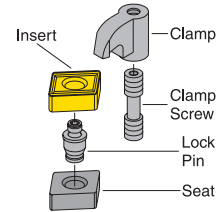
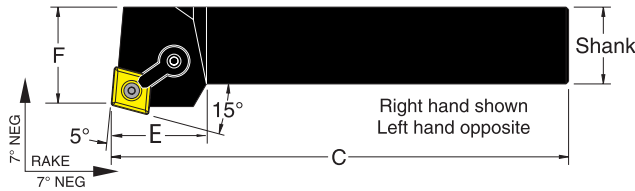

Multiple Lock Negative 80° Diamond Toolholders

Description	EDP No.		Shank Width	Shank Height	C	E	F	CNMG Insert	Seat	Lock Pin	Clamp	Clamp Screw	Seat Screw
	Right Hand	Left Hand											
MCRNR/L12-4B	30596	30597	.750	.750	4.5	1.25	0.75						
MCRNR/L16-4C	30598	30599	1.00	1.00	5.0	1.25	1.25	43	ICSN-433	NL-46	CL-9	XNS-58	S-46
MCRNR/L16-4D	30600	30601	1.00	1.00	6.0	1.25	1.25						
MCRNR/L16-5D	30602	30603	1.00	1.00	6.0	1.25	1.25	54	ICSN-533	NL-58	CL-9	XNS-510	S-58
MCRNR/L20-5D	30604	30605	1.25	1.25	6.0	1.25	1.50						

MDJN R/L Toolholder

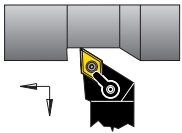

Style J - 3° Side Cutting Edge Angle for negative 55° diamond DNMG inserts

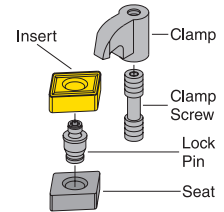
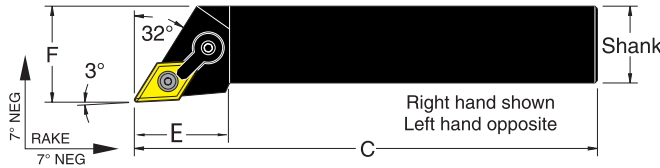

Multiple Lock Negative 55° Diamond Toolholders

Description	EDP No.		Shank Width	Shank Height	C	E	F	DNMG Insert	Seat	Lock Pin	Clamp	Clamp Screw	Seat Screw
	Right Hand	Left Hand											
MDJNR/L12-4B	30606	30607	.750	.750	4.5	1.25	1.00	43	IDSN-433	NL-46	CL-6	XNS-36	S-46
MDJNR/L16-4C	30608	30609	1.00	1.00	5.0	1.25	1.25						
MDJNR/L16-4D	30610	30611	1.00	1.00	6.0	1.25	1.25	43	IDSN-433	NL-46	CL-20	XNS-48	S-46
MDJNR/L20-4D	30612	30613	1.25	1.25	6.0	1.25	1.50						
MDJNR/L24-4E	30614	30615	1.50	1.50	7.0	1.25	2.00						

MDPNN Neutral Toolholder

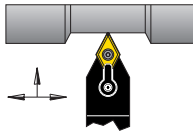

Style P - 27.5° Side Cutting Edge Angle for negative 55° diamond DNMG inserts

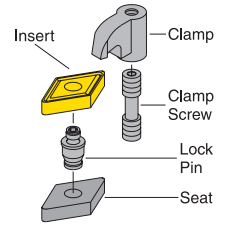
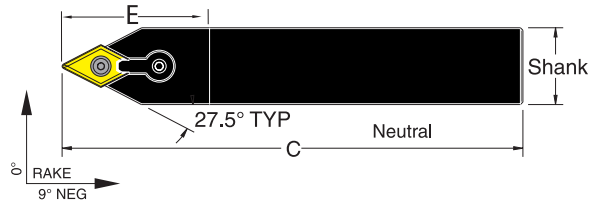

Multiple Lock Negative 55° Diamond Toolholders

Description	EDP No.		Shank Width	Shank Height	C		DNMG Insert	Seat	Lock Pin	Clamp	Clamp Screw	Seat Screw
	Neutral					E						
MDPNN12-4B	30616		.750	.750	4.5	1.75						
MDPNN16-4D	30617		1.00	1.00	6.0	1.75	43	IDSN-433	NL-46	CL-12	XNS-510	S-46
MDPNN20-4D	30618		1.25	1.25	6.0	1.75						

MSDNN Neutral Toolholder

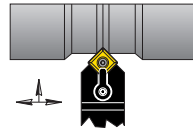

Style D - 45° Side Cutting Edge Angle for negative square SNMG inserts

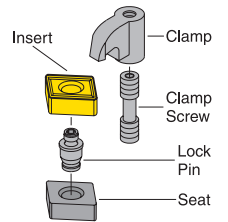

Multiple Lock Negative 45° Square Toolholders

Description	EDP No.		Shank Width	Shank Height	C		SNMG Insert	Seat	Lock Pin	Clamp	Clamp Screw	Seat Screw
	Neutral					E						
MSDNN08-3A	30619		.500	.500	4.0	1.000	32	ISSN-322	NL-34	CL-6	XNS-36	S-34
MSDNN10-3B	30620		.625	.625	4.5	1.000						
MSDNN12-4B	30621		.750	.750	4.5	1.375	43	ISSN-433	NL-46	CL-9	XNS-59	S-46
MSDNN16-4D	30622		1.00	1.00	6.0	1.375						

MSKN R/L Toolholder



Style K - 15° End Cutting Edge angle for negative square SNMG inserts

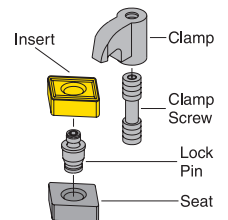
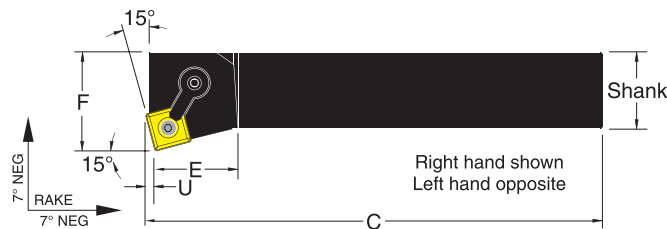

Multiple Lock Negative 15° Square Toolholders

Description	EDP No.		Shank Width	Shank Height	C			SNMG Insert	Seat	Lock Pin	Clamp	Clamp Screw	Seat Screw
	Right Hand	Left Hand				E	F						
MSKNR20-6D	30623	30624	1.25	1.25	6.0	1.50	1.500	64	ISSN-633	NL-68	CL-12	XNS-510	S-68

MTAN R/L Toolholder

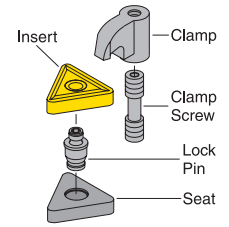
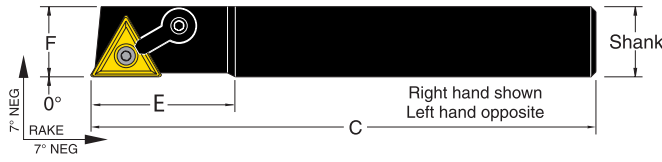
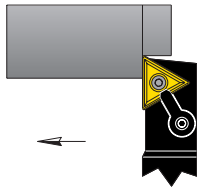

Style A - 0° Side Cutting Edge Angle for negative triangle TNMG inserts

Multiple Lock Negative Triangle Toolholders

Description	EDP No.		Width	Shank Height	Shank			TNMG Insert	Seat	Lock Pin	Clamp	Clamp Screw	Seat Screw
	Right Hand	Left Hand			C	E	F						
MTANR/L10-3B	30625	30626	.625	.625	4.5	1.000	.625	32	ITSN-333	NL-34L	CL-6	XNS-36	S-34
MTANR/L12-3B	30627	30628	.750	.750	4.5	1.000	.750						
MTANR/L16-4D	30629	30630	1.00	1.00	6.0	1.375	1.00	43	ITSN-432	NL-46	CL-9	XNS-59	S-46

MTEN Toolholder

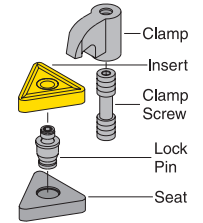
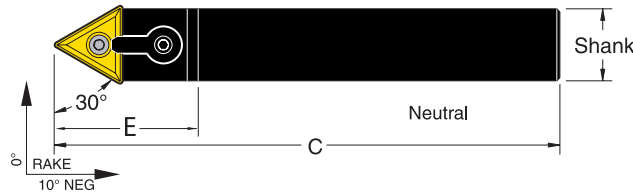
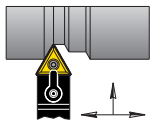

Style E - 30° Side Cutting Edge Angle for negative triangle TNMG inserts

Multiple Lock Negative Triangle Toolholders

Description	EDP No. Neutral	Shank Width	Shank Height	Shank		TNMG Insert	Seat	Lock Pin	Clamp	Clamp Screw
				C	E					
MTENN10-3B	30631	.625	.625	4.5	1.125	32	ITSN-333	NL-34L	CL-6	XNS-36
MTENN12-3B	30632	.750	.750	4.5	1.125					
MTENN12-4B	30633	.750	.750	4.5	1.500	43	ITSN-432	NL-46	CL-9	XNS-59
MTENN16-4D	30634	1.00	1.00	6.0	1.500					

MTFN R/L Toolholder

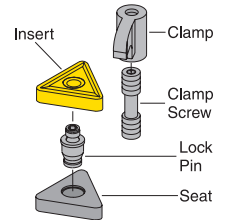
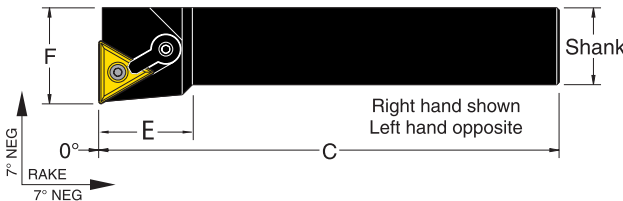
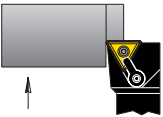

Style F - 0° End Cutting Edge Angle for negative triangle TNMG inserts

Multiple Lock Negative Triangle Toolholders

Description	EDP No.		Width	Shank Height	Shank			TNMG Insert	Seat	Lock Pin	Clamp	Clamp Screw	Seat Screw
	Right Hand	Left Hand			C	E	F						
MTFNR/L10-3B	30635	30636	.625	.625	4.5	0.875	.875						
MTFNR/L12-3B	30637	30638	.750	.750	4.5	0.875	1.00	32	ITSN-333	NL-34L	CL-6	XNS-36	S-34
MTFNR/L16-3C	30639	30640	1.00	1.00	5.0	0.875	1.25						
MTFNR/L16-3D	30641	30642	1.00	1.00	6.0	0.875	1.25						
MTFNR/L16-4C	30643	30644	1.00	1.00	5.0	1.250	1.25	43	ITSN-432	NL-46	CL-9	XNS-510	S-46
MTFNR/L16-4D	30645	30646	1.00	1.00	6.0	1.250	1.25						

MTGN Toolholder

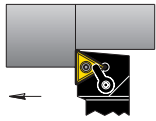

Style G - 0° Side Cutting Edge Angle for negative triangle TNMG insert

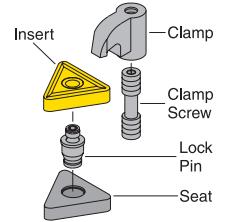
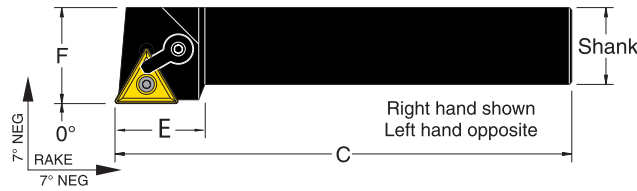

Multiple Lock Negative Triangle Toolholders

Description	EDP No.		Shank Width	Shank Height	C	E	F	TNMG Insert	Seat	Lock Pin	Clamp	Clamp Screw	
	Right Hand	Left Hand											
MTGNR/L10-3B	30647	30648	.625	.625	4.5	1.000	.875	32	ITSN-333	NL-34L	CL-6	XNS-36	S-34
MTGNR/L12-3B	30649	30650	.750	.750	4.5	1.000	1.00						
MTGNR/L16-3C	30651	30652	1.00	1.00	5.0	1.000	1.25						
MTGNR/L16-3D	30653	30654	1.00	1.00	6.0	1.000	1.25	43	ITSN-432	NL-46	CL-9	XNS-510	S-46
MTGNR/L16-4C	30655	30656	1.00	1.00	5.0	1.375	1.25						
MTGNR/L16-4D	30657	30658	1.00	1.00	6.0	1.375	1.25						

MTJN R/L Toolholder

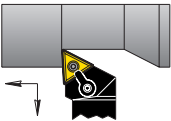

Style J - 3° Side Cutting Edge Angle for negative triangle TNMG inserts

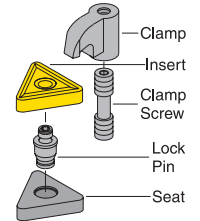
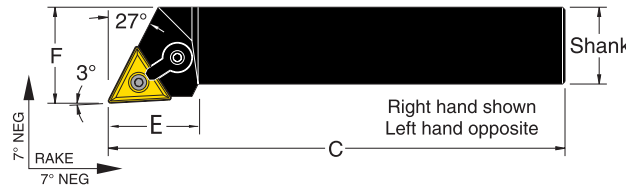

Multiple Lock Negative Triangle Toolholders

Description	EDP No.		Shank Width	Shank Height	C	E	F	TNMG Insert	Seat	Lock Pin	Clamp	Clamp Screw
	Right Hand	Left Hand										
MTJNR/L10-3B	30659	30660	.625	.625	4.5	1.000	.875	32	ITSN-333	NL-34L	CL-6	XNS-36
MTJNR/L12-3B	30661	30662	.750	.750	4.5	1.000	1.00					
MTJNR/L16-3D	30663	30664	1.00	1.00	6.0	1.000	1.25					
MTJNR/L16-4D	30665	30666	1.00	1.00	6.0	1.250	1.25	43	ITSN-432	NL-46	CL-9	XNS-510
MTJNR/L20-4D	30667	30668	1.25	1.25	6.0	1.250	1.50					

MVJN R/L Toolholder

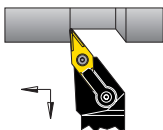

Style J - Neg 3° Side Cutting Edge Angle for negative 35° diamond VNMG inserts

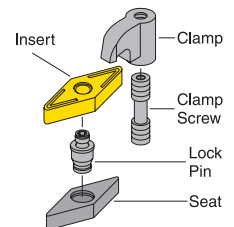
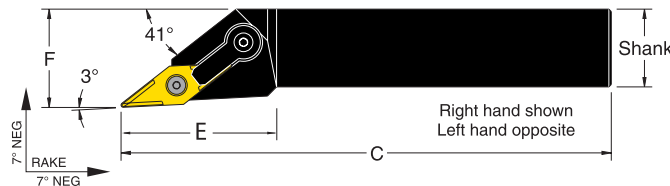

Multiple Lock Negative 35° Diamond Toolholders

Description	EDP No.		Shank Width	Shank Height	C	E	F	VNMG Insert	Seat	Lock Pin	Clamp	Clamp Screw	Seat Screw
	Right Hand	Left Hand											
MVJNR/L12-3B	30669	30670	.750	.750	4.5	1.687	1.00	33	IVSN-322	NL-34L	CL-30	XNS-510	S-34
MVJNR/L16-3C	30671	30672	1.00	1.00	5.0	1.687	1.25						
MVJNR/L16-3D	30673	30674	1.00	1.00	6.0	1.687	1.25						
MVJNR/L16-4D	59787	59786	1.00	1.00	5.0	2.000	1.25	43	IVSN-432	NL-46	CL-30	XNS-510	S-46

MWLN R/L Toolholder

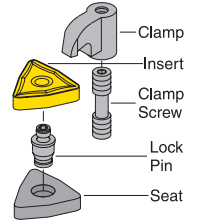
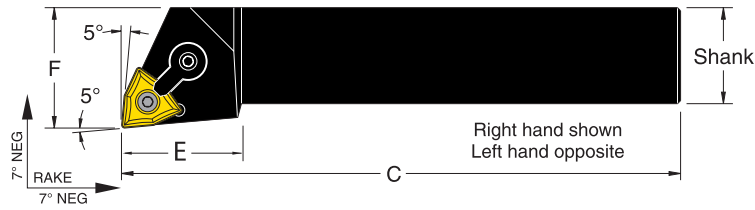
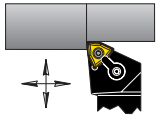

Style L - Neg. 5° End or Side Cutting Edge Angle for negative 80° trigon WNMG inserts

Multiple Lock 80° Triagon Toolholders

Description	EDP No.		Shank Width	Shank Height	C	E	F	WNMG Insert	Seat	Lock Pin	Clamp	Clamp Screw
	Right Hand	Left Hand										
MWLN/L12-3B	30675	30676	.750	.750	4.5	1.00	1.00	33	IWSN-322	NL-34L	CL-6	XNS-36
MWLN/L12-4B	30677	30678	.750	.750	4.5	1.25	1.00	43	IWSN-432	NL-46	CL-9	XNS-59
MWLN/L16-4D	30679	30680	1.00	1.00	6.0	1.25	1.25					
MWLN/L20-4D	30681	30682	1.25	1.25	6.0	1.25	1.50					

SCLC R/L Toolholder

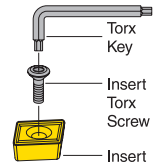
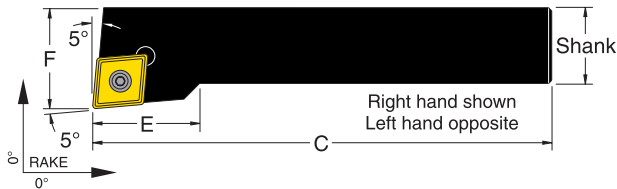
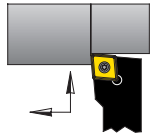

Style L - Neg. 5° End or Side Cutting Edge Angle for 7° positive 80° diamond CCMT inserts

Screw Lock Positive Diamond 80° Toolholders

Description	EDP No.		Shank Width	Shank Height	C	E	F	CCMT Insert	Insert Torx Screw	Torx Key
	Right Hand	Left Hand								
SCLCR/L06-2J	30683	30684	.375	.375	3.5	.49	.500	21.5	TS-25.45-6M1	T-7
SCLCR/L08-3A	30685	30686	.500	.500	4.0	.69	.625	32.5	TS-4.7-10M1	T-15
SCLCR/L10-3B	30687	30688	.625	.625	4.5	.69	.750			
SCLCR/L12-3B	30689	30690	.750	.750	4.5	.69	1.000			
SCLCR/L16-3D	30691	30692	1.00	1.00	6.0	.69	1.250	43	TS-103-4MI	T-20
SCLCR/L16-4D	18376	18377	1.00	1.00	6.0	.83	1.000			

SDJC R/L Toolholder

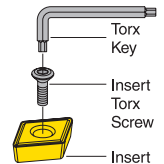
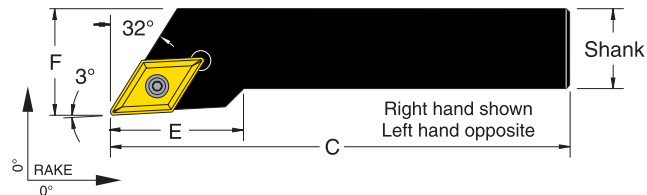
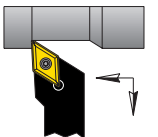

Style J - Neg. 3° Side Cutting Edge Angle for 7° positive 55° diamond DCMT inserts

Screw Lock Positive Diamond 55° Toolholders

Description	EDP No.		Shank Width	Shank Height	C	E	F	DCMT Insert	Insert Torx Screw	Torx Key
	Right Hand	Left Hand								
SDJCR/L06-2J	30693	30694	.375	.375	3.5	0.68	.500	21.5	TS-25.45-6M1	T-7
SDJCR/L08-2A	30695	30696	.500	.500	4.0	0.68	.625	32.5	TS-4.7-10M1	T-15
SDJCR/L08-3A	30697	30698	.500	.500	4.0	1.00	.625			
SDJCR/L10-3B	30699	30700	.625	.625	4.5	1.00	.750			
SDJCR/L12-3B	30701	30702	.750	.750	4.5	1.00	1.00	43	TS-103-4MI	T-20
SDJCR/L16-3D	30703	30704	1.00	1.00	6.0	1.00	1.25			

SRCC R/L Toolholder

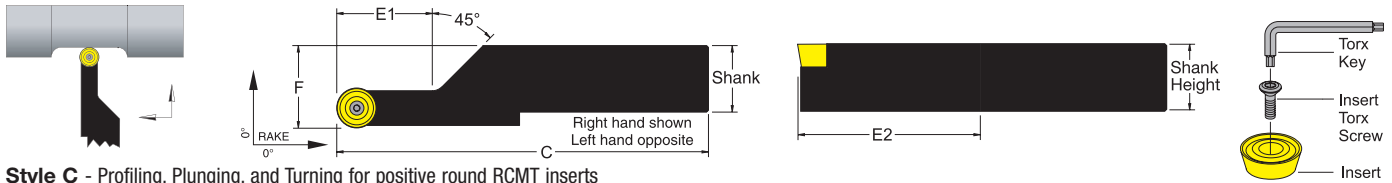

Style C - Profiling, Plunging, and Turning for positive round RCMT inserts

Screw Lock Positive RCMT Toolholders

Description	EDP No.		Shank Width	Shank Height	C	E1	E2	F	RCMT Insert	Insert Torx Screw	Torx Key
	Right Hand	Left Hand									
SRCCR/L10-06-A	59807	59827	.625	.625	4.000	.810	1.435	.743	0602		
SRCCR/L12-06-B	59808	59828	.750	.750	4.500	.810	1.560	.868	0602		
SRCCR/L16-06-D	59809	29829	1.00	1.00	6.000	.810	1.810	1.118	0602	TS-25.456M1	T-7
SRCCR/L20-06-D	59810	59830	1.25	1.25	6.000	.810	2.060	1.368	0602		
SRCCR/L12-08-B	59811	59831	.750	.750	4.500	1.020	1.770	.908	0803		
SRCCR/L16-08-D	59812	59832	1.00	1.00	6.000	1.020	2.020	1.158	0803	TS-3.5-7M1	T-8
SRCCR/L20-08-D	59813	59833	1.25	1.25	6.000	1.020	2.270	1.408	0803		
SRCCR/L12-10-B	59814	59834	.750	.750	4.500	1.230	1.980	.947	1003		
SRCCR/L16-10-D	59815	59835	1.00	1.00	6.000	1.230	2.230	1.197	1003	TS-35.6-9M1	T-15
SRCCR/L20-10-D	59816	59836	1.25	1.25	6.000	1.230	2.480	1.447	1003		

SRGC R/L Toolholder

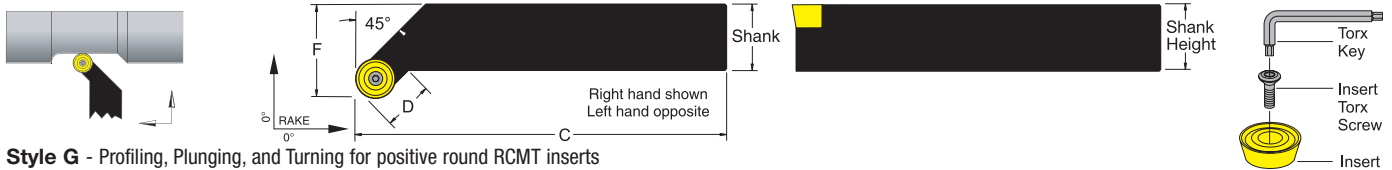

Style G - Profiling, Plunging, and Turning for positive round RCMT inserts

Screw Lock Positive RCMT Toolholders

Description	EDP No.		Shank Width	Shank Height	C	D	F	RCMT Insert	Insert Torx Screw	Torx Key
	Right Hand	Left Hand								
SRGCR/L10-06-A	59797	59817	.625	.625	4.000	.250	.750	0602		
SRGCR/L12-06-B	59798	59818	.750	.750	4.500	.420	1.000	0602		
SRGCR/L16-06-D	59799	59819	1.00	1.00	6.000	.420	1.250	0602	TS-25.456M1	T-7
SRGCR/L20-06-D	59800	59820	1.25	1.25	6.000	.420	1.500	0602		
SRGCR/L12-08-B	59801	59821	.750	.750	4.500	.450	1.000	0803		
SRGCR/L16-08-D	59802	59822	1.00	1.00	6.000	.450	1.250	0803	TS-3.5-7M1	T-8
SRGCR/L20-08-D	59803	59823	1.25	1.25	6.000	.450	1.500	0803		
SRGCR/L12-10-B	59804	59824	.750	.750	4.500	.470	1.000	1003		
SRGCR/L16-10-D	59805	59825	1.00	1.00	6.000	.470	1.250	1003	TS-35.6-9M1	T-15
SRGCR/L20-10-D	59806	59826	1.25	1.25	6.000	.470	1.500	1003		

SROC R/L Toolholder

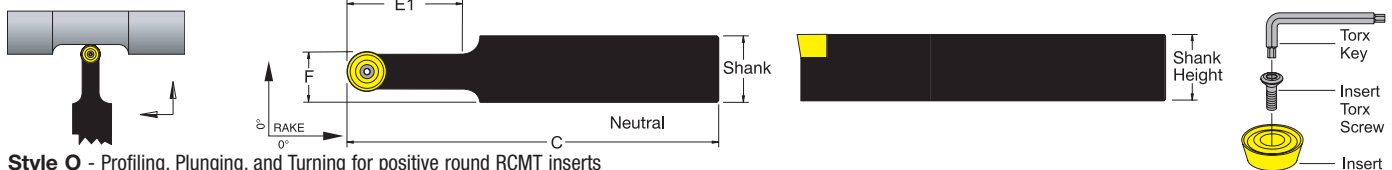

Style O - Profiling, Plunging, and Turning for positive round RCMT inserts

Screw Lock Positive RCMT Toolholders

Description	EDP No. Neutral	Shank Width	Shank Height	C	E1	F	RCMT Insert	Insert Torx Screw	Lock Pin	Torx Key
SROCR/L12-06-B	59838	.750	.750	4.500	.750	.493	0602			
SROCR/L16-06-D	59839	1.00	1.00	6.000	1.00	.618	0602	TS-25.456M1	T-7	
SROCR/L20-06-D	59840	1.25	1.25	6.000	1.25	.743	0602			
SROCR/L12-08-B	59841	.750	.750	4.500	.750	.533	0803			
SROCR/L16-08-D	59842	1.00	1.00	6.000	1.00	.658	0803	TS-3.5-7M1	T-8	
SROCR/L20-08-D	59843	1.25	1.25	6.000	1.250	.783	0803			
SROCR/L12-10-B	59844	.750	.750	4.500	.750	.572	1003			
SROCR/L16-10-D	59845	1.00	1.00	6.000	1.00	.697	1003	TS-35.6-9M1	T-15	
SROCR/L20-10-D	59846	1.25	1.250	6.000	1.25	.822	1003			

SSDCN Toolholder

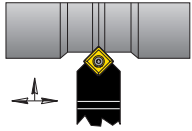

Style D - 45° Side Cutting Edge Angle
for 7° positive square SCMT inserts

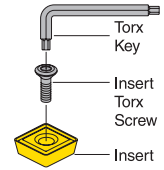
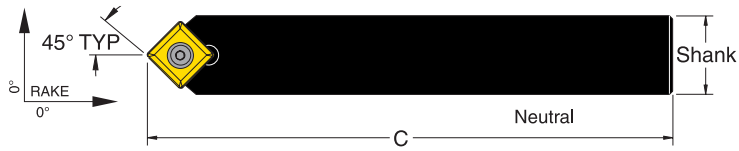

Screw Lock Positive 45° Square Toolholders

Description	EDP No. Neutral	Shank Width	Shank Height	C	SCMT Insert	Insert Torx Screw	Torx Key
SSDCN08-3A	30705	.500	.500	4.0			
SSDCN10-3B	30706	.625	.625	4.5	32.5	TS-4.7-10M1	T-15
SSDCN12-3B	30707	.750	.750	4.5			

SVJC R/L Toolholder

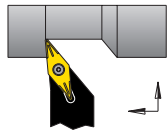

Style J - Neg. 3° Side Cutting Edge Angle
for 7° positive 35° diamond VCMT inserts

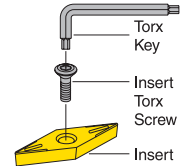
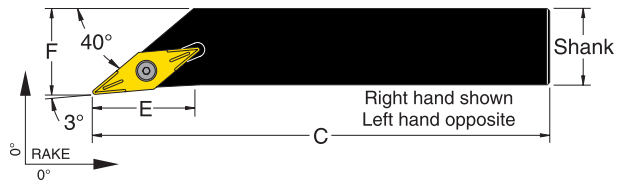

Screw Lock Positive 35° Diamond Toolholders

Description	EDP No.		Shank Width	Shank Height	C	E	F	VCMT Insert	Insert Torx Screw	Torx Key
	Right Hand	Left Hand								
SVJCR/L12-3B	30708	30709	.750	.750	4.5	1.25	1.00			
SVJCR/L16-3D	30710	30711	1.00	1.00	6.0	1.25	1.25	33	TS-4.7-10M1	T-15
SVJCR/L20-3D	30712	30713	1.25	1.25	6.0	1.25	1.50			

SWLC R/L Toolholder

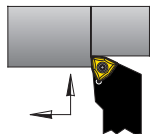

Style L - Neg. 5° End or Side Cutting Edge Angle
for 7° positive 80° trigon WCMT inserts

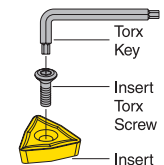
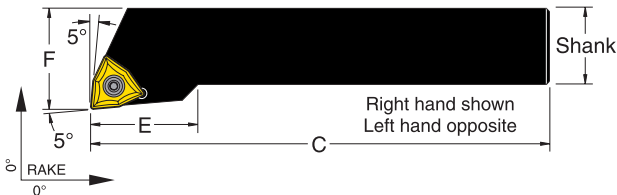

Screw Lock Positive 80° Trigon Toolholders

Description	EDP No.		Shank Width	Shank Height	C	E	F	WCMT Insert	Insert Torx Screw	Torx Key
	Right Hand	Left Hand								
SWLCR/L06-2J	59795	59794	.375	.375	3.5	.49	.500	21.5	TS-25.45-6M1	T-7
SWLCR/L08-3A	30714	30715	.500	.500	4.0	.69	.625			
SWLCR/L10-3B	30716	30717	.625	.625	4.5	.69	.750	32.5	TS-4.7-10M1	T-15
SWLCR/L12-3B	30718	30719	.750	.750	4.5	.69	1.00			
SWLCR/L16-3D	30720	30721	1.00	1.00	6.0	.69	1.25			
SWLCR/L 16-4D	18241	59796	1.00	1.00	6.0	.83	1.250	43	TS-103-4M1	T-20

S-MCLN R/L Boring Bar

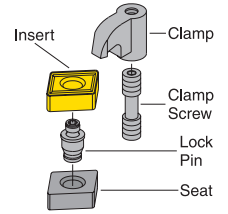
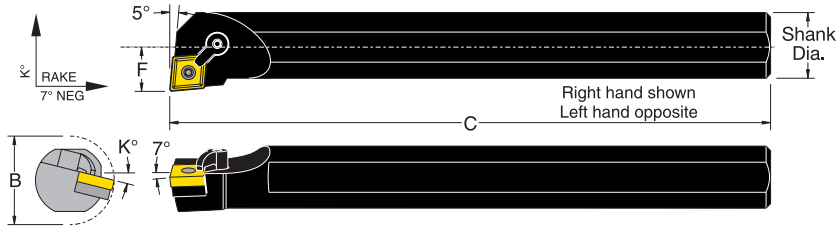
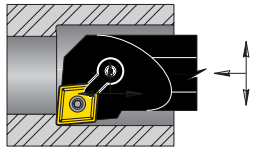

Style L - Neg. 5° Side or End Cutting Edge Angle for negative 80° diamond CNMG inserts

Multiple Lock Negative 80° Diamond Boring Bars

Description	EDP No.		Shank Dia.	Min. Bore	C	F	K°	CNMG Insert	Seat	Lock Pin	Clamp	Clamp Screw	Seat Screw
	Right Hand	Left Hand											
S16T-MCLNR/L-4	30722	30723	1.00	1.280	12.0	0.640	14°	43	—	NL-44	CL-20	XNS-47	—
S20U-MCLNR/L-4	30724	30725	1.25	1.530	14.0	0.765	14°	43	ICSN-433	NL-46	CL-20	XNS-47	S-46
S24U-MCLNR/L-4	30726	30727	1.50	1.780	14.0	0.890	11°						
S28U-MCLNR/L-4	30728	30729	1.75	2.030	14.0	1.015	11°	54	ICSN-533	NL-58	CL-12	XNS-510	S-58
S32V-MCLNR/L-5	30730	30731	2.00	2.562	16.0	1.281	11°						

S-MDUN R/L Boring Bar

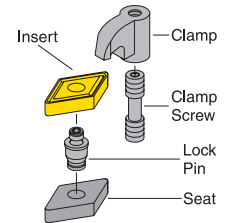
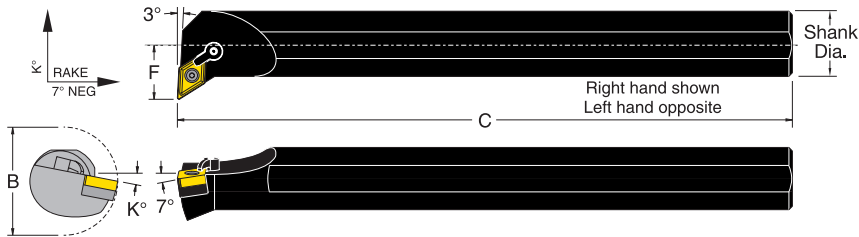
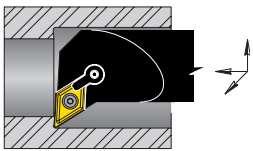

Style U - Neg. 3° End Cutting Edge Angle for negative 55° diamond DNMG inserts

Multiple Lock Negative 55° Diamond Boring Bars

Description	EDP No.		Shank Dia.	Min. Bore	C	F	K°	DNMG Insert	Seat	Lock Pin	Clamp	Clamp Screw	Seat Screw
	Right Hand	Left Hand											
S20U-MDUNR/L-4	30732	30733	1.25	2.00	14.0	1.000	11°	43	IDSN-433	NL-46	CL-12	XNS-59	S-46
S24U-MDUNR/L-4	30734	30735	1.50	2.25	14.0	1.125	11°						
S32V-MDUNR/L-4	30736	30737	2.00	3.00	16.0	1.375	11°						

S-MTFN R/L Boring Bar

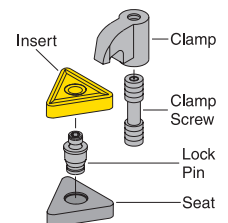
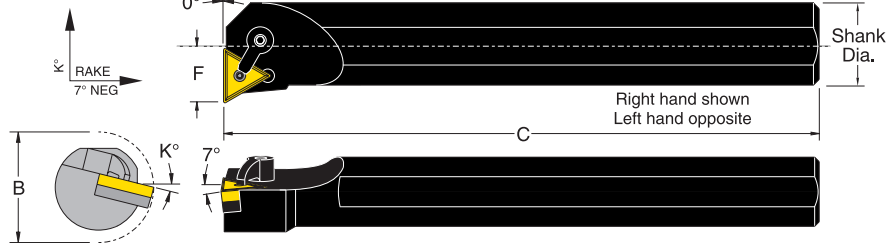

Style F - 0° End Cutting Edge Angle for negative triangle TNMG inserts

Multiple Lock Negative Triangle Boring Bars

Description	EDP No.		Shank Dia.	Min. Bore	C	F	K°	TNMG Insert	Seat	Lock Pin	Clamp	Clamp Screw	Seat Screw
	Right Hand	Left Hand											
S16T-MTFNR/L-3	30738	30739	1.00	1.280	12.0	0.640	14°	33	ITSN-322	NL-34L	CL-7	XNS-35	S-34
S20U-MTFNR/L-3	30740	30741	1.25	1.530	14.0	0.765	14°	43	ITSN-432	NL-46	CL-9	XNS-59	S-46
S24U-MTFNR/L-4	30742	30743	1.50	2.060	14.0	0.890	11°						

For spare parts ordering number see page 62.



S-MTUN R/L Boring Bar

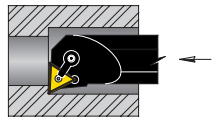

Style U - Neg. 3° End Cutting Edge Angle for negative triangle TNMG inserts

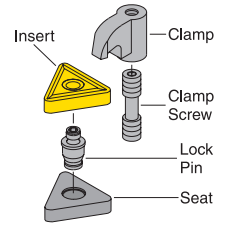
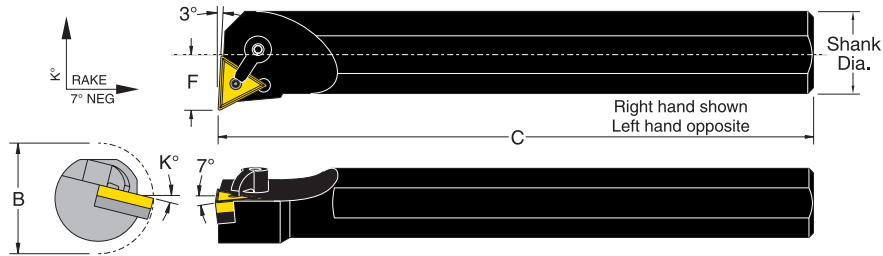

Multiple Lock Negative Triangle Boring Bars

Description	EDP No.		Shank Dia.	Min. Bore -B	C	F	K°	TNMG Insert	Seat	Lock Pin	Clamp	Clamp Screw	Seat Screw
	Right Hand	Left Hand											
S12S-MTUNR/L-3	30744	30745	0.75	1.000	10.0	0.500	14°	33	—	NL-33	CL-7	XNS-35	—
S16T-MTUNR/L-3	30746	30747	1.00	1.280	12.0	0.640	14°	33	ITSN-322	NL-34L	CL-7	XNS-35	S-34
S20U-MTUNR/L-4	30748	30749	1.25	1.530	14.0	0.765	14°	43	ITSN-432	NL-46	CL-9	XNS-59	S-46
S24U-MTUNR/L-4	30750	30751	1.50	2.060	14.0	0.890	11°						

S-MVUN R/L Boring Bar

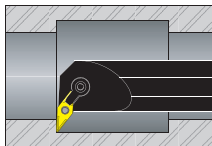

Style U - Negative 3° Side Cutting Edge Angle for negative 35° diamond VNMG inserts

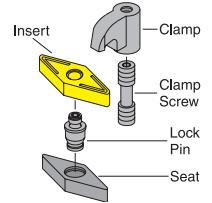
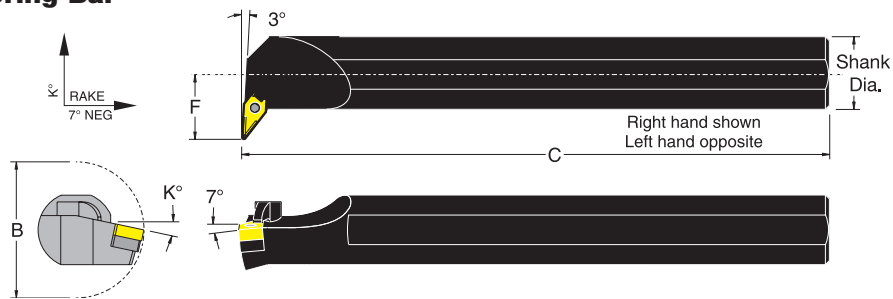

Negative 35° Trigon Boring Bars

Description	EDP No.		Shank Dia.	Min. Bore -B	C	F	K°	VNMG Insert	Seat	Lock Pin	Clamp	Clamp Screw	Seat Screw
	Right Hand	Left Hand											
S12S-MVUNR/L-3	30752	30753	1.00	2.00	12.0	1.000	14°	332	IVSN-322	NL-34L	CL-30	XNS-510	S-34
S32S-MVUNR/L-4	30754	30755	2.00	3.25	16.0	0.625	11°	432	IVSN-433	NL-46	CL-30	XNS-510	S-46

S-MWLN R/L Boring Bar

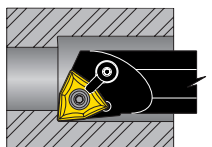

Style L - Neg. 5° Side or End Cutting Edge Angle for negative 80° trigon WNMG inserts

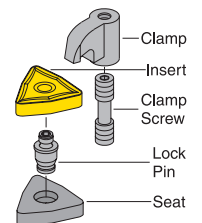
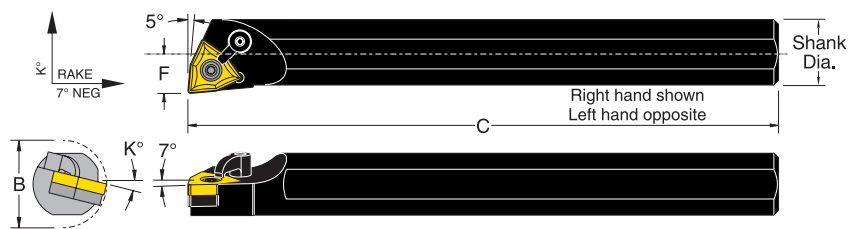

Negative 80° Trigon Boring Bars

Description	EDP No.		Shank Dia.	Min. Bore -B	C	F	K°	WNMG Insert	Seat	Lock Pin	Clamp	Clamp Screw
	Right Hand	Left Hand										
S12S-MWLN R/L-3	30756	30757	0.75	0.93	10.0	0.500	14°	33	—	NL-33L	HC-7	SHC-7
S16T-MWLN R/L-4	30758	30759	1.00	1.28	12.0	0.640	14°	43	—	NL-44	CL-20	XNS-47
S20U-MWLN R/L-4	30760	30761	1.25	1.53	14.0	0.765	14°	43	IWSN-432	NL-46	CL-20	XNS-47
S24U-MWLN R/L-4	30762	30763	1.50	1.78	14.0	0.890	11°					

S-SCLC R/L Boring Bar

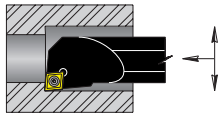

Style L - Neg. 5° End or Side Cutting Edge Angle for 7° positive 80° diamond CCMT inserts

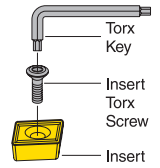
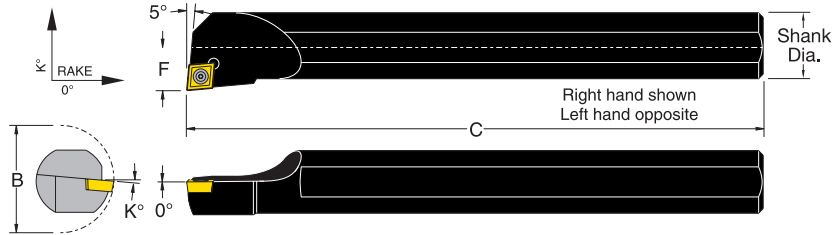

Screw Lock Positive 80° Boring Bars

Description	EDP No.		Shank Dia.	Min. Bore -B	C	F	K°	CCMT Insert	Insert Torx Key	Torx Key
	Right Hand	Left Hand								
S06M-SCLCR/L-2	30764	30765	0.375	0.500	6.00	.250	-11°	21.5	TS-25.45-6M1	T-7
S08M-SCLCR/L-2	30766	30767	0.500	0.625	6.00	.312	-9°			
S08M-SCLCR/L-3	30768	30769	0.500	0.625	6.00	.312	-11°	32.5	TS-4.7-8M1	T-15
S10R-SCLCR/L-3	30770	30771	0.625	0.812	8.00	.406	-7°			
S12S-SCLCR/L-3	30772	30773	0.750	1.000	10.0	.500	-10°	32.5	TS-4.7-10M1	T-15

S-SDUC R/L Boring Bar

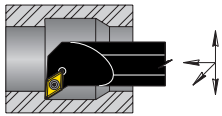

Style U - Neg. 3° End Cutting Edge Angle for 7° positive 55° diamond DCMT inserts

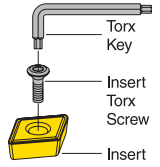
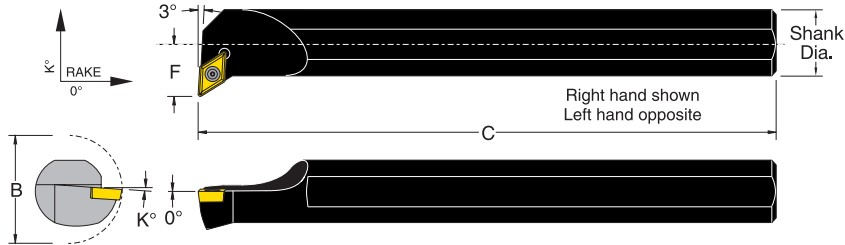

Screw Lock Positive 55° Boring Bars

Description	EDP No.		Shank Dia.	Min. Bore -B	C	F	K°	DCMT Insert	Insert Torx Key	Torx Key
	Right Hand	Left Hand								
S06M-SDUCR/L-2	30774	30775	0.375	0.625	6.00	.375	-11°	21.5	TS-25.45-6M1	T-7
S08M-SDUCR/L-2	30776	30777	0.500	0.780	6.00	.437	-11°			
S10R-SDUCR/L-2	30778	30779	0.625	0.840	8.00	.500	-5°			
S12S-SDUCR/L-3	30780	30781	0.750	1.125	10.0	.562	-6°	32.5	TS-4.7-10M1	T-15

S-STFC R/L Boring Bar

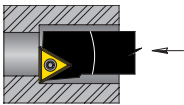

Style F - 0° End Cutting Edge Angle for 7° positive triangle TCGT or CCMT inserts

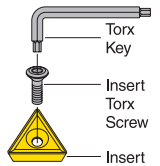
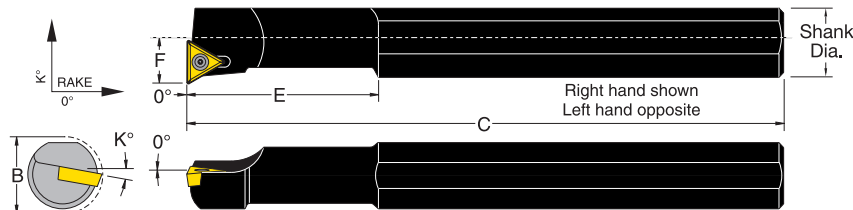

Screw Lock Positive Triangle Boring Bars

Description	EDP No.		Shank Dia.	Min. Bore -B	C	E	F	K°	TCMT Insert	Insert Torx Key	Torx Key
	Right Hand	Left Hand									
S06M-STFCR/L-2	30782	30783	0.375	0.500	6.00	1.00	.250	-11°	21.5	TS-25.45-6M1	T-7
S08M-STFCR/L-2	30784	30785	0.500	0.625	6.00	1.00	.312	-9°			
S12S-STFCR/L-2	30786	30787	0.750	1.000	10.0	1.75	.500	-6°			

STUC R/L Boring Bar

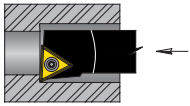

Style L - Neg. 5° End or Side Cutting Edge Angle for 7° positive 80° diamond CCMT inserts

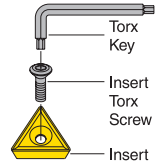
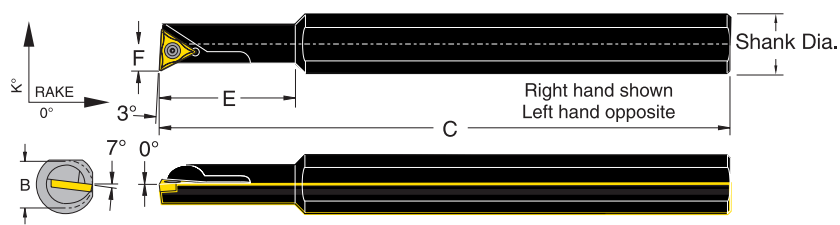

Screw Lock Positive Triangle Boring Bars

Description	EDP No. Right Hand	Shank Dia.	Min. Bore -B	C	E	F	TCMT Insert	Insert Torx Key	Torx Key
S06K-STUCR-2	30788	0.500	0.500	5.00	1.25	.208			
S08M-STUCR-2	30789	0.500	0.590	6.00	1.50	.287	21.5	TS-25.45-6M1	T-7
S10R-STUCR-2	30790	0.625	0.750	8.00	2.25	.350			
S12S-STUCR-3	30791	0.750	0.845	10.0	2.50	.422	32.5	TS-4.7-10M1	T-15
S16T-STUCR-3	30792	1.000	1.115	12.0	3.00	.555			

S-SVUC R/L Boring Bar

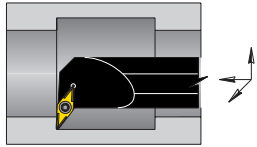

Style U - Neg. 3° End Cutting Edge Angle for 7° positive 35° diamond VCMT inserts

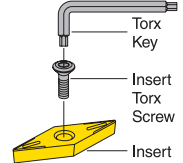
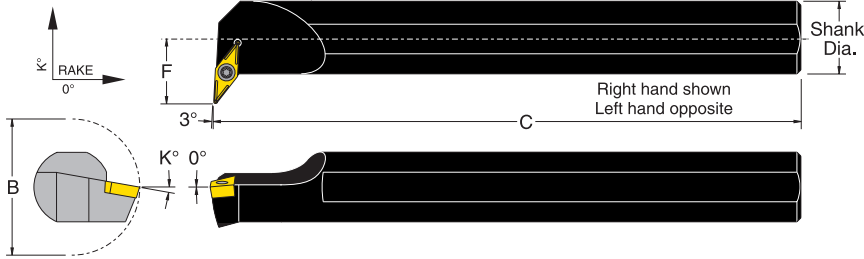

Screw Lock Positive 35° Diamond Boring Bars

Description	EDP No. Right Hand	EDP No. Left Hand	Shank Dia.	Min. Bore -B	C	F	K°	VCMT Insert	Insert Torx Key	Torx Key
S12S-SVUCR/L-2	30793	30794	0.75	1.125	10.0	.625	-6°	22	TS-T-7	
S16T-SVUCR/L-2	30795	30796	1.00	1.500	12.0	.750	-6°			
S16T-SVUCR/L-3	30797	30798	1.00	2.000	12.0	.750	-6°	33	TS-4.7-10M1	T-15
S20U-SVUCR/L-3	30799	30800	1.25	2.250	14.0	1.00	-6°			

S-SWUC R/L Boring Bar

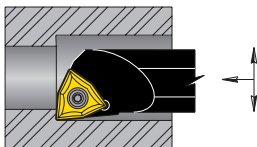

Style U - Neg. 3° End Cutting Edge Angle for 7° positive 80° trigon WCMT inserts

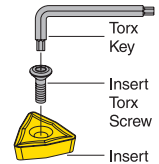
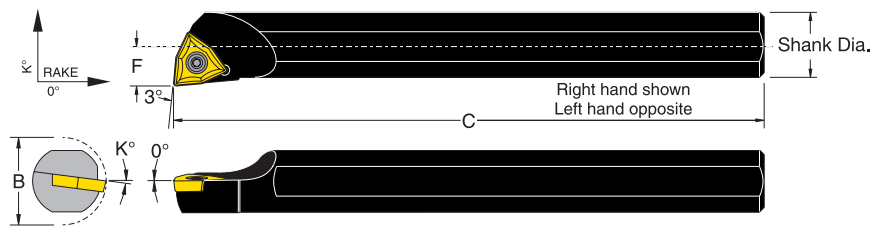

Screw Lock Positive 80° Trigon Boring Bars

Description	EDP No. Right Hand	EDP No. Left Hand	Shank Dia.	Min. Bore -B	C	F	K°	WCMT Insert	Insert Torx Key	Torx Key
S06M-SWUCR/L-2	59793	59792	0.375	0.500	6.00	.250	-11°	21.5	TS-25.45-6M1	T-7
S08M-SWUCR/L-2	59791	59790	0.500	0.625	6.00	.312	-9°			
S08M-SWUCR/L-3	30801	30802	0.500	0.625	6.00	.312	-11°	32.5	TS-4.7-8M1	T-15
S10R-SWUCR/L-3	30803	30804	0.625	0.812	8.00	.406	-7°			
S12S-SWUCR/L-3	30805	30806	0.750	1.000	10.0	.500	-10°	32.5	TS-4.7-10M1	T-15
S16T-SWUCR/L-4	59789	59788	1.000	1.280	12.00	.640	-5°	43	TS-103-4M1	T-20

SCLC R/L Boring Bar

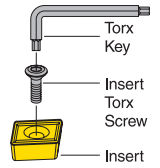
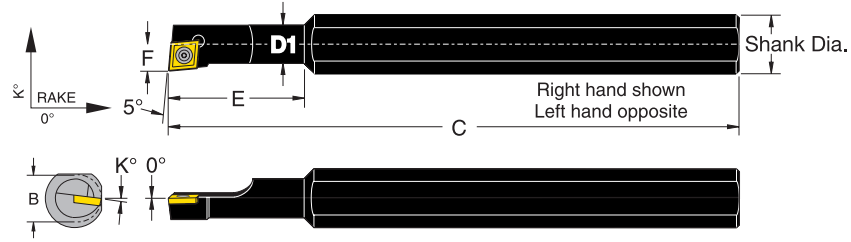
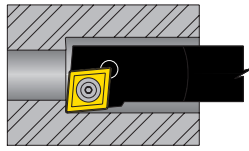

Style L - 0° End Cutting
Edge Angle for 7° positive
80° diamond CCMT inserts

Screw Lock Mini 80° Boring Bars

Description	EDP No. Right Hand	Shank Dia.	Min. Bore -B	C	D1	E	F	K°	CCMT Insert	Insert Torx Key	Torx Key
S06H-SCLCR-2	30807	0.375	0.394	4.00	.315	1.25	.236	-11°	21.5	TS-25.45-6M1	T-7
S08K-SCLCR-2	30808	0.500	0.550	5.00	.390	1.50	.275	-9°			
S10M-SCLCR-2	30809	0.625	0.708	6.00	.472	2.00	.354	-7°			

S-STUC R Boring Bar

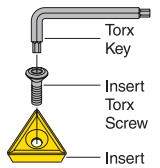
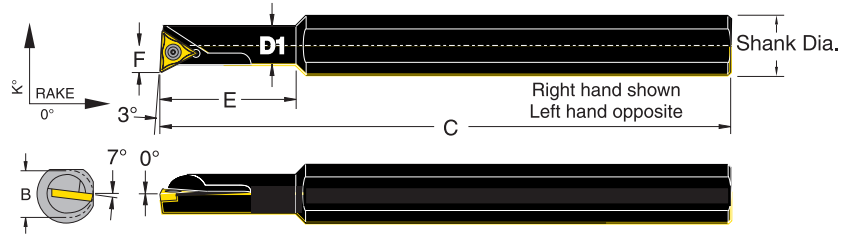
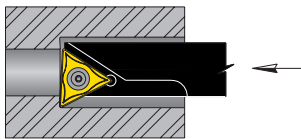

Style U - Neg. 3° End Cutting
Edge Angle for 7° positive
triangle TCMT inserts

Screw Lock Mini Triangle Boring Bars

Description	EDP No. Right Hand	Shank Dia.	Min. Bore -B	C	D1	E	F	DCMT Insert	Insert Torx Key	Torx Key
S08H-STUCR-1.2-2	30810	0.500	0.286	4.00	.265	1.125	.143	21.5	TS-06	T-6
S08H-STUCR-1.2-3	30811	0.500	0.313	4.00	.300	1.125	.157			
S08H-STUCR-1.2-4	30812	0.500	0.374	4.00	.358	1.125	.189			



Spare Parts and Accessories

Shim Seat

Sold in pkgs. of 10

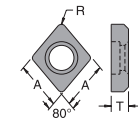

Desc.	EDP No.	A	T	R
Neg. 80° Diamond Shim Seat				
ICSN-432	30813	.500	.1875	.0312
ICSN-433	30814	.500	.1875	.0469
ICSN-533	30815	.625	.1875	.0469
ICSN-633	30816	.625	.1875	.0469

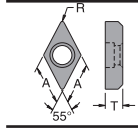

Neg. 55° Diamond Shim Seat				
IDSN-423	30817	.500	.1250	.0469
IDSN-432	30818	.500	.1875	.0312
IDSN-433	30819	.500	.1875	.0469

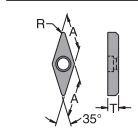

Neg. 35° Diamond Shim Seat				
IVSN-322	30820	.375	.1250	.0312
IVSN-324	30821	.375	.1250	.0625

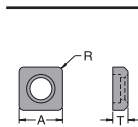

Neg. Square Shim Seat				
ISSN-322	30822	.375	.1250	.0312
ISSN-323	30823	.375	.1250	.0469
ISSN-423	30824	.500	.1250	.0469
ISSN-432	30825	.500	.1875	.0312
ISSN-433	30826	.500	.1875	.0469
ISSN-633	30827	.500	.1875	.0469

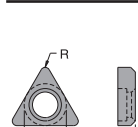

Neg. Triangle Shim Seat				
ITSN-322	30828	.375	.1250	.0312
ITSN-323	30829	.375	.1250	.0469
ITSN-332	30830	.375	.1875	.0312
ITSN-333	30831	.375	.1875	.0469
ITSN-432	30832	.500	.1875	.0312
ITSN-433	30833	.500	.1875	.0469

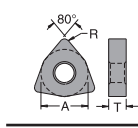

Neg. 80° Trigon Shim Seat				
IWSN-322	30834	.375	.1250	.0312
IWSN-432	30835	.500	.1875	.0312
IWSN-433	30836	.500	.1875	.0469

Finger Clamp Screw

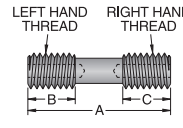

Sold in pkgs. of 10

Desc.	EDP No.	A	B	C	Thread	Hex Size
XNS-35	30851	0.625	.22	.22	10-32	3/32
XNS-36	30852	0.750	.25	.25	10-32	3/32
XNS-47	30853	0.875	.28	.28	1/4-28	1/8
XNS-48	30854	1.000	.37	.37	1/4-28	1/8
XNS-58	30855	1.000	.50	.28	5/16-24	5/32
XNS-59	30856	1.125	.47	.41	5/16-24	5/32
XNS-510	30857	1.250	.50	.50	5/16-24	5/32

Multi-Lock Seat Screw



Sold in pkgs. of 10

Desc.	EDP No.	Insert I.C.	Thread	Hex Size
S-34	30858	.375	10-32	5/64
S-46	30859	.500	1/4-28	3/32
S-58	30860	.625	5/16-24	1/8

Insert Torx Screw

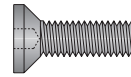

Sold in pkgs. of 10

Desc.	EDP No.	Insert I.C.	Torx Key
Insert Torx Screw			
TS-06	30863	.156	T-6
TS-25.45-6M1	30861	.250	T-7
TS-4.7-8M1	30864	.375	T-15
TS-4.7-10M1	30862	.375	T-15
TS-44-3	30865	.375	T-10
TS-103-4M1	59785	.500	T-120
TS-3.5-7M1	59779	.315	T-8
TS-35.6-9M1	59778	.394	T-15

Finger Clamp

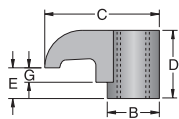

Sold in pkgs. of 10

Desc.	EDP No.	B	C	D	E	G	Thread
CL-5	30837	.280	.52	.350	.102	—	10-32
CL-6	30838	.310	.58	.440	.187	.094	10-32
CL-7	30839	.310	.64	.310	.082	—	10-32
CL-9	30840	.430	.75	.660	.344	.125	5/16-24
CL-12	30841	.430	.88	.660	.344	.125	5/16-24
CL-20	30842	.375	.73	.380	.125	—	1/4-28
CL-30	30843	.430	1.0	.660	.344	.125	5/16-24

Negative Lock Pin

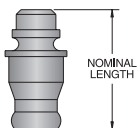

Sold in pkgs. of 10

Desc.	EDP No.	Insert I.C.	Nominal Length	Thread	Hex Size
NL-33	30844	.375	.344	10-32	5/64
NL-33L	30845	.375	.406	10-32	5/64
NL-34	30846	.375	.453	10-32	5/64
NL-34L	30847	.375	.516	10-32	5/64
NL-44	30848	.500	.516	1/4-28	3/32
NL-46	30849	.500	.672	1/4-28	3/32
NL-58	30850	.625	.859	5/16-24	1/8

Quality Through Technology

Research and development



Advanced CAD design



Electron microscope

Research and development oriented to application. Our prime target is our customers' benefit.

Highly advanced tool manufacturing



Machining center

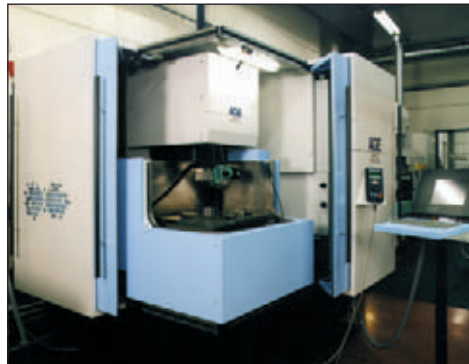

Wire erosion EDM machine



Grinding center

Tungsten carbide manufacturing



Automatic pressing machinery

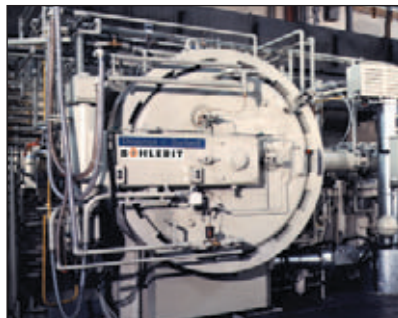

HIP sintering furnace

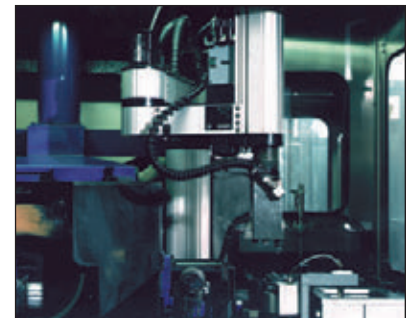

Indexable inserts manufacturing



The most advanced coating technologies
Plasma CVD, MT-CVD, CVD,
PVD - Diamond Film

Recommended Cutting Data for LC215B

Material group	Main workpiece material groups and their characteristic letters		Brinell hardness HB	Recommended Cutting Speed $V_C = \text{SFM}$ when feed = IPR		
				R	M	F
				.016 - .031 	.010 - .016 	.002 - .010
P	Unalloyed steel ¹⁾	≈0.15%C annealed	125	590 - 790	820 - 1150	980 - 1570
		≈0.45%C annealed	190	490 - 690	720 - 1050	890 - 1480
		≈0.45%C hardened and temp.	250	390 - 590	490 - 820	590 - 980
		≈0.75%C annealed	270	460 - 660	660 - 890	820 - 1150
		≈0.75%C hardened and temp.	300	360 - 520	430 - 660	590 - 790
	Low-alloy steel ¹⁾	annealed	180	460 - 660	590 - 890	820 - 1250
		hardened and temp.	275	360 - 560	490 - 720	590 - 890
		hardened and temp.	300	330 - 490	460 - 690	560 - 820
		hardened and temp.	350	300 - 460	430 - 590	490 - 660
	High-alloy steel and high-alloy tool steel ¹⁾	annealed	200	430 - 590	590 - 750	720 - 1150
hardened and temp.		325	260 - 430	330 - 490	460 - 590	
M	Stainless steel ¹⁾	ferritic / martensitic annealed	200	460 - 590	560 - 750	720 - 920
		martensitic hardened and temp.	240	330 - 460	430 - 520	590 - 720
	Stainless steel ¹⁾	austenitic ²⁾ , quenched	180			
K	Grey cast iron	perlitic / ferritic	180	490 - 660	660 - 920	890 - 1310
		perlitic (martensitic)	260	330 - 490	430 - 560	490 - 590
	Nodular graphite cast iron	ferritic	160	430 - 560	490 - 660	590 - 820
		perlitic	250	330 - 430	430 - 560	490 - 620
	Malleable cast iron	ferritic	130	390 - 560	520 - 660	590 - 820
		perlitic	230	330 - 490	460 - 590	520 - 660

¹⁾ and cast steel

²⁾ and austenitic / ferritic

= wet machining

= dry machining

The indicated standard values of cutting data are recommendations for wet machining applications. For dry machining, the cutting speed SFM must be reduced by approx. 20%.

*Hardness comparison table, see page 76.

Machining example:

Workpiece: Screw blank
Material: 42CrMo4 (4140)
Operating conditions: wet
Tool: MCLNR20-4D
Indexable insert: CNMG 432-BM
Böhlerit grade: LC215B
Cutting data: SFM = 720
 $a_p = .157$
 IPR = .0138



Recommended Cutting Data for LC225C

Material group	Main workpiece material groups and their characteristic letters	Brinell hardness HB	Recommended Cutting Speed $V_C = \text{SFM}$ when feed = IPR			
			R	M	F	
			.016 - .031 	.010 - .016 	.002 - .010 	
P	Unalloyed steel ¹⁾	≈0.15%C annealed	125	490 - 660	690 - 980	840 - 1350
		≈0.45%C annealed	190	430 - 590	620 - 890	750 - 1250
		≈0.45%C hardened and temp.	250	330 - 490	430 - 690	490 - 840
		≈0.75%C annealed	270	390 - 560	560 - 750	690 - 980
		≈0.75%C hardened and temp.	300	300 - 460	360 - 560	490 - 660
	Low-alloy steel ¹⁾	annealed	180	390 - 560	490 - 750	690 - 1050
		hardened and temp.	275	300 - 460	430 - 620	490 - 750
		hardened and temp.	300	280 - 430	390 - 590	460 - 690
		hardened and temp.	350	260 - 390	360 - 490	430 - 560
	High-alloy steel and high-alloy tool steel ¹⁾	annealed	200	360 - 490	490 - 660	620 - 980
hardened and temp.		325	230 - 360	280 - 430	390 - 490	
M	Stainless steel ¹⁾	ferritic / martensitic annealed	200	390 - 490	460 - 660	620 - 790
		martensitic hardened and temp.	240	280 - 390	360 - 460	490 - 620
	Stainless steel ¹⁾	austenitic ²⁾ , quenched	180	300 - 360	390 - 520	390 - 620
K	Grey cast iron	perlitic / ferritic	180			
		perlitic (martensitic)	260			
	Nodular graphite cast iron	ferritic	160			
		perlitic	250			
	Malleable cast iron	ferritic	130			
		perlitic	230			

¹⁾ and cast steel

²⁾ and austenitic / ferritic

= wet machining

= dry machining

The indicated standard values of cutting data are recommendations for wet machining applications. For dry machining, the cutting speed SFM must be reduced by approx. 20%.







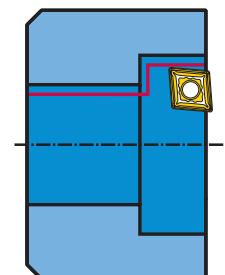









































*Hardness comparison table, see page 76.

Machining example:

Workpiece: Bushing
 Material: X14CrMoS17
 Operating conditions: wet
 Tool: 520U-MCLNL-4
 Indexable insert: CNMG 431-BFM
 Böhlerit grade: LC225C
 Cutting data: SFM = 590
 $a_p = .039$
 IPR = .006





Recommended Cutting Data for LC235C

Material group	Main workpiece material groups and their characteristic letters		Brinell hardness HB	Recommended Cutting Speed $V_C = \text{SFM}$ when feed = IPR		
				R	M	F
				.016 - .031  	.010 - .016  	.002 - .010  
Workpiece material						
P	Unalloyed steel ¹⁾	≈0.15%C annealed	125	 390 - 490	 560 - 690	 660 - 980
		≈0.45%C annealed	190	 330 - 430	 490 - 590	 590 - 840
		≈0.45%C hardened and temp.	250	 230 - 390	 330 - 520	 430 - 660
		≈0.75%C annealed	270	 260 - 430	 360 - 460	 460 - 610
		≈0.75%C hardened and temp.	300	 200 - 330	 300 - 390	 390 - 520
	Low-alloy steel ¹⁾	annealed	180	 300 - 430	 390 - 590	 560 - 790
		hardened and temp.	275	 230 - 360	 330 - 520	 460 - 690
		hardened and temp.	300	 200 - 330	 330 - 490	 430 - 610
		hardened and temp.	350	 180 - 260	 300 - 360	 360 - 480
	High-alloy steel and high-alloy tool steel ¹⁾	annealed	200	 260 - 360	 430 - 520	 510 - 710
hardened and temp.		325	 200 - 300	 260 - 390	 360 - 460	
M	Stainless steel ¹⁾	ferritic / martensitic annealed	200	 300 - 430	 360 - 520	 520 - 660
		martensitic hardened and temp.	240	 230 - 360	 330 - 430	 430 - 520
	Stainless steel ¹⁾	austenitic ²⁾ , quenched	180	 230 - 330	 300 - 460	 360 - 520
K	Grey cast iron	perlitic / ferritic	180			
		perlitic (martensitic)	260			
	Nodular graphite cast iron	ferritic	160			
		perlitic	250			
	Malleable cast iron	ferritic	130			
		perlitic	230			

¹⁾ and cast steel

²⁾ and austenitic / ferritic

 = wet machining

 = dry machining

The indicated standard values of cutting data are recommendations for wet machining applications. For dry machining, the cutting speed SFM must be reduced by approx. 20%.





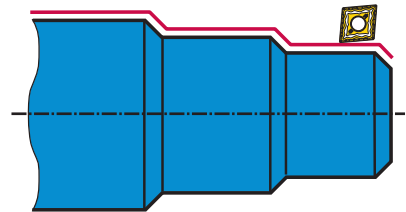

*Hardness comparison table, see page 76.

Machining example:

Workpiece: Axle
 Material: 30M_NB4+Ti
 Operating conditions: wet
 Tool: MCLNL12-4B
 Indexable insert: CNMG 432-BM
 Böhrerit grade: LC235C
 Cutting data: SFM = 490
 $a_p = .118$
 IPR = .0157





Recommended Cutting Data for LC435D

Material group	Main workpiece material groups and their characteristic letters		Brinell hardness HB	Recommended Cutting Speed $v_c = \text{SFM}$ when feed = IPR		
				R	M	F
				.016 - .031  	.010 - .016  	.002 - .010  
P	Unalloyed steel ¹⁾	≈0.15%C annealed	125			
		≈0.45%C annealed	190			
		≈0.45%C hardened and temp.	250			
		≈0.75%C annealed	270			
		≈0.75%C hardened and temp.	300			
	Low-alloy steel ¹⁾	annealed	180			
		hardened and temp.	275			
		hardened and temp.	300			
		hardened and temp.	350			
	High-alloy steel and high-alloy tool steel ¹⁾	annealed	200			
hardened and temp.		325				
M	Stainless steel ¹⁾	ferritic / martensitic annealed	200	390 - 520	490 - 660	590 - 820
		martensitic hardened and temp.	240	300 - 430	360 - 490	460 - 690
	Stainless steel ¹⁾	austenitic ²⁾ , quenched	180	260 - 460	330 - 590	390 - 690
K	Grey cast iron	perlitic / ferritic	180			
		perlitic (martensitic)	260			
	Nodular graphite cast iron	ferritic	160			
		perlitic	250			
	Malleable cast iron	ferritic	130			
		perlitic	230			

¹⁾ and cast steel

²⁾ and austenitic / ferritic

 = wet machining

 = dry machining

The indicated standard values of cutting data are recommendations for wet machining applications. For dry machining, the cutting speed SFM must be reduced by approx. 20%.

*Hardness comparison table, see page 76.

Machining example:

Workpiece: Connector
 Material: AISI 304
 Operating conditions: wet
 Tool: MCLNL16-4D
 Indexable insert: CNMG 432-BMRS
 Böhlerit grade: LC435D
 Cutting data: SFM = 590
 $a_p = .236$
 IPR = .0138

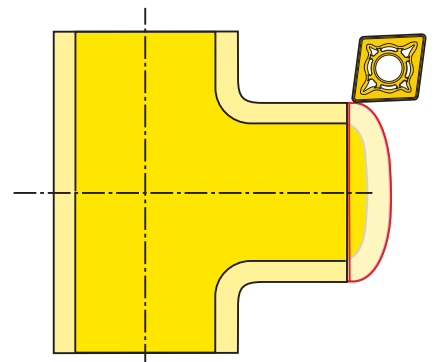

Recommended Cutting Data for LC610M

Material group	Main workpiece material groups and their characteristic letters		Brinell hardness HB	Recommended Cutting Speed $v_c = \text{SFM}$ when feed = IPR		
				R	M	F
				.016 - .031 	.010 - .016 	.002 - .010
	Workpiece material					
M	Stainless steel ¹⁾	austenitic ²⁾ , quenched	180			**390 - 980
		perlitic / ferritic	180			*260 - 820
K	Grey cast iron	perlitic (martensitic)	260			
		ferritic	160			*230 - 660
	Nodular graphite cast iron	perlitic	250			
		ferritic	130			*260 - 720
	Malleable cast iron	perlitic	230			
N	Aluminum wrought alloys	unhardenable	60	1640 - 6560	1970 - 8200	2300 - 9840
		hardenable, hardened	100	660 - 3280	980 - 4920	1310 - 6560
	Aluminum cast alloys	≤ 12% Si. unhardenable	75	1310 - 2620	1640 - 3940	1970 - 4920
		≤ 12% Si. hardenable, hardened	90	980 - 1970	1310 - 2950	1640 - 3940
		> 12% Si. unhardenable	130	660 - 1970	980 - 2620	1310 - 3280
	Copper and copper alloys (Bronze / Brass)	Free cutting alloys Pb>1%	110	820 - 1310	820 - 1640	1480 - 2130
		Brass, Red bronze	90	820 - 1970	820 - 2620	1480 - 3280
		Bronze, non leaded copper and electrolytic copper	100	490 - 820	590 - 980	660 - 1310
	Nonmetallic materials	Duroplastics				
		Fibre reinforced plastics		200 - 230	260 - 330	300 - 390
Hard rubber						

¹⁾ and cast steel

²⁾ and austenitic / ferritic

** Only for finishing: IPR 0.01 IPR, a_{pmax} 0.02

* Only for materials with hardness not exceeding 200 HB

= wet and dry machining

The indicated standard values of cutting data are recommendations for wet machining applications. For dry machining, the cutting speed SFM must be reduced by approx. 20%.

*Hardness comparison table, see page 76.

Machining example:

Workpiece: Casing of telescopic sight

Material: 2011

Operating conditions: dry

Tool: SVJCR16-3D

Indexable insert: VCGT 331-ALC

Böhlerit grade: LC610M

Cutting data: SFM = 2.952
 a_p = .080
IPR = .010



Recommended Cutting Data for LW610, LC610A

Material group	Main workpiece material groups and their characteristic letters		Brinell hardness HB	Recommended Cutting Speed $v_c = \text{SFM}$	
				LW610	LC610A
				when feed = IPR	
	Workpiece material			.004 - .016	.004 - .016
M	Stainless steel ¹⁾	austenitic ²⁾ , quenched	180		
		K	Grey cast iron	perlitic / ferritic	180
perlitic (martensitic)	260			330 - 490	
Nodular graphite cast iron	ferritic		160	430 - 590	
	perlitic		250	330 - 490	
Malleable cast iron	ferritic		130	390 - 590	
	perlitic		230	330 - 520	
N	Aluminum wrought alloys	unhardenable	60	1300 - 8000	1640 - 11480
		hardenable, hardened	100	500 - 5500	660 - 8200
	Aluminum cast alloys	≤ 12% Si. unhardenable	75		1310 - 6560
		≤ 12% Si. hardenable, hardened	90		980 - 4920
		> 12% Si. unhardenable	130		660 - 3940
	Copper and copper alloys (Bronze / Brass)	Free cutting alloys Pb>1%	110		820 - 2300
		Brass, Red bronze	90		820 - 3940
		Bronze, non leaded copper and electrolytic copper	100		490 - 1970
	Nonmetallic materials	Duroplastics			300 - 490
		Fibre reinforced plastics			
Hard rubber					

¹⁾ and cast steel

²⁾ and austenitic / ferritic

= wet and dry machining

The indicated standard values of cutting data are recommendations for wet machining applications. For dry machining, the cutting speed SFM must be reduced by approx. 20%.

*Hardness comparison table, see page 76.

Machining example:

Workpiece:

Material: Aluminum Cast
 Operating conditions: wet
 Tool: MVJNR16-4D
 Indexable insert: VCGT4(3.5)(8)
 Böhlert grade: LC610A
 Cutting data: SFM = 2.624
 $a_p = .118$
 IPR = .012

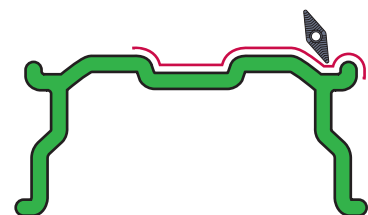

Selecting a clamping system

To make it easier to select the correct tool, the LMT-FETTE range has been assessed for each process type.

M-type tool holders		Process type	External		Internal		
		Roughing Finishing	Very good Good		Very good Good		
		Shape of the indexable insert	 	 	 		
		Type of the indexable insert	Double-sided Smooth	Double-sided With chip breaker	Single-sided With chip breaker		
S-type tool holders		Process type	External		Internal		
		Roughing Finishing	Suitable Very good		Suitable Very good		
		Shape of the indexable insert	 	 	 		
		Type of the indexable insert	Single-sided With chip breakers	Single-sided Smooth			

Selecting tools for internal work

The following guidelines must be observed when selecting the tools for internal work:

General recommendations:

- Use the largest possible shank diameter
- Use the smallest possible overhang
- Use the correct, stable clamping method for the boring bar.
- Cooling lubricant (or compressed air) can improve chip transport and the surface quality, particularly with deep bores or blind holes.

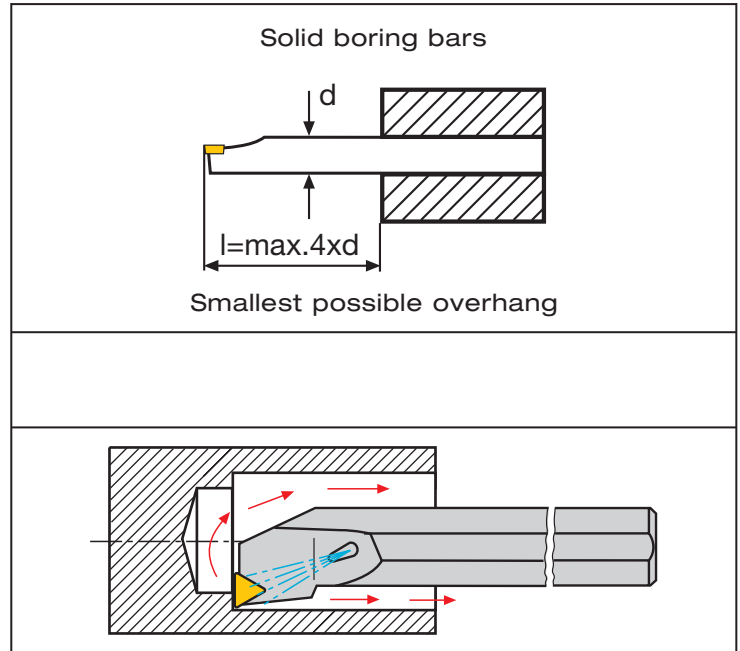

Factors to consider when selecting boring bars for work susceptible to vibration:

- The approach angle should be as close as possible to 90° and not be below 75°.
- Select a small corner radius.
- Use positive holders (S-clamp holder) and indexable inserts.
- Uncoated grades generally have sharper cutting edges and therefore generate less cutting force.

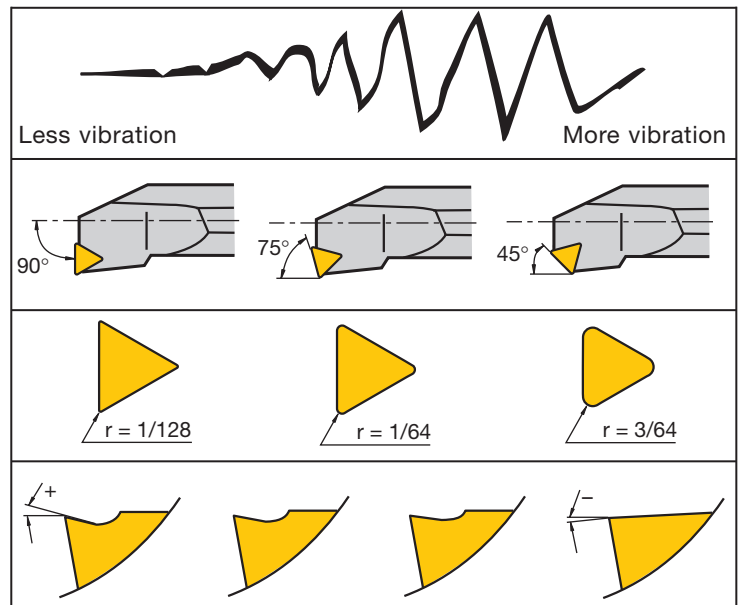

Selecting the indexable insert size

Depth of cut

- Determining the largest depth of cut a_p .
- Determine the effective length of cutting edge (l_a) required. The setting angle (κ) and the depth of cut (a_p) should be taken into consideration.

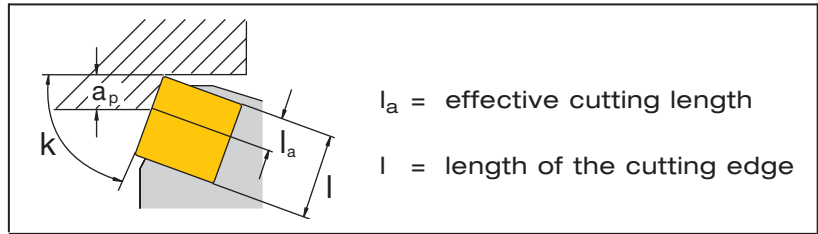

The smallest length of cutting edge (l_a) required can be found in the table below:

Angle of approach κ	Depth of cut (a_p) inch										
	.04	.08	.12	.16	.20	.24	.28	.32	.36	.40	.60
	required effective length of the cutting edge (l_a) inch										
90	.04	.08	.12	.16	.20	.24	.28	.32	.36	.40	.15
105 75	.044	.084	.124	.164	.208	.248	.292	.332	.372	.433	.630
120 60	.047	.091	.138	.185	.228	.276	.323	.366	.433	.472	.709
135 45	.055	.114	.169	.224	.280	.335	.394	.472	.512	.591	.866
150 30	.079	.157	.236	.315	.394	.472	.551	.630	.709	.787	1.181
165 15	.157	.315	.472	.630	.787	.945	1.063	1.220	1.378	1.535	2.283

The effective length of the cutting edge:

The point angle of an indexable insert has a great influence on the stability of the cutting edges. Every indexable insert has a maximum effective cutting edge length. The maximum values given in the table are designed for working safely when rough cutting with a continuous cut.

If the effective length of the cutting edges is lower than the depth of cut, a larger indexable insert should be used or the depth of cut should be reduced.

For additional safety during difficult cutting jobs, a larger or thicker indexable insert should be used. When turning against a shoulder, the depth of cut can be increased considerably. So that no problems arise here, a larger indexable insert should be used or an additional face turning operation should be performed.

R: $l_a = 0.4 \times d$ (depth of cut)	S: $l_a = 2/3 \times l$
C: $l_a = 2/3 \times l$	T: $l_a = 1/2 \times l$
D: $l_a = 1/2 \times l$	K: $l_a = 1/2 \times l$
W: $l_a = 1/4 \times l$	V: $l_a = 1/4 \times l$

Selecting the indexable insert shape

Indexable insert shape

The diagram shows the most common indexable insert shapes from round tips right down to 35° indexable inserts.

The arrow on the scale shows that the greater the stability of the cutting edge (S), the higher the point angle on the left is. With regard to accessibility (Z), the indexable inserts shown on the right are the most suitable.

The arrow on the scale shows that the tendency to vibration (V) on the left increases, whereas the power required (P) is lower.

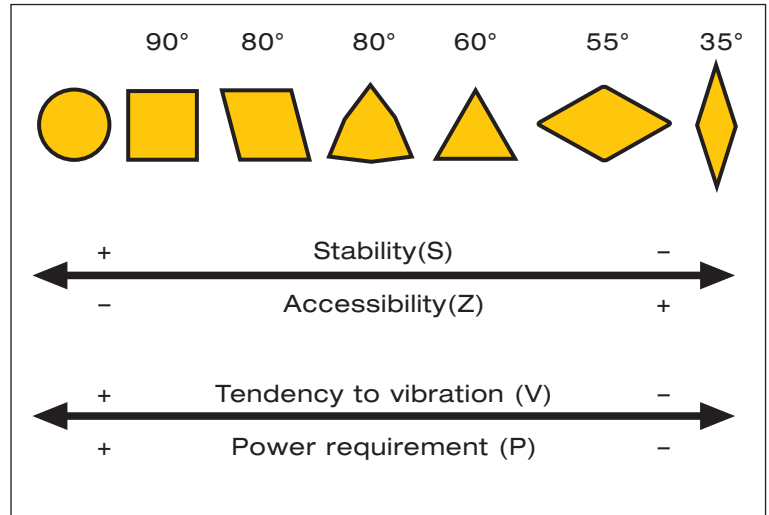

When turning shapes the maximum copy angle must not be exceeded for inward copying. The angle between the secondary cutting edges and the workpiece shape produced should be at least 2°.

Corner radius and feed

The corner radius of the indexable insert is a key factor with regard to:

- Stability during rough cutting
- Surface quality during finishing

Roughing

- Use the largest possible corner radius to ensure the greatest degree of stability for the cutting edge.
- A large corner radius permits a greater feed rate.
- Use a smaller corner radius if there is a risk of vibration.

When selecting the feed rate for rough turning work, the maximum feed rates given above must not be exceeded in any circumstances. The basic rule is:

$$\text{IPR ROUGHING} = 0.5 \times \text{CORNER RADIUS}$$

Maximum feed rate for various corner radii

Corner radius (r) inch	1/64 .016	1/32 .031	3/64 .047	1/16 .062	3/32 .094
Recommended max. feed rate (f _r) IPR	.01-.014	.016-.028	.02-.04	.028-.05	.04-.07

The most frequently used radii for rough machining are between 3/64 and 1/16 inch.

The table is based on the max. recommended feed rate of 2/3 of the corner radius.

Greater feed rates are possible in the following cases:

- Indexable inserts have a stable cutting edge and a point angle of at least 60°
- Single-sided indexable inserts
- Indexable inserts which are used with a setting angle less than 90°
- Working easily machineable workpiece materials at moderate cutting speeds

Formulas for machining work

Units

Code	Description	Unit
D_m	Diameter of workpiece inches	inch
V_c	Cutting speed (feet per min.)	ft/min (sfm)
n	Revolutions per minute of work or tool	rpm
T_c	Cutting time, minutes	min.
Q	Metal removal rate, cubic inches per minutes	cu. ³ /in./min.
l_m	Working length, inches	in
HP_s	Horse power at spindle, hp	hp
HP_m	Horse power at motor, hp	hp
F_n	Feed per revolution	inch/rev (ipr)
F_m	Feed per minutes	ipm
k_r	Approach angle	degree
R_{max}	Profile depth	μ m
r_e	Indexable insert corner radius	inch
a_p	Cutting depth	inch
D_2	Starting diameter	inch
d_2	Finish diameter	inch
K	Unit horse power factor	K

Typical Machine Efficiencies

Direct Drive	.9
Belt Drive	.8
Gear Drive	.7

“K” Factors

Work Material	Brinell Hardness	RC Hardness	“K” Factor
Steels, wrought and cast	85-200	up to 13	1.64
	201-253	13-25	1.56
	254-286	25-30	1.28
	287-327	30-35	1.10
	328-371	35-40	0.88
	372-481	40-50	0.69
	482-560	50-55	0.59
P-H stainless steels	561-615	55-58	0.54
	150-450	1-48	1.27-0.42
Stainless steels, ferritic, austenitic, & martensitic	135-275	up to 29	1.54-0.76
Cast irons, gray, ductile, and malleable	286-421	30-45	0.74-0.50
	110-149	RB	2.27
	150-175	1-7	2.00
	176-200	7-13	1.89
	201-250	13-25	1.52
Titanium	251-300	25-32	1.27
	301-320	32-34.5	1.19
	250-375	25-40.5	1.33-0.87
High temp. alloys nickel, cobalt based	200-360	13-39	0.83-0.48
Iron base	180-320	8-34.5	0.91-0.53
Nickel alloys	80-360	up to 39	0.91-0.53
Aluminum alloys	30-150	RB	6.25-3.33
Magnesium alloys	40-90	RB	10.0-6.67
Copper	150	1	3.33
Copper alloys	100-150	RB	3.33
	151-243	1-23	2.00

Formulas

To Find	Symbols – Formula	Calc. Formula
Cutting speed (sfm)	$.262 \times n \times D_m$	$.262 \times \text{rpm} \times \text{dia.}$
Revolutions per minute	$3.82 \times V_c \div D_m$	$3.82 \times \text{sfm} \div \text{dia.}$
Inches per minute	$f_n \times n$	$\text{ipr} \times \text{rpm}$
Inches per revolutions	$F_m \div n$	$\text{ipm} \div \text{rpm}$
Rate of metal removal cu.in ³ ÷ min.	$\left(\left(\frac{D_2}{2} \right)^2 \times \pi \right) - \left(\left(\frac{d_2}{2} \right)^2 \times \pi \right) \times F_n \times n$	$\left(\left(\frac{\text{start dia.}}{2} \right)^2 \times \pi \right) - \left(\left(\frac{\text{finish dia.}}{2} \right)^2 \times \pi \right) \times \text{ipr} \times \text{rpm}$
Horse power required at spindle HP_s	$Q \div K$	$Q \div K$
Horse power required at the motor HP_m	$HP_s \div \text{EFF}$	$HP_s \div \text{EFF}$
Cutting time, minute	$l_m \div f_m$	$\text{loc} \div \text{ipm}$

Finishing

The surface quality and accuracy of the tolerance is greatly influenced by the feed rate and corner radius. The stability of the clamping system and the machine are other decisive factors.

General recommendation:

- The surface quality can be improved by using higher cutting speeds and positive rake angles.
- Use a smaller corner radius if there is a risk of vibration.
- Especially high quality surfaces can be achieved using uncoated hard metals (sharper cutting edges than coated grades).

Theoretical maximum roughness height (R_{max})

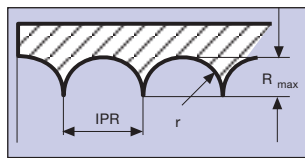

R_{max} = Roughness height
 r = Corner radius (mm)
 IPR = Feed (mm/revolution)

$$R_{max} = \frac{f_n^2}{0.8r} \cdot 1000 \text{ (}\mu\text{m)}$$

$$\text{Feed: } IPR = \sqrt{\frac{R_{max} \times 0.8r}{1000}}$$

The diagram shows theoretical R_{max} values for specific feed/corner radius combinations.

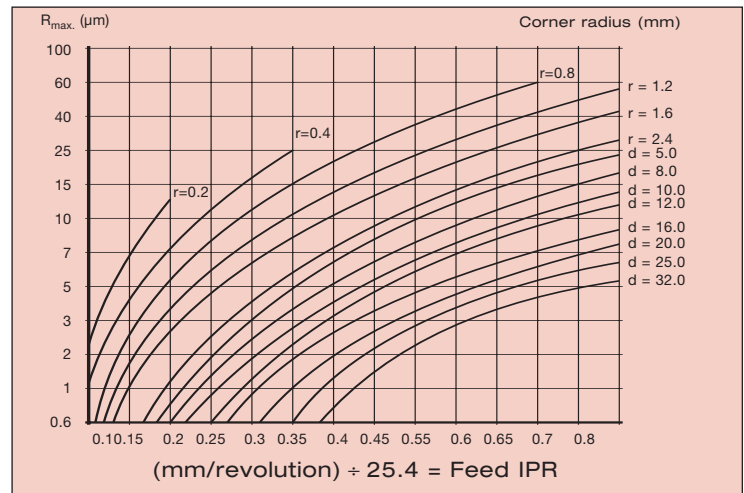

Mean roughness figure (R_a)

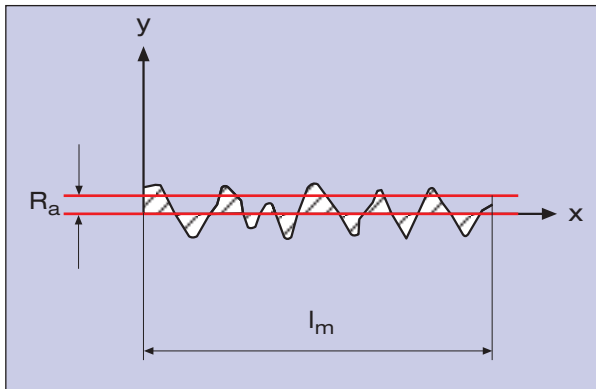

Procedure:

Look up the appropriate R_{max} value in the conversion table. Then read off the correct combination of corner radius and feed rate.

Conversion table for various measurement systems. This cannot be used to calculate the mathematical relationship between the R_{max} roughness height and the figure for R_a .

R_{max} μm	$R_a = \text{CLA} = \text{AA}$		RMS		Value for roughness
	μm	μinch	μm	μinch	
1.6	0.30	11.8	0.33	13.1	
1.8	0.35	13.8	0.39	15.3	
2.0	0.40	15.7	0.44	17.4	N5
2.2	0.44	17.5	0.49	19.4	
2.4	0.49	19.2	0.54	21.3	
2.6	0.53	20.8	0.59	23.1	
2.8	0.58	22.7	0.64	25.2	
3.0	0.63	24.6	0.70	27.3	
3.5	0.71	27.8	0.79	30.9	
4.0	0.80	31.4	0.89	34.8	N6
4.5	0.90	35.2	1.0	39.1	
5.0	0.99	38.8	1.1	43.1	
6.0	1.2	47.2	1.3	52.4	
7.0	1.4	55.1	1.5	61.2	
8.0	1.6	63.0	1.8	70.0	N7
9.0	1.8	71	2.0	78.8	
10.0	2.0	97	2.2	87.7	
15.0	3.2	126	3.10	140	N8
20.0	4.4	173	4.9	192	
25.0	5.8	238	6.4	264	
27.0	6.3	247	7.0	274	N9
30.0	7.4	292	8.2	324	
35.0	8.8	346	9.8	384	
40.0	10.7	422	11.9	468	
45.0	12.5	485	13.9	538	N10
50.0	14.0	552	15.5	613	



Hardness-Comparison Table

Tensile strength Rm N/mm ²	Vickers hardness HV	Brinell hardness HB	Rockwell hardness HRC	Tensile strength Rm N/mm ²	Vickers hardness HV	Brinell hardness HB	Rockwell hardness HRC
255	80	76		1125	350	333	35.5
270	85	80.7		1155	360	342	36.6
285	90	85.5		1190	370	352	37.7
305	95	90.2		1220	380	361	38.8
320	100	95		1155	390	371	39.8
335	105	99.8		1290	400	380	40.8
350	110	105		1320	410	390	41.8
370	115	109		1350	420	399	42.7
385	120	114		1385	430	409	43.6
400	125	119		1420	440	418	44.5
415	130	124		1455	450	428	45.3
430	135	128		1485	460	437	46.1
450	140	133		1520	470	447	46.9
465	145	138		1555	480	(456)	47.7
480	150	143		1595	490	(466)	48.4
495	155	147		1630	500	(475)	49.1
510	160	152		1665	510	(485)	49.8
530	165	156		1700	520	(494)	50.5
545	170	162		1740	530	(504)	51.1
560	175	166		1775	540	(513)	51.7
575	180	171		1810	550	(523)	52.3
595	185	176		1845	560	(532)	53.0
610	190	181		1880	570	(542)	53.6
625	195	185		1920	580	(551)	54.1
640	200	190		1955	590	(561)	54.7
660	205	195		1995	600	(570)	55.2
675	210	199		2030	610	(580)	55.7
690	215	204		2070	620	(589)	56.3
705	220	209		2105	630	(599)	56.8
720	225	214		2145	640	(608)	57.3
740	230	219		2180	650	(618)	57.8
755	235	223			660		58.3
770	240	228	20.3		670		58.8
785	245	233	21.3		680		59.2
800	250	238	22.2		690		59.7
820	255	242	23.1		700		60.1
835	260	247	24		720		61.0
850	265	252	24.8		740		61.8
865	270	257	25.6		760		62.5
880	275	261	26.4		780		63.3
900	280	266	27.1		800		64.0
915	285	271	27.8		820		64.7
930	290	276	28.5		840		65.3
950	295	280	29.2		860		65.9
965	300	285	29.8		880		66.4
995	310	295	31		900		67.0
1030	320	304	32.2		920		67.5
1060	330	314	33.3		940		68.0
1095	340	323	34.4				

Tensile strength	N/mm ²	R _m
Vickers hardness	Diamond pyramid 136° Test force F ≥ 98 N	HV
Brinell hardness calculated from: HB = 0.95 x HV	0.102 x F/D ² = 30 N/mm ² F = Test force in N D = Ball diameter in mm	HB
Hardness Rockwell C	Diamond cone 120° Total test force 1471 ± 9 N	HRC

Options against machining problems

Solution	Problem											
	Extreme Flank Wear	Extreme Crater Wear	Formation of Built-Up Edge	Chips in Cutting Edge	Notching	Broken Indexable Insert (Fracture)	Thermal heat Crack	Plastic Deformation	Interrupted Cut	Poor Workpiece Surface	No Chip Control	Too Tight of Chip
Cutting Time	↑↑				↑↑			↑↑				
Wear Resistance	↑↑				↑↑			↑↑				
Cutting Time Toughness				↑↑		↑↑	↑↑		↑↑			
Cutting Speed	↓↓	↓↓	↑↑		↓↓			↓↓	↑↑	↑↑		
Feed	↔	↓↓	↓↓					↓↓	↓↓	↓↓	↑↑	↓↓
Depth of cut					↔				↓↓		↔	↔
Chip angle		↑↑	↑↑	↓↓		↓↓			↔			
Chip breaker geometry				↔		↔					↔	↔
Condition of cutting edge				↔					↔			
Corner radius						↑↑			↑↑	↑↑		
Approach angle				↓↓								
Stability				↑↑								
Cooling		↑↑	↑↑				↑↑	↑↑		↑↑		

↑↑ : increase

↓↓ : reduce

↔ : optimize

Comparison table of materials to be machined

Material group	Country									
	Germany		Great Britain		France	Italy	Belgium	Sweden	Spain	U.S.A.
	W-Nr.	DIN	BS	EN	AFNOR	UNI	NBN	SS	UNF	AISI/SAE
P	Constructional steels									
	1.0401	C15	080M15	-	CC12	C15C16	-	1350	F.111	1015
	1.0402	C22	050A20	2C	CC20	C20C21	C25-1	1450	F.112	1020
	1.0501	C35	060A35	-	CC35	C35	C35-1	1550	F.113	1035
	1.0503	C45	080M46	-	CC45	C45	C45-1	1650	F.114	1045
	1.0535	C55	070M55	-	-	C55	C55-1	1655	-	1055
	1.0601	C60	080A62	43D	CC55	C60	C60-1	-	-	1060
	1.0715	9SMn28	230M07	-	S250	CF9SMn28	-	1912	11SMn28	1213
	1.0718	9SMnPb28	-	-	S250Pb	CF9SMnPb28	-	1914	11SMnPb28	12L13
	1.0722	10SPb20	-	-	10PbF2	CF10SPb20	-	-	10SPb20	-
	1.0726	35S20	212M36	8M	35MF4	-	-	1957	F210G	1140
	1.0736	9SMn36	240M07	1B	S300	CF9SMn36	-	-	12SMn35	1215
	1.0737	9SMnPb36	-	-	S300Pb	CF9SMnPb36	-	1926	12SMn35	12L14
	1.0904	55Si7	250A53	45	55S7	55Si8	55Si7	2085	56Si7	9255
	1.0961	60SiCr7	-	-	60SC7	60SiCr8	60SiCr8	-	60SiCr8	9262
	1.1141	Ck15	080M15	32C	XC12	C16	C16-2	1370	C15K	1015
	1.1157	40Mn4	150M36	15	35M5	-	-	-	-	1039
	1.1158	Ck25	-	-	-	-	C25-2	-	-	1025
	1.1167	36Mn5	-	-	40M5	-	-	2120	36Mn5	1335
	1.1170	28Mn6	150M28	14A	20M5	C28Mn	28Mn6	-	-	1330
	1.1183	Cf35	060A35	-	XC38TS	C36	C36	1572	-	1035
	1.1191	Ck45	080M46	-	XC42	C45	C45-2	1672	C45K	1045
	1.1203	Ck55	070M55	-	XC55	C50	C55-2	-	C55K	1055
	1.1213	Cf53	060A52	-	XC48TS	C53	C53	1674	-	1050
	1.1221	Ck60	080A62	43D	XC60	C60	C60-2	1678	-	1060
	1.1274	Ck101	060A96	-	-	-	-	1870	-	1095
	1.3401	X120Mn12	Z120M12	-	Z120M12	XG120Mn12	-	-	XG120Mn12	-
	1.3505	100Cr6	534A99	31	100C6	100Cr6	-	2258	F.131	52100
	1.5415	15Mo3	1501-240	-	15D3	16Mo3KW	16Mo3	2912	16Mo3	ASTM A204Gr.A
	1.5423	16Mo5	1503-245-420	-	-	16Mo5	16Mo5	-	16Mo5	4520
	1.5622	14Ni6	-	-	16N6	14Ni6	18Ni6	-	15Ni6	ASTM A350LF5
	1.5662	X8Ni9	1501-509;510	-	-	X10Ni9	10Ni36	-	XBNI09	ASTM A353
	1.5680	12Ni19	-	-	Z18N5	-	12Ni20	-	-	2515
	1.5710	36NiCr6	640A35	111A	35NC6	-	-	-	-	3135
	1.5732	14NiCr10	-	-	14NC11	16NiCr11	-	-	15NiCr11	3415
	1.5752	14NiCr14	655M13; 655A12	36A	12NC15	-	13NiCr12	-	-	3415;3310
	1.6511	36CrNiMo4	816M40	110	40NCD3	38NiCrMo4(KB)	-	-	35NiCrMo4	9840
	1.6523	21NiCrMo2	805M20	362	20NCD2	20NiCrMo2	-	2506	20NiCrMo2	8620
	1.6546	40NiCrMo22	311-Type 7	-	-	40NiCrMo2(KB)	40NiCrMo2	-	40NiCrMo2	8740
	1.6582	34CrNiMo6	817M40	24	35NCD6	35NiCrMo6(KB)	35CrNiMo6	2541	-	4340
	1.6587	17CrNiMo6	820A16	-	18NCD6	-	17CrNiMo7	-	14NiCrMo13	-
	1.6657	14NiCrMo134	832M13	36C	-	15NiCrMo13	14NiCrMo132	-	14NiCrMo131	-
	1.7015	15Cr3	523M15	-	12C3	-	15Cr2	-	-	5015
	1.7033	34Cr4	530A32	18B	32C4	34Cr4(KB)	34Cr4	-	35Cr4	5132
	1.7035	41Cr4	530M40	18	42C4	41Cr4	42Cr4	-	42Cr4	5140
1.7045	42Cr4	-	-	-	-	-	2245	42Cr4	5140	
1.7131	16MnCr5	(527M20)	-	16MC5	16MnCr5	16MnCr5	2511	16MnCr5	5115	
1.7176	55Cr3	527A60	48	55C3	-	55Cr3	-	-	5155	
1.7218	25CrMo4	1717CDS110	-	25CD4	25CrMo4(KB)	25CrMo4	2225	55Cr3	4130	
1.7220	34CrMo4	708A37	19B	35CD4	35CrMo4	34CrMo4	2234	AM26CrMo4	4137;4135	
1.7223	41CrMo4	708M40	19A	42CD4TS	41CrMo4	41CrMo4	2244	42CrMo4	4140;4142	
1.7225	42CrMo4	708M40	19A	42CD4	42CrMo4	42CrMo4	2244	42CrMo4	4140	
1.7262	15CrMo5	-	-	12CD4	-	-	2216	12CrMo4	-	
1.7335	13CrMo4 4	1501-620Gr27	-	15CD3.5	14CrMo4 5	14CrMo45	-	14CrMo45	ASTM A182	
1.7361	32CrMo12	722M24	40B	30CD12	32CrMo12	32CrMo12	2240	F.124.A	F11;F12	

Comparison table of materials to be machined

Material group	Country									
	Germany		Great Britain		France	Italy	Belgium	Sweden	Spain	U.S.A.
	W.-Nr.	DIN	BS	EN	AFNOR	UNI	NBN	SS	UNF	AISI/SAE
P	Constructional steels									
	1.7380	10CrMo9 10	1501-622 Gr.31;45	-	12CD9.10	12CrMo9.10	-	2218	TU.H	ASTM A182 F.22
	1.7715	14MoV6 3	1503-660-440	-	-	-	13MoCrV6	-	13MoCrV6	-
	1.8159	50CrV4	735A50	47	50CV4	50CrV4	50CrV4	2230	51CrV4	6150
	1.8509	41CrAlMo7	905M39	41B	40CAD6.12	41CrAlMo7	41CrAlMo7	2940	41CrAlMo7	-
	1.8523	39CrMoV13 9	897M39	40C	-	36CrMoV12	39CrMoV13	-	-	-
	Tool steels									
	1.1545	C105W1	-	-	Y ₁ 105	C98KU	-	1880	F.515	W.110
	1.1663	C125W	-	-	Y ₂ 120	C100KU	-	-	F.516	-
	1.2067	100Cr6	BL3	-	Y100C6	C120KU	-	-	(C120)	W.112
	1.2080	X210Cr12	BD3	-	Z200C12	-	-	-	100Cr6	L3
	1.2344	X40CrMoV51	BH13	-	Z40CDV5	X210Cr13KU	-	-	X210Cr12	D3
	1.2363	X100CrMoV51	BA2	-	Z100CDV5	X250Cr12KU	-	2242	X40CrMoV5	H13
	1.2419	105WCr6	-	-	105WC13	X35CrMoV05KU	-	2260	X100CrMoV5	A2
	1.2436	X210CrW12	-	-	107WCr5KU	X40CrMoV511KU	-	2140	105WCr5	-
	1.2542	45WCrV7	BS1	-	-	X100CrMoV51KU	-	2312	X210CrW12	-
	1.2581	X30WCrV9 3	BH21	-	Z30WCV9	X215CrW121KU	-	2710	45WCrSi8	S1
	1.2601	X165CrMoV12	-	-	-	45WCrV8KU	-	-	X30WCrV9	H21
	1.2713	55NiCrMoV6	-	-	55NCDV7	X28W09KU	-	2310	X160CrMoV12	-
	1.2833	100V1	BW2	-	Y ₁ 105V	X30WCrV9 3KU	-	-	F.520.S	L6
	1.3243	S 6-5-2-5	-	-	Z85WDKCV	X165CrMoW12KU	-	102V2KU	-	W210
	1.3255	S 18-1-2-5	BT4	-	Z80WKCV	HS 6-5-2-5	-	2723	HS 6-5-2-5	-
	1.3343	S 6-5-2	BM2	-	Z85WDCV	06-05-04-02	-	-	HS 18-1-1-5	T4
	1.3348	S 2-9-2	-	-	Z100WCWV	18-05-04-01	-	2722	HS 6-5-2	M2
	1.3355	S 18-0-1	BT1	-	Z80WCV	06-05-04-02	-	2782	HS 2-9-2	M7
					09-04-02-02	HS 2-9-2	-	-	HS 18-0-1	T1
					18-04-01	X75W18KU	-	-		

Comparison table of materials to be machined

Material group	Country									
	Germany		Great Britain		France	Italy	Belgium	Sweden	Spain	U.S.A.
	W-Nr.	DIN	BS	EN	AFNOR	UNI	NBN	SS	UNF	AISI/SAE
M	Stainless and heat resisting steels									
	1.4000	X6Cr13	403S17	-	Z6C13	X6Cr13	-	2301	F.3110	403
	1.4001	X7Cr14							F.8401	
	1.4006	X10Cr13	410S21	56A	Z10C14	X12Cr13	-	2302	F.3401	410
	1.4016	X6Cr17	430S15	60	Z8C17	X8Cr17	-	2320	F.3113	430
	1.4027	G-X200Cr14	420C29	56B	Z20C13M	-	-	-	-	-
	1.4034	X46Cr13	420S45	56D	Z40CM	X40Cr14	-	2304	F.3405	-
					Z38C13M					
	1.4057	X20CrNi172	431S29	57	Z15CNI6.02	X16CrNi16	-	2321	F.3427	431
	1.4104	X12CrMoS17	-	-	Z10CF17	X10CrS17	-	2383	F.3117	430F
	1.4113	X6CrMo171	434S17	-	Z8CD17.01	X8CrMo17	-	2325	-	434
	1.4313	X5CrNi134	425C11	-	Z4CND13.4M	-	-	-	-	-
	1.4408	G-X6CrNiMo1810	316C16	-	-	-	-	-	F.8414	-
	1.4718	X45CrSi93	401S45	52	Z45Cs9	X45CrSi8	-	-	F.322	HW3
	1.4724	X10CrAl13	403S17	-	Z10C13	X10CrAl12	-	-	F.311	405
	1.4742	X10CrAl18	430S15	60	Z10CAS18	X8Cr17	-	-	F.3113	430
	1.4747	X80CrNiSi20	443505	59	Z80CSN20.02	X8CrSiNi20	-	-	F.320B	HNW6
	1.4762	X10CrAl24	-	-	Z10CAS24	X16Cr26	-	2322	-	446
	1.4301	X5CrNi1810	304S15	58E	Z6CN18.09	X5CrNi1810	-	2332	F.3551	304
									F.3541	
									F.3504	
	1.4305	X10CrNiS189	303S21	58M	Z10CNF 18.09	X10CrNiS18.09	-	2346	F.3508	303
	1.4306	X2CrNi1911	304S12	-	Z2CN 18.10	X2CrNi18.11	-	2352	F.3503	304L
			304C12		Z3CN 19.10			2333		
	1.4308	G-X6CrNi18 9	304C15	-	Z6CN18.10M	-	-	-	-	-
	1.4310	X12CrNi177	-	-	Z12CN17.07	X12CrNi1707	-	2331	F.3517	301
	1.4311	X2CrNi1810	304S26	-	Z2CN18.10	-	-	2371	-	304LN
	1.4401	X5CrNiMo17122	316S16	58J	Z6CND17.11	X5CrNiMo1712	-	2347	F.3543	316
	1.4429	X2CrNiMoN17133	-	-	Z2CND17.13	-	-	2375	-	316LN
	1.4435	X2CrNiMo18143	316S12	-	Z2CND17.13	X2CrNiMo1713	-	2353	-	316L
	1.4438	X2CrNiMo17133	317S12	-	Z2CND1915	X2CrNiMo1816	-	2367	-	317L
	1.4460	X8CrNiMo275	-	-	-	-	-	2324	-	329
	1.4541	X6CrNiTi1810	2337	312S12	Z6CNT18.10	X6CrNiTi1811	-	58B	F.3553, F.3523	321
	1.4550	X6CrNiNb1810	347S17	58F	Z6CNNb18.10	X6CrNiNb1811	-	2338	F.3552, F.3524	347
	1.4571	X6CrNiMoTi17122	320S17	58J	Z6NDT17.12	X6CrNiMoTi1712	-	2350	F.3535	316Ti
	1.4581	G-X5CrNi	318C17	-	Z4CNDNb	XG8CrNiMo1811	-	-	-	-
		MoNb1810			18 12M					
	1.4583	X10CrNi	-	-	Z6CNDNb	X6CrNiMoNb1713	-	-	-	318
		MoNb1812			17 13B					
	1.4828	X15CrNiSi2012	309S24	-	Z15CNS20.12	-	-	-	-	309
	1.4845	X12CrNi25 21	310S24	-	Z12CN2520	X6CrNi2520	-	2361	F.331	310S
	1.4864	X12NiCrSi3616	-	-	Z12NCS35.16	-	-	-	-	330
	1.4865	G-X40NiCrSi3818	330C11	-	-	XG50NiCr3919	-	-	-	-
	1.4871	X53CrMnNiN219	349S54	-	Z52CMN21.09	X53CrMnNiN219	-	-	-	EV8
			321S12	58B						
1.4878	X12CrNiTi189	321S20	58C	Z6CNT18.12B	X6CrNiTi1811	-	-	F.3523	321	

Comparison table of materials to be machined

Material group	Country									
	Germany		Great Britain		France	Italy	Belgium	Sweden	Spain	U.S.A.
	W.-Nr.	DIN	BS	EN	AFNOR	UNI	NBN	SS	UNF	AISI/SAE
K	Unalloyed grey cast iron									
										ASTM A48-76
		GG 10			Ft 10 D			01 00		
		GG 15	Grade 150		Ft 15 D			01 10		No 20 B
		GG 20	Grade 220		Ft 20 D			01 15		No 25 B
		GG 25	Grade 260		Ft 25 D			01 20		No 30 B
								01 25		No 35 B
		GG 30	Grade 300		R 30 D					No 40 B
		GG 35	Grade 350		Ft 35 D			01 30		No 45 B
		GG 40	Grade 400		Ft 40 D			01 35		No 50 B
								01 40		No 55 B
	Alloyed grey cast iron									
		DIN4694	3468: 1974					MB		ASTM
		GGL-			A32-301			ISO-215		A436-72
		NiCr 20 2	L-NiCr 20 2		L-NC 20 2			05 23		Type 2
	Unalloyed nodular cast									
			2789; 1973		NF A32-201					A536-72
		GGG 40	SNG 420/12		FCS 400-12			07 17-02		60-40-18
		GGG 40.3	SNG 370/17		FGS 370-17			07 17-12		-
		GGG 35.3	-		-			07 17-15		-
		GGG 50	SNG 500/7		FGS 500-7			07 27-02		80-55-06
		GGG 60	SNG 600/3		FGS 600-3			07 32-03		-
		GGG 70	SNG 700/2		FGS 700-2			07 37-01		100-70-03
	Alloyed cast steels									
		DIN 1694								
		GGG NiMn 13 7	L-NiMn 13 7		L-NM 13 7			07 72		-
		GGG NiCr 20 2	L-NiMn 20 2		L-NC 20 2			07 76		Type 2
	Malleable cast iron									
										ASTM A47-74
										A 220-762)
		-	8 290/6		MN 32-8			08 14		
		GTS-35	B 340/12		MN 35-10			08 15		32510
		GTS-45	P 440/7					08 52		40010
	GTS-55	P 510/4		MP 50-5			08 54		50005	
	GTS-65	P 570/3		MP 60-3			08 58		70003	
	GTS-70	P 690/		IP 70-2			08 62		(002)	

Comparison of ISO and ANSI indexable inserts designations

ISO	ANSI	ISO	ANSI
CCGT 060202-BAL	CCGT 2 (1.5) (.5)-BAL	CNMG 090308-BM	CNMG 322-BM
CCGT 060204-BAL	CCGT 2 (1.5) 1-BAL	CNMG 120402-SF	CNMG 430-SF
CCGT 09T302-BAL	CCGT 3 (2.5) (.5)-BAL	CNMG 120404-BF	CNMG 431-BF
CCGT 09T304-BAL	CCGT 3 (2.5) 1-BAL	CNMG 120404-BFM	CNMG 431-BFM
CCGT 120404-BAL	CCGT 431-BAL	CNMG 120404-BFMS	CNMG 431-BFMS
CCGT 120408-BAL	CCGT 432-BAL	CNMG 120404-NF	CNMG 431-NF
		CNMG 120408-BF	CNMG 432-BF
CCGW 060202	CCGW 2 (1.5) (.5)	CNMG 120408-BFM	CNMG 432-BFM
CCGW 060204	CCGW 2 (1.5) 1	CNMG 120408-BFMS	CNMG 432-BFMS
CCGW 09T302	CCGW 3 (2.5) (.5)	CNMG 120408-BM	CNMG 432-BM
CCGW 09T304	CCGW 3 (2.5) 1	CNMG 120408-BMR	CNMG 432-BMR
CCGW 120404	CCGW 431	CNMG 120408-BMRS	CNMG 432-BMRS
CCGW 120408	CCGW 432	CNMG 120408-BMS	CNMG 432-BMS
		CNMG 120408-NF	CNMG 432-NF
CCMT 060202-BSF	CCMT 2 (1.5) (.5)-BSF	CNMG 120408-TF	CNMG 432-TF
CCMT 060202-BSM	CCMT 2 (1.5) (.5)-BSM	CNMG 120408-WG	CNMG 432-WG
CCMT 060202-CF	CCMT 2 (1.5) (.5)-CF	CNMG 120412-BF	CNMG 433-BF
CCMT 060204-BSF	CCMT 2 (1.5) 1-BSF	CNMG 120412-BFM	CNMG 433-BFM
CCMT 060204-BSM	CCMT 2 (1.5) 1-BSM	CNMG 120412-BFMS	CNMG 433-BFMS
CCMT 060204-CF	CCMT 2 (1.5) 1-CF	CNMG 120412-BM	CNMG 433-BM
CCMT 060208-BSF	CCMT 2 (1.5) 2-BSF	CNMG 120412-BMR	CNMG 433-BMR
CCMT 060208-BSM	CCMT 2 (1.5) 2-BSM	CNMG 120412-BMRS	CNMG 433-BMRS
CCMT 09T302-CF	CCMT 3 (2.5) (.5)-CF	CNMG 120412-BMS	CNMG 433-BMS
CCMT 09T304-BSF	CCMT 3 (2.5) 1-BSF	CNMG 120416-BM	CNMG 434-BM
CCMT 09T304-BSM	CCMT 3 (2.5) 1-BSM	CNMG 120416-BMR	CNMG 434-BMR
CCMT 09T304-BSMS	CCMT 3 (2.5) 1-BSMS	CNMG 120416-BMRS	CNMG 434-BMRS
CCMT 09T304-CF	CCMT 3 (2.5) 1-CF	CNMG 120416-BMS	CNMG 434-BMS
CCMT 09T308-BSF	CCMT 3 (2.5) 2-BSF	CNMG 160608-BM	CNMG 542-BM
CCMT 09T308-BSM	CCMT 3 (2.5) 2-BSM	CNMG 160612-BM	CNMG 543-BM
CCMT 09T308-BSMS	CCMT 3 (2.5) 2-BSMS	CNMG 160612-BMR	CNMG 543-BMR
CCMT 09T308-CF	CCMT 3 (2.5) 2-CF	CNMG 160612-BMRS	CNMG 543-BMRS
CCMT 120404-BSF	CCMT 431-BSF	CNMG 160612-BMS	CNMG 543-BMS
CCMT 120404-BSM	CCMT 431-BSM	CNMG 160616-BM	CNMG 544-BM
CCMT 120404-BSMS	CCMT 431-BSMS	CNMG 160616-BMR	CNMG 544-BMR
CCMT 120408-BSF	CCMT 432-BSF	CNMG 160616-BMRS	CNMG 544-BMRS
CCMT 120408-BSM	CCMT 432-BSM	CNMG 160616-BMS	CNMG 544-BMS
CCMT 120408-BSMS	CCMT 432-BSMS	CNMG 190608-BMR	CNMG 642-BMR
		CNMG 190612-BM	CNMG 643-BM
CCMW 09T304	CCMW 3 (1.5) 1	CNMG 190612-BMR	CNMG 643-BMR
CCMW 120404	CCMW 431	CNMG 190612-BMRS	CNMG 643-BMRS
CCMW 120408	CCMW 432	CNMG 190616-BM	CNMG 644-BM
		CNMG 190616-BMR	CNMG 644-BMR
CNGA 120404	CNGA 431	CNMG 190616-BMRS	CNMG 644-BMRS
CNGA 120408	CNGA 432		
CNGA 120412	CNGA 433	CNMM 120408-BR	CNMM 432-BR
		CNMM 120412-BR	CNMM 433-BR
CNMA 120404	CNMA 431	CNMM 120416-BR	CNMM 434-BR
CNMA 120408	CNMA 432	CNMM 160612-BR	CNMM 543-BR
CNMA 120412	CNMA 433	CNMM 160616-BR	CNMM 544-BR
		CNMM 190612-BR	CNMM 643-BR
CNMG 090304-BF	CNMG 321-BF	CNMM 190616-BR	CNMM 644-BR
CNMG 090304-BFM	CNMG 321-BFM	CNMM 190624-BR	CNMM 645-BR
CNMG 090304-BFMS	CNMG 321-BFMS		
CNMG 090304-BM	CNMG 321-BM	CNMX 120408	CNMX 432

Comparison of ISO and ANSI indexable inserts designations

ISO	ANSI	ISO	ANSI
CNMX 190612	CNMX 643	DNMG 110404-TF	DNMG 331-TF
CNMX 190616	CNMX 644	DNMG 110408-BF	DNMG 332-BF
		DNMG 110408-BFM	DNMG 332-BFM
DCGT 070202-BAL	DCGT 2 (1.5) (.5)-BAL	DNMG 110408-BM	DNMG 332-BM
DCGT 070204-BAL	DCGT 2 (1.5) 1-BAL	DNMG 110408EL-BC	DNMG 332EL-BC
DCGT 11T302-BAL	DCGT 3 (2.5) (.5)-BAL	DNMG 110408ER-BC	DNMG 332ER-BC
DCGT 11T304-BAL	DCGT 3 (2.5) 1-BAL	DNMG 110408-NF	DNMG 332-NF
DCGT 11T308-BAL	DCGT 3 (2.5) 2-BAL	DNMG 110412-BF	DNMG 333-BF
		DNMG 110412-BFM	DNMG 333-BFM
DCGW 070202	DCGW 2 (1.5) (.5)	DNMG 110412-BM	DNMG 333-BM
DCGW 070204	DCGW 2 (1.5) 1	DNMG 140405TL20	-
DCGW 11T304	DCGW 3 (2.5) 1	DNMG 140405TL25	-
DCGW 11T308	DCGW 3 (2.5) 2	DNMG 140405TR20	-
		DNMG 140405TR25	-
DCMT 070202-BSF	DCMT 2 (1.5) (.5)-BSF	DNMG 140410TL25	-
DCMT 070202-BSM	DCMT 2 (1.5) (.5)-BSM	DNMG 140410TL32	-
DCMT 070202-CF	DCMT 2 (1.5) (.5)-CF	DNMG 140410TR25	-
DCMT 070204-BSF	DCMT 2 (1.5) 1-BSF	DNMG 140410TR32	-
DCMT 070204-BSM	DCMT 2 (1.5) 1-BSM	DNMG 150404EL-BC	DNMG 431EL-BC
DCMT 070204-CF	DCMT 2 (1.5) 1-CF	DNMG 150404ER-BC	DNMG 431ER-BC
DCMT 070208-BSM	DCMT 2 (1.5) 2-BSM	DNMG 150404-BF	DNMG 431-BF
DCMT 11T302-CF	DCMT 3 (2.5) (.5)-CF	DNMG 150404-BFM	DNMG 431-BFM
DCMT 11T304-BSF	DCMT 3 (2.5) 1-BSF	DNMG 150404-BFMS	DNMG 431-BFMS
DCMT 11T304-BSM	DCMT 3 (2.5) 1-BSM	DNMG 150404-BMS	DNMG 431-BMS
DCMT 11T304-BSMS	DCMT 3 (2.5) 1-BSMS	DNMG 150408EL-BC	DNMG 432EL-BC
DCMT 11T304-CF	DCMT 3 (2.5) 1-CF	DNMG 150408ER-BC	DNMG 432ER-BC
DCMT 11T304-FM	DCMT 3 (2.5) 1-FM	DNMG 150408-BF	DNMG 432-BF
DCMT 11T308	DCMT 3 (2.5) 2	DNMG 150408-BFM	DNMG 432-BFM
DCMT 11T308-BSF	DCMT 3 (2.5) 2-BSF	DNMG 150408-BFMS	DNMG 432-BFMS
DCMT 11T308-BSM	DCMT 3 (2.5) 2-BSM	DNMG 150408-BM	DNMG 432-BM
DCMT 11T308-BSMS	DCMT 3 (2.5) 2-BSMS	DNMG 150408-BMR	DNMG 432-BMR
DCMT 11T308-CF	DCMT 3 (2.5) 2-CF	DNMG 150408-BMRS	DNMG 432-BMRS
DCMT 150408	DCMT 432	DNMG 150408-BMS	DNMG 432-BMS
DCMT 150412	DCMT 433	DNMG 150412-BF	DNMG 433-BF
		DNMG 150412-BFM	DNMG 433-BFM
DCMW 11T304	DCMW 3 (2.5) 1	DNMG 150412-BFMS	DNMG 433-BFMS
DCMW 11T308	DCMW 3 (2.5) 2	DNMG 150412-BM	DNMG 433-BM
		DNMG 150412-BMR	DNMG 433-BMR
DNGA 150404	DNGA 431	DNMG 150412-BMRS	DNMG 433-BMRS
DNGA 150408	DNGA 432	DNMG 150412-BMS	DNMG 433-BMS
DNGA 150604	DNGA 441	DNMG 150416-BM	DNMG 434-BM
DNGA 150608	DNGA 442	DNMG 150416-BMR	DNMG 434-BMR
		DNMG 150416-BMRS	DNMG 434-BMRS
DNMA 150608	DNM 442	DNMG 150416-BMS	DNMG 434-BMS
		DNMG 150604EL-BC	DNMG 441EL-BC
DNMG 110402-NF	DNMG 330-NF	DNMG 150604ER-BC	DNMG 441ER-BC
DNMG 110404-BF	DNMG 331-BF	DNMG 150604-BF	DNMG 441-BF
DNMG 110404-BFM	DNMG 331-BFM	DNMG 150604-BFM	DNMG 441-BFM
DNMG 110404-BFMS	DNMG 331-BFMS	DNMG 150604-BFMS	DNMG 441-BFMS
DNMG 110404-BMS	DNMG 331-BMS	DNMG 150604-BMS	DNMG 441-BMS
DNMG 110404EL-BC	DNMG 331EL-BC	DNMG 150604-TF	DNMG 441-TF
DNMG 110404ER-BC	DNMG 331ER-BC	DNMG 150608EL-BC	DNMG 442EL-BC
DNMG 110404-NF	DNMG 331-NF	DNMG 150608ER-BC	DNMG 442ER-BC
DNMG 110404-SF	DNMG 331-SF	DNMG 150608-BF	DNMG 442-BF

Comparison of ISO and ANSI indexable inserts designations

ISO	ANSI	ISO	ANSI
DNMG 150608-BFM	DNMG 442-BFM	SCGW 120404	SCGW 431
DNMG 150608-BFMS	DNMG 442-BFMS	SCGW 120408	SCGW 432
DNMG 150608-BM	DNMG 442-BM		
DNMG 150608-BMR	DNMG 442-BMR	SCMT 09T304-BSF	SCMT 3 (2.5) 1-BSF
DNMG 150608-BMRS	DNMG 442-BMRS	SCMT 09T308-BSM	SCMT 3 (2.5) 2-BSM
DNMG 150608-BMS	DNMG 442-BMS	SCMT 120404	SCMT 431
DNMG 150608-TF	DNMG 442-TF	SCMT 120404-BSF	SCMT 431-BSF
DNMG 150612-BF	DNMG 443-BF	SCMT 120408	SCMT 432
DNMG 150612-BFM	DNMG 443-BFM	SCMT 120408-BSM	SCMT 432-BSM
DNMG 150612-BFMS	DNMG 443-BFMS	SCMT 120408-BSMS	SCMT 432-BSMS
DNMG 150612-BM	DNMG 443-BM	SCMT 120412	SCMT 433
DNMG 150612-BMR	DNMG 443-BMR	SCMT 120412-BSM	SCMT 433-BSM
DNMG 150612-BMRS	DNMG 443-BMRS		
DNMG 150612-BMS	DNMG 443-BMS	SCMW 09T304	SCMW 3 (2.5) 1
DNMG 150616-BM	DNMG 444-BM	SCMW 120404	SCMW 431
DNMG 150616-BMR	DNMG 444-BMR		
DNMG 150616-BMRS	DNMG 444-BMRS	SNGA 120404	SNG 431
DNMG 150616-BMS	DNMG 444-BMS	SNGA 120408	SNG 432
DNMM 150408-BR	DNMM 432-BR	SNMA 120408	SNM 432
DNMM 150412-BR	DNMM 433-BR	SNMA 120412	SNM 433
DNMM 150608-BR	DNMM 442-BR	SNMA 190612	SNM 643
DNMM 150612-BR	DNMM 443-BR	SNMA 190616	SNM 644
KNUX 160405-L11	-	SNMG 090304-BFM	SNMG 321-BFM
KNUX 160405-L12	-	SNMG 090304-BFMS	SNMG 321-BFMS
KNUX 160405-R11	-	SNMG 120404-BF	SNMG 431-BF
KNUX 160405-R12	-	SNMG 120408-BM	SNMG 432-BM
KNUX 160410-L11	-	SNMG 120408-BMR	SNMG 432-BMR
KNUX 160410-L12	-	SNMG 120408-BMRS	SNMG 432-BMRS
KNUX 160410-R11	-	SNMG 120408-BMS	SNMG 432-BMS
		SNMG 120412-BM	SNMG 433-BM
LNUX 191940SN-BRW		SNMG 120412-BMR	SNMG 433-BMR
LNUX 301940SN-BRW		SNMG 120412-BMRS	SNMG 433-BMRS
LNUX 301940SN-BRWF		SNMG 120412-BMS	SNMG 433-BMS
LNUX 301940SN-BRWR		SNMG 120416-BM	SNMG 434-BM
		SNMG 150608-BM	SNMG 542-BM
RCGT 0602M0-BAL	-	SNMG 150612-BMR	SNMG 543-BMR
RCGT 0803M0-BAL	-	SNMG 150612-BMRS	SNMG 543-BMRS
RCGT 1003M0-BAL	-	SNMG 150616-BMRS	SNMG 544-BMRS
		SNMG 190612-BM	SNMG 643-BM
RCMT 0602M0	-	SNMG 190612-BMR	SNMG 643-BMR
		SNMG 190612-BMRS	SNMG 643-BMRS
RCMX 1003M0	-	SNMG 190616-BMR	SNMG 644-BMR
RCMX 1204M0	-	SNMG 190616-BMRS	SNMG 644-BMRS
RCMX 1606M0	-	SNMG 211040SN-BRW	
RCMX 2006M0	-		
RCMX 2507M0	-	SNMM 120408-BR	SNMM 432-BR
RCMX 3209M0	-	SNMM 120412-BR	SNMM 433-BR
		SNMM 150612-BR	SNMM 543-BR
SCGT 120408-BAL	SCGT 432-BAL	SNMM 190612-BR	SNMM 643-BR
		SNMM 190616-BR	SNMM 644-BR
SCGW 09T304	SCGW 3 (2.5) 1	SNMM 190624-BR	SNMM 646-BR
SCGW 09T308	SCGW 3 (2.5) 2	SNMM 250716	SNMM 854

Comparison of ISO and ANSI indexable inserts designations

ISO	ANSI	ISO	ANSI
SNMM 250724	SNMM 856	TNMA 160404	TNM 331
		TNMA 160412	TNM 333
SNMX 120408	SNMX 432	TNMA 220412	TNM 433
SNMX 120412	SNMX 433		
SNMX 190612-510	SNMX 643-510	TNMG 160404-BF	TNMG 331-BF
SNMX 190616-510	SNMX 644-510	TNMG 160404-BFM	TNMG 331-BFM
		TNMG 160404-BFMS	TNMG 331-BFMS
SNUN 120412	SNUN 433	TNMG 160404-SF	TNMG 331-SF
		TNMG 160408-BFM	TNMG 332-BFM
SPMR 090304-CF	SPMR 321-CF	TNMG 160408-BFMS	TNMG 332-BFMS
		TNMG 160408-BM	TNMG 332-BM
SPMR 090304-FM	SPMR 321-FM	TNMG 160408-BMR	TNMG 332-BMR
SPMR 090308-FM	SPMR 322-FM	TNMG 160408-BMS	TNMG 332-BMS
SPMR 120304-FM	SPMR 421-FM	TNMG 160408-SF	TNMG 332-SF
SPMR 120308-FM	SPMR 422-FM	TNMG 160412-BFM	TNMG 333-BFM
SPMR 120312-FM	SPMR 423-FM	TNMG 160412-BM	TNMG 333-BM
		TNMG 160412-BMR	TNMG 333-BMR
SPUN 090308	SPUN 322	TNMG 160412-BMS	TNMG 333-BMS
SPUN 120304	SPUN 421	TNMG 220408-BM	TNMG 432-BM
SPUN 120308	SPUN 422	TNMG 220408-BMS	TNMG 432-BMS
SPUN 120312	SPUN 423	TNMG 220412-BM	TNMG 433-BM
SPUN 150412	SPUN 533	TNMG 220412-BMR	TNMG 433-BMR
SPUN 190400	-	TNMG 220412-BMS	TNMG 433-BMS
SPUN 190412	SPUN 633	TNMG 220416-BMR	TNMG 434-BMR
SPUN 250620	SPUN 845		
		TNMM 160408-BR	TNMM 332-BR
TCGT 110204-BAL	TCGT 2 (1.5) 1-BAL	TNMM 160412-BR	TNMM 333-BR
TCGT 16T304-BAL	TCGT 3 (1.5) 1-BAL	TNMM 220408-BR	TNMM 432-BR
		TNMM 220412-BR	TNMM 433-BR
TCGW 110204	TCGW 2 (1.5) 1		
		TNMX 160408	TNMX 332
TCMT 110202	TCMT 2 (1.5) (.5)	TNMX 220412	TNMX 433
TCMT 110202-BSF	TCMT 2 (1.5) (.5)-BSF		
TCMT 110202-BSM	TCMT 2 (1.5) (.5)-BSM	TNUN 160408	TNUN 332
TCMT 110204	TCMT 2 (1.5) 1	TNUN 160412	TNUN 333
TCMT 110204-BSF	TCMT 2 (1.5) 1-BSF		
TCMT 110204-BSM	TCMT 2 (1.5) 1-BSM	TPGR 110304	TPGR 221
TCMT 110204-BSMS	TCMT 2 (1.5) 1-BSMS	TPGR 160308	TPGR 322
TCMT 110208-BSF	TCMT 2 (1.5) 2-BSF		
TCMT 110208-BSM	TCMT 2 (1.5) 2-BSM	TPMR 090204-FM	TPMR 1.8 (1.5) 1-FM
TCMT 110208-BSMS	TCMT 2 (1.5) 2-BSMS	TPMR 110304-CF	TPMR 221-CF
TCMT 16T304-BSF	TCMT 3 (2.5) 1-BSF	TPMR 110304-FM	TPMR 221-FM
TCMT 16T304-BSM	TCMT 3 (2.5) 1-BSM	TPMR 110308-CF	TPMR 222-CF
TCMT 16T304-BSMS	TCMT 3 (2.5) 1-BSMS	TPMR 110308-FM	TPMR 222-FM
TCMT 16T304-FM	TCMT 3 (2.5) 1-FM	TPMR 160304-CF	TPMR 321-CF
TCMT 16T308-BSF	TCMT 3 (2.5) 2-BSF	TPMR 160304-FM	TPMR 321-FM
TCMT 16T308-BSM	TCMT 3 (2.5) 2-BSM	TPMR 160308-CF	TPMR 322-CF
TCMT 16T308-BSMS	TCMT 3 (2.5) 2-BSMS	TPMR 160308-FM	TPMR 322-FM
TCMT 16T308-FM	TCMT 3 (2.5) 2-FM		
		TPMX 220412	-
TCMW 110202	TCMW 2 (1.5) (.5)		
TCMW 110204	TCMW 2 (1.5) 1	TPUN 110304	TPUN 221
TCMW 16T304	TCMW 3 (2.5) 1	TPUN 110308	TPUN 222
TCMW 16T308	TCMW 3 (2.5) 2	TPUN 160304	TPUN 321

Comparison of ISO and ANSI indexable inserts designations

ISO	ANSI	ISO	ANSI
TPUN 160308	TPUN 322	WCMT 080404-BSM	WCMT 431-BSM
TPUN 160312	TPUN 323	WCMT 080408-BSF	WCGT 432-BSF
TPUN 220408	TPUN 432	WCMT 080408-BSM	WCGT 432-BSM
TPUN 220412	TPUN 433		
		WNMG 06T302-NF	WNMG 3 (2.5) (.5)-NF
VBMT 160404	VBMT 331	WNMG 06T302-SF	WNMG 3 (2.5) (.5)-SF
VBMT 160408	VBMT 332	WNMG 06T304-NF	WNMG 3 (2.5) 1-NF
VBMT 160412	VBMT 333	WNMG 06T304-SF	WNMG 3 (2.5) 1-SF
		WNMG 06T304-WG	WNMG 3 (2.5) 1-WG
VCGT 110302-BAL	VCGT 220-BAL	WNMG 06T308-NF	WNMG 3 (2.5) 2-NF
VCGT 110304-BAL	VCGT 221-BAL	WNMG 06T308-TF	WNMG 3 (2.5) 2-TF
VCGT 160402-BAL	VCGT 330-BAL	WNMG 06T308-WG	WNMG 3 (2.5) 2-WG
VCGT 160404-BAL	VCGT 331-BAL	WNMG 060404-BF	WNMG 331-BF
VCGT 160408-BAL	VCGT 332-BAL	WNMG 060404-BFM	WNMG 331-BFM
VCGT 160412-BAL	VCGT 333-BAL	WNMG 060404-BFMS	WNMG 331-BFMS
VCGT 220530-BAL	-	WNMG 060408-BF	WNMG 332-BF
		WNMG 060408-BFM	WNMG 332-BFM
VCMT 110302-BSF	VCMT 220-BSF	WNMG 060408-BM	WNMG 332-BM
VCMT 110304-BSF	VCMT 221-BSF	WNMG 060408-BMS	WNMG 332-BMS
VCMT 160404-BSF	VCMT 331-BSF	WNMG 060412-BF	WNMG 333-BF
VCMT 160404-BSM	VCMT 331-BSM	WNMG 060412-BFM	WNMG 333-BFM
VCMT 160404-BSMS	VCMT 331-BSMS	WNMG 060412-BM	WNMG 333-BM
VCMT 160404-CF	VCMT 331-CF	WNMG 080404-BF	WNMG 431-BF
VCMT 160408-BSF	VCGT 332-BSF	WNMG 080404-BFM	WNMG 431-BFM
VCMT 160408-BSM	VCGT 332-BSM	WNMG 080404-BFMS	WNMG 431-BFMS
VCMT 160408-BSMS	VCGT 332-BSMS	WNMG 080404-NF	WNMG 431-NF
VCMT 160408-CF	VCMT 332-CF	WNMG 080408-BF	WNMG 432-BF
VCMT 160412-BSM	VCMT 333-BSM	WNMG 080408-BFM	WNMG 432-BFM
VCMT 160412-BSMS	VCMT 333-BSMS	WNMG 080408-BFMS	WNMG 432-BFMS
		WNMG 080408-BM	WNMG 432-BM
VNMG 160404-BF	VNMG 331-BF	WNMG 080408-BMR	WNMG 432-BMR
VNMG 160408-BM	VNMG 332-BM	WNMG 080408-BMRS	WNMG 432-BMRS
VNMG 160412-BM	VNMG 333-BM	WNMG 080408-BMS	WNMG 432-BM
		WNMG 080408-NF	WNMG 432-NF
VOGT 180610 F	-	WNMG 080408-WG	WNMG 432-WG
VOGW 180612	-	WNMG 080412-BF	WNMG 433-BF
		WNMG 080412-BFM	WNMG 433-BFM
VPGT 110304-BAL	VPGT 221-BAL	WNMG 080412-BM	WNMG 433-BM
VPGT 160412-BAL	VPGT 333-BAL	WNMG 080412-BMR	WNMG 433-BMR
VPGT 220516-BAL	-	WNMG 080412-BMRS	WNMG 433-BMRS
		WNMG 080412-BMS	WNMG 433-BMS
WCGT 06T302-BAL	WCGT 3 (2.5) (.5)-BAL	WNMG 080416-BM	WNMG 434-BM
WCGT 06T304-BAL	WCGT 3 (2.5) 1-BAL	WNMG 080416-BMR	WNMG 443-BMR
WCGT 06T308-BAL	WCGT 3 (2.5) 2-BAL	WNMG 080416-BMRS	WNMG 443-BMRS
WCGT 080404-BAL	WCGT 431-BAL	WNMG 080416-BMS	WNMG 443-BMS
WCGT 080408-BAL	WCGT 432-BAL		
WCMT 06T302-BSF	WCMT 3 (2.5) (.5)-BSF		
WCMT 06T302-BSM	WCMT 3 (2.5) (.5)-BSM		
WCMT 06T304-BSF	WCMT 3 (2.5) 1-BSF		
WCMT 06T304-BSM	WCMT 3 (2.5) 1-BSM		
WCMT 06T308-BSF	WCMT 3 (2.5) 2-BSF		
WCMT 06T308-BSM	WCMT 3 (2.5) 2-BSM		
WCMT 080404-BSF	WCMT 431-BSF		

Turning Tool Performance Report

COMPANY	Name of company	WORKPIECE	Part, description				Report No.	
	Place		Material				Date	
	Department		Standard No.				LMT or Dist. Person	
			Mechanical properties					
MACHINE	Make		N/mm ₂	HB	HV	HRC	Shop Contact Person	
	Type		from					
	Power (hp)		to					
	Tool attachment		Status of treatment					
	Clamping		Surface Cond.					
	Stability when mach.		Required surface	μm	Rz+W	Ra	rms	
Coolant %	Achieved surface	μm	Rz+W	Ra	rms			
Circle the PROCESS OF MACHINING		Test # 1		Test # 2		Test # 3		
Type of Process - OD Turn, Facing, Profiling								
CONDITIONS OF MACHINE								
TOOL - Toolholder or Boring Bar								
Manufacturer								
Description								
CUTTING MAT.	Type of material							
	Manufacturer							
	Grade							
	Shape of insert							
	Chipbreaker Type							
CUTTING PARAM.	Revolutions n [rpm] & D _m [inch]	n :	D _m :	n :	D _m :	n :	D _m :	
	Cutting speed v _c [sfm]							
	Cutting depth a _p [doc]							
	Groove width/Hole diam. [in.]							
	Feed f [ipr]							
	Number of passes							
RESULTS	Tool life / Edge tc-time in cut [min]							
	No. Pieces / Edge [count]							
	Flank wear vb [in.]							
	vb _{max} [in.]							
	Chip breaker performance							
	End of tool life							
VALUATION is + or - or =								
Sketch / Remarks:								
TURNING								

Please fill in CAREFULLY and COMPLETELY, AT LEAST heavy printed fields.



Products and Services

Axial Thread Rolling
Bar Peeling
Carbide Milling Tools & Inserts
Chamfer Tools
Crankshaft Mills
End Mills
FS Turning Heads
Hard Materials
Hobs
Master Gears & Guages
Mold & Die Tools
Rack Cutters
Radial Thread Rolling
Rolling Dies
Shaper Cutters
Shaving Cutters
Tangential Thread Rolling
Taps
Turning
Repair Services for Thread Rolling
Resharpening Services for Hobs
Zip Service for Axial Thread Rolls

LMT-FETTE

18013 Cleveland Parkway, Suite 180
Cleveland, Ohio 44135

1-800-225-0852

tel: 216-377-6130

fax: 216-377-0787

email: Imtfette@Imtfette.com