

1 Indexable Drilling

1

Holemaking

2 Indexable Boring

3 Reaming

4 Indexable Turning

Turning

5 Parting and Grooving

6 Multifunction

Milling

7 Indexable Milling

8 Solid Milling

9 Material examples and
article no. index

List of contents

Symbol explanation	2
Application tips – eccentric devices	3
Toolfinder	4+5
Product program	6–41
Technical Information	
Cutting Data	42–55
Maximum Offset Range	56–58
Coding example, coolant supply	59
Indexable insert drilling – problems / possible causes / solutions	60
KUB Centron – drilling instructions + problems / possible causes / solutions	61+62
Application and Grade Comparison	63+64

KOMET \ Performance

Premium quality tools for high performance.

The premium quality tools from the **KOMET Performance** product line have been designed for specific applications and are distinguished by their outstanding performance. If you make high demands on the performance of your production and want to achieve the very best results, we recommend the Premium tools in this product line.

Symbol explanation

Shank



Cylindrical shank with clamping flat
Guarantees optimum clamping of the tool and
can be clamped in every standard adapter



Drill with ABS connection
The ABS connection from Komet is a modular
coupling system for rotating tools and stationary
tools, and offers a number of advantages, such as
improved force transmission

Coolant supply version



Drill with thru coolant supply
The tried-and-tested thru coolant system
guarantees a reduction in heat at the cutting edges
of the tool as well as improved chip removal



Application tips – Torsional vibration dampeners and eccentric adjusting devices

The modular concept of the ABS connection, will allow you to easily and quickly optimize your drilling operation. Two example of this are the torsional dampening devices and the eccentric adjusting devices.

Torsional vibration dampeners change the natural frequency of the drill assembly. This results in:

- ▲ A significant noise reduction
- ▲ Considerably longer tool life
- ▲ Improved surface finish
- ▲ Improved process reliability

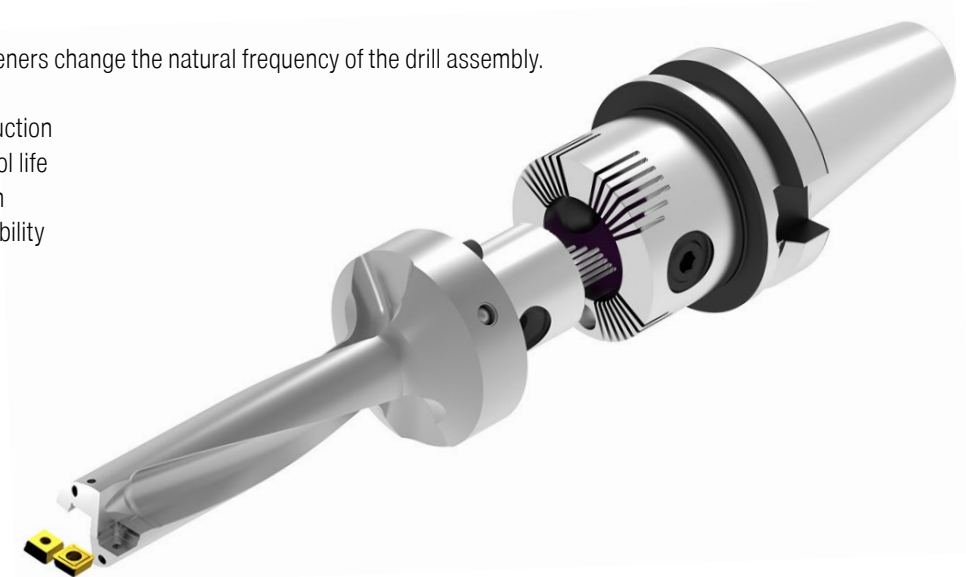

Eccentric adapter with ABS connection

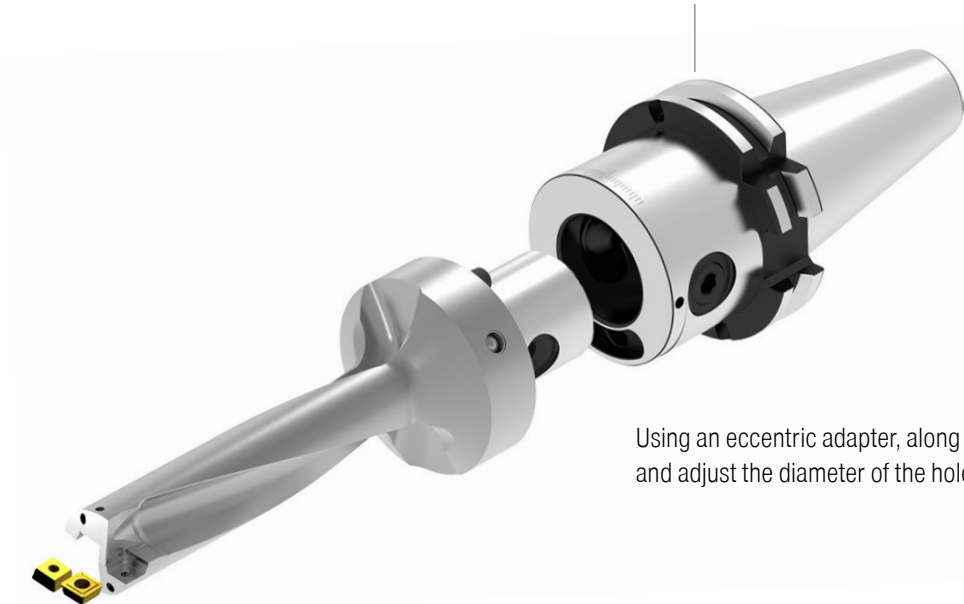

Using an eccentric adapter, along with an ABS drill, you can easily vary and adjust the diameter of the hole by +/- 0.25mm (+/- .010").

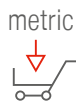

Additional metric items are available in our Online-Shop at cuttingtools.ceratizit.com and in the metric main catalog.



Toolfinder

KUB Pentron



- ▲ The all around tool for process-secure drilling under a wide variety of conditions
- ▲ Ideal for extreme machining situations

	Boring depth	Drilling through a cross hole	Stack plate drilling	Drilling on uneven surfaces	Boring	Spot drilling an edge	Spot drilling a convex surface	Spot drilling angled surfaces	Spot drilling a pointed contour	Chain drilling	Spot drilling through a center in the pre-op
4xD	●	●	○	-	●	●	●	●	○	○	●
5xD	●	○	○	-	●	○	●	○	○	-	○
4xD	●	●	○	-	●	●	●	●	○	○	●
5xD	●	○	○	-	●	○	●	○	○	-	○

KUB Quatron



- ▲ Provides perfect drilling quality even under enormous loads
- ▲ For stable machining situations

	Boring depth	Drilling through a cross hole	Stack plate drilling	Drilling on uneven surfaces	Boring	Spot drilling an edge	Spot drilling a convex surface	Spot drilling angled surfaces	Spot drilling a pointed contour	Chain drilling	Spot drilling through a center in the pre-op
2xD	●	●	●	○	○	●	●	○	○	●	●
3xD	●	●	●	○	○	●	●	○	○	●	●
2xD	●	●	●	○	○	●	●	○	○	●	●
3xD	●	●	●	○	○	●	●	○	○	●	●

KUB Trigon

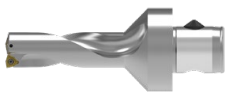

- ▲ Ideal for machining under unstable conditions
- ▲ Well-suited to machining on less powerful machines
- ▲ The first choice for creating dimensionally accurate holes

	Boring depth	Drilling through a cross hole	Stack plate drilling	Drilling on uneven surfaces	Boring	Spot drilling an edge	Spot drilling a convex surface	Spot drilling angled surfaces	Spot drilling a pointed contour	Chain drilling	Spot drilling through a center in the pre-op
2xD	●	-	●	●	○	●	●	○	○	●	○
3xD	●	-	●	●	○	●	●	○	○	●	○
4xD	○	-	○	-	-	○	○	-	○	○	○
2.5xD	●	-	●	●	○	●	●	○	○	●	○
4xD	○	-	○	-	-	○	○	-	○	○	○

MaxiDrill 900



- ▲ Provides perfect drilling quality even under enormous loads
- ▲ Ideal for large drilling depths: The high feed rates increase productivity
- ▲ For stable machining situations











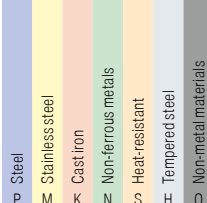

	Boring depth	Drilling through a cross hole	Stack plate drilling	Drilling on uneven surfaces	Boring	Spot drilling an edge	Spot drilling a convex surface	Spot drilling angled surfaces	Spot drilling a pointed contour	Chain drilling	Spot drilling through a center in the pre-op
3xD	●	●	●	○	●	●	●	●	○	○	●
5xD	●	○	○	○	●	●	●	●	○	○	●

KUB Centron



- ▲ Cost-effective and process-secure drilling
- ▲ Hole depths up to 9xD in virtually all materials
- ▲ HSS or solid carbide centering tip for optimum positioning accuracy

	Boring depth	Drilling through a cross hole	Stack plate drilling	Drilling on uneven surfaces	Boring	Spot drilling an edge	Spot drilling a convex surface	Spot drilling angled surfaces	Spot drilling a pointed contour	Chain drilling	Spot drilling through a center in the pre-op
4xD	○	-	●	-	-	○	-	-	○	○	●
6xD	○	-	●	-	-	○	-	-	○	○	●
9xD	○	-	●	-	-	○	-	-	○	○	●

Shank	Diameter Ø	Page No.	Insert type	No. of cutting edges		Page No.		
ABS	0.562 – 1.752	6+7						
ABS	0.562 – 1.752	8+9	 SOGX	4		14+15		
C	0.562 – 1.750	10+11						
C	0.562 – 1.750	12+13						
ABS	0.562 – 2.500	16+17						
ABS	0.562 – 2.500	18+19	 SOEX	4		24+25		
C	0.562 – 1.750	20+21						
C	0.562 – 1.750	22+23						
ABS	0.562 – 3.250	26+27						
ABS	0.562 – 3.250	28+29	 WOEX	3		40+41		
ABS	0.562 – 1.750	30						
C	0.562 – 3.250	31-33						
C	0.562 – 1.750	34+35						
C	0.480 – 2.483						 SONT	2 4
C	0.480 – 1.614							
ABS	0.812 – 2.500		 WOEX	3		40+41		
ABS	0.812 – 2.500	36-38					KUB Centron – centering tips	
ABS	0.812 – 2.500							Ø 5 – 10 mm



KUB Pentron – Indexable insert drill

Scope of supply:

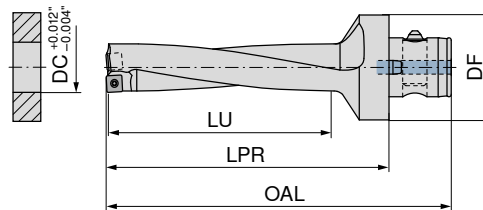
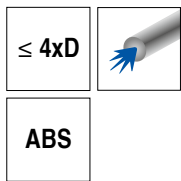
Indexable Insert Drill incl. clamping screws



Designation	KOMET no.	DC inch	DF inch	OAL inch	LU inch	LPR inch	Insert	torque moment Nm	10 874 ...	15 874 ...
KUB-P.4D.0562.R.04.ABS50-F	U44 51430	0.562	1.969	4.685	2.362	3.465	SOGX 040204	0,38		14395
KUB-P.4D.0593.R.04.ABS50-F	U44 51510	0.593	1.969	4.921	2.520	3.701	SOGX 040204	0,38		15195
KUB-P.4D.0625.R.04.ABS50-F	U44 51590	0.625	1.969	4.921	2.520	3.701	SOGX 040204	0,38		15995
KUB-P.4D.0656.R.05.ABS50-F	U44 51670	0.656	1.969	5.118	2.677	3.898	SOGX 050204	0,62		16795
KUB-P.4D.0687.R.05.ABS50	U44 51750	0.689	1.969	5.276	2.835	4.055	SOGX 050204	0,62	17595	
KUB-P.4D.0703.R.05.ABS50-F	U44 51790	0.703	1.969	5.275	2.835	4.055	SOGX 050204	0,62		17995
KUB-P.4D.0750.R.06.ABS50-F	U44 51910	0.750	1.969	5.629	3.150	4.409	SOGX 060206	1,01		19195
KUB-P.4D.0765.R.06.ABS50-F	U44 51940	0.765	1.969	5.629	3.150	4.409	SOGX 060206	1,01		19495
KUB-P.4D.0781.R.06.ABS50-F	U44 51980	0.781	1.969	5.629	3.150	4.409	SOGX 060206	1,01		19895
KUB-P.4D.0812.R.07.ABS50-F	U44 52060	0.812	1.969	5.787	3.307	4.567	SOGX 07T208	1,01		20695
KUB-P.4D.0828.R.07.ABS50	U44 52100	0.827	1.969	5.787	3.307	4.567	SOGX 07T208	1,01	21095	
KUB-P.4D.0875.R.07.ABS50-F	U44 52220	0.875	1.969	6.102	3.622	4.882	SOGX 07T208	1,01		22295
KUB-P.4D.0906.R.07.ABS50	U44 52300	0.906	1.969	6.102	3.622	4.882	SOGX 07T208	1,01	23095	
KUB-P.4D.0937.R.08.ABS50-F	U44 52380	0.937	1.969	6.259	3.780	5.039	SOGX 080308	1,28		23895
KUB-P.4D.0985.R.08.ABS50	U44 52500	0.984	1.969	6.457	3.937	5.236	SOGX 080308	1,28	25095	
KUB-P.4D.1000.R.08.ABS50-F	U44 52540	1.000	1.969	6.614	4.094	5.394	SOGX 080308	1,28		25495
KUB-P.4D.1031.R.09.ABS50-F	U44 52620	1.031	1.969	6.811	4.252	5.591	SOGX 09T308	2,25		26295
KUB-P.4D.1062.R.09.ABS50	U44 52700	1.063	1.969	6.811	4.252	5.591	SOGX 09T308	2,25	27095	
KUB-P.4D.1109.R.09.ABS50-F	U44 52820	1.109	1.969	7.165	4.567	5.945	SOGX 09T308	2,25		28295
KUB-P.4D.1125.R.09.ABS50-F	U44 52860	1.125	1.969	7.165	4.567	5.945	SOGX 09T308	2,25		28695
KUB-P.4D.1156.R.09.ABS50-F	U44 52940	1.156	1.969	7.322	4.724	6.102	SOGX 09T308	2,25		29495
KUB-P.4D.1187.R.10.ABS63-F	U44 63020	1.187	2.480	7.913	4.882	6.417	SOGX 100408	2,8		30196
KUB-P.4D.1218.R.10.ABS63-F	U44 63090	1.218	2.480	7.913	4.882	6.417	SOGX 100408	2,8		30996
KUB-P.4D.1250.R.10.ABS63-F	U44 63180	1.250	2.480	8.071	5.039	6.575	SOGX 100408	2,8		31896
KUB-P.4D.1281.R.10.ABS63	U44 63250	1.280	2.480	8.268	5.197	6.772	SOGX 100408	2,8	32596	
KUB-P.4D.1312.R.11.ABS63-F	U44 63330	1.312	2.480	8.425	5.354	6.929	SOGX 110408	2,8		33396
KUB-P.4D.1328.R.11.ABS63-F	U44 63370	1.328	2.480	8.425	5.354	6.929	SOGX 110408	2,8		33796
KUB-P.4D.1375.R.11.ABS63-F	U44 63490	1.375	2.480	8.622	5.512	7.126	SOGX 110408	2,8		34996
KUB-P.4D.1437.R.11.ABS63	U44 63650	1.437	2.480	8.976	5.827	7.480	SOGX 110408	2,8	36596	
KUB-P.4D.1469.R.12.ABS63-F	U44 63730	1.469	2.480	9.134	5.984	7.638	SOGX 120408	6,25		37396
KUB-P.4D.1500.R.12.ABS63-F	U44 63810	1.500	2.480	9.331	6.142	7.835	SOGX 120408	6,25		38196
KUB-P.4D.1562.R.12.ABS63-F	U44 63970	1.562	2.480	9.488	6.299	7.992	SOGX 120408	6,25		39796
KUB-P.4D.1625.R.12.ABS63-F	U44 64130	1.625	2.480	9.842	6.614	8.346	SOGX 120408	6,25		41396
KUB-P.4D.1656.R.13.ABS63-F	U44 64210	1.656	2.480	10.039	6.772	8.543	SOGX 130508	6,25		42196
KUB-P.4D.1687.R.13.ABS63-F	U44 64290	1.687	2.480	10.039	6.772	8.543	SOGX 130508	6,25		42896
KUB-P.4D.1750.R.13.ABS63	U44 64450	1.752	2.480	10.394	7.087	8.898	SOGX 130508	6,25	44596	

		 Key	 Screwdriver	 Clamping screw
		80 950 ...	80 950 ...	10 950 ...
Spare parts				
DC				
0.562 - 0.625	T05 - IP	057		M1,8x3,8 - 05IP 10100
0.656 - 0.703			T06 - IP 123	M2,0x4,3 - 06IP 10000
0.750 - 0.906			T06 - IP 123	M2,2x5,5 - 06IP 10700
0.937 - 1.000			T08 - IP 125	M2,5x6,3 - 08IP 10800
1.031 - 1.156			T08 - IP 125	M3,0x7,6 - 08IP 10200
1.187 - 1.437			T15 - IP 128	M3,5x7,5 - 15IP 10300
1.469 - 1.752			T20 - IP 129	M4,5x10 - 20IP 10400



Matching holders can be found in our Online-Shop at cuttingtools.ceratizit.com and in the metric clamping technology catalog



KUB Pentron – Indexable insert drill

Scope of supply:

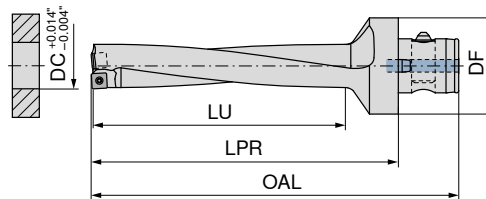
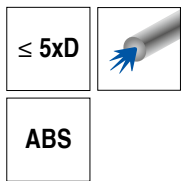
Indexable Insert Drill incl. clamping screws



Designation	KOMET no.	DC inch	DF inch	OAL inch	LU inch	LPR inch	Insert	torque moment Nm	10 875 ...	15 875 ...
KUB-P.5D.0562.R.04.ABS50-F	U45 51430	0.562	1.969	5.275	2.953	4.055	SOGX 040204	0,38		14395
KUB-P.5D.0593.R.04.ABS50-F	U45 51510	0.593	1.969	5.551	3.150	4.331	SOGX 040204	0,38		15195
KUB-P.5D.0625.R.04.ABS50-F	U45 51590	0.625	1.969	5.551	3.150	4.331	SOGX 040204	0,38		15995
KUB-P.5D.0656.R.05.ABS50-F	U45 51670	0.656	1.969	5.787	3.346	4.567	SOGX 050204	0,62		16795
KUB-P.5D.0687.R.05.ABS50	U45 51750	0.689	1.969	5.984	3.543	4.764	SOGX 050204	0,62	17595	
KUB-P.5D.0703.R.05.ABS50-F	U45 51790	0.703	1.969	5.984	3.543	4.764	SOGX 050204	0,62		17995
KUB-P.5D.0750.R.06.ABS50-F	U45 51910	0.750	1.969	6.417	3.937	5.197	SOGX 060206	1,01		19195
KUB-P.5D.0765.R.06.ABS50-F	U45 51940	0.765	1.969	6.417	3.937	5.197	SOGX 060206	1,01		19495
KUB-P.5D.0781.R.06.ABS50-F	U45 51980	0.781	1.969	6.417	3.937	5.197	SOGX 060206	1,01		19895
KUB-P.5D.0812.R.07.ABS50-F	U45 52060	0.812	1.969	6.614	4.134	5.394	SOGX 07T208	1,01		20695
KUB-P.5D.0828.R.07.ABS50	U45 52100	0.827	1.969	6.614	4.134	5.394	SOGX 07T208	1,01	21095	
KUB-P.5D.0875.R.07.ABS50-F	U45 52220	0.875	1.969	7.007	4.528	5.787	SOGX 07T208	1,01		22295
KUB-P.5D.0906.R.07.ABS50	U45 52300	0.906	1.969	7.008	4.528	5.787	SOGX 07T208	1,01	23095	
KUB-P.5D.0937.R.08.ABS50-F	U45 52380	0.937	1.969	7.204	4.724	5.984	SOGX 080308	1,28		23895
KUB-P.5D.0985.R.08.ABS50	U45 52500	0.984	1.969	7.441	4.921	6.220	SOGX 080308	1,28	25095	
KUB-P.5D.1000.R.08.ABS50-F	U45 52540	1.000	1.969	7.637	5.118	6.417	SOGX 080308	1,28		25495
KUB-P.5D.1031.R.09.ABS50-F	U45 52620	1.031	1.969	7.874	5.315	6.654	SOGX 09T308	2,25		26295
KUB-P.5D.1062.R.09.ABS50	U45 52700	1.063	1.969	7.874	5.315	6.654	SOGX 09T308	2,25	27095	
KUB-P.5D.1109.R.09.ABS50-F	U45 52820	1.109	1.969	8.307	5.709	7.087	SOGX 09T308	2,25		28295
KUB-P.5D.1125.R.09.ABS50-F	U45 52860	1.125	1.969	8.307	5.709	7.087	SOGX 09T308	2,25		28695
KUB-P.5D.1156.R.09.ABS50-F	U45 52940	1.156	1.969	8.503	5.906	7.283	SOGX 09T308	2,25		29495
KUB-P.5D.1187.R.10.ABS63-F	U45 63020	1.187	2.480	9.134	6.102	7.638	SOGX 100408	2,8		30196
KUB-P.5D.1218.R.10.ABS63-F	U45 63090	1.218	2.480	9.134	6.102	7.638	SOGX 100408	2,8		30996
KUB-P.5D.1250.R.10.ABS63-F	U45 63180	1.250	2.480	9.331	6.299	7.835	SOGX 100408	2,8		31896
KUB-P.5D.1281.R.10.ABS63	U45 63250	1.280	2.480	9.567	6.496	8.071	SOGX 100408	2,8	32596	
KUB-P.5D.1312.R.11.ABS63-F	U45 63330	1.312	2.480	9.764	6.693	8.268	SOGX 110408	2,8		33396
KUB-P.5D.1328.R.11.ABS63-F	U45 63370	1.328	2.480	9.764	6.693	8.268	SOGX 110408	2,8		33796
KUB-P.5D.1375.R.11.ABS63-F	U45 63490	1.375	2.480	10.000	6.890	8.504	SOGX 110408	2,8		34996
KUB-P.5D.1437.R.11.ABS63	U45 63650	1.437	2.480	10.433	7.283	8.937	SOGX 110408	2,8	36596	
KUB-P.5D.1469.R.12.ABS63-F	U45 63730	1.469	2.480	10.630	7.480	9.134	SOGX 120408	6,25		37396
KUB-P.5D.1500.R.12.ABS63-F	U45 63810	1.500	2.480	10.866	7.677	9.370	SOGX 120408	6,25		38196
KUB-P.5D.1562.R.12.ABS63-F	U45 63970	1.562	2.480	11.063	7.874	9.567	SOGX 120408	6,25		39796
KUB-P.5D.1625.R.12.ABS63-F	U45 64130	1.625	2.480	11.496	8.268	10.000	SOGX 120408	6,25		41396
KUB-P.5D.1656.R.13.ABS63-F	U45 64210	1.656	2.480	11.732	8.465	10.236	SOGX 130508	6,25		42196
KUB-P.5D.1687.R.13.ABS63-F	U45 64290	1.687	2.480	11.732	8.465	10.236	SOGX 130508	6,25		42896
KUB-P.5D.1750.R.13.ABS63	U45 64450	1.752	2.480	12.165	8.858	10.669	SOGX 130508	6,25	44596	

		 Key	 Screwdriver	 Clamping screw
		80 950 ...	80 950 ...	10 950 ...
Spare parts				
DC				
0.562 - 0.625	T05 - IP	057		M1,8x3,8 - 05IP 10100
0.656 - 0.703			T06 - IP 123	M2,0x4,3 - 06IP 10000
0.750 - 0.906			T06 - IP 123	M2,2x5,5 - 06IP 10700
0.984 - 1.000			T08 - IP 125	M2,5x6,3 - 08IP 10800
1.031 - 1.156			T08 - IP 125	M3,0x7,6 - 08IP 10200
1.187 - 1.437			T15 - IP 128	M3,5x7,5 - 15IP 10300
1.469 - 1.752			T20 - IP 129	M4,5x10 - 20IP 10400



Matching holders can be found in our Online-Shop at cuttingtools.ceratizit.com and in the metric clamping technology catalog

KUB Pentron – Indexable insert drill

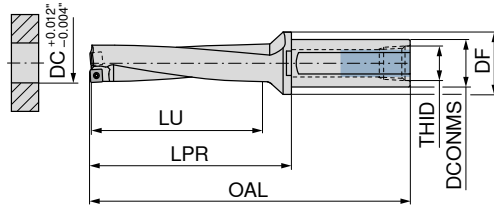
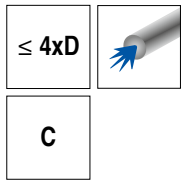

Scope of supply:

Indexable Insert Drill incl. clamping screws



15 874 ...

Designation	KOMET no.	DC inch	DCONMS inch	DF inch	OAL inch	LU inch	LPR inch	THID inch	Insert	torque moment Nm	
KUB-P.4D.0562.R.04.C0750-EF	U44 81430	0.562	0.750	1.180	5.163	2.362	2.913	1/8" NPT	SOGX 040204	0,38	14309
KUB-P.4D.0593.R.04.C0750-EF	U44 81510	0.593	0.750	1.180	5.400	2.520	3.150	1/8" NPT	SOGX 040204	0,38	15109
KUB-P.4D.0625.R.04.C0750-EF	U44 81590	0.625	0.750	1.180	5.400	2.520	3.150	1/8" NPT	SOGX 040204	0,38	15909
KUB-P.4D.0656.R.05.C0750-EF	U44 81670	0.656	0.750	1.180	5.596	2.677	3.346	1/8" NPT	SOGX 050204	0,62	16709
KUB-P.4D.0687.R.05.C1000-E	U44 81750	0.687	1.000	1.180	6.754	2.835	3.504	1/8" NPT	SOGX 050204	0,62	17500
KUB-P.4D.0703.R.05.C1000-EF	U44 81790	0.703	1.000	1.180	6.754	2.835	3.504	1/8" NPT	SOGX 050204	0,62	17900
KUB-P.4D.0750.R.06.C1000-EF	U44 81910	0.750	1.000	1.180	7.108	3.150	3.858	1/8" NPT	SOGX 060206	1,01	19100
KUB-P.4D.0765.R.06.C1000-EF	U44 81940	0.765	1.000	1.180	7.108	3.150	3.858	1/8" NPT	SOGX 060206	1,01	19400
KUB-P.4D.0781.R.06.C1000-EF	U44 81980	0.781	1.000	1.180	7.108	3.150	3.858	1/8" NPT	SOGX 060206	1,01	19800
KUB-P.4D.0812.R.07.C1000-EF	U44 82060	0.812	1.000	1.180	7.305	3.307	4.055	1/8" NPT	SOGX 07T208	1,01	20600
KUB-P.4D.0828.R.07.C1000-E	U44 82100	0.828	1.000	1.180	7.305	3.307	4.055	1/8" NPT	SOGX 07T208	1,01	21000
KUB-P.4D.0843.R.07.C1000-EF	U44 82140	0.843	1.000	1.180	7.974	3.465	4.724	1/8" NPT	SOGX 07T208	1,01	21400
KUB-P.4D.0875.R.07.C1000-EF	U44 82220	0.875	1.000	1.180	7.659	3.622	4.409	1/8" NPT	SOGX 07T208	1,01	22200
KUB-P.4D.0906.R.07.C1000-E	U44 82300	0.906	1.000	1.180	7.659	3.622	4.409	1/8" NPT	SOGX 07T208	1,01	23000
KUB-P.4D.0937.R.08.C1250-EF	U44 82380	0.937	1.250	1.540	7.817	3.780	4.567	1/8" NPT	SOGX 080308	1,28	23801
KUB-P.4D.0985.R.08.C1250-E	U44 82500	0.985	1.250	1.540	8.014	3.937	4.764	1/8" NPT	SOGX 080308	1,28	25001
KUB-P.4D.1000.R.08.C1250-EF	U44 82540	1.000	1.250	1.540	8.171	4.094	4.921	1/8" NPT	SOGX 080308	1,28	25401
KUB-P.4D.1031.R.09.C1250-EF	U44 82620	1.031	1.250	1.540	8.368	4.252	5.118	1/4" NPT	SOGX 09T308	2,25	26201
KUB-P.4D.1062.R.09.C1250-E	U44 82700	1.062	1.250	1.540	8.368	4.252	5.118	1/4" NPT	SOGX 09T308	2,25	27001
KUB-P.4D.1109.R.09.C1250-EF	U44 82820	1.109	1.250	1.540	8.722	4.567	5.472	1/4" NPT	SOGX 09T308	2,25	28201
KUB-P.4D.1125.R.09.C1250-E	U44 82860	1.125	1.250	1.540	8.722	4.567	5.472	1/4" NPT	SOGX 09T308	2,25	28601
KUB-P.4D.1156.R.09.C1250-EF	U44 82940	1.156	1.250	1.540	8.880	4.724	5.630	1/4" NPT	SOGX 09T308	2,25	29401
KUB-P.4D.1187.R.10.C1500-EF	U44 83020	1.187	1.500	1.970	9.577	4.882	5.827	1/4" NPT	SOGX 100408	2,8	30102
KUB-P.4D.1218.R.10.C1500-EF	U44 83090	1.218	1.500	1.970	9.577	4.882	5.827	1/4" NPT	SOGX 100408	2,8	30902
KUB-P.4D.1250.R.10.C1500-EF	U44 83180	1.250	1.500	1.970	9.734	5.039	5.984	1/4" NPT	SOGX 100408	2,8	31802
KUB-P.4D.1281.R.10.C1500-E	U44 83250	1.281	1.500	1.970	9.931	5.197	6.181	1/4" NPT	SOGX 100408	2,8	32502
KUB-P.4D.1312.R.11.C1500-EF	U44 83330	1.312	1.500	1.970	10.089	5.354	6.339	1/4" NPT	SOGX 110408	2,8	33302
KUB-P.4D.1328.R.11.C1500-EF	U44 83370	1.328	1.500	1.970	10.089	5.354	6.339	1/4" NPT	SOGX 110408	2,8	33702
KUB-P.4D.1375.R.11.C1500-EF	U44 83490	1.375	1.500	1.970	10.285	5.512	6.535	1/4" NPT	SOGX 110408	2,8	34902
KUB-P.4D.1437.R.11.C1500-E	U44 83650	1.437	1.500	1.970	10.640	5.827	6.890	1/4" NPT	SOGX 110408	2,8	36502
KUB-P.4D.1469.R.12.C1500-EF	U44 83730	1.469	1.500	1.970	10.797	5.984	7.047	1/4" NPT	SOGX 120408	6,25	37302
KUB-P.4D.1500.R.12.C1500-EF	U44 83810	1.500	1.500	1.970	10.994	6.142	7.244	1/4" NPT	SOGX 120408	6,25	38102
KUB-P.4D.1531.R.12.C1500-EF	U44 83890	1.531	1.500	1.970	10.994	6.142	7.244	1/4" NPT	SOGX 120408	6,25	38902
KUB-P.4D.1562.R.12.C1500-EF	U44 83970	1.562	1.500	1.970	11.152	6.299	7.402	1/4" NPT	SOGX 120408	6,25	39702
KUB-P.4D.1625.R.12.C1500-EF	U44 84130	1.625	1.500	1.970	11.506	6.614	7.756	1/4" NPT	SOGX 120408	6,25	41302
KUB-P.4D.1656.R.13.C1500-EF	U44 84210	1.656	1.500	1.970	11.703	6.772	7.953	1/4" NPT	SOGX 130508	6,25	42102
KUB-P.4D.1687.R.13.C1500-EF	U44 84290	1.687	1.500	1.970	11.703	6.772	7.953	1/4" NPT	SOGX 130508	6,25	42802
KUB-P.4D.1750.R.13.C1500-EF	U44 84450	1.750	1.500	1.970	12.057	7.087	8.307	1/4" NPT	SOGX 130508	6,25	44502

		 Key	 Screwdriver	 Clamping screw
		80 950 ...	80 950 ...	10 950 ...
Spare parts				
DC				
0.562 - 0.625	T05 - IP	057		M1,8x3,8 - 05IP 10100
0.656 - 0.703			T06 - IP 123	M2,0x4,3 - 06IP 10000
0.750 - 0.906			T06 - IP 123	M2,2x5,5 - 06IP 10700
0.937 - 1.000			T08 - IP 125	M2,5x6,3 - 08IP 10800
1.031 - 1.156			T08 - IP 125	M3,0x7,6 - 08IP 10200
1.187 - 1.437			T15 - IP 128	M3,5x7,5 - 15IP 10300
1.469 - 1.750			T20 - IP 129	M4,5x10 - 20IP 10400



Matching holders can be found in our Online-Shop at cuttingtools.ceratizit.com and in the metric clamping technology catalog

KUB Pentron – Indexable insert drill

Scope of supply:

Indexable Insert Drill incl. clamping screws

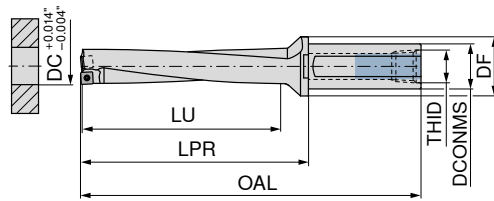
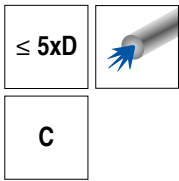

15 875 ...

Designation	KOMET no.	DC inch	DCONMS inch	DF inch	OAL inch	LU inch	LPR inch	THID inch	Insert	torque moment Nm	
KUB-P.5D.0562.R.04.C0750-EF	U45 81430	0.562	0.750	1.180	5.754	2.953	3.504	1/8" NPT	SOGX 040204	0,38	14309
KUB-P.5D.0593.R.04.C0750-EF	U45 81510	0.593	0.750	1.180	6.030	3.150	3.780	1/8" NPT	SOGX 040204	0,38	15109
KUB-P.5D.0625.R.04.C0750-EF	U45 81590	0.625	0.750	1.180	6.030	3.150	3.780	1/8" NPT	SOGX 040204	0,38	15909
KUB-P.5D.0656.R.05.C0750-EF	U45 81670	0.656	0.750	1.180	6.266	3.346	4.016	1/8" NPT	SOGX 050204	0,62	16709
KUB-P.5D.0687.R.05.C1000-E	U45 81750	0.687	1.000	1.180	7.463	3.543	4.213	1/8" NPT	SOGX 050204	0,62	17500
KUB-P.5D.0703.R.05.C1000-EF	U45 81790	0.703	1.000	1.180	7.463	3.543	4.213	1/8" NPT	SOGX 050204	0,62	17900
KUB-P.5D.0750.R.06.C1000-EF	U45 81910	0.750	1.000	1.180	7.896	3.937	4.646	1/8" NPT	SOGX 060206	1,01	19100
KUB-P.5D.0765.R.06.C1000-EF	U45 81940	0.765	1.000	1.180	7.896	3.937	4.646	1/8" NPT	SOGX 060206	1,01	19400
KUB-P.5D.0781.R.06.C1000-EF	U45 81980	0.781	1.000	1.180	7.896	3.937	4.646	1/8" NPT	SOGX 060206	1,01	19800
KUB-P.5D.0812.R.07.C1000-EF	U45 82060	0.812	1.000	1.180	8.132	4.134	4.882	1/8" NPT	SOGX 07T208	1,01	20600
KUB-P.5D.0828.R.07.C1000-E	U45 82100	0.828	1.000	1.180	8.132	4.134	4.882	1/8" NPT	SOGX 07T208	1,01	21000
KUB-P.5D.0843.R.07.C1000-EF	U45 82140	0.843	1.000	1.180	8.329	4.331	5.079	1/8" NPT	SOGX 07T208	1,01	21400
KUB-P.5D.0875.R.07.C1000-EF	U45 82220	0.875	1.000	1.180	8.565	4.528	5.315	1/8" NPT	SOGX 07T208	1,01	22200
KUB-P.5D.0906.R.07.C1000-E	U45 82300	0.906	1.000	1.180	8.565	4.528	5.315	1/8" NPT	SOGX 07T208	1,01	23000
KUB-P.5D.0937.R.08.C1250-EF	U45 82380	0.937	1.250	1.540	8.762	4.724	5.512	1/8" NPT	SOGX 080308	1,28	23801
KUB-P.5D.0985.R.08.C1250-E	U45 82500	0.985	1.250	1.540	8.998	4.921	5.748	1/8" NPT	SOGX 080308	1,28	25001
KUB-P.5D.1000.R.08.C1250-EF	U45 82540	1.000	1.250	1.540	9.195	5.118	5.945	1/8" NPT	SOGX 080308	1,28	25401
KUB-P.5D.1031.R.09.C1250-EF	U45 82620	1.031	1.250	1.540	9.431	5.315	6.181	1/4" NPT	SOGX 09T308	2,25	26201
KUB-P.5D.1062.R.09.C1250-E	U45 82700	1.062	1.250	1.540	9.431	5.315	6.181	1/4" NPT	SOGX 09T308	2,25	27001
KUB-P.5D.1109.R.09.C1250-EF	U45 82820	1.109	1.250	1.540	9.864	5.709	6.614	1/4" NPT	SOGX 09T308	2,25	28201
KUB-P.5D.1125.R.09.C1250-EF	U45 82860	1.125	1.250	1.540	9.864	5.709	6.614	1/4" NPT	SOGX 09T308	2,25	28601
KUB-P.5D.1156.R.09.C1250-EF	U45 82940	1.156	1.250	1.540	10.061	5.906	6.811	1/4" NPT	SOGX 09T308	2,25	29401
KUB-P.5D.1187.R.10.C1500-EF	U45 83020	1.187	1.500	1.970	10.797	6.102	7.047	1/4" NPT	SOGX 100408	2,8	30102
KUB-P.5D.1218.R.10.C1500-EF	U45 83090	1.218	1.500	1.970	10.797	6.102	7.047	1/4" NPT	SOGX 100408	2,8	30902
KUB-P.5D.1250.R.10.C1500-EF	U45 83180	1.250	1.500	1.970	10.994	6.299	7.244	1/4" NPT	SOGX 100408	2,8	31802
KUB-P.5D.1281.R.10.C1500-E	U45 83250	1.281	1.500	1.970	11.230	6.496	7.480	1/4" NPT	SOGX 100408	2,8	32502
KUB-P.5D.1312.R.11.C1500-EF	U45 83330	1.312	1.500	1.970	11.427	6.693	7.677	1/4" NPT	SOGX 110408	2,8	33302
KUB-P.5D.1328.R.11.C1500-EF	U45 83370	1.328	1.500	1.970	11.427	6.693	7.677	1/4" NPT	SOGX 110408	2,8	33702
KUB-P.5D.1375.R.11.C1500-EF	U45 83490	1.375	1.500	1.970	11.663	6.890	7.913	1/4" NPT	SOGX 110408	2,8	34902
KUB-P.5D.1437.R.11.C1500-E	U45 83650	1.437	1.500	1.970	12.096	7.283	8.346	1/4" NPT	SOGX 110408	6,25	36502
KUB-P.5D.1469.R.12.C1500-EF	U45 83730	1.469	1.500	1.970	12.293	7.480	8.543	1/4" NPT	SOGX 120408	6,25	37302
KUB-P.5D.1500.R.12.C1500-EF	U45 83810	1.500	1.500	1.970	12.530	7.677	8.780	1/4" NPT	SOGX 120408	6,25	38102
KUB-P.5D.1531.R.12.C1500-EF	U45 83890	1.531	1.500	1.970	12.530	7.677	8.780	1/4" NPT	SOGX 120408	6,25	38902
KUB-P.5D.1562.R.12.C1500-EF	U45 83970	1.562	1.500	1.970	12.726	7.874	8.976	1/4" NPT	SOGX 120408	6,25	39702
KUB-P.5D.1625.R.12.C1500-EF	U45 84130	1.625	1.500	1.970	13.159	8.268	9.409	1/4" NPT	SOGX 120408	6,25	41302
KUB-P.5D.1656.R.13.C1500-EF	U45 84210	1.656	1.500	1.970	13.396	8.465	9.646	1/4" NPT	SOGX 130508	6,25	42102
KUB-P.5D.1687.R.13.C1500-EF	U45 84290	1.687	1.500	1.970	13.396	8.465	9.646	1/4" NPT	SOGX 130508	6,25	42802
KUB-P.5D.1750.R.13.C1500-EF	U45 84450	1.750	1.500	1.970	13.829	8.858	10.079	1/4" NPT	SOGX 130508	6,25	44502

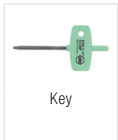
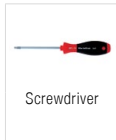
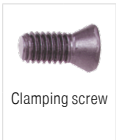
		 Key	 Screwdriver	 Clamping screw
		80 950 ...	80 950 ...	10 950 ...
Spare parts				
DC				
0.562 - 0.625	T05 - IP	057		M1,8x3,8 - 05IP 10100
0.656 - 0.703			T06 - IP 123	M2,0x4,3 - 06IP 10000
0.750 - 0.906			T06 - IP 123	M2,2x5,5 - 06IP 10700
0.937 - 1.000			T08 - IP 125	M2,5x6,3 - 08IP 10800
1.031 - 1.156			T08 - IP 125	M3,0x7,6 - 08IP 10200
1.187 - 1.437			T15 - IP 128	M3,5x7,5 - 15IP 10300
1.469 - 1.750			T20 - IP 129	M4,5x10 - 20IP 10400





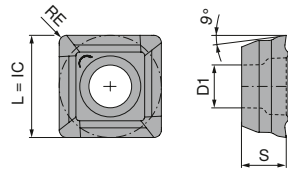

Matching holders can be found in our Online-Shop at cuttingtools.ceratizit.com and in the metric clamping technology catalog

SOGX

Designation	L inch	IC inch	D1 inch	S inch
SOGX 0402..	0.188	0.188	0.080	0.086
SOGX 0502..	0.216	0.216	0.090	0.094
SOGX 0602..	0.244	0.244	0.102	0.108
SOGX 07T2..	0.279	0.279	0.102	0.116
SOGX 0803..	0.314	0.314	0.112	0.133
SOGX 09T3..	0.350	0.350	0.133	0.153
SOGX 1004..	0.385	0.385	0.161	0.165
SOGX 1104..	0.429	0.429	0.161	0.177
SOGX 1204..	0.472	0.472	0.204	0.188
SOGX 1305..	0.519	0.519	0.204	0.204

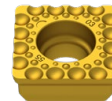

SOGX

	NEW	NEW	NEW	
-01 BK8425	-03 BK8430	-13 BK8425	-32 BK8425	-34 BK8425
				
SOGX	SOGX	SOGX	SOGX	SOGX
10 820 ...	10 820 ...	10 820 ...	10 820 ...	10 820 ...

ISO	KOMET no.	RE inch	10 820 ...	10 820 ...	10 820 ...	10 820 ...	10 820 ...
040204	W80 10010.048425	0.016	30401				
040204	W80 10030.048430	0.016		00403			
040204	W80 10130.048425	0.016			30413		
040204	W80 10320.048425	0.016				30432	
040204	W80 10340.048425	0.016					30434
050204	W80 12010.048425	0.016	30501				
050204	W80 12030.048430	0.016		00503			
050204	W80 12130.048425	0.016			30513		
050204	W80 12320.048425	0.016				30532	
050204	W80 12340.048425	0.016					30534
060206	W80 18010.068425	0.024	30601				
060206	W80 18030.068430	0.024		00603			
060206	W80 18130.068425	0.024			30613		
060206	W80 18320.068425	0.024				30632	
060206	W80 18340.068425	0.024					30634
07T208	W80 20010.088425	0.031	30701				
07T208	W80 20030.088430	0.031		00703			
07T208	W80 20130.088425	0.031			30713		
07T208	W80 20320.088425	0.031				30732	
07T208	W80 20340.088425	0.031					30734
080308	W80 24010.088425	0.031	30801				
080308	W80 24030.088430	0.031		00803			
080308	W80 24130.088425	0.031			30813		
080308	W80 24320.088425	0.031				30832	
080308	W80 24340.088425	0.031					30834
09T308	W80 28010.088425	0.031	30901				
09T308	W80 28030.088430	0.031		00903			
09T308	W80 28130.088425	0.031			30913		
09T308	W80 28320.088425	0.031				30932	
09T308	W80 28340.088425	0.031					30934
100408	W80 32010.088425	0.031	31001				
100408	W80 32030.088430	0.031		01003			
100408	W80 32130.088425	0.031			31013		
100408	W80 32320.088425	0.031				31032	
100408	W80 32340.088425	0.031					31034
110408	W80 38010.088425	0.031	31101				
110408	W80 38030.088430	0.031		01103			
110408	W80 38130.088425	0.031			31113		
110408	W80 38320.088425	0.031				31132	
110408	W80 38340.088425	0.031					31134
120408	W80 42010.088425	0.031	31201				
120408	W80 42030.088430	0.031		01203			
120408	W80 42130.088425	0.031			31213		
120408	W80 42320.088425	0.031				31232	
120408	W80 42340.088425	0.031					31234
130508	W80 46010.088425	0.031	31301				
130508	W80 46030.088430	0.031		01303			
130508	W80 46130.088425	0.031			31313		
130508	W80 46320.088425	0.031				31332	
130508	W80 46340.088425	0.031					31334

P	●	●	●	●	○
M	●	●	●	●	
K	●	●	●	●	●
N	○	○	○	○	
S	●	●	●	●	
H	○	○	○	○	
O					

SOGX

Designation	L inch	IC inch	D1 inch	S inch
SOGX 0402..	0.188	0.188	0.080	0.086
SOGX 0502..	0.216	0.216	0.090	0.094
SOGX 0602..	0.244	0.244	0.102	0.108
SOGX 07T2..	0.279	0.279	0.102	0.116
SOGX 0803..	0.314	0.314	0.112	0.133
SOGX 09T3..	0.350	0.350	0.133	0.153
SOGX 1004..	0.385	0.385	0.161	0.165
SOGX 1104..	0.429	0.429	0.161	0.177
SOGX 1204..	0.472	0.472	0.204	0.188
SOGX 1305..	0.519	0.519	0.204	0.204

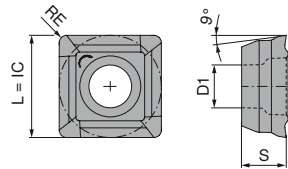

SOGX

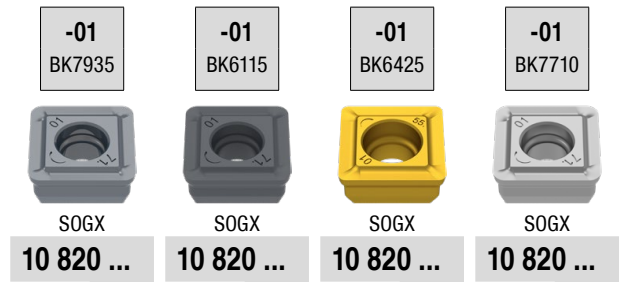

ISO	KOMET no.	RE inch	10 820 ...	10 820 ...	10 820 ...	10 820 ...
040204	W80 10010.046115	0.016		40401		
040204	W80 10010.046425	0.016			60401	
040204	W80 10010.047710	0.016				90401
040204	W80 10010.047935	0.016	50401			
050204	W80 12010.046115	0.016		40501		
050204	W80 12010.046425	0.016			60501	
050204	W80 12010.047710	0.016				90501
050204	W80 12010.047935	0.016	50501			
060206	W80 18010.066115	0.024		40601		
060206	W80 18010.066425	0.024			60601	
060206	W80 18010.067710	0.024				90601
060206	W80 18010.067935	0.024	50601			
07T208	W80 20010.086115	0.031		40701		
07T208	W80 20010.086425	0.031			60701	
07T208	W80 20010.087710	0.031				90701
07T208	W80 20010.087935	0.031	50701			
080308	W80 24010.086115	0.031		40801		
080308	W80 24010.086425	0.031			60801	
080308	W80 24010.087710	0.031				90801
080308	W80 24010.087935	0.031	50801			
09T308	W80 28010.086115	0.031		40901		
09T308	W80 28010.086425	0.031			60901	
09T308	W80 28010.087710	0.031				90901
09T308	W80 28010.087935	0.031	50901			
100408	W80 32010.086115	0.031		41001		
100408	W80 32010.086425	0.031			61001	
100408	W80 32010.087710	0.031				91001
100408	W80 32010.087935	0.031	51001			
110408	W80 38010.086115	0.031		41101		
110408	W80 38010.086425	0.031			61101	
110408	W80 38010.087710	0.031				91101
110408	W80 38010.087935	0.031	51101			
120408	W80 42010.086115	0.031		41201		
120408	W80 42010.086425	0.031			61201	
120408	W80 42010.087710	0.031				91201
120408	W80 42010.087935	0.031	51201			
130508	W80 46010.086115	0.031		41301		
130508	W80 46010.086425	0.031			61301	
130508	W80 46010.087710	0.031				91301
130508	W80 46010.087935	0.031	51301			
P			●	●	●	
M			●	●	●	
K			●	●	●	
N			○			●
S			●			○
H				○		
O			○			○

→ v_c Page 43-45

BK6115-01 is exclusively recommended for use on the peripheral cutting edge!

KUB Quatron – Indexable insert drill

Scope of supply:

Indexable Insert Drill incl. clamping screws

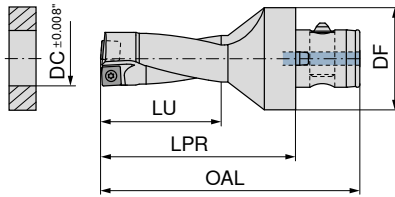
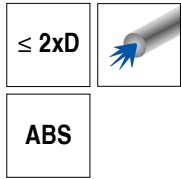

Designation	KOMET no.	DC inch	DF inch	OAL inch	LU inch	LPR inch	Insert	torque moment Nm	10 879 ...	15 879 ...
KUB-Q.2D.0562.R.05.ABS50-F	U10 71432	0.562	1.969	3.779	1.181	2.559	SOEX 050204	0,62		14395
KUB-Q.2D.0593.R.05.ABS50-F	U10 71510	0.593	1.969	3.858	1.260	2.638	SOEX 050204	0,62		15195
KUB-Q.2D.0625.R.05.ABS50-F	U10 71590	0.625	1.969	3.858	1.260	2.638	SOEX 050204	0,62		15995
KUB-Q.2D.0656.R.05.ABS50-F	U10 71670	0.656	1.969	3.937	1.339	2.717	SOEX 050204	0,62		16795
KUB-Q.2D.0687.R.05.ABS50	U10 71750	0.689	1.969	4.016	1.417	2.795	SOEX 050204	0,62	17595	
KUB-Q.2D.0703.R.06.ABS50-F	U10 71790	0.703	1.969	4.015	1.417	2.795	SOEX 060306	1,01		17995
KUB-Q.2D.0718.R.06.ABS50-F	U10 71820	0.718	1.969	4.094	1.496	2.874	SOEX 060306	1,01		18295
KUB-Q.2D.0750.R.06.ABS50-F	U10 71910	0.750	1.969	4.173	1.575	2.953	SOEX 060306	1,01		19195
KUB-Q.2D.0765.R.06.ABS50-F	U10 71940	0.765	1.969	4.173	1.575	2.953	SOEX 060306	1,01		19495
KUB-Q.2D.0781.R.06.ABS50-F	U10 71980	0.781	1.969	4.173	1.575	2.953	SOEX 060306	1,01		19895
KUB-Q.2D.0812.R.06.ABS50-F	U10 72060	0.812	1.969	4.251	1.654	3.031	SOEX 060306	1,01		20695
KUB-Q.2D.0828.R.06.ABS50	U10 72100	0.827	1.969	4.252	1.654	3.032	SOEX 060306	1,01	21095	
KUB-Q.2D.0843.R.06.ABS50-F	U10 72140	0.843	1.969	4.330	1.732	3.110	SOEX 060306	1,01		21495
KUB-Q.2D.0875.R.07.ABS50-F	U10 72220	0.875	1.969	4.409	1.811	3.189	SOEX 07T308	1,01		22295
KUB-Q.2D.0906.R.07.ABS50	U10 72300	0.906	1.969	4.409	1.811	3.189	SOEX 07T308	1,01	23095	
KUB-Q.2D.0937.R.07.ABS50-F	U10 72380	0.937	1.969	4.488	1.890	3.268	SOEX 07T308	1,01		23895
KUB-Q.2D.0968.R.07.ABS50-F	U10 72460	0.968	1.969	4.566	1.969	3.346	SOEX 07T308	1,01		24695
KUB-Q.2D.0985.R.07.ABS50	U10 72500	0.984	1.969	4.567	1.969	3.346	SOEX 07T308	1,01	25095	
KUB-Q.2D.1000.R.07.ABS50-F	U10 72540	1.000	1.969	4.645	2.047	3.425	SOEX 07T308	1,01		25495
KUB-Q.2D.1031.R.07.ABS50-F	U10 72620	1.031	1.969	4.724	2.126	3.504	SOEX 07T308	1,01		26295
KUB-Q.2D.1062.R.07.ABS50	U10 72700	1.063	1.969	4.724	2.126	3.504	SOEX 07T308	1,01	27095	
KUB-Q.2D.1109.R.09.ABS50-F	U10 72820	1.109	1.969	4.881	2.283	3.661	SOEX 090408	2,25		28295
KUB-Q.2D.1125.R.09.ABS50-F	U10 72860	1.125	1.969	4.881	2.283	3.661	SOEX 090408	2,25		28695
KUB-Q.2D.1156.R.09.ABS50-F	U10 72940	1.156	1.969	4.960	2.323	3.740	SOEX 090408	2,25		29495
KUB-Q.2D.1187.R.09.ABS50-F	U10 73020	1.187	1.969	5.235	2.441	4.015	SOEX 090408	2,25		30195
KUB-Q.2D.1218.R.09.ABS50-F	U10 73090	1.218	1.969	5.236	2.441	4.016	SOEX 090408	2,25		30995
KUB-Q.2D.1250.R.09.ABS50-F	U10 73180	1.250	1.969	4.314	2.520	3.094	SOEX 090408	2,25		31895
KUB-Q.2D.1281.R.09.ABS50-F	U10 73250	1.281	1.969	5.393	2.598	4.173	SOEX 090408	2,25		32595
KUB-Q.2D.1312.R.12.ABS50-F	U10 73330	1.312	1.969	5.471	2.677	4.251	SOEX 120508	6,25		33395
KUB-Q.2D.1328.R.12.ABS50-F	U10 73370	1.328	1.969	5.471	2.677	4.251	SOEX 120508	6,25		33795
KUB-Q.2D.1375.R.12.ABS50-F	U10 73490	1.375	1.969	5.550	2.756	4.330	SOEX 120508	6,25		34995
KUB-Q.2D.1406.R.12.ABS50-F	U10 73570	1.406	1.969	5.629	2.835	4.409	SOEX 120508	6,25		35795
KUB-Q.2D.1437.R.12.ABS50-F	U10 73650	1.437	1.969	6.101	2.913	4.881	SOEX 120508	6,25		36595
KUB-Q.2D.1469.R.12.ABS50-F	U10 73730	1.469	1.969	6.180	2.992	4.960	SOEX 120508	6,25		37395
KUB-Q.2D.1500.R.12.ABS50-F	U10 73810	1.500	1.969	6.259	3.071	5.039	SOEX 120508	6,25		38195
KUB-Q.2D.1531.R.12.ABS50-F	U10 73890	1.531	1.969	6.259	3.071	5.039	SOEX 120508	6,25		38995
KUB-Q.2D.1562.R.12.ABS50-F	U10 73970	1.562	1.969	6.338	3.150	5.118	SOEX 120508	6,25		39795
KUB-Q.2D.1625.R.12.ABS50-F	U10 74130	1.625	1.969	6.495	3.307	5.275	SOEX 120508	6,25		41395
KUB-Q.2D.1656.R.12.ABS50-F	U10 74210	1.656	1.969	6.574	3.386	5.354	SOEX 120508	6,25		42195
KUB-Q.2D.1687.R.12.ABS50-F	U10 74290	1.687	1.969	6.574	3.386	5.354	SOEX 120508	6,25		42895
KUB-Q.2D.1750.R.12.ABS50-F	U10 74450	1.750	1.969	6.653	3.465	5.433	SOEX 120508	6,25		44595

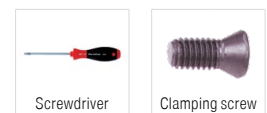

80 950 ... 10 950 ...

Spare parts

DC	123	10000
0.562 - 0.689	123	10700
0.703 - 0.843	125	10800
0.875 - 1.063	128	10300
1.109 - 1.281	129	10400
1.312 - 1.750		

KUB Quatron – Indexable insert drill

Scope of supply:

Indexable Insert Drill incl. clamping screws

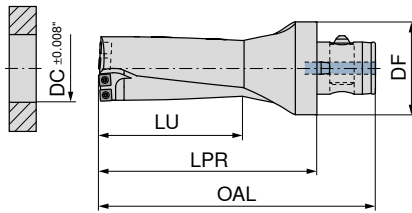
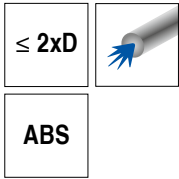

Designation	KOMET no.	DC inch	DF inch	OAL inch	LU inch	LPR inch	Insert	torque moment Nm	10 879 ...	15 879 ...
KUB-Q.2D.1781.R.07.ABS63-F	U10 84520	1.781	2.480	7.283	3.622	5.787	SOEX 07T308	1,01		45296
KUB-Q.2D.1812.R.07.ABS63	U10 84600	1.811	2.480	7.283	3.622	5.787	SOEX 07T308	1,01	46096	47696
KUB-Q.2D.1875.R.07.ABS63-F	U10 84760	1.875	2.480	7.441	3.780	5.945	SOEX 07T308	1,01		49296
KUB-Q.2D.1937.R.07.ABS63-F	U10 84920	1.937	2.480	7.598	3.937	6.102	SOEX 07T308	1,01		50296
KUB-Q.2D.1975.R.07.ABS63-F	U10 85020	1.975	2.480	7.677	4.016	6.181	SOEX 07T308	1,01		50896
KUB-Q.2D.2000.R.07.ABS63-F	U10 85080	2.000	2.480	7.677	4.016	6.181	SOEX 07T308	1,01		52496
KUB-Q.2D.2062.R.09.ABS63-F	U10 85240	2.062	2.480	7.835	4.173	6.339	SOEX 090408	2,25		57298
KUB-Q.2D.2125.R.09.ABS63	U10 85400	2.126	2.480	7.913	4.252	6.417	SOEX 090408	2,25	54096	57998
KUB-Q.2D.2165.R.09.ABS80	U10 95500	2.165	3.150	8.189	4.331	6.496	SOEX 090408	2,25	55098	60398
KUB-Q.2D.2203.R.09.ABS80	U10 95600	2.205	3.150	8.268	4.409	6.575	SOEX 090408	2,25	56098	61998
KUB-Q.2D.2250.R.09.ABS80-F	U10 95720	2.250	3.150	8.425	4.567	6.732	SOEX 090408	2,25		63598
KUB-Q.2D.2281.R.09.ABS80-F	U10 95790	2.281	3.150	8.425	4.567	6.732	SOEX 090408	2,25		
KUB-Q.2D.2375.R.09.ABS80-F	U10 96030	2.375	3.150	8.662	4.803	6.969	SOEX 090408	2,25		
KUB-Q.2D.2437.R.09.ABS80-F	U10 96190	2.437	3.150	8.740	4.882	7.047	SOEX 090408	2,25		
KUB-Q.2D.2500.R.09.ABS80-F	U10 96350	2.500	3.150	8.898	5.039	7.205	SOEX 090408	2,25		

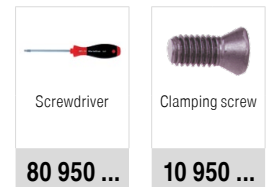

Spare parts
DC

DC	80 950 ...	10 950 ...
1.781 - 2.000	125	10800
2.062 - 2.500	128	10300

KUB Quatron – Indexable insert drill

Scope of supply:

Indexable Insert Drill incl. clamping screws

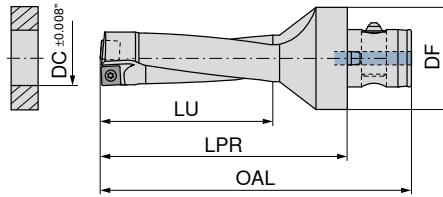
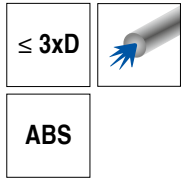

Designation	KOMET no.	DC inch	DF inch	OAL inch	LU inch	LPR inch	Insert	torque moment Nm	10 880 ...	15 880 ...
KUB-Q.3D.0562.R.05.ABS50-F	U11 51432	0.562	1.969	4.370	1.772	3.150	SOEX 050204	0,62		14395
KUB-Q.3D.0593.R.05.ABS50-F	U11 51510	0.593	1.969	4.488	1.890	3.268	SOEX 050204	0,62		15195
KUB-Q.3D.0625.R.05.ABS50-F	U11 51590	0.625	1.969	4.488	1.890	3.268	SOEX 050204	0,62		15995
KUB-Q.3D.0656.R.05.ABS50-F	U11 51670	0.656	1.969	4.606	2.008	3.386	SOEX 050204	0,62		16795
KUB-Q.3D.0687.R.05.ABS50	U11 51750	0.689	1.969	4.724	2.126	3.504	SOEX 050204	0,62	17595	
KUB-Q.3D.0703.R.06.ABS50-F	U11 51790	0.703	1.969	4.724	2.126	3.504	SOEX 060306	1,01		17995
KUB-Q.3D.0718.R.06.ABS50-F	U11 51820	0.718	1.969	4.842	2.244	3.622	SOEX 060306	1,01		18295
KUB-Q.3D.0750.R.06.ABS50-F	U11 51910	0.750	1.969	4.960	2.362	3.740	SOEX 060306	1,01		19195
KUB-Q.3D.0765.R.06.ABS50-F	U11 51940	0.765	1.969	4.960	2.362	3.740	SOEX 060306	1,01		19495
KUB-Q.3D.0781.R.06.ABS50-F	U11 51980	0.781	1.969	4.960	2.362	3.740	SOEX 060306	1,01		19895
KUB-Q.3D.0812.R.06.ABS50-F	U11 52060	0.812	1.969	5.078	2.480	3.858	SOEX 060306	1,01		20695
KUB-Q.3D.0828.R.06.ABS50	U11 52100	0.827	1.969	5.079	2.480	3.858	SOEX 060306	1,01	21095	
KUB-Q.3D.0843.R.06.ABS50-F	U11 52140	0.843	1.969	5.196	2.598	3.976	SOEX 060306	1,01		21495
KUB-Q.3D.0875.R.07.ABS50-F	U11 52220	0.875	1.969	5.314	2.717	4.094	SOEX 07T308	1,01		22295
KUB-Q.3D.0906.R.07.ABS50	U11 52300	0.906	1.969	5.315	2.717	4.094	SOEX 07T308	1,01	23095	
KUB-Q.3D.0937.R.07.ABS50-F	U11 52380	0.937	1.969	5.433	2.835	4.213	SOEX 07T308	1,01		23895
KUB-Q.3D.0968.R.07.ABS50-F	U11 52460	0.968	1.969	5.551	2.953	4.331	SOEX 07T308	1,01		24695
KUB-Q.3D.0985.R.07.ABS50	U11 52500	0.984	1.969	5.551	2.953	4.331	SOEX 07T308	1,01	25095	
KUB-Q.3D.1000.R.07.ABS50-F	U11 52540	1.000	1.969	5.669	3.071	4.449	SOEX 07T308	1,01		25495
KUB-Q.3D.1031.R.07.ABS50-F	U11 52620	1.031	1.969	5.787	3.189	4.567	SOEX 07T308	1,01		26295
KUB-Q.3D.1062.R.07.ABS50	U11 52700	1.063	1.969	5.787	3.189	4.567	SOEX 07T308	1,01	27095	
KUB-Q.3D.1109.R.09.ABS50-F	U11 52820	1.109	1.969	6.023	3.425	4.803	SOEX 090408	2,25		28295
KUB-Q.3D.1125.R.09.ABS50-F	U11 52860	1.125	1.969	6.023	3.425	4.803	SOEX 090408	2,25		28695
KUB-Q.3D.1156.R.09.ABS50-F	U11 52940	1.156	1.969	6.141	3.543	4.921	SOEX 090408	2,25		29495
KUB-Q.3D.1187.R.09.ABS50-F	U11 53020	1.187	1.969	6.456	3.661	5.236	SOEX 090408	2,25		30195
KUB-Q.3D.1218.R.09.ABS50-F	U11 53090	1.218	1.969	6.456	3.661	5.236	SOEX 090408	2,25		30995
KUB-Q.3D.1250.R.09.ABS50-F	U11 53180	1.250	1.969	6.574	3.780	5.354	SOEX 090408	2,25		31895
KUB-Q.3D.1281.R.09.ABS50-F	U11 53250	1.281	1.969	6.692	3.898	5.472	SOEX 090408	2,25		32595
KUB-Q.3D.1312.R.12.ABS50-F	U11 53330	1.312	1.969	6.811	4.016	5.591	SOEX 120508	6,25		33395
KUB-Q.3D.1328.R.12.ABS50-F	U11 53370	1.328	1.969	6.811	4.016	5.591	SOEX 120508	6,25		33795
KUB-Q.3D.1375.R.12.ABS50-F	U11 53490	1.375	1.969	6.929	4.134	5.709	SOEX 120508	6,25		34995
KUB-Q.3D.1406.R.12.ABS50-F	U11 53570	1.406	1.969	7.047	4.252	5.827	SOEX 120508	6,25		35795
KUB-Q.3D.1437.R.12.ABS50-F	U11 53650	1.437	1.969	7.559	4.370	6.339	SOEX 120508	6,25		36595
KUB-Q.3D.1469.R.12.ABS50-F	U11 53730	1.469	1.969	7.677	4.488	6.457	SOEX 120508	6,25		37395
KUB-Q.3D.1500.R.12.ABS50-F	U11 53810	1.500	1.969	7.795	4.606	6.575	SOEX 120508	6,25		38195
KUB-Q.3D.1531.R.12.ABS50-F	U11 53890	1.531	1.969	7.795	4.606	6.575	SOEX 120508	6,25		38995
KUB-Q.3D.1562.R.12.ABS50-F	U11 53970	1.562	1.969	7.913	4.724	6.693	SOEX 120508	6,25		39795
KUB-Q.3D.1625.R.12.ABS50-F	U11 54130	1.625	1.969	8.149	4.961	6.929	SOEX 120508	6,25		41395
KUB-Q.3D.1656.R.12.ABS50-F	U11 54210	1.656	1.969	8.267	5.079	7.047	SOEX 120508	6,25		42195
KUB-Q.3D.1687.R.12.ABS50-F	U11 54290	1.687	1.969	8.267	5.079	7.047	SOEX 120508	6,25		42895
KUB-Q.3D.1750.R.12.ABS50-F	U11 54450	1.750	1.969	8.385	5.197	7.165	SOEX 120508	6,25		44595

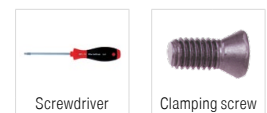

80 950 ... 10 950 ...

Spare parts

DC	123	10000
0.562 - 0.689	123	10700
0.703 - 0.843	125	10800
0.875 - 1.063	128	10300
1.109 - 1.281	129	10400
1.312 - 1.750		

KUB Quatron – Indexable insert drill

Scope of supply:

Indexable Insert Drill incl. clamping screws

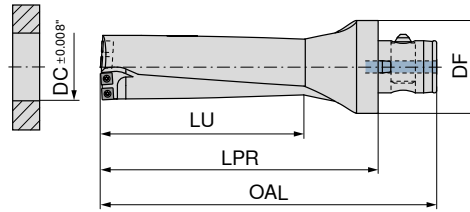
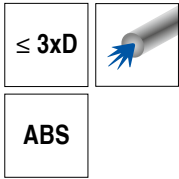

Designation	KOMET no.	DC inch	DF inch	OAL inch	LU inch	LPR inch	Insert	torque moment Nm	10 880 ...	15 880 ...
KUB-Q.3D.1781.R.07.ABS63-F	U12 34520	1.781	2.480	9.094	5.433	7.598	SOEX 07T308	1,01		45296
KUB-Q.3D.1812.R.07.ABS63	U12 34600	1.811	2.480	9.094	5.433	7.598	SOEX 07T308	1,01	46096	
KUB-Q.3D.1875.R.07.ABS63-F	U12 34760	1.875	2.480	9.331	5.669	7.835	SOEX 07T308	1,01		47696
KUB-Q.3D.1937.R.07.ABS63-F	U12 34920	1.937	2.480	9.567	5.906	8.071	SOEX 07T308	1,01		49296
KUB-Q.3D.1975.R.07.ABS63-F	U12 35020	1.975	2.480	9.685	6.024	8.189	SOEX 07T308	1,01		50296
KUB-Q.3D.2000.R.07.ABS63-F	U12 35080	2.000	2.480	9.685	6.024	8.189	SOEX 07T308	1,01		50896
KUB-Q.3D.2062.R.09.ABS63-F	U12 35240	2.062	2.480	9.921	6.260	8.425	SOEX 090408	2,25		52496
KUB-Q.3D.2125.R.09.ABS63	U12 35400	2.126	2.480	10.039	6.378	8.543	SOEX 090408	2,25	54096	
KUB-Q.3D.2165.R.09.ABS80	U12 45500	2.165	3.150	10.354	6.496	8.661	SOEX 090408	2,25	55098	
KUB-Q.3D.2203.R.09.ABS80	U12 45600	2.205	3.150	10.472	6.614	8.780	SOEX 090408	2,25	56098	
KUB-Q.3D.2250.R.09.ABS80-F	U12 45720	2.250	3.150	10.709	6.850	9.016	SOEX 090408	2,25		57298
KUB-Q.3D.2281.R.09.ABS80-F	U12 45790	2.281	3.150	10.709	6.850	9.016	SOEX 090408	2,25		57998
KUB-Q.3D.2375.R.09.ABS80-F	U12 46030	2.375	3.150	11.063	7.205	9.370	SOEX 090408	2,25		60398
KUB-Q.3D.2437.R.09.ABS80-F	U12 46190	2.437	3.150	11.181	7.323	9.488	SOEX 090408	2,25		61998
KUB-Q.3D.2500.R.09.ABS80-F	U12 46350	2.500	3.150	11.417	7.559	9.724	SOEX 090408	2,25		63598

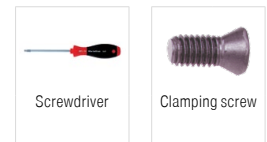

Spare parts
DC

DC	80 950 ...	10 950 ...
1.781 - 2.000	125	10800
2.062 - 2.500	128	10300

KUB Quatron – Indexable insert drill

Scope of supply:

Indexable Insert Drill incl. clamping screws

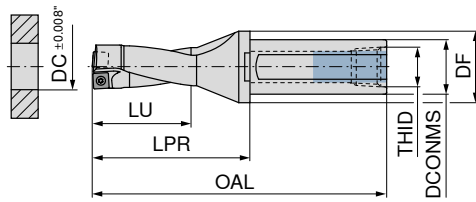
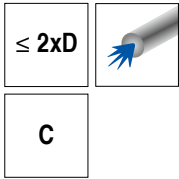

15 879 ...

Designation	KOMET no.	DC inch	DCONMS inch	DF inch	OAL inch	LU inch	LPR inch	THID inch	Insert	torque moment Nm	
KUB-Q.2D.0562.R.05.C0750-EF	U11 21435	0.562	0.750	1.180	4.376	1.181	2.126	1/8" NPT	SOEX 050204	0,62	14309
KUB-Q.2D.0593.R.05.C0750-EF	U11 21513	0.593	0.750	1.180	4.455	1.260	2.205	1/8" NPT	SOEX 050204	0,62	15109
KUB-Q.2D.0625.R.05.C0750-EF	U11 21593	0.625	0.750	1.180	4.455	1.260	2.205	1/8" NPT	SOEX 050204	0,62	15909
KUB-Q.2D.0656.R.05.C0750-EF	U11 21673	0.656	0.750	1.180	4.534	1.339	2.284	1/8" NPT	SOEX 050204	0,62	16709
KUB-Q.2D.0687.R.05.C0750-E	U11 21753	0.687	0.750	1.180	4.612	1.417	2.362	1/8" NPT	SOEX 050204	0,62	17509
KUB-Q.2D.0703.R.06.C1000-EF	U11 31793	0.703	1.000	1.180	5.612	1.417	2.362	1/8" NPT	SOEX 060306	1,01	17900
KUB-Q.2D.0718.R.06.C1000-EF	U11 31823	0.718	1.000	1.180	5.691	1.496	2.441	1/8" NPT	SOEX 060306	1,01	18200
KUB-Q.2D.0750.R.06.C1000-EF	U11 31913	0.750	1.000	1.180	5.770	1.575	2.520	1/8" NPT	SOEX 060306	1,01	19100
KUB-Q.2D.0765.R.06.C1000-EF	U11 31943	0.765	1.000	1.180	5.770	1.575	2.520	1/8" NPT	SOEX 060306	1,01	19400
KUB-Q.2D.0781.R.06.C1000-EF	U11 31983	0.781	1.000	1.180	5.770	1.575	2.520	1/8" NPT	SOEX 060306	1,01	19800
KUB-Q.2D.0812.R.06.C1000-EF	U11 32063	0.812	1.000	1.180	5.849	1.654	2.599	1/8" NPT	SOEX 060306	1,01	20600
KUB-Q.2D.0828.R.06.C1000-E	U11 32103	0.828	1.000	1.180	5.927	1.732	2.677	1/8" NPT	SOEX 060306	1,01	21000
KUB-Q.2D.0843.R.06.C1000-EF	U11 32143	0.843	1.000	1.180	5.927	1.732	2.677	1/8" NPT	SOEX 060306	1,01	21400
KUB-Q.2D.0875.R.07.C1000-EF	U11 32223	0.875	1.000	1.180	6.006	1.811	2.756	1/8" NPT	SOEX 07T308	1,01	22200
KUB-Q.2D.0906.R.07.C1000-E	U11 32303	0.906	1.000	1.180	6.085	1.890	2.835	1/8" NPT	SOEX 07T308	1,01	23000
KUB-Q.2D.0937.R.07.C1000-EF	U11 32382	0.937	1.000	1.180	6.085	1.890	2.835	1/8" NPT	SOEX 07T308	1,01	23800
KUB-Q.2D.0937.R.07.C1250-EF	U11 42383	0.937	1.250	1.540	6.085	1.890	2.835	1/4" NPT	SOEX 07T308	1,01	23801
KUB-Q.2D.0968.R.07.C1250-EF	U11 42463	0.968	1.250	1.540	6.164	1.969	2.914	1/4" NPT	SOEX 07T308	1,01	24601
KUB-Q.2D.0968.R.07.C1000-EF	U11 32462	0.968	1.000	1.180	6.164	1.969	2.914	1/8" NPT	SOEX 07T308	1,01	24600
KUB-Q.2D.0985.R.07.C1250-E	U11 42503	0.985	1.250	1.540	6.164	1.969	2.914	1/4" NPT	SOEX 07T308	1,01	25001
KUB-Q.2D.0985.R.07.C1000-E	U11 32502	0.985	1.000	1.180	6.164	1.969	2.914	1/8" NPT	SOEX 07T308	1,01	25000
KUB-Q.2D.1000.R.07.C1250-EF	U11 42543	1.000	1.250	1.540	6.242	2.047	2.992	1/4" NPT	SOEX 07T308	1,01	25401
KUB-Q.2D.1000.R.07.C1000-EF	U11 32542	1.000	1.000	1.180	6.242	2.047	2.992	1/8" NPT	SOEX 07T308	1,01	25400
KUB-Q.2D.1031.R.07.C1250-EF	U11 42622	1.031	1.250	1.540	6.321	2.126	3.071	1/4" NPT	SOEX 07T308	1,01	26201
KUB-Q.2D.1062.R.07.C1250-E	U11 42702	1.062	1.250	1.540	6.321	2.126	3.071	1/4" NPT	SOEX 07T308	1,01	27001
KUB-Q.2D.1109.R.09.C1250-EF	U11 42822	1.109	1.250	1.540	6.478	2.283	3.228	1/4" NPT	SOEX 090408	2,25	28201
KUB-Q.2D.1125.R.09.C1250-EF	U11 42862	1.125	1.250	1.540	6.478	2.283	3.228	1/4" NPT	SOEX 090408	2,25	28601
KUB-Q.2D.1156.R.09.C1250-EF	U11 42942	1.156	1.250	1.540	6.557	2.323	3.307	1/4" NPT	SOEX 090408	2,25	29401
KUB-Q.2D.1187.R.09.C1250-EF	U11 43022	1.187	1.250	1.540	6.832	2.441	3.582	1/4" NPT	SOEX 090408	2,25	30101
KUB-Q.2D.1218.R.09.C1250-EF	U11 43092	1.218	1.250	1.540	6.832	2.441	3.582	1/4" NPT	SOEX 090408	2,25	30901
KUB-Q.2D.1250.R.09.C1250-EF	U11 43182	1.250	1.250	1.540	6.911	2.520	3.661	1/4" NPT	SOEX 090408	2,25	31801
KUB-Q.2D.1281.R.09.C1250-E	U11 43252	1.281	1.250	1.540	6.990	2.598	3.740	1/4" NPT	SOEX 090408	2,25	32501
KUB-Q.2D.1312.R.12.C1250-EF	U11 43332	1.312	1.250	1.540	7.068	2.677	3.818	1/4" NPT	SOEX 120508	6,25	33301
KUB-Q.2D.1328.R.12.C1250-EF	U11 43372	1.328	1.250	1.540	7.068	2.677	3.818	1/4" NPT	SOEX 120508	6,25	33701
KUB-Q.2D.1375.R.12.C1250-EF	U11 43492	1.375	1.250	1.540	7.147	2.756	3.897	1/4" NPT	SOEX 120508	6,25	34901
KUB-Q.2D.1406.R.12.C1250-EF	U11 43572	1.406	1.250	1.540	7.226	2.835	3.976	1/4" NPT	SOEX 120508	6,25	35701
KUB-Q.2D.1437.R.12.C1250-E	U11 43652	1.437	1.250	1.540	7.698	2.913	4.448	1/4" NPT	SOEX 120508	6,25	36501
KUB-Q.2D.1469.R.12.C1250-EF	U11 43732	1.469	1.250	1.540	7.777	2.992	4.527	1/4" NPT	SOEX 120508	6,25	37301
KUB-Q.2D.1500.R.12.C1250-EF	U11 43812	1.500	1.250	1.540	7.856	3.071	4.606	1/4" NPT	SOEX 120508	6,25	38101
KUB-Q.2D.1531.R.12.C1250-EF	U11 43892	1.531	1.250	1.540	7.856	3.071	4.606	1/4" NPT	SOEX 120508	6,25	38901
KUB-Q.2D.1562.R.12.C1250-EF	U11 43972	1.562	1.250	1.540	7.935	3.150	4.685	1/4" NPT	SOEX 120508	6,25	39701
KUB-Q.2D.1625.R.12.C1250-EF	U11 44132	1.625	1.250	1.540	8.092	3.307	4.842	1/4" NPT	SOEX 120508	6,25	41301
KUB-Q.2D.1656.R.12.C1250-EF	U11 44212	1.656	1.250	1.540	8.171	3.386	4.921	1/4" NPT	SOEX 120508	6,25	42101
KUB-Q.2D.1687.R.12.C1250-EF	U11 44292	1.687	1.250	1.540	8.171	3.386	4.921	1/4" NPT	SOEX 120508	6,25	42801
KUB-Q.2D.1750.R.12.C1250-EF	U11 44452	1.750	1.250	1.540	8.250	3.465	5.000	1/4" NPT	SOEX 120508	6,25	44501

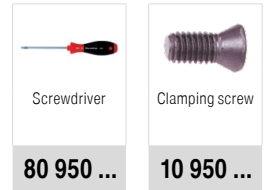

**Spare parts
DC**

	80 950 ...	10 950 ...
0.562 - 0.687	123	10000
0.703	129	10400
0.718 - 0.843	123	10700
0.875 - 1.062	125	10800
1.109 - 1.281	128	10300
1.312 - 1.750	129	10400

KUB Quatron – Indexable insert drill

Scope of supply:

Indexable Insert Drill incl. clamping screws

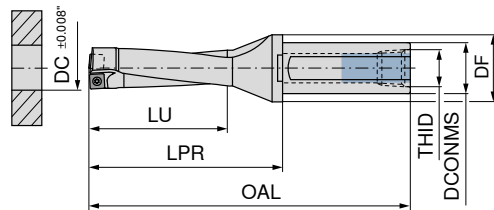
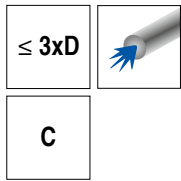

15 880 ...

Designation	KOMET no.	DC inch	DCONMS inch	DF inch	OAL inch	LU inch	LPR inch	THID inch	Insert	torque moment Nm	
KUB-Q.3D.0562.R.05.C0750-EF	U12 01434	0.562	0.750	1.180	4.967	1.772	2.717	1/8" NPT	SOEX 050204	0,62	14309
KUB-Q.3D.0593.R.05.C0750-EF	U12 01512	0.593	0.750	1.180	5.085	1.890	2.835	1/8" NPT	SOEX 050204	0,62	15109
KUB-Q.3D.0625.R.05.C0750-EF	U12 01592	0.625	0.750	1.180	5.085	1.890	2.835	1/8" NPT	SOEX 050204	0,62	15909
KUB-Q.3D.0656.R.05.C0750-EF	U12 01672	0.656	0.750	1.180	5.203	2.008	2.953	1/8" NPT	SOEX 050204	0,62	16709
KUB-Q.3D.0687.R.05.C0750-E	U12 01752	0.687	0.750	1.180	5.321	2.126	3.071	1/8" NPT	SOEX 050204	0,62	17509
KUB-Q.3D.0703.R.06.C1000-EF	U12 11792	0.703	1.000	1.180	6.321	2.126	3.071	1/8" NPT	SOEX 060306	1,01	17900
KUB-Q.3D.0718.R.06.C1000-EF	U12 11822	0.718	1.000	1.180	6.439	2.244	3.189	1/8" NPT	SOEX 060306	1,01	18200
KUB-Q.3D.0750.R.06.C1000-EF	U12 11912	0.750	1.000	1.180	6.557	2.362	3.307	1/8" NPT	SOEX 060306	1,01	19100
KUB-Q.3D.0765.R.06.C1000-EF	U12 11942	0.765	1.000	1.180	6.557	2.362	3.307	1/8" NPT	SOEX 060306	1,01	19400
KUB-Q.3D.0781.R.06.C1000-EF	U12 11982	0.781	1.000	1.180	6.557	2.362	3.307	1/8" NPT	SOEX 060306	1,01	19800
KUB-Q.3D.0812.R.06.C1000-EF	U12 12062	0.812	1.000	1.180	6.675	2.480	3.425	1/8" NPT	SOEX 060306	1,01	20600
KUB-Q.3D.0828.R.06.C1000-E	U12 12102	0.828	1.000	1.180	6.793	2.598	3.543	1/8" NPT	SOEX 060306	1,01	21000
KUB-Q.3D.0843.R.06.C1000-EF	U12 12142	0.843	1.000	1.180	6.793	2.598	3.543	1/8" NPT	SOEX 060306	1,01	21400
KUB-Q.3D.0875.R.07.C1000-EF	U12 12222	0.875	1.000	1.180	6.912	2.717	3.662	1/8" NPT	SOEX 07T308	1,01	22200
KUB-Q.3D.0906.R.07.C1000-E	U12 12302	0.906	1.000	1.180	7.030	2.835	3.780	1/8" NPT	SOEX 07T308	1,01	23000
KUB-Q.3D.0937.R.07.C1000-EF	U12 12382	0.937	1.000	1.180	7.030	2.835	3.780	1/8" NPT	SOEX 07T308	1,01	23800
KUB-Q.3D.0937.R.07.C1250-EF	U12 22382	0.937	1.250	1.540	7.030	2.835	3.780	1/4" NPT	SOEX 07T308	1,01	23801
KUB-Q.3D.0968.R.07.C1000-EF	U12 12462	0.968	1.000	1.180	7.148	2.953	3.898	1/8" NPT	SOEX 07T308	1,01	24600
KUB-Q.3D.0968.R.07.C1250-EF	U12 22462	0.968	1.250	1.540	7.148	2.953	3.898	1/4" NPT	SOEX 07T308	1,01	24601
KUB-Q.3D.0985.R.07.C1250-E	U12 22502	0.985	1.250	1.540	7.266	3.071	4.016	1/4" NPT	SOEX 07T308	1,01	25001
KUB-Q.3D.0985.R.07.C1000-E	U12 12502	0.985	1.000	1.180	7.148	2.953	3.898	1/8" NPT	SOEX 07T308	1,01	25000
KUB-Q.3D.1000.R.07.C1250-EF	U12 22542	1.000	1.250	1.540	7.266	3.071	4.016	1/4" NPT	SOEX 07T308	1,01	25401
KUB-Q.3D.1000.R.07.C1000-EF	U12 12542	1.000	1.000	1.180	7.266	3.071	4.016	1/8" NPT	SOEX 07T308	1,01	25400
KUB-Q.3D.1031.R.07.C1250-EF	U12 22622	1.031	1.250	1.540	7.384	3.189	4.134	1/4" NPT	SOEX 07T308	1,01	26201
KUB-Q.3D.1062.R.07.C1250-E	U12 22702	1.062	1.250	1.540	7.384	3.189	4.134	1/4" NPT	SOEX 07T308	1,01	27001
KUB-Q.3D.1109.R.09.C1250-EF	U12 22822	1.109	1.250	1.540	7.620	3.425	4.370	1/4" NPT	SOEX 090408	6,25	28201
KUB-Q.3D.1125.R.09.C1250-EF	U12 22862	1.125	1.250	1.540	7.620	3.425	4.370	1/4" NPT	SOEX 090408	6,25	28601
KUB-Q.3D.1156.R.09.C1250-EF	U12 22942	1.156	1.250	1.540	7.738	3.543	4.488	1/4" NPT	SOEX 090408	6,25	29401
KUB-Q.3D.1187.R.09.C1250-EF	U12 23022	1.187	1.250	1.540	8.053	3.661	4.803	1/4" NPT	SOEX 090408	6,25	30101
KUB-Q.3D.1218.R.09.C1250-EF	U12 23092	1.218	1.250	1.540	8.053	3.661	4.803	1/4" NPT	SOEX 090408	6,25	30901
KUB-Q.3D.1250.R.09.C1250-EF	U12 23182	1.250	1.250	1.540	8.171	3.780	4.921	1/4" NPT	SOEX 090408	6,25	31801
KUB-Q.3D.1281.R.09.C1250-E	U12 23252	1.281	1.250	1.540	8.289	3.898	5.039	1/4" NPT	SOEX 090408	6,25	32501
KUB-Q.3D.1312.R.12.C1250-EF	U12 23332	1.312	1.250	1.540	8.407	4.016	5.157	1/4" NPT	SOEX 120508	6,25	33301
KUB-Q.3D.1328.R.12.C1250-EF	U12 23372	1.328	1.250	1.540	8.407	4.016	5.157	1/4" NPT	SOEX 120508	6,25	33701
KUB-Q.3D.1375.R.12.C1250-EF	U12 23492	1.375	1.250	1.540	8.526	4.134	5.276	1/4" NPT	SOEX 120508	6,25	34901
KUB-Q.3D.1406.R.12.C1250-EF	U12 23572	1.406	1.250	1.540	8.644	4.252	5.394	1/4" NPT	SOEX 120508	6,25	35701
KUB-Q.3D.1437.R.12.C1250-E	U12 23652	1.437	1.250	1.540	9.156	4.370	5.906	1/4" NPT	SOEX 120508	6,25	36501
KUB-Q.3D.1469.R.12.C1250-EF	U12 23732	1.469	1.250	1.540	9.274	4.488	6.024	1/4" NPT	SOEX 120508	6,25	37301
KUB-Q.3D.1500.R.12.C1250-EF	U12 23812	1.500	1.250	1.540	9.392	4.606	6.142	1/4" NPT	SOEX 120508	6,25	38101
KUB-Q.3D.1531.R.12.C1250-EF	U12 23892	1.531	1.250	1.540	9.392	4.606	6.142	1/4" NPT	SOEX 120508	6,25	38901
KUB-Q.3D.1562.R.12.C1250-EF	U12 23972	1.562	1.250	1.540	9.510	4.724	6.260	1/4" NPT	SOEX 120508	6,25	39701
KUB-Q.3D.1625.R.12.C1250-EF	U12 24132	1.625	1.250	1.540	9.746	4.961	6.496	1/4" NPT	SOEX 120508	6,25	41301
KUB-Q.3D.1656.R.12.C1250-EF	U12 24212	1.656	1.250	1.540	9.864	5.079	6.614	1/4" NPT	SOEX 120508	6,25	42101
KUB-Q.3D.1687.R.12.C1250-EF	U12 24292	1.687	1.250	1.540	9.864	5.079	6.614	1/4" NPT	SOEX 120508	6,25	42801
KUB-Q.3D.1750.R.12.C1250-EF	U12 24452	1.750	1.250	1.540	9.982	5.197	6.732	1/4" NPT	SOEX 120508	6,25	44501

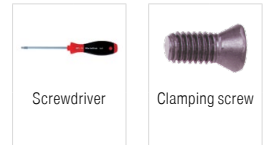

Screwdriver 80 950 ... Clamping screw 10 950 ...

Spare parts
DC

0.562 - 0.687	123	10000
0.703 - 0.843	123	10700
0.875 - 1.062	125	10800
1.109 - 1.281	128	10300
1.312 - 1.750	129	10400

SOEX

Designation	L inch	IC inch	D1 inch	S inch
SOEX 0502..	0.218	0.218	0.090	0.093
SOEX 0603..	0.250	0.250	0.104	0.125
SOEX 07T3..	0.312	0.312	0.112	0.140
SOEX 0904..	0.374	0.374	0.161	0.172
SOEX 1205..	0.500	0.500	0.204	0.203

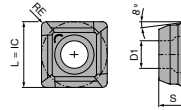

SOEX

NEW

NEW

NEW

NEW

NEW

-01
BK8425

-13
BK8425

-03
BK8430

-01
BK6115

-01
BK6420

SOEX
10 822 ...

SOEX
10 822 ...

SOEX
10 822 ...

SOEX
10 822 ...

SOEX
10 822 ...

ISO	KOMET no.	RE inch	10 822 ...	10 822 ...	10 822 ...	10 822 ...	10 822 ...
050204	W83 13000.016115	0.016					40501
050204	W83 13010.046420	0.016					45501
050204	W83 13010.048425	0.016	30501				
050204	W83 13030.048430	0.016			00503		
050204	W83 13130.048425	0.016		30513			
060306	W83 18000.096115	0.024					40601
060306	W83 18010.066420	0.024					45601
060306	W83 18010.068425	0.024	30601				
060306	W83 18030.068430	0.024			00603		
060306	W83 18130.068425	0.024		30613			
07T308	W83 23000.016115	0.031					40701
07T308	W83 23010.086420	0.031					45701
07T308	W83 23010.088425	0.031	30701				
07T308	W83 23030.088430	0.031			00703		
07T308	W83 23130.088425	0.031		30713			
090408	W83 32000.156115	0.031					40901
090408	W83 32010.086420	0.031					45901
090408	W83 32010.088425	0.031	30901				
090408	W83 32030.088430	0.031			00903		
090408	W83 32130.088425	0.031		30913			
120508	W83 44000.186115	0.031					41201
120508	W83 44010.086420	0.031					46201
120508	W83 44010.088425	0.031	31201				
120508	W83 44030.088430	0.031			01203		
120508	W83 44130.088425	0.031		31213			
P			●	●	●	●	●
M			●	●	●	●	●
K			●	●	●	●	○
N			○	○	○	○	○
S			●	●	●	●	●
H			○	○	○	○	○
O							

→ v_c Page 46-47

SOEX

Designation	L inch	IC inch	D1 inch	S inch
SOEX 0502..	0.218	0.218	0.090	0.093
SOEX 0603..	0.250	0.250	0.104	0.125
SOEX 07T3..	0.312	0.312	0.112	0.140
SOEX 0904..	0.374	0.374	0.161	0.172
SOEX 1205..	0.500	0.500	0.204	0.203

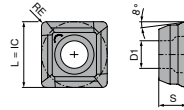

SOEX

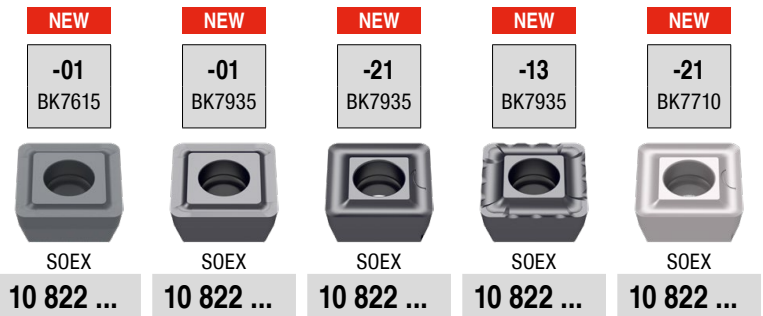

ISO	KOMET no.	RE inch	10 822 ...	10 822 ...	10 822 ...	10 822 ...	10 822 ...
050204	W83 13010.047615	0.016	05501				
050204	W83 13010.047935	0.016		50501			
050204	W83 13130.047935	0.016				50513	
050204	W83 13210.047710	0.016					90521
050204	W83 13210.047935	0.016			50521		
060306	W83 18010.067615	0.024	05601				
060306	W83 18010.067935	0.024		50601			
060306	W83 18130.067935	0.024				50613	
060306	W83 18210.067710	0.024					90621
060306	W83 18210.067935	0.024			51621		
07T308	W83 23010.087615	0.031	05701				
07T308	W83 23010.087935	0.031		50701			
07T308	W83 23130.087935	0.031				50713	
07T308	W83 23210.087710	0.031					90721
07T308	W83 23210.087935	0.031			50721		
090408	W83 32010.087615	0.031	05901				
090408	W83 32010.087935	0.031		50901			
090408	W83 32130.087935	0.031				50913	
090408	W83 32210.087710	0.031					90921
090408	W83 32210.087935	0.031			50921		
120508	W83 44010.087615	0.031	06201				
120508	W83 44010.087935	0.031		51201			
120508	W83 44130.087935	0.031				51213	
120508	W83 44210.087710	0.031					91221
120508	W83 44210.087935	0.031			51221		

P		●	●	●
M		●	●	●
K	●	●	●	●
N		○	○	○ ●
S		●	●	● ○
H				
O		○	○	○ ○

→ v_c Page 46-47

KUB Trigon – Indexable insert drill

Scope of supply:

Indexable Insert Drill incl. clamping screws

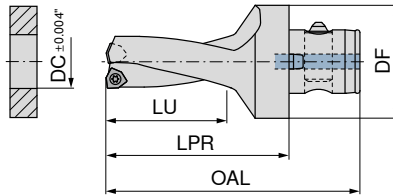
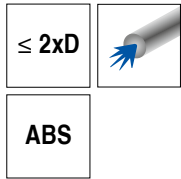

NEW



15 892 ...

Designation	KOMET no.	DC inch	DF inch	OAL inch	LU inch	LPR inch	Insert	torque moment Nm	
KUB-T-U.2D.0562.R.03.ABS50-F	V40 11430	0.562	1.969	3.780	1.181	2.559	WOEX 030204	0,62	14395
KUB-T-U.2D.0593.R.03.ABS50-F	V40 11510	0.593	1.969	3.858	1.260	2.638	WOEX 030204	0,62	15195
KUB-T-U.2D.0625.R.03.ABS50-F	V40 11590	0.625	1.969	3.858	1.260	2.638	WOEX 030204	0,62	15995
KUB-T-U.2D.0687.R.03.ABS50-F	V40 11750	0.687	1.969	4.016	1.417	2.795	WOEX 030204	0,62	17595
KUB-T-U.2D.0703.R.03.ABS50-F	V40 11790	0.703	1.969	4.016	1.417	2.559	WOEX 030204	0,62	17995
KUB-T-U.2D.0750.R.03.ABS50-F	V40 11910	0.750	1.969	4.173	1.575	2.638	WOEX 030204	0,62	19195
KUB-T-U.2D.0781.R.03.ABS50-F	V40 11980	0.781	1.969	4.173	1.575	2.638	WOEX 030204	0,62	19895
KUB-T-U.2D.0812.R.04.ABS50-F	V40 12060	0.812	1.969	4.252	1.654	2.795	WOEX 040304	1,01	20695
KUB-T-U.2D.0828.R.04.ABS50-F	V40 12100	0.828	1.969	4.252	1.654	2.795	WOEX 040304	1,01	21095
KUB-T-U.2D.0875.R.04.ABS50-F	V40 12220	0.875	1.969	4.409	1.811	2.953	WOEX 040304	1,01	22295
KUB-T-U.2D.0937.R.04.ABS50-F	V40 12380	0.937	1.969	4.488	1.890	2.953	WOEX 040304	1,01	23895
KUB-T-U.2D.1000.R.05.ABS50-F	V40 12540	1.000	1.969	4.646	2.047	3.031	WOEX 05T304	1,28	25495
KUB-T-U.2D.1031.R.05.ABS50-F	V40 12620	1.031	1.969	4.724	2.126	3.031	WOEX 05T304	1,28	26295
KUB-T-U.2D.1062.R.05.ABS50-F	V40 12700	1.062	1.969	4.724	2.126	3.189	WOEX 05T304	1,28	27095
KUB-T-U.2D.1109.R.05.ABS50-F	V40 12820	1.109	1.969	4.882	2.283	3.268	WOEX 05T304	1,28	28295
KUB-T-U.2D.1125.R.05.ABS50-F	V40 12860	1.125	1.969	4.882	2.283	3.425	WOEX 05T304	1,28	28695
KUB-T-U.2D.1156.R.05.ABS50-F	V40 12940	1.156	1.969	4.961	2.362	3.504	WOEX 05T304	1,28	29495
KUB-T-U.2D.1187.R.05.ABS50-F	V40 13010	1.187	1.969	5.236	2.441	3.504	WOEX 05T304	1,28	30195
KUB-T-U.2D.1218.R.05.ABS50-F	V40 13090	1.218	1.969	5.236	2.441	3.661	WOEX 05T304	1,28	30995
KUB-T-U.2D.1250.R.05.ABS50-F	V40 13180	1.250	1.969	5.315	2.520	3.661	WOEX 05T304	1,28	31895
KUB-T-U.2D.1281.R.05.ABS50-F	V40 13250	1.281	1.969	5.394	2.598	3.740	WOEX 05T304	1,28	32595
KUB-T-U.2D.1312.R.05.ABS50-F	V40 13330	1.312	1.969	5.472	2.677	4.016	WOEX 05T304	1,28	33395
KUB-T-U.2D.1328.R.05.ABS50-F	V40 13370	1.328	1.969	5.472	2.677	4.016	WOEX 05T304	1,28	33795
KUB-T-U.2D.1375.R.05.ABS50-F	V40 13490	1.375	1.969	5.551	2.756	4.094	WOEX 05T304	1,28	34995
KUB-T-U.2D.1406.R.05.ABS50-F	V40 13570	1.406	1.969	5.630	2.835	4.173	WOEX 05T304	1,28	35795
KUB-T-U.2D.1437.R.05.ABS50-F	V40 13650	1.437	1.969	6.102	2.913	4.252	WOEX 05T304	1,28	36595
KUB-T-U.2D.1469.R.06.ABS50-F	V40 13730	1.469	1.969	6.181	2.992	4.252	WOEX 06T304	2,8	37395
KUB-T-U.2D.1500.R.06.ABS50-F	V40 13810	1.500	1.969	6.260	3.071	4.331	WOEX 06T304	2,8	38195
KUB-T-U.2D.1531.R.06.ABS50-F	V40 13890	1.531	1.969	6.260	3.071	4.409	WOEX 06T304	2,8	38995
KUB-T-U.2D.1562.R.06.ABS50-F	V40 13970	1.562	1.969	6.339	3.150	4.882	WOEX 06T304	2,8	39795
KUB-T-U.2D.1625.R.06.ABS50-F	V40 14130	1.625	1.969	6.496	3.307	4.961	WOEX 06T304	2,8	41395
KUB-T-U.2D.1656.R.06.ABS50-F	V40 14210	1.656	1.969	6.575	3.386	5.039	WOEX 06T304	2,8	42195
KUB-T-U.2D.1687.R.06.ABS50-F	V40 14280	1.687	1.969	6.575	3.386	5.039	WOEX 06T304	2,8	42895
KUB-T-U.2D.1750.R.06.ABS50-F	V40 14450	1.750	1.969	6.689	3.500	5.118	WOEX 06T304	2,8	44595

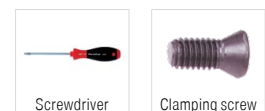

80 950 ...

10 950 ...

Spare parts

DC	80 950 ...	10 950 ...
0.562 - 0.781	123	10000
0.812 - 0.937	123	10700
1.000 - 1.437	125	10500
1.469 - 1.750	127	10600

Matching holders can be found in our Online-Shop at cuttingtools.ceratizit.com and in the metric clamping technology catalog

KUB Trigon – Indexable insert drill

Scope of supply:

with indexable insert (10 897 ...) incl. fixing screw, cylindrical pin and clamping screw
with indexable insert (10 898 ...) incl. fixing screw, cylindrical pin and clamping screw

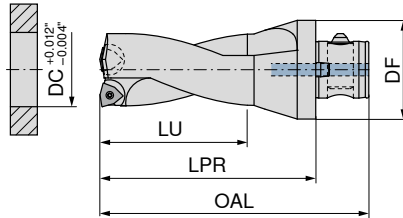
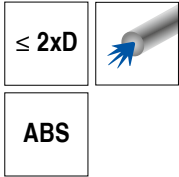

Designation	KOMET no.	DC inch	DF inch	OAL inch	LU inch	LPR inch	Insert	torque moment Nm	10 892 ...	15 892 ...
KUB-T.2D.1781.R.08.ABS63-F	V13 34520	1.781	2.480	7.224	3.562	5.728	WOEX 080404	4,3		45296
KUB-T.2D.1812.R.08.ABS63	V13 34600	1.811	2.480	7.283	3.622	5.787	WOEX 080404	4,3	46096	
KUB-T.2D.1875.R.08.ABS63-F	V13 34760	1.875	2.480	7.412	3.750	5.916	WOEX 080404	4,3		47696
KUB-T.2D.1937.R.08.ABS63-F	V13 34920	1.937	2.480	7.536	3.874	6.040	WOEX 080404	4,3		49296
KUB-T.2D.1975.R.08.ABS63-F	V13 35020	1.975	2.480	7.612	3.950	6.116	WOEX 080404	4,3		50296
KUB-T.2D.2000.R.08.ABS63-F	V13 35080	2.000	2.480	7.662	4.000	6.166	WOEX 080404	4,3		50896
KUB-T.2D.2062.R.08.ABS63-F	V13 35240	2.062	2.480	7.786	4.124	6.290	WOEX 080404	4,3		52496
KUB-T.2D.2125.R.08.ABS63	V13 35400	2.126	2.480	7.913	4.252	6.417	WOEX 080404	4,3	54096	
KUB-T.2D.2165.R.10.ABS80	V14 35500	2.165	3.150	8.189	4.331	6.496	WOEX 100504	4,3	55098	
KUB-T.2D.2203.R.10.ABS80	V14 35600	2.205	3.150	8.268	4.409	6.575	WOEX 100504	4,3	56098	
KUB-T.2D.2250.R.10.ABS80-F	V14 35720	2.250	3.150	8.359	4.500	6.666	WOEX 100504	4,3		57298
KUB-T.2D.2281.R.10.ABS80-F	V14 35790	2.281	3.150	8.421	4.562	6.728	WOEX 100504	4,3		57998
KUB-T.2D.2375.R.10.ABS80-F	V14 36030	2.375	3.150	8.609	4.750	6.916	WOEX 100504	4,3		60398
KUB-T.2D.2437.R.10.ABS80-F	V14 36190	2.437	3.150	8.733	4.874	7.040	WOEX 100504	4,3		61998
KUB-T.2D.2500.R.10.ABS80-F	V14 36350	2.500	3.150	8.859	5.000	7.166	WOEX 100504	4,3		63598
KUB-T.2D.2593.R.10.ABS80-F	V14 36590	2.593	3.150	9.045	5.186	7.352	WOEX 100504	4,3		65998
KUB-T.2D.2625.R.10.ABS80-F	V14 36670	2.625	3.150	9.109	5.250	7.416	WOEX 100504	4,3		66798
KUB-T.2D.2656.R.10.ABS80-F	V14 36750	2.656	3.150	9.171	5.312	7.478	WOEX 100504	4,3		67598
KUB-T.2D.2750.R.12.ABS80-F	V14 36990	2.750	3.150	9.753	5.500	8.060	WOEX 120608	6,25		69998
KUB-T.2D.2875.R.12.ABS80	V14 37300	2.874	3.150	10.000	5.748	8.307	WOEX 120608	6,25	73098	
KUB-T.2D.3000.R.12.ABS80-F	V14 37620	3.000	3.150	10.253	6.000	8.560	WOEX 120608	6,25		76298
KUB-T.2D.3250.R.12.ABS80-F	V14 38260	3.250	3.150	10.753	6.500	9.060	WOEX 120608	6,25		82698

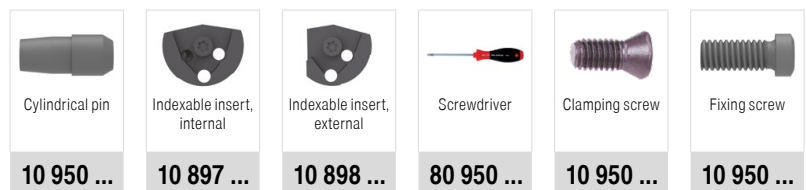

Spare parts

DC	10 950 ...	10 897 ...	10 898 ...	80 950 ...	10 950 ...	10 950 ...
1.781 - 2.126		17200	14800	120	12700	17000
2.165 - 2.656		17200	25300	120	12700	17000
2.750 - 3.250		17300	36000	121	17400	17100

Matching holders can be found in our Online-Shop at cuttingtools.ceratizit.com and in the metric clamping technology catalog

KUB Trigon – Indexable insert drill

Scope of supply:

Indexable Insert Drill incl. clamping screws

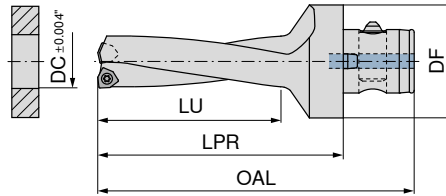
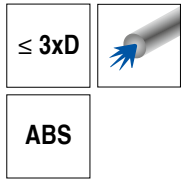

15 893 ...

Designation	KOMET no.	DC inch	DF inch	OAL inch	LU inch	LPR inch	Insert	torque moment Nm	
KUB-T-U.3D.0562.R.03.ABS50-F	V40 21430	0.562	1.969	4.370	1.772	5.276	WOEX 030204	0,62	14395
KUB-T-U.3D.0593.R.03.ABS50-F	V40 21510	0.593	1.969	4.488	1.890	5.354	WOEX 030204	0,62	15195
KUB-T-U.3D.0625.R.03.ABS50-F	V40 21590	0.625	1.969	4.488	1.890	5.354	WOEX 030204	0,62	15995
KUB-T-U.3D.0656.R.03.ABS50-F	V40 21670	0.656	1.969	4.606	2.008	5.469	WOEX 030204	0,62	16795
KUB-T-U.3D.0687.R.03.ABS50-F	V40 21750	0.687	1.969	4.724	2.126	3.150	WOEX 030204	0,62	17595
KUB-T-U.3D.0703.R.03.ABS50-F	V40 21790	0.703	1.969	4.724	2.126	3.268	WOEX 030204	0,62	17995
KUB-T-U.3D.0750.R.03.ABS50-F	V40 21910	0.750	1.969	4.961	2.362	3.268	WOEX 030204	0,62	19195
KUB-T-U.3D.0765.R.03.ABS50-F	V40 21940	0.765	1.969	4.961	2.362	3.386	WOEX 030204	0,62	19495
KUB-T-U.3D.0781.R.03.ABS50-F	V40 21980	0.781	1.969	4.961	2.362	3.504	WOEX 030204	0,62	19895
KUB-T-U.3D.0812.R.04.ABS50-F	V40 22060	0.812	1.969	5.079	2.480	3.504	WOEX 040304	1,01	20695
KUB-T-U.3D.0828.R.04.ABS50-F	V40 22100	0.828	1.969	5.079	2.480	3.740	WOEX 040304	1,01	21095
KUB-T-U.3D.0875.R.04.ABS50-F	V40 22220	0.875	1.969	5.315	2.717	3.740	WOEX 040304	1,01	22295
KUB-T-U.3D.0937.R.04.ABS50-F	V40 22380	0.937	1.969	5.433	2.835	3.740	WOEX 040304	1,01	23895
KUB-T-U.3D.0985.R.04.ABS50-F	V40 22500	0.985	1.969	5.551	2.953	3.858	WOEX 040304	1,01	25095
KUB-T-U.3D.1000.R.05.ABS50-F	V40 22540	1.000	1.969	5.669	3.071	3.858	WOEX 05T304	1,28	25495
KUB-T-U.3D.1031.R.05.ABS50-F	V40 22620	1.031	1.969	5.787	3.189	4.094	WOEX 05T304	1,28	26295
KUB-T-U.3D.1062.R.05.ABS50-F	V40 22700	1.062	1.969	5.787	3.189	4.213	WOEX 05T304	1,28	27095
KUB-T-U.3D.1109.R.05.ABS50-F	V40 22820	1.109	1.969	6.024	3.425	4.331	WOEX 05T304	1,28	28295
KUB-T-U.3D.1125.R.05.ABS50-F	V40 22860	1.125	1.969	6.024	3.425	4.449	WOEX 05T304	1,28	28695
KUB-T-U.3D.1156.R.05.ABS50-F	V40 22940	1.156	1.969	6.142	3.543	4.567	WOEX 05T304	1,28	29495
KUB-T-U.3D.1187.R.05.ABS50-F	V40 23010	1.187	1.969	6.457	3.661	4.567	WOEX 05T304	1,28	30195
KUB-T-U.3D.1218.R.05.ABS50-F	V40 23090	1.218	1.969	6.457	3.661	4.803	WOEX 05T304	1,28	30995
KUB-T-U.3D.1250.R.05.ABS50-F	V40 23180	1.250	1.969	6.575	3.780	4.803	WOEX 05T304	1,28	31895
KUB-T-U.3D.1281.R.05.ABS50-F	V40 23250	1.281	1.969	6.693	3.898	4.921	WOEX 05T304	1,28	32595
KUB-T-U.3D.1312.R.05.ABS50-F	V40 23330	1.312	1.969	6.811	4.016	5.236	WOEX 05T304	1,28	33395
KUB-T-U.3D.1328.R.05.ABS50-F	V40 23370	1.328	1.969	6.811	4.016	5.236	WOEX 05T304	1,28	33795
KUB-T-U.3D.1375.R.05.ABS50-F	V40 23490	1.375	1.969	6.929	4.134	5.354	WOEX 05T304	1,28	34995
KUB-T-U.3D.1406.R.05.ABS50-F	V40 23570	1.406	1.969	7.047	4.252	5.472	WOEX 05T304	1,28	35795
KUB-T-U.3D.1437.R.05.ABS50-F	V40 23650	1.437	1.969	7.559	4.370	5.591	WOEX 05T304	1,28	36595
KUB-T-U.3D.1469.R.06.ABS50-F	V40 23730	1.469	1.969	7.677	4.488	5.591	WOEX 06T304	2,8	37395
KUB-T-U.3D.1500.R.06.ABS50-F	V40 23810	1.500	1.969	7.795	4.606	5.709	WOEX 06T304	2,8	38195
KUB-T-U.3D.1531.R.06.ABS50-F	V40 23890	1.531	1.969	7.795	4.606	5.827	WOEX 06T304	2,8	38995
KUB-T-U.3D.1562.R.06.ABS50-F	V40 23970	1.562	1.969	7.913	4.724	6.339	WOEX 06T304	2,8	39795
KUB-T-U.3D.1625.R.06.ABS50-F	V40 24130	1.625	1.969	8.150	4.961	6.457	WOEX 06T304	2,8	41395
KUB-T-U.3D.1656.R.06.ABS50-F	V40 24210	1.656	1.969	8.268	5.079	6.575	WOEX 06T304	2,8	42195
KUB-T-U.3D.1687.R.06.ABS50-F	V40 24280	1.687	1.969	8.268	5.079	6.575	WOEX 06T304	2,8	42895
KUB-T-U.3D.1750.R.06.ABS50-F	V40 24450	1.750	1.969	8.439	5.250	6.693	WOEX 06T304	2,8	44595

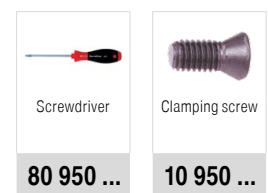

Spare parts

DC	80 950 ...	10 950 ...
0.562 - 0.781	123	10000
0.812 - 0.985	123	10700
1.000 - 1.437	125	10500
1.469 - 1.750	127	10600

Matching holders can be found in our Online-Shop at cuttingtools.ceratizit.com and in the metric clamping technology catalog

KUB Trigon – Indexable insert drill

▲ Tightening torque refers to clamping screw

Scope of supply:

with indexable insert (10 897 ...) incl. fixing screw, cylindrical pin and clamping screw
with indexable insert (10 898 ...) incl. fixing screw, cylindrical pin and clamping screw

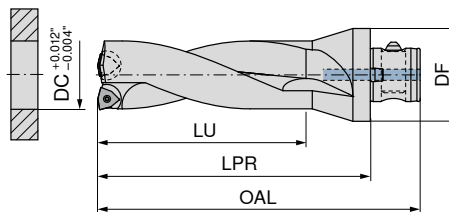
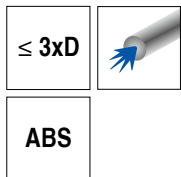

Designation	KOMET no.	DC inch	DF inch	OAL inch	LU inch	LPR inch	Insert	torque moment Nm	10 893 ...	15 893 ...	
KUB-T.3D.1781.R.08.ABS63-F	V13 74520	1.781	2.480	9.005	5.343	7.509	WOEX 080404	4,3	46096	45296	
KUB-T.3D.1812.R.08.ABS63	V13 74600	1.811	2.480	9.094	5.433	7.598	WOEX 080404	4,3		47696	
KUB-T.3D.1875.R.08.ABS63-F	V13 74760	1.875	2.480	9.287	5.625	7.791	WOEX 080404	4,3		49296	
KUB-T.3D.1937.R.08.ABS63-F	V13 74920	1.937	2.480	9.473	5.811	7.977	WOEX 080404	4,3		50296	
KUB-T.3D.1975.R.08.ABS63-F	V13 75020	1.975	2.480	9.587	5.925	8.091	WOEX 080404	4,3		50896	
KUB-T.3D.2000.R.08.ABS63-F	V13 75080	2.000	2.480	9.662	6.000	8.166	WOEX 080404	4,3		52496	
KUB-T.3D.2062.R.08.ABS63-F	V13 75240	2.062	2.480	10.028	6.186	8.532	WOEX 080404	4,3	54096		
KUB-T.3D.2125.R.08.ABS63	V13 75400	2.126	2.480	10.039	6.378	8.543	WOEX 080404	4,3			
KUB-T.3D.2165.R.10.ABS80	V14 75500	2.165	3.150	10.354	6.496	8.661	WOEX 100504	4,3	55098		
KUB-T.3D.2203.R.10.ABS80	V14 75600	2.205	3.150	10.472	6.614	8.780	WOEX 100504	4,3	56098		
KUB-T.3D.2250.R.10.ABS80-F	V14 75720	2.250	3.150	10.609	6.750	8.916	WOEX 100504	4,3	73098	57298	
KUB-T.3D.2281.R.10.ABS80-F	V14 75790	2.281	3.150	10.702	6.843	9.009	WOEX 100504	4,3		57998	
KUB-T.3D.2375.R.10.ABS80-F	V14 76030	2.375	3.150	10.984	7.125	9.291	WOEX 100504	4,3		60398	
KUB-T.3D.2437.R.10.ABS80-F	V14 76190	2.437	3.150	11.170	7.311	9.477	WOEX 100504	4,3		61998	
KUB-T.3D.2500.R.10.ABS80-F	V14 76350	2.500	3.150	11.359	7.500	9.666	WOEX 100504	4,3		63598	
KUB-T.3D.2593.R.10.ABS80-F	V14 76590	2.593	3.150	11.638	7.779	9.945	WOEX 100504	4,3		65998	
KUB-T.3D.2625.R.10.ABS80-F	V14 76670	2.625	3.150	11.734	7.875	10.041	WOEX 100504	4,3		66798	
KUB-T.3D.2656.R.10.ABS80-F	V14 76750	2.656	3.150	11.827	7.968	10.134	WOEX 100504	4,3		67598	
KUB-T.3D.2750.R.12.ABS80-F	V14 76990	2.750	3.150	12.503	8.250	10.810	WOEX 120608	6,25			69998
KUB-T.3D.2875.R.12.ABS80	V14 77300	2.874	3.150	12.874	8.622	11.181	WOEX 120608	6,25			
KUB-T.3D.3000.R.12.ABS80-F	V14 77620	3.000	3.150	13.253	9.000	11.560	WOEX 120608	6,25			76298
KUB-T.3D.3250.R.12.ABS80-F	V14 78260	3.250	3.150	14.003	9.750	12.310	WOEX 120608	6,25			82698

	Cylindrical pin	Indexable insert, internal	Indexable insert, external	Screwdriver	Clamping screw	Fixing screw
Spare parts						
DC						
1.781 - 2.126		17200	14800	120	12700	17000
2.165 - 2.656		17200	25300	120	12700	17000
2.750 - 3.250		17300	36000	121	17400	17100

Matching holders can be found in our Online-Shop at cuttingtools.ceratizit.com and in the metric clamping technology catalog

KUB Trigon – Indexable insert drill

Scope of supply:

Indexable Insert Drill incl. clamping screws



ABS

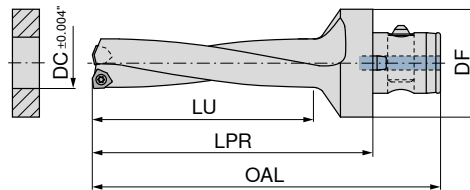

Designation	KOMET no.	DC inch	DF inch	OAL inch	LU inch	LPR inch	Insert	torque moment Nm	10 894 ...		15 894 ...	
KUB-T.4D.0562.R.03.ABS50-F	V30 91431	0.562	1.969	4.955	2.358	3.735	WOEX 030204	0,62				14395
KUB-T.4D.0593.R.03.ABS50-F	V30 91511	0.593	1.969	5.112	2.514	3.892	WOEX 030204	0,62				15195
KUB-T.4D.0625.R.03.ABS50-F	V30 91591	0.625	1.969	5.114	2.516	3.894	WOEX 030204	0,62				15995
KUB-T.4D.0656.R.03.ABS50-F	V30 91671	0.656	1.969	5.269	2.671	4.049	WOEX 030204	0,62				16795
KUB-T.4D.0687.R.03.ABS50-F	V30 91751	0.687	1.969	5.425	2.827	4.205	WOEX 030204	0,62				17595
KUB-T.4D.0703.R.03.ABS50-F	V30 91791	0.703	1.969	5.425	2.828	4.205	WOEX 030204	0,62				17995
KUB-T.4D.0750.R.03.ABS50-F	V30 91911	0.750	1.969	5.740	3.142	4.520	WOEX 030204	0,62				19195
KUB-T.4D.0765.R.03.ABS50-F	V30 91941	0.765	1.969	5.752	3.154	4.532	WOEX 030204	0,62				19495
KUB-T.4D.0781.R.03.ABS50-F	V30 91981	0.781	1.969	5.753	3.155	4.533	WOEX 030204	0,62				19895
KUB-T.4D.0812.R.04.ABS50-F	V30 92061	0.812	1.969	5.909	3.311	4.689	WOEX 040304	1,01				20695
KUB-T.4D.0828.R.04.ABS50	V30 92101	0.827	1.969	5.906	3.307	4.685	WOEX 040304	1,01	21095			
KUB-T.4D.0875.R.04.ABS50-F	V30 92221	0.875	1.969	6.224	3.626	5.004	WOEX 040304	1,01				22295
KUB-T.4D.0937.R.04.ABS50-F	V30 92381	0.937	1.969	6.377	3.779	5.157	WOEX 040304	1,01				23895
KUB-T.4D.0985.R.05.ABS50	V30 92501	0.984	1.969	6.535	3.937	5.315	WOEX 05T304	1,28	25095			
KUB-T.4D.1000.R.05.ABS50-F	V30 92541	1.000	1.969	6.692	4.094	5.472	WOEX 05T304	1,28				25495
KUB-T.4D.1031.R.05.ABS50-F	V30 92621	1.031	1.969	6.848	4.250	5.628	WOEX 05T304	1,28				26295
KUB-T.4D.1062.R.05.ABS50	V30 92701	1.063	1.969	6.850	4.252	5.630	WOEX 05T304	1,28	27095			
KUB-T.4D.1109.R.05.ABS50-F	V30 92821	1.109	1.969	7.160	4.562	5.940	WOEX 05T304	1,28				28295
KUB-T.4D.1125.R.05.ABS50-F	V30 92861	1.125	1.969	7.161	4.563	5.941	WOEX 05T304	1,28				28695
KUB-T.4D.1156.R.05.ABS50-F	V30 92941	1.156	1.969	7.316	4.718	6.096	WOEX 05T304	1,28				29495
KUB-T.4D.1187.R.05.ABS50-F	V30 93021	1.187	1.969	7.685	4.874	6.465	WOEX 05T304	1,28				30195
KUB-T.4D.1218.R.05.ABS50-F	V30 93091	1.218	1.969	7.699	4.888	6.479	WOEX 05T304	1,28				30995
KUB-T.4D.1250.R.05.ABS50-F	V30 93181	1.250	1.969	7.842	5.031	6.622	WOEX 05T304	1,28				31895
KUB-T.4D.1281.R.05.ABS50-F	V30 93251	1.281	1.969	8.014	5.203	6.794	WOEX 05T304	1,28				32595
KUB-T.4D.1312.R.05.ABS50-F	V30 93331	1.312	1.969	8.161	5.350	6.941	WOEX 05T304	1,28				33395
KUB-T.4D.1328.R.05.ABS50-F	V30 93371	1.328	1.969	8.170	5.359	6.950	WOEX 05T304	1,28				33795
KUB-T.4D.1375.R.05.ABS50-F	V30 93491	1.375	1.969	8.327	5.516	7.107	WOEX 05T304	1,28				34995
KUB-T.4D.1406.R.05.ABS50-F	V30 93571	1.406	1.969	8.482	5.671	7.262	WOEX 05T304	1,28				35795
KUB-T.4D.1437.R.05.ABS50-F	V30 93651	1.437	1.969	8.638	5.827	7.418	WOEX 05T304	1,28				36595
KUB-T.4D.1469.R.06.ABS50-F	V30 93731	1.469	1.969	9.175	5.986	7.955	WOEX 06T304	2,8				37395
KUB-T.4D.1500.R.06.ABS50-F	V30 93811	1.500	1.969	9.331	6.142	8.111	WOEX 06T304	2,8				38195
KUB-T.4D.1531.R.06.ABS50-F	V30 93891	1.531	1.969	9.329	6.140	8.109	WOEX 06T304	2,8				38995
KUB-T.4D.1562.R.06.ABS50-F	V30 93971	1.562	1.969	9.484	6.295	8.264	WOEX 06T304	2,8				39795
KUB-T.4D.1625.R.06.ABS50-F	V30 94131	1.625	1.969	9.799	6.610	8.579	WOEX 06T304	2,8				41395
KUB-T.4D.1656.R.06.ABS50-F	V30 94211	1.656	1.969	9.955	6.766	8.735	WOEX 06T304	2,8				42195
KUB-T.4D.1687.R.06.ABS50-F	V30 94291	1.687	1.969	9.953	6.764	8.733	WOEX 06T304	2,8				42895
KUB-T.4D.1750.R.06.ABS50-F	V30 94451	1.750	1.969	10.268	7.079	9.048	WOEX 06T304	2,8				44595

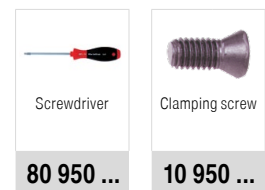

Spare parts
DC

0.562 - 0.781	123	10000
0.812 - 0.937	123	10700
0.984 - 1.437	125	10500
1.469 - 1.750	127	10600

Matching holders can be found in our Online-Shop at cuttingtools.ceratizit.com and in the metric clamping technology catalog

KUB Trigon – Indexable insert drill

Scope of supply:

Indexable Insert Drill incl. clamping screws

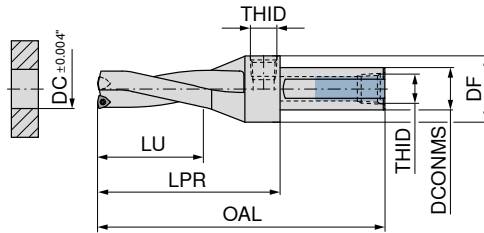
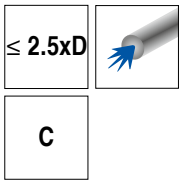

15 896 ...

Designation	KOMET no.	DC inch	DCONMS inch	DF inch	OAL inch	LU inch	LPR inch	THID inch	Insert	torque moment Nm	
KUB-T.2,5D.0562.R.03.C0750-EF	V57 41432	0.562	0.750	1.130	5.125	1.405	2.875	1/8" NPT	WOEX 030204	0,62	14309
KUB-T.2,5D.0593.R.03.C0750-EF	V57 41510	0.593	0.750	1.130	5.125	1.483	2.875	1/8" NPT	WOEX 030204	0,62	15109
KUB-T.2,5D.0625.R.03.C0750-EF	V57 41590	0.625	0.750	1.130	5.125	1.563	2.875	1/8" NPT	WOEX 030204	0,62	15909
KUB-T.2,5D.0687.R.03.C0750-E	V57 41750	0.687	0.750	1.130	5.375	1.718	3.125	1/8" NPT	WOEX 030204	0,62	17509
KUB-T.2,5D.0703.R.03.C0750-EF	V57 41790	0.703	0.750	1.130	5.375	1.758	3.125	1/8" NPT	WOEX 030204	0,62	17909
KUB-T.2,5D.0750.R.03.C0750-EF	V57 41910	0.750	0.750	1.130	5.375	1.875	3.125	1/8" NPT	WOEX 030204	0,62	19109

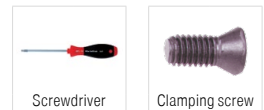

Screwdriver

Clamping screw

80 950 ...

10 950 ...

Spare parts

DC
0.562 - 0.750

123

10000

Matching holders can be found in our Online-Shop at cuttingtools.ceratzit.com and in the metric clamping technology catalog

KUB Trigon – Indexable insert drill

Scope of supply:

Indexable Insert Drill incl. clamping screws

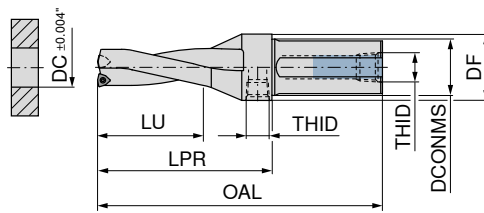
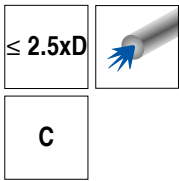

15 896 ...

Designation	KOMET no.	DC inch	DCONMS inch	DF inch	OAL inch	LU inch	LPR inch	THID inch	Insert	torque moment Nm	
KUB-T.2,5D.0562.R.03.C1250-EF	V57 51434	0.562	1.250	1.575	6.125	1.405	2.875	1/8" NPT	WOEX 030204	0,62	14301
KUB-T.2,5D.0593.R.03.C1250-EF	V57 51512	0.593	1.250	1.575	6.125	1.483	2.875	1/8" NPT	WOEX 030204	0,62	15101
KUB-T.2,5D.0625.R.03.C1250-EF	V57 51592	0.625	1.250	1.575	6.125	1.563	2.875	1/8" NPT	WOEX 030204	0,62	15901
KUB-T.2,5D.0656.R.03.C1250-EF	V57 51672	0.656	1.250	1.575	6.375	1.718	3.125	1/8" NPT	WOEX 030204	0,62	16701
KUB-T.2,5D.0687.R.03.C1250-E	V57 51752	0.687	1.250	1.575	6.375	1.718	3.125	1/8" NPT	WOEX 030204	0,62	17501
KUB-T.2,5D.0703.R.03.C1250-EF	V57 51792	0.703	1.250	1.575	6.375	1.758	3.125	1/8" NPT	WOEX 030204	0,62	17901
KUB-T.2,5D.0750.R.03.C1250-EF	V57 51912	0.750	1.250	1.575	6.375	1.625	3.125	1/8" NPT	WOEX 030204	0,62	19101
KUB-T.2,5D.0765.R.03.C1250-EF	V57 51942	0.765	1.250	1.575	6.375	1.625	3.125	1/8" NPT	WOEX 030204	0,62	19401
KUB-T.2,5D.0781.R.03.C1250-EF	V57 51982	0.781	1.250	1.575	6.375	1.625	3.125	1/8" NPT	WOEX 030204	0,62	19801
KUB-T.2,5D.0812.R.04.C1250-EF	V57 52062	0.812	1.250	1.575	6.375	1.625	3.125	1/8" NPT	WOEX 040304	1,01	20601
KUB-T.2,5D.0828.R.04.C1250-E	V57 52102	0.828	1.250	1.575	6.875	2.000	3.625	1/8" NPT	WOEX 040304	1,01	21001
KUB-T.2,5D.0843.R.04.C1250-EF	V57 52142	0.843	1.250	1.575	6.875	2.000	3.625	1/8" NPT	WOEX 040304	1,01	21401
KUB-T.2,5D.0875.R.04.C1250-EF	V57 52222	0.875	1.250	1.575	6.875	2.000	3.625	1/8" NPT	WOEX 040304	1,01	22201
KUB-T.2,5D.0906.R.04.C1250-E	V57 52302	0.906	1.250	1.575	6.875	2.000	3.625	1/8" NPT	WOEX 040304	1,01	23001
KUB-T.2,5D.0937.R.04.C1250-EF	V57 52382	0.937	1.250	1.575	6.875	2.000	3.625	1/8" NPT	WOEX 040304	1,01	23801
KUB-T.2,5D.0985.R.05.C1250-E	V57 52502	0.985	1.250	1.575	6.875	2.000	3.625	1/8" NPT	WOEX 05T304	1,28	25001
KUB-T.2,5D.1000.R.05.C1250-EF	V57 52542	1.000	1.250	1.575	6.875	2.000	3.625	1/8" NPT	WOEX 05T304	1,28	25401
KUB-T.2,5D.1031.R.05.C1250-EF	V57 52622	1.031	1.250	1.575	7.562	2.750	4.312	1/8" NPT	WOEX 05T304	1,28	26201
KUB-T.2,5D.1062.R.05.C1250-E	V57 52702	1.062	1.250	1.575	7.562	2.750	4.312	1/8" NPT	WOEX 05T304	1,28	27001
KUB-T.2,5D.1109.R.05.C1250-EF	V57 52822	1.109	1.250	1.575	7.562	2.750	4.312	1/8" NPT	WOEX 05T304	1,28	28201
KUB-T.2,5D.1125.R.05.C1250-EF	V57 52862	1.125	1.250	1.575	7.562	2.750	4.312	1/8" NPT	WOEX 05T304	1,28	28601
KUB-T.2,5D.1156.R.05.C1250-EF	V57 52942	1.156	1.250	1.575	8.250	3.250	5.000	1/8" NPT	WOEX 05T304	1,28	29401
KUB-T.2,5D.1187.R.05.C1250-EF	V57 53022	1.187	1.250	1.575	8.250	3.250	5.000	1/8" NPT	WOEX 05T304	1,28	30101
KUB-T.2,5D.1218.R.05.C1250-EF	V57 53092	1.218	1.250	1.575	8.250	3.250	5.000	1/8" NPT	WOEX 05T304	1,28	30901
KUB-T.2,5D.1250.R.05.C1250-EF	V57 53182	1.250	1.250	1.575	8.250	3.250	5.000	1/8" NPT	WOEX 05T304	1,28	31801
KUB-T.2,5D.1281.R.05.C1250-E	V57 53252	1.281	1.250	1.575	8.250	3.250	5.000	1/8" NPT	WOEX 05T304	1,28	32501
KUB-T.2,5D.1312.R.05.C1250-EF	V57 53332	1.312	1.250	1.575	8.250	3.250	5.000	1/8" NPT	WOEX 05T304	1,28	33301
KUB-T.2,5D.1328.R.05.C1250-EF	V57 53372	1.328	1.250	1.575	8.250	3.250	5.000	1/8" NPT	WOEX 05T304	1,28	33701
KUB-T.2,5D.1375.R.05.C1250-EF	V57 53492	1.375	1.250	1.575	8.250	3.250	5.000	1/8" NPT	WOEX 05T304	1,28	34901
KUB-T.2,5D.1406.R.05.C1250-EF	V57 53572	1.406	1.250	1.575	8.250	3.250	5.000	1/8" NPT	WOEX 05T304	1,28	35701
KUB-T.2,5D.1437.R.05.C1250-E	V57 53652	1.437	1.250	1.575	8.250	3.250	5.000	1/8" NPT	WOEX 05T304	1,28	36501
KUB-T.2,5D.1469.R.06.C1250-EF	V57 53732	1.469	1.250	1.575	8.368	3.500	5.118	1/8" NPT	WOEX 06T304	2,8	37301
KUB-T.2,5D.1500.R.06.C1250-EF	V57 53812	1.500	1.250	1.575	8.368	3.500	5.118	1/8" NPT	WOEX 06T304	2,8	38101
KUB-T.2,5D.1531.R.06.C1250-EF	V57 53892	1.531	1.250	1.575	8.368	3.500	5.118	1/8" NPT	WOEX 06T304	2,8	38911
KUB-T.2,5D.1562.R.06.C1250-EF	V57 53972	1.562	1.250	1.575	8.368	3.500	5.118	1/8" NPT	WOEX 06T304	2,8	39701
KUB-T.2,5D.1625.R.06.C1250-EF	V57 54132	1.625	1.250	1.575	8.368	3.500	5.118	1/8" NPT	WOEX 06T304	2,8	41301
KUB-T.2,5D.1656.R.06.C1500-EF	V57 54212	1.656	1.500	1.970	10.709	4.000	5.709	1/4" NPT	WOEX 06T304	2,8	42102
KUB-T.2,5D.1687.R.06.C1500-EF	V57 54262	1.687	1.500	1.970	10.709	4.000	5.709	1/4" NPT	WOEX 06T304	2,8	42802
KUB-T.2,5D.1750.R.06.C1500-EF	V57 54452	1.750	1.500	1.970	10.709	4.000	5.709	1/4" NPT	WOEX 06T304	2,8	44502

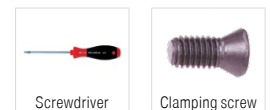

80 950 ...

10 950 ...

Spare parts

DC		
0.562 - 0.781	123	10000
0.812 - 0.937	123	10700
0.985 - 1.437	125	10500
1.469 - 1.750	127	10600

Matching holders can be found in our Online-Shop at cuttingtools.ceratizit.com and in the metric clamping technology catalog

KUB Trigon – Indexable insert drill

Scope of supply:

with indexable insert (10 897 ...) incl. fixing screw, cylindrical pin and clamping screw
with indexable insert (10 898 ...) incl. fixing screw, cylindrical pin and clamping screw

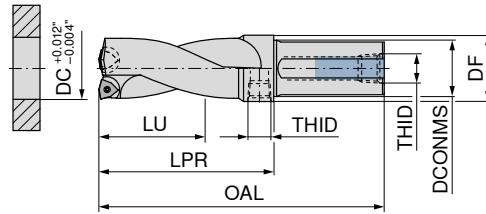
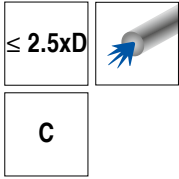

15 896 ...

Designation	KOMET no.	DC inch	DCONMS inch	DF inch	OAL inch	LU inch	LPR inch	THID inch	Insert	torque moment Nm	
KUB-T.2,5D.1812.R.08.C1500-E	V57 34602	1.812	1.500	1.969	10.709	4.000	5.709	1/4" NPT	WOEX 080404	4,3	46002
KUB-T.2,5D.1875.R.08.C1500-EF	V57 34762	1.875	1.500	1.969	10.709	4.000	5.709	1/4" NPT	WOEX 080404	4,3	47602
KUB-T.2,5D.1937.R.08.C1500-EF	V57 34922	1.937	1.500	1.969	11.890	5.000	6.890	1/4" NPT	WOEX 080404	4,3	49202
KUB-T.2,5D.2000.R.08.C1500-EF	V57 35082	2.000	1.500	1.969	11.890	5.000	6.890	1/4" NPT	WOEX 080404	4,3	50802
KUB-T.2,5D.2125.R.08.C1500-E	V57 35402	2.125	1.500	2.067	11.890	5.000	6.890	1/4" NPT	WOEX 080404	4,3	54002
KUB-T.2,5D.2250.R.10.C2000-EF	V57 35722	2.250	2.000	2.362	11.890	5.000	6.890	1/4" NPT	WOEX 100504	4,3	57204
KUB-T.2,5D.2375.R.10.C2000-EF	V57 36032	2.375	2.000	2.362	11.890	5.000	6.890	1/4" NPT	WOEX 100504	4,3	60304
KUB-T.2,5D.2500.R.10.C2000-EF	V57 36352	2.500	2.000	2.492	11.890	5.000	6.890	1/4" NPT	WOEX 100504	4,3	63504
KUB-T.2,5D.2750.R.12.C2000-EF	V57 36992	2.750	2.000	2.657	13.268	6.000	8.267	1/4" NPT	WOEX 120608	6,25	69904
KUB-T.2,5D.3000.R.12.C2000-EF	V57 37622	3.000	2.000	2.933	13.268	6.000	8.267	1/4" NPT	WOEX 120608	6,25	76204
KUB-T.2,5D.3250.R.12.C2000-EF	V57 38262	3.250	2.000	3.130	13.268	6.000	8.267	1/4" NPT	WOEX 120608	6,25	82604

	Cylindrical pin	Indexable insert, internal	Indexable insert, external	Screwdriver	Clamping screw	Fixing screw
	10 950 ...	10 897 ...	10 898 ...	80 950 ...	10 950 ...	10 950 ...
Spare parts						
DC						
1.812 - 2.125		17200	14800	120	12700	17000
2.250 - 2.500		17200	25300	120	12700	17000
2.750 - 3.250		17300	36000	121	17400	17100

Matching holders can be found in our Online-Shop at cuttingtools.ceratizit.com and in the metric clamping technology catalog

KUB Trigon – Indexable insert drill

Scope of supply:

Indexable Insert Drill incl. clamping screws

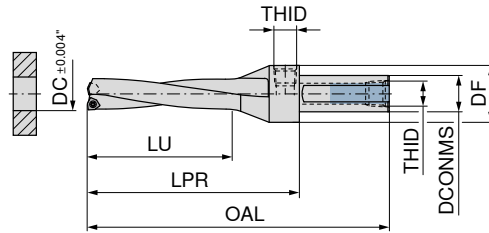
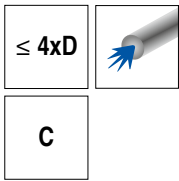

15 894 ...

Designation	KOMET no.	DC inch	DCONMS inch	DF inch	OAL inch	LU inch	LPR inch	THID inch	Insert	torque moment Nm	
KUB-T.4D.0562.R.03.C0750-EF	V57 61432	0.562	0.750	1.130	5.875	2.248	3.625	1/8" NPT	WOEX 030204	0,62	14309
KUB-T.4D.0593.R.03.C0750-EF	V57 61510	0.593	0.750	1.130	6.000	2.372	3.750	1/8" NPT	WOEX 030204	0,62	15109
KUB-T.4D.0625.R.03.C0750-EF	V57 61590	0.625	0.750	1.130	6.128	2.500	3.878	1/8" NPT	WOEX 030204	0,62	15909
KUB-T.4D.0687.R.03.C0750-E	V57 61750	0.687	0.750	1.130	6.376	2.748	4.126	1/8" NPT	WOEX 030204	0,62	17509
KUB-T.4D.0703.R.03.C0750-EF	V57 61790	0.703	0.750	1.130	6.439	2.812	4.189	1/8" NPT	WOEX 030204	0,62	17909
KUB-T.4D.0750.R.03.C0750-EF	V57 61910	0.750	0.750	1.130	6.628	3.000	4.378	1/8" NPT	WOEX 030204	0,62	19109

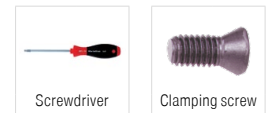

80 950 ...

10 950 ...

Spare parts
DC
0.562 - 0.750

123

10000

Matching holders can be found in our Online-Shop at cuttingtools.ceratizit.com and in the metric clamping technology catalog

KUB Trigon – Indexable insert drill

Scope of supply:

Indexable Insert Drill incl. clamping screws

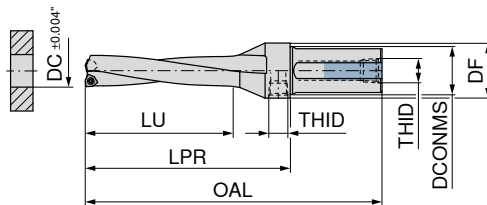
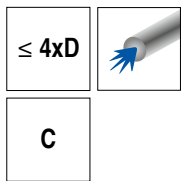

15 894 ...

Designation	KOMET no.	DC inch	DCONMS inch	DF inch	OAL inch	LU inch	LPR inch	THID inch	Insert	torque moment Nm	
KUB-T.4D.0562.R.03.C1250-EF	V57 71434	0.562	1.250	1.575	6.875	2.248	3.625	1/8" NPT	WOEX 030204	0,62	14301
KUB-T.4D.0593.R.03.C1250-EF	V57 71512	0.593	1.250	1.575	7.000	2.372	3.750	1/8" NPT	WOEX 030204	0,62	15101
KUB-T.4D.0625.R.03.C1250-EF	V57 71592	0.625	1.250	1.575	7.128	2.500	3.878	1/8" NPT	WOEX 030204	0,62	15901
KUB-T.4D.0656.R.03.C1250-EF	V57 71672	0.656	1.250	1.575	7.252	2.624	4.002	1/8" NPT	WOEX 030204	0,62	16701
KUB-T.4D.0687.R.03.C1250-E	V57 71752	0.687	1.250	1.575	7.376	2.748	4.126	1/8" NPT	WOEX 030204	0,62	17501
KUB-T.4D.0703.R.03.C1250-EF	V57 71792	0.703	1.250	1.575	7.439	2.812	4.189	1/8" NPT	WOEX 030204	0,62	17901
KUB-T.4D.0750.R.03.C1250-EF	V57 71912	0.750	1.250	1.575	7.628	3.000	4.378	1/8" NPT	WOEX 030204	0,62	19101
KUB-T.4D.0765.R.03.C1250-EF	V57 71942	0.765	1.250	1.575	7.688	3.060	4.438	1/8" NPT	WOEX 030204	0,62	19401
KUB-T.4D.0781.R.03.C1250-EF	V57 71982	0.781	1.250	1.575	7.752	3.124	4.502	1/8" NPT	WOEX 030204	0,62	19801
KUB-T.4D.0812.R.04.C1250-EF	V57 72062	0.812	1.250	1.575	7.876	3.248	4.626	1/8" NPT	WOEX 040304	1,01	20601
KUB-T.4D.0828.R.04.C1250-E	V57 72102	0.828	1.250	1.575	7.940	3.312	4.690	1/8" NPT	WOEX 040304	1,01	21001
KUB-T.4D.0843.R.04.C1250-EF	V57 72142	0.843	1.250	1.575	8.000	3.372	4.750	1/8" NPT	WOEX 040304	1,01	21401
KUB-T.4D.0875.R.04.C1250-EF	V57 72222	0.875	1.250	1.575	8.128	3.500	4.878	1/8" NPT	WOEX 040304	1,01	22201
KUB-T.4D.0906.R.04.C1250-E	V57 72302	0.906	1.250	1.575	8.252	3.624	5.002	1/8" NPT	WOEX 040304	1,01	23001
KUB-T.4D.0937.R.04.C1250-EF	V57 72382	0.937	1.250	1.575	8.376	3.748	5.126	1/8" NPT	WOEX 040304	1,01	23801
KUB-T.4D.0985.R.05.C1250-E	V57 72502	0.985	1.250	1.575	8.568	3.940	5.318	1/8" NPT	WOEX 05T304	1,28	25001
KUB-T.4D.1000.R.05.C1250-EF	V57 72542	1.000	1.250	1.575	8.628	4.000	5.378	1/8" NPT	WOEX 05T304	1,28	25401
KUB-T.4D.1031.R.05.C1250-EF	V57 72622	1.031	1.250	1.575	8.752	4.124	5.502	1/8" NPT	WOEX 05T304	1,28	26201
KUB-T.4D.1062.R.05.C1250-E	V57 72702	1.062	1.250	1.575	8.876	4.248	5.626	1/8" NPT	WOEX 05T304	1,28	27001
KUB-T.4D.1109.R.05.C1250-EF	V57 72822	1.109	1.250	1.575	9.064	4.436	5.814	1/8" NPT	WOEX 05T304	1,28	28201
KUB-T.4D.1125.R.05.C1250-EF	V57 72862	1.125	1.250	1.575	9.128	4.500	5.878	1/8" NPT	WOEX 05T304	1,28	28601
KUB-T.4D.1156.R.05.C1250-EF	V57 72942	1.156	1.250	1.575	9.252	4.624	6.002	1/8" NPT	WOEX 05T304	1,28	29401
KUB-T.4D.1187.R.05.C1250-EF	V57 73022	1.187	1.250	1.575	9.589	4.748	6.339	1/8" NPT	WOEX 05T304	1,28	30101
KUB-T.4D.1218.R.05.C1250-EF	V57 73092	1.218	1.250	1.575	9.713	4.872	6.463	1/8" NPT	WOEX 05T304	1,28	30901
KUB-T.4D.1250.R.05.C1250-EF	V57 73182	1.250	1.250	1.575	9.841	5.000	6.591	1/8" NPT	WOEX 05T304	1,28	31801
KUB-T.4D.1281.R.05.C1250-E	V57 73252	1.281	1.250	1.575	9.965	5.124	6.715	1/8" NPT	WOEX 05T304	1,28	32501
KUB-T.4D.1312.R.05.C1250-EF	V57 73332	1.312	1.250	1.575	10.089	5.248	6.839	1/8" NPT	WOEX 05T304	1,28	33301
KUB-T.4D.1328.R.05.C1250-EF	V57 73372	1.328	1.250	1.575	10.137	5.312	6.887	1/8" NPT	WOEX 05T304	1,28	33701
KUB-T.4D.1375.R.05.C1250-EF	V57 73492	1.375	1.250	1.575	10.341	5.500	7.091	1/8" NPT	WOEX 05T304	1,28	34901
KUB-T.4D.1406.R.05.C1250-EF	V57 73572	1.406	1.250	1.575	10.449	5.624	7.199	1/8" NPT	WOEX 05T304	1,28	35701
KUB-T.4D.1437.R.05.C1250-E	V57 73652	1.437	1.250	1.575	10.589	5.748	7.339	1/8" NPT	WOEX 05T304	1,28	36501
KUB-T.4D.1469.R.06.C1250-EF	V57 73732	1.469	1.250	1.575	11.095	5.876	7.845	1/8" NPT	WOEX 06T304	2,8	37301
KUB-T.4D.1500.R.06.C1250-EF	V57 73812	1.500	1.250	1.575	11.219	6.000	7.969	1/8" NPT	WOEX 06T304	2,8	38101
KUB-T.4D.1531.R.06.C1250-EF	V57 73892	1.531	1.250	1.575	11.343	6.124	8.093	1/8" NPT	WOEX 06T304	2,8	38901
KUB-T.4D.1562.R.06.C1250-EF	V57 73972	1.562	1.250	1.575	11.467	6.248	8.217	1/8" NPT	WOEX 06T304	2,8	39701
KUB-T.4D.1625.R.06.C1250-EF	V57 74132	1.625	1.250	1.575	11.719	6.500	8.469	1/8" NPT	WOEX 06T304	2,8	41301
KUB-T.4D.1656.R.06.C1500-EF	V57 74212	1.656	1.500	1.970	13.593	6.624	8.593	1/4" NPT	WOEX 06T304	2,8	42102
KUB-T.4D.1687.R.06.C1500-EF	V57 74292	1.687	1.500	1.970	13.717	6.748	8.717	1/4" NPT	WOEX 06T304	2,8	42802
KUB-T.4D.1750.R.06.C1500-EF	V57 74452	1.750	1.500	1.970	13.969	7.000	8.969	1/4" NPT	WOEX 06T304	2,8	44502

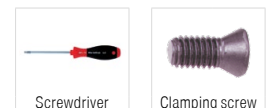

80 950 ...

10 950 ...

Spare parts

DC		
0.562 - 0.781	123	10000
0.812 - 0.937	123	10700
0.985 - 1.437	125	10500
1.469 - 1.750	127	10600

Matching holders can be found in our Online-Shop at cuttingtools.ceratizit.com and in the metric clamping technology catalog

KUB Centron – basic element

▲ KLG = Coupling Size



ABS

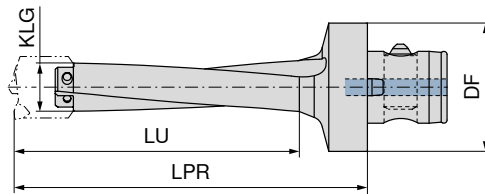

10 864 ...

Designation	KOMET no.	DF inch	LU inch	LPR inch	KLG	
KUB-C.GH.4D.190-ABS50	V47 20201	1.969	4.449	5.709	19	19095
KUB-C.GH.4D.250-ABS50	V47 20261	1.969	5.118	6.299	25	25095
KUB-C.GH.4D.320-ABS50	V47 20331	1.969	6.299	7.677	32	32095
KUB-C.GH.4D.385-ABS63	V47 20401	2.480	7.283	9.252	38,5	38596
KUB-C.GH.4D.445-ABS80	V47 20461	3.150	8.465	11.024	44,5	44598
KUB-C.GH.4D.535-ABS80	V47 20551	3.150	10.236	12.795	53,5	53598



ABS

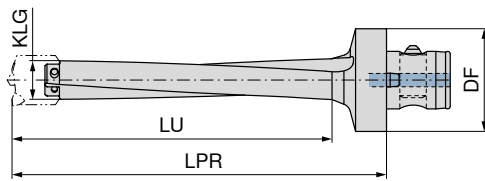

10 866 ...

Designation	KOMET no.	DF inch	LU inch	LPR inch	KLG	
KUB-C.GH.6D.190-ABS50	V47 40201	1.969	5.906	7.283	19	19095
KUB-C.GH.6D.250-ABS50	V47 40261	1.969	6.890	8.268	25	25095
KUB-C.GH.6D.320-ABS50	V47 40331	1.969	8.465	10.039	32	32095
KUB-C.GH.6D.385-ABS63	V47 40401	2.480	10.236	12.205	38,5	38596
KUB-C.GH.6D.445-ABS80	V47 40461	3.150	12.205	14.764	44,5	44598
KUB-C.GH.6D.535-ABS80	V47 40551	3.150	14.567	17.126	53,5	53598



ABS

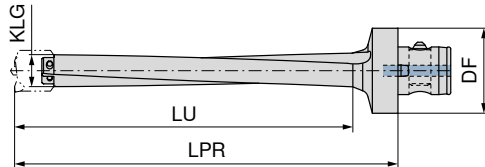

10 869 ...

Designation	KOMET no.	DF inch	LU inch	LPR inch	KLG	
KUB-C.GH.9D.190-ABS50	V47 60201	1.969	7.874	9.252	19	19095
KUB-C.GH.9D.250-ABS50	V47 60261	1.969	9.055	10.236	25	25095
KUB-C.GH.9D.320-ABS50	V47 60331	1.969	11.417	12.992	32	32095
KUB-C.GH.9D.385-ABS63	V47 60401	2.480	13.386	15.354	38,5	38596
KUB-C.GH.9D.445-ABS80	V47 60461	3.150	16.339	18.898	44,5	44598
KUB-C.GH.9D.535-ABS80	V47 60551	3.150	19.488	22.047	53,5	53598

For correct assembly, please observe the operating instructions provided.

Matching holders can be found in our Online-Shop at cuttingtools.ceratizit.com and in the metric clamping technology catalog

KUB Centron – drill head Ø 0.812–2.500 Inch

- ▲ The pre-assembled drill head is ready to use
- ▲ The indexable inserts and centering tip must be professionally assembled
- ▲ Tightening torque refers to the clamping screw of the indexable inserts
- ▲ KLG = Coupling size

Scope of supply:

- ▲ Drill head incl. screws, guide pads and shim set
- ▲ Order centering tip and indexable inserts separately

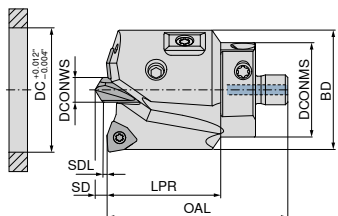

NEW



15 860 ...

Designation	KOMET no.	DC inch	OAL inch	LPR inch	SD inch	BD inch	SDL inch	DCONMS inch	DCONWS inch	KLG	torque moment Nm	Insert	
KUB-C.BK.0812.R.03.19-F	V46 52060	0.812	1.440	0.910	0.089	0.768	0.039	0.748	0.197	19	0,62	WOEX 030204	20600
KUB-C.BK.0875.R.03.19-F	V46 52220	0.875	1.440	0.910	0.089	0.835	0.039	0.748	0.197	19	0,62	WOEX 030204	22200
KUB-C.BK.1000.R.03.19-F	V46 52540	1.000	1.440	0.910	0.089	0.961	0.039	0.748	0.197	19	0,62	WOEX 030204	25400
KUB-C.BK.1125.R.04.25-F	V46 52860	1.125	1.500	0.910	0.104	1.083	0.043	0.984	0.236	25	1,01	WOEX 040304	28600
KUB-C.BK.1250.R.04.25-F	V46 53180	1.250	1.500	0.910	0.104	1.211	0.043	0.984	0.236	25	1,01	WOEX 040304	31800
KUB-C.BK.1375.R.05.32-F	V46 53490	1.375	1.540	0.910	0.104	1.335	0.043	1.260	0.236	32	1,28	WOEX 05T304	34900
KUB-C.BK.1500.R.05.32-F	V46 53810	1.500	1.540	0.910	0.104	1.461	0.043	1.260	0.236	32	1,28	WOEX 05T304	38100
KUB-C.BK.1625.R.05.38,5-F	V46 54130	1.625	1.700	0.980	0.133	1.567	0.049	1.516	0.315	38,5	1,28	WOEX 05T304	41300
KUB-C.BK.1750.R.05.38,5-F	V46 54450	1.750	1.700	0.980	0.133	1.689	0.049	1.516	0.315	38,5	1,28	WOEX 05T304	44500
KUB-C.BK.1875.R.06.44,5-F	V46 54760	1.875	1.850	0.980	0.152	1.815	0.049	1.752	0.394	44,5	2,8	WOEX 06T304	47600
KUB-C.BK.2000.R.06.44,5-F	V46 55080	2.000	1.850	0.980	0.152	1.941	0.049	1.752	0.394	44,5	2,8	WOEX 06T304	50800
KUB-C.BK.2250.R.08.53,5-F	V46 55720	2.250	2.050	1.180	0.152	2.193	0.049	2.106	0.394	53,5	6,25	WOEX 080404	57200
KUB-C.BK.2375.R.08.53,5-F	V46 56030	2.375	2.050	1.180	0.152	2.315	0.049	2.106	0.394	53,5	6,25	WOEX 080404	60300
KUB-C.BK.2500.R.08.53,5-F	V46 56350	2.500	2.050	1.180	0.150	2.441	0.049	2.106	0.394	53,5	6,25	WOEX 080404	63500



Guide pad clamping screw



Indexable insert clamping screw

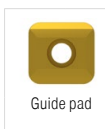

Guide pad

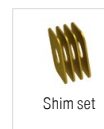

Shim set

10 950 ...

Spare parts

DC						
0.812 - 1.000		M2,5x4,2 - 8IP - 1,28Nm	11900	M2,0x4,3 - 06IP	10000	14600 15200
1.125 - 1.250		M2,5x4,5 - 8IP - 1,28Nm	11700	M2,2x5,5 - 06IP	10700	14700 15200
1.375 - 1.750		M2,5x4,5 - 8IP - 1,28Nm	11700	M2,5x7,2 - 08IP	10500	14800 15200
1.875 - 2.000		M3,5x5,0 - 8IP - 2,25Nm	11800	M3,5x7,3 - 10IP	10600	15000 15300
2.250 - 2.500		M3,5x5,0 - 8IP - 2,25Nm	11800	M4,5x9 - 15IP	12700	15100 15300

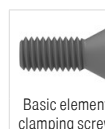

Basic element clamping screw

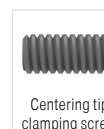

Centering tip clamping screw

10 950 ...

Spare parts

DC				
0.812 - 1.000		M2,5x6,4 - 08IP - 1,28Nm	12400	M4x6 - SW2 - 1,5Nm 12800
1.125 - 1.250		M3x7,4 - 08IP - 2,25Nm	12500	M5x10 - SW2,5 - 2,5Nm 13000
1.375 - 1.750		M4x8,9 - 15IP - 4,3Nm	12000	M5x12 - SW2,5 - 2,5Nm 13100
1.875 - 2.000		M5x11,5 - 20IP - 6,25Nm	12100	M8x16 - SW4 - 8Nm 13300
2.250 - 2.500		M5,5x14 - 20IP - 6,25Nm	12200	M8x16 - SW4 - 8Nm 13300

Exploded drawing of the drill head \varnothing 0.812–2.500 inch

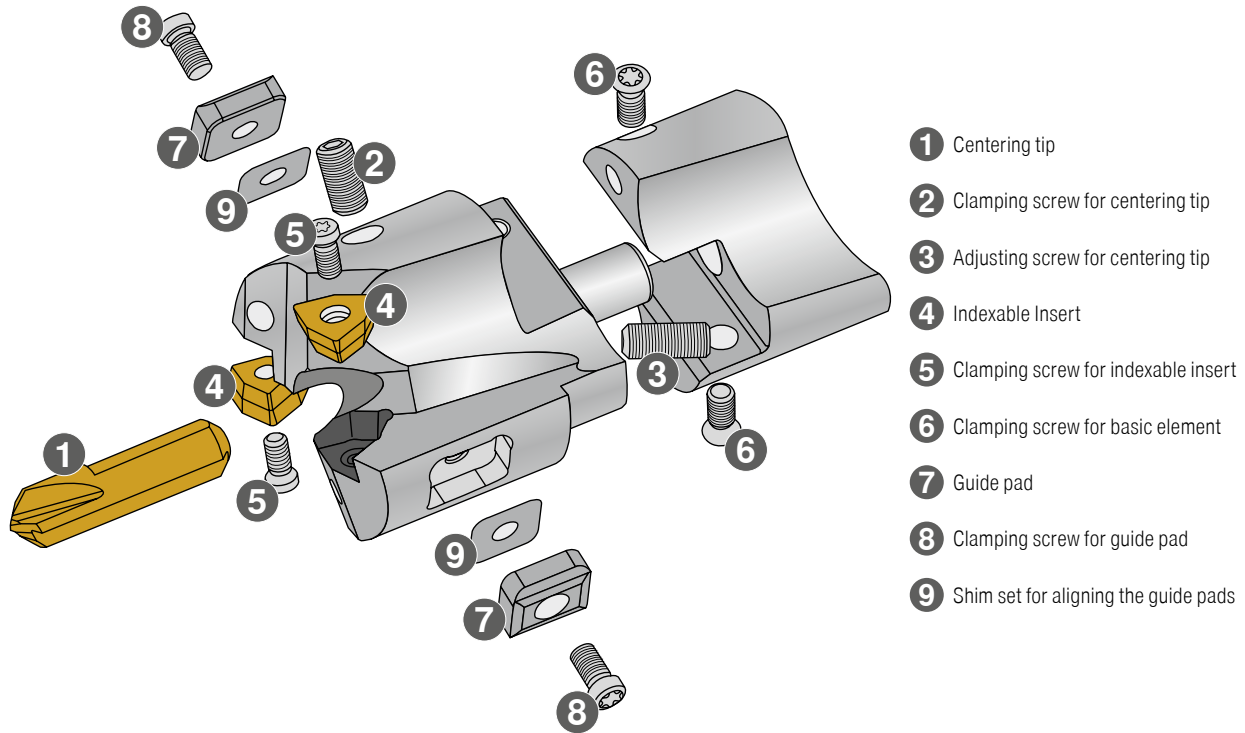

 For correct assembly, please observe the operating instructions provided.

KUB Centron – centering tip

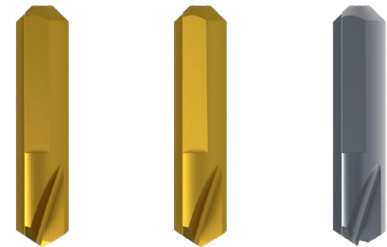
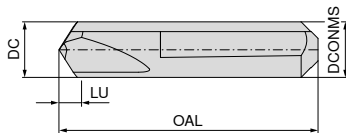
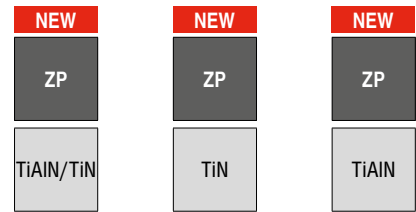

DC inch	KOMET no.	OAL inch	LU inch	DCONMS inch	120°		
					Solid carbide 10 863 ...	HSS 10 862 ...	HSS 10 862 ...
0.197	V95 10012.0089	0.846	0.089	0.197		00500	
0.197	V95 10012.0090	0.846	0.089	0.197			10500
0.197	V95 10310.8450	0.846	0.089	0.197	20500		
0.236	V95 10022.0089	0.906	0.104	0.236		00600	
0.236	V95 10022.0090	0.906	0.104	0.236			10600
0.236	V95 10320.8450	0.906	0.104	0.236	20600		
0.315	V95 10032.0089	1.063	0.133	0.315		00800	
0.315	V95 10032.0090	1.063	0.133	0.315			10800
0.315	V95 10330.8450	1.063	0.133	0.315	20800		
0.394	V95 10042.0089	1.102	0.152	0.394		01000	
0.394	V95 10042.0090	1.102	0.152	0.394			11000
0.394	V95 10340.8450	1.102	0.152	0.394	21000		
P					●	●	
M					●		●
K					●		●
N					●	●	
S					○		●
H							
O					○	○	

→ v_c Page 54+55

-  The cutting data of the KUB Centron depends on the centering tip and not on the indexable inserts. Please select the cutting data of the centering tip.

-  For correct assembly, please observe the operating instructions provided.

-  Article No. 10 863 ... is only suitable up to drilling depth 6xD.

WOEX

Designation	L inch	IC inch	S inch	D1 inch
WOEW 0201..	0.106	0.156	0.062	0.090
WOEX 0302..	0.125	0.196	0.090	0.090
WOEX 0403..	0.161	0.250	0.125	0.100
WOEX 05T3..	0.208	0.314	0.149	0.112
WOEX 06T3..	0.259	0.393	0.149	0.159
WOEX 0804..	0.311	0.472	0.188	0.192
WOEX 0804..	0.311	0.472	0.188	0.194
WOEX 1005..	0.389	0.590	0.208	0.192
WOEX 1206..	0.456	0.692	0.236	0.236

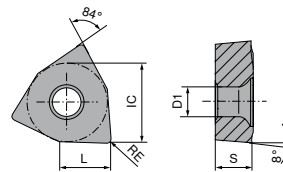

WOEX

ISO	KOMET no.	RE inch	<div style="display: flex; justify-content: space-around; align-items: center;"> <div style="text-align: center;"> <div style="border: 1px solid black; padding: 2px;">-01 BK8425</div> <div>WOEX</div> </div> <div style="text-align: center;"> <div style="border: 1px solid black; padding: 2px;">-03 BK8425</div> <div>WOEX</div> </div> <div style="text-align: center;"> <div style="border: 1px solid black; padding: 2px;">-13 BK8425</div> <div>WOEX</div> </div> <div style="text-align: center;"> <div style="border: 1px solid black; padding: 2px;">-01 BK7935</div> <div>WOEX</div> </div> <div style="text-align: center;"> <div style="border: 1px solid black; padding: 2px;">-01 BK6115</div> <div>WOEX</div> </div> </div>				
						10 821 ...	10 821 ...
030204	W29 10130.048425	0.016					
030204	W29 10010.046115	0.016					40301
030204	W29 10010.047935	0.016				50301	
030204	W29 10030.048425	0.016		30303			
030204	W29 10010.048425	0.016	30301				
040304	W29 18130.048425	0.016			30413		
040304	W29 18010.046115	0.016					40401
040304	W29 18010.047935	0.016				50401	
040304	W29 18030.048425	0.016		30403			
040304	W29 18010.048425	0.016	30401				
05T304	W29 24130.048425	0.016			30513		
05T304	W29 24010.046115	0.016					40501
05T304	W29 24010.047935	0.016				50501	
05T304	W29 24030.048425	0.016		30503			
05T304	W29 24010.048425	0.016	30501				
06T304	W29 34130.048425	0.016			30613		
06T304	W29 34010.046115	0.016					40601
06T304	W29 34010.047935	0.016				50601	
06T304	W29 34030.048425	0.016		30603			
06T304	W29 34010.048425	0.016	30601				
080404	W29 42130.048425	0.016			30813		
080404	W29 42010.046115	0.016					40801
080404	W29 42010.048425	0.016	30801				
100504	W29 50130.048425	0.016			31013		
100504	W29 50010.046115	0.016					41001
100504	W29 50010.048425	0.016	31001				
100508	W29 50010.088425	0.031	39001				
120608	W29 58130.088425	0.031			38213		
120608	W29 58010.086115	0.031					41201
P			●	●	●	●	●
M			●	●	●	●	●
K			●	●	●	●	●
N			○	○	○	○	○
S			○	○	○	●	○
H			○	○	○	○	○
O			○	○	○	○	○

→ v_c Page 48

BK8425 -03 and BK6115 -01 are exclusively recommended for use on the peripheral cutting edge!

WOEX

Designation	L inch	IC inch	S inch	D1 inch
WOEX 0302..	0.125	0.196	0.090	0.090
WOEX 0403..	0.161	0.250	0.125	0.100
WOEX 05T3..	0.208	0.314	0.149	0.112
WOEX 06T3..	0.259	0.393	0.149	0.159
WOEX 0804..	0.311	0.472	0.188	0.194

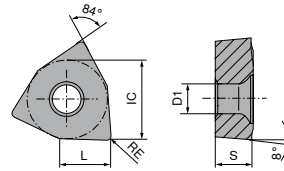

WOEX

	-01 BK7615	-01 BK62	-11 BK77	-13 BK79
	WOEX	WOEX	WOEX	WOEX
	10 821 ...	10 821 ...	10 821 ...	10 821 ...
ISO	KOMET no.	RE inch		
030204	W29 10010.0462	0.016		
030204	W29 10130.0479	0.016		20301
030204	W29 10110.0477	0.016		15313
030204	W29 10010.047615	0.016	05301	80311
040304	W29 18010.0462	0.016		
040304	W29 18130.0479	0.016		20401
040304	W29 18110.0477	0.016		15413
040304	W29 18010.047615	0.016	05401	80411
05T304	W29 24010.0462	0.016		
05T304	W29 24130.0479	0.016		20501
05T304	W29 24110.0477	0.016		15513
05T304	W29 24010.047615	0.016	05501	80511
06T304	W29 34010.0462	0.016		
06T304	W29 34130.0479	0.016		20601
06T304	W29 34110.0477	0.016		15613
06T304	W29 34010.047615	0.016	05601	80611
080404	W29 42010.0462	0.016		
080404	W29 42130.0479	0.016		20801
080404	W29 42110.0477	0.016		15813
080404	W29 42010.047615	0.016	05801	80811
100504	W29 50010.0462	0.016		
100504	W29 50130.0479	0.016		21001
100504	W29 50110.0477	0.016		16013
100508	W29 50010.087615	0.031	08001	81011
120608	W29 58010.087615	0.031	08201	
120608	W29 58130.0879	0.031		16213
120608	W29 58010.0862	0.031	28201	

P				●
M				●
K		●	●	●
N				○
S				●
H			○	○
O				○

→ v_c Page 48

Material examples for cutting data tables

	Material sub-group	Index	Composition / Structure / Heat treatment	Tensile strength lbf/in ² / HB / HRC	Material number	Material designation	Material number	Material designation
P	Unalloyed steel	P.1.1	< 0.15 % C Annealed	60900 lbf/in ² / 125 HB	1.0401	1015	1.0301	1010
		P.1.2	< 0.45 % C Annealed	92800 lbf/in ² / 190 HB	1.1191	1045	1.0737	12L14
		P.1.3	< 0.45 % C Tempered	121800 lbf/in ² / 250 HB	1.1191	1045	1.0503	1043
		P.1.4	< 0.75 % C Annealed	132000 lbf/in ² / 270 HB	1.1223	1060	1.0535	1055
		P.1.5	< 0.75 % C Tempered	146500 lbf/in ² / 300 HB	1.1223	1060	1.1274	1095
	Low-alloy steel	P.2.1	Annealed	88500 lbf/in ² / 180 HB	1.7131	5115	1.6523	8620
		P.2.2	Tempered	134900 lbf/in ² / 275 HB	1.7131	5115	1.6582	4340
		P.2.3	Tempered	146500 lbf/in ² / 300 HB	1.7225	4142	1.7131	5115
		P.2.4	Tempered	174000 lbf/in ² / 375 HB	1.7225	4142	1.7223	4140
	High-alloy steel and high-alloy tool steel	P.3.1	Annealed	98600 lbf/in ² / 200 HB	1.4021	420	1.2379	D2
		P.3.2	Hardened and tempered	159500 lbf/in ² / 300 HB	1.2343	H11	1.3343	M2
		P.3.3	Hardened and tempered	188500 lbf/in ² / 400 HB	1.2343	H11	1.2363	A2
	Stainless steel	P.4.1	Ferritic / martensitic Annealed	98600 lbf/in ² / 200 HB	1.4016	430	1.4125	440C
		P.4.2	Martensitic Tempered	117500 lbf/in ² / 250 HB	1.4112	S44003	1.4021	420
M	Stainless steel	M.1.1	Austenitic / austenitic-ferritic Quenched	88500 lbf/in ² / 200 HB	1.4301	304	1.4401	316
		M.2.1	Austenitic Tempered	300 HB	1.4841	314	1.4568	17-7 PH
		M.3.1	Austenitic / ferritic (Duplex)	113100 lbf/in ² / 230 HB	1.4462	S32205	1.4410	S32750
K	Grey cast iron	K.1.1	Pearlitic / ferritic	88500 lbf/in ² / 180 HB	0.6010	A48-20B	0.6025	A48-40 B
		K.1.2	Pearlitic (martensitic)	127600 lbf/in ² / 260 HB	0.6030	A48-45B	0.6040	A48-60 B
	Spherulitic graphite cast iron	K.2.1	Ferritic	78300 lbf/in ² / 160 HB	0.7040	60-40-18	0.7050	65-45-12
		K.2.2	Pearlitic	122600 lbf/in ² / 250 HB	0.7070	100-70-03	0.7660	A439 Type D2
	Malleable iron	K.3.1	Ferritic	63800 lbf/in ² / 130 HB	0.8035	GTW-35-04		
		K.3.2	Pearlitic	113100 lbf/in ² / 230 HB	0.8170	70003		
N	Aluminium wrought alloy	N.1.1	Non-hardenable	60 HB	3.0255	A91060	3.0255	A91060
		N.1.2	Hardenable	49300 lbf/in ² / 100 HB	3.1355	2024	3.1355	2024
	Cast aluminium alloy	N.2.1	≤ 12 % Si, non-hardenable	36300 lbf/in ² / 75 HB	3.2581	A04130 / A413-0	3.2581	A04130 / A413-0
		N.2.2	≤ 12 % Si, hardenable	43500 lbf/in ² / 90 HB	3.2134	G-AISi5Cu1Mg		
		N.2.3	> 12 % Si, non-hardenable	63800 lbf/in ² / 130 HB		G-AISi17Cu4Mg		
	Copper and copper alloys (bronze/brass)	N.3.1	Free-machining alloys, PB > 1 %	54400 lbf/in ² / 110 HB	2.0380	CuZn39Pb2 (Ms58)	2.0380	C37700
		N.3.2	CuZn, CuSnZn	43500 lbf/in ² / 90 HB	2.0331	CuZn15	2.0331	C34000
		N.3.3	CuSn, lead-free copper and electrolytic copper	49300 lbf/in ² / 100 HB	2.0060	E-Cu57		
	Magnesium alloys	N.4.1	Magnesium and magnesium alloys	70 HB	3.5612	MgAl6Zn		
	S	Heat-resistant alloys	S.1.1	Fe - basis Annealed	98600 lbf/in ² / 200 HB	1.4864	X12NiCrSi 36-16	1.4864
S.1.2			Fe - basis	137800 lbf/in ² / 280 HB	1.4980	X6NiCrTiMoVB25-15-2	1.4980	S66286
S.2.1			Annealed	121800 lbf/in ² / 250 HB	2.4856	Inconel 625	2.4812	Hastelloy C
S.2.2			Ni or Co basis	171100 lbf/in ² / 350 HB	2.4952	Nimonic 80A	2.4668	Inconel 718
S.2.3			Cast	156600 lbf/in ² / 320 HB	2.4674	Nimocast PK24	2.4670	Nimocast 713
Titanium alloys		S.3.1	Pure titanium	5800 lbf/in ²	3.7025	Ti99,8		
		S.3.2	Alpha + beta alloys	152300 lbf/in ²	3.7165	TiAl6V4		
		S.3.3	Beta alloys	203100 lbf/in ² / 410 HB	Ti555.3	Ti-5Al-5V-5Mo-3Cr		
H	Hardened steel	H.1.1	Hardened and tempered	46-55 HRC				
		H.1.2	Hardened and tempered	56-60 HRC				
		H.1.3	Hardened and tempered	61-65 HRC				
		H.1.4	Hardened and tempered	66-70 HRC				
	Chilled iron	H.2.1	Cast	400 HB				
	Hardened cast iron	H.3.1	Hardened and tempered	55 HRC				
O	Non-metal materials	O.1.1	Plastics, duroplastic	≤ 21800 lbf/in ²				
		O.1.2	Plastics, thermoplastic	≤ 14500 lbf/in ²				
		O.2.1	Aramid fibre-reinforced	≤ 145000 lbf/in ²				
		O.2.2	Glass/carbon-fibre reinforced	≤ 145000 lbf/in ²				
		O.3.1	Graphite					

* Tensile Strength at Rupture (Rm)

Cutting data standard values for SOGX indexable inserts

Index	SOGX 10 820 ...						
	-01 / -13 / -32 BK8425	-03 BK8430	-34 BK8425	-01 BK7935	-01 BK6115	-01 BK6425	-01 BK7710
	v _c in ft/min						
P.1.1	850	850		820	980	1050	
P.1.2	850	850	850	720	980	1050	
P.1.3	890	890		890	890	920	
P.1.4	820	820		820	820	820	
P.1.5	890	890	890	660	980	950	
P.2.1	890	890		890	890	920	
P.2.2	850	850		850	850	890	
P.2.3	590	590	590	520	790	850	
P.2.4	490	490	490	430	660	690	
P.3.1	520	520	520	460	660	720	
P.3.2	430	430	430	390	520	590	
P.3.3	390	390	390	360	460	520	
P.4.1	590	590		490	720	790	
P.4.2	430	430		390	520	590	
M.1.1	490	490		520	720	660	
M.2.1	490	490		520	720	660	
M.3.1	460	460		490	660	590	
K.1.1	520	520	520	490	790	660	
K.1.2	390	390	390	390	590	490	
K.2.1	520	520	520	490	520	520	
K.2.2	330	330	330	300	330	330	
K.3.1	390	390	390	360	390	390	
K.3.2	330	330	330	300	330	330	
N.1.1	1310	1310		1310			1640
N.1.2	1310	1310		1310			1640
N.2.1	820	820		820			920
N.2.2	820	820		820			920
N.2.3	750	750		750			820
N.3.1	660	660		660			820
N.3.2	720	720		720			920
N.3.3	1080	1080		1080			1280
N.4.1	660	660		660			820
S.1.1	200	200		200			
S.1.2	160	160		160			
S.2.1	200	200		200			
S.2.2	160	160		160			
S.2.3	100	100		100			
S.3.1	330	330		330			330
S.3.2	260	260		260			260
S.3.3	160	160		160			160
H.1.1	330	330			330		
H.1.2	260	260			260		
H.1.3	160	160			160		
H.1.4							
H.2.1	330	330			330		
H.3.1	260	260			260		
O.1.1				330			330
O.1.2				330			330
O.2.1							
O.2.2				330			330
O.3.1				330			330

 During the drilling operation on through holes a sharp disk will be produced. Safety precautions must be observed. A safety guard has to be provided as protection.

 In order to ensure efficient chip evacuation, coolant pressure must be at least 5 bar. Optimum pressure is > 15 bar.

Cutting data standard values for KUB Pentron – 4xD

ABS / C 10 874 ... / 15 874 ...												
Index	Ø 0.562-0.625	Ø 0.656-0.703	Ø 0.750-0.781	Ø 0.812-0.828	Ø 0.875-0.937	Ø 0.985-1.000	Ø 1.031-1.062	Ø 1.109-1.218	Ø 1.250-1.328	Ø 1.375-1.469	Ø 1.500-1.687	Ø 1.750
	inch	inch	inch	inch	inch	inch	inch	inch	inch	inch	inch	inch
f in inch/rev.												
P.1.1	0.002	0.003	0.003	0.004	0.004	0.004	0.004	0.004	0.004	0.004	0.004	0.004
P.1.2	0.003	0.005	0.005	0.006	0.006	0.006	0.007	0.007	0.007	0.007	0.007	0.007
P.1.3	0.002	0.005	0.005	0.005	0.005	0.005	0.005	0.005	0.005	0.005	0.005	0.005
P.1.4	0.002	0.004	0.004	0.005	0.005	0.005	0.005	0.005	0.005	0.005	0.005	0.005
P.1.5	0.003	0.005	0.005	0.006	0.006	0.006	0.006	0.006	0.006	0.006	0.006	0.006
P.2.1	0.002	0.005	0.005	0.005	0.005	0.005	0.005	0.005	0.005	0.005	0.005	0.005
P.2.2	0.002	0.004	0.004	0.005	0.005	0.005	0.005	0.005	0.005	0.005	0.005	0.005
P.2.3	0.003	0.006	0.006	0.006	0.006	0.007	0.007	0.007	0.007	0.007	0.007	0.007
P.2.4	0.002	0.004	0.004	0.005	0.005	0.006	0.006	0.006	0.006	0.006	0.006	0.006
P.3.1	0.003	0.005	0.005	0.006	0.006	0.007	0.007	0.007	0.007	0.007	0.007	0.007
P.3.2	0.002	0.004	0.004	0.005	0.005	0.006	0.006	0.006	0.006	0.006	0.006	0.006
P.3.3	0.002	0.003	0.003	0.004	0.004	0.005	0.005	0.005	0.005	0.005	0.005	0.005
P.4.1	0.004	0.005	0.005	0.007	0.007	0.008	0.008	0.008	0.008	0.008	0.008	0.008
P.4.2	0.002	0.004	0.004	0.005	0.005	0.006	0.006	0.006	0.006	0.006	0.006	0.006
M.1.1	0.003	0.004	0.004	0.005	0.006	0.006	0.006	0.006	0.006	0.006	0.006	0.006
M.2.1	0.003	0.003	0.003	0.004	0.004	0.006	0.006	0.006	0.006	0.006	0.006	0.006
M.3.1	0.003	0.003	0.003	0.004	0.004	0.005	0.005	0.005	0.005	0.005	0.005	0.005
K.1.1	0.005	0.006	0.006	0.007	0.007	0.009	0.010	0.010	0.010	0.010	0.010	0.010
K.1.2	0.004	0.004	0.004	0.004	0.004	0.008	0.008	0.008	0.008	0.008	0.008	0.008
K.2.1	0.005	0.006	0.006	0.007	0.007	0.009	0.010	0.010	0.010	0.010	0.010	0.010
K.2.2	0.004	0.005	0.005	0.006	0.006	0.007	0.008	0.008	0.008	0.008	0.008	0.008
K.3.1	0.005	0.006	0.006	0.007	0.007	0.009	0.010	0.010	0.010	0.010	0.010	0.010
K.3.2	0.004	0.005	0.005	0.006	0.006	0.007	0.008	0.008	0.008	0.008	0.008	0.008
N.1.1	0.004	0.004	0.004	0.004	0.005	0.005	0.005	0.005	0.005	0.005	0.005	0.005
N.1.2	0.004	0.004	0.004	0.004	0.005	0.005	0.005	0.005	0.005	0.005	0.005	0.005
N.2.1	0.004	0.005	0.005	0.005	0.006	0.006	0.006	0.006	0.006	0.006	0.006	0.006
N.2.2	0.004	0.005	0.005	0.005	0.006	0.006	0.006	0.006	0.006	0.006	0.006	0.006
N.2.3	0.004	0.005	0.005	0.005	0.006	0.006	0.006	0.006	0.006	0.006	0.006	0.006
N.3.1	0.004	0.005	0.005	0.005	0.006	0.006	0.006	0.006	0.006	0.006	0.006	0.006
N.3.2	0.004	0.005	0.006	0.006	0.007	0.007	0.007	0.007	0.007	0.007	0.007	0.007
N.3.3	0.004	0.005	0.005	0.006	0.006	0.006	0.006	0.006	0.006	0.006	0.006	0.006
N.4.1	0.004	0.005	0.005	0.005	0.006	0.006	0.006	0.006	0.006	0.006	0.006	0.006
S.1.1	0.001	0.001	0.001	0.001	0.002	0.002	0.002	0.002	0.002	0.002	0.002	0.002
S.1.2	0.001	0.001	0.001	0.001	0.002	0.002	0.002	0.002	0.002	0.002	0.002	0.002
S.2.1	0.001	0.001	0.001	0.001	0.002	0.002	0.002	0.002	0.002	0.002	0.002	0.002
S.2.2	0.001	0.001	0.001	0.001	0.002	0.002	0.002	0.002	0.002	0.002	0.002	0.002
S.2.3	0.001	0.001	0.001	0.001	0.001	0.001	0.002	0.002	0.002	0.002	0.002	0.002
S.3.1	0.002	0.002	0.002	0.002	0.002	0.003	0.004	0.004	0.004	0.004	0.004	0.004
S.3.2	0.002	0.002	0.002	0.002	0.002	0.003	0.004	0.004	0.004	0.004	0.004	0.004
S.3.3	0.001	0.001	0.001	0.001	0.002	0.002	0.002	0.002	0.002	0.002	0.002	0.002
H.1.1	0.002	0.002	0.002	0.002	0.002	0.002	0.002	0.002	0.002	0.002	0.002	0.002
H.1.2	0.001	0.001	0.001	0.001	0.002	0.002	0.002	0.002	0.002	0.002	0.002	0.002
H.1.3	0.001	0.001	0.001	0.001	0.002	0.002	0.002	0.002	0.002	0.002	0.002	0.002
H.1.4												
H.2.1	0.002	0.002	0.002	0.002	0.002	0.002	0.002	0.002	0.002	0.002	0.002	0.002
H.3.1	0.001	0.001	0.001	0.001	0.002	0.002	0.002	0.002	0.002	0.002	0.002	0.002
O.1.1	0.003	0.003	0.003	0.004	0.004	0.004	0.004	0.004	0.004	0.004	0.004	0.004
O.1.2	0.003	0.003	0.003	0.004	0.004	0.004	0.004	0.004	0.004	0.004	0.004	0.004
O.2.1												
O.2.2	0.002	0.002	0.002	0.002	0.003	0.003	0.003	0.003	0.003	0.003	0.003	0.003
O.3.1	0.004	0.004	0.004	0.004	0.004	0.004	0.004	0.004	0.004	0.004	0.004	0.004

 During the drilling operation on through holes a sharp disk will be produced. Safety precautions must be observed. A safety guard has to be provided as protection.

 In order to ensure efficient chip evacuation, coolant pressure must be at least 5 bar. Optimum pressure is > 15 bar.

Cutting data standard values for KUB Pentron – 5xD

ABS / C 10 875 ... / 15 875 ...												
Index	Ø 0.562-0.625	Ø 0.656-0.703	Ø 0.750-0.781	Ø 0.812-0.828	Ø 0.875-0.937	Ø 0.985-1.000	Ø 1.031-1.062	Ø 1.109-1.218	Ø 1.250-1.328	Ø 1.375-1.469	Ø 1.500-1.687	Ø 1.750
	inch	inch	inch	inch	inch	inch	inch	inch	inch	inch	inch	inch
f in inch/rev.												
P.1.1	0.002	0.003	0.003	0.004	0.004	0.004	0.004	0.004	0.004	0.004	0.004	0.004
P.1.2	0.003	0.004	0.004	0.005	0.005	0.005	0.006	0.006	0.006	0.006	0.006	0.006
P.1.3	0.002	0.004	0.004	0.004	0.004	0.004	0.004	0.004	0.004	0.004	0.004	0.004
P.1.4	0.002	0.004	0.004	0.004	0.004	0.004	0.004	0.004	0.004	0.004	0.004	0.004
P.1.5	0.003	0.004	0.004	0.005	0.005	0.005	0.006	0.006	0.006	0.006	0.006	0.006
P.2.1	0.002	0.004	0.004	0.004	0.004	0.004	0.004	0.004	0.004	0.004	0.004	0.004
P.2.2	0.002	0.004	0.004	0.004	0.004	0.004	0.004	0.004	0.004	0.004	0.004	0.004
P.2.3	0.003	0.004	0.004	0.006	0.007	0.007	0.006	0.006	0.006	0.006	0.006	0.006
P.2.4	0.002	0.003	0.003	0.005	0.006	0.006	0.005	0.005	0.005	0.005	0.005	0.005
P.3.1	0.003	0.005	0.005	0.006	0.006	0.007	0.007	0.007	0.007	0.007	0.007	0.007
P.3.2	0.002	0.004	0.004	0.005	0.005	0.006	0.006	0.006	0.006	0.006	0.006	0.006
P.3.3	0.002	0.003	0.003	0.004	0.004	0.005	0.005	0.005	0.005	0.005	0.005	0.005
P.4.1	0.004	0.005	0.005	0.007	0.007	0.008	0.008	0.008	0.008	0.008	0.008	0.008
P.4.2	0.002	0.004	0.004	0.005	0.005	0.006	0.006	0.006	0.006	0.006	0.006	0.006
M.1.1	0.003	0.003	0.003	0.004	0.004	0.006	0.004	0.004	0.004	0.004	0.004	0.004
M.2.1	0.003	0.003	0.003	0.004	0.004	0.005	0.005	0.005	0.005	0.005	0.005	0.005
M.3.1	0.003	0.003	0.003	0.003	0.003	0.004	0.004	0.004	0.004	0.004	0.004	0.004
K.1.1	0.004	0.005	0.005	0.006	0.006	0.008	0.009	0.009	0.009	0.009	0.009	0.009
K.1.2	0.003	0.004	0.004	0.005	0.005	0.006	0.007	0.007	0.007	0.007	0.007	0.007
K.2.1	0.004	0.005	0.005	0.006	0.006	0.008	0.009	0.009	0.009	0.009	0.009	0.009
K.2.2	0.003	0.004	0.004	0.005	0.005	0.006	0.007	0.007	0.007	0.007	0.007	0.007
K.3.1	0.004	0.005	0.005	0.006	0.006	0.008	0.009	0.009	0.009	0.009	0.009	0.009
K.3.2	0.003	0.004	0.004	0.005	0.005	0.006	0.007	0.007	0.007	0.007	0.007	0.007
N.1.1	0.004	0.004	0.004	0.005	0.005	0.005	0.005	0.005	0.005	0.005	0.005	0.005
N.1.2	0.004	0.004	0.004	0.005	0.005	0.005	0.005	0.005	0.005	0.005	0.005	0.005
N.2.1	0.004	0.005	0.005	0.005	0.006	0.006	0.006	0.006	0.006	0.006	0.006	0.006
N.2.2	0.004	0.005	0.005	0.005	0.006	0.006	0.006	0.006	0.006	0.006	0.006	0.006
N.2.3	0.004	0.005	0.005	0.005	0.006	0.006	0.006	0.006	0.006	0.006	0.006	0.006
N.3.1	0.004	0.005	0.005	0.005	0.006	0.006	0.006	0.006	0.006	0.006	0.006	0.006
N.3.2	0.004	0.006	0.006	0.006	0.007	0.007	0.007	0.007	0.007	0.007	0.007	0.007
N.3.3	0.004	0.005	0.005	0.005	0.006	0.006	0.006	0.006	0.006	0.006	0.006	0.006
N.4.1	0.004	0.005	0.005	0.005	0.006	0.006	0.006	0.006	0.006	0.006	0.006	0.006
S.1.1	0.001	0.001	0.001	0.001	0.002	0.002	0.002	0.002	0.002	0.002	0.002	0.002
S.1.2	0.001	0.001	0.001	0.001	0.002	0.002	0.002	0.002	0.002	0.002	0.002	0.002
S.2.1	0.001	0.001	0.001	0.001	0.002	0.002	0.002	0.002	0.002	0.002	0.002	0.002
S.2.2	0.001	0.001	0.001	0.001	0.002	0.002	0.002	0.002	0.002	0.002	0.002	0.002
S.2.3	0.001	0.001	0.001	0.001	0.001	0.001	0.002	0.002	0.002	0.002	0.002	0.002
S.3.1	0.002	0.002	0.002	0.002	0.002	0.003	0.004	0.004	0.004	0.004	0.004	0.004
S.3.2	0.002	0.002	0.002	0.002	0.002	0.003	0.004	0.004	0.004	0.004	0.004	0.004
S.3.3	0.001	0.001	0.001	0.001	0.002	0.002	0.002	0.002	0.002	0.002	0.002	0.002
H.1.1	0.002	0.002	0.002	0.002	0.002	0.002	0.002	0.002	0.002	0.002	0.002	0.002
H.1.2	0.001	0.001	0.001	0.001	0.002	0.002	0.002	0.002	0.002	0.002	0.002	0.002
H.1.3	0.001	0.001	0.001	0.001	0.002	0.002	0.002	0.002	0.002	0.002	0.002	0.002
H.1.4												
H.2.1	0.002	0.002	0.002	0.002	0.002	0.002	0.002	0.002	0.002	0.002	0.002	0.002
H.3.1	0.001	0.001	0.001	0.001	0.002	0.002	0.002	0.002	0.002	0.002	0.002	0.002
O.1.1	0.003	0.003	0.003	0.004	0.004	0.004	0.004	0.004	0.004	0.004	0.004	0.004
O.1.2	0.003	0.003	0.003	0.004	0.004	0.004	0.004	0.004	0.004	0.004	0.004	0.004
O.2.1												
O.2.2	0.002	0.002	0.002	0.002	0.003	0.003	0.003	0.003	0.003	0.003	0.003	0.003
O.3.1	0.004	0.004	0.004	0.004	0.004	0.004	0.004	0.004	0.004	0.004	0.004	0.004

 During the drilling operation on through holes a sharp disk will be produced. Safety precautions must be observed. A safety guard has to be provided as protection.

 In order to ensure efficient chip evacuation, coolant pressure must be at least 5 bar. Optimum pressure is > 15 bar.

Cutting data standard values for SOEX indexable inserts

Index	SOEX 10 822 ...					
	BK8425	BK7935	BK6115	BK7710	BK6420	BK7615
	v _c in ft/min					
P.1.1	850	820	980		980	
P.1.2	850	720	980		980	
P.1.3	890	890	890		890	
P.1.4	820	820	820		820	
P.1.5	890	660	980		890	
P.2.1	890	890	890		890	
P.2.2	850	850	850		850	
P.2.3	590	520	790		790	
P.2.4	490	430	660		620	
P.3.1	520	460	660		660	
P.3.2	430	390	520		520	
P.3.3	390	360	460		460	
P.4.1	590	490	720		720	
P.4.2	430	390	520		520	
M.1.1	490	520	720		720	
M.2.1	490	520	720		720	
M.3.1	460	490	660		660	
K.1.1	520	490	790		660	850
K.1.2	390	390	590		490	520
K.2.1	520	490	520		520	590
K.2.2	330	300	330		330	390
K.3.1	390	360	390		390	460
K.3.2	330	300	330		330	390
N.1.1	1310	1310		1640		
N.1.2	1310	1310		1640		
N.2.1	820	820		920		
N.2.2	820	820		920		
N.2.3	750	750		820		
N.3.1	660	660		820		
N.3.2	720	720		920		
N.3.3	1080	1080		1280		
N.4.1	660	660		820		
S.1.1	200	200				
S.1.2	160	160				
S.2.1	200	200				
S.2.2	160	160				
S.2.3	100	100				
S.3.1	330	330		330		
S.3.2	260	260		260		
S.3.3	160	160		160		
H.1.1	330		330			
H.1.2	260		260			
H.1.3	160		160			
H.1.4						
H.2.1	330		330			
H.3.1	260		260			
O.1.1		330		330		
O.1.2		330		330		
O.2.1						
O.2.2		330		330		
O.3.1		330		330		

 During the drilling operation on through holes a sharp disk will be produced. Safety precautions must be observed. A safety guard has to be provided as protection.

 In order to ensure efficient chip evacuation, coolant pressure must be at least 5 bar. Optimum pressure is > 15 bar.

Cutting data standard values for KUB Quatron – 2xD, 3xD

Index	ABS / C									
	10 879 ... / 15 879 ... / 10 880 ... / 15 880 ...									
	Ø 0.562-0.656 inch	Ø 0.687-0.781 inch	Ø 0.812-0.968 inch	Ø 0.985-1.156 inch	Ø 1.187-1.437 inch	Ø 1.469-1.562 inch	Ø 1.625-1.750 inch	Ø 1.781-1.812 inch	Ø 1.875-2.062 inch	Ø 2.125-2.500 inch
f in inch/rev.										
P.1.1	0.004	0.005	0.005	0.005	0.005	0.005	0.005	0.005	0.005	0.005
P.1.2	0.006	0.006	0.007	0.010	0.012	0.012	0.010	0.010	0.010	0.010
P.1.3	0.005	0.006	0.008	0.008	0.010	0.010	0.008	0.008	0.008	0.008
P.1.4	0.004	0.005	0.007	0.007	0.009	0.009	0.007	0.007	0.007	0.007
P.1.5	0.005	0.006	0.007	0.009	0.011	0.011	0.009	0.009	0.009	0.009
P.2.1	0.005	0.006	0.008	0.008	0.010	0.010	0.008	0.008	0.008	0.008
P.2.2	0.004	0.005	0.007	0.007	0.009	0.009	0.007	0.007	0.007	0.007
P.2.3	0.006	0.006	0.008	0.008	0.010	0.010	0.008	0.008	0.008	0.008
P.2.4	0.005	0.006	0.007	0.007	0.009	0.009	0.007	0.007	0.007	0.007
P.3.1	0.004	0.005	0.005	0.007	0.008	0.008	0.007	0.007	0.007	0.007
P.3.2	0.003	0.004	0.004	0.006	0.007	0.007	0.006	0.006	0.006	0.006
P.3.3	0.007	0.004	0.004	0.006	0.006	0.006	0.006	0.006	0.006	0.006
P.4.1	0.004	0.005	0.005	0.008	0.009	0.009	0.008	0.008	0.008	0.008
P.4.2	0.003	0.004	0.004	0.006	0.007	0.007	0.006	0.006	0.006	0.006
M.1.1	0.003	0.003	0.005	0.006	0.007	0.007	0.006	0.006	0.006	0.006
M.2.1	0.002	0.003	0.005	0.005	0.006	0.005	0.005	0.005	0.005	0.005
M.3.1	0.002	0.003	0.004	0.004	0.005	0.004	0.004	0.004	0.004	0.004
K.1.1	0.006	0.006	0.010	0.012	0.012	0.012	0.012	0.012	0.012	0.012
K.1.2	0.005	0.005	0.008	0.010	0.010	0.010	0.010	0.010	0.010	0.010
K.2.1	0.006	0.006	0.008	0.008	0.010	0.010	0.008	0.008	0.008	0.008
K.2.2	0.005	0.006	0.008	0.008	0.009	0.009	0.008	0.008	0.008	0.008
K.3.1	0.006	0.006	0.009	0.009	0.010	0.010	0.009	0.009	0.009	0.009
K.3.2	0.005	0.006	0.008	0.008	0.009	0.009	0.008	0.008	0.008	0.008
N.1.1	0.003	0.003	0.004	0.005	0.005	0.005	0.005	0.005	0.005	0.005
N.1.2	0.003	0.003	0.004	0.005	0.005	0.005	0.005	0.005	0.005	0.005
N.2.1	0.004	0.005	0.006	0.006	0.008	0.008	0.006	0.006	0.006	0.006
N.2.2	0.004	0.005	0.006	0.006	0.008	0.008	0.006	0.006	0.006	0.006
N.2.3	0.004	0.004	0.006	0.006	0.007	0.007	0.006	0.006	0.006	0.006
N.3.1	0.005	0.006	0.010	0.010	0.010	0.010	0.010	0.010	0.008	0.008
N.3.2	0.005	0.006	0.010	0.010	0.010	0.010	0.010	0.010	0.009	0.009
N.3.3	0.003	0.003	0.004	0.005	0.006	0.006	0.005	0.005	0.005	0.005
N.4.1	0.005	0.006	0.010	0.010	0.010	0.010	0.010	0.010	0.008	0.008
S.1.1	0.002	0.003	0.004	0.005	0.005	0.005	0.005	0.005	0.005	0.005
S.1.2	0.002	0.002	0.003	0.004	0.004	0.004	0.004	0.004	0.004	0.004
S.2.1	0.002	0.003	0.004	0.005	0.005	0.005	0.005	0.005	0.005	0.005
S.2.2	0.002	0.002	0.003	0.004	0.004	0.004	0.004	0.004	0.004	0.004
S.2.3	0.001	0.002	0.002	0.002	0.002	0.002	0.002	0.002	0.002	0.002
S.3.1	0.003	0.004	0.004	0.004	0.004	0.004	0.004	0.004	0.004	0.004
S.3.2	0.002	0.003	0.003	0.004	0.004	0.004	0.004	0.004	0.004	0.004
S.3.3	0.002	0.002	0.002	0.002	0.002	0.002	0.002	0.002	0.002	0.002
H.1.1	0.002	0.002	0.004	0.004	0.004	0.004	0.004	0.004	0.004	0.004
H.1.2	0.002	0.002	0.003	0.003	0.003	0.003	0.003	0.003	0.003	0.003
H.1.3	0.001	0.001	0.002	0.002	0.002	0.002	0.002	0.002	0.002	0.002
H.1.4										
H.2.1	0.002	0.002	0.004	0.004	0.004	0.004	0.004	0.004	0.004	0.004
H.3.1	0.002	0.002	0.003	0.003	0.003	0.003	0.003	0.003	0.003	0.003
O.1.1	0.003	0.003	0.004	0.005	0.006	0.006	0.005	0.005	0.005	0.005
O.1.2	0.003	0.003	0.004	0.005	0.006	0.006	0.005	0.005	0.005	0.005
O.2.1										
O.2.2	0.003	0.003	0.004	0.004	0.004	0.004	0.004	0.004	0.004	0.004
O.3.1	0.003	0.003	0.004	0.005	0.006	0.006	0.005	0.005	0.005	0.005

 During the drilling operation on through holes a sharp disk will be produced. Safety precautions must be observed. A safety guard has to be provided as protection.

 In order to ensure efficient chip evacuation, coolant pressure must be at least 5 bar. Optimum pressure is > 15 bar.

Cutting data standard values for WOEX indexable inserts

Index	WOEX 10 821 ...						
	BK8425	BK7935	BK6115	BK7615	BK62	BK77	BK79
	v _c in ft/min						
P.1.1	850	820	980				850
P.1.2	850	720	980				850
P.1.3	890	890	890				890
P.1.4	790	790	820				790
P.1.5	750	660	890				750
P.2.1	890	890	890				890
P.2.2	850	850	850				850
P.2.3	590	520	790				590
P.2.4	490	430	620				490
P.3.1	520	460	660				520
P.3.2	430	360	520				430
P.3.3	390	330	460				390
P.4.1	590	520	720				590
P.4.2	430	360	520				430
M.1.1	490	520	720				490
M.2.1	490	520	720				490
M.3.1	430	490	660				430
K.1.1	520	490	790	850	790		520
K.1.2	390	360	460	520	460		390
K.2.1	520	490	520	590	520		520
K.2.2	330	300	330	390	330		330
K.3.1	390	360	390	460	390		390
K.3.2	330	300	330	390	330		330
N.1.1	1310	1310					1310
N.1.2	1310	1310					1310
N.2.1	820	820					820
N.2.2	820	820					820
N.2.3	750	750					750
N.3.1	660	660					660
N.3.2	720	720					720
N.3.3	1080	1080					1080
N.4.1	660	660					660
S.1.1		160				160	
S.1.2		130				130	
S.2.1		160				160	
S.2.2		130				130	
S.2.3		100				100	
S.3.1		230				230	
S.3.2		200				200	
S.3.3		130				130	
H.1.1	330		330		330	130	
H.1.2	260		260		260	100	
H.1.3	160		160		160	70	
H.1.4							
H.2.1	330		330		330	130	
H.3.1	260		260		260	100	
O.1.1						330	
O.1.2						330	
O.2.1							
O.2.2						330	
O.3.1						330	

 During the drilling operation on through holes a sharp disk will be produced. Safety precautions must be observed. A safety guard has to be provided as protection.

 In order to ensure efficient chip evacuation, coolant pressure must be at least 5 bar. Optimum pressure is > 15 bar.

Cutting data standard values for KUB Trigon – 2xD

Index	ABS 15 892 ...												
	Ø 0.562-0.625	Ø 0.687-0.781	Ø 0.812-0.937	Ø 0.985-1.156	Ø 1.187-1.437	Ø 1.469-1.562	Ø 1.625-1.750	Ø 1.781-1.812	Ø 1.875-2.062	Ø 2.125-2.500	Ø 2.593-2.656	Ø 2.750-2.875	Ø 3.000-3.250
	inch	inch	inch	inch	inch	inch	inch	inch	inch	inch	inch	inch	inch
	f in inch/rev.												
P.1.1	0.003	0.004	0.004	0.005	0.005	0.005	0.005	0.005	0.005	0.005	0.005	0.005	0.005
P.1.2	0.003	0.004	0.005	0.006	0.006	0.006	0.006	0.007	0.008	0.008	0.010	0.010	0.010
P.1.3	0.002	0.003	0.005	0.006	0.006	0.006	0.006	0.006	0.006	0.007	0.008	0.010	0.010
P.1.4	0.002	0.003	0.004	0.005	0.005	0.005	0.005	0.006	0.005	0.006	0.007	0.009	0.009
P.1.5	0.003	0.004	0.004	0.005	0.006	0.006	0.006	0.006	0.007	0.008	0.009	0.009	0.009
P.2.1	0.002	0.003	0.005	0.006	0.006	0.006	0.006	0.006	0.007	0.008	0.010	0.010	0.010
P.2.2	0.002	0.003	0.004	0.005	0.005	0.005	0.005	0.006	0.005	0.006	0.007	0.009	0.009
P.2.3	0.002	0.003	0.004	0.006	0.006	0.006	0.006	0.006	0.006	0.006	0.007	0.008	0.008
P.2.4	0.002	0.002	0.003	0.004	0.005	0.005	0.005	0.005	0.006	0.006	0.006	0.007	0.007
P.3.1	0.002	0.003	0.004	0.005	0.005	0.005	0.005	0.006	0.006	0.006	0.006	0.006	0.006
P.3.2	0.002	0.002	0.003	0.004	0.004	0.004	0.004	0.004	0.005	0.006	0.006	0.006	0.006
P.3.3	0.002	0.002	0.003	0.003	0.003	0.003	0.003	0.004	0.004	0.005	0.005	0.005	0.005
P.4.1	0.003	0.004	0.004	0.005	0.005	0.005	0.005	0.006	0.006	0.007	0.007	0.007	0.007
P.4.2	0.002	0.002	0.003	0.004	0.004	0.004	0.004	0.004	0.005	0.006	0.006	0.006	0.006
M.1.1	0.002	0.002	0.003	0.005	0.005	0.005	0.005	0.006	0.006	0.006	0.006	0.006	0.006
M.2.1	0.002	0.002	0.003	0.005	0.005	0.005	0.005	0.005	0.005	0.005	0.006	0.006	0.006
M.3.1	0.002	0.002	0.003	0.004	0.004	0.004	0.004	0.004	0.004	0.004	0.006	0.006	0.006
K.1.1	0.004	0.005	0.006	0.008	0.008	0.008	0.008	0.010	0.010	0.010	0.012	0.012	0.012
K.1.2	0.003	0.003	0.004	0.006	0.006	0.006	0.006	0.007	0.007	0.007	0.008	0.010	0.010
K.2.1	0.003	0.004	0.006	0.008	0.008	0.008	0.008	0.010	0.010	0.010	0.012	0.012	0.012
K.2.2	0.003	0.004	0.005	0.008	0.005	0.005	0.005	0.006	0.009	0.009	0.010	0.010	0.010
K.3.1	0.004	0.005	0.006	0.010	0.006	0.006	0.006	0.007	0.010	0.010	0.012	0.012	0.012
K.3.2	0.003	0.004	0.005	0.008	0.005	0.005	0.005	0.006	0.009	0.009	0.010	0.010	0.010
N.1.1	0.002	0.003	0.003	0.004	0.004	0.005	0.005	0.005	0.005	0.006	0.006	0.006	0.006
N.1.2	0.002	0.003	0.003	0.004	0.004	0.005	0.005	0.005	0.005	0.006	0.006	0.006	0.006
N.2.1	0.004	0.005	0.006	0.007	0.007	0.008	0.008	0.007	0.008	0.008	0.008	0.008	0.008
N.2.2	0.004	0.005	0.006	0.007	0.007	0.008	0.008	0.007	0.008	0.008	0.008	0.008	0.008
N.2.3	0.004	0.004	0.005	0.006	0.006	0.007	0.007	0.006	0.007	0.007	0.007	0.007	0.007
N.3.1	0.002	0.003	0.005	0.006	0.006	0.007	0.008	0.008	0.008	0.008	0.010	0.010	0.010
N.3.2	0.002	0.004	0.005	0.007	0.007	0.008	0.009	0.009	0.009	0.009	0.010	0.010	0.010
N.3.3	0.002	0.003	0.003	0.004	0.004	0.004	0.004	0.005	0.005	0.005	0.006	0.006	0.006
N.4.1	0.002	0.003	0.005	0.006	0.006	0.007	0.008	0.008	0.008	0.008	0.010	0.010	0.010
S.1.1	0.002	0.002	0.003	0.004	0.004	0.004	0.004	0.004	0.004	0.004	0.005	0.005	0.005
S.1.2	0.001	0.002	0.002	0.003	0.003	0.003	0.003	0.003	0.003	0.003	0.004	0.004	0.004
S.2.1	0.002	0.002	0.003	0.004	0.004	0.004	0.004	0.004	0.004	0.004	0.005	0.005	0.005
S.2.2	0.001	0.002	0.002	0.003	0.003	0.003	0.003	0.003	0.003	0.003	0.004	0.004	0.004
S.2.3	0.001	0.001	0.002	0.002	0.002	0.002	0.002	0.002	0.002	0.002	0.002	0.002	0.002
S.3.1	0.003	0.004	0.004	0.005	0.004	0.005	0.005	0.005	0.004	0.004	0.005	0.005	0.006
S.3.2	0.002	0.003	0.004	0.005	0.004	0.005	0.005	0.005	0.004	0.004	0.005	0.005	0.006
S.3.3	0.002	0.002	0.002	0.003	0.002	0.003	0.003	0.003	0.002	0.002	0.003	0.003	0.003
H.1.1	0.002	0.002	0.002	0.002	0.002	0.002	0.002	0.002	0.003	0.003	0.003	0.003	0.003
H.1.2	0.002	0.002	0.002	0.002	0.002	0.002	0.002	0.002	0.002	0.002	0.002	0.002	0.003
H.1.3	0.002	0.002	0.002	0.002	0.002	0.002	0.002						
H.1.4													
H.2.1	0.002	0.002	0.002	0.002	0.002	0.002	0.002	0.002	0.002	0.002	0.002	0.002	0.002
H.3.1	0.002	0.002	0.002	0.002	0.002	0.002	0.002	0.002	0.002	0.002	0.002	0.002	0.002
O.1.1	0.003	0.003	0.004	0.004	0.004	0.004	0.004	0.004	0.004	0.004	0.004	0.004	0.004
O.1.2	0.003	0.003	0.004	0.004	0.004	0.004	0.004	0.004	0.004	0.004	0.004	0.004	0.004
O.2.1													
O.2.2	0.002	0.002	0.002	0.003	0.003	0.003	0.003	0.003	0.003	0.003	0.003	0.003	0.003
O.3.1	0.004	0.004	0.004	0.004	0.004	0.004	0.004	0.004	0.004	0.004	0.004	0.004	0.004

 During the drilling operation on through holes a sharp disk will be produced. Safety precautions must be observed. A safety guard has to be provided as protection.

 In order to ensure efficient chip evacuation, coolant pressure must be at least 5 bar. Optimum pressure is > 15 bar.

Cutting data standard values for KUB Trigon – 2.5xD

		C 15 896 ...								
Index	Ø 0.562–0.625	Ø 0.687–0.781	Ø 0.812–0.937	Ø 0.985–1.156	Ø 1.187–1.437	Ø 1.469–1.562	Ø 1.625–1.750	Ø 1.812–2.000	Ø 2.125–2.500	Ø 2.750–3.250
	inch	inch	inch	inch	inch	inch	inch	inch	inch	inch
f in inch/rev.										
P.1.1	0.003	0.004	0.004	0.005	0.005	0.005	0.005	0.005	0.005	0.005
P.1.2	0.003	0.004	0.005	0.006	0.006	0.006	0.007	0.008	0.010	0.010
P.1.3	0.002	0.003	0.005	0.006	0.006	0.006	0.006	0.007	0.008	0.010
P.1.4	0.002	0.003	0.004	0.005	0.005	0.005	0.006	0.006	0.007	0.009
P.1.5	0.003	0.004	0.004	0.005	0.006	0.006	0.006	0.008	0.009	0.009
P.2.1	0.002	0.003	0.005	0.006	0.006	0.006	0.006	0.007	0.008	0.010
P.2.2	0.002	0.003	0.004	0.005	0.005	0.005	0.006	0.006	0.007	0.009
P.2.3	0.002	0.003	0.004	0.006	0.006	0.006	0.006	0.006	0.007	0.008
P.2.4	0.002	0.002	0.003	0.004	0.005	0.005	0.005	0.006	0.006	0.007
P.3.1	0.002	0.003	0.004	0.005	0.005	0.005	0.006	0.006	0.006	0.006
P.3.2	0.002	0.002	0.003	0.004	0.004	0.004	0.004	0.006	0.006	0.006
P.3.3	0.002	0.002	0.003	0.003	0.003	0.003	0.004	0.005	0.005	0.005
P.4.1	0.003	0.004	0.004	0.005	0.005	0.005	0.006	0.007	0.007	0.007
P.4.2	0.002	0.002	0.003	0.004	0.004	0.004	0.004	0.006	0.006	0.006
M.1.1	0.002	0.002	0.003	0.005	0.005	0.005	0.006	0.006	0.006	0.006
M.2.1	0.002	0.002	0.003	0.005	0.005	0.005	0.005	0.005	0.006	0.006
M.3.1	0.002	0.002	0.003	0.004	0.004	0.004	0.004	0.004	0.006	0.006
K.1.1	0.004	0.005	0.006	0.008	0.008	0.008	0.010	0.010	0.012	0.012
K.1.2	0.003	0.003	0.004	0.006	0.006	0.006	0.007	0.007	0.008	0.010
K.2.1	0.003	0.004	0.006	0.008	0.008	0.008	0.010	0.010	0.012	0.012
K.2.2	0.003	0.004	0.005	0.008	0.005	0.005	0.006	0.009	0.010	0.010
K.3.1	0.004	0.005	0.006	0.010	0.006	0.006	0.007	0.010	0.012	0.012
K.3.2	0.003	0.004	0.005	0.008	0.005	0.005	0.006	0.009	0.010	0.010
N.1.1	0.002	0.003	0.003	0.004	0.004	0.005	0.005	0.005	0.006	0.006
N.1.2	0.002	0.003	0.003	0.004	0.004	0.005	0.005	0.005	0.006	0.006
N.2.1	0.004	0.005	0.006	0.007	0.007	0.008	0.008	0.008	0.008	0.008
N.2.2	0.004	0.005	0.006	0.007	0.007	0.008	0.008	0.008	0.008	0.008
N.2.3	0.004	0.004	0.005	0.006	0.006	0.007	0.007	0.007	0.007	0.007
N.3.1	0.002	0.003	0.005	0.006	0.006	0.007	0.008	0.008	0.010	0.010
N.3.2	0.002	0.004	0.005	0.007	0.007	0.008	0.009	0.009	0.010	0.010
N.3.3	0.002	0.003	0.003	0.004	0.004	0.004	0.005	0.005	0.006	0.006
N.4.1	0.002	0.003	0.005	0.006	0.006	0.007	0.008	0.008	0.010	0.010
S.1.1	0.002	0.002	0.003	0.004	0.004	0.004	0.004	0.004	0.005	0.005
S.1.2	0.001	0.002	0.002	0.003	0.003	0.003	0.003	0.003	0.004	0.004
S.2.1	0.002	0.002	0.003	0.004	0.004	0.004	0.004	0.004	0.005	0.005
S.2.2	0.001	0.002	0.002	0.003	0.003	0.003	0.003	0.003	0.004	0.004
S.2.3	0.001	0.001	0.002	0.002	0.002	0.002	0.002	0.002	0.002	0.002
S.3.1	0.003	0.004	0.004	0.005	0.004	0.005	0.005	0.004	0.005	0.006
S.3.2	0.002	0.003	0.004	0.005	0.004	0.005	0.005	0.004	0.005	0.006
S.3.3	0.002	0.002	0.002	0.003	0.002	0.003	0.003	0.002	0.003	0.003
H.1.1	0.002	0.002	0.002	0.002	0.002	0.002	0.002	0.003	0.003	0.003
H.1.2	0.002	0.002	0.002	0.002	0.002	0.002	0.002	0.002	0.002	0.003
H.1.3	0.002	0.002	0.002	0.002	0.002	0.002	0.002			
H.1.4										
H.2.1	0.002	0.002	0.002	0.002	0.002	0.002	0.002	0.002	0.002	0.002
H.3.1	0.002	0.002	0.002	0.002	0.002	0.002	0.002	0.002	0.002	0.002
O.1.1	0.003	0.003	0.004	0.004	0.004	0.004	0.004	0.004	0.004	0.004
O.1.2	0.003	0.003	0.004	0.004	0.004	0.004	0.004	0.004	0.004	0.004
O.2.1										
O.2.2	0.002	0.002	0.002	0.003	0.003	0.003	0.003	0.003	0.003	0.003
O.3.1	0.004	0.004	0.004	0.004	0.004	0.004	0.004	0.004	0.004	0.004

 During the drilling operation on through holes a sharp disk will be produced. Safety precautions must be observed. A safety guard has to be provided as protection.

 In order to ensure efficient chip evacuation, coolant pressure must be at least 5 bar. Optimum pressure is > 15 bar.

Cutting data standard values for KUB Trigon – 3xD

Index	ABS 10 893 ... / 15 893 ...												
	Ø 0.562-0.656	Ø 0.687-0.781	Ø 0.812-0.937	Ø 0.985-1.156	Ø 1.187-1.437	Ø 1.469-1.562	Ø 1.625-1.750	Ø 1.781-1.812	Ø 1.875-2.062	Ø 2.125-2.500	Ø 2.593-2.656	Ø 2.750-2.875	Ø 3.000-3.250
	inch	inch	inch	inch	inch	inch	inch	inch	inch	inch	inch	inch	inch
	f in inch/rev.												
P.1.1	0.003	0.004	0.004	0.005	0.005	0.005	0.005	0.005	0.005	0.005	0.005	0.005	0.005
P.1.2	0.003	0.004	0.005	0.006	0.006	0.006	0.008	0.008	0.008	0.010	0.010	0.010	0.010
P.1.3	0.002	0.003	0.005	0.006	0.006	0.006	0.006	0.006	0.007	0.008	0.010	0.010	0.010
P.1.4	0.002	0.003	0.004	0.005	0.005	0.005	0.006	0.005	0.006	0.007	0.009	0.009	0.009
P.1.5	0.003	0.004	0.004	0.005	0.006	0.006	0.007	0.007	0.008	0.009	0.009	0.009	0.009
P.2.1	0.002	0.003	0.005	0.006	0.006	0.006	0.006	0.006	0.007	0.008	0.010	0.010	0.010
P.2.2	0.002	0.003	0.004	0.005	0.005	0.005	0.006	0.005	0.006	0.007	0.009	0.009	0.009
P.2.3	0.002	0.003	0.004	0.006	0.006	0.006	0.006	0.006	0.006	0.007	0.008	0.008	0.008
P.2.4	0.002	0.002	0.003	0.004	0.005	0.005	0.005	0.006	0.006	0.006	0.007	0.007	0.007
P.3.1	0.002	0.003	0.004	0.005	0.005	0.005	0.006	0.006	0.006	0.006	0.006	0.006	0.006
P.3.2	0.002	0.002	0.003	0.004	0.004	0.004	0.004	0.005	0.006	0.006	0.006	0.006	0.006
P.3.3	0.002	0.002	0.003	0.003	0.003	0.003	0.004	0.004	0.005	0.005	0.005	0.005	0.005
P.4.1	0.003	0.004	0.004	0.005	0.005	0.005	0.006	0.006	0.007	0.007	0.007	0.007	0.007
P.4.2	0.002	0.002	0.003	0.004	0.004	0.004	0.004	0.005	0.006	0.006	0.006	0.006	0.006
M.1.1	0.002	0.002	0.003	0.005	0.005	0.005	0.006	0.006	0.006	0.006	0.006	0.006	0.006
M.2.1	0.002	0.002	0.003	0.005	0.005	0.005	0.005	0.005	0.005	0.006	0.006	0.006	0.006
M.3.1	0.002	0.002	0.003	0.004	0.004	0.004	0.004	0.004	0.004	0.006	0.006	0.006	0.006
K.1.1	0.004	0.005	0.006	0.008	0.008	0.008	0.010	0.010	0.010	0.012	0.012	0.012	0.012
K.1.2	0.003	0.003	0.004	0.006	0.006	0.006	0.007	0.007	0.007	0.008	0.010	0.010	0.010
K.2.1	0.003	0.004	0.006	0.008	0.008	0.008	0.010	0.010	0.010	0.012	0.012	0.012	0.012
K.2.2	0.003	0.004	0.005	0.008	0.008	0.008	0.008	0.009	0.009	0.010	0.010	0.010	0.010
K.3.1	0.004	0.005	0.006	0.010	0.010	0.010	0.010	0.010	0.010	0.012	0.012	0.012	0.012
K.3.2	0.003	0.004	0.005	0.008	0.008	0.008	0.008	0.009	0.009	0.010	0.010	0.010	0.010
N.1.1	0.002	0.003	0.003	0.004	0.004	0.005	0.005	0.005	0.005	0.006	0.006	0.006	0.006
N.1.2	0.002	0.003	0.003	0.004	0.004	0.005	0.005	0.005	0.005	0.006	0.006	0.006	0.006
N.2.1	0.004	0.005	0.006	0.007	0.007	0.008	0.008	0.007	0.008	0.008	0.008	0.008	0.008
N.2.2	0.004	0.005	0.006	0.007	0.007	0.008	0.008	0.007	0.008	0.008	0.008	0.008	0.008
N.2.3	0.004	0.004	0.005	0.006	0.006	0.007	0.007	0.006	0.007	0.007	0.007	0.007	0.007
N.3.1	0.002	0.003	0.005	0.006	0.006	0.007	0.008	0.008	0.008	0.010	0.010	0.010	0.010
N.3.2	0.002	0.004	0.005	0.007	0.007	0.008	0.009	0.009	0.009	0.010	0.010	0.010	0.010
N.3.3	0.002	0.004	0.004	0.004	0.004	0.004	0.005	0.005	0.005	0.006	0.006	0.006	0.006
N.4.1	0.002	0.003	0.005	0.006	0.006	0.007	0.008	0.008	0.008	0.010	0.010	0.010	0.010
S.1.1	0.002	0.002	0.003	0.004	0.004	0.004	0.004	0.004	0.004	0.005	0.005	0.005	0.005
S.1.2	0.001	0.002	0.002	0.003	0.003	0.003	0.003	0.003	0.003	0.004	0.004	0.004	0.004
S.2.1	0.002	0.002	0.003	0.004	0.004	0.004	0.004	0.004	0.004	0.005	0.005	0.005	0.005
S.2.2	0.001	0.002	0.002	0.003	0.003	0.003	0.003	0.003	0.003	0.004	0.004	0.004	0.004
S.2.3	0.001	0.001	0.002	0.002	0.002	0.002	0.002	0.002	0.002	0.002	0.002	0.002	0.002
S.3.1	0.003	0.004	0.004	0.005	0.004	0.005	0.005	0.004	0.004	0.005	0.005	0.006	0.006
S.3.2	0.002	0.003	0.004	0.005	0.004	0.005	0.005	0.004	0.004	0.005	0.005	0.006	0.006
S.3.3	0.002	0.002	0.002	0.003	0.002	0.003	0.003	0.002	0.002	0.003	0.003	0.003	0.003
H.1.1	0.002	0.003	0.003	0.004	0.004	0.004	0.004	0.003	0.003	0.003	0.003	0.003	0.003
H.1.2	0.002	0.002	0.002	0.003	0.003	0.003	0.003	0.002	0.002	0.002	0.002	0.003	0.003
H.1.3	0.001	0.002	0.002	0.002	0.002	0.002	0.002						
H.1.4													
H.2.1	0.002	0.003	0.003	0.004	0.004	0.004	0.004	0.002	0.002	0.002	0.002	0.002	0.002
H.3.1	0.002	0.002	0.002	0.003	0.003	0.003	0.003	0.002	0.002	0.002	0.002	0.002	0.002
O.1.1	0.003	0.003	0.004	0.004	0.004	0.004	0.004	0.004	0.004	0.004	0.004	0.004	0.004
O.1.2	0.003	0.003	0.004	0.004	0.004	0.004	0.004	0.004	0.004	0.004	0.004	0.004	0.004
O.2.1													
O.2.2	0.002	0.002	0.002	0.003	0.003	0.003	0.003	0.003	0.003	0.003	0.003	0.003	0.003
O.3.1	0.004	0.004	0.004	0.004	0.004	0.004	0.004	0.004	0.004	0.004	0.004	0.004	0.004

 During the drilling operation on through holes a sharp disk will be produced. Safety precautions must be observed. A safety guard has to be provided as protection.

 In order to ensure efficient chip evacuation, coolant pressure must be at least 5 bar. Optimum pressure is > 15 bar.

Cutting data standard values for KUB Trigon – 4xD

Index	ABS 10 894 ... / 15 894 ...						
	Ø 0.562-0.656 inch	Ø 0.687-0.781 inch	Ø 0.812-0.937 inch	Ø 0.985-1.156 inch	Ø 1.187-1.437 inch	Ø 1.469-1.562 inch	Ø 1.625-1.750 inch
	f in inch/rev.						
P.1.1	0.002	0.003	0.003	0.004	0.004	0.004	0.004
P.1.2	0.002	0.003	0.004	0.005	0.006	0.006	0.007
P.1.3	0.002	0.002	0.004	0.005	0.005	0.005	0.006
P.1.4	0.002	0.002	0.004	0.004	0.004	0.004	0.005
P.1.5	0.002	0.003	0.004	0.004	0.005	0.005	0.006
P.2.1	0.002	0.002	0.004	0.005	0.005	0.005	0.006
P.2.2	0.002	0.002	0.004	0.004	0.004	0.004	0.005
P.2.3	0.002	0.002	0.003	0.005	0.006	0.006	0.006
P.2.4	0.001	0.002	0.002	0.004	0.004	0.004	0.004
P.3.1	0.002	0.002	0.003	0.004	0.004	0.004	0.005
P.3.2	0.001	0.002	0.002	0.003	0.003	0.003	0.004
P.3.3	0.001	0.002	0.002	0.003	0.003	0.003	0.003
P.4.1	0.002	0.003	0.004	0.004	0.004	0.004	0.005
P.4.2	0.001	0.002	0.002	0.003	0.003	0.003	0.004
M.1.1	0.002	0.002	0.002	0.004	0.004	0.004	0.005
M.2.1	0.002	0.002	0.002	0.004	0.004	0.004	0.004
M.3.1	0.002	0.002	0.002	0.004	0.004	0.004	0.004
K.1.1	0.003	0.004	0.005	0.007	0.007	0.007	0.009
K.1.2	0.002	0.002	0.003	0.005	0.005	0.006	0.006
K.2.1	0.002	0.003	0.005	0.007	0.007	0.007	0.009
K.2.2	0.002	0.003	0.004	0.007	0.007	0.007	0.007
K.3.1	0.003	0.004	0.006	0.009	0.009	0.009	0.009
K.3.2	0.002	0.003	0.004	0.007	0.007	0.007	0.007
N.1.1	0.001	0.002	0.002	0.003	0.003	0.004	0.004
N.1.2	0.001	0.002	0.002	0.003	0.003	0.004	0.004
N.2.1	0.003	0.004	0.005	0.006	0.006	0.007	0.007
N.2.2	0.003	0.004	0.005	0.006	0.006	0.007	0.007
N.2.3	0.003	0.004	0.004	0.006	0.006	0.006	0.006
N.3.1	0.001	0.002	0.004	0.006	0.006	0.006	0.007
N.3.2	0.001	0.003	0.004	0.006	0.006	0.007	0.008
N.3.3	0.001	0.002	0.002	0.003	0.003	0.003	0.004
N.4.1	0.001	0.002	0.004	0.006	0.006	0.006	0.007
S.1.1	0.001	0.002	0.002	0.003	0.003	0.003	0.003
S.1.2	0.001	0.001	0.002	0.002	0.002	0.002	0.002
S.2.1	0.001	0.002	0.002	0.003	0.003	0.003	0.003
S.2.2	0.001	0.001	0.002	0.002	0.002	0.002	0.002
S.2.3	0.000	0.001	0.001	0.002	0.002	0.002	0.002
S.3.1	0.002	0.003	0.004	0.004	0.004	0.004	0.004
S.3.2	0.002	0.002	0.003	0.004	0.003	0.004	0.004
S.3.3	0.001	0.002	0.002	0.002	0.002	0.002	0.002
H.1.1	0.001	0.002	0.002	0.003	0.003	0.003	0.003
H.1.2	0.001	0.002	0.002	0.002	0.002	0.002	0.002
H.1.3	0.001	0.001	0.001	0.002	0.002	0.002	0.002
H.1.4							
H.2.1	0.001	0.002	0.002	0.003	0.003	0.003	0.003
H.3.1	0.001	0.002	0.002	0.002	0.002	0.002	0.002
O.1.1	0.003	0.003	0.004	0.004	0.004	0.004	0.004
O.1.2	0.003	0.003	0.004	0.004	0.004	0.004	0.004
O.2.1							
O.2.2	0.002	0.002	0.002	0.003	0.003	0.003	0.003
O.3.1	0.004	0.004	0.004	0.004	0.004	0.004	0.004

 During the drilling operation on through holes a sharp disk will be produced. Safety precautions must be observed. A safety guard has to be provided as protection.

 In order to ensure efficient chip evacuation, coolant pressure must be at least 5 bar. Optimum pressure is > 15 bar.

Cutting data standard values for KUB Trigon – 4xD

Index	C 15 894 ...						
	Ø 0.562-0.656 inch	Ø 0.687-0.781 inch	Ø 0.812-0.937 inch	Ø 0.985-1.156 inch	Ø 1.187-1.437 inch	Ø 1.469-1.562 inch	Ø 1.625-1.750 inch
	f in inch/rev.						
P.1.1	0.002	0.003	0.003	0.004	0.004	0.004	0.004
P.1.2	0.002	0.003	0.004	0.005	0.006	0.006	0.007
P.1.3	0.002	0.002	0.004	0.005	0.005	0.005	0.006
P.1.4	0.002	0.002	0.004	0.004	0.004	0.004	0.005
P.1.5	0.002	0.003	0.004	0.004	0.005	0.005	0.006
P.2.1	0.002	0.002	0.004	0.005	0.005	0.005	0.006
P.2.2	0.002	0.002	0.004	0.004	0.004	0.004	0.005
P.2.3	0.002	0.002	0.003	0.005	0.006	0.006	0.006
P.2.4	0.001	0.002	0.002	0.004	0.004	0.004	0.004
P.3.1	0.002	0.002	0.003	0.004	0.004	0.004	0.005
P.3.2	0.001	0.002	0.002	0.003	0.004	0.003	0.004
P.3.3	0.001	0.002	0.002	0.003	0.003	0.003	0.003
P.4.1	0.002	0.003	0.004	0.004	0.005	0.004	0.005
P.4.2	0.001	0.002	0.002	0.003	0.004	0.003	0.004
M.1.1	0.002	0.002	0.002	0.004	0.004	0.004	0.005
M.2.1	0.002	0.002	0.002	0.004	0.004	0.004	0.004
M.3.1	0.002	0.002	0.002	0.004	0.004	0.004	0.004
K.1.1	0.003	0.004	0.005	0.007	0.007	0.007	0.009
K.1.2	0.002	0.002	0.003	0.005	0.005	0.006	0.006
K.2.1	0.002	0.003	0.005	0.007	0.007	0.007	0.009
K.2.2	0.002	0.003	0.004	0.007	0.007	0.007	0.007
K.3.1	0.003	0.004	0.006	0.009	0.009	0.009	0.009
K.3.2	0.002	0.003	0.004	0.007	0.007	0.007	0.007
N.1.1	0.001	0.002	0.002	0.003	0.004	0.004	0.004
N.1.2	0.001	0.002	0.002	0.003	0.004	0.004	0.004
N.2.1	0.003	0.004	0.005	0.006	0.007	0.007	0.007
N.2.2	0.003	0.004	0.005	0.006	0.007	0.007	0.007
N.2.3	0.003	0.004	0.004	0.006	0.006	0.006	0.006
N.3.1	0.002	0.002	0.004	0.006	0.006	0.006	0.007
N.3.2	0.002	0.003	0.004	0.006	0.007	0.007	0.008
N.3.3	0.001	0.003	0.003	0.004	0.004	0.003	0.004
N.4.1	0.002	0.002	0.004	0.006	0.006	0.006	0.007
S.1.1	0.001	0.002	0.003	0.003	0.004	0.003	0.003
S.1.2	0.001	0.002	0.002	0.002	0.003	0.002	0.002
S.2.1	0.001	0.002	0.003	0.003	0.004	0.003	0.003
S.2.2	0.001	0.002	0.002	0.002	0.003	0.002	0.002
S.2.3	0.001	0.001	0.002	0.002	0.002	0.002	0.002
S.3.1	0.002	0.003	0.004	0.004	0.004	0.004	0.004
S.3.2	0.002	0.002	0.003	0.004	0.004	0.004	0.004
S.3.3	0.001	0.002	0.002	0.002	0.002	0.002	0.002
H.1.1	0.001	0.002	0.002	0.003	0.003	0.003	0.003
H.1.2	0.001	0.002	0.002	0.002	0.002	0.002	0.002
H.1.3	0.001	0.001	0.001	0.002	0.002	0.002	0.002
H.1.4							
H.2.1	0.001	0.002	0.002	0.003	0.003	0.003	0.003
H.3.1	0.001	0.002	0.002	0.002	0.002	0.002	0.002
O.1.1	0.003	0.003	0.004	0.004	0.004	0.004	0.004
O.1.2	0.003	0.003	0.004	0.004	0.004	0.004	0.004
O.2.1							
O.2.2	0.002	0.002	0.002	0.003	0.003	0.003	0.003
O.3.1	0.004	0.004	0.004	0.004	0.004	0.004	0.004

 During the drilling operation on through holes a sharp disk will be produced. Safety precautions must be observed. A safety guard has to be provided as protection.

 In order to ensure efficient chip evacuation, coolant pressure must be at least 5 bar. Optimum pressure is > 15 bar.

Cutting data standard values for KUB Centron

Index	Drill head diameter											
	Ø 0.812–1.000 inch				Ø 1.125–1.250 inch				Ø 1.375–1.750 inch			
	f inch/rev.	Centering tip V _c			f inch/rev.	Centering tip V _c			f inch/rev.	Centering tip V _c		
	10 863 ... (TiN/TiAlN)	10 862 ... (TiN)	10 862 ... (TiAlN)		10 863 ... (TiN/TiAlN)	10 862 ... (TiN)	10 862 ... (TiAlN)		10 863 ... (TiN/TiAlN)	10 862 ... (TiN)	10 862 ... (TiAlN)	
P.1.1	0.003	820	520		0.003	820	520		0.004	820	520	
P.1.2	0.005	820	520		0.006	820	520		0.006	820	520	
P.1.3	0.004	660	520		0.005	660	520		0.005	660	520	
P.1.4	0.004	590	520		0.004	590	520		0.004	590	520	
P.1.5	0.004	750	520		0.005	750	520		0.005	750	520	
P.2.1	0.004	660	520		0.005	660	520		0.005	660	520	
P.2.2	0.004	620	490		0.004	620	490		0.004	620	490	
P.2.3	0.005	590	460		0.006	590	460		0.006	590	460	
P.2.4	0.004	490	390		0.005	490	390		0.005	490	390	
P.3.1	0.003	520	390		0.004	520	390		0.004	520	390	
P.3.2	0.002	460	330		0.003	460	330		0.003	460	330	
P.3.3	0.003	430	300		0.003	430	300		0.003	430	300	
P.4.1	0.004	590	430		0.004	590	430		0.004	590	430	
P.4.2	0.002	460	330		0.003	460	330		0.003	460	330	
M.1.1	0.004	520		230	0.005	520		230	0.005	520		230
M.2.1	0.003	390		230	0.004	390		230	0.004	390		230
M.3.1	0.003	360		200	0.003	360		200	0.003	360		200
K.1.1	0.006	660		330	0.006	660		330	0.006	660		330
K.1.2	0.005	520		330	0.006	520		330	0.006	520		330
K.2.1	0.005	520		330	0.006	520		330	0.006	520		330
K.2.2	0.004	330		260	0.005	330		260	0.005	330		260
K.3.1	0.005	390		330	0.006	390		330	0.006	390		330
K.3.2	0.004	330		260	0.005	330		260	0.005	330		260
N.1.1	0.003	1150	1150		0.003	1150	1150		0.004	1150	1150	
N.1.2	0.003	1150	1150		0.003	1150	1150		0.004	1150	1150	
N.2.1	0.004	820	820		0.005	820	820		0.006	820	820	
N.2.2	0.004	820	820		0.005	820	820		0.006	820	820	
N.2.3	0.004	750	750		0.004	750	750		0.006	750	750	
N.3.1	0.006	660	660		0.006	660	660		0.007	660	660	
N.3.2	0.006	720	720		0.007	720	720		0.008	720	720	
N.3.3	0.004	820	820		0.004	820	820		0.006	820	820	
N.4.1	0.006	660	660		0.006	660	660		0.007	660	660	
S.1.1	0.002	160		80	0.002	160		80	0.002	160		80
S.1.2	0.001	130		70	0.002	130		70	0.002	130		70
S.2.1	0.002	160		80	0.002	160		80	0.002	160		80
S.2.2	0.001	130		70	0.002	130		70	0.002	130		70
S.2.3	0.001	100		70	0.002	100		70	0.002	100		70
S.3.1	0.002	260		160	0.003	260		160	0.003	260		160
S.3.2	0.002	260		130	0.002	260		130	0.002	260		130
S.3.3	0.001	160		100	0.002	160		100	0.002	160		100
H.1.1												
H.1.2												
H.1.3												
H.1.4												
H.2.1												
H.3.1												
O.1.1	0.003	330	330		0.004	330	330		0.004	330	330	
O.1.2	0.003	330	330		0.004	330	330		0.004	330	330	
O.2.1												
O.2.2	0.003	160	100		0.004	160	100		0.004	160	100	
O.3.1	0.003	330	330		0.004	330	330		0.004	330	330	

 During the drilling operation on through holes a sharp disk will be produced. Safety precautions must be observed. A safety guard has to be provided as protection.

 In order to ensure efficient chip evacuation, coolant pressure must be at least 5 bar. Optimum pressure is > 15 bar.

Index	Drill head diameter							
	Ø 1.875–2.000 inch				Ø 2.250–2.500 inch			
	f inch/rev.	Centering tip V _c			f inch/rev.	Centering tip V _c		
	10 863 ... (TiN/TiAlN)	10 862 ... (TiN)	10 862 ... (TiAlN)		10 863 ... (TiN/TiAlN)	10 862 ... (TiN)	10 862 ... (TiAlN)	
P.1.1	0.004	820	520		0.004	820	520	
P.1.2	0.006	820	520		0.006	820	520	
P.1.3	0.005	660	520		0.006	660	520	
P.1.4	0.004	590	520		0.005	590	520	
P.1.5	0.005	750	520		0.006	750	520	
P.2.1	0.005	660	520		0.006	660	520	
P.2.2	0.004	620	490		0.005	620	490	
P.2.3	0.006	590	460		0.006	590	460	
P.2.4	0.005	490	390		0.005	490	390	
P.3.1	0.004	520	390		0.005	520	390	
P.3.2	0.003	460	330		0.004	460	330	
P.3.3	0.003	430	300		0.004	430	300	
P.4.1	0.004	590	430		0.006	590	430	
P.4.2	0.003	460	330		0.004	460	330	
M.1.1	0.005	520		230	0.005	520		230
M.2.1	0.004	390		230	0.004	390		230
M.3.1	0.003	360		200	0.003	360		200
K.1.1	0.006	660		330	0.006	660		330
K.1.2	0.006	520		330	0.006	520		330
K.2.1	0.006	520		330	0.006	520		330
K.2.2	0.005	330		260	0.005	330		260
K.3.1	0.006	390		330	0.006	390		330
K.3.2	0.005	330		260	0.005	330		260
N.1.1	0.004	1150	1150		0.004	1150	1150	
N.1.2	0.004	1150	1150		0.004	1150	1150	
N.2.1	0.006	820	820		0.006	820	820	
N.2.2	0.006	820	820		0.006	820	820	
N.2.3	0.006	750	750		0.006	750	750	
N.3.1	0.007	660	660		0.007	660	660	
N.3.2	0.008	720	720		0.008	720	720	
N.3.3	0.006	820	820		0.006	820	820	
N.4.1	0.007	660	660		0.007	660	660	
S.1.1	0.002	160		80	0.002	160		80
S.1.2	0.002	130		70	0.002	130		70
S.2.1	0.002	160		80	0.002	160		80
S.2.2	0.002	130		70	0.002	130		70
S.2.3	0.002	100		70	0.002	100		70
S.3.1	0.003	260		160	0.003	260		160
S.3.2	0.002	260		130	0.002	260		130
S.3.3	0.002	160		100	0.002	160		100
H.1.1								
H.1.2								
H.1.3								
H.1.4								
H.2.1								
H.3.1								
O.1.1	0.004	330	330		0.004	330	330	
O.1.2	0.004	330	330		0.004	330	330	
O.2.1								
O.2.2	0.004	160	100		0.004	160	100	
O.3.1	0.004	330	330		0.004	330	330	

 The cutting data of the KUB Centron depends on the centering tip and not on the indexable inserts. Please select the cutting data of the centering tip.

Maximum adjustment range (X) during solid drilling / from the center for stationary applications – KUB Pentron

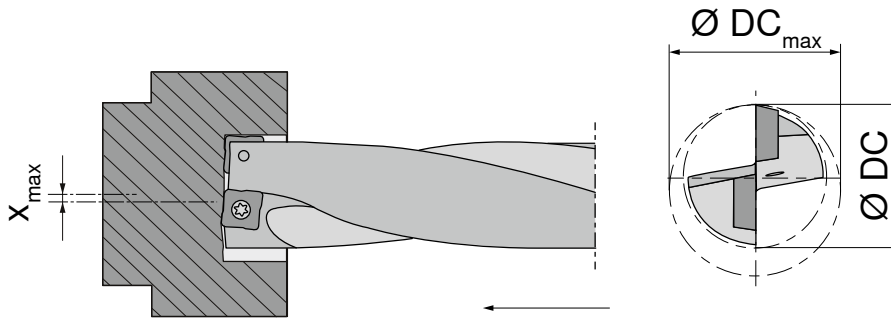

At max. offset X_{max} the hole will be:

$$DC_{max} = DC + 2X_{max}$$

e.g. for DC = 0.750", X_{max} = 0.010":

$$DC_{max} = DC + 0.020" = 0.770"$$

Ø DC inch	Insert size	X _{max} inch	Ø DC _{max} inch
0.562		0.010	0.582
0.593	SOGX 04....	0.010	0.613
0.625		0.010	0.645
0.656		0.010	0.676
0.687	SOGX 05....	0.010	0.707
0.703		0.010	0.723
0.750		0.010	0.770
0.765	SOGX 06....	0.010	0.785
0.781		0.010	0.801
0.812		0.010	0.832
0.828		0.010	0.848
0.843	SOGX 07....	0.010	0.863
0.875		0.010	0.895
0.906		0.010	0.926
0.937		0.010	0.957
0.985	SOGX 08....	0.010	1.005
1.000		0.010	1.020
1.031		0.010	1.051
1.062		0.010	1.082
1.109	SOGX 09....	0.010	1.129
1.125		0.010	1.145
1.156		0.010	1.176
1.187		0.010	1.207
1.218		0.010	1.238
1.250	SOGX 10....	0.010	1.270
1.281		0.010	1.301
1.312		0.010	1.332
1.328		0.010	1.348
1.375	SOGX 11....	0.010	1.395
1.437		0.010	1.457
1.469		0.010	1.489
1.500		0.010	1.520
1.531	SOGX 12....	0.010	1.551
1.562		0.010	1.582
1.625		0.010	1.645
1.656		0.010	1.676
1.687	SOGX 13....	0.010	1.707
1.750		0.010	1.770



The maximum radial X-offset affects the cutting force balance of the drill, therefore, the use of lower feed rates is recommended!

Maximum adjustment range (X) during solid drilling / from the center for stationary applications – KUB Quatron

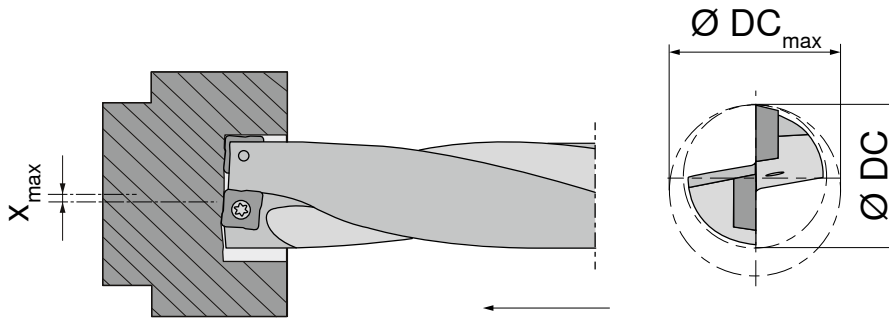

At max. offset X_{max} the hole will be:
 $DC_{max} = DC + 2X_{max}$
 e.g. for $DC = 0.750''$, $X_{max} = 0.010''$:
 $DC_{max} = DC + 0.020'' = 0.770''$

Ø DC inch	Insert size	X _{max} inch	Ø DC _{max} inch	Ø DC inch	Insert size	X _{max} inch	Ø DC _{max} inch
0.562	SOEX 05...	0.010	0.582	1.312	SOEX 12...	0.010	1.332
0.593		0.010	0.613	1.328		0.010	1.348
0.625		0.010	0.645	1.375		0.010	1.395
0.656		0.010	0.676	1.406		0.010	1.426
0.687		0.010	0.707	1.437		0.010	1.457
0.703	SOEX 06...	0.010	0.723	1.469	SOEX 07...	0.010	1.489
0.718		0.010	0.738	1.500		0.010	1.520
0.750		0.010	0.770	1.531		0.010	1.551
0.765		0.010	0.785	1.562		0.010	1.582
0.781		0.010	0.801	1.625		0.010	1.645
0.812		0.010	0.832	1.656		0.010	1.676
0.828		0.010	0.848	1.687		0.010	1.707
0.843	SOEX 07...	0.010	0.863	1.750	SOEX 09...	0.010	1.770
0.875		0.010	0.895	1.781		0.010	1.801
0.906		0.010	0.926	1.812		0.010	1.832
0.937		0.010	0.957	1.875		0.010	1.895
0.968		0.010	0.988	1.937		0.010	1.957
0.985		0.010	1.005	1.975		0.010	1.995
1.000		0.010	1.020	2.000		0.010	2.020
1.031		0.010	1.051	2.062		0.010	2.082
1.062		0.010	1.082	2.125		0.010	2.145
1.109		0.010	1.129	2.165		0.010	2.185
1.125	SOEX 09...	0.010	1.145	2.203	SOEX 09...	0.010	2.223
1.156		0.010	1.176	2.250		0.010	2.270
1.187		0.010	1.207	2.281		0.010	2.301
1.218		0.010	1.238	2.375		0.010	2.395
1.250		0.010	1.270	2.437		0.010	2.457
1.281		0.010	1.301	2.500			2.520

 The maximum radial X-offset affects the cutting force balance of the drill, therefore, the use of lower feed rates is recommended!

Maximum adjustment range (X) during solid drilling / from the center for stationary applications – KUB Trigon

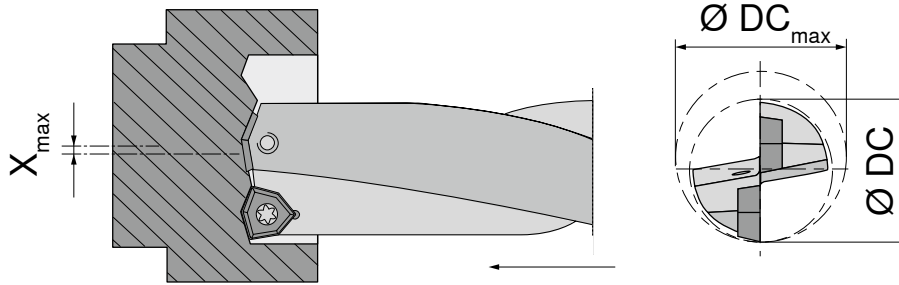

At max. offset X_{max} the hole will be:
 $DC_{max} = DC + 2X_{max}$
 e.g. for $DC = 0.750''$, $X_{max} = 0.020''$:
 $DC_{max} = DC + 0.040'' = 0.790''$

$\varnothing DC$ inch	Insert size	X_{max} inch	$\varnothing DC_{max}$ inch	$\varnothing DC$ inch	Insert size	X_{max} inch	$\varnothing DC_{max}$ inch
0.562	WOEX 03...	0.020	0.602	1.469	WOEX 06...	0.060	1.589
0.593		0.020	0.633	1.500		0.060	1.620
0.625		0.020	0.665	1.531		0.060	1.651
0.656		0.020	0.696	1.562		0.060	1.682
0.687		0.020	0.727	1.625		0.060	1.745
0.703		0.020	0.743	1.656		0.060	1.776
0.750		0.020	0.790	1.687		0.043	1.773
0.765		0.020	0.805	1.750		0.011	1.772
0.781		0.020	0.821	1.781		0.058	1.897
0.812		WOEX 04...	0.020	0.852		1.812	0.059
0.828	0.020		0.868	1.875	0.059	1.992	
0.843	0.020		0.883	1.937	0.059	2.055	
0.875	0.020		0.915	1.975	0.059	2.093	
0.906	0.020		0.946	2.000	0.059	2.118	
0.937	0.020		0.977	2.062	0.049	2.160	
0.985	0.020		1.025	2.125	0.023	2.171	
1.000	0.020		1.040	2.165	0.059	2.283	
1.031	0.040		1.111	2.203	0.059	2.321	
1.062	0.040		1.142	2.250	0.058	2.366	
1.109	WOEX 05...	0.060	1.229	2.281	0.058	2.397	
1.125		0.065	1.254	2.375	0.027	2.429	
1.156		0.060	1.276	2.437	0.059	2.555	
1.187		0.050	1.287	2.500	0.065	2.630	
1.218		0.050	1.318	2.593	0.059	2.711	
1.250		0.041	1.331	2.625	0.058	2.740	
1.281		0.040	1.361	2.656	0.059	2.774	
1.312		0.040	1.392	2.750	0.058	2.866	
1.328		0.040	1.408	2.875	0.059	2.992	
1.375		0.020	1.415	3.000	0.059	3.118	
1.406	0.020	1.446	3.250	0.018	3.285		
1.437	0.020	1.477					

 The maximum radial X-offset affects the cutting force balance of the drill, therefore, the use of lower feed rates is recommended!

Coding example indexable insert drilling

System	Length	Bore diameter	Direction of rotation	Insert size	Machine connection and size
KUB-P	4D	0750	R	06	ABS 50
KUB-Q	3D	1375	R	12	ABS 50
KUB-T	2.5D	1125	R	05	C1250
KUB-C.GH	4D	320	R		ABS 50

KUB-P = KUB Pentron	0750 = 0.750"	R = right	ABS50 = ABS adapter size 50
KUB-Q = KUB Quatron	1375 = 1.375"	R = right	ABS50 = ABS adapter size 50
KUB-T = KUB Trigon	1125 = 1.125"	R = right	C1250 = Cylindrical shank with clamping flat Ø1.250"
KUB-C.GH = KUB Centron Basic Element	320 = KLG 32	R = right	ABS50 = ABS adapter size 50

Recommended coolant pressure and coolant flow

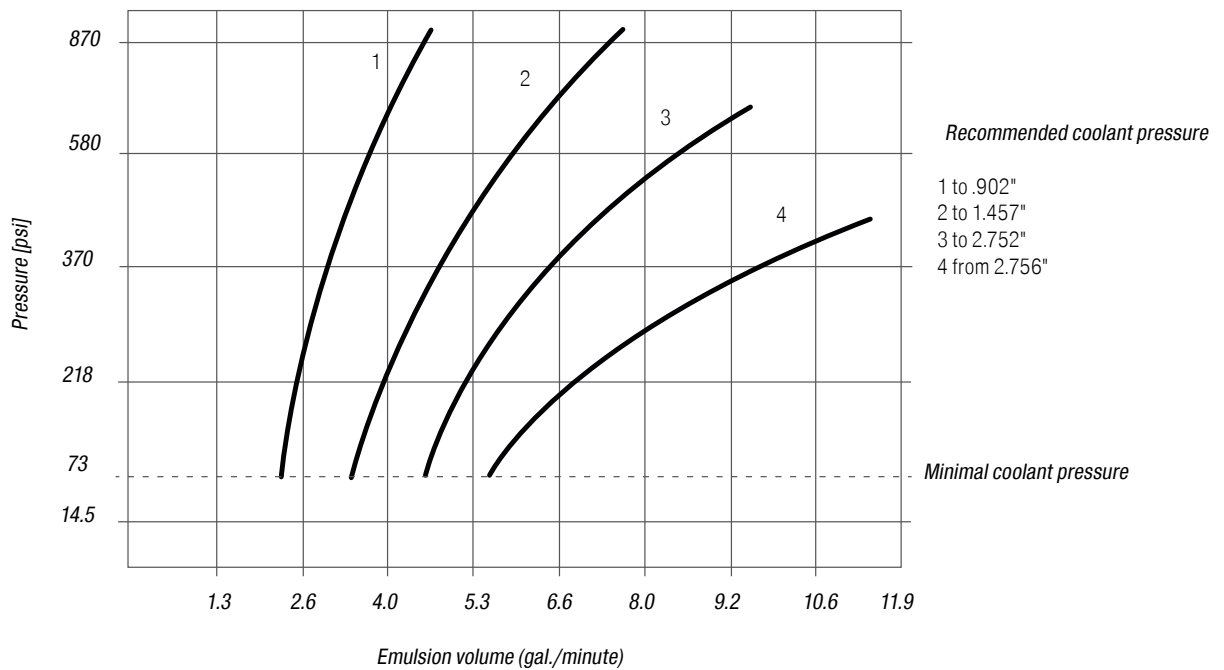

Indexable insert drilling – problems / possible causes / solutions

Rotating and stationary application		Short service life / types of wear of indexable inserts <ul style="list-style-type: none"> ▲ Cutting speed too high → select the correct cutting speed ▲ Insert grade selection has too little wear resistance → select a wear resistant grade ▲ Tool overhang too large → if possible, use a shorter tool ▲ Damaged insert seat → check tool, replace if necessary ▲ Clamping device stability too low → increase stability
		Hole tapers in <ul style="list-style-type: none"> ▲ Chip jam on the outer cutting edge → use a different chip breakage geometry, increase the feed if necessary ▲ Material very soft → increase the cutting speed, reduce the feed. Use a positive cutting edge geometry
		Hole tapers out <ul style="list-style-type: none"> ▲ Chip jam on the inner cutting edge → use a different chip breakage geometry, increase the feed if necessary
		Poor surface quality <ul style="list-style-type: none"> ▲ Poor chip evacuation → optimize the cutting parameters: Increase the cutting speed, reduce the feed
		Built-up edge <ul style="list-style-type: none"> ▲ Cutting speed too low → increase cutting speed ▲ Indexable insert too negative → use positive geometry ▲ Unsuitable coating → select the correct coating
		Friction marks on the tool body <ul style="list-style-type: none"> ▲ Drill diameter too small → check the setting ▲ Chip evacuation problems → optimize the cutting parameters, check the geometry of the indexable insert ▲ Cutting radius too large → use the correct cutting radius
Stationary application		Edge breakage on the inner cutting edge <ul style="list-style-type: none"> ▲ Center height of the tool too high/too low → adjust tool turret/adaptor if necessary → Recalibrate the machine ▲ Indexable insert grades interchanged → use correct indexable insert ▲ Feed too high → reduce feed ▲ Indexable insert grade too brittle → use a tougher indexable insert grade ▲ Incorrect indexable insert geometry → if necessary use a geometry with a chamfered cutting edge
		Edge breakage on the outer cutting edge <ul style="list-style-type: none"> ▲ Feed too high → reduce feed ▲ Interrupted cut → switch to a tougher grade of indexable insert ▲ Cutting radius too small → use an indexable insert with a larger cutting radius
		Hole too small / too large with adjustable tools <ul style="list-style-type: none"> ▲ Machine is not in the X-0 position → move axis to correct position ▲ Machine axis has been moved → recalibrate the machine
Rotating application		Edge breakage on the inner cutting edge <ul style="list-style-type: none"> ▲ Indexable insert grades interchanged → use correct indexable insert ▲ Feed too high → reduce feed ▲ Indexable insert grade too brittle → use a tougher indexable insert grade ▲ Incorrect indexable insert geometry → if necessary use a geometry with a chamfered cutting edge
		Edge breakage on the outer cutting edge <ul style="list-style-type: none"> ▲ Feed too high → reduce feed ▲ Interrupted cut → switch to a tougher grade of indexable insert ▲ Cutting radius too small → use an indexable insert with a larger cutting radius
		Hole too small / too large when using adjustable tools <ul style="list-style-type: none"> ▲ Incorrect cutting radius used → use the correct cutting radius ▲ Incorrect adjustment setting → set the tool to the correct diameter ▲ Increase cutting fluid supply

KUB Centron – notes on drilling technology

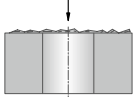
1.  Center drill entering on uneven surfaces (casting surfaces)

 - ▲ Generally possible
 - ▲ Reduce feed during drill entry

2.  Center drill entering on angled surfaces

 - ▲ The entering drilling location must be spot faced in advance
 - ▲ Avoid chips jamming on the drill shank

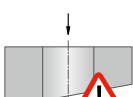
3.  Angled drill exit

 - ▲ Possible under certain conditions
 - ▲ If necessary, reduce feed
 - ▲ Drilling angle max. 3°

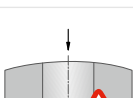
4.  Center drill entering on convex surfaces

 - ▲ Centered drilling possible with reduced feed
 - ▲ If the drill entry location is outside the center of the radius, spot facing is required

5.  Drilling through a cross hole

 - ▲ During the interruption, reduce the feed rate by 1/2
 - ▲ Cross hole max. 1/3 of the bore diameter
 - ▲ Off center cross hole not possible

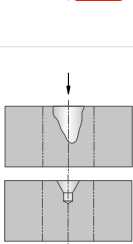
6.  Center drill entering on pre-op or large center drilled hole

 - ▲ Possible under certain conditions
 - ▲ If necessary, reduce feed
 - ▲ In the case of a large center, facing is required in advance
 - ▲ If necessary, adjust the set length of the center drill. The center drill must be engaged before the inserts begin to cut.

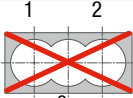
7.  Drilling a cavity

 - ▲ Not possible

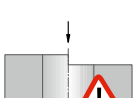
8.  Center drill entering on an edge

 - ▲ Not possible with tools longer than 4xD
 - ▲ Preparation required due to undefined center drill entry location (spot facing, face milling)
 - ▲ Then continue as described under Point 1

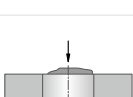
9.  Center drill entering on a forging/welding/casting seam

 - ▲ Reduce feed during drill entry
 - ▲ If necessary, face surface before drilling

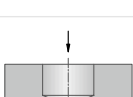

10.  Drilling through stacks

 - ▲ Not possible

11.  Blind hole

 - ▲ Possible
 - ▲ Set guide pads .020" below actual ϕ

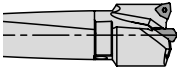
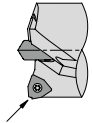
KUB Centron – problems / possible causes / solutions

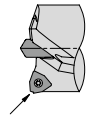
Rotating and stationary application		Short service life / types of wear of indexable inserts <ul style="list-style-type: none"> ▲ Cutting speed too high → select the correct cutting speed ▲ Grade has too little wear resistance → select a wear-resistant grade ▲ Tool overhang too large → if possible, use a shorter tool ▲ Damaged insert seat → check tool, replace if necessary ▲ Clamping device stability too low → increase stability
		Hole tapers in <ul style="list-style-type: none"> ▲ Chip jam on the outer cutting edge → use a different chip breakage geometry, increase the feed if necessary ▲ Material very soft → increase the cutting speed, reduce the feed ▲ Use positive cutting edge geometry ▲ Axial adjustment of the centering tip not optimal → adjust according to the setting sheet in the operating instructions
		Hole tapers out <ul style="list-style-type: none"> ▲ Chip jam on the inner cutting edge → use a different chip breakage geometry, increase the feed if necessary
		Poor surface quality <ul style="list-style-type: none"> ▲ Poor chip evacuation → optimize the cutting parameters: Increase the cutting speed, reduce the feed
		Built-up edge <ul style="list-style-type: none"> ▲ Cutting speed too low → increase cutting speed ▲ Indexable insert too negative → use positive geometry ▲ Unsuitable coating → select the correct coating
		Friction marks on the tool body <ul style="list-style-type: none"> ▲ Drill diameter too small → check the setting ▲ Chip evacuation problems → optimize the cutting parameters, check the geometry of the indexable insert ▲ Cutting radius too large → use the correct cutting radius ▲ Chips stuck on the guide pads, broken guide pads, the guide pads do not have to be used for base elements of <math>< 6xD</math>
Stationary application		Significant wear on one side of the centering tip <ul style="list-style-type: none"> ▲ Tool not centered → tool turret/adapter may have moved → recalibrate the machine
		Single-sided retract marks <ul style="list-style-type: none"> ▲ Tool not centered → tool turret/adapter may have moved → recalibrate the machine
		Edge breakage on the outer cutting edge <ul style="list-style-type: none"> ▲ Feed too high → reduce feed ▲ Interrupted cut → switch to a tougher grade of indexable insert ▲ Cutting radius too small → use an indexable insert with a larger cutting radius
		Hole too small / too large with adjustable tools <ul style="list-style-type: none"> ▲ Machine is not in the X-0 position → move axis to correct position ▲ Machine axis has been moved → recalibrate the machine
Rotating application		Significant wear on one side of the centering tip <ul style="list-style-type: none"> ▲ Insufficient guiding → check length adjustment of the centering tip
		Edge breakage on the outer cutting edge <ul style="list-style-type: none"> ▲ Feed too high → reduce feed ▲ Interrupted cut → switch to a tougher grade of indexable insert ▲ Cutting radius too small → use an indexable insert with a larger cutting radius
		Hole too small / too large with adjustable tools <ul style="list-style-type: none"> ▲ Incorrect cutting radius used → use the correct cutting radius ▲ Incorrect adjustment setting → set the tool to the correct diameter

Grades Overview

CTPP430	<ul style="list-style-type: none"> ▲ Carbide, TiAlN-coated ▲ ISO P30 M25 S25 K30 N25 ▲ The universal high-performance grade for steel, austenitic steel and heat-resistant alloys. 	BK8425	<ul style="list-style-type: none"> ▲ Carbide, TiAlN/TiN-coated ▲ ISO P25 M25 K25 N25 S25 H25 ▲ Universally applicable grade with increased wear resistance thanks to the innovative PVD coating in a multilayer design.
CTPP420	<ul style="list-style-type: none"> ▲ Carbide, TiCN-Al₂O₃-coated ▲ ISO P20 K20 ▲ The wear-resistant solution for steel and cast iron materials at high cutting speeds. 	BK8430	<ul style="list-style-type: none"> ▲ Carbide, TiAlN/TiN-coated ▲ ISO P25 M25 K25 N25 S25 H25 ▲ Fine-grain grade with high wear resistance ▲ Extreme edge stability and maximum wear resistance in the middle and top speed range
BK7710	<ul style="list-style-type: none"> ▲ Carbide, TiB₂-coated ▲ ISO N10 S10 O10 ▲ The wear-resistant grade with optimum cutting characteristics to prevent built-up edge formation for machining aluminium and titanium alloys. 	BK6115	<ul style="list-style-type: none"> ▲ Carbide, TiCN-TiN-Al₂O₃-coated ▲ ISO P20 M20 K20 H20 ▲ High-quality, surface-treated coating for machining cast iron materials under normal to stable conditions and high cutting speeds.
BK6425	<ul style="list-style-type: none"> ▲ Carbide, TiCN-Al₂O₃-TiN-coated ▲ ISO P25 M15 K20 ▲ The extremely wear-resistant grade for machining all steel and stainless materials. 	BK7935	<ul style="list-style-type: none"> ▲ Carbide, AlTiN-coated ▲ ISO P35 M30 K30 N30 S30 O30 ▲ The tough carbide grade for machining stainless steel and acid-resistant steels as well as special alloys.
BK62	<ul style="list-style-type: none"> ▲ Carbide, TiN-TiCN-Al₂O₃-coated ▲ ISO K15 H15 ▲ Special carbide grade for machining cast iron materials at high cutting speeds. Not suitable for machining aluminium materials. 	BK77	<ul style="list-style-type: none"> ▲ Carbide, TiN-coated ▲ ISO S10 H10 O10 ▲ The wear-resistant carbide grade for machining aluminium alloys, superalloys and plastics at medium cutting speeds.
BK79	<ul style="list-style-type: none"> ▲ Carbide, TiAlN-coated ▲ ISO P40 M35 K25 N30 ▲ Universally applicable grade with high wear-resistance ▲ low to medium cutting speed for roughing and finishing as well as interrupted cut 	BK7615	<ul style="list-style-type: none"> ▲ Carbide, TiCN-Al₂O₃-coated ▲ ISO K15 ▲ Highly productive grade with extreme edge stability for wet and dry machining of all cast iron materials

Chip breakers

-01	<ul style="list-style-type: none"> ▲ Universal geometry suitable for a wide range of materials ▲ Can be used for the center and peripheral insert 	-21	<ul style="list-style-type: none"> ▲ Soft cutting geometry that reduces cutting forces ▲ High positive chip breaker
-03	<ul style="list-style-type: none"> ▲ Geometry for chip breaking problems with excellent chip control at low feed rates ▲ WOEX BK8425 -03: Can only be used for the peripheral insert ▲ SOGX BK8425 -03: Suitable for the center and peripheral insert ▲ Main application in low alloyed and stainless steels 	-32	<ul style="list-style-type: none"> ▲ For the machining of steel and cast iron materials ▲ Minimised burr formation when entering and exiting the hole ▲ Reliable separation of disc-shaped residual material when the drill exits the hole
-11	<ul style="list-style-type: none"> ▲ Highly positive, minimally rounded chip breaker ▲ For soft cutting use ▲ Main application in aluminium 	-34	<ul style="list-style-type: none"> ▲ High-feed geometry ▲ Extremely sturdy indexable insert ▲ Designed specially for steel and cast iron materials
-13	<ul style="list-style-type: none"> ▲ The dome-shaped chip breaker results in more controlled breaking of the chips ▲ Can be used for center and periphery ▲ Suitable for unstable machining conditions due to the low cutting forces 		

Application

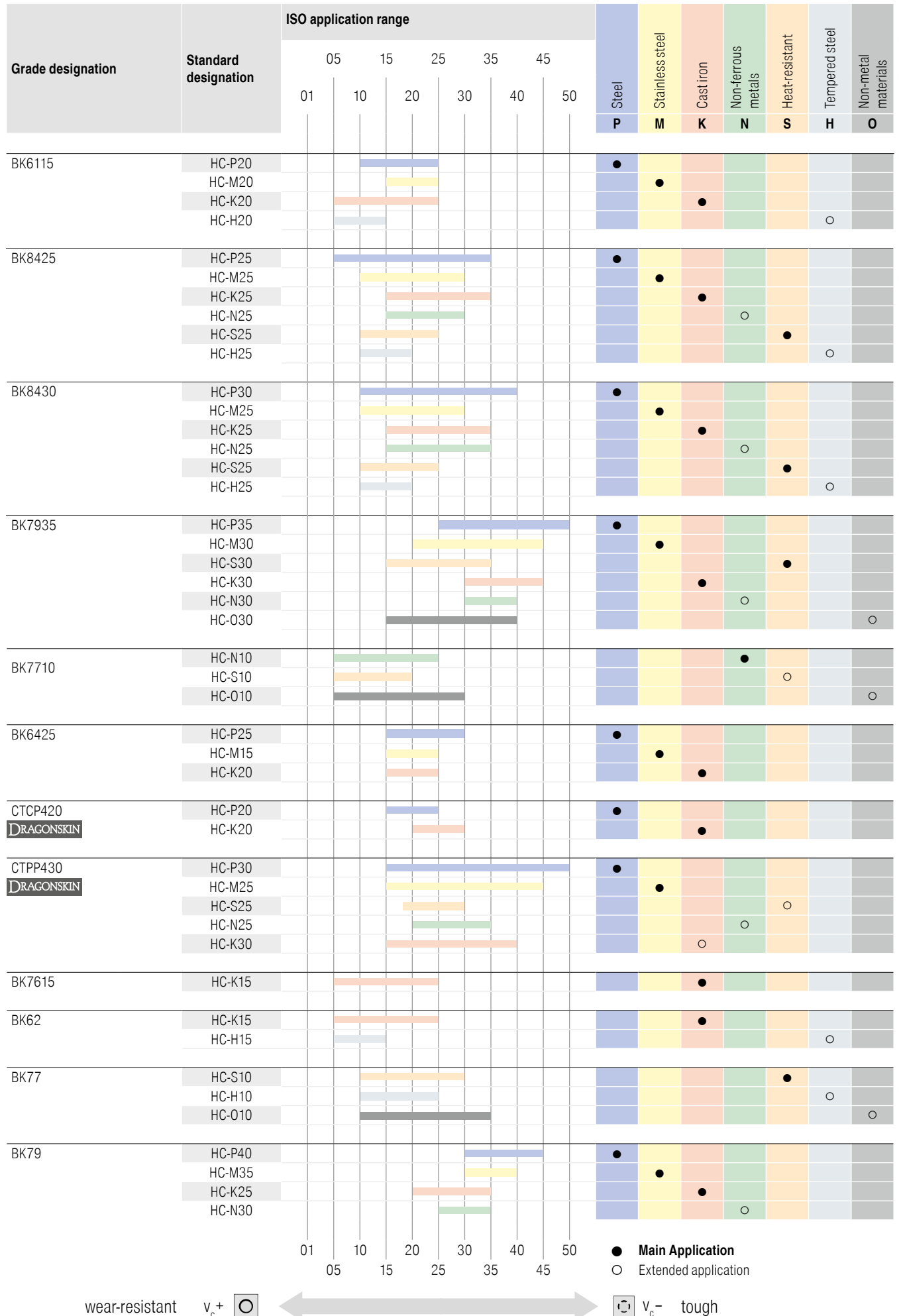





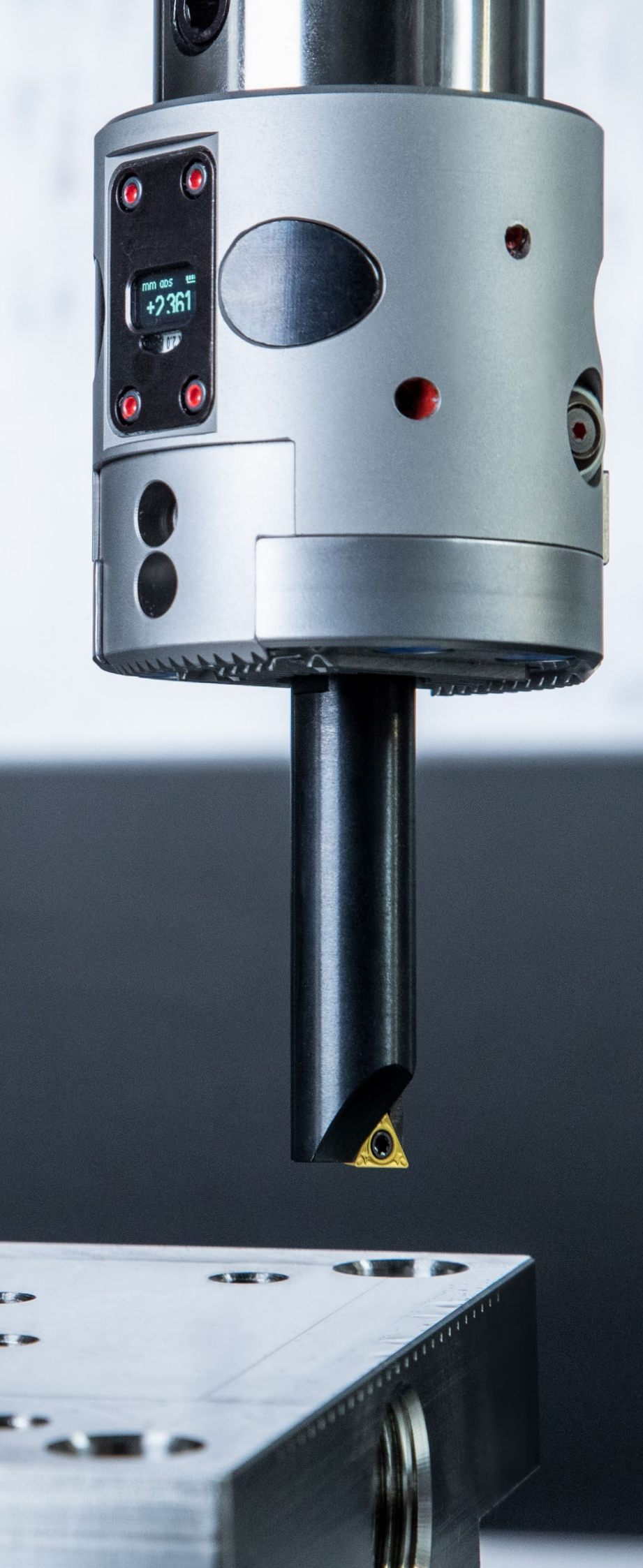

1 Indexable Drilling

Holemaking

2 Indexable Boring

2

3 Reaming

4 Indexable Turning

Turning

5 Parting and Grooving

6 Multifunction

Milling

7 Indexable Milling

8 Solid Milling

9 Material examples and
article no. index

Table of contents

Symbol explanation	2
Toolfinder	3
Contents Overview Accessories	4
Product program	5-19
Cutting Data	20-24
Technical Information	
Maximum speeds for two-edged systems	25
Selection of the rake angle and the cutting radius	26
Types of wear	27
Grade description	28
Chip breakers	29



KOMET \ Performance

Premium quality tools for high performance.

The premium quality tools from the **KOMET Performance** product line have been designed for specific applications and are distinguished by their outstanding performance. If you make high demands on the performance of your production and want to achieve the very best results, we recommend the Premium tools in this product line.

Symbol explanation

- F** Fine Machining
- M** Medium Machining
- R** Rough Machining

-  Smooth cut
-  Irregular cutting depth
-  Interrupted cut



Coolant supply central
Steep taper Form AD



KOMET ABS – modular coupling system for rotating and stationary tools



Coolant supply either via the flange or centrally

Micron-precise display resolution:
0.00005" in diameter



Modern, high contrast OLED display on the precision adjustment head itself

Universal ABS interface

Absolute position measuring system

Additional Bluetooth Low Energy interface for easy display on any conventional smartphone

System overview – MicroKom / TwinKom

System

Diameter range Ø 0.221 – 14.370 inch

BluFlex 2



5

hi.flex



6

ABS

TwinKom – G04















10

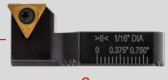

ABS

Accessories



Diameter range Ø 0.220 – 1.024 inch

- ABS32 boring bar  7
- Steel boring bar  7
- Boring bar, vibration-optimized  8
- Adapter  7
- Boring Bar  8
- Coolant diverting plug  9
- Insert holder  9
- Bridge  9
- Insert holder  9
- Serrated body  9
- Insert holder  9
- Support bridge  7

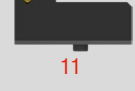

Indexable Insert

WOHX	TOEX / TOGX / TOHX
	
13	17-19

Diameter range Ø 1.181 – 8.031 inch

- Tool holder 90° radially adjustable  11
- Tool holder 80° radially adjustable  11
- Tool holder 80° radially adjustable  12

Indexable Insert

WOEX / WOGX	SOEX
	
14	16

Overview of ABS tool holders

Work with flexibility and process-security with the modular ABS coupling system for rotating and stationary tools.

CAT Taper shank holder on request.



ISO 7388-1 – SK steep taper holders

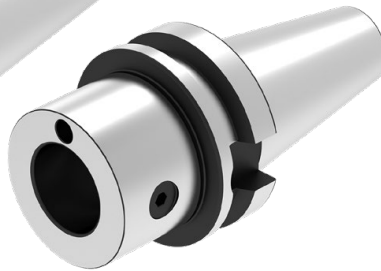

ISO 7388-2 – MAS-BT taper shank



HSK hollow taper adapters with face contact



ISO 26623-1 – PSC polygon hollow adapters with face contact



Additional metric items are available in our Online-Shop at cuttingtools.ceratizit.com and in the metric main catalog.



MicroKom – BluFlex 2 – precision adjustment head

- ▲ Via the free app (Android/IOS), an extended display can be transferred to a standard smartphone (62 840 16097)
- ▲ For MicroKom boring bars with Ø 0.630 inch or with ABS 32, MicroKom bridges, and serrated body
- ▲ With through coolant supply
- ▲ LSCX = Recess depth of boring bar

Scope of supply:

incl. Battery

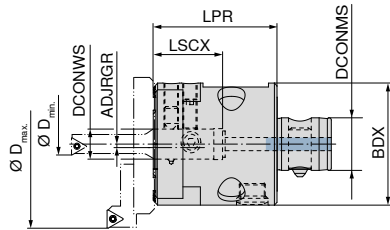

without Bluetooth with Bluetooth

D _{min} - D _{max} inch	KOMET no.	Adapter	DCONWS inch	DCONMS inch	BDX inch	LPR inch	LSCX inch	ADJRGR inch	without Bluetooth	with Bluetooth
0.221 -14.370	M04 30100	ABS 50	0.630	1.102	2.559	2.795	1.496	0.183	62 820 ...	62 840 ...
0.221 -14.370	M04 30000	ABS 50	0.630	1.102	2.559	2.795	1.496	0.183	16097	16097

Spare parts for Article no.	Image	Part Name	Article no.	Image	Part Name	Article no.	Image	Part Name	Article no.	Image	Part Name	Article no.
62 820 16097		Clamping screw	13989		Clamping screw	13700		Clamping screw	18600		Clamping sleeve	18500
62 840 16097		Clamping screw	13989		Clamping screw	13700		Clamping screw	18600		Clamping sleeve	18500
								Battery cover	18400			

Metric Adaptors can be found in our Online-Shop or in the Metric Catalog 2021



MicroKom – hi.flex – precision adjustment head

- ▲ for MicroKom boring bars with Ø 0.630 inch or ABS 32, MicroKom bridges, and serrated body
- ▲ with through coolant supply
- ▲ LSCX = Recess depth of boring bar

ABS

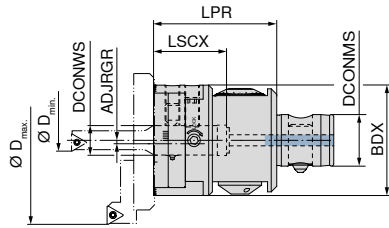

Analogue

67 800 ...

D _{min} - D _{max} inch	KOMET no.	Adapter	DCONWS inch	DCONMS inch	BDX inch	LPR inch	LSCX inch
0.221 - 14.370	M05 01600	ABS 50	0.630	1.102	2.362	2.638	1.575

12597

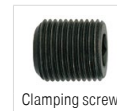

Clamping screw

62 950 ...

14700

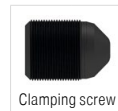

Clamping screw

62 950 ...

13989



Clamping screw

62 950 ...

13700

**Spare parts
for Article no.
67 800 12597**



Metric Adaptors can be found in our Online-Shop or in the Metric Catalog 2021



MicroKom – Steel boring bar for hi.flex, BluFlex 2

▲ With internal coolant supply

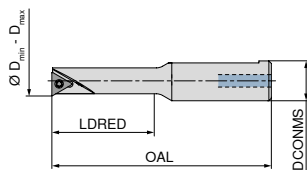

62 850 ...

D _{min} - D _{max} inch	KOMET no.	OAL inch	LDRED inch	DCONMS _{h6} inch	Insert	
0.236 - 0.315	B05 20100	2.823	0.827	0.630	WO.. 02T0	00600
0.315 - 0.472	B05 20120	3.047	1.102	0.630	TO.. 06T1	00800
0.394 - 0.551	B05 20140	3.220	1.339	0.630	TO.. 0902	01000
0.472 - 0.709	B05 20160	3.472	1.654	0.630	TO.. 0902	01200
0.551 - 0.709	B05 20180	3.717	1.969	0.630	TO.. 0902	01400
0.709 - 0.984	B05 20220	3.937	2.362	0.630	TO.. 0902	01800
0.866 - 1.024	B05 20260	4.252	2.697	0.630	TO.. 1403	02200



TORX® Screws

62 950 ...

Spare parts

Insert	
TO.. 06T1	12800
TO.. 0902	12000
TO.. 1403	12600
WO.. 02T0	11800

MicroKom – Boring bar

▲ With internal coolant supply

ABS

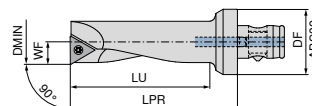

62 857 ...

DMIN inch	KOMET no.	WF inch	DF inch	LU inch	LPR inch	Insert	
0.311	B00 25610	0.156	1.260	1.102	1.654	TO.X 06T1..	07989
0.350	B00 25700	0.175	1.260	1.339	1.890	TO.X 06T1..	21989
0.390	B00 25620	0.195	1.260	1.339	1.890	TO.X 06T1..	08989
0.429	B00 25710	0.215	1.260	1.693	2.244	TO.X 0902..	23989
0.469	B00 25630	0.234	1.260	1.693	2.244	TO.X 0902..	09989
0.547	B00 25640	0.274	1.260	1.969	2.520	TO.X 0902..	10989
0.626	B00 25650	0.313	1.260	2.283	2.835	TO.X 0902..	11989
0.705	B00 25661	0.352	1.260	2.323	2.835	TO.X 0902..	13989
0.783	B00 25671	0.390	1.260	2.756	3.228	TO.X 0902..	15989
0.862	B00 25681	0.429	1.260	2.756	3.228	TO.X 0902..	17989
0.941	B00 25691	0.469	1.260	2.756	3.228	TO.X 0902..	19989



TORX® Screws

62 950 ...

Spare parts

Insert	
TO.X 06T1..	12800
TO.X 0902..	12000

MicroKom – Spindle tool

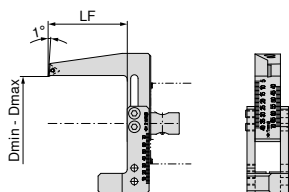

62 866 ...

D _{min} - D _{max} inch	KOMET no.	LF inch	Insert	
0.197 - 2.756	M05 90300	2.283	TO.X 0902..	07000



Cylindrical screw

TORX® Screws

62 950 ...

62 950 ...

Spare parts

Insert	
TO.X 0902..	26800

MicroKom – Adapter

▲ for 62 852 ..., 62 853 ..., 62 856 ... (essential for using the boring bar)

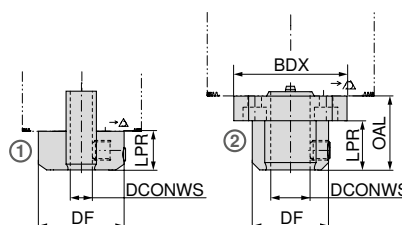

62 851 ...

DCONWS inch	KOMET no.	OAL inch	BDX inch	DF inch	LPR inch	Fig.	
0.236	M05 90200			1.220	0.630	1	00600
0.315	M05 90210			1.220	0.630	1	00800
0.394	M05 90220	0.984	1.811	1.220	0.591	2	01000
0.472	M05 90230	0.984	1.811	1.220	0.591	2	01200
0.630	M05 90240	1.181	1.811	1.220	0.787	2	01600



Cylindrical screw

Clamping screw

62 950 ...

62 950 ...

Spare parts

DCONWS	
0.236 - 0.315	44800
0.394 - 0.472	44800
0.630	14700

Suitable inserts can be found on → Page 14–19.

MicroKom – Boring bar

- ▲ can only be used with adapter 62 851 ...
- ▲ with internal coolant supply

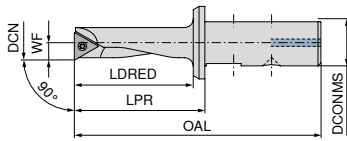

62 856 ...

DCN	KOMET no.	OAL	LPR	DCONMS	WF	LDRED	Insert	
inch		inch	inch	inch	inch	inch		
0.220	B00 37010	1.890	1.024	0.315	0.108	0.866	WOHX 02T0..	05600
0.256	B00 37020	2.047	1.181	0.315	0.126	1.024	WOHX 02T0..	06500
0.315	B00 15510	2.244	1.378	0.315	0.156	1.102	TO.X 06T1..	08000
0.315	B00 15610	2.953	1.378	0.630	0.156	1.181	TO.X 06T1..	00800
0.394	B00 15620	3.150	1.575	0.630	0.195	1.378	TO.X 0902..	01000
0.433	B00 15710	3.346	1.772	0.630	0.215	1.575	TO.X 0902..	01100
0.472	B00 15530	2.638	1.772	0.630	0.234	1.496	TO.X 0902..	11200
0.472	B00 15630	3.346	1.772	0.630	0.234	1.575	TO.X 0902..	01200
0.551	B00 15640	3.543	1.969	0.630	0.274	1.772	TO.X 0902..	01400
0.630	B00 15650	3.740	2.165	0.630	0.313	1.969	TO.X 0902..	01600
0.709	B00 15661	3.937	2.362	0.630	0.352	2.165	TO.X 0902..	01800
0.748	B00 15751	4.134	2.559	0.630	0.372	2.362	TO.X 0902..	01900
0.787	B00 15671	4.134	2.559	0.630	0.390	2.362	TO.X 0902..	02000
0.866	B00 15681	4.134	2.559	0.630	0.429	2.362	TO.X 0902..	02200
0.945	B00 15691	4.134	2.559	0.630	0.469	2.362	TO.X 0902..	02400



TORX® Screws

62 950 ...

Spare parts

DCN		
0.220 - 0.256		11800
0.315 - 0.394		12800
0.433 - 0.945		12000

MicroKom – Carbide boring shank

- ▲ for boring head 62 854 ...
- ▲ can only be used with adapter 62 851 ...
- ▲ with internal coolant supply

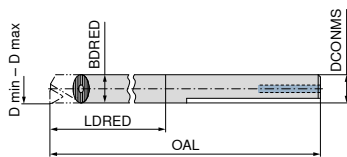

62 853 ...

D _{min} - D _{max}	KOMET no.	OAL	DBRED	LDRED	DCONMS	
inch		inch	inch	inch	inch	
0.512 - 0.669	G10 12060	4.724	0.472	2.953	0.472	01300
0.669 - 0.866	G10 12070	5.512	0.630	3.937	0.630	01700
0.866 - 1.024	G10 12080	5.512	0.630	3.937	0.630	02200

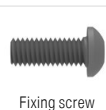

Fixing screw

62 950 ...

Spare parts

DCONMS	
0.472	19700
0.630	19800

MicroKom – Boring bar, vibration-optimized

- ▲ can only be used with adapter 62 851 ...
- ▲ with internal coolant supply

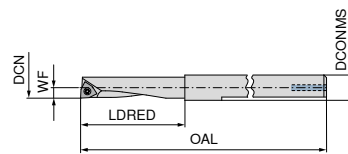

62 852 ...

DCN	KOMET no.	OAL	LDRED	DCONMS	Insert	
inch		inch	inch	inch		
0.220	B00 30280	2.559	0.866	0.236	WOHX 02T0..	10600
0.272	B00 30290	3.150	1.417	0.236	WOHX 02T0..	00600 ¹⁾
0.354	B00 00680	3.543	0.945	0.315	TO.X 06T1..	00800 ¹⁾
0.433	B00 00690	3.740	1.969	0.394	TO.X 06T1..	01000 ¹⁾

1) Carbide version



TORX® Screws

62 950 ...

Spare parts

Insert	
TO.X 06T1..	09700
WOHX 02T0..	11800

MicroKom – Boring head

- ▲ for boring shank 62 853 ...

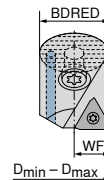

62 854 ...

D _{min} - D _{max}	KOMET no.	WF	DBRED	Insert	
inch		inch	inch		
0.518 - 0.591	G10 12621	0.254	0.472	TO.X 0902..	01300
0.591 - 0.669	G10 12841	0.333	0.630	TO.X 0902..	01500
0.669 - 0.748	G10 12711	0.333	0.472	TO.X 0902..	01700
0.748 - 0.866	G10 12861	0.372	0.630	TO.X 0902..	01900
0.866 - 1.024	G10 12731	0.431	0.630	TO.X 0902..	02200



TORX® Screws

62 950 ...

Spare parts

Insert	
TO.X 0902..	12000

Suitable inserts can be found on → Page 14–19.

MicroKom – Bridge for hi.flex, BluFlex 2

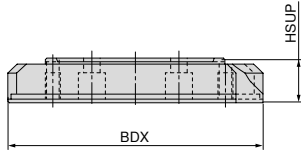

62 860 ...					
D _{min} - D _{max} inch	KOMET no.	BDX inch	HSUP inch	WT inch	
3.543 - 4.921	M05 80101	3.346	0.472	0.147	12500
4.724 - 6.102	M05 80200	4.528	0.719	0.107	15500
5.906 - 7.283	M05 80300	5.709	0.797	0.152	18500
7.087 - 8.465	M05 80400	6.890	0.915	0.229	21500
8.267 - 9.646	M05 80500	8.071	0.984	0.309	24500
9.449 - 10.827	M05 80510	9.252	0.984	0.349	27500
10.630 - 12.008	M05 80520	10.433	0.984	0.394	30500
11.811 - 13.189	M05 80530	11.614	0.984	0.435	33500
12.992 - 14.370	M05 80540	12.795	0.984	0.478	36500



Cylindrical screw



Disk spring

62 950 ...

62 950 ...

Spare parts BDX

3.346 - 12.795

00000

19100

MicroKom – Insert holder for hi.flex, BluFlex 2

▲ With internal coolant supply

Scope of supply:

without inserts
incl. mounting screws

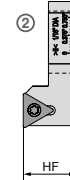
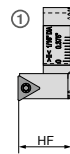

67 863 ...						
DCN inch	DCX inch	KOMET no.	HF inch	Insert	Fig.	
0.984	1.732	M05 20601	0.531	TO.. 06T1	1	04400
1.732	2.480	M05 20651	0.531	TO.. 0902	2	12500



TORX® Screws

62 950 ...

Spare parts Insert

TO.. 06T1

09700

TO.. 0902

09900

MicroKom – Serrated body for hi.flex, BluFlex 2

▲ With internal coolant supply

Scope of supply:

without insert holder

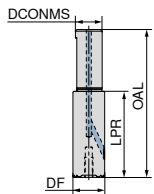

67 861 ...					
D _{min} - D _{max} inch	KOMET no.	DCONMS inch	OAL inch	LPR inch	DF inch
0.984 - 2.480	M05 90600	0.630	3.484	2.028	0.748



Cylindrical screw

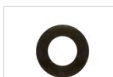

Disk spring

62 950 ...

62 950 ...

Spare parts for Article no.

67 861 06300

00000

19100

MicroKom – Coolant diverting plug for hi.flex

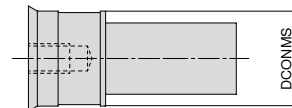

62 862 ...		
DCONMS inch	KOMET no.	
0.630	M05 90501	09300



Suitable inserts can be found on → Page 14–19.

TwinKom – Base body

Scope of supply:

Clamping plate incl. adjustment and fixing screws
Order tool holder and indexable inserts separately

ABS

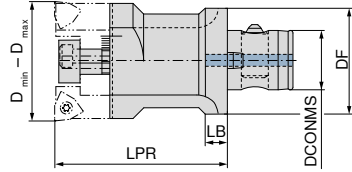

D _{min} - D _{max} inch	KOMET no.	DCONMS inch	DF inch	Adapter	LPR inch	LB inch	62 881 ...	
							short	long
1.181 - 1.575	G04 00500	0.512	0.984	ABS 25	1.969		04190	
1.575 - 2.008	G04 01010	0.630	1.260	ABS 32	2.362		05189	
1.181 - 1.575	G04 01000	0.630	1.260	ABS 32	3.346	0.295		44189
2.008 - 2.677	G04 01510	0.787	1.575	ABS 40	2.362		07188	
1.575 - 2.008	G04 01500	0.787	1.575	ABS 40	4.724	0.335		45188
2.677 - 3.425	G04 02010	1.102	1.969	ABS 50	2.756		09197	
2.677 - 3.425	G04 02020	1.102	1.969	ABS 50	5.315			49197
2.008 - 2.677	G04 02000	1.102	1.969	ABS 50	5.315	0.413		47197
3.425 - 4.567	G04 02500	1.339	2.480	ABS 63	2.756		12196	
3.425 - 4.567	G04 02510	1.339	2.480	ABS 63	6.102			52196
4.567 - 6.024	G04 03000	1.811	3.150	ABS 80	3.543		15792	
4.567 - 6.024	G04 03010	1.811	3.150	ABS 80	6.890			55792
6.024 - 8.031	G04 03500	2.205	3.937	ABS 100	4.921		20491	

Spare parts D _{min} - D _{max}	Cylindrical screw TwinKom		Adjustment screw		TwinKom clamping plate
	62 950 ...	84 950 ...	10 950 ...	62 950 ...	62 950 ...
1.181 - 1.575	45500			53800	55000
1.575 - 2.008	45600		11200		55100
2.008 - 2.677	54400			53900	55200
2.677 - 3.425		42600		54000	55300
3.425 - 4.567	54500			54100	55400
4.567 - 6.024	54600			54200	55500
6.024 - 8.031	54700			54300	55600

TwinKom – Tool holder 90°

▲ radially adjustable

Scope of supply:

including pair of holders and clamping screws
Order indexable inserts separately

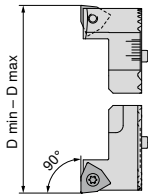

67 871 ...

D _{min} - D _{max} inch	KOMET no.	Insert
1.181 - 1.614	G03 60410	WO.X 05T3
1.535 - 2.008	G03 60420	WO.X 06T3
1.929 - 2.795	G03 60430	WO.X 06T3
2.520 - 3.853	G03 60440	WO.X 0804
3.268 - 4.764	G03 60450	WO.X 1005
4.291 - 6.181	G03 60460	WO.X 1005
5.472 - 8.031	G03 60470	WO.X 1206

04100
05100
07100
09800
12100
15700
20400

TwinKom – Tool holder 80°

▲ radially adjustable

Scope of supply:

including pair of holders and clamping screws
Order indexable inserts separately

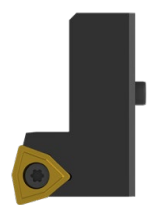
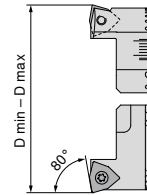

67 875 ...

D _{min} - D _{max} inch	KOMET no.	Insert
1.181 - 1.614	G03 50410	WO.X 05T3
1.535 - 2.008	G03 50420	WO.X 06T3
1.929 - 2.795	G03 50430	WO.X 06T3
2.520 - 3.853	G03 50440	WO.X 0804
3.268 - 4.764	G03 50450	WO.X 1005
4.291 - 6.181	G03 50460	WO.X 1005
5.472 - 8.031	G03 50470	WO.X 1206

04100
05100
07100
09800
12100
15700
20400

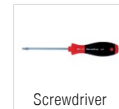

Screwdriver

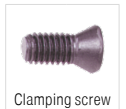

Clamping screw

80 950 ...

10 950 ...

Spare parts

for Article no.

67 875 04100 / 67 871 04100
67 875 05100 / 67 871 05100
67 875 07100 / 67 871 07100
67 875 09800 / 67 871 09800
67 875 12100 / 67 871 12100
67 875 15700 / 67 871 15700
67 875 20400 / 67 871 20400

125 10500
127 10600
127 10600
128 12700
128 12700
128 12700
129 17400

Suitable inserts can be found on → **Page 14+15.**

TwinKom – depths of cut

a _{p max}	P	M	K	N	S
WO.X 05T3	0.177	0.138	0.197	0.197	0.138
WO.X 05T6	0.236	0.157	0.236	0.236	0.157
WO.X 0804	0.295	0.236	0.295	0.295	0.236
WO.X 1005	0.354	0.354	0.354	0.354	0.354
WO.X 1206	0.354	0.354	0.354	0.354	0.354

Further cutting data can be found on → **pages 20**

Metric Adaptors can be found in our Online-Shop or in the Metric Catalog 2021



TwinKom – Tool holder 80°

▲ radially adjustable

Scope of supply:

including pair of holders and clamping screws
Order indexable inserts separately

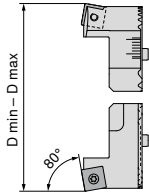

67 872 ...

D _{min} - D _{max} inch	KOMET no.	Insert	
1.181 - 1.614	G03 80200	SOEX 07T308	04100
1.535 - 2.008	G03 80211	SOEX 090408	05100
1.929 - 2.795	G03 80220	SOEX 090408	07100
2.520 - 3.853	G03 80230	SOEX 120508	09800
3.268 - 4.764	G03 80240	SOEX 120508	12100
4.291 - 6.181	G03 80250	SOEX 120508	15700
5.472 - 8.031	G03 80260	SOEX 120508	20400



Screwdriver

80 950 ...



Clamping screw

10 950 ...

Spare parts

D _{min} - D _{max}		
1.181 - 1.614	125	10800
1.535 - 2.008	128	10300
1.929 - 2.795	128	10300
2.520 - 3.853	129	10400
3.268 - 4.764	129	10400
4.291 - 6.181	129	10400
5.472 - 8.031	129	10400

TwinKom – depths of cut

a _{p max}	P	M	K	N
SOEX 07T308	0.177	0.138	0.197	0.197
SOEX 090408	0.236	0.157	0.236	0.236
SOEX 120508	0.354	0.354	0.354	0.354

 Further cutting data can be found on → **pages 20**

 Metric Adaptors can be found in our Online-Shop or in the Metric Catalog 2021



WOHX

Designation	L inch	S inch	D1 inch	IC inch
WOHX 02T0..	0.102	0.047	0.079	0.157

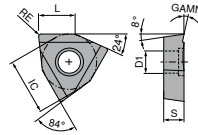

2

WOHX

-G12 BK2710	-G12 BK8440	-G12 K10
F WOHX	F WOHX	F WOHX
62 600 ...	62 600 ...	62 600 ...
	10102	00102
		20102

ISO	KOMET no.	RE inch
02T001EL	W00 04120.018440	0.004
02T001EL	W00 04120.012710	0.004
02T001FL	W00 04120.0121	0.004

P	•	•	
M	•	•	
K	•	•	
N			•
S			•
H		•	
O			•



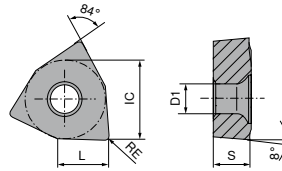

→ v. Page 21

WOGX / WOEX

Designation	L inch	S inch	D1 inch	IC inch
WOEX 0302..	0.126	0.091	0.091	0.197
WOEX 0403..	0.161	0.125	0.100	0.250
WO.X 05T3..	0.209	0.150	0.112	0.315
WO.X 06T3..	0.260	0.150	0.159	0.394
WO.X 0804..	0.311	0.189	0.193	0.472
WOEX 0804..	0.311	0.189	0.195	0.472
WOEX 1005..	0.390	0.209	0.193	0.591
WOEX 1206..	0.457	0.236	0.236	0.693



WOGX / WOEX

NEW	NEW			
-15 BK8430	-02 BK6440	-11 BK77	-11 BK7710	-01 BK8425
				
WOGX	WOEX	WOEX	WOEX	WOEX
10 821 ...	10 821 ...	10 821 ...	10 821 ...	10 821 ...

ISO	KOMET no.	RE inch	10 821 ...	10 821 ...	10 821 ...	10 821 ...	10 821 ...
030204	W29 10110.0477	0.016			80311		
030204	W29 10010.048425	0.016					30301
030204	W29 10110.047710	0.016				90311	
040304	W29 18110.047710	0.016				90411	
040304	W29 18010.048425	0.016					30401
040304	W29 18110.0477	0.016			80411		
05T304	W29 24110.0477	0.016			80511		
05T304	W29 24010.048425	0.016					30501
05T304	W29 24110.047710	0.016				90511	
05T304	W29 24020.046440	0.016		25502			
05T304	W29 24150.048430	0.016	00515				
06T304	W29 34110.0477	0.016			80611		
06T304	W29 34010.048425	0.016					30601
06T304	W29 34110.047710	0.016				90611	
06T304	W29 34020.046440	0.016		25602			
06T304	W29 34150.048430	0.016	00615				
080404	W29 42110.0477	0.016			80811		
080404	W29 42010.048425	0.016					30801
080404	W29 42110.047710	0.016				90811	
080404	W29 42020.046440	0.016		25802			
080404	W29 42150.048430	0.016	00815				
100504	W29 50110.0477	0.016			81011		
100504	W29 50010.048425	0.016					31001
100504	W29 50110.047710	0.016				91011	
100504	W29 50020.046440	0.016		26002			
100508	W29 50010.088425	0.031					39001
120608	W29 58020.086440	0.031		21202			
P			○	●			●
M			○	●			●
K			○				●
N						●	○
S			●		●		
H			●		○		○
O					○		

→ v_c Page 23

WOEX

2



10 821 ...	10 821 ...	10 821 ...
	40301	05301
50301		
	40401	05401
50401		
	40501	05501
50501		
	40601	05601
50601		
	40801	05801
	41001	08001
	41201	08201

ISO	KOMET no.	RE inch
030204	W29 10010.046115	0.016
030204	W29 10010.047615	0.016
030204	W29 10010.047935	0.016
040304	W29 18010.046115	0.016
040304	W29 18010.047615	0.016
040304	W29 18010.047935	0.016
05T304	W29 24010.046115	0.016
05T304	W29 24010.047615	0.016
05T304	W29 24010.047935	0.016
06T304	W29 34010.046115	0.016
06T304	W29 34010.047615	0.016
06T304	W29 34010.047935	0.016
080404	W29 42010.046115	0.016
080404	W29 42010.047615	0.016
100504	W29 50010.046115	0.016
100508	W29 50010.087615	0.031
120608	W29 58010.086115	0.031
120608	W29 58010.087615	0.031

P	●	●	
M	●	●	
K	●	●	●
N	○		
S	●		
H		○	
O			

→ v_c Page 23

SOEX

Designation	L inch	IC inch	D1 inch	S inch
SOEX 0502..	0.219	0.219	0.091	0.094
SOEX 0603..	0.250	0.250	0.104	0.125
SOEX 07T3..	0.313	0.313	0.112	0.141
SOEX 0904..	0.375	0.375	0.161	0.172
SOEX 1205..	0.500	0.500	0.205	0.203

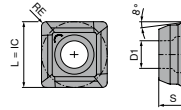

SOEX

NEW

-01
BK8425



SOEX
10 822 ...

NEW

-01
BK7615



SOEX
10 822 ...

NEW

-01
BK7935



SOEX
10 822 ...

ISO	KOMET no.	RE inch	10 822 ...	10 822 ...	10 822 ...
050204	W83 13010.047615	0.016		05501	50501
050204	W83 13010.047935	0.016			
050204	W83 13010.048425	0.016	30501		50601
060306	W83 18010.067615	0.024		05601	
060306	W83 18010.067935	0.024			50601
060306	W83 18010.068425	0.024	30601		
07T308	W83 23010.087615	0.031		05701	
07T308	W83 23010.087935	0.031			50701
07T308	W83 23010.088425	0.031	30701		
090408	W83 32010.087615	0.031		05901	
090408	W83 32010.087935	0.031			50901
090408	W83 32010.088425	0.031	30901		
120508	W83 44010.087615	0.031		06201	
120508	W83 44010.087935	0.031			51201
120508	W83 44010.088425	0.031	31201		
P			●		●
M			●		●
K			●	●	●
N			○		○
S			●		●
H			○		
O					○

→ v_c Page 24

TOGX

Designation	L inch	S inch	D1 inch	IC inch
TOGX 06T1..	0.261	0.071	0.087	0.157
TOGX 0902..	0.359	0.098	0.110	0.220
TOGX 1403..	0.536	0.118	0.150	0.323

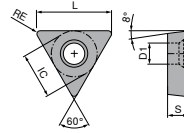

2

TOGX

	NEW -18 CK32	-14 CK3230	NEW -14 CK3230	-14 BK60
	F TOGX	F TOGX	F TOGX	F TOGX
	62 607 ...	62 601 ...	62 606 ...	62 601 ...
		53202		90206
	20401		10201	
		54002		70409
	21401		11401	
		54602		70414
	22601		12601	

ISO	KOMET no.	RE inch
06T102EN	W57 04140.023210	0.008
06T102EN	W57 04140.0260	0.008
06T102EN	W57 04140.023230	0.008
06T102EN	W57 04180.0432	0.016
090204EN	W57 14140.043210	0.016
090204EN	W57 14140.0460	0.016
090204EN	W57 14140.043230	0.016
090204EN	W57 14180.0432	0.016
140304EN	W57 26140.043210	0.016
140304EN	W57 26140.0460	0.016
140304EN	W57 26140.043230	0.016
140304EN	W57 26180.0432	0.016

P	•	•	•	•
M	•	•	•	•
K				•
N				
S				
H				
O				

→ v_c Page 21

TOGX

ISO	KOMET no.	RE inch				
			62 607 ...	62 601 ...	62 601 ...	62 601 ...
06T102EN	W57 04180.048430	0.016	30401			
06T102FN	W57 04120.027710	0.008		70201		
06T102FN	W57 04120.0223	0.008			50206	
06T102TN	W30 04990.0240	0.008				60206
090204EN	W57 14180.048430	0.016	31401			
090204FN	W57 14120.047710	0.016		70401		
090204FN	W57 14120.0423	0.016			50409	
090204TN	W30 14990.0440	0.016				60409
140304EN	W57 26180.048430	0.016	32601			
140304FN	W57 26120.0423	0.016			50414	
140304TN	W30 26990.0440	0.016				62600
P			○			
M			○			
K			○			
N				●		●
S			●			●
H			●			●
O						●

→ v. Page 21

TOEX / TOHX / TOGX

Designation	L inch	S inch	D1 inch	IC inch	LE inch
TO.X 0902..	0.359	0.098	0.110	0.220	-
TOEX 06T1..	0.261	0.071	0.087	0.157	0.071
TOEX 0902..	0.359	0.098	0.110	0.220	0.106
TOEX 1403..	0.536	0.118	0.150	0.323	0.106
TOGX 06T1..	0.261	0.071	0.087	0.157	-
TOHX 06T1..	0.256	0.071	0.087	0.157	-
TOHX 1403..	0.536	0.118	0.150	0.323	-

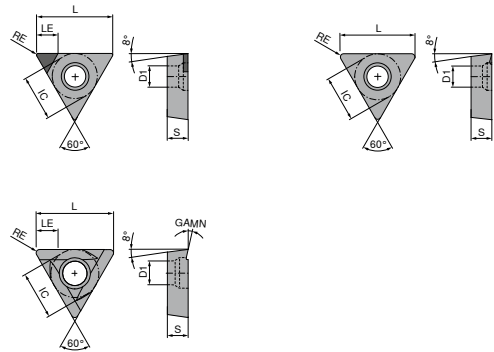

2

TOEX / TOHX / TOGX

ISO	KOMET no.	RE inch	CTDPU20 NEW	-G12 BK8425 NEW	-14 BK8430	-G06 BK2710 NEW	-G06 BK6110	-G06 BK7615 NEW
			DIAMOND	TOHX	TOGX	TOHX	TOHX	TOHX
			62 605 ...	62 603 ...	62 601 ...	62 602 ...	62 602 ...	62 602 ...
06T102EN	W57 04140.028430	0.008			30201			
06T102FN	W30 04990.025510	0.008	00201					
06T103EL	W30 04120.038425	0.012		30200				
06T103EL	W30 04060.036110	0.012					40606	
06T103EL	W30 04060.032710	0.012				10606		
090204EL	W30 14060.042710	0.016				10409		
090204EL	W30 14060.046110	0.016					40409	
090204EL	W30 14120.048425	0.016		31800				
090204EN	W57 14140.048430	0.016			30401			
090204FN	W30 14990.045510	0.016	01401					
140304EL	W30 26120.048425	0.016		32600				
140304EL	W30 26060.047615	0.016						82600
140304EL	W30 26060.046110	0.016					40414	
140304EL	W30 26060.042710	0.016				12600		
140304FN	W30 26990.045510	0.016	02601					
P			●	○	○	●	●	
M			●	○	○	●	●	
K			●	○	○	●	●	●
N			●					
S				●	●			
H				○	●		●	
O			●					

→ v_c Page 21

Material examples for cutting data tables

	Material sub-group	Index	Composition / Structure / Heat treatment	Tensile strength lbf/in ² / HB / HRC	Material number	Material designation	Material number	Material designation
P	Unalloyed steel	P.1.1	< 0.15 % C Annealed	60900 lbf/in ² / 125 HB	1.0401	1015	1.0301	1010
		P.1.2	< 0.45 % C Annealed	92800 lbf/in ² / 190 HB	1.1191	1045	1.0737	12L14
		P.1.3	< 0.45 % C Tempered	121800 lbf/in ² / 250 HB	1.1191	1045	1.0503	1043
		P.1.4	< 0.75 % C Annealed	132000 lbf/in ² / 270 HB	1.1223	1060	1.0535	1055
		P.1.5	< 0.75 % C Tempered	146500 lbf/in ² / 300 HB	1.1223	1060	1.1274	1095
	Low-alloy steel	P.2.1	Annealed	88500 lbf/in ² / 180 HB	1.7131	5115	1.6523	8620
		P.2.2	Tempered	134900 lbf/in ² / 275 HB	1.7131	5115	1.6582	4340
		P.2.3	Tempered	146500 lbf/in ² / 300 HB	1.7225	4142	1.7131	5115
		P.2.4	Tempered	174000 lbf/in ² / 375 HB	1.7225	4142	1.7223	4140
	High-alloy steel and high-alloy tool steel	P.3.1	Annealed	98600 lbf/in ² / 200 HB	1.4021	420	1.2379	D2
		P.3.2	Hardened and tempered	159500 lbf/in ² / 300 HB	1.2343	H11	1.3343	M2
		P.3.3	Hardened and tempered	188500 lbf/in ² / 400 HB	1.2343	H11	1.2363	A2
	Stainless steel	P.4.1	Ferritic / martensitic Annealed	98600 lbf/in ² / 200 HB	1.4016	430	1.4125	440C
		P.4.2	Martensitic Tempered	117500 lbf/in ² / 250 HB	1.4112	S44003	1.4021	420
M	Stainless steel	M.1.1	Austenitic / austenitic-ferritic Quenched	88500 lbf/in ² / 200 HB	1.4301	304	1.4401	316
		M.2.1	Austenitic Tempered	300 HB	1.4841	314	1.4568	17-7 PH
		M.3.1	Austenitic / ferritic (Duplex)	113100 lbf/in ² / 230 HB	1.4462	S32205	1.4410	S32750
K	Grey cast iron	K.1.1	Pearlitic / ferritic	88500 lbf/in ² / 180 HB	0.6010	A48-20B	0.6025	A48-40 B
		K.1.2	Pearlitic (martensitic)	127600 lbf/in ² / 260 HB	0.6030	A48-45B	0.6040	A48-60 B
	Spherulitic graphite cast iron	K.2.1	Ferritic	78300 lbf/in ² / 160 HB	0.7040	60-40-18	0.7050	65-45-12
		K.2.2	Pearlitic	122600 lbf/in ² / 250 HB	0.7070	100-70-03	0.7660	A439 Type D2
	Malleable iron	K.3.1	Ferritic	63800 lbf/in ² / 130 HB	0.8035	GTW-35-04		
		K.3.2	Pearlitic	113100 lbf/in ² / 230 HB	0.8170	70003		
N	Aluminium wrought alloy	N.1.1	Non-hardenable	60 HB	3.0255	A91060	3.0255	A91060
		N.1.2	Hardenable	49300 lbf/in ² / 100 HB	3.1355	2024	3.1355	2024
	Cast aluminium alloy	N.2.1	≤ 12 % Si, non-hardenable	36300 lbf/in ² / 75 HB	3.2581	A04130 / A413-0	3.2581	A04130 / A413-0
		N.2.2	≤ 12 % Si, hardenable	43500 lbf/in ² / 90 HB	3.2134	G-AISi5Cu1Mg		
		N.2.3	> 12 % Si, non-hardenable	63800 lbf/in ² / 130 HB		G-AISi17Cu4Mg		
	Copper and copper alloys (bronze/brass)	N.3.1	Free-machining alloys, PB > 1 %	54400 lbf/in ² / 110 HB	2.0380	CuZn39Pb2 (Ms58)	2.0380	C37700
		N.3.2	CuZn, CuSnZn	43500 lbf/in ² / 90 HB	2.0331	CuZn15	2.0331	C34000
		N.3.3	CuSn, lead-free copper and electrolytic copper	49300 lbf/in ² / 100 HB	2.0060	E-Cu57		
	Magnesium alloys	N.4.1	Magnesium and magnesium alloys	70 HB	3.5612	MgAl6Zn		
	S	Heat-resistant alloys	S.1.1	Fe - basis Annealed	98600 lbf/in ² / 200 HB	1.4864	X12NiCrSi 36-16	1.4864
S.1.2			Fe - basis	137800 lbf/in ² / 280 HB	1.4980	X6NiCrTiMoVB25-15-2	1.4980	S66286
S.2.1			Ni or Co basis Annealed	121800 lbf/in ² / 250 HB	2.4856	Inconel 625	2.4812	Hastelloy C
S.2.2			Ni or Co basis	171100 lbf/in ² / 350 HB	2.4952	Nimonic 80A	2.4668	Inconel 718
S.2.3			Cast	156600 lbf/in ² / 320 HB	2.4674	Nimocast PK24	2.4670	Nimocast 713
Titanium alloys		S.3.1	Pure titanium	5800 lbf/in ²	3.7025	Ti99,8		
		S.3.2	Alpha + beta alloys	152300 lbf/in ²	3.7165	TiAl6V4		
		S.3.3	Beta alloys	203100 lbf/in ² / 410 HB	Ti555.3	Ti-5Al-5V-5Mo-3Cr		
H	Hardened steel	H.1.1	Hardened and tempered	46-55 HRC				
		H.1.2	Hardened and tempered	56-60 HRC				
		H.1.3	Hardened and tempered	61-65 HRC				
		H.1.4	Hardened and tempered	66-70 HRC				
	Chilled iron	H.2.1	Cast	400 HB				
	Hardened cast iron	H.3.1	Hardened and tempered	55 HRC				
O	Non-metal materials	O.1.1	Plastics, duroplastic	≤ 21800 lbf/in ²				
		O.1.2	Plastics, thermoplastic	≤ 14500 lbf/in ²				
		O.2.1	Aramid fibre-reinforced	≤ 145000 lbf/in ²				
		O.2.2	Glass/carbon-fibre reinforced	≤ 145000 lbf/in ²				
		O.3.1	Graphite					

* Tensile Strength at Rupture (Rm)

Cutting data standard values for indexable inserts – MicroKom tools

Index	Indexable inserts for ...											
	62 820 ... / 62 840 ... / 62 800 ... / 62 815 ... / 62 810 ... / 62 858 ...											
	BK8440	BK8425	BK2710	K10	BK60	BK6110	BK7615	BK7710	CBN40	PKD5510 CTDPU20	CK3230	CK32
v _c ft/min												
P.1.1	560	660	750		890	980					1150	1150
P.1.2	560	660	750		890	980					1150	1150
P.1.3	560	660	750		890	980					1150	1150
P.1.4	490	590	690		820	980					1050	1050
P.1.5	490	590	690		820	980					1050	1050
P.2.1	460	520	590		690	890					920	920
P.2.2	460	520	590		690	890					920	920
P.2.3	460	520	590		690	890					920	920
P.2.4	460	520	590		690	890					920	920
P.3.1	390	460	520		620	820					820	820
P.3.2	390	460	520		620	820					820	820
P.3.3	390	460	520		620	820					820	820
P.4.1	330	390	460		520	720					690	690
P.4.2	330	390	460		520	720					690	690
M.1.1	460	520	590		920	720					920	920
M.2.1	390	460	520		820	720					820	820
M.3.1	300	330	390		590	660					590	590
K.1.1	490	590	690		690	950	950					
K.1.2	460	520	590		590	950	950					
K.2.1	390	460	520		520	890	890					
K.2.2	390	460	520		520	820	820					
K.3.1	330	390	460		460	720	720					
K.3.2	330	390	460		460	720	720					
N.1.1				820				1300		1640		
N.1.2				820				1300		1640		
N.2.1				820				1300		1640		
N.2.2				820				1300		1640		
N.2.3				820				1100		1640		
N.3.1				750				1100		1480		
N.3.2				750				1100		1480		
N.3.3				750				1100		1480		
N.4.1				750				1100		1480		
S.1.1		200	70									
S.1.2		160	70									
S.2.1		200	70									
S.2.2		160	70									
S.2.3		100	70									
S.3.1		330	200									
S.3.2		260	100									
S.3.3		160	100									
H.1.1	300	330				330			520			
H.1.2	230	260				260			610			
H.1.3	130	160				160			710			
H.1.4									790			
H.2.1	300	330				330						
H.3.1	230	260				260						
O.1.1				330						1640		
O.1.2				330						1640		
O.2.1										1640		
O.2.2				330						980		
O.3.1				330						980		

 The cutting data is significantly dependent on the external conditions, e.g. stability of the tool and workpiece clamping, material and machine type! The stated values are possible cutting data which have to be increased or reduced according to the application conditions! The specified values represent guideline cutting data that can be adjusted by approx. ± 20 % according to the usage conditions. It is essential to observe the v_c values of the type used, the maximum speeds of the system and the reduction of these maximum speeds depending on the type used overhang length. You can find these on pages 24 + 25.

Cutting data standard values for precision adjustment heads

Fine machining with depth of cut $a_p = 0.004 - 0.008$ inch

Index	hi.flex						<input checked="" type="radio"/> 1st choice <input type="radio"/> suitable		
	67 800 ...						Emulsion	Compressed air	MMS
	Ø .236"- .311"	Ø .315"- .469"	Ø .472"- .984"	Ø .984"- 1.732"	Ø 1.732"- 3.701"	Ø 3.701"- 2.559"			
	f in inch/rev.								
P.1.1	.002	.003	.004	.003	.004	.004	●	○	
P.1.2	.002	.003	.005	.004	.006	.006	●	○	
P.1.3	.002	.002	.005	.003	.005	.005	●	○	
P.1.4	.002	.002	.004	.003	.004	.004	●	○	
P.1.5	.002	.003	.005	.004	.006	.006	●	○	
P.2.1	.002	.002	.005	.003	.005	.005	●	○	
P.2.2	.002	.002	.004	.003	.004	.004	●	○	
P.2.3	.001	.002	.004	.003	.004	.004	●	○	
P.2.4	.001	.002	.002	.002	.002	.002	●	○	
P.3.1	.001	.002	.004	.002	.004	.004	●	○	
P.3.2	.001	.002	.003	.002	.003	.003	●	○	
P.3.3	.001	.002	.003	.002	.003	.003	●	○	
P.4.1	.001	.002	.004	.002	.004	.004	●	○	
P.4.2	.001	.002	.003	.002	.003	.003	●	○	
M.1.1	.000	.002	.004	.002	.004	.004	●	○	
M.2.1	.000	.002	.003	.002	.004	.004	●	○	
M.3.1	.000	.002	.003	.002	.003	.003	●	○	
K.1.1	.002	.004	.006	.006	.008	.008	○	●	
K.1.2	.002	.004	.006	.006	.008	.008	○	●	
K.2.1	.002	.003	.006	.004	.006	.006	○	●	
K.2.2	.001	.003	.005	.003	.005	.005	○	●	
K.3.1	.002	.003	.006	.004	.006	.006	○	●	
K.3.2	.001	.003	.005	.003	.005	.005	○	●	
N.1.1	.001	.002	.004	.003	.005	.005	●	○	
N.1.2	.001	.002	.004	.003	.005	.005	●	○	
N.2.1	.002	.003	.005	.004	.006	.006	●	○	
N.2.2	.002	.003	.005	.004	.006	.006	●	○	
N.2.3	.002	.003	.005	.004	.006	.006	●	○	
N.3.1	.001	.002	.003	.004	.006	.006	●	○	
N.3.2	.001	.002	.003	.004	.006	.006	●	○	
N.3.3	.002	.003	.006	.004	.006	.006	●	○	
N.4.1	.001	.002	.003	.004	.006	.006	●	○	
S.1.1	.000	.002	.003	.002	.003	.003	●	○	
S.1.2	.000	.001	.002	.002	.002	.002	●	○	
S.2.1	.000	.002	.003	.002	.003	.003	●	○	
S.2.2	.000	.001	.002	.002	.002	.002	●	○	
S.2.3	.002	.003	.002	.003	.003	.003	●	○	
S.3.1	.000	.002	.003	.002	.003	.003	●	○	
S.3.2	.000	.002	.003	.002	.003	.003	●	○	
S.3.3	.000	.001	.002	.001	.002	.002	●	○	
H.1.1	.000	.002	.003	.003	.003	.003		●	
H.1.2	.000	.002	.003	.002	.003	.003		●	
H.1.3	.000	.001	.002	.001	.002	.002		●	
H.1.4									
H.2.1	.000	.002	.003	.003	.003	.003		●	
H.3.1	.000	.002	.003	.002	.003	.003		●	
O.1.1	.000	.002	.002	.002	.002	.002	○	●	
O.1.2	.000	.002	.002	.002	.002	.002	○	●	
O.2.1									
O.2.2	.000	.001	.001	.002	.002	.002	○	●	
O.3.1	.000	.001	.001	.002	.002	.002	○	●	

 The cutting data is significantly dependent on the external conditions, e.g. stability of the tool and workpiece clamping, material and machine type! The stated values are possible cutting data which have to be increased or reduced according to the application conditions! The specified values represent guideline cutting data that can be adjusted by approx. $\pm 20\%$ according to the usage conditions. It is essential to observe the vc values of the type used (page 65 + 66), the maximum speeds of the system and the reduction of these maximum speeds depending on the type used overhang length. You can find these on pages 24 + 25.

Cutting data values for rough boring heads

Cutting depth $a_p = 0.138'' - 0.354''$

TwinKom G04 with WOEX / WOGX													● 1st choice ○ suitable		
67 881 ...													Emulsion	Compressed air	MMS
Index	BK8425	BK6440	BK6115	BK8430	BK77	Ø 1.181"- 1.614"	Ø 1.535"- 2.008"	Ø 1.929"- 2.795"	Ø 2.520"- 3.853"	Ø 3.268"- 4.764"	Ø 4.291"- 6.181"	Ø 5.472"- 8.031"			
f in inch/rev.															
P.1.1	660	790	980	660		.006	.007	.008	.009	.010	.011	.011	●	○	○
P.1.2	660	790	980	660		.006	.007	.008	.008	.009	.011	.011	●	○	○
P.1.3	660	720	980	660		.006	.007	.008	.008	.009	.011	.011	●	○	○
P.1.4	590	720	980	590		.006	.007	.008	.008	.009	.011	.011	●	○	○
P.1.5	590	720	980	590		.006	.007	.008	.008	.009	.011	.011	●	○	○
P.2.1	520	660	890	520		.006	.007	.007	.008	.009	.010	.010	●	○	○
P.2.2	520	660	890	520		.006	.007	.007	.008	.009	.010	.010	●	○	○
P.2.3	520	660	890	520		.006	.007	.007	.008	.009	.010	.010	●	○	○
P.2.4	520	660	890	520		.006	.007	.007	.008	.009	.010	.010	●	○	○
P.3.1	460	590	820	460		.006	.006	.007	.007	.009	.010	.010	●	○	○
P.3.2	460	520	820	460		.006	.006	.007	.007	.009	.010	.010	●	○	○
P.3.3	460	520	820	460		.006	.006	.007	.007	.009	.010	.010	●	○	○
P.4.1	390	460	720	390		.005	.006	.006	.006	.007	.008	.008	●	○	○
P.4.2	390	460	720	390		.005	.006	.006	.006	.007	.008	.008	●	○	○
M.1.1	520	660	720	520		.006	.006	.007	.007	.008	.009	.009	●	○	○
M.2.1	460	590	720	460		.005	.006	.006	.006	.007	.008	.008	●	○	○
M.3.1	330	520	660	330		.005	.006	.006	.006	.007	.008	.008	●	○	○
K.1.1	590		950	590		.009	.009	.010	.010	.012	.012	.012	○	●	○
K.1.2	520		950	520		.009	.009	.010	.010	.012	.012	.012	○	●	○
K.2.1	460		890	460		.009	.009	.010	.010	.012	.012	.012	○	●	○
K.2.2	460		820	460		.009	.009	.010	.010	.012	.012	.012	○	●	○
K.3.1	390		720	390		.008	.009	.009	.009	.010	.010	.010	○	●	○
K.3.2	390		720	390		.008	.009	.009	.009	.010	.010	.010	○	●	○
N.1.1					820	.006	.010	.010	.012	.014	.014	.014	●	○	○
N.1.2					820	.006	.010	.010	.012	.014	.014	.014	●	○	○
N.2.1					820	.006	.010	.010	.012	.014	.014	.014	●	○	○
N.2.2					820	.006	.010	.010	.012	.014	.014	.014	●	○	○
N.2.3					660	.006	.009	.009	.011	.013	.013	.013	●	○	○
N.3.1					820	.006	.010	.010	.012	.014	.014	.014	●	○	○
N.3.2					820	.006	.011	.011	.013	.014	.014	.014	●	○	○
N.3.3					820	.006	.010	.010	.012	.014	.014	.014	●	○	○
N.4.1					820	.006	.010	.010	.012	.014	.014	.014	●	○	○
S.1.1	200			200		.002	.003	.003	.003	.004	.004	.004	●	○	○
S.1.2	160			160		.002	.002	.002	.002	.003	.003	.003	●	○	○
S.2.1	200			200		.002	.003	.003	.003	.004	.004	.004	●	○	○
S.2.2	160			160		.002	.002	.002	.002	.003	.003	.003	●	○	○
S.2.3	100			100		.002	.002	.002	.002	.003	.003	.003	●	○	○
S.3.1	330			330		.002	.003	.003	.003	.004	.004	.004	●	○	○
S.3.2	260			260		.002	.003	.003	.003	.004	.004	.004	●	○	○
S.3.3	160			160		.002	.002	.002	.002	.003	.003	.003	●	○	○
H.1.1	330		330	330		.003	.003	.003	.003	.003	.003	.003		●	○
H.1.2	260		260	260		.002	.002	.002	.002	.002	.002	.002		●	○
H.1.3	160		160	160		.002	.002	.002	.002	.002	.002	.002		●	○
H.1.4															○
H.2.1	330		330	330		.002	.002	.002	.002	.002	.002	.002		●	○
H.3.1	260		260	260		.002	.002	.002	.002	.002	.002	.002		●	○
O.1.1															
O.1.2															
O.2.1															
O.2.2															
O.3.1															

 The cutting data is significantly dependent on the external conditions, e.g. stability of the tool and workpiece clamping, material and machine type! The stated values are possible cutting data which have to be increased or reduced according to the application conditions! The specified values represent guideline cutting data that can be adjusted by approx. $\pm 20\%$ according to the usage conditions. It is essential to observe the vc values of the type used, the maximum speeds of the system and the reduction of these maximum speeds depending on the type used overhang length. You can find these on pages 24 + 25.

Cutting data values for rough boring heads

Cutting depth $a_p = 0.138'' - 0.354''$

TwinKom G04 with SOEX										● 1st choice ○ suitable			
67 881 ...										Emulsion	Compressed air	MMS	
Index	BK8425	BK7935	BK7615	Ø 1.181"- 1.614"	Ø 1.535"- 2.008"	Ø 1.929"- 2.795"	Ø 2.520"- 3.853"	Ø 3.268"- 4.764"	Ø 4.291"- 6.181"				Ø 5.472"- 8.031"
f in inch/rev.													
P.1.1	660			.007	.009	.012	.014	.017	.019	.019	●	○	○
P.1.2	660			.007	.009	.012	.014	.017	.019	.019	●	○	○
P.1.3	660			.007	.009	.012	.014	.017	.019	.019	●	○	○
P.1.4	590			.007	.009	.012	.014	.017	.019	.019	●	○	○
P.1.5	590			.007	.009	.012	.014	.017	.019	.019	●	○	○
P.2.1	520			.007	.009	.012	.014	.017	.019	.019	●	○	○
P.2.2	520			.007	.009	.012	.014	.017	.019	.019	●	○	○
P.2.3	520			.007	.009	.012	.014	.017	.019	.019	●	○	○
P.2.4	520			.007	.009	.012	.014	.017	.019	.019	●	○	○
P.3.1	460			.006	.007	.009	.012	.012	.014	.014	●	○	○
P.3.2	460			.006	.007	.009	.012	.012	.014	.014	●	○	○
P.3.3	460			.006	.007	.009	.012	.012	.014	.014	●	○	○
P.4.1	390			.006	.007	.009	.012	.012	.014	.014	●	○	○
P.4.2	390			.006	.007	.009	.012	.012	.014	.014	●	○	○
M.1.1		390		.006	.007	.009	.012	.012	.014	.014	●	○	○
M.2.1		390		.006	.007	.009	.012	.012	.014	.014	●	○	○
M.3.1		300		.006	.007	.009	.012	.012	.014	.014	●	○	○
K.1.1			790	.009	.012	.014	.017	.019	.024	.024	○	●	○
K.1.2			590	.009	.012	.014	.017	.019	.024	.024	○	●	○
K.2.1			520	.009	.012	.014	.017	.019	.024	.024	○	●	○
K.2.2			330	.009	.012	.014	.017	.019	.024	.024	○	●	○
K.3.1			390	.009	.012	.014	.017	.019	.024	.024	○	●	○
K.3.2			330	.009	.012	.014	.017	.019	.024	.024	○	●	○
N.1.1	820			.009	.012	.014	.017	.019	.024	.024	●	○	○
N.1.2	820			.009	.012	.014	.017	.019	.024	.024	●	○	○
N.2.1	820			.009	.012	.014	.017	.019	.024	.024	●	○	○
N.2.2	820			.009	.012	.014	.017	.019	.024	.024	●	○	○
N.2.3	660			.009	.012	.014	.017	.019	.024	.024	●	○	○
N.3.1	820			.009	.012	.014	.017	.019	.024	.024	●	○	○
N.3.2	820			.009	.012	.014	.017	.019	.024	.024	●	○	○
N.3.3	820			.009	.012	.014	.017	.019	.024	.024	●	○	○
N.4.1	820			.009	.012	.014	.017	.019	.024	.024	●	○	○
S.1.1													
S.1.2													
S.2.1													
S.2.2													
S.2.3													
S.3.1													
S.3.2													
S.3.3													
H.1.1													
H.1.2													
H.1.3													
H.1.4													
H.2.1													
H.3.1													
O.1.1													
O.1.2													
O.2.1													
O.2.2													
O.3.1													

 The cutting data is significantly dependent on the external conditions, e.g. stability of the tool and workpiece clamping, material and machine type! The stated values are possible cutting data which have to be increased or reduced according to the application conditions! The specified values represent guideline cutting data that can be adjusted by approx. **± 20 %** according to the usage conditions. It is essential to observe the vc values of the type used, the maximum speeds of the system and the reduction of these maximum speeds depending on the type used overhang length. You can find these on pages **24 + 25**.

Maximum Speeds and Scale Accuracy

Maximum speeds for precision adjustment heads and Micro-Boring Heads

System	Boring range	Maximum speed n_{max} in RPM
BlueFlex 2 (62 820 ..., 62 840 ...)	Ø 0.221"-14.370"	20,000
hi.flex (67 800 ...)	Ø 0.221"-14.370"	17,500



2

Maximum speeds for two-edged systems

System	Boring range	Maximum speed n_{max} in RPM
TwinKom (62 881 ...)	Ø 1.181"-1.575"	10,000
	Ø 1.575"-2.008"	8,000
	Ø 2.008"-2.677"	6,500
	Ø 2.677"-3.425"	5,000
	Ø 3.425"-4.567"	4,000
	Ø 4.567"-6.024"	3,000
	Ø 6.024"-8.031"	2,200



 The specified maximum speeds refer to an overhang length of up to 4xD.

For longer overhangs the maximum speeds should be reduced as follows:

$$5xD = 80 \% n_{max}$$

$$6xD = 60 \% n_{max}$$

> 6xD n_{max} identify with caution

Scale accuracy

Large scale with 0.0008" adjustment

How it works:

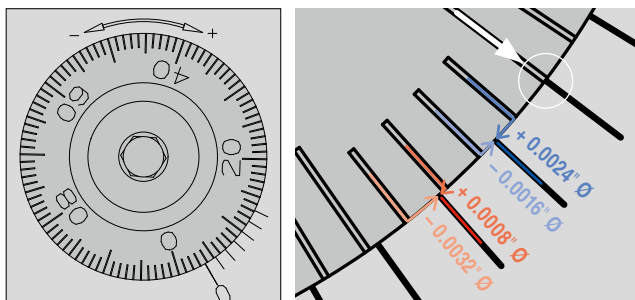

Using the vernier the diameter can be set to 0.0008". The starting point is the point at which the graduation on the vernier and a graduation on the scale ring overlap (white arrow).

If the **first vernier graduation** (blue) is brought to the left of it with the left section of the scale ring to congruence, this corresponds to a diameter change of **- 0.0016"**. If this vernier graduation is brought to congruence with the right section of the scale ring, this corresponds to a diameter change of **+ 0.0024"**.

If the **second vernier graduation** (red) is brought to the left of it with the left section of the scale ring to congruence, this corresponds to a diameter change of **- 0.0032"**. If this vernier graduation is brought to congruence with the right section of the scale ring, this corresponds to a diameter change of **+ 0.0008"**.

Selection of the cutting radius depending on the overhang length

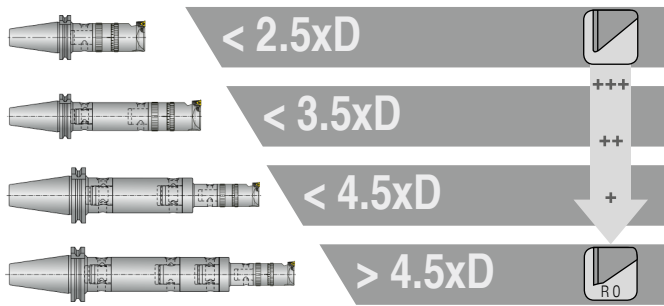

Selection of the cutting edge radius in dependency of the cutting depth a_p

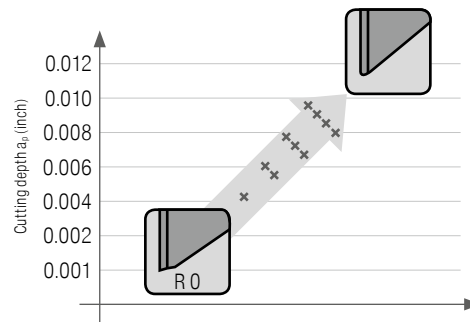

Influence of the cutting forces of the cutting edge radius on internal machining

Resulting force

$$F_{res} = \sqrt{F_a^2 + F_p^2} = \sqrt{F_c^2 + F_f^2 + F_p^2}$$

Tangential cutting force (F_c)

- ▲ pushes the tool down from the vertical central axis
- ▲ is influenced by the cutting depth and the chip thickness
- ▲ reduces the clearance angle

Passive cutting force (F_p)

- ▲ pushes the tool away from the horizontal central axis
- ▲ increases the risk of vibrations and causes dimensional inaccuracies

Feed force (F_f)

- ▲ acts in the machining direction of the tool

Active cutting force (F_a)

- ▲ determined by F_c and F_f

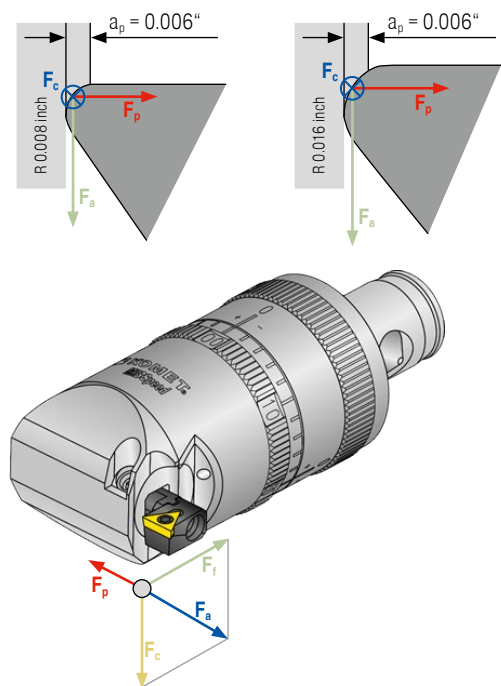

Selection of the rake angle

Recommendations for the use of inserts with ground Chip breakers

	rounded E	Sharp F	chamfered T
0°	P M K N S H	P M K N S H	P M K N S H
≤ 6°	P M K N S H	P M K N S H	P M K N S H
≤ 12°	P M K N S H	P M K N S H	P M K N S H
≤ 20°	P M K N S H	P M K N S H	P M K N S H

Types of wear

Wear on clearance face



Abrasion on the flank: normal wear after a certain period of operation

Cause

- ▲ Cutting speed too high
- ▲ Carbide grade does not have enough wear resistance
- ▲ Feed not adapted to application

Remedy

- ▲ Reduce cutting speed
- ▲ Select a carbide grade with high wear resistance
- ▲ Bring feed into the right relationship with cutting speed and cutting depth

Edge chipping

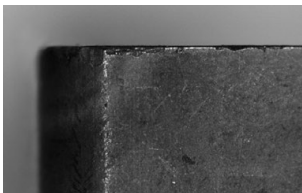

Increased mechanical stress on the cutting edge may result in carbide particles breaking off.

Cause

- ▲ Grade with too high a wear resistance
- ▲ Vibrations on tool or workpiece
- ▲ Feed rate or cutting depth is too high
- ▲ Built-up edge
- ▲ Interrupted cut
- ▲ Chip stroke

Remedy

- ▲ Use tougher grade
- ▲ Improve stability (tool, workpiece)
- ▲ Avoid built-up edges

Cratering



The outgoing hot chip is causing cratering of the cutting insert on the clamping surface.

Cause

- ▲ Cutting speed, feed rate or both are too high
- ▲ Rake angle too small
- ▲ Grade does not have enough wear resistance
- ▲ Incorrectly supplied coolant

Remedy

- ▲ Reduce cutting speed and/or feed rate
- ▲ Choose carbide grades with greater wear-resistance
- ▲ Increase quantity and/or pressure of coolant, check supply
- ▲ Use a more crater-resistant grade

Plastic deformation

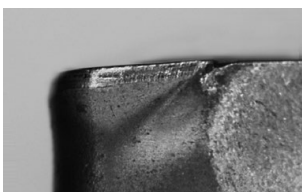

High machining temperature with simultaneous mechanical stress can lead to plastic deformation.

Cause

- ▲ Working temperature too high, softening of the base material
- ▲ Damage to the coating
- ▲ Grade does not have enough wear resistance
- ▲ Incorrectly supplied coolant

Remedy

- ▲ Reduce cutting speed
- ▲ Choose carbide grades with greater wear-resistance and thermal stability
- ▲ Make provisions for cooling

Built-up edge

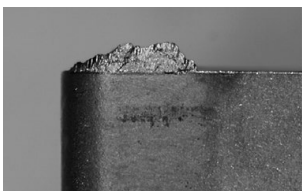

Material builds up on the cutting edge if the chip does not flow correctly due to the cutting temperature being too low.

Cause

- ▲ Cutting speed too low
- ▲ Rake angle too small
- ▲ Incorrect cutting material
- ▲ Missing coolant/lubrication

Remedy

- ▲ Increase cutting speed
- ▲ Increase rake angle
- ▲ Use coating
- ▲ Increase oil content of emulsion

Insert breakage

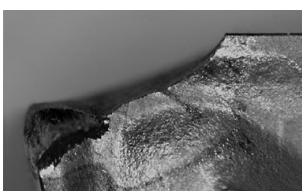

If a cutting insert is overloaded, insert breakage may occur.

Cause

- ▲ Cutting material overloaded (extreme values)
- ▲ Lack of stability
- ▲ Wedge angle too small
- ▲ Interference contours were not taken into account
- ▲ Interrupted cut

Remedy

- ▲ Use a tougher cutting material
- ▲ Use chamfer for edge protection
- ▲ Increase rounding of cutting edge
- ▲ Use more stable geometry
- ▲ Check cutting data
- ▲ Check interference contours

Grade description

BK60

- ▲ Carbide, TiC-TiCN-TiN-coated
- ▲ ISO | P25 | **M10**
- ▲ Multi-layer coating for long service life even in the upper cutting speed range

BK77

- ▲ Carbide, TiN-coated:
- ▲ wear-resistant PVD-coated grade
- ▲ for cutting aluminum alloys and plastics at medium cutting speeds
- ▲ sufficient properties of toughness and a high level of resistance against the formation of build-up on the cutting edges

BK2710

- ▲ Carbide, TiAlN-coated
- ▲ ISO | P10 | M10 | **K10**
- ▲ Extremely wear-resistant carbide grade for machining stainless steels, structural steels and tool steels as well as cast iron materials

BK6110

- ▲ Carbide, TiCN-TiN-Al₂O₃-coated
- ▲ ISO | P10 | **K10**
- ▲ Wear-resistant carbide for machining cast iron and steel materials

BK6115

- ▲ Carbide, TiCN-TiN-Al₂O₃-coated
- ▲ ISO | **P20** | **K20** | H20
- ▲ High-quality, surface-treated coating for machining cast iron materials in normal to stable conditions and at high cutting speeds

BK6440

- ▲ Carbide, CVD-TiCN-Al₂O₃-TiN coated
- ▲ ISO | **M25** | **K35**
- ▲ Extremely tough standard grain grade; good wear resistance in steel and stainless steel materials, even in unfavourable cutting conditions / interrupted cut

BK7615

- ▲ Carbide, TiCN-Al₂O₃-coated
- ▲ ISO | **K15**
- ▲ Highly productive grade with extreme edge stability for wet and dry machining of all cast iron materials

BK7935

- ▲ PVD-AlTiN:
- ▲ coating with high aluminum content on tough substrate for continuous drilling of rust- and acid-resistant steels, and special alloys
- ▲ Use as continuous drilling inner indexable insert and for difficult conditions recommended

BK7710

- ▲ Carbide, TiB₂-coated
- ▲ ISO | **N10** | S10 | O10
- ▲ The wear-resistant grade with optimum cutting characteristics to prevent built-up edge formation for machining aluminium and titanium alloys.

BK8425

- ▲ Carbide, TiAlN/TiN-coated
- ▲ ISO | **P25** | **M25** | **K25**
- ▲ Universal grade with greater wear resistance thanks to innovative PVD multi-layer coating

BK8430

- ▲ Carbide, TiAlN/TiN-coated
- ▲ ISO | **P25** | **M25**
- ▲ Fine-grain grade with high wear resistance
- ▲ Extreme edge stability and maximum wear resistance in the middle and top speed range

BK8440

- ▲ Carbide, TiCN-TiN-coated
- ▲ ISO | **P35** | M10
- ▲ Very tough carbide grade for medium cutting speeds and interrupted cut

CBN40

- ▲ Cubic boron nitride, uncoated
- ▲ ISO | **H05**
- ▲ Uncoated cutting material made of cubic boron nitride for machining hardened steels over 45 HRC, heat-resistant nickel-based or cobalt-based alloys

CK32

- ▲ Cermet, uncoated
- ▲ ISO | **P10** | **M15** | K05 | N15
- ▲ For fine and finish turning
- ▲ Less wear and greater cutting speed result in longer tool life and high surface quality
- ▲ Cutting material for high productivity in the top cutting speed range

CK3230

- ▲ Cermet, uncoated
- ▲ ISO | **P20** | **M20** | K10 | N20
- ▲ Extremely tough behaviour with good wear resistance suitable for use also in interrupted cut

K10

- ▲ Carbide, uncoated
- ▲ ISO | **K10**
- ▲ Uncoated carbide grade for machining grey cast iron or non-ferrous metals, depending on the cutting edge geometry

PKD5510
CTDPU20

- ▲ Polycrystalline diamond cutting material with mixed grain, uncoated
- ▲ ISO | **N15**
- ▲ Outstanding wear resistance, even where Si content > 12% and high proportion of abrasive reinforcements
- ▲ Used in plastics and fibre composites (GFK, CFK)

Chip breakers

-01

- ▲ Rake angle 12°
- ▲ All-round topography chamfered, rounded
- ▲ Very smooth-cutting thanks to positive cutting edge geometry
- ▲ Also suitable for less-powerful machines and unstable workpieces
- ▲ Easily controllable chip formation also in less solid materials

-02

- ▲ Rake angle 0°
- ▲ Roughing topography, extremely stable (significant wedge angle)
- ▲ Excellent chip formation for chips that are difficult to control
- ▲ For small cutting depths < 1.5 mm only suitable under certain circumstances

-11

- ▲ Highly positive, minimally rounded chip breaker
- ▲ For soft cutting use
- ▲ Main application in aluminum

-12

- ▲ Rake angle 30°
- ▲ Peripheral ground indexable insert with pressed chip breaker
- ▲ Highly positive, sharp and all-round cutting edge, therefore extremely smooth-cutting
- ▲ Peripheral ground flanks guarantee controlled chip formation and best surface quality at low cutting forces

-14

- ▲ Rake angle 14°
- ▲ Peripheral ground, sintered topography
- ▲ Controlled chip formation in fine and extremely fine machining

-15

- ▲ Rake angle 15°
- ▲ Semi-finishing chip breaker; peripheral ground, sintered
- ▲ Controlled chip formation in fine and extremely fine machining

-18

- ▲ Rake angle 14°
- ▲ Peripheral ground and sintered topography
- ▲ Controlled chip formation in fine and extremely fine machining
- ▲ Positive wiper geometry for maximum demands on surface quality

-G06

- ▲ Rake angle 6°
- ▲ For P / M / K materials
- ▲ High stability due to significant wedge angle

-G12

- ▲ Rake angle 12°
- ▲ For P / N / S materials
- ▲ Extremely smooth-cutting thanks to positive cutting edge geometry
- ▲ Extremely suitable for less-powerful machines and unstable workpieces
- ▲ Easily controllable chip formation also in less solid materials





Holemaking

1 Indexable Drilling

2 Indexable Boring

3 Reaming

3

4 Indexable Turning

Turning

5 Parting and Grooving

6 Multifunction

Milling

7 Indexable Milling

8 Solid Milling

9 Material examples and
article no. index

Table of contents

Symbol explanation	2
Reamers overview	3
Reamers Toolfinder	4+5
Product range – Reamers	
Reamax TS	6–13
Rapid Set Head	14–19
Cutting Ring	20–26
Monomax	27–36
PCD Reamer	37–39
Technical Information	
Cutting Data	40–62
Assembly Instructions	63–67
Problems / possible causes / solutions	68
Types of wear	69
Cutting edge geometries and surface quality	70
Tolerance class	71
Coatings and Grades	72

KOMET \ Performance

Premium quality tools for high performance.

The premium quality tools from the **KOMET Performance** product line have been designed for specific applications and are distinguished by their outstanding performance. If you make high demands on the performance of your production and want to achieve the very best results, we recommend the Premium tools in this product line.

Symbol explanation

Shank

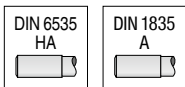

Coolant supply version



central internal coolant



lateral internal coolant

ZEFP = Number of flutes

- = Main Application
- = Extended application



metric



Additional metric items are available in our Online-Shop at cuttingtools.ceratizit.com and in the metric main catalog.

Toolfinder – Reamers





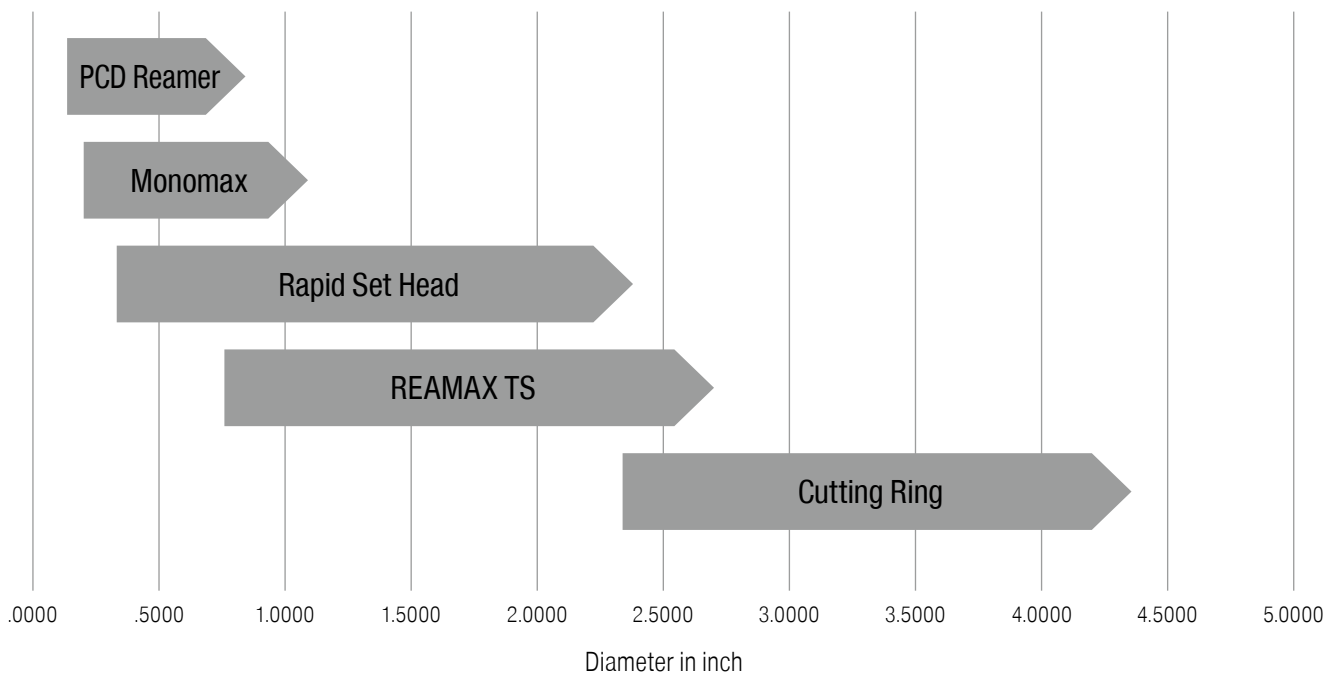

3

Overview of high-speed reamers

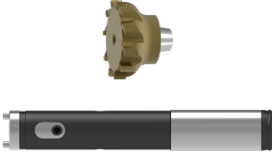
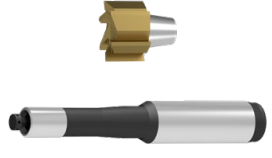
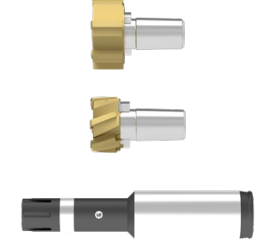
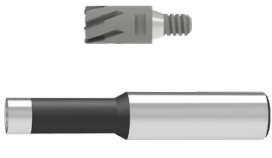
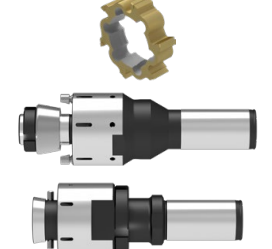
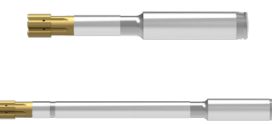

Toolfinder – Reamers

Solid carbide – high speed reamers	REMAXTS		<ul style="list-style-type: none"> ▲ highly flexible and economical replaceable head system ▲ all common materials ▲ can be adjusted in μm range
	REMAX		<ul style="list-style-type: none"> ▲ Exchangeable head system, optimized for use with air mist coolant (MMS) ▲ Face and taper contact giving run out accuracy $\leq 2 \mu\text{m}$
	Rapid Set Head		<ul style="list-style-type: none"> ▲ Exchangeable head system ▲ Left hand spiral fluted cutting blades. available for highest productivity ▲ Re-tipping and regrinding available
	MultiChange		<ul style="list-style-type: none"> ▲ flexible quick change system for reaming, countersinking and chamfering ▲ face and taper contact giving run out accuracy $\leq 5 \mu\text{m}$
	Cutting Ring		<ul style="list-style-type: none"> ▲ For large diameter holes. ▲ Compensation for wear through simple readjustment. ▲ Re-tipping and regrinding available
	Monomax		<ul style="list-style-type: none"> ▲ Expandable monoblock reamer in 3xD and 5xD ▲ Re-tipping and regrinding available ▲ All common materials
	Fullmax		<ul style="list-style-type: none"> ▲ High-speed reamer in shorter and longer version ▲ Reamers for machining steel, stainless and acid-resistant steels, cast materials, aluminium and hardened materials up to 63 HRC ▲ Extremely irregular pitch ▲ Standard shank ~ DIN 6535 HA
	PCD Reamer		<ul style="list-style-type: none"> ▲ 2 and 4 blade versions available ▲ High stability from the carbide body ▲ Optimized for finishing pre-cast bores ▲ Re-tipping and regrinding available

 Solid Carbide Reamers and HSS Reamers can be found in the metric catalog.

Hole diameter in inch Ø DC		Through hole	Blind hole	Int. coolant supply	Steel P Stainless steel M Cast Iron K Non-ferrous metals N Heat-resistant S Tempered steel H Non-metal materials O	KOMET \ Performance
.7086 - 2.5590 (18.00 - 65.00 mm)		✓	✓	✓	● ● ● ● ● ○	6-11
				✓		12+13
.4920 - 1.5748 (12.50 - 40.00 mm)		✓	✓	✓	● ● ● ● ● ○	metric
				✓		
.3779 - 2.3622 (9.60 - 60.00 mm)		✓	✓	✓	● ● ● ● ●	14-17
.3779 - 2.3622 (9.60 - 60.00 mm)		✓			●	15+18
				✓		19
.3150 - 1.2677 (8.00-30.20 mm)		✓	✓	✓	● ● ● ●	metric
				✓		
2.3858 - 4.3543 (60.60 - 110.60 mm)		✓	✓		● ● ● ● ●	20-23
		✓		✓		24
			✓	✓		25+26
short	.2205 - 1.0196 (5.60 - 25.90 mm)	✓	✓	✓	● ● ● ● ● ○	29-32
long	.2205 - 1.0196 (5.60 - 25.90 mm)	✓	✓	✓	● ● ● ● ● ○	33-36
short	.1575 - .6300 (4.00 - 16.00 mm)	✓	✓	✓	● ● ● ○ ○ ○	metric
	.1165 - .7894 (2.96 - 20.05 mm)					
long	.1575 - .6300 (4.00 - 16.00 mm)	✓	✓	✓	● ● ● ● ○ ● ○	
	.1165 - .7894 (2.96 - 20.05 mm)					
.1575 - .7913 (4.00 - 20.10 mm)		✓	✓		●	37-39

REAMAX TS – Selection guide – Through hole

Ø		.7086 – 2.5590 inch								
KOMET no.	75J.65	75J.65	75J.17	75J.71	75J.71	75J.71	75J.93	75J.93	75J.21	
Grind geometry	ASG3000	ASG0106	ASG0706	ASG3000	ASG4000	ASG0106	ASG4000	ASG3000	ASG03	
Lead angle	45°	45°	45°/8°	45°	25°	45°	25°	45°	30°/2°	
Grade / coating	DBG-P	DBG-P	DBC	TiN	TiN	TiN	DST	DST	K10	
Article no.	49 586	49 521	49 526	49 534	49 596	49 520	49 597	49 544	49 531	
Application		Through hole								
Material sub-group	Index									
P	Non alloyed steel	P.1.1								
		P.1.2								
		P.1.3	●			○	●		●	●
		P.1.4								
		P.1.5								
	Low alloyed steel	P.2.1								
		P.2.2	●			○			●	●
		P.2.3								
		P.2.4								
	High-alloy steel and high-alloy tool steel	P.3.1								
		P.3.2								
		P.3.3		●				○		
Stainless steel	P.4.1									
	P.4.2									
M	Stainless steel	M.1.1								
		M.2.1		●						
		M.3.1						○		
K	Grey cast iron	K.1.1	●			○				
		K.1.2								
	Spherulitic graphite cast iron	K.2.1	●					●	●	
		K.2.2								
	Malleable iron	K.3.1	●						●	
		K.3.2						●	●	
N	Aluminum alloys,	N.1.1								
		N.1.2								
	Cast Aluminium Alloys	N.2.1			●					
		N.2.2								
		N.2.3								
	Copper and copper alloys (Bronze, Brass)	N.3.1							○	
		N.3.2				●				
		N.3.3								
Magnesium alloys	N.4.1			●						
S	Heat resistant alloys	S.1.1								
		S.1.2								
		S.2.1								
		S.2.2								
		S.2.3								
	Titanium alloys	S.3.1								
		S.3.2								●
		S.3.3								
O	Non-metal materials	O.1.1								
		O.1.2								
		O.2.1								
		O.2.2								
		O.3.1			○					

Applications: Main application ●
Additional range of application ○

REAMAX TS – Selection guide – Blind hole

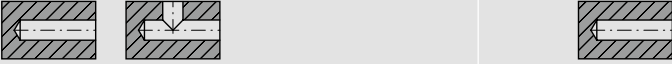
Ø		.7086 – 2.5590 inch						
KOMET no.		75H.65	75H.65	75H.71	75H.71	75H.17	75H.93	75H.21
Grind geometry		ASG3000	ASG0106	ASG0106	ASG3000	ASG0706	ASG3000	ASG03
Lead angle		45°	45°	45°	45°	45°/8°	45°	30°/2°
Grade / coating		DBG-P	DBG-P	TiN	TiN	DBC	DST	K10
Article no.		49 585	49 571	49 527	49 535	49 580	49 539	49 530
Application		Blind hole 						
Material sub-group		Index						
P	Non alloyed steel	P.1.1						
		P.1.2						
		P.1.3	●			○		●
		P.1.4						
		P.1.5						
	Low alloyed steel	P.2.1						
		P.2.2	●			○		●
		P.2.3						
		P.2.4						
	High-alloy steel and high-alloy tool steel	P.3.1						
		P.3.2						
		P.3.3		●	○			
Stainless steel	P.4.1							
	P.4.2							
M	Stainless steel	M.1.1						
		M.2.1		●	○			
		M.3.1						
K	Grey cast iron	K.1.1	●			●		
		K.1.2						
	Spherulitic graphite cast iron	K.2.1	●				●	
		K.2.2						
	Malleable iron	K.3.1	●				●	
		K.3.2						
N	Aluminum alloys,	N.1.1						
		N.1.2						
	Cast Aluminium Alloys	N.2.1					●	
		N.2.2						
		N.2.3						
	Copper and copper alloys (Bronze, Brass)	N.3.1						
		N.3.2			●		○	
		N.3.3						
Magnesium alloys	N.4.1					●		
S	Heat resistant alloys	S.1.1						
		S.1.2						
		S.2.1						
		S.2.2						
		S.2.3						
	Titanium alloys	S.3.1						
		S.3.2						
		S.3.3					●	
O	Non-metal materials	O.1.1						
		O.1.2						
		O.2.1						
		O.2.2						
		O.3.1					○	

3

Applications: Main application ●
Additional range of application ○

REAMAX TS – Replaceable reaming heads

- ▲ up to tolerance class IT 6
- ▲ precise repeatability < .0001"
- ▲ high precision grind for maximum quality
- ▲ can be adjusted for the smallest hole tolerances

- ▲ interface enables head change in the machine
- ▲ retraction from the hole at 3–4 times the cutting feed rate
- ▲ KLG = coupling size
- ▲ ZEFP = number of cutting edges

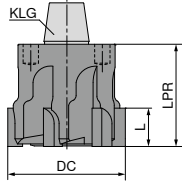

75J.93
∠ 25°
ASG4000
CERMET
Through hole

75J.65
∠ 45°
ASG0106
HM
Through hole

75J.17
∠ 45/8°
ASG0706
HM
Through hole

75J.93
∠ 45°
ASG3000
CERMET
Through hole

DC inch	L inch	LPR inch	ZEFP	KLG	49 597 ...	49 521 ...	49 526 ...	49 544 ...
0.7087 - 0.7874	0.236	0.787	6	1	xxxx ¹⁾	xxxx ¹⁾	xxxx ¹⁾	xxxx ¹⁾
0.7874 - 0.8661	0.236	0.787	6	2	xxxx ¹⁾	xxxx ¹⁾	xxxx ¹⁾	xxxx ¹⁾
0.8661 - 1.0630	0.236	0.787	6	3	xxxx ¹⁾	xxxx ¹⁾	xxxx ¹⁾	xxxx ¹⁾
1.0630 - 1.2519	0.236	0.984	6	4	xxxx ¹⁾	xxxx ¹⁾	xxxx ¹⁾	xxxx ¹⁾
1.2520 - 1.3779	0.236	0.984	8	4	xxxx ¹⁾	xxxx ¹⁾	xxxx ¹⁾	xxxx ¹⁾
1.3780 - 1.6535	0.236	0.984	8	5	xxxx ¹⁾	xxxx ¹⁾	xxxx ¹⁾	xxxx ¹⁾
1.6535 - 2.0472	0.236	1.181	8	6	xxxx ¹⁾	xxxx ¹⁾	xxxx ¹⁾	xxxx ¹⁾
2.0472 - 2.5590	0.314	1.377	10	7	xxxx ¹⁾	xxxx ¹⁾	xxxx ¹⁾	xxxx ¹⁾
P					●	●		●
M						●		
K					●			●
N							●	○
S								
H								
O							○	

1) Not available from stock, articles are non-returnable and cannot be exchanged / Minimum order 2 pieces

→ v_c Page 41-44

For xxxx please indicate piece part bore diameter and tolerance. (e.g. Ø 1.5000" ±.0005")

Assembly instructions can be found on → Page 63+64

REAMAX TS – Replaceable reaming heads

- ▲ up to tolerance class IT 6
- ▲ precise repeatability < .0001"
- ▲ high precision grind for maximum quality
- ▲ can be adjusted for the smallest hole tolerances

- ▲ interface enables head change in the machine
- ▲ retraction from the hole at 3–4 times the cutting feed rate
- ▲ KLG = coupling size
- ▲ ZEFP = number of cutting edges

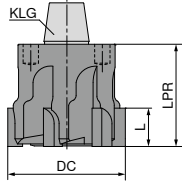

75J.71
∠ 25°
ASG4000
HM
Through hole

75J.65
∠ 45°
ASG3000
HM
Through hole

75J.21
∠ 30/2°
ASG03
HM
Through hole

75J.71
∠ 45°
ASG0106
HM
Through hole

75J.71
∠ 45°
ASG3000
HM
Through hole

DC inch	L inch	LPR inch	ZEFP	KLG	49 596 ...	49 586 ...	49 531 ...	49 520 ...	49 534 ...
0.7087 - 0.7874	0.236	0.787	6	1	xxxx ¹⁾	xxxx ¹⁾	xxxx ¹⁾	xxxx ¹⁾	xxxx ¹⁾
0.7874 - 0.8661	0.236	0.787	6	2	xxxx ¹⁾	xxxx ¹⁾	xxxx ¹⁾	xxxx ¹⁾	xxxx ¹⁾
0.8661 - 1.0630	0.236	0.787	6	3	xxxx ¹⁾	xxxx ¹⁾	xxxx ¹⁾	xxxx ¹⁾	xxxx ¹⁾
1.0630 - 1.2519	0.236	0.984	6	4	xxxx ¹⁾	xxxx ¹⁾	xxxx ¹⁾	xxxx ¹⁾	xxxx ¹⁾
1.2520 - 1.3779	0.236	0.984	8	4	xxxx ¹⁾	xxxx ¹⁾	xxxx ¹⁾	xxxx ¹⁾	xxxx ¹⁾
1.3780 - 1.6535	0.236	0.984	8	5	xxxx ¹⁾	xxxx ¹⁾	xxxx ¹⁾	xxxx ¹⁾	xxxx ¹⁾
1.6535 - 2.0472	0.236	1.181	8	6	xxxx ¹⁾	xxxx ¹⁾	xxxx ¹⁾	xxxx ¹⁾	xxxx ¹⁾
2.0472 - 2.5590	0.314	1.377	10	7	xxxx ¹⁾	xxxx ¹⁾	xxxx ¹⁾	xxxx ¹⁾	xxxx ¹⁾
P					●	●		○	○
M								○	
K						●			○
N									●
S							●		
H									
O									

1) Not available from stock, articles are non-returnable and cannot be exchanged / Minimum order 2 pieces

→ v_c Page 41-44

For xxxx please indicate piece part bore diameter and tolerance. (e.g. Ø 1.5000" ±.0005")

Assembly instructions can be found on → Page 63+64

REAMAX TS – Replaceable reaming heads

- ▲ up to tolerance class IT 6
- ▲ precise repeatability < .0001"
- ▲ high precision grind for maximum quality
- ▲ can be adjusted for the smallest hole tolerances

- ▲ interface enables head change in the machine
- ▲ retraction from the hole at 3–4 times the cutting feed rate
- ▲ KLG = coupling size
- ▲ ZEFP = number of cutting edges

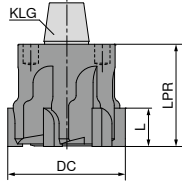

75H.93
∠ 45°
ASG3000
CERMET
Blind hole

75H.65
∠ 45°
ASG0106
HM
Blind hole

75H.17
∠ 45/8°
ASG0706
HM
Blind hole

75H.65
∠ 45°
ASG3000
HM
Blind hole

75H.71
∠ 45°
ASG3000
HM
Blind hole

49 539 ...

49 571 ...

49 580 ...

49 585 ...

49 535 ...

DC inch	L inch	LPR inch	ZEFP	KLG	49 539 ...	49 571 ...	49 580 ...	49 585 ...	49 535 ...
0.7087 - 0.7874	0.236	0.787	6	1	xxxx ¹⁾	xxxx ¹⁾	xxxx ¹⁾	xxxx ¹⁾	xxxx ¹⁾
0.7874 - 0.8661	0.236	0.787	6	2	xxxx ¹⁾	xxxx ¹⁾	xxxx ¹⁾	xxxx ¹⁾	xxxx ¹⁾
0.8661 - 1.0630	0.236	0.787	6	3	xxxx ¹⁾	xxxx ¹⁾	xxxx ¹⁾	xxxx ¹⁾	xxxx ¹⁾
1.0630 - 1.2519	0.236	0.984	6	4	xxxx ¹⁾	xxxx ¹⁾	xxxx ¹⁾	xxxx ¹⁾	xxxx ¹⁾
1.2520 - 1.3779	0.236	0.984	8	4	xxxx ¹⁾	xxxx ¹⁾	xxxx ¹⁾	xxxx ¹⁾	xxxx ¹⁾
1.3780 - 1.6535	0.236	0.984	8	5	xxxx ¹⁾	xxxx ¹⁾	xxxx ¹⁾	xxxx ¹⁾	xxxx ¹⁾
1.6535 - 2.0472	0.236	1.181	8	6	xxxx ¹⁾	xxxx ¹⁾	xxxx ¹⁾	xxxx ¹⁾	xxxx ¹⁾
2.0472 - 2.5590	0.314	1.377	10	7	xxxx ¹⁾	xxxx ¹⁾	xxxx ¹⁾	xxxx ¹⁾	xxxx ¹⁾
P					●	●		●	○
M						●			
K					●			●	○
N					○		●		●
S									
H									
O							○		

1) Not available from stock, articles are non-returnable and cannot be exchanged / Minimum order 2 pieces

→ v_c Page 41-44

For xxxx please indicate piece part bore diameter and tolerance. (e.g. Ø 1.5000" ±.0005")

Assembly instructions can be found on → Page 63+64

REAMAX TS – Replaceable reaming heads

- ▲ up to tolerance class IT 6
- ▲ precise repeatability < .0001"
- ▲ high precision grind for maximum quality
- ▲ can be adjusted for the smallest hole tolerances

- ▲ interface enables head change in the machine
- ▲ retraction from the hole at 3–4 times the cutting feed rate
- ▲ KLG = coupling size
- ▲ ZEFP = number of cutting edges

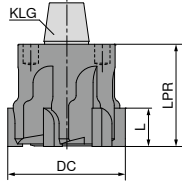

75H.21
∠ 30/2°
ASG03
HM
Blind hole

75H.71
∠ 45°
ASG0106
HM
Blind hole

49 530 ...	49 527 ...
xxxx ¹⁾	xxxx ¹⁾
xxxx ¹⁾	xxxx ¹⁾
xxxx ¹⁾	xxxx ¹⁾
xxxx ¹⁾	xxxx ¹⁾
xxxx ¹⁾	xxxx ¹⁾
xxxx ¹⁾	xxxx ¹⁾
xxxx ¹⁾	xxxx ¹⁾
xxxx ¹⁾	xxxx ¹⁾

DC inch	L inch	LPR inch	ZEFP	KLG
0.7087 - 0.7874	0.236	0.787	6	1
0.7874 - 0.8661	0.236	0.787	6	2
0.8661 - 1.0630	0.236	0.787	6	3
1.0630 - 1.2519	0.236	0.984	6	4
1.2520 - 1.3779	0.236	0.984	8	4
1.3780 - 1.6535	0.236	0.984	8	5
1.6535 - 2.0472	0.236	1.181	8	6
2.0472 - 2.5590	0.314	1.377	10	7

P	○
M	○
K	
N	
S	●
H	
O	

1) Not available from stock, articles are non-returnable and cannot be exchanged / Minimum order 2 pieces

→ v_c Page 41-44

For xxxx please indicate piece part bore diameter and tolerance. (e.g. Ø 1.5000" ±.0005")

Assembly instructions can be found on → Page 63+64

REAMAX TS – Holder

▲ KLG = Coupling Size

Supply details:

Complete holder with pull stud. Reamer head not included

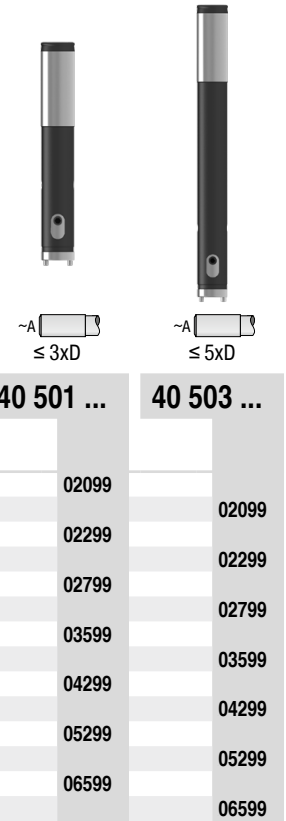
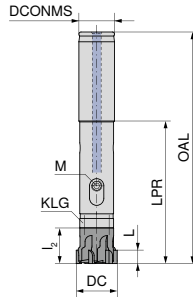

DC inch	KOMET no.	OAL inch	l ₂ inch	LPR inch	L inch	DCONMS inch	DCONMS mm	M Nm	KLG	40 501 ...	40 503 ...
0.7087 - 0.7870	75A.40.13010	5.118	0.787	3.149	0.236	0.787	20	1,5	1	02099	
0.7087 - 0.7870	75A.40.15010	7.480	0.787	5.511	0.236	0.787	20	1,5	1		02099
0.7874 - 0.8657	75A.40.13020	5.118	0.787	3.149	0.236	0.787	20	2,5	2	02299	
0.7874 - 0.8657	75A.40.15020	7.480	0.787	5.511	0.236	0.787	20	2,5	2		02299
0.8661 - 1.0626	75A.40.13030	5.118	0.787	3.149	0.236	0.787	20	4	3	02799	
0.8661 - 1.0626	75A.40.15030	8.267	0.787	6.299	0.236	0.787	20	4	3		02799
1.0630 - 1.3776	75A.40.13040	6.929	0.984	4.724	0.236	0.984	25	5	4	03599	
1.0630 - 1.3776	75A.40.15040	9.291	0.984	7.086	0.236	0.984	25	5	4		03599
1.3780 - 1.6535	75A.40.13050	6.929	0.984	4.724	0.236	0.984	25	6	5	04299	
1.3780 - 1.6535	75A.40.15050	10.078	0.984	7.874	0.236	0.984	25	6	5		04299
1.6535 - 2.0472	75A.40.13060	7.086	1.181	4.724	0.236	1.259	32	10	6	05299	
1.6535 - 2.0472	75A.40.15060	11.023	1.181	8.661	0.236	1.259	32	10	6		05299
2.0472 - 2.5590	75A.40.13070	7.086	1.181	4.724	0.314	1.259	32	13	7	06599	
2.0472 - 2.5590	75A.40.15070	11.023	1.181	8.661	0.314	1.259	32	13	7		06599

Do not heat shrink tools!

Spare parts DC	80 397 ...	80 950 ...	40 900 ...
0.7087 - 0.7870			00100
0.7874 - 0.8657	SW2,5	T08 - IP	00200
0.8661 - 1.0626	SW3	039	00300
1.0630 - 1.3776	SW3		00400
1.3780 - 1.6535	SW3		00500
1.6535 - 2.0472	SW4		00500
2.0472 - 2.5590	SW5		00700

Assembly instructions can be found on → **Page 63+64**

REAMAX TS – Holder

- ▲ KLG = Coupling size
- ▲ Adjustment inside the machine
- ▲ Alignable DAH Zero holder for correction of concentricity error
- ▲ DAH Zero holder is pre-loaded and set to a runout of < 0.0002"

Supply details:

Complete holder with pull stud. Reamer head not included

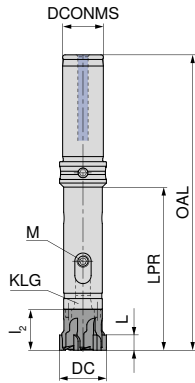

DC inch	KOMET no.	OAL inch	l ₂ inch	LPR inch	L inch	DCONMS inch	DCONMS mm	M Nm	KLG	40 504 ...	40 506 ...
0.7087 - 0.7870	75A.41.13010	5.708	0.787	3.149	0.236	0.787	20	1,5	1	02099	
0.7087 - 0.7870	75A.41.15010	8.070	0.787	5.511	0.236	0.787	20	1,5	1		02099
0.7874 - 0.8657	75A.41.13020	5.708	0.787	3.149	0.236	0.787	20	2,5	2	02299	
0.7874 - 0.8657	75A.41.15020	8.070	0.787	5.511	0.236	0.787	20	2,5	2		02299
0.8661 - 1.0626	75A.41.13030	5.708	0.787	3.149	0.236	0.787	20	4	3	02799	
0.8661 - 1.0626	75A.41.15030	8.858	0.787	6.299	0.236	0.787	20	4	3		02799
1.0630 - 1.3776	75A.41.13040	5.708	0.984	4.724	0.236	0.984	25	5	4	03599	
1.0630 - 1.3776	75A.41.15040	9.291	0.984	7.086	0.236	0.984	25	5	4		03599
1.3780 - 1.6535	75A.41.13050	6.929	0.984	4.724	0.236	0.984	25	6	5	04299	
1.3780 - 1.6535	75A.41.15050	9.291	0.984	7.874	0.236	0.984	25	6	5		04299

Do not heat shrink tools !

Spare parts	Clamping key - T	Screwdriver	Reamax TS pull stud
DC	80 397 ...	80 950 ...	40 900 ...
0.7087 - 0.7870		T08 - IP	00100
0.7874 - 0.8657	SW2,5	039	00200
0.8661 - 1.0626	SW3		00300
1.0630 - 1.3776	SW3		00400
1.3780 - 1.6535	SW3		00500



Assembly instructions can be found on → Page 63+64

Rapid Set Head – Selection guide

Ø		.3779 – 2.3622 inch							
KOMET no.	340.65	340.65	340.21	340.71	340.71	340.93	340.21	340.21	
Grind geometry	ASG3000	ASG0106	ASG03	ASG3000	ASG0106	ASG3000	ASG02	ASG3000	
Lead angle	45°	45°	30°/2°	45°	45°	45°	45°/8°	45°	
Grade / coating	DBG-P	DBG-P	K10	TiN	TiN	DST	K10	K10	
Article no.	49 817	49 816	49 800	49 808	49 809	49 813	49 804	49 801	
Application		Through hole + blind hole							
Material sub-group	Index								
P	Non alloyed steel	P.1.1							
		P.1.2							
		P.1.3	●			○		●	○
		P.1.4							
		P.1.5							
	Low alloyed steel	P.2.1							
		P.2.2	●			○		●	○
		P.2.3							
		P.2.4	●			●			
	High-alloy steel and high-alloy tool steel	P.3.1							
P.3.2			●			●			
P.3.3									
Stainless steel	P.4.1								
	P.4.2		●			●			
M	Stainless steel	M.1.1							
		M.2.1		●			●		
		M.3.1							
K	Grey cast iron	K.1.1	●			●		○	
		K.1.2							
	Spherulitic graphite cast iron	K.2.1	●				●	○	
		K.2.2							
	Malleable iron	K.3.1	●				●	○	
		K.3.2							
N	Aluminum alloys,	N.1.1							
		N.1.2							
	Cast Aluminium Alloys	N.2.1						●	○
		N.2.2							
		N.2.3							
	Copper and copper alloys (Bronze, Brass)	N.3.1				○		●	○
		N.3.2				○		●	○
		N.3.3				○		●	○
Magnesium alloys	N.4.1						●	○	
S	Heat resistant alloys	S.1.1							
		S.1.2							
		S.2.1							
		S.2.2							
	Titanium alloys	S.2.3							
		S.3.1							
S.3.2				●					
S.3.3									
O	Non-metal materials	O.1.1							
		O.1.2							
		O.2.1							
		O.2.2							
		O.3.1							

Applications: Main application ● Additional range of application ○

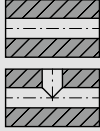
Rapid Set Head – Selection guide

Ø		.3779 – 2.3622 inch	
KOMET no.		340.70	340.92
Grind geometry		ASG05	ASG05
Lead angle		25°	25°
Grade / coating		TiN	DST
Article no.		49 805	49 812
Application		Through hole	
			
Material sub-group		Index	
P	Non alloyed steel	P.1.1	
		P.1.2	
		P.1.3	○
		P.1.4	
		P.1.5	
	Low alloyed steel	P.2.1	
		P.2.2	○
		P.2.3	
		P.2.4	●
	High-alloy steel and high-alloy tool steel	P.3.1	
		P.3.2	
		P.3.3	
	Stainless steel	P.4.1	
		P.4.2	
M	Stainless steel	M.1.1	
		M.2.1	
		M.3.1	
K	Grey cast iron	K.1.1	
		K.1.2	
	Spherulitic graphite cast iron	K.2.1	
		K.2.2	
	Malleable iron	K.3.1	
		K.3.2	
N	Aluminum alloys,	N.1.1	
		N.1.2	
	Cast Aluminium Alloys	N.2.1	
		N.2.2	
		N.2.3	
	Copper and copper alloys (Bronze, Brass)	N.3.1	
		N.3.2	
		N.3.3	
N.4.1			
S	Heat resistant alloys	S.1.1	
		S.1.2	
		S.2.1	
		S.2.2	
		S.2.3	
	Titanium alloys	S.3.1	
		S.3.2	
S.3.3			
O	Non-metal materials	O.1.1	
		O.1.2	
		O.2.1	
		O.2.2	
		O.3.1	

3

Applications: Main application ●
Additional range of application ○

Rapid Set Head

- ▲ PHD = Approximate diameter for face machining geometries (ASG)
- ▲ KLG = Coupling Size
- ▲ ZEFP = Number of cutting edges

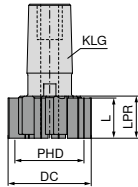

340.71 ∠ 45° ASG3000 HM Through hole + blind hole	340.71 ∠ 45° ASG0106 HM Through hole + blind hole	340.21 ∠ 45° ASG3000 HM Through hole + blind hole	340.21 ∠ 30/2° ASG03 HM Through hole + blind hole	340.21 ∠ 45/8° ASG02 HM Through hole + blind hole
---	---	---	---	---

49 808 ...	49 809 ...	49 801 ...	49 800 ...	49 804 ...
------------	------------	------------	------------	------------

DC inch	L inch	LPR inch	ZEFP	PHD inch	KLG	49 808 ...	49 809 ...	49 801 ...	49 800 ...	49 804 ...
0.378 - 0.4957	0.374	0.433	4	DC-0.1220	1	xxxx ¹⁾	xxxx ¹⁾	xxxx ¹⁾	xxxx ¹⁾	xxxx ¹⁾
0.4961 - 0.6138	0.413	0.433	4	DC-0.1417	2	xxxx ¹⁾	xxxx ¹⁾	xxxx ¹⁾	xxxx ¹⁾	xxxx ¹⁾
0.6142 - 0.7319	0.413	0.433	6	DC-0.1417	3	xxxx ¹⁾	xxxx ¹⁾	xxxx ¹⁾	xxxx ¹⁾	xxxx ¹⁾
0.7323 - 0.9449	0.413	0.433	6	DC-0.2008	4	xxxx ¹⁾	xxxx ¹⁾	xxxx ¹⁾	xxxx ¹⁾	xxxx ¹⁾
0.9453 - 1.185	0.413	0.433	6	DC-0.2362	5	xxxx ¹⁾	xxxx ¹⁾	xxxx ¹⁾	xxxx ¹⁾	xxxx ¹⁾
1.1854 - 1.2165	0.629	0.669	6	DC-0.2953	6	xxxx ¹⁾	xxxx ¹⁾	xxxx ¹⁾	xxxx ¹⁾	xxxx ¹⁾
1.2169 - 1.5748	0.629	0.669	6	DC-0.2953	6	xxxx ¹⁾	xxxx ¹⁾	xxxx ¹⁾	xxxx ¹⁾	xxxx ¹⁾
1.5752 - 1.9957	0.629	0.669	6	DC-0.3150	7	xxxx ¹⁾	xxxx ¹⁾	xxxx ¹⁾	xxxx ¹⁾	xxxx ¹⁾
1.9961 - 2.3622	0.629	0.669	6	DC-0.3150	8	xxxx ¹⁾	xxxx ¹⁾	xxxx ¹⁾	xxxx ¹⁾	xxxx ¹⁾
P						○	○	○		
M							○			
K						○		○		
N						○		○		●
S									●	
H										
O										

1) Not available from stock, articles are non-returnable and cannot be exchanged / Minimum order 2 pieces

For xxxx please indicate piece part bore diameter and tolerance. (e.g. Ø 1.5000" ±.0005")

Assembly instructions can be found on → Page 65

Rapid Set Head

- ▲ PHD = Approximate diameter for face machining geometries (ASG)
- ▲ KLG = Coupling Size
- ▲ ZEFP = Number of cutting edges

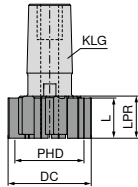

340.93 ∠45° ASG3000 CERMET Through hole + blind hole	340.65 ∠45° ASG3000 HM Through hole + blind hole	340.65 ∠45° ASG0106 HM Through hole + blind hole
---	---	---

49 813 ...	49 817 ...	49 816 ...
xxxx ¹⁾	xxxx ¹⁾	xxxx ¹⁾
xxxx ¹⁾	xxxx ¹⁾	xxxx ¹⁾
	xxxx ¹⁾	xxxx ¹⁾
xxxx ¹⁾		
xxxx ¹⁾	xxxx ¹⁾	xxxx ¹⁾
xxxx ¹⁾	xxxx ¹⁾	xxxx ¹⁾
xxxx ¹⁾	xxxx ¹⁾	xxxx ¹⁾
xxxx ¹⁾	xxxx ¹⁾	xxxx ¹⁾
xxxx ¹⁾	xxxx ¹⁾	xxxx ¹⁾
xxxx ¹⁾	xxxx ¹⁾	xxxx ¹⁾
xxxx ¹⁾	xxxx ¹⁾	xxxx ¹⁾
xxxx ¹⁾	xxxx ¹⁾	xxxx ¹⁾
xxxx ¹⁾	xxxx ¹⁾	xxxx ¹⁾

DC inch	L inch	LPR inch	PHD inch	KLG	ZEFP
0.378 - 0.4957	0.374	0.433	DC-0.1220	1	4
0.4961 - 0.6138	0.413	0.433	DC-0.1417	2	4
0.6142 - 0.7319	0.413	0.433	DC-0.1417	4	6
0.6142 - 0.7319	0.413	0.433	DC-0.1417	3	6
0.7323 - 0.9449	0.413	0.433	DC-0.2008	4	6
0.9453 - 1.185	0.413	0.433	DC-0.2362	5	6
1.1854 - 1.2165	0.629	0.669	DC-0.2953	6	6
1.2169 - 1.5748	0.629	0.669	DC-0.2953	6	6
1.5752 - 1.9957	0.629	0.669	DC-0.3150	7	6
1.9961 - 2.3622	0.629	0.669	DC-0.3150	8	6

P	•	•	•
M			•
K	•	•	
N	•		
S			
H			
O			

1) Not available from stock, articles are non-returnable and cannot be exchanged / Minimum order 2 pieces → v_c Page 57-61

For xxxx please indicate piece part bore diameter and tolerance. (e.g. Ø 1.5000" ±.0005")

Assembly instructions can be found on → Page 65

Rapid Set Head

- ▲ KLG = Coupling Size
- ▲ ZEFP = Number of cutting edges

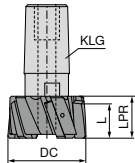

340.70
∠ 25°
ASG05
HM
Through hole

340.92
∠ 25°
ASG05
CERMET
Through hole

DC inch	L inch	LPR inch	KLG	ZEFP	49 805 ...	49 812 ...
0.378 - 0.4957	0.374	0.433	1	4	xxxx ¹⁾	xxxx ¹⁾
0.4961 - 0.6138	0.413	0.433	2	4	xxxx ¹⁾	xxxx ¹⁾
0.6142 - 0.7319	0.413	0.433	3	4	xxxx ¹⁾	xxxx ¹⁾
0.7323 - 0.9449	0.413	0.433	4	6	xxxx ¹⁾	xxxx ¹⁾
0.9453 - 1.185	0.413	0.433	5	6	xxxx ¹⁾	xxxx ¹⁾
1.1854 - 1.2165	0.629	0.669	6	6	xxxx ¹⁾	xxxx ¹⁾
1.2169 - 1.5748	0.629	0.669	6	6	xxxx ¹⁾	xxxx ¹⁾
1.5752 - 1.9957	0.629	0.669	7	6	xxxx ¹⁾	xxxx ¹⁾
1.9961 - 2.3622	0.629	0.669	8	6	xxxx ¹⁾	xxxx ¹⁾
P					○	●
M						
K						
N						
S						
H						
O						

1) Not available from stock, articles are non-returnable and cannot be exchanged / Minimum order 2 pieces

→ v_c Page 57-61

For xxxx please indicate piece part bore diameter and tolerance. (e.g. Ø 1.5000^{±0.0005})

Assembly instructions can be found on → **Page 65**

Holder for Rapid Set Head

▲ KLG = Coupling Size

Supply details:

Holder includes radial coolant screw for diameters 0.4961"-2.3622".
Solid screw included for diameters 0.3780"-0.4957".
Axial coolant screw must be ordered separately.

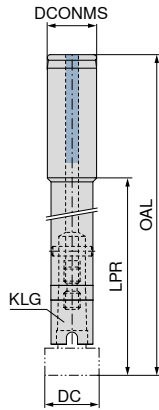

3

DC inch	KOMET no.	OAL inch	LPR inch	DCONMS ^{hg} inch	DCONMS mm	KLG
0.3780 - 0.4957	540.56.001	3.740	1.969	0.500	12.700	1
0.3780 - 0.4957	540.13.001	6.220	4.449	0.500	12.700	1
0.4961 - 0.6138	540.56.002	4.252	2.362	0.625	15.875	2
0.4961 - 0.6138	540.13.002	6.260	4.370	0.625	15.875	2
0.6142 - 0.7319	540.56.003	4.330	2.362	0.625	15.875	3
0.6142 - 0.7319	540.13.003	6.732	4.764	0.625	15.875	3
0.7323 - 0.9449	540.56.004	5.117	3.150	0.750	19.050	4
0.7323 - 0.9449	540.13.004	7.520	5.550	0.750	19.050	4
0.9453 - 1.1850	540.56.005	6.220	3.857	1.000	25.400	5
0.9453 - 1.1850	540.13.005	8.622	6.260	1.000	25.400	5
1.1854 - 1.5748	540.56.006	6.457	4.094	1.000	25.400	6
1.1854 - 1.5748	540.13.006	8.857	6.495	1.000	25.400	6
1.5752 - 1.9957	540.56.007	7.244	4.094	1.000	25.400	7
1.5752 - 1.9957	540.13.007	11.142	7.992	1.000	25.400	7
1.9961 - 2.3622	540.56.008	7.420	4.272	1.000	25.400	8
1.9961 - 2.3622	540.13.008	11.355	8.209	1.000	25.400	8

49 890 ...	49 891 ...
01399	01399
01699	01699
01999	01999
02499	02499
03099	03099
04099	04099
05199	05199
06099	06099

Spare parts

DC	Differential Axial Coolant	Differential Radial Coolant	Threaded pin	Screw short version	Screw long version	Bushing
0.3780 - 0.4957				41600		
0.3780 - 0.4957					41700	
0.4961 - 0.6138	40600	40100	41800			41100
0.6142 - 0.7319	40700	40200	41900			41200
0.7323 - 0.9449	40800	40300	42000			41300
0.9453 - 1.1850	40900	40400	42100			41400
1.1854 - 1.5748	40900	40400	42100			41400
1.5752 - 1.9957	41000	40500	42200			41500
1.9961 - 2.3622	41000	40500	42200			41500

Assembly instructions can be found on → Page 65

Cutting Ring – Selection guide

Ø		2.3858 – 4.3543 inch									
KOMET no.		300.65	300.65	300.17	300.05	300.05	300.45	300.25	300.05	300.45	
Grind geometry		ASG3000	ASG0106	ASG0706	ASG3000	ASG0106	ASG3000	ASG03	ASG4000	ASG4000	
Lead angle		45°	45°	45°/8°	45°	45°	45°	30°/2°	25°	45°	
Grade / coating		DBG-P	DBG-P	DBC	TiN	TiN	DST	K10	TiN	DST	
Article no.		49 836	49 835	49 839	49 823	49 824	49 827	49 832	49 831	49 828	
Application		Through hole + blind hole					Through hole				
Material sub-group		Index									
P	Non alloyed steel	P.1.1									
		P.1.2									
		P.1.3	●			○		●		●	●
		P.1.4									
		P.1.5									
	Low alloyed steel	P.2.1									
		P.2.2	●			○		●			●
		P.2.3									
		P.2.4	●			○					
	High-alloy steel and high-alloy tool steel	P.3.1					●				
P.3.2			●								
P.3.3											
Stainless steel	P.4.1										
	P.4.2		●			○					
M	Stainless steel	M.1.1									
		M.2.1		●			○				
		M.3.1									
K	Grey cast iron	K.1.1	●			○					
		K.1.2									
	Spherulitic graphite cast iron	K.2.1	●					●			
		K.2.2									
	Malleable iron	K.3.1	●					●			
		K.3.2									
N	Aluminum alloys,	N.1.1									
		N.1.2									
	Cast Aluminium Alloys	N.2.1			●						
		N.2.2									
		N.2.3									
	Copper and copper alloys (Bronze, Brass)	N.3.1				○		●		○	
		N.3.2				○				○	
		N.3.3				○				○	
N.4.1			●								
S	Heat resistant alloys	S.1.1									
		S.1.2									
		S.2.1									
		S.2.2									
	S.2.3										
	Titanium alloys	S.3.1									
S.3.2								●			
S.3.3											
O	Non-metal materials	O.1.1									
		O.1.2									
		O.2.1									
		O.2.2									
		O.3.1									

Applications: Main application ●
Additional range of application ○

Cutting ring

- ▲ PHD = Approximate diameter for face machining geometries (ASG)
- ▲ ZEFP = Number of cutting edges

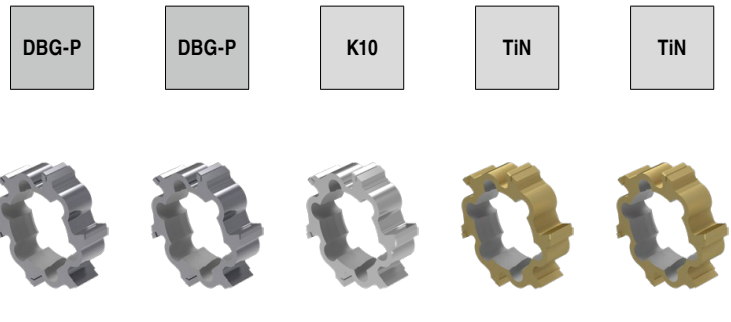
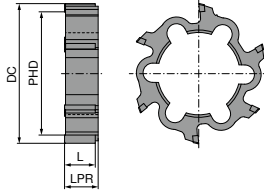

300.65 ∠ 45° ASG3000 HM Through hole + blind hole	300.65 ∠ 45° ASG0106 HM Through hole + blind hole	300.25 ∠ 30/2° ASG03 HM Through hole + blind hole	300.05 ∠ 45° ASG3000 HM Through hole + blind hole	300.05 ∠ 45° ASG0106 HM Through hole + blind hole
--	--	--	--	--

49 836 ...	49 835 ...	49 832 ...	49 823 ...	49 824 ...
-------------------	-------------------	-------------------	-------------------	-------------------

DC inch	L inch	LPR inch	PHD inch	ZEFP	49 836 ...	49 835 ...	49 832 ...	49 823 ...	49 824 ...
2.3858 - 2.5823	0.629	0.728	DC-0.3307	6	xxxx ¹⁾	xxxx ¹⁾	xxxx ¹⁾	xxxx ¹⁾	xxxx ¹⁾
2.5827 - 2.7791	0.629	0.728	DC-0.3307	6	xxxx ¹⁾	xxxx ¹⁾	xxxx ¹⁾	xxxx ¹⁾	xxxx ¹⁾
2.7795 - 2.9760	0.629	0.728	DC-0.3307	6	xxxx ¹⁾	xxxx ¹⁾	xxxx ¹⁾	xxxx ¹⁾	xxxx ¹⁾
2.9764 - 3.1335	0.629	0.728	DC-0.3307	6	xxxx ¹⁾	xxxx ¹⁾	xxxx ¹⁾	xxxx ¹⁾	xxxx ¹⁾
3.1339 - 3.3697	0.629	0.728	DC-0.3307	8	xxxx ¹⁾	xxxx ¹⁾	xxxx ¹⁾	xxxx ¹⁾	xxxx ¹⁾
3.3701 - 3.5665	0.629	0.728	DC-0.3307	8	xxxx ¹⁾	xxxx ¹⁾	xxxx ¹⁾	xxxx ¹⁾	xxxx ¹⁾
3.5669 - 3.7634	0.629	0.728	DC-0.3307	8	xxxx ¹⁾	xxxx ¹⁾	xxxx ¹⁾	xxxx ¹⁾	xxxx ¹⁾
3.7638 - 3.9602	0.629	0.728	DC-0.3307	8	xxxx ¹⁾	xxxx ¹⁾	xxxx ¹⁾	xxxx ¹⁾	xxxx ¹⁾
3.9606 - 4.3539	0.629	0.728	DC-0.3307	10	xxxx ¹⁾	xxxx ¹⁾	xxxx ¹⁾	xxxx ¹⁾	xxxx ¹⁾
P					●	●		○	●
M									○
K					●			○	
N								○	
S							●		
H									
O									

1) Not available from stock, articles are non-returnable and cannot be exchanged / Minimum order 2 pieces

1) For xxxx please indicate piece part bore diameter and tolerance. (e.g. Ø 2.5000" ±.0005")

1) Assembly instructions can be found on → Page 66+67

Cutting ring

- ▲ PHD = Approximate diameter for face machining geometries (ASG)
- ▲ ZEFP = Number of cutting edges

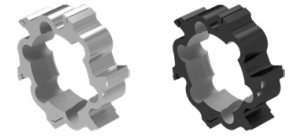
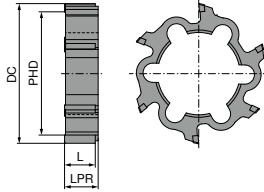

300.45 ∠ 45° ASG3000 CERMET Through hole + blind hole	300.17 ∠ 45° ASG0706 HM Through hole + blind hole
--	--

DC inch	L inch	LPR inch	PHD inch	ZEFP
2.3858 - 2.5823	0.629	0.688	DC-0.3307	6
2.3858 - 2.5823	0.629	0.728	DC-0.3307	6
2.5827 - 2.7791	0.629	0.688	DC-0.3307	6
2.5827 - 2.7791	0.629	0.728	DC-0.3307	6
2.7795 - 2.9760	0.629	0.688	DC-0.3307	6
2.7795 - 2.9760	0.629	0.728	DC-0.3307	6
2.9764 - 3.1335	0.629	0.688	DC-0.3307	6
2.9764 - 3.1335	0.629	0.728	DC-0.3307	6
3.1339 - 3.3697	0.629	0.688	DC-0.3307	8
3.1339 - 3.3697	0.629	0.728	DC-0.3307	8
3.3701 - 3.5665	0.629	0.688	DC-0.3307	8
3.3701 - 3.5665	0.629	0.728	DC-0.3307	8
3.5669 - 3.7634	0.629	0.688	DC-0.3307	8
3.5669 - 3.7634	0.629	0.728	DC-0.3307	8
3.7638 - 3.9602	0.629	0.688	DC-0.3307	8
3.7638 - 3.9602	0.629	0.728	DC-0.3307	8
3.9606 - 4.3539	0.629	0.688	DC-0.3307	10
3.9606 - 4.3539	0.629	0.728	DC-0.3307	10

49 827 ...	49 839 ...
xxxx ¹⁾	
xxxx ¹⁾	xxxx ¹⁾
xxxx ¹⁾	xxxx ¹⁾
xxxx ¹⁾	xxxx ¹⁾
xxxx ¹⁾	xxxx ¹⁾
xxxx ¹⁾	xxxx ¹⁾
xxxx ¹⁾	xxxx ¹⁾
xxxx ¹⁾	xxxx ¹⁾
xxxx ¹⁾	xxxx ¹⁾
xxxx ¹⁾	xxxx ¹⁾
xxxx ¹⁾	xxxx ¹⁾
xxxx ¹⁾	xxxx ¹⁾
xxxx ¹⁾	xxxx ¹⁾
xxxx ¹⁾	xxxx ¹⁾
xxxx ¹⁾	xxxx ¹⁾
xxxx ¹⁾	xxxx ¹⁾
xxxx ¹⁾	xxxx ¹⁾

P	●	
M		
K	●	
N	●	●
S		
H		
O		

1) Not available from stock, articles are non-returnable and cannot be exchanged / Minimum order 2 pieces → v_c Page 52-56

For xxxx please indicate piece part bore diameter and tolerance. (e.g. Ø 2.5000" ±.0005")

Assembly instructions can be found on → **Page 66+67**

Cutting ring

- ▲ PHD = Approximate diameter for face machining geometries (ASG)
- ▲ ZEFP = Number of cutting edges

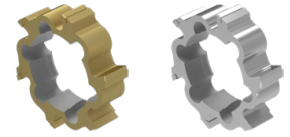
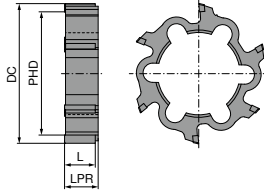

300.05
∠ 25°
ASG4000
HM
Through hole

300.45
∠ 25°
ASG4000
CERMET
Through hole

DC inch	L inch	LPR inch	PHD inch	ZEFP	49 831 ...	49 828 ...
2.3858 - 2.5823	0.629	0.728	DC-0.3307	6	xxxx ¹⁾	
2.3858 - 2.5823	0.629	0.688	DC-0.3307	6		xxxx ¹⁾
2.5827 - 2.7791	0.629	0.728	DC-0.3307	6	xxxx ¹⁾	
2.5827 - 2.7791	0.629	0.688	DC-0.3307	6		xxxx ¹⁾
2.7795 - 2.9760	0.629	0.728	DC-0.3307	6	xxxx ¹⁾	
2.7795 - 2.9760	0.629	0.688	DC-0.3307	6		xxxx ¹⁾
2.9764 - 3.1335	0.629	0.728	DC-0.3307	6	xxxx ¹⁾	
2.9764 - 3.1335	0.629	0.688	DC-0.3307	6		xxxx ¹⁾
3.1339 - 3.3697	0.629	0.728	DC-0.3307	8	xxxx ¹⁾	
3.1339 - 3.3697	0.629	0.688	DC-0.3307	8		xxxx ¹⁾
3.3701 - 3.5665	0.629	0.728	DC-0.3307	8	xxxx ¹⁾	
3.3701 - 3.5665	0.629	0.688	DC-0.3307	8		xxxx ¹⁾
3.5669 - 3.7634	0.629	0.728	DC-0.3307	8	xxxx ¹⁾	
3.5669 - 3.7634	0.629	0.688	DC-0.3307	8		xxxx ¹⁾
3.7638 - 3.9602	0.629	0.728	DC-0.3307	8	xxxx ¹⁾	
3.7638 - 3.9602	0.629	0.688	DC-0.3307	8		xxxx ¹⁾
3.9606 - 4.3539	0.629	0.728	DC-0.3307	10	xxxx ¹⁾	
3.9606 - 4.3539	0.629	0.688	DC-0.3307	10		xxxx ¹⁾
P					●	●
M						
K						
N					○	
S						
H						
O						

1) Not available from stock, articles are non-returnable and cannot be exchanged / Minimum order 2 pieces

→ v_c Page 52-56

For xxxx please indicate piece part bore diameter and tolerance. (e.g. Ø 2.5000" ±.0005")

Assembly instructions can be found on → Page 66+67

Cutting ring holder for through hole machining

Supply details:

Holder includes positioning pin, taper ring and adjusting nut. Does not include cutting ring.

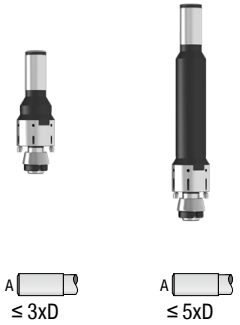
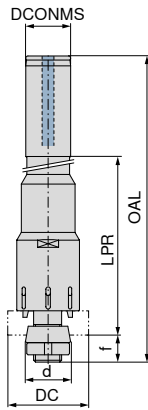

DC inch	KOMET no.	OAL inch	LPR inch	DCONMS inch	DCONMS mm	d mm	f inch
2.3858 - 2.7795	503.76.008	7.460	4.133	1.259	32	40.000	0.964
2.3858 - 2.7795	504.76.009	12.657	9.330	1.259	32	40.000	0.964
2.7795 - 3.1338	503.76.009	7.460	4.133	1.259	32	40.000	0.964
2.7795 - 3.1338	504.76.010	12.657	9.330	1.259	32	40.000	0.964
3.1339 - 3.5669	503.76.010	8.011	4.133	1.574	40	56.200	1.122
3.1339 - 3.5669	504.76.011	13.326	9.448	1.574	40	56.200	1.122
3.5669 - 3.9606	503.76.011	8.011	4.133	1.574	40	56.200	1.122
3.5669 - 3.9606	504.76.012	13.326	9.448	1.574	40	56.200	1.122

40 892 ...	40 893 ...
07199	07199
08099	08099
09199	09199
10199	10199

Spare parts
DC

2.3858 - 2.7795	50700	50500	50100
2.7795 - 3.1338	50700	50500	50100
3.1339 - 3.5669	50800	50600	50200
3.5669 - 3.9606	50800	50600	50200

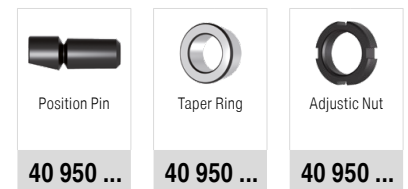

40 950 ...	40 950 ...	40 950 ...
50700	50500	50100
50700	50500	50100
50800	50600	50200
50800	50600	50200

Assembly instructions can be found on → **Page 66+67**

Cutting ring holder for blind hole machining

Supply details:

Holder includes bushing, taper screw and adjusting nut. Does not include cutting ring.

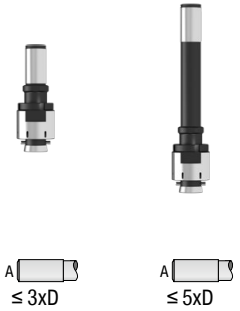
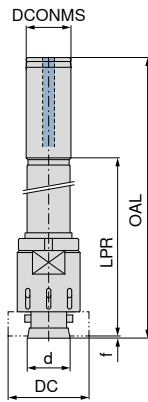

3

DC inch	KOMET no.	OAL inch	LPR inch	DCONMS inch	DCONMS mm	d inch	f inch	40 895 ...	40 897 ...
2.3858 - 2.7795	513.81.008	6.555	4.133	1.259	32	1.456	0.059	07199	
2.3858 - 2.7795	514.81.008	11.752	9.330	1.259	32	1.456	0.059		07199
2.7795 - 3.1338	513.81.009	6.555	4.133	1.259	32	1.456	0.059	08099	
2.7795 - 3.1338	514.81.009	11.752	9.330	1.259	32	1.456	0.059		08099
3.1339 - 3.5669	513.81.010	6.948	4.133	1.574	40	2.094	0.059	09199	
3.1339 - 3.5669	514.81.010	12.263	9.448	1.574	40	2.094	0.059		09199
3.5669 - 3.9606	513.81.011	6.948	4.133	1.574	40	2.094	0.059	10199	
3.5669 - 3.9606	514.81.011	12.263	9.448	1.574	40	2.094	0.059		10199

Spare parts

DC	40 950 ...	40 950 ...	40 950 ...
2.3858 - 2.7795	51500	51300	50300
2.7795 - 3.1338	51600	51300	50300
3.1339 - 3.5669	51700	51400	50400
3.5669 - 3.9606	51800	51400	50400

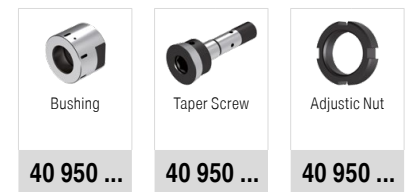

Assembly instructions can be found on → **Page 66+67**

Cutting ring holder for blind hole machining

Supply details:

Holder includes bushing, taper screw and adjusting nut. Does not include cutting ring.

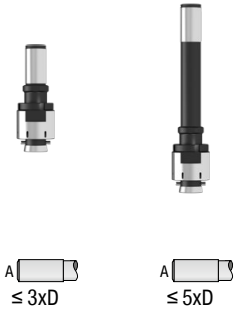
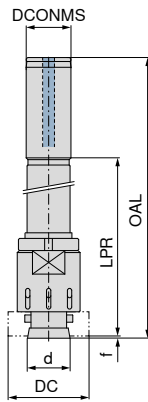

DC inch	KOMET no.	OAL inch	LPR inch	DCONMS inch	DCONMS mm	d inch	f inch	40 894 ...	40 896 ...
2.3858 - 2.7795	513.76.008	6.555	4.133	1.259	32	1.456	0.059	07199	
2.3858 - 2.7795	514.76.008	11.752	9.330	1.259	32	1.456	0.059		07199
2.7795 - 3.1338	513.76.009	6.555	4.133	1.259	32	1.456	0.059	08099	
2.7795 - 3.1338	514.76.009	11.752	9.330	1.259	32	1.456	0.059		08099
3.1339 - 3.5669	513.76.010	6.948	4.133	1.574	40	2.094	0.059	09199	
3.1339 - 3.5669	514.76.010	12.263	9.448	1.574	40	2.094	0.059		09199
3.5669 - 3.9606	513.76.011	6.948	4.133	1.574	40	2.094	0.059	10199	
3.5669 - 3.9606	514.76.011	12.263	9.448	1.574	40	2.094	0.059		10199

Spare parts

DC	40 950 ...	40 950 ...	40 950 ...
2.3858 - 2.7795	51500	51100	50300
2.7795 - 3.1338	51600	51100	50300
3.1339 - 3.5669	51700	51200	50400
3.5669 - 3.9606	51800	51200	50400

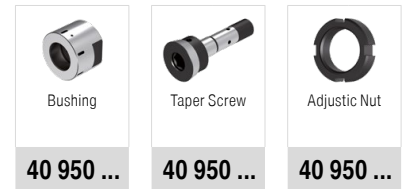

Assembly instructions can be found on → **Page 66+67**

Monomax – Selection guide – Through hole

Ø		.2205 – 1.0196 inch								
KOMET no. (3xD)		56J.65	56J.65	56J.17	56J.71	56J.71	56J.71	56J.93	56J.93	56J.21
KOMET no. (5xD)		56R.65	56R.65	56R.17	56R.71	56R.71	56R.71	56R.93	56R.93	56R.21
Grind geometry		ASG0106	ASG3000	ASG0706	ASG4000	ASG3000	ASG0106	ASG4000	ASG3000	ASG03
Lead angle		45°	45°	45°/8°	45°	45°	45°	25°	45°	30°/2°
Grade / coating		DBG-P	DBG-P	DBC	TiN	TiN	TiN	DST	DST	K10
Article no. (3xD)		49 652	49 676	49 648	49 688	49 605	49 656	49 635	49 625	49 672
Article no. (5xD)		49 653	49 677	49 649	49 689	49 606	49 661	49 636	49 626	49 673
Application		Through hole								
Material sub-group		Index								
P	Non alloyed steel	P.1.1								
		P.1.2								
		P.1.3				●	○		●	●
		P.1.4								
		P.1.5								
	Low alloyed steel	P.2.1								
		P.2.2					○		●	●
		P.2.3								
	P.2.4	●								
	High-alloy steel and high-alloy tool steel	P.3.1								
P.3.2										
P.3.3		●					○			
Stainless steel	P.4.1									
	P.4.2									
M	Stainless steel	M.1.1								
		M.2.1	●					○		
		M.3.1								
K	Grey cast iron	K.1.1					○			
		K.1.2		●						
	Spherulitic graphite cast iron	K.2.1		●				○	●	
		K.2.2								
	Malleable iron	K.3.1		●				○	●	
		K.3.2								
N	Aluminum alloys,	N.1.1								
		N.1.2								
	Aluminium-Gusslegierungen	N.2.1			●					
		N.2.2								
		N.2.3								
	Copper and copper alloys (Bronze, Brass)	N.3.1							○	
		N.3.2					●			
		N.3.3								
	Magnesium alloys	N.4.1								
S	Heat resistant alloys	S.1.1								
		S.1.2								
		S.2.1								
		S.2.2								
		S.2.3								
	Titanium alloys	S.3.1								
		S.3.2								●
S.3.3										
O	Non-metal materials	O.1.1								
		O.1.2								
		O.2.1								
		O.2.2								
		O.3.1				○				

3

Applications: _____ Main application ●
Additional range of application ○

Monomax – Selection guide – Blind hole

Ø		.2205 – 1.0196 inch							
KOMET no. (3xD)		56H.65	56H.65	56H.71	56H.71	56H.17	56H.93	56H.21	
KOMET no. (5xD)		56Q.65	56Q.65	56Q.71	56Q.71	56Q.17	56Q.93	56Q.21	
Grind geometry		ASG3000	ASG0106	ASG3000	ASG0106	ASG0706	ASG3000	ASG03	
Lead angle		45°	45°	45°	45°	45°/8°	45°	30°/2°	
Grade / coating		DBG-P	DBG-P	TiN	TiN	DBC	DST	K10	
Article no. (3xD)		49 657	49 644	49 684	49 660	49 640	49 680	49 668	
Article no. (5xD)		49 665	49 645	49 685	49 664	49 641	49 681	49 669	
Application		Blind hole							
Material sub-group	Index								
P	Non alloyed steel	P.1.1							
		P.1.2							
		P.1.3	●		○			●	
		P.1.4							
		P.1.5							
	Low alloyed steel	P.2.1							
		P.2.2	●		○			●	
		P.2.3							
		P.2.4	●						
	High-alloy steel and high-alloy tool steel	P.3.1							
P.3.2			●						
P.3.3					○				
Stainless steel	P.4.1								
	P.4.2								
M	Stainless steel	M.1.1							
		M.2.1		●					
		M.3.1				○			
K	Grey cast iron	K.1.1	●		○				
		K.1.2							
	Spherulitic graphite cast iron	K.2.1	●					●	
		K.2.2							
	Malleable iron	K.3.1	●					●	
		K.3.2							
N	Aluminum alloys,	N.1.1							
		N.1.2							
	Aluminium-Gusslegierungen	N.2.1					●		
		N.2.2							
		N.2.3							
	Copper and copper alloys (Bronze, Brass)	N.3.1						○	
		N.3.2			●				
		N.3.3							
Magnesium alloys	N.4.1								
S	Heat resistant alloys	S.1.1							
		S.1.2							
		S.2.1							
		S.2.2							
		S.2.3							
	Titanium alloys	S.3.1							
		S.3.2						●	
	S.3.3								
O	Non-metal materials	O.1.1							
		O.1.2							
		O.2.1							
		O.2.2							
		O.3.1					○		

Applications:

Main application

Additional range of application



Monomax – High-speed reamers, short

- ▲ adjustable for smallest bore tolerances
- ▲ wear compensation within the tolerance zone
- ▲ retraction from the hole at 3-4 times the cutting feed rate
- ▲ up to tolerance class IT 5
- ▲ ZEFP = number of cutting edges

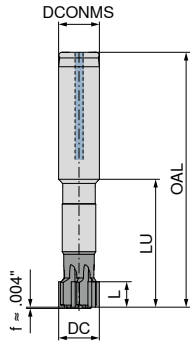

DST	DBC	DBG-P	DST	TIN
56J.93 ≤ 3xD ∠45° ASG3000 CERMET Through hole	56J.17 ≤ 3xD ∠45/8° ASG0706 HM Through hole	56J.65 ≤ 3xD ∠45° ASG0106 HM Through hole	56J.93 ≤ 3xD ∠25° ASG4000 CERMET Through hole	56J.71 ≤ 3xD ∠45° ASG3000 HM Through hole

DC	OAL	LU	L	DCONMS _{h6}	DCONMS	ZEFP	49 625 ...	49 648 ...	49 652 ...	49 635 ...	49 605 ...
inch	inch	inch	inch	inch	mm						
0.2205 - 0.3504	3.346	1.574	0.393	0.472	12	4	xxxx ¹⁾	xxxx ¹⁾	xxxx ¹⁾	xxxx ¹⁾	xxxx ¹⁾
0.3504 - 0.6259	3.740	1.968	0.393	0.472	12	6	xxxx ¹⁾	xxxx ¹⁾	xxxx ¹⁾	xxxx ¹⁾	xxxx ¹⁾
0.6260 - 0.7441	3.937	1.968	0.393	0.629	16	6	xxxx ¹⁾	xxxx ¹⁾	xxxx ¹⁾	xxxx ¹⁾	xxxx ¹⁾
0.7441 - 1.0197	4.724	2.362	0.393	0.787	20	6	xxxx ¹⁾	xxxx ¹⁾	xxxx ¹⁾	xxxx ¹⁾	xxxx ¹⁾
P							●		●	●	○
M									●		
K							●			○	○
N							○	●			●
S											
H											
O								○			

1) Not available from stock, articles are non-returnable and cannot be exchanged / Minimum order 2 pieces

Do not heat shrink tools !

For xxxx please indicate piece part bore diameter and tolerance. (e.g. Ø .5000" ±.0005")

Monomax – High-speed reamers, short

- ▲ adjustable for smallest bore tolerances
- ▲ wear compensation within the tolerance zone
- ▲ retraction from the hole at 3-4 times the cutting feed rate
- ▲ up to tolerance class IT 5
- ▲ ZEFP = number of cutting edges

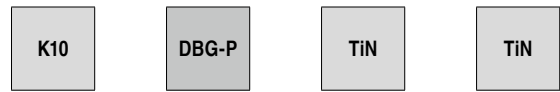
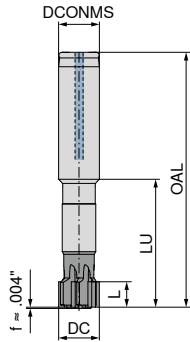

56J.21
≤ 3xD
∠30/2°
ASG03
HM

56J.65
≤ 3xD
∠45°
ASG3000
HM

56J.17
≤ 3xD
∠25°
ASG4000
HM

56J.71
≤ 3xD
∠45°
ASG0106
HM

Through hole

Through hole

Through hole

Through hole

49 672 ...

49 676 ...

49 688 ...

49 656 ...

DC inch	OAL inch	LU inch	L inch	DCONMS _{h6} inch	DCONMS mm	ZEFP				
0.2205 - 0.3504	3.346	1.574	0.393	0.472	12	4				
0.3504 - 0.6259	3.740	1.968	0.393	0.472	12	6	xxxx ¹⁾	xxxx ¹⁾	xxxx ¹⁾	xxxx ¹⁾
0.6260 - 0.7441	3.937	1.968	0.393	0.629	16	6	xxxx ¹⁾	xxxx ¹⁾	xxxx ¹⁾	xxxx ¹⁾
0.7441 - 1.0197	4.724	2.362	0.393	0.787	20	6	xxxx ¹⁾	xxxx ¹⁾	xxxx ¹⁾	xxxx ¹⁾
P									●	○
M										○
K								●		
N										
S								●		
H										
O										

1) Not available from stock, articles are non-returnable and cannot be exchanged / Minimum order 2 pieces

→ v_c Page 46-51

1 Do not heat shrink tools !

1 For xxxx please indicate piece part bore diameter and tolerance. (e.g. Ø .5000" ±.0005")

Monomax – High-speed reamers, short

- ▲ adjustable for smallest bore tolerances
- ▲ wear compensation within the tolerance zone
- ▲ retraction from the hole at 3-4 times the cutting feed rate
- ▲ up to tolerance class IT 5
- ▲ ZEFP = number of cutting edges

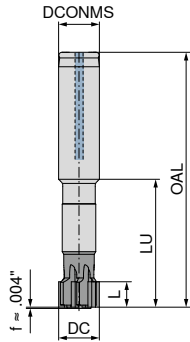

	49 644 ...	49 640 ...	49 657 ...
P	•		•
M	•		
K			•
N		•	
S			
H			
O		○	

DC inch	OAL inch	LU inch	L inch	DCONMS _{h6} inch	DCONMS mm	ZEFP
0.2205 - 0.3504	3.346	1.574	0.393	0.472	12	4
0.3504 - 0.6259	3.740	1.968	0.393	0.472	12	6
0.6260 - 0.7441	3.937	1.968	0.393	0.629	16	6
0.7441 - 1.0197	4.724	2.362	0.393	0.787	20	6

1) Not available from stock, articles are non-returnable and cannot be exchanged / Minimum order 2 pieces

→ v_c Page 46-51

1 Do not heat shrink tools !

1 For xxxx please indicate piece part bore diameter and tolerance. (e.g. Ø .5000" ±.0005")

Monomax – High-speed reamers, short

- ▲ adjustable for smallest bore tolerances
- ▲ wear compensation within the tolerance zone
- ▲ retraction from the hole at 3-4 times the cutting feed rate
- ▲ up to tolerance class IT 5
- ▲ ZEFP = number of cutting edges

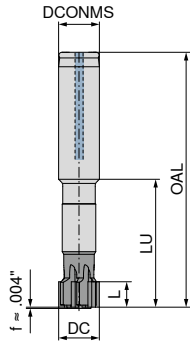

TiN	K10	DST	TiN
56H.71 ≤ 3xD ∠ 45° ASG0106 HM Blind hole	56H.21 ≤ 3xD ∠ 30/2° ASG03 HM Blind hole	56H.93 ≤ 3xD ∠ 45° ASG3000 CERMET Blind hole	56H.71 ≤ 3xD ∠ 45° ASG3000 HM Blind hole

	49 660 ...	49 668 ...	49 680 ...	49 684 ...
DC	0.2205 - 0.3504	0.3504 - 0.6259	0.6260 - 0.7441	0.7441 - 1.0197
OAL	3.346	3.740	3.937	4.724
LU	1.574	1.968	1.968	2.362
L	0.393	0.393	0.393	0.393
DCONMS _{h6}	0.472	0.472	0.629	0.787
DCONMS	12	12	16	20
ZEFP	4	6	6	6
P	○		●	○
M	○			
K			●	○
N			○	●
S		●		
H				
O				

1) Not available from stock, articles are non-returnable and cannot be exchanged / Minimum order 2 pieces

Do not heat shrink tools !

For xxxx please indicate piece part bore diameter and tolerance. (e.g. Ø .5000" ±.0005")

Monomax – High-speed reamers, long

- ▲ adjustable for smallest bore tolerances
- ▲ wear compensation within the tolerance zone
- ▲ retraction from the hole at 3-4 times the cutting feed rate
- ▲ up to tolerance class IT 5
- ▲ ZEFP = number of cutting edges

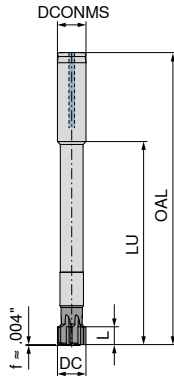

DST	DBC	DBG-P	DST	TIN
56R.93 ≤ 5xD ∠ 45° ASG3000 CERMET Through hole	56R.17 ≤ 5xD ∠ 45/8° ASG0706 HM Through hole	56R.65 ≤ 5xD ∠ 45° ASG0106 HM Through hole	56R.93 ≤ 5xD ∠ 25° ASG4000 CERMET Through hole	56R.71 ≤ 5xD ∠ 45° ASG3000 HM Through hole

DC	OAL	LU	L	DCONMS ₀₆	DCONMS	ZEFP	49 626 ...	49 649 ...	49 653 ...	49 636 ...	49 606 ...
inch	inch	inch	inch	inch	mm						
0.2205 - 0.3504	5.118	3.346	0.393	0.472	12	4	xxxx ¹⁾	xxxx ¹⁾	xxxx ¹⁾	xxxx ¹⁾	xxxx ¹⁾
0.3504 - 0.3897	5.118	3.346	0.393	0.472	12	6	xxxx ¹⁾	xxxx ¹⁾	xxxx ¹⁾	xxxx ¹⁾	xxxx ¹⁾
0.3898 - 0.6259	6.299	4.527	0.393	0.472	12	6	xxxx ¹⁾	xxxx ¹⁾	xxxx ¹⁾	xxxx ¹⁾	xxxx ¹⁾
0.6260 - 0.7441	7.086	5.118	0.393	0.629	16	6	xxxx ¹⁾	xxxx ¹⁾	xxxx ¹⁾	xxxx ¹⁾	xxxx ¹⁾
0.7441 - 1.0197	7.874	5.511	0.393	0.787	20	6	xxxx ¹⁾	xxxx ¹⁾	xxxx ¹⁾	xxxx ¹⁾	xxxx ¹⁾
P							●		●	●	○
M									●		
K							●			○	○
N							○	●			●
S											
H											
O								○			

1) Not available from stock, articles are non-returnable and cannot be exchanged / Minimum order 2 pieces

Do not heat shrink tools!

For xxxx please indicate piece part bore diameter and tolerance. (e.g. Ø .5000" ±.0005")

Monomax – High-speed reamers, long

- ▲ adjustable for smallest bore tolerances
- ▲ wear compensation within the tolerance zone
- ▲ retraction from the hole at 3-4 times the cutting feed rate
- ▲ up to tolerance class IT 5
- ▲ ZEFP = number of cutting edges

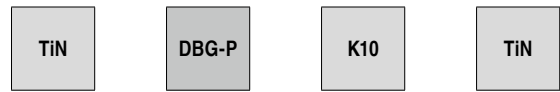
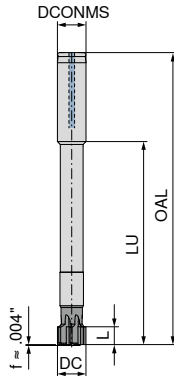

56R.71 ≤ 5xD ∠ 45° ASG4000 HM Through hole	56R.65 ≤ 5xD ∠ 45° ASG3000 HM Through hole	56R.21 ≤ 5xD ∠ 30/2° ASG03 HM Through hole	56R.71 ≤ 5xD ∠ 45° ASG0106 HM Through hole
---	---	---	---

49 689 ...	49 677 ...	49 673 ...	49 661 ...
xxxx ¹⁾	xxxx ¹⁾	xxxx ¹⁾	xxxx ¹⁾
xxxx ¹⁾	xxxx ¹⁾	xxxx ¹⁾	xxxx ¹⁾
xxxx ¹⁾	xxxx ¹⁾	xxxx ¹⁾	xxxx ¹⁾
xxxx ¹⁾	xxxx ¹⁾	xxxx ¹⁾	xxxx ¹⁾

DC inch	OAL inch	LU inch	L inch	DCONMS _{h6} inch	DCONMS mm	ZEFP
0.2205 - 0.3504	5.118	3.346	0.393	0.472	12	4
0.3504 - 0.3897	5.118	3.346	0.393	0.472	12	6
0.3898 - 0.6259	6.299	4.527	0.393	0.472	12	6
0.6260 - 0.7441	7.086	5.118	0.393	0.629	16	6
0.7441 - 1.0197	7.874	5.511	0.393	0.787	20	6

P	●	○
M		○
K	●	
N		
S		●
H		
O		

1) Not available from stock, articles are non-returnable and cannot be exchanged / Minimum order 2 pieces

Do not heat shrink tools!

For xxxx please indicate piece part bore diameter and tolerance. (e.g. Ø .5000" ±.0005")

Monomax – High-speed reamers, long

- ▲ adjustable for smallest bore tolerances
- ▲ wear compensation within the tolerance zone
- ▲ retraction from the hole at 3–4 times the cutting feed rate
- ▲ up to tolerance class IT 5
- ▲ ZEFP = number of cutting edges

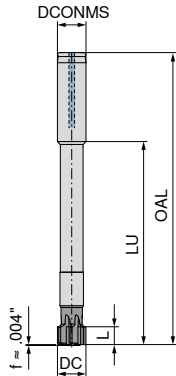

DC inch	OAL inch	LU inch	L inch	DCONMS _{h6} inch	DCONMS mm	ZEFP
0.2205 - 0.3504	5.118	3.346	0.393	0.472	12	4
0.3504 - 0.3897	5.118	3.346	0.393	0.472	12	6
0.3898 - 0.6259	6.299	4.527	0.393	0.472	12	6
0.6260 - 0.7441	7.086	5.118	0.393	0.629	16	6
0.7441 - 1.0197	7.874	5.511	0.393	0.787	20	6

49 645 ...	49 641 ...	49 665 ...
xxxx ¹⁾	xxxx ¹⁾	xxxx ¹⁾
xxxx ¹⁾	xxxx ¹⁾	xxxx ¹⁾
xxxx ¹⁾	xxxx ¹⁾	xxxx ¹⁾
xxxx ¹⁾	xxxx ¹⁾	xxxx ¹⁾
xxxx ¹⁾	xxxx ¹⁾	xxxx ¹⁾

P	●	●
M	●	
K		●
N		●
S		
H		
O		○

1) Not available from stock, articles are non-returnable and cannot be exchanged / Minimum order 2 pieces

Do not heat shrink tools!

For xxxx please indicate piece part bore diameter and tolerance. (e.g. Ø .5000" ±.0005")

Monomax – High-speed reamers, long

- ▲ adjustable for smallest bore tolerances
- ▲ wear compensation within the tolerance zone
- ▲ retraction from the hole at 3–4 times the cutting feed rate
- ▲ up to tolerance class IT 5
- ▲ ZEFP = number of cutting edges

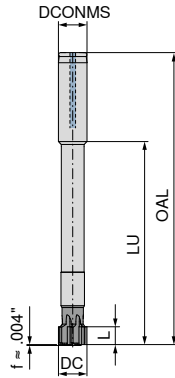

DST	TiN	K10	TiN
56Q.93 ≤ 5xD ∠ 45° ASG3000 CERMET Blind hole	56Q.71 ≤ 5xD ∠ 45° ASG3000 HM Blind hole	56Q.21 ≤ 5xD ∠ 30/2° ASG03 HM Blind hole	56Q.71 ≤ 5xD ∠ 45° ASG0106 HM Blind hole

DC inch	OAL inch	LU inch	L inch	DCONMS _{h6} inch	DCONMS mm	ZEFP
0.2205 - 0.3504	5.118	3.346	0.393	0.472	12	4
0.3504 - 0.3897	5.118	3.346	0.393	0.472	12	6
0.3898 - 0.6259	6.299	4.527	0.393	0.472	12	6
0.6260 - 0.7441	7.086	5.118	0.393	0.629	16	6
0.7441 - 1.0197	7.874	5.511	0.393	0.787	20	6

49 681 ...	49 685 ...	49 669 ...	49 664 ...
xxxx ¹⁾	xxxx ¹⁾	xxxx ¹⁾	xxxx ¹⁾
xxxx ¹⁾	xxxx ¹⁾	xxxx ¹⁾	xxxx ¹⁾
xxxx ¹⁾	xxxx ¹⁾	xxxx ¹⁾	xxxx ¹⁾
xxxx ¹⁾	xxxx ¹⁾	xxxx ¹⁾	xxxx ¹⁾

P	●	○	○
M			○
K	●	○	
N	○	●	
S			●
H			
O			

1) Not available from stock, articles are non-returnable and cannot be exchanged / Minimum order 2 pieces

Do not heat shrink tools!

For xxxx please indicate piece part bore diameter and tolerance. (e.g. Ø .5000" ±.0005")

PCD Reamers – Selection guide

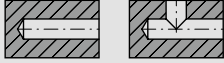
Ø		.1575 – .7913 inch			
KOMET no.		690.10	690.11	690.13	690.14
Number of flutes		2	4	2	4
Grind geometry		ASG1101		ASG1101	
Lead angle		45°		45°	
Grade / coating		PCD-U		PCD-U	
Article no.		49 200	49 201	49 204	49 205
Application		Through hole 		Blind hole 	
Material sub-group		Index			
P	Non alloyed steel	P.1.1			
		P.1.2			
		P.1.3			
		P.1.4			
		P.1.5			
	Low alloyed steel	P.2.1			
		P.2.2			
		P.2.3			
		P.2.4			
	High-alloy steel and high-alloy tool steel	P.3.1			
		P.3.2			
		P.3.3			
Stainless steel	P.4.1				
	P.4.2				
M	Stainless steel	M.1.1			
		M.2.1			
		M.3.1			
K	Grey cast iron	K.1.1			
		K.1.2			
	Spherulitic graphite cast iron	K.2.1			
		K.2.2			
	Malleable iron	K.3.1			
K.3.2					
N	Aluminum alloys,	N.1.1			
		N.1.2			
	Aluminium-Gusslegierungen	N.2.1	●	●	
		N.2.2			
		N.2.3			
	Copper and copper alloys (Bronze, Brass)	N.3.1			
		N.3.2			
N.3.3					
Magnesium alloys	N.4.1	●	●		
S	Heat resistant alloys	S.1.1			
		S.1.2			
		S.2.1			
		S.2.2			
		S.2.3			
	Titanium alloys	S.3.1			
		S.3.2			
	S.3.3				
O	Non-metal materials	O.1.1			
		O.1.2			
		O.2.1			
		O.2.2			
		O.3.1			

3

PCD – Reamers

- ▲ Solid Carbide body
- ▲ PHD = Diameter for face machining
- ▲ ZEPF = Number of cutting edges

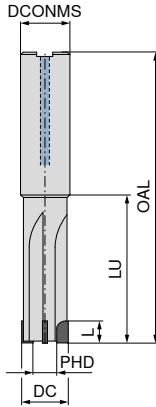

DC	OAL	L	LU	PHD	DCONMS _{h6}	DCONMS	ZEPF	49 204 ...	49 205 ...
inch	inch	inch	inch	inch	inch	mm			
0.1575 - 0.1811	2.519	0.275	1.102	DC-0.0945	0.236	6	2	xxxx ¹⁾	
0.1811 - 0.2008	2.519	0.275	1.102	DC-0.1024	0.236	6	2	xxxx ¹⁾	
0.2008 - 0.2205	2.519	0.275	1.102	DC-0.1063	0.236	6	2	xxxx ¹⁾	
0.2205 - 0.2402	2.795	0.275	1.377	DC-0.1102	0.236	6	2	xxxx ¹⁾	
0.2402 - 0.2598	2.992	0.275	1.574	DC-0.1339	0.314	8	2	xxxx ¹⁾	
0.2599 - 0.2795	2.992	0.275	1.574	DC-0.1339	0.314	8	2	xxxx ¹⁾	
0.2796 - 0.2992	2.992	0.275	1.574	DC-0.1339	0.314	8	2	xxxx ¹⁾	
0.2993 - 0.3189	2.992	0.275	1.574	DC-0.1417	0.314	8	2	xxxx ¹⁾	
0.3189 - 0.3386	3.346	0.275	1.574	DC-0.1417	0.472	12	2	xxxx ¹⁾	
0.3386 - 0.3583	3.346	0.275	1.574	DC-0.1614	0.472	12	2	xxxx ¹⁾	
0.3583 - 0.3976	3.346	0.275	1.574	DC-0.1811	0.472	12	2	xxxx ¹⁾	
0.3780 - 0.3976	3.346	0.275	1.574	DC-0.1496	0.472	12	4		xxxx ¹⁾
0.3977 - 0.4567	3.740	0.275	1.968	DC-0.1969	0.472	12	2	xxxx ¹⁾	
0.3977 - 0.4567	3.740	0.275	1.968	DC-0.1496	0.472	12	4		xxxx ¹⁾
0.4567 - 0.5551	3.740	0.275	1.968	DC-0.2362	0.472	12	2	xxxx ¹⁾	
0.4567 - 0.5551	3.740	0.275	1.968	DC-0.1496	0.472	12	4		xxxx ¹⁾
0.5552 - 0.5945	3.858	0.275	1.968	DC-0.2598	0.629	16	2	xxxx ¹⁾	
0.5552 - 0.5945	3.858	0.275	1.968	DC-0.1535	0.629	16	4		xxxx ¹⁾
0.5945 - 0.6339	3.858	0.275	1.968	DC-0.2795	0.629	16	2	xxxx ¹⁾	
0.5945 - 0.6339	3.858	0.275	1.968	DC-0.1535	0.629	16	4		xxxx ¹⁾
0.6339 - 0.7126	4.251	0.275	2.362	DC-0.3150	0.629	16	2	xxxx ¹⁾	
0.6339 - 0.7126	4.251	0.275	2.362	DC-0.1811	0.629	16	4		xxxx ¹⁾
0.7126 - 0.7913	4.330	0.275	2.362	DC-0.3386	0.787	20	2	xxxx ¹⁾	
0.7126 - 0.7913	4.330	0.275	2.362	DC-0.1811	0.787	20	4		xxxx ¹⁾

P	
M	
K	
N	•
S	
H	
O	

1) Not available from stock, articles are non-returnable and cannot be exchanged / Minimum order 2 pieces

For xxxx please indicate piece part bore diameter and tolerance. (e.g. Ø .5000" ±.0005")

PCD - Reamers

- ▲ Solid Carbide body
- ▲ PHD = Diameter for face machining
- ▲ ZEFP = Number of cutting edges

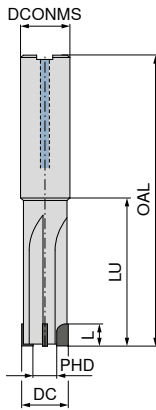

DC inch	OAL inch	L inch	LU inch	PHD inch	DCONMS _{h6} inch	DCONMS mm	ZEFP	49 200 ...	49 201 ...
0.2205 - 0.2402	2.795	0.275	1.377	DC-0.1102	0.236	6	2	xxxx ¹⁾	
0.2402 - 0.2598	2.992	0.275	1.574	DC-0.1339	0.314	8	2	xxxx ¹⁾	
0.2599 - 0.2795	2.992	0.275	1.574	DC-0.1339	0.314	8	2	xxxx ¹⁾	
0.2796 - 0.2992	2.992	0.275	1.574	DC-0.1339	0.314	8	2	xxxx ¹⁾	
0.2993 - 0.3189	2.992	0.275	1.574	DC-0.1417	0.314	8	2	xxxx ¹⁾	
0.3189 - 0.3386	3.346	0.275	1.574	DC-0.1417	0.472	12	2	xxxx ¹⁾	
0.3386 - 0.3583	3.346	0.275	1.574	DC-0.1614	0.472	12	2	xxxx ¹⁾	
0.3583 - 0.3976	3.346	0.275	1.574	DC-0.1811	0.472	12	2	xxxx ¹⁾	
0.3780 - 0.3976	3.346	0.275	1.574	DC-0.1417	0.472	12	4		xxxx ¹⁾
0.3977 - 0.4567	3.740	0.275	1.968	DC-0.1969	0.472	12	2	xxxx ¹⁾	
0.3977 - 0.4567	3.740	0.275	1.968	DC-0.1496	0.472	12	4		xxxx ¹⁾
0.4567 - 0.5551	3.740	0.275	1.968	DC-0.2362	0.472	12	2	xxxx ¹⁾	
0.4567 - 0.5551	3.740	0.275	1.968	DC-0.1496	0.472	12	4		xxxx ¹⁾
0.5552 - 0.5945	3.858	0.275	1.968	DC-0.2598	0.629	16	2	xxxx ¹⁾	
0.5552 - 0.5945	3.858	0.275	1.968	DC-0.1535	0.629	16	4		xxxx ¹⁾
0.5945 - 0.6339	3.858	0.275	1.968	DC-0.2795	0.629	16	2	xxxx ¹⁾	
0.5945 - 0.6339	3.858	0.275	1.968	DC-0.1535	0.629	16	4		xxxx ¹⁾
0.6339 - 0.7126	4.251	0.275	2.362	DC-0.3150	0.629	16	2	xxxx ¹⁾	
0.6339 - 0.7126	4.251	0.275	2.362	DC-0.1811	0.629	16	4		xxxx ¹⁾
0.7126 - 0.7913	4.330	0.275	2.362	DC-0.3386	0.787	20	2	xxxx ¹⁾	
0.7126 - 0.7913	4.330	0.275	2.362	DC-0.1811	0.787	20	4		xxxx ¹⁾

P	
M	
K	
N	•
S	
H	
O	

1) Not available from stock, articles are non-returnable and cannot be exchanged / Minimum order 2 pieces

For xxxx please indicate piece part bore diameter and tolerance. (e.g. Ø .5000" ±.0005")

Material examples for cutting data tables

	Material sub-group	Index	Composition / Structure / Heat treatment	Tensile strength lbf/in ² / HB / HRC	Material number	Material designation	Material number	Material designation
P	Unalloyed steel	P.1.1	< 0.15 % C Annealed	60900 lbf/in ² / 125 HB	1.0401	1015	1.0301	1010
		P.1.2	< 0.45 % C Annealed	92800 lbf/in ² / 190 HB	1.1191	1045	1.0737	12L14
		P.1.3	< 0.45 % C Tempered	121800 lbf/in ² / 250 HB	1.1191	1045	1.0503	1043
		P.1.4	< 0.75 % C Annealed	132000 lbf/in ² / 270 HB	1.1223	1060	1.0535	1055
		P.1.5	< 0.75 % C Tempered	146500 lbf/in ² / 300 HB	1.1223	1060	1.1274	1095
	Low-alloy steel	P.2.1	Annealed	88500 lbf/in ² / 180 HB	1.7131	5115	1.6523	8620
		P.2.2	Tempered	134900 lbf/in ² / 275 HB	1.7131	5115	1.6582	4340
		P.2.3	Tempered	146500 lbf/in ² / 300 HB	1.7225	4142	1.7131	5115
		P.2.4	Tempered	174000 lbf/in ² / 375 HB	1.7225	4142	1.7223	4140
	High-alloy steel and high-alloy tool steel	P.3.1	Annealed	98600 lbf/in ² / 200 HB	1.4021	420	1.2379	D2
		P.3.2	Hardened and tempered	159500 lbf/in ² / 300 HB	1.2343	H11	1.3343	M2
		P.3.3	Hardened and tempered	188500 lbf/in ² / 400 HB	1.2343	H11	1.2363	A2
	Stainless steel	P.4.1	Ferritic / martensitic Annealed	98600 lbf/in ² / 200 HB	1.4016	430	1.4125	440C
		P.4.2	Martensitic Tempered	117500 lbf/in ² / 250 HB	1.4112	S44003	1.4021	420
M	Stainless steel	M.1.1	Austenitic / austenitic-ferritic Quenched	88500 lbf/in ² / 200 HB	1.4301	304	1.4401	316
		M.2.1	Austenitic Tempered	300 HB	1.4841	314	1.4568	17-7 PH
		M.3.1	Austenitic / ferritic (Duplex)	113100 lbf/in ² / 230 HB	1.4462	S32205	1.4410	S32750
K	Grey cast iron	K.1.1	Pearlitic / ferritic	88500 lbf/in ² / 180 HB	0.6010	A48-20B	0.6025	A48-40 B
		K.1.2	Pearlitic (martensitic)	127600 lbf/in ² / 260 HB	0.6030	A48-45B	0.6040	A48-60 B
	Spherulitic graphite cast iron	K.2.1	Ferritic	78300 lbf/in ² / 160 HB	0.7040	60-40-18	0.7050	65-45-12
		K.2.2	Pearlitic	122600 lbf/in ² / 250 HB	0.7070	100-70-03	0.7660	A439 Type D2
	Malleable iron	K.3.1	Ferritic	63800 lbf/in ² / 130 HB	0.8035	GTW-35-04		
		K.3.2	Pearlitic	113100 lbf/in ² / 230 HB	0.8170	70003		
N	Aluminium wrought alloy	N.1.1	Non-hardenable	60 HB	3.0255	A91060	3.0255	A91060
		N.1.2	Hardenable	49300 lbf/in ² / 100 HB	3.1355	2024	3.1355	2024
	Cast aluminium alloy	N.2.1	≤ 12 % Si, non-hardenable	36300 lbf/in ² / 75 HB	3.2581	A04130 / A413-0	3.2581	A04130 / A413-0
		N.2.2	≤ 12 % Si, hardenable	43500 lbf/in ² / 90 HB	3.2134	G-AISi5Cu1Mg		
		N.2.3	> 12 % Si, non-hardenable	63800 lbf/in ² / 130 HB		G-AISi17Cu4Mg		
	Copper and copper alloys (bronze/brass)	N.3.1	Free-machining alloys, PB > 1 %	54400 lbf/in ² / 110 HB	2.0380	CuZn39Pb2 (Ms58)	2.0380	C37700
		N.3.2	CuZn, CuSnZn	43500 lbf/in ² / 90 HB	2.0331	CuZn15	2.0331	C34000
		N.3.3	CuSn, lead-free copper and electrolytic copper	49300 lbf/in ² / 100 HB	2.0060	E-Cu57		
	Magnesium alloys	N.4.1	Magnesium and magnesium alloys	70 HB	3.5612	MgAl6Zn		
	S	Heat-resistant alloys	S.1.1	Fe - basis Annealed	98600 lbf/in ² / 200 HB	1.4864	X12NiCrSi 36-16	1.4864
S.1.2			Fe - basis	137800 lbf/in ² / 280 HB	1.4980	X6NiCrTiMoVB25-15-2	1.4980	S66286
S.2.1			Ni or Co basis Annealed	121800 lbf/in ² / 250 HB	2.4856	Inconel 625	2.4812	Hastelloy C
S.2.2			Ni or Co basis	171100 lbf/in ² / 350 HB	2.4952	Nimonic 80A	2.4668	Inconel 718
S.2.3			Ni or Co basis Cast	156600 lbf/in ² / 320 HB	2.4674	Nimocast PK24	2.4670	Nimocast 713
Titanium alloys		S.3.1	Pure titanium	5800 lbf/in ²	3.7025	Ti99,8		
		S.3.2	Alpha + beta alloys	152300 lbf/in ²	3.7165	TiAl6V4		
		S.3.3	Beta alloys	203100 lbf/in ² / 410 HB	Ti555.3	Ti-5Al-5V-5Mo-3Cr		
H	Hardened steel	H.1.1	Hardened and tempered	46-55 HRC				
		H.1.2	Hardened and tempered	56-60 HRC				
		H.1.3	Hardened and tempered	61-65 HRC				
		H.1.4	Hardened and tempered	66-70 HRC				
	Chilled iron	H.2.1	Cast	400 HB				
	Hardened cast iron	H.3.1	Hardened and tempered	55 HRC				
O	Non-metal materials	O.1.1	Plastics, duroplastic	≤ 21800 lbf/in ²				
		O.1.2	Plastics, thermoplastic	≤ 14500 lbf/in ²				
		O.2.1	Aramid fibre-reinforced	≤ 145000 lbf/in ²				
		O.2.2	Glass/carbon-fibre reinforced	≤ 145000 lbf/in ²				
		O.3.1	Graphite					

* Tensile Strength at Rupture (Rm)

Cutting data standard values for REAMAX TS

Index	Grade / coating		DBG-P				DBG-P					
	Article no. / type		49 586 ..., 49 585 ... / 75J.65, 75H.65 – ASG3000				49 521 ..., 49 571 ... / 75J.65, 75H.65 – ASG0106					
	Nominal Ø in inches		.7086–.8660	.8661–1.2519	1.2520–2.0471	2.0472–2.5590	.7086–.8660	.8661–1.2519	1.2520–2.0471	2.0472–2.5590		
	Reaming allowance Ø		.008 – .012	.008 – .012	.012 – .016	.012 – .016	.008 – .012	.008 – .012	.012 – .016	.012 – .016		
Number of flutes		6	6	8	10	6	6	8	10			
	v _c ft/min		f	f	f	f	v _c ft/min		f	f	f	f
	3xD	5xD	inch/rev.	inch/rev.	inch/rev.	inch/rev.	3xD	5xD	inch/rev.	inch/rev.	inch/rev.	inch/rev.
P.1.1	490 (430–660)	390 (330–520)	.031–.043	.039–.055	.051–.075	.075–.110						
P.1.2	490 (430–660)	390 (330–520)	.031–.043	.039–.055	.051–.075	.075–.110						
P.1.3	490 (430–660)	390 (330–520)	.031–.043	.039–.055	.051–.075	.075–.110						
P.1.4	490 (430–660)	390 (330–520)	.031–.043	.039–.055	.051–.075	.075–.110						
P.1.5	490 (430–660)	390 (330–520)	.031–.043	.039–.055	.051–.075	.075–.110						
P.2.1	490 (430–660)	390 (330–520)	.031–.043	.039–.055	.051–.075	.075–.110						
P.2.2	490 (430–660)	390 (330–520)	.031–.043	.039–.055	.051–.075	.075–.110						
P.2.3	490 (430–660)	390 (330–520)	.031–.043	.039–.055	.051–.075	.075–.110						
P.2.4	490 (430–660)	390 (330–520)	.031–.043	.039–.055	.051–.075	.075–.110						
P.3.1							100 (80–160)	100 (80–130)	.024–.035	.031–.043	.043–.059	.059–.091
P.3.2							100 (80–160)	100 (80–130)	.024–.035	.031–.043	.043–.059	.059–.091
P.3.3							100 (80–160)	100 (80–130)	.024–.035	.031–.043	.043–.059	.059–.091
P.4.1							150 (110–200)	130 (110–160)	.024–.035	.031–.043	.043–.059	.059–.091
P.4.2							150 (110–200)	130 (110–160)	.024–.035	.031–.043	.043–.059	.059–.091
M.1.1							150 (110–200)	130 (110–160)	.024–.035	.031–.043	.043–.059	.059–.091
M.2.1							150 (110–200)	130 (110–160)	.024–.035	.031–.043	.043–.059	.059–.091
M.3.1							100 (80–160)	100 (80–130)	.024–.035	.031–.043	.043–.059	.059–.091
K.1.1	490 (430–720)	390 (330–490)	.035–.051	.047–.067	.063–.091	.091–.134						
K.1.2	490 (430–720)	390 (330–490)	.035–.051	.047–.067	.063–.091	.091–.134						
K.2.1	570 (490–980)	490 (430–590)	.035–.051	.047–.067	.063–.091	.091–.134						
K.2.2	390 (330–590)	390 (330–490)	.031–.043	.039–.055	.051–.075	.075–.110						
K.3.1	390 (330–590)	390 (330–490)	.031–.043	.039–.055	.051–.075	.075–.110						
K.3.2	390 (330–590)	390 (330–490)	.031–.043	.039–.055	.051–.075	.075–.110						
N.1.1												
N.1.2												
N.2.1												
N.2.2												
N.2.3												
N.3.1												
N.3.2												
N.3.3												
N.4.1												
S.1.1												
S.1.2												
S.2.1												
S.2.2												
S.2.3												
S.3.1												
S.3.2												
S.3.3												
H.1.1												
H.1.2												
H.1.3												
H.1.4												
H.2.1												
H.3.1												
O.1.1												
O.1.2												
O.2.1												
O.2.2												
O.3.1												

3

 The cutting data depend extremely on the external conditions, the material and machine type. The indicated values are possible values which have to be increased or reduced, inside the bracket, according to the application conditions.

Cutting data standard values for REAMAX TS

Index	Grade / coating		TiN				TiN					
	Article no. / type		49 534 ..., 49 535 ... / 75J.71, 75H.71 – ASG3000				49 596 ... / 75J.71 – ASG4000					
	Nominal Ø in inches		.7086–.8660	.8661–1.2519	1.2520–2.0471	2.0472–2.5590	.7086–.8660	.8661–1.2519	1.2520–2.0471	2.0472–2.5590		
	Reaming allowance Ø		.008 – .012	.008 – .012	.012 – .016	.012 – .016	.008 – .012	.008 – .012	.012 – .016	.012 – .016		
Number of flutes		6	6	8	10	6	6	8	10			
Index	v _c ft/min		f	f	f	f	v _c ft/min	f	f	f	f	
	3xD	5xD	inch/rev.	inch/rev.	inch/rev.	inch/rev.		3xD	5xD	inch/rev.	inch/rev.	inch/rev.
P.1.1	330 (260–460)	260 (200–390)	.031–.004	.039–.055	.051–.075	.075–.110	330 (260–460)	260 (200–390)	.039–.051	.047–.067	.067–.091	.094–.134
P.1.2	330 (260–460)	260 (200–390)	.031–.004	.039–.055	.051–.075	.075–.110	330 (260–460)	260 (200–390)	.039–.051	.047–.067	.067–.091	.094–.134
P.1.3	330 (260–460)	260 (200–390)	.031–.004	.039–.055	.051–.075	.075–.110	330 (260–460)	260 (200–390)	.039–.051	.047–.067	.067–.091	.094–.134
P.1.4	330 (260–460)	260 (200–390)	.031–.004	.039–.055	.051–.075	.075–.110	330 (260–460)	260 (200–390)	.039–.051	.047–.067	.067–.091	.094–.134
P.1.5	330 (260–460)	260 (200–390)	.031–.004	.039–.055	.051–.075	.075–.110	330 (260–460)	260 (200–390)	.039–.051	.047–.067	.067–.091	.094–.134
P.2.1	330 (260–460)	260 (200–390)	.031–.004	.039–.055	.051–.075	.075–.110						
P.2.2	330 (260–460)	260 (200–390)	.031–.004	.039–.055	.051–.075	.075–.110						
P.2.3	330 (260–460)	260 (200–390)	.031–.004	.039–.055	.051–.075	.075–.110						
P.2.4	330 (260–460)	260 (200–390)	.031–.004	.039–.055	.051–.075	.075–.110						
P.3.1												
P.3.2												
P.3.3												
P.4.1												
P.4.2												
M.1.1												
M.2.1												
M.3.1												
K.1.1	260 (200–430)	260 (200–390)	.035–.051	.047–.067	.063–.091	.091–.134						
K.1.2	260 (200–430)	260 (200–390)	.035–.051	.047–.067	.063–.091	.091–.134						
K.2.1												
K.2.2												
K.3.1												
K.3.2												
N.1.1												
N.1.2												
N.2.1												
N.2.2												
N.2.3												
N.3.1	390 (330–660)	390 (330–660)	.035–.051	.043–.067	.059–.091	.091–.134						
N.3.2	260 (200–490)	260 (200–390)	.028–.043	.035–.055	.047–.075	.067–.102						
N.3.3	390 (330–660)	390 (330–490)	.028–.043	.035–.055	.047–.075	.067–.102						
N.4.1												
S.1.1												
S.1.2												
S.2.1												
S.2.2												
S.2.3												
S.3.1												
S.3.2												
S.3.3												
H.1.1												
H.1.2												
H.1.3												
H.1.4												
H.2.1												
H.3.1												
O.1.1												
O.1.2												
O.2.1												
O.2.2												
O.3.1												

 The cutting data depend extremely on the external conditions, the material and machine type. The indicated values are possible values which have to be increased or reduced, inside the bracket, according to the application conditions.

Cutting data standard values for REAMAX TS

Index	Grade / coating		TiN				DBC					
	Article no. / type		49 520 ..., 49 527 ... / 75J.71, 75H.71 – ASG0106				49 526 ..., 49 580 ... / 75J.17, 75H.17 – ASG0706					
	Nominal Ø in inches		.7086–.8660	.8661–1.2519	1.2520–2.0471	2.0472–2.5590	.7086–.8660	.8661–1.2519	1.2520–2.0471	2.0472–2.5590		
	Reaming allowance Ø		.008 – .012	.008 – .012	.012 – .016	.012 – .016	.008 – .012	.008 – .012	.012 – .016	.012 – .016		
	Number of flutes		6	6	8	10	6	6	8	10		
3xD	v _c ft/min		f inch/rev.	f inch/rev.	f inch/rev.	f inch/rev.	v _c ft/min		f inch/rev.	f inch/rev.	f inch/rev.	f inch/rev.
	5xD	3xD					5xD					
P.1.1												
P.1.2												
P.1.3												
P.1.4												
P.1.5												
P.2.1												
P.2.2												
P.2.3												
P.2.4												
P.3.1	70 (50–110)	70 (50–90)	.024–.035	.031–.043	.043–.059	.059–.091						
P.3.2	70 (50–110)	70 (50–90)	.024–.035	.031–.043	.043–.059	.059–.091						
P.3.3	70 (50–110)	70 (50–90)	.024–.035	.031–.043	.043–.059	.059–.091						
P.4.1	100 (70–130)	90 (70–110)	.024–.035	.031–.043	.043–.059	.059–.091						
P.4.2	100 (70–130)	90 (70–110)	.024–.035	.031–.043	.043–.059	.059–.091						
M.1.1	100 (70–130)	90 (70–110)	.024–.035	.031–.043	.043–.059	.059–.091						
M.2.1	100 (70–130)	90 (70–110)	.024–.035	.031–.043	.043–.059	.059–.091						
M.3.1	70 (50–110)	70 (50–90)	.024–.035	.031–.043	.043–.059	.059–.091						
K.1.1												
K.1.2												
K.2.1												
K.2.2												
K.3.1												
K.3.2												
N.1.1							490 (430–980)	490 (430–660)	.035–.051	.043–.067	.059–.091	.087–.134
N.1.2							490 (430–980)	490 (430–660)	.035–.051	.043–.067	.059–.091	.087–.134
N.2.1							660 (590–980)	490 (430–660)	.035–.051	.043–.067	.059–.091	.087–.134
N.2.2							660 (590–980)	490 (430–660)	.035–.051	.043–.067	.059–.091	.087–.134
N.2.3							660 (590–980)	490 (430–660)	.035–.051	.043–.067	.059–.091	.087–.134
N.3.1												
N.3.2												
N.3.3												
N.4.1							490 (430–980)	490 (430–660)	.035–.051	.043–.067	.059–.091	.087–.134
S.1.1												
S.1.2												
S.2.1												
S.2.2												
S.2.3												
S.3.1												
S.3.2												
S.3.3												
H.1.1												
H.1.2												
H.1.3												
H.1.4												
H.2.1												
H.3.1												
O.1.1												
O.1.2												
O.2.1												
O.2.2												
O.3.1							820 (720–890)	820 (720–890)	.035–.051	.043–.067	.059–.091	.087–.134

3

 The cutting data depend extremely on the external conditions, the material and machine type. The indicated values are possible values which have to be increased or reduced, inside the bracket, according to the application conditions.

Cutting data standard values for REAMAX TS

Index	Grade / coating		DST				DST					
	Article no. / type		49 544 ..., 40 539 ... / 75J.93, 75H.93 – ASG3000				49 597 ... / 75J.93 – ASG4000					
	Nominal Ø in inches		.7086–.8660	.8661–1.2519	1.2520–2.0471	2.0472–2.5590	.7086–.8660	.8661–1.2519	1.2520–2.0471	2.0472–2.5590		
	Reaming allowance Ø		.008 – .012	.008 – .012	.012 – .016	.012 – .016	.008 – .012	.008 – .012	.012 – .016	.012 – .016		
Number of flutes		6	6	8	10	6	6	8	10			
Index	v _c ft/min		f	f	f	f	v _c ft/min		f	f	f	f
	3xD	5xD	inch/rev.	inch/rev.	inch/rev.	inch/rev.	3xD	5xD	inch/rev.	inch/rev.	inch/rev.	inch/rev.
P.1.1	490 (430–660)	390 (330–520)	.031–.043	.039–.055	.051–.075	.075–.110	490 (430–660)	390 (330–520)	.039–.051	.047–.067	.067–.091	.094–.134
P.1.2	490 (430–660)	390 (330–520)	.031–.043	.039–.055	.051–.075	.075–.110	490 (430–660)	390 (330–520)	.039–.051	.047–.067	.067–.091	.094–.134
P.1.3	490 (430–660)	390 (330–520)	.031–.043	.039–.055	.051–.075	.075–.110	490 (430–660)	390 (330–520)	.039–.051	.047–.067	.067–.091	.094–.134
P.1.4	490 (430–660)	390 (330–520)	.031–.043	.039–.055	.051–.075	.075–.110	490 (430–660)	390 (330–520)	.039–.051	.047–.067	.067–.091	.094–.134
P.1.5	490 (430–660)	390 (330–520)	.031–.043	.039–.055	.051–.075	.075–.110	490 (430–660)	390 (330–520)	.039–.051	.047–.067	.067–.091	.094–.134
P.2.1	490 (430–660)	390 (330–520)	.031–.043	.039–.055	.051–.075	.075–.110	490 (430–660)	390 (330–520)	.039–.051	.047–.067	.067–.091	.094–.134
P.2.2	490 (430–660)	390 (330–520)	.031–.043	.039–.055	.051–.075	.075–.110	490 (430–660)	390 (330–520)	.039–.051	.047–.067	.067–.091	.094–.134
P.2.3	490 (430–660)	390 (330–520)	.031–.043	.039–.055	.051–.075	.075–.110	490 (430–660)	390 (330–520)	.039–.051	.047–.067	.067–.091	.094–.134
P.2.4	490 (430–660)	390 (330–520)	.031–.043	.039–.055	.051–.075	.075–.110	490 (430–660)	390 (330–520)	.039–.051	.047–.067	.067–.091	.094–.134
P.3.1												
P.3.2												
P.3.3												
P.4.1												
P.4.2												
M.1.1												
M.2.1												
M.3.1												
K.1.1												
K.1.2												
K.2.1	570 (490–980)	490 (430–590)	.035–.051	.047–.067	.063–.091	.091–.134	740 (660–980)	590 (520–790)	.047–.063	.059–.079	.079–.106	.114–.161
K.2.2	380 (330–490)	330 (260–390)	.031–.043	.039–.055	.051–.075	.075–.110	390 (330–490)	330 (260–390)	.047–.063	.059–.079	.079–.106	.114–.161
K.3.1	390 (330–590)	390 (330–490)	.031–.043	.039–.055	.051–.075	.075–.110						
K.3.2	390 (330–590)	390 (330–490)	.031–.043	.039–.055	.051–.075	.075–.110	390 (330–590)	390 (330–490)	.039–.051	.047–.067	.067–.091	.094–.134
N.1.1												
N.1.2												
N.2.1												
N.2.2												
N.2.3												
N.3.1	490 (430–1050)	490 (430–660)	.035–.051	.043–.067	.059–.091	.083–.122						
N.3.2	490 (430–1050)	490 (430–660)	.035–.051	.043–.067	.059–.091	.083–.122						
N.3.3												
N.4.1												
S.1.1												
S.1.2												
S.2.1												
S.2.2												
S.2.3												
S.3.1												
S.3.2												
S.3.3												
H.1.1												
H.1.2												
H.1.3												
H.1.4												
H.2.1												
H.3.1												
O.1.1												
O.1.2												
O.2.1												
O.2.2												
O.3.1												

 The cutting data depend extremely on the external conditions, the material and machine type. The indicated values are possible values which have to be increased or reduced, inside the bracket, according to the application conditions.

Cutting data standard values for REAMAX TS

Index	Grade / coating		DST				K10					
	Article no. / type		49 539 ... / 75H.93 – ASG3000				49 531 ..., 49 530 ... / 75J.21, 75H.21 – ASG03					
	Nominal Ø in inches		.7086–.8660	.8661–1.2519	1.2520–2.0471	2.0472–2.5590	.7086–.8660	.8661–1.2519	1.2520–2.0471	2.0472–2.5590		
	Reaming allowance Ø		.008 – .012	.008 – .012	.012 – .016	.012 – .016	.008 – .012	.008 – .012	.012 – .016	.012 – .016		
Number of flutes		6	6	8	10	6	6	8	10			
	v _c ft/min		f inch/rev.	f inch/rev.	f inch/rev.	f inch/rev.	v _c ft/min		f inch/rev.	f inch/rev.	f inch/rev.	f inch/rev.
	3xD	5xD					3xD	5xD				
P.1.1	490 (430–660)	390 (330–520)	.031–.043	.043–.055	.051–.075	.075–.110						
P.1.2	490 (430–660)	390 (330–520)	.031–.043	.043–.055	.051–.075	.075–.110						
P.1.3	490 (430–660)	390 (330–520)	.031–.043	.043–.055	.051–.075	.075–.110						
P.1.4	490 (430–660)	390 (330–520)	.031–.043	.043–.055	.051–.075	.075–.110						
P.1.5	490 (430–660)	390 (330–520)	.031–.043	.043–.055	.051–.075	.075–.110						
P.2.1	490 (430–660)	390 (330–520)	.031–.043	.043–.055	.051–.075	.075–.110						
P.2.2	490 (430–660)	390 (330–520)	.031–.043	.043–.055	.051–.075	.075–.110						
P.2.3	490 (430–660)	390 (330–520)	.031–.043	.043–.055	.051–.075	.075–.110						
P.2.4	490 (430–660)	390 (330–520)	.031–.043	.043–.055	.051–.075	.075–.110						
P.3.1												
P.3.2												
P.3.3												
P.4.1												
P.4.2												
M.1.1												
M.2.1												
M.3.1												
K.1.1												
K.1.2												
K.2.1	570 (490–980)	490 (430–590)	.035–.051	.047–.067	.063–.091	.091–.134						
K.2.2	390 (330–490)	330 (260–390)	.031–.043	.043–.055	.051–.075	.075–.110						
K.3.1	390 (330–590)	390 (330–490)	.031–.043	.043–.055	.051–.075	.075–.110						
K.3.2	390 (330–590)	390 (330–490)	.031–.043	.043–.055	.051–.075	.075–.110						
N.1.1												
N.1.2												
N.2.1												
N.2.2												
N.2.3												
N.3.1	490 (430–1050)	490 (330–660)	.035–.051	.043–.067	.059–.091	.083–.122						
N.3.2	490 (430–1050)	490 (330–660)	.035–.051	.043–.067	.059–.091	.083–.122						
N.3.3												
N.4.1												
S.1.1												
S.1.2												
S.2.1												
S.2.2												
S.2.3												
S.3.1							30 (20–40)	30 (20–40)	.024–.035	.031–.047	.043–.063	.063–.094
S.3.2							30 (20–40)	30 (20–40)	.024–.035	.031–.047	.043–.063	.063–.094
S.3.3							30 (20–40)	30 (20–40)	.024–.035	.031–.047	.043–.063	.063–.094
H.1.1												
H.1.2												
H.1.3												
H.1.4												
H.2.1												
H.3.1												
O.1.1												
O.1.2												
O.2.1												
O.2.2												
O.3.1												

3

 The cutting data depend extremely on the external conditions, the material and machine type. The indicated values are possible values which have to be increased or reduced, inside the bracket, according to the application conditions.

Cutting data standard values for Monomax

Index	Grade / coating		DBG-P				DBG-P					
	Article no. / type		49 657 ..., 49 665 ... / 56H.65, 56Q.65 – ASG3000				49 676 ..., 49 677 ... / 56J.65, 56R.65 – ASG3000					
	Nominal Ø in inches		.2205-.3503	.3504-.4727	.4728-.8664	.8665-1.0196	.2205-.3503	.3504-.4727	.4728-.8664	.8665-1.0196		
	Reaming allowance Ø		.004-.008	.004-.012	.008-.012	.008-.016	.004-.008	.004-.012	.008-.012	.008-.016		
Number of flutes		4	6	6	6	4	6	6	6			
	V _c ft/min		f	f	f	f	V _c ft/min		f	f	f	f
	3xD	5xD	inch/rev.	inch/rev.	inch/rev.	inch/rev.	3xD	5xD	inch/rev.	inch/rev.	inch/rev.	inch/rev.
P.1.1	490 (430-660)	390 (330-520)	.012-.020	.020-.028	.028-.039	0.90-1.30						
P.1.2	490 (430-660)	390 (330-520)	.012-.020	.020-.028	.028-.039	0.90-1.30						
P.1.3	490 (430-660)	390 (330-520)	.012-.020	.020-.028	.028-.039	0.90-1.30						
P.1.4	490 (430-660)	390 (330-520)	.012-.020	.020-.028	.028-.039	0.90-1.30						
P.1.5	490 (430-660)	390 (330-520)	.012-.020	.020-.028	.028-.039	0.90-1.30						
P.2.1	490 (430-660)	390 (330-520)	.012-.020	.020-.028	.028-.039	0.90-1.30						
P.2.2	490 (430-660)	390 (330-520)	.012-.020	.020-.028	.028-.039	0.90-1.30						
P.2.3	490 (430-660)	390 (330-520)	.012-.020	.020-.028	.028-.039	0.90-1.30						
P.2.4	200 (160-330)	390 (330-520)	.008-.012	.016-.020	.020-.028	0.60-0.90						
P.3.1												
P.3.2												
P.3.3												
P.4.1												
P.4.2												
M.1.1												
M.2.1												
M.3.1												
K.1.1	490 (430-720)	390 (330-490)	.016-.024	.028-.035	.035-.047	.043-.059	490 (430-720)	390 (330-490)	.016-.024	.028-.035	.035-.047	.043-.059
K.1.2	490 (430-720)	390 (330-490)	.016-.024	.028-.035	.035-.047	.043-.059	490 (430-720)	390 (330-490)	.016-.024	.028-.035	.035-.047	.043-.059
K.2.1	570 (490-980)	490 (430-590)	.016-.024	.028-.035	.035-.047	.043-.059	570 (490-980)	490 (430-590)	.016-.024	.028-.035	.035-.047	.043-.059
K.2.2	390 (330-590)	390 (330-490)	.012-.020	.020-.028	.028-.039	.035-.051	390 (330-590)	390 (330-490)	.012-.020	.020-.028	.028-.039	.035-.051
K.3.1	490 (430-820)	390 (330-520)	.016-.024	.028-.035	.035-.047	.043-.059	490 (430-820)	390 (330-520)	.016-.024	.028-.035	.035-.047	.043-.059
K.3.2	390 (330-590)	390 (330-490)	.012-.020	.020-.028	.028-.039	.035-.051	390 (330-590)	390 (330-490)	.012-.020	.020-.028	.028-.039	.035-.051
N.1.1												
N.1.2												
N.2.1												
N.2.2												
N.2.3												
N.3.1												
N.3.2												
N.3.3												
N.4.1												
S.1.1												
S.1.2												
S.2.1												
S.2.2												
S.2.3												
S.3.1												
S.3.2												
S.3.3												
H.1.1												
H.1.2												
H.1.3												
H.1.4												
H.2.1												
H.3.1												
O.1.1												
O.1.2												
O.2.1												
O.2.2												
O.3.1												

 The cutting data depend extremely on the external conditions, the material and machine type. The indicated values are possible values which have to be increased or reduced, inside the bracket, according to the application conditions.

Cutting data standard values for Monomax

Index	Grade / coating		DBG-P				TiN					
	Article no. / type		49 652 ..., 49 653... / 56J.65, 56R.65 – ASG0106				49 656, 49 661, 49 660, 49 664 / 56J.71, 56R.71, 56H.71, 56Q.71 – ASG0106					
	Nominal Ø in inches		.2205-.3503	.3504-.4727	.4728-.8664	.8665-1.0196	.2205-.3503	.3504-.4727	.4728-.8664	.8665-1.0196		
	Reaming allowance Ø		.004-.008	.004-.012	.008-.012	.008-.016	.004-.008	.004-.012	.008-.012	.008-.016		
Number of flutes		4	6	6	6	4	6	6	6			
Index	V _c ft/min		f	f	f	f	V _c ft/min		f	f	f	f
	3xD	5xD	inch/rev.	inch/rev.	inch/rev.	inch/rev.	3xD	5xD	inch/rev.	inch/rev.	inch/rev.	inch/rev.
P.1.1												
P.1.2												
P.1.3												
P.1.4												
P.1.5												
P.2.1												
P.2.2												
P.2.3												
P.2.4	200 (160-330)	200 (160-330)	.008-.012	.016-.020	.020-.028	.024-.035						
P.3.1	130 (110-200)	130 (110-200)	.008-.012	.016-.020	.020-.028	.024-.035	100 (80-160)	100 (80-130)	.012-.016	.016-.024	.024-.031	.028-.039
P.3.2	130 (110-200)	130 (110-200)	.008-.012	.016-.020	.020-.028	.024-.035	100 (80-160)	100 (80-130)	.012-.016	.016-.024	.024-.031	.028-.039
P.3.3	100 (80-160)	100 (80-130)	.012-.016	.016-.024	.024-.031	.028-.039	100 (80-160)	100 (80-130)	.012-.016	.016-.024	.024-.031	.028-.039
P.4.1	150 (110-200)	130 (110-160)	.012-.016	.016-.024	.024-.031	.028-.039	150 (110-200)	130 (110-160)	.012-.016	.016-.024	.024-.031	.028-.039
P.4.2	150 (110-200)	130 (110-160)	.012-.016	.016-.024	.024-.031	.028-.039	150 (110-200)	130 (110-160)	.012-.016	.016-.024	.024-.031	.028-.039
M.1.1	330 (260-520)	100 (80-130)	.012-.016	.016-.024	.024-.031	.028-.039	150 (110-200)	130 (110-160)	.012-.016	.016-.024	.024-.031	.028-.039
M.2.1	330 (260-520)	100 (80-130)	.012-.016	.016-.024	.024-.031	.028-.039	150 (110-200)	130 (110-160)	.012-.016	.016-.024	.024-.031	.028-.039
M.3.1	330 (260-520)	100 (80-130)	.012-.016	.016-.024	.024-.031	.028-.039	100 (80-160)	100 (80-130)	.012-.016	.016-.024	.024-.031	.028-.039
K.1.1												
K.1.2												
K.2.1												
K.2.2												
K.3.1												
K.3.2												
N.1.1												
N.1.2												
N.2.1												
N.2.2												
N.2.3												
N.3.1												
N.3.2												
N.3.3												
N.4.1												
S.1.1												
S.1.2												
S.2.1												
S.2.2												
S.2.3												
S.3.1												
S.3.2												
S.3.3												
H.1.1												
H.1.2												
H.1.3												
H.1.4												
H.2.1												
H.3.1												
O.1.1												
O.1.2												
O.2.1												
O.2.2												
O.3.1												

3

 The cutting data depend extremely on the external conditions, the material and machine type. The indicated values are possible values which have to be increased or reduced, inside the bracket, according to the application conditions.

Cutting data standard values for Monomax

Index	Grade / coating		TiN				v _c ft/min		TiN			
	Article no. / type		49 605, 49 606, 49 684, 49 685 / 56J.71, 56R.71, 56H.71, 56Q.71 – ASG3000				49 688 ..., 49 689 ... / 56J.71, 56R.71 – ASG4000		.2205-.3503 .3504-.4727 .4728-.8664 .8665-1.0196			
	Nominal Ø in inch		.2205-.3503	.3504-.4727	.4728-.8664	.8665-1.0196	.2205-.3503 .3504-.4727 .4728-.8664 .8665-1.0196					
	Reaming allowance Ø		.004-.008	.004-.012	.008-.012	.008-.016	.004-.008 .004-.012 .008-.012 .008-.016					
Number of flutes		4	6	6	6	4		6	6	6	6	
Index	v _c ft/min		f	f	f	f	v _c ft/min		f	f	f	f
	3xD	5xD	inch/rev.	inch/rev.	inch/rev.	inch/rev.	3xD	5xD	inch/rev.	inch/rev.	inch/rev.	inch/rev.
P.1.1	330 (260-460)	260 (200-390)	.012-.020	.020-.028	.028-.039	.035-.051	330 (260-460)	260 (200-390)	.016-.024	.028-.035	.035-.047	.047-.059
P.1.2	330 (260-460)	260 (200-390)	.012-.020	.020-.028	.028-.039	.035-.051	330 (260-460)	260 (200-390)	.016-.024	.028-.035	.035-.047	.047-.059
P.1.3	330 (260-460)	260 (200-390)	.012-.020	.020-.028	.028-.039	.035-.051	330 (260-460)	260 (200-390)	.016-.024	.028-.035	.035-.047	.047-.059
P.1.4	330 (260-460)	260 (200-390)	.012-.020	.020-.028	.028-.039	.035-.051	330 (260-460)	260 (200-390)	.016-.024	.028-.035	.035-.047	.047-.059
P.1.5	330 (260-460)	260 (200-390)	.012-.020	.020-.028	.028-.039	.035-.051	330 (260-460)	260 (200-390)	.016-.024	.028-.035	.035-.047	.047-.059
P.2.1	330 (260-460)	260 (200-390)	.012-.020	.020-.028	.028-.039	.035-.051						
P.2.2	330 (260-460)	260 (200-390)	.012-.020	.020-.028	.028-.039	.035-.051						
P.2.3	330 (260-460)	260 (200-390)	.012-.020	.020-.028	.028-.039	.035-.051						
P.2.4												
P.3.1												
P.3.2												
P.3.3												
P.4.1												
P.4.2												
M.1.1												
M.2.1												
M.3.1												
K.1.1	260 (200-430)	260 (200-390)	.016-.024	.028-.035	.035-.047	.043-.059						
K.1.2	260 (200-430)	260 (200-390)	.016-.024	.028-.035	.035-.047	.043-.059						
K.2.1												
K.2.2												
K.3.1												
K.3.2												
N.1.1												
N.1.2												
N.2.1												
N.2.2												
N.2.3												
N.3.1	390 (330-660)	390 (330-490)	.016-.024	.024-.035	.031-.047	.043-.059						
N.3.2	390 (330-660)	390 (330-490)	.016-.024	.024-.035	.031-.047	.043-.059						
N.3.3	260 (200-490)	260 (200-390)	.016-.024	.024-.035	.031-.047	.043-.059						
N.4.1												
S.1.1												
S.1.2												
S.2.1												
S.2.2												
S.2.3												
S.3.1												
S.3.2												
S.3.3												
H.1.1												
H.1.2												
H.1.3												
H.1.4												
H.2.1												
H.3.1												
O.1.1												
O.1.2												
O.2.1												
O.2.2												
O.3.1												

 The cutting data depend extremely on the external conditions, the material and machine type. The indicated values are possible values which have to be increased or reduced, inside the bracket, according to the application conditions.

Cutting data standard values for Monomax

Index	Grade / coating		TiN				DBC					
	Article no. / type		49 656, 49 661, 49 660, 49 664 / 56J.71, 56R.71, 56H.71, 56Q.71 – ASG0106				49 648, 49 649, 49 640, 49 641 / 56J.17, 56R.17, 56H.17, 56Q.17 – ASG0706					
	Nominal Ø in inches		.2205-.3503	.3504-.4727	.4728-.8664	.8665-1.0196	.2205-.3503	.3504-.4727	.4728-.8664	.8665-1.0196		
	Reaming allowance Ø		.004-.008	.004-.012	.008-.012	.008-.016	.004-.008	.004-.012	.008-.012	.008-.016		
	Number of flutes		4	6	6	6	4	6	6	6		
	V _c ft/min		f	f	f	f	V _c ft/min		f	f	f	f
	3xD	5xD	inch/rev.	inch/rev.	inch/rev.	inch/rev.	3xD	5xD	inch/rev.	inch/rev.	inch/rev.	inch/rev.
P.1.1												
P.1.2												
P.1.3												
P.1.4												
P.1.5												
P.2.1												
P.2.2												
P.2.3												
P.2.4												
P.3.1	100 (80-160)	100 (80-130)	.012-.016	.016-.024	.024-.031	.028-.039						
P.3.2	100 (80-160)	100 (80-130)	.012-.016	.016-.024	.024-.031	.028-.039						
P.3.3	100 (80-160)	100 (80-130)	.012-.016	.016-.024	.024-.031	.028-.039						
P.4.1	150 (110-200)	130 (110-160)	.012-.016	.016-.024	.024-.031	.028-.039						
P.4.2	150 (110-200)	130 (110-160)	.012-.016	.016-.024	.024-.031	.028-.039						
M.1.1	150 (110-200)	130 (110-160)	.012-.016	.016-.024	.024-.031	.028-.039						
M.2.1	150 (110-200)	130 (110-160)	.012-.016	.016-.024	.024-.031	.028-.039						
M.3.1	100 (80-160)	100 (80-130)	.012-.016	.016-.024	.024-.031	.028-.039						
K.1.1												
K.1.2												
K.2.1												
K.2.2												
K.3.1												
K.3.2												
N.1.1							490 (430-980)	490 (430-660)	.016-.024	.016-.024	.031-.047	.031-.059
N.1.2							490 (430-980)	490 (430-660)	.016-.024	.016-.024	.031-.047	.031-.059
N.2.1							660 (590-980)	490 (430-660)	.016-.024	.016-.024	.031-.047	.031-.059
N.2.2							660 (590-980)	490 (430-660)	.016-.024	.016-.024	.031-.047	.031-.059
N.2.3							660 (590-980)	490 (430-660)	.016-.024	.016-.024	.031-.047	.031-.059
N.3.1												
N.3.2												
N.3.3												
N.4.1												
S.1.1												
S.1.2												
S.2.1												
S.2.2												
S.2.3												
S.3.1												
S.3.2												
S.3.3												
H.1.1												
H.1.2												
H.1.3												
H.1.4												
H.2.1												
H.3.1												
O.1.1												
O.1.2												
O.2.1												
O.2.2												
O.3.1							820 (720-890)	820 (720-890)	.016-.024	.016-.024	.031-.047	.031-.059

3

 The cutting data depend extremely on the external conditions, the material and machine type. The indicated values are possible values which have to be increased or reduced, inside the bracket, according to the application conditions.

Cutting data standard values for Monomax

Index	Grade / coating		DST				Grade / coating		DST			
	Article no. / type		49 625, 49 626, 49 680, 49 681 / 56J.93, 56R.93, 56H.93, 56Q.93 - ASG3000				49 635 ..., 49 636 ... / 56J.93, 56R.93 - ASG4000		.2205-.3503 .3504-.4727 .4728-.8664 .8665-1.0196			
	Nominal Ø in inches		.2205-.3503	.3504-.4727	.4728-.8664	.8665-1.0196	.2205-.3503	.3504-.4727	.4728-.8664	.8665-1.0196		
	Reaming allowance Ø		.004-.008	.004-.012	.008-.012	.008-.016	.004-.008	.004-.012	.008-.012	.008-.016		
Index	Number of flutes		4	6	6	6	4	6	6	6		
	v _c ft/min		f		f		f		f			
	3xD	5xD	inch/rev.	inch/rev.	inch/rev.	inch/rev.	inch/rev.	inch/rev.	inch/rev.	inch/rev.		
P.1.1	490 (430-660)	390 (330-520)	.012-.020	.020-.028	.028-.039	.035-.051	490 (430-660)	390 (330-520)	.016-.024	.028-.035	.035-.047	.047-.059
P.1.2	490 (430-660)	390 (330-520)	.012-.020	.020-.028	.028-.039	.035-.051	490 (430-660)	390 (330-520)	.016-.024	.028-.035	.035-.047	.047-.059
P.1.3	490 (430-660)	390 (330-520)	.012-.020	.020-.028	.028-.039	.035-.051	490 (430-660)	390 (330-520)	.016-.024	.028-.035	.035-.047	.047-.059
P.1.4	490 (430-660)	390 (330-520)	.012-.020	.020-.028	.028-.039	.035-.051	490 (430-660)	390 (330-520)	.016-.024	.028-.035	.035-.047	.047-.059
P.1.5	490 (430-660)	390 (330-520)	.012-.020	.020-.028	.028-.039	.035-.051	490 (430-660)	390 (330-520)	.016-.024	.028-.035	.035-.047	.047-.059
P.2.1	490 (430-660)	390 (330-520)	.012-.020	.020-.028	.028-.039	.035-.051	490 (430-660)	390 (330-520)	.016-.024	.028-.035	.035-.047	.047-.059
P.2.2	490 (430-660)	390 (330-520)	.012-.020	.020-.028	.028-.039	.035-.051	490 (430-660)	390 (330-520)	.016-.024	.028-.035	.035-.047	.047-.059
P.2.3	490 (430-660)	390 (330-520)	.012-.020	.020-.028	.028-.039	.035-.051	490 (430-660)	390 (330-520)	.016-.024	.028-.035	.035-.047	.047-.059
P.2.4												
P.3.1												
P.3.2												
P.3.3												
P.4.1												
P.4.2												
M.1.1												
M.2.1												
M.3.1												
K.1.1												
K.1.2												
K.2.1	570 (490-980)	490 (430-590)	.016-.024	.028-.035	.035-.047	.043-.059	570 (490-980)	490 (430-590)	.016-.024	.028-.035	.035-.047	.043-.059
K.2.2	390 (330-490)	330 (260-390)	.012-.020	.020-.028	.028-.039	.035-.051	390 (330-490)	390 (330-490)	.012-.020	.020-.028	.028-.039	.035-.051
K.3.1	490 (430-820)	390 (330-660)	.016-.024	.028-.035	.035-.047	.043-.059	390 (330-590)	390 (330-490)	.012-.020	.020-.028	.028-.039	.035-.051
K.3.2	390 (330-590)	390 (330-490)	.012-.020	.020-.028	.028-.039	.035-.051	390 (330-590)	390 (330-490)	.012-.020	.020-.028	.028-.039	.035-.051
N.1.1												
N.1.2												
N.2.1												
N.2.2												
N.2.3												
N.3.1	490 (430-980)	490 (430-660)	.016-.024	.024-.035	.031-.047	.043-.059						
N.3.2	490 (430-980)	490 (430-660)	.016-.024	.024-.035	.031-.047	.043-.059						
N.3.3												
N.4.1												
S.1.1												
S.1.2												
S.2.1												
S.2.2												
S.2.3												
S.3.1												
S.3.2												
S.3.3												
H.1.1												
H.1.2												
H.1.3												
H.1.4												
H.2.1												
H.3.1												
O.1.1												
O.1.2												
O.2.1												
O.2.2												
O.3.1												

 The cutting data depend extremely on the external conditions, the material and machine type. The indicated values are possible values which have to be increased or reduced, inside the bracket, according to the application conditions.

Cutting data standard values for Monomax

Grade / coating		K10				
Article no. / type		49 672, 49 673, 49 668, 49 669 / 56J.21, 56Q.21, 56H.21, 56R.21 – ASG03				
Nominal Ø in inches		.2205 – .3503	.3504 – .4727	.4728 – .8664	.8665 – 1.0196	
Reaming allowance Ø		.004 – .008	.004 – .012	.008 – .012	.008 – .016	
Number of flutes		4	6	6	6	
Index	V _c ft/min		f	f	f	f
	3xD	5xD	inch/rev.	inch/rev.	inch/rev.	inch/rev.
P.1.1						
P.1.2						
P.1.3						
P.1.4						
P.1.5						
P.2.1						
P.2.2						
P.2.3						
P.2.4						
P.3.1						
P.3.2						
P.3.3						
P.4.1						
P.4.2						
M.1.1						
M.2.1						
M.3.1						
K.1.1						
K.1.2						
K.2.1						
K.2.2						
K.3.1						
K.3.2						
N.1.1						
N.1.2						
N.2.1						
N.2.2						
N.2.3						
N.3.1						
N.3.2						
N.3.3						
N.4.1						
S.1.1						
S.1.2						
S.2.1						
S.2.2						
S.2.3						
S.3.1	30 (20–40)	30 (20–40)	.012–.016	.016–.024	.024–.031	.031–.043
S.3.2	30 (20–40)	30 (20–40)	.012–.016	.016–.024	.024–.031	.031–.043
S.3.3	30 (20–40)	30 (20–40)	.012–.016	.016–.024	.024–.031	.031–.043
H.1.1						
H.1.2						
H.1.3						
H.1.4						
H.2.1						
H.3.1						
O.1.1						
O.1.2						
O.2.1						
O.2.2						
O.3.1						

 The cutting data depend extremely on the external conditions, the material and machine type. The indicated values are possible values which have to be increased or reduced, inside the bracket, according to the application conditions.

Cutting Data Standard Values for Cutting Ring

Index	Grade / coating		DBG-P			DBG-P					
	Article no. / type		49 836 ... / 300.65 - ASG3000			49 835 ... / 300.65 - ASG0106					
	Nominal Ø in inches		2.3858-3.1338	3.1339-3.9605	3.9606-4.3543	2.3858-3.1338	3.1339-3.9605	3.9606-4.3543			
	Reaming allowance Ø		.012 - .020	.012 - .020	.012 - .020	.012 - .020	.012 - .020	.012 - .020	.012 - .020		
Number of flutes		6	8	10	6	8	10				
Index	v _c ft/min		f inch/rev.	f inch/rev.	f inch/rev.	v _c ft/min		f inch/rev.	f inch/rev.	f inch/rev.	
	3xD	5xD				3xD	5xD				
P.1.1	490 (430-660)	390 (330-520)	.043-.067	.059-.091	.075-.110						
P.1.2	490 (430-660)	390 (330-520)	.043-.067	.059-.091	.075-.110						
P.1.3	490 (430-660)	390 (330-520)	.043-.067	.059-.091	.075-.110						
P.1.4	490 (430-660)	390 (330-520)	.043-.067	.059-.091	.075-.110						
P.1.5	490 (430-660)	390 (330-520)	.043-.067	.059-.091	.075-.110						
P.2.1	490 (430-660)	390 (330-520)	.043-.067	.059-.091	.075-.110						
P.2.2	490 (430-660)	390 (330-520)	.043-.067	.059-.091	.075-.110						
P.2.3	490 (430-660)	390 (330-520)	.043-.067	.059-.091	.075-.110						
P.2.4	490 (430-660)	390 (330-520)	.043-.067	.059-.091	.075-.110						
P.3.1						100 (80-160)	100 (80-130)	.035-.051	.047-.071	.059-.091	
P.3.2						100 (80-160)	100 (80-130)	.035-.051	.047-.071	.059-.091	
P.3.3						100 (80-160)	100 (80-130)	.035-.051	.047-.071	.059-.091	
P.4.1						150 (110-200)	130 (110-160)	.035-.051	.047-.071	.059-.091	
P.4.2						150 (110-200)	130 (110-160)	.035-.051	.047-.071	.059-.091	
M.1.1						150 (110-200)	130 (110-160)	.035-.051	.047-.071	.059-.091	
M.2.1						150 (110-200)	130 (110-160)	.035-.051	.047-.071	.059-.091	
M.3.1						100 (80-160)	100 (80-130)	.035-.051	.047-.071	.059-.091	
K.1.1	490 (430-720)	390 (330-490)	.085-.080	.073-.107	.091-.134						
K.1.2	490 (430-720)	390 (330-490)	.085-.080	.073-.107	.091-.134						
K.2.1	570 (490-980)	490 (430-590)	.085-.080	.073-.107	.091-.134						
K.2.2	390 (330-590)	390 (330-490)	.045-.066	.060-.088	.075-.110						
K.3.1	390 (330-590)	390 (330-490)	.045-.066	.060-.088	.075-.110						
K.3.2	390 (330-590)	390 (330-490)	.045-.066	.060-.088	.075-.110						
N.1.1											
N.1.2											
N.2.1											
N.2.2											
N.2.3											
N.3.1											
N.3.2											
N.3.3											
N.4.1											
S.1.1											
S.1.2											
S.2.1											
S.2.2											
S.2.3											
S.3.1											
S.3.2											
S.3.3											
H.1.1											
H.1.2											
H.1.3											
H.1.4											
H.2.1											
H.3.1											
O.1.1											
O.1.2											
O.2.1											
O.2.2											
O.3.1											

 The cutting data depend extremely on the external conditions, the material and machine type. The indicated values are possible values which have to be increased or reduced, inside the bracket, according to the application conditions.

Cutting Data Standard Values for Cutting Ring

Index	Grade / coating		TiN			TiN				
	Article no. / type		49 823 ... / 300.05 - ASG3000			49 824 ... / 300.05 - ASG0106				
	Nominal Ø in inches		2.3858-3.1338	3.1339-3.9605	3.9606-4.3543	2.3858-3.1338	3.1339-3.9605	3.9606-4.3543		
	Reaming allowance Ø		.012 - .020	.012 - .020	.012 - .020	.012 - .020	.012 - .020	.012 - .020		
	Number of flutes		6	8	10	6	8	10		
Index	V _c ft/min		f inch/rev.	f inch/rev.	f inch/rev.	V _c ft/min		f inch/rev.	f inch/rev.	f inch/rev.
	3xD	5xD				3xD	5xD			
P.1.1	330 (260-460)	260 (200-390)	.043-.067	.059-.091	.075-.110					
P.1.2	330 (260-460)	260 (200-390)	.043-.067	.059-.091	.075-.110					
P.1.3	330 (260-460)	260 (200-390)	.043-.067	.059-.091	.075-.110					
P.1.4	330 (260-460)	260 (200-390)	.043-.067	.059-.091	.075-.110					
P.1.5	330 (260-460)	260 (200-390)	.043-.067	.059-.091	.075-.110					
P.2.1	330 (260-460)	260 (200-390)	.043-.067	.059-.091	.075-.110					
P.2.2	330 (260-460)	260 (200-390)	.043-.067	.059-.091	.075-.110					
P.2.3	330 (260-460)	260 (200-390)	.043-.067	.059-.091	.075-.110					
P.2.4	330 (260-460)	260 (200-390)	.043-.067	.059-.091	.075-.110					
P.3.1						100 (80-150)	100 (80-150)	.031-.047	.043-.063	.051-.079
P.3.2						100 (80-150)	100 (80-150)	.031-.047	.043-.063	.051-.079
P.3.3										
P.4.1						100 (80-150)	100 (80-150)	.031-.047	.043-.063	.051-.079
P.4.2						100 (80-150)	100 (80-150)	.031-.047	.043-.063	.051-.079
M.1.1						100 (80-150)	100 (80-130)	.035-.051	.047-.071	.059-.091
M.2.1						70 (50-110)	70 (50-110)	.035-.051	.047-.071	.059-.091
M.3.1						70 (50-110)	70 (50-110)	.035-.051	.047-.071	.059-.091
K.1.1	260 (200-430)	260 (200-390)	.055-.079	.075-.079	.091-.134					
K.1.2	260 (200-430)	260 (200-390)	.055-.079	.075-.079	.091-.134					
K.2.1										
K.2.2										
K.3.1										
K.3.2										
N.1.1										
N.1.2										
N.2.1										
N.2.2										
N.2.3										
N.3.1	390 (330-660)	390 (330-660)	.047-.075	.067-.098	.083-.122					
N.3.2	390 (330-660)	390 (330-660)	.039-.059	.055-.083	.067-.102					
N.3.3	260 (200-490)	260 (200-390)	.039-.059	.055-.083	.067-.102					
N.4.1										
S.1.1										
S.1.2										
S.2.1										
S.2.2										
S.2.3										
S.3.1										
S.3.2										
S.3.3										
H.1.1										
H.1.2										
H.1.3										
H.1.4										
H.2.1										
H.3.1										
O.1.1										
O.1.2										
O.2.1										
O.2.2										
O.3.1										

3

 The cutting data depend extremely on the external conditions, the material and machine type. The indicated values are possible values which have to be increased or reduced, inside the bracket, according to the application conditions.

Cutting Data Standard Values for Cutting Ring

Index	Grade / coating		TiN			DBC					
	Article no. / type		49 831 ... / 300.05 - ASG4000			49 839 ... / 300.17 - ASG0706					
	Nominal Ø in inches		2.3858-3.1338	3.1339-3.9605	3.9606-4.3543	2.3858-3.1338	3.1339-3.9605	3.9606-4.3543			
	Reaming allowance Ø		.012 - .020	.012 - .020	.012 - .020	.012 - .020	.012 - .020	.012 - .020	.012 - .020		
	Number of flutes		6	8	10	6	8	10			
	V _c ft/min		f inch/rev.	f inch/rev.	f inch/rev.	V _c ft/min		f inch/rev.	f inch/rev.	f inch/rev.	
	3xD	5xD				3xD	5xD				
P.1.1	330 (260-460)	260 (200-390)	.055-.079	.012-.020	.012-.020						
P.1.2	330 (260-460)	260 (200-390)	.055-.079	.012-.020	.012-.020						
P.1.3	330 (260-460)	260 (200-390)	.055-.079	.012-.020	.012-.020						
P.1.4	330 (260-460)	260 (200-390)	.055-.079	.012-.020	.012-.020						
P.1.5	330 (260-460)	260 (200-390)	.055-.079	.012-.020	.012-.020						
P.2.1											
P.2.2											
P.2.3											
P.2.4											
P.3.1											
P.3.2											
P.3.3											
P.4.1											
P.4.2											
M.1.1											
M.2.1											
M.3.1											
K.1.1											
K.1.2											
K.2.1											
K.2.2											
K.3.1											
K.3.2											
N.1.1						490 (430-980)	490 (430-660)	.052-.080	.070-.107	.087-.134	
N.1.2						490 (430-980)	490 (430-660)	.052-.080	.070-.107	.087-.134	
N.2.1						660 (590-980)	490 (430-660)	.052-.080	.070-.107	.087-.134	
N.2.2						660 (590-980)	490 (430-660)	.052-.080	.070-.107	.087-.134	
N.2.3						660 (590-980)	490 (430-660)	.052-.080	.070-.107	.087-.134	
N.3.1	390 (330-660)	390 (330-660)	.047-.075	.067-.098	.083-.122						
N.3.2	390 (330-660)	390 (330-660)	.039-.059	.055-.083	.067-.102						
N.3.3	260 (200-490)	260 (200-390)	.039-.059	.055-.083	.067-.102						
N.4.1						490 (430-980)	490 (430-660)	.052-.080	.070-.107	.087-.134	
S.1.1											
S.1.2											
S.2.1											
S.2.2											
S.2.3											
S.3.1											
S.3.2											
S.3.3											
H.1.1											
H.1.2											
H.1.3											
H.1.4											
H.2.1											
H.3.1											
O.1.1											
O.1.2											
O.2.1											
O.2.2											
O.3.1											

 The cutting data depend extremely on the external conditions, the material and machine type. The indicated values are possible values which have to be increased or reduced, inside the bracket, according to the application conditions.

Cutting Data Standard Values for Cutting Ring

Index	Grade / coating		DST			Grade / coating		DST			
	Article no. / type		49 827 ... / 300.45 - ASG3000			49 828 ... / 300.45 - ASG4000		49 828 ... / 300.45 - ASG4000			
	Nominal Ø in inches		2.3858-3.1338	3.1339-3.9605	3.9606-4.3543	2.3858-3.1338	3.1339-3.9605	3.9606-4.3543	2.3858-3.1338	3.1339-3.9605	3.9606-4.3543
	Reaming allowance Ø		.012 - .020	.012 - .020	.012 - .020	.012 - .020	.012 - .020	.012 - .020	.012 - .020	.012 - .020	.012 - .020
	Number of flutes		6	8	10	6	8	10	6	8	10
Index	V _c ft/min		f inch/rev.	f inch/rev.	f inch/rev.	V _c ft/min		f inch/rev.	f inch/rev.	f inch/rev.	
	3xD	5xD				3xD	5xD				
P.1.1	490 (390-660)	390 (330-520)	.043-.067	.059-.091	.075-.110	490 (390-660)	390 (330-520)	.055-.079	.075-.106	.094-.134	
P.1.2	490 (390-660)	390 (330-520)	.043-.067	.059-.091	.075-.110	490 (390-660)	390 (330-520)	.055-.079	.075-.106	.094-.134	
P.1.3	490 (390-660)	390 (330-520)	.043-.067	.059-.091	.075-.110	490 (390-660)	390 (330-520)	.055-.079	.075-.106	.094-.134	
P.1.4	490 (390-660)	390 (330-520)	.043-.067	.059-.091	.075-.110	490 (390-660)	390 (330-520)	.055-.079	.075-.106	.094-.134	
P.1.5	490 (390-660)	390 (330-520)	.043-.067	.059-.091	.075-.110	490 (390-660)	390 (330-520)	.055-.079	.075-.106	.094-.134	
P.2.1	490 (390-660)	390 (330-520)	.043-.067	.059-.091	.075-.110	490 (390-660)	390 (330-520)	.055-.079	.075-.106	.094-.134	
P.2.2	490 (390-660)	390 (330-520)	.043-.067	.059-.091	.075-.110	490 (390-660)	390 (330-520)	.055-.079	.075-.106	.094-.134	
P.2.3	490 (390-660)	390 (330-520)	.043-.067	.059-.091	.075-.110	490 (390-660)	390 (330-520)	.055-.079	.075-.106	.094-.134	
P.2.4											
P.3.1											
P.3.2											
P.3.3											
P.4.1											
P.4.2											
M.1.1											
M.2.1											
M.3.1											
K.1.1											
K.1.2											
K.2.1	570 (390-980)	490 (390-590)	.055-.079	.075-.106	.091-.134						
K.2.2	490 (390-820)	390 (260-490)	.043-.067	.059-.091	.075-.110						
K.3.1	390 (330-590)	390 (260-490)	.055-.079	.075-.106	.091-.134						
K.3.2	390 (330-590)	390 (260-490)	.043-.067	.059-.091	.075-.110						
N.1.1											
N.1.2											
N.2.1											
N.2.2											
N.2.3											
N.3.1	490 (390-1050)	490 (390-660)	.047-.075	.067-.098	.083-.122						
N.3.2											
N.3.3											
N.4.1											
S.1.1											
S.1.2											
S.2.1											
S.2.2											
S.2.3											
S.3.1											
S.3.2											
S.3.3											
H.1.1											
H.1.2											
H.1.3											
H.1.4											
H.2.1											
H.3.1											
O.1.1											
O.1.2											
O.2.1											
O.2.2											
O.3.1											

3

 The cutting data depend extremely on the external conditions, the material and machine type. The indicated values are possible values which have to be increased or reduced, inside the bracket, according to the application conditions.

Cutting Data Standard Values for Cutting Ring

		K10			
		49 832 ... / 300.25 - ASG03			
		2.3858-3.1338	3.1339-3.9605	3.9606-4.3543	
		.012 - .020	.012 - .020	.012 - .020	
		6	8	10	
Index	v_c ft/min		f	f	f
	3xD	5xD	inch/rev.	inch/rev.	inch/rev.
P.1.1					
P.1.2					
P.1.3					
P.1.4					
P.1.5					
P.2.1					
P.2.2					
P.2.3					
P.2.4					
P.3.1					
P.3.2					
P.3.3					
P.4.1					
P.4.2					
M.1.1					
M.2.1					
M.3.1					
K.1.1					
K.1.2					
K.2.1					
K.2.2					
K.3.1					
K.3.2					
N.1.1					
N.1.2					
N.2.1					
N.2.2					
N.2.3					
N.3.1					
N.3.2					
N.3.3					
N.4.1					
S.1.1					
S.1.2					
S.2.1					
S.2.2					
S.2.3					
S.3.1	30 (20-40)	30 (20-40)	.031-.043	.041-.057	.052-.072
S.3.2	30 (20-40)	30 (20-40)	.031-.043	.041-.057	.052-.072
S.3.3	30 (20-40)	30 (20-40)	.031-.043	.041-.057	.052-.072
H.1.1					
H.1.2					
H.1.3					
H.1.4					
H.2.1					
H.3.1					
O.1.1					
O.1.2					
O.2.1					
O.2.2					
O.3.1					



The cutting data depend extremely on the external conditions, the material and machine type. The indicated values are possible values which have to be increased or reduced, inside the bracket, according to the application conditions.

Cutting Data Standard Values for Rapid Set Head

Index	Grade / coating		DBG-P			DBG-P				
	Article no. / type		49 816 ... / 340.65 - ASG0106			49 817 ... / 340.65 - ASG3000				
	Nominal Ø in inches		.3779 - .6138	.6139 - 1.1850	1.1851 - 2.3622	.3779 - .6138	.6139 - 1.1850	1.1851 - 2.3622		
	Reaming allowance Ø		.004 - .012	.008 - .016	.008 - .016	.004 - .012	.008 - .016	.008 - .016		
	Number of flutes		4	6	6	4	6	6		
	V_c ft/min		f inch/rev.	f inch/rev.	f inch/rev.	V_c ft/min		f inch/rev.	f inch/rev.	f inch/rev.
	3xD	5xD				3xD	5xD			
P.1.1						490 (430-660)	390 (330-520)	.012-.020	.035-.051	.043-.059
P.1.2						490 (430-660)	390 (330-520)	.012-.020	.035-.051	.043-.059
P.1.3						490 (430-660)	390 (330-520)	.012-.020	.035-.051	.043-.059
P.1.4						490 (430-660)	390 (330-520)	.012-.020	.035-.051	.043-.059
P.1.5						490 (430-660)	390 (330-520)	.012-.020	.035-.051	.043-.059
P.2.1						490 (430-660)	390 (330-520)	.012-.020	.035-.051	.043-.059
P.2.2						490 (430-660)	390 (330-520)	.012-.020	.035-.051	.043-.059
P.2.3						490 (430-660)	390 (330-520)	.012-.020	.035-.051	.043-.059
P.2.4						490 (430-660)	390 (330-520)	.012-.020	.035-.051	.043-.059
P.3.1	100 (80-160)	100 (80-130)	.012-.016	.028-.039	.035-.047					
P.3.2	100 (80-160)	100 (80-130)	.012-.016	.028-.039	.035-.047					
P.3.3	100 (80-160)	100 (80-130)	.012-.016	.028-.039	.035-.047					
P.4.1	150 (110-200)	130 (110-160)	.012-.016	.028-.039	.035-.047					
P.4.2	150 (110-200)	130 (110-160)	.012-.016	.028-.039	.035-.047					
M.1.1	150 (110-200)	130 (110-160)	.012-.016	.028-.039	.035-.047					
M.2.1	150 (110-200)	130 (110-160)	.012-.016	.028-.039	.035-.047					
M.3.1	100 (80-160)	100 (80-130)	.012-.016	.028-.039	.035-.047					
K.1.1						490 (430-720)	390 (330-490)	.016-.024	.043-.059	.051-.075
K.1.2						490 (430-720)	390 (330-490)	.016-.024	.043-.059	.051-.075
K.2.1						570 (490-980)	490 (430-590)	.016-.024	.043-.059	.051-.075
K.2.2						390 (330-590)	390 (330-490)	.012-.020	.035-.051	.043-.059
K.3.1						390 (330-590)	390 (330-490)	.012-.020	.035-.051	.043-.059
K.3.2						390 (330-590)	390 (330-490)	.012-.020	.035-.051	.043-.059
N.1.1										
N.1.2										
N.2.1										
N.2.2										
N.2.3										
N.3.1										
N.3.2										
N.3.3										
N.4.1										
S.1.1										
S.1.2										
S.2.1										
S.2.2										
S.2.3										
S.3.1										
S.3.2										
S.3.3										
H.1.1										
H.1.2										
H.1.3										
H.1.4										
H.2.1										
H.3.1										
O.1.1										
O.1.2										
O.2.1										
O.2.2										
O.3.1										

3

 The cutting data depend extremely on the external conditions, the material and machine type. The indicated values are possible values which have to be increased or reduced, inside the bracket, according to the application conditions.

Cutting Data Standard Values for Rapid Set Head

Index	Grade / coating		DST			Grade / coating		DST		
	Article no. / type		49 812 ... / 340.92 - ASG05			Article no. / type		49 813 ... / 340.93 - ASG3000		
	Nominal Ø in inches		.3779 - .6138	.6139 - 1.1850	1.1851 - 2.3622	Nominal Ø in inches		.3779 - .6138	.6139 - 1.1850	1.1851 - 2.3622
	Reaming allowance Ø		.004 - .012	.008 - .016	.008 - .016	Reaming allowance Ø		.004 - .012	.008 - .016	.008 - .016
	Number of flutes		4	6	6	Number of flutes		4	6	6
Index	V _c ft/min		f inch/rev.	f inch/rev.	f inch/rev.	V _c ft/min		f inch/rev.	f inch/rev.	f inch/rev.
	3xD	5xD				3xD	5xD			
P.1.1	490 (390-660)	490 (390-520)	.024-.031	.047-.059	.055-.075	490 (390-660)	490 (390-520)	.012-.020	.035-.051	.043-.059
P.1.2	490 (390-660)	490 (390-520)	.024-.031	.047-.059	.055-.075	490 (390-660)	490 (390-520)	.012-.020	.035-.051	.043-.059
P.1.3	490 (390-660)	490 (390-520)	.024-.031	.047-.059	.055-.075	490 (390-660)	490 (390-520)	.012-.020	.035-.051	.043-.059
P.1.4	490 (390-660)	490 (390-520)	.024-.031	.047-.059	.055-.075	490 (390-660)	490 (390-520)	.012-.020	.035-.051	.043-.059
P.1.5	490 (390-660)	490 (390-520)	.024-.031	.047-.059	.055-.075	490 (390-660)	490 (390-520)	.012-.020	.035-.051	.043-.059
P.2.1	490 (390-660)	490 (390-520)	.024-.031	.047-.059	.055-.075	490 (390-660)	490 (390-520)	.012-.020	.035-.051	.043-.059
P.2.2	490 (390-660)	490 (390-520)	.024-.031	.047-.059	.055-.075	490 (390-660)	490 (390-520)	.012-.020	.035-.051	.043-.059
P.2.3	490 (390-660)	490 (390-520)	.024-.031	.047-.059	.055-.075	490 (390-660)	490 (390-520)	.012-.020	.035-.051	.043-.059
P.2.4										
P.3.1										
P.3.2										
P.3.3										
P.4.1										
P.4.2										
M.1.1										
M.2.1										
M.3.1										
K.1.1										
K.1.2										
K.2.1						570 (490-980)	570 (490-980)	.016-.024	.043-.024	.051-.075
K.2.2						490 (390-820)	490 (390-820)	.016-.024	.043-.024	.051-.075
K.3.1						390 (330-590)	390 (330-590)	.016-.024	.043-.024	.051-.075
K.3.2						390 (330-590)	390 (330-590)	.016-.024	.043-.024	.051-.075
N.1.1										
N.1.2										
N.2.1										
N.2.2										
N.2.3										
N.3.1						490 (390-1050)	490 (390-1050)	.016-.024	.043-.059	.047-.067
N.3.2										
N.3.3										
N.4.1										
S.1.1										
S.1.2										
S.2.1										
S.2.2										
S.2.3										
S.3.1										
S.3.2										
S.3.3										
H.1.1										
H.1.2										
H.1.3										
H.1.4										
H.2.1										
H.3.1										
O.1.1										
O.1.2										
O.2.1										
O.2.2										
O.3.1										

 The cutting data depend extremely on the external conditions, the material and machine type. The indicated values are possible values which have to be increased or reduced, inside the bracket, according to the application conditions.

Cutting Data Standard Values for Rapid Set Head

Index	Grade / coating		TiN			TiN				
	Article no. / type		49 805 ... / 340.70 - ASG05			49 808 ... / 340.71 - ASG3000				
	Nominal Ø in inches		.3779 - .6138	.6139 - 1.1850	1.1851 - 2.3622	.3779 - .6138	.6139 - 1.1850	1.1851 - 2.3622		
	Reaming allowance Ø		.004 - .012	.008 - .016	.008 - .016	.004 - .012	.008 - .016	.008 - .016		
	Number of flutes		4	6	6	4	6	6		
Index	V _c ft/min		f inch/rev.	f inch/rev.	f inch/rev.	V _c ft/min		f inch/rev.	f inch/rev.	f inch/rev.
	3xD	5xD				3xD	5xD			
P.1.1	330 (260-460)	260 (200-390)	.024-.031	.047-.059	.055-.075	330 (260-460)	260 (200-390)	.012-.020	.035-.051	.043-.059
P.1.2	330 (260-460)	260 (200-390)	.024-.031	.047-.059	.055-.075	330 (260-460)	260 (200-390)	.012-.020	.035-.051	.043-.059
P.1.3	330 (260-460)	260 (200-390)	.024-.031	.047-.059	.055-.075	330 (260-460)	260 (200-390)	.012-.020	.035-.051	.043-.059
P.1.4	330 (260-460)	260 (200-390)	.024-.031	.047-.059	.055-.075	330 (260-460)	260 (200-390)	.012-.020	.035-.051	.043-.059
P.1.5	330 (260-460)	260 (200-390)	.024-.031	.047-.059	.055-.075	330 (260-460)	260 (200-390)	.012-.020	.035-.051	.043-.059
P.2.1	330 (260-460)	260 (200-390)	.024-.031	.047-.059	.055-.075	330 (260-460)	260 (200-390)	.012-.020	.035-.051	.043-.059
P.2.2	330 (260-460)	260 (200-390)	.024-.031	.047-.059	.055-.075	330 (260-460)	260 (200-390)	.012-.020	.035-.051	.043-.059
P.2.3	330 (260-460)	260 (200-390)	.024-.031	.047-.059	.055-.075	330 (260-460)	260 (200-390)	.012-.020	.035-.051	.043-.059
P.2.4	330 (260-460)	260 (200-390)	.024-.031	.047-.059	.055-.075	330 (260-460)	260 (200-390)	.012-.020	.035-.051	.043-.059
P.3.1										
P.3.2										
P.3.3										
P.4.1										
P.4.2										
M.1.1										
M.2.1										
M.3.1										
K.1.1						260 (200-430)	260 (200-390)	.016-.024	.043-.059	.051-.075
K.1.2						260 (200-430)	260 (200-390)	.016-.024	.043-.059	.051-.075
K.2.1										
K.2.2										
K.3.1										
K.3.2										
N.1.1										
N.1.2										
N.2.1										
N.2.2										
N.2.3										
N.3.1						390 (330-660)	390 (330-660)	.016-.024	.043-.059	.047-.067
N.3.2						260 (200-490)	260 (200-490)	.012-.020	.035-.051	.039-.055
N.3.3						260 (200-490)	260 (200-490)	.012-.020	.035-.051	.039-.055
N.4.1										
S.1.1										
S.1.2										
S.2.1										
S.2.2										
S.2.3										
S.3.1										
S.3.2										
S.3.3										
H.1.1										
H.1.2										
H.1.3										
H.1.4										
H.2.1										
H.3.1										
O.1.1										
O.1.2										
O.2.1										
O.2.2										
O.3.1										

3

 The cutting data depend extremely on the external conditions, the material and machine type. The indicated values are possible values which have to be increased or reduced, inside the bracket, according to the application conditions.

Cutting Data Standard Values for Rapid Set Head

Index	Grade / coating		TiN			K10					
	Article no. / type		49 809 ... / 340.71 – ASG0106			49 800 ... / 340.21 – ASG03					
	Nominal Ø in inches		.3779 – .6138	.6139 – 1.1850	1.1851 – 2.3622	.3779 – .6138	.6139 – 1.1850	1.1851 – 2.3622			
	Reaming allowance Ø		.004 – .012	.008 – .016	.008 – .016	.004 – .012	.008 – .016	.008 – .016			
	Number of flutes		4	6	6	4	6	6			
3xD	V _c ft/min		f inch/rev.	f inch/rev.	f inch/rev.	3xD	V _c ft/min		f inch/rev.	f inch/rev.	f inch/rev.
	5xD						5xD				
P.1.1											
P.1.2											
P.1.3											
P.1.4											
P.1.5											
P.2.1											
P.2.2											
P.2.3											
P.2.4											
P.3.1	100 (70–130)	100 (70–130)	.012–.016	.028–.039	.035–.047						
P.3.2	100 (70–130)	100 (70–130)	.012–.016	.028–.039	.035–.047						
P.3.3	100 (70–130)	100 (70–130)	.012–.016	.028–.039	.035–.047						
P.4.1	100 (70–130)	100 (70–130)	.012–.016	.028–.039	.035–.047						
P.4.2	100 (70–130)	100 (70–130)	.012–.016	.028–.039	.035–.047						
M.1.1	100 (70–130)	100 (70–130)	.012–.016	.028–.039	.035–.047						
M.2.1	70 (50–110)	70 (50–110)	.012–.016	.028–.039	.035–.047						
M.3.1	100 (70–130)	100 (70–130)	.012–.016	.028–.039	.035–.047						
K.1.1											
K.1.2											
K.2.1											
K.2.2											
K.3.1											
K.3.2											
N.1.1											
N.1.2											
N.2.1											
N.2.2											
N.2.3											
N.3.1											
N.3.2											
N.3.3											
N.4.1											
S.1.1											
S.1.2											
S.2.1											
S.2.2											
S.2.3											
S.3.1						30 (20–40)	30 (20–40)	.012–.016	.031–.043	.035–.051	
S.3.2						30 (20–40)	30 (20–40)	.012–.016	.031–.043	.035–.051	
S.3.3						30 (20–40)	30 (20–40)	.012–.016	.031–.043	.035–.051	
H.1.1											
H.1.2											
H.1.3											
H.1.4											
H.2.1											
H.3.1											
O.1.1											
O.1.2											
O.2.1											
O.2.2											
O.3.1											

 The cutting data depend extremely on the external conditions, the material and machine type. The indicated values are possible values which have to be increased or reduced, inside the bracket, according to the application conditions.

Cutting Data Standard Values for Rapid Set Head

Index	Grade / coating		K10			V _c ft/min		K10		
	Article no. / type		49 804 ... / 340.21 - ASG02					49 801 ... / 340.21 - ASG3000		
	Nominal Ø in inches		.3779 - .6138	.6139 - 1.1850	1.1851 - 2.3622			.3779 - .6138	.6139 - 1.1850	1.1851 - 2.3622
	Reaming allowance Ø		.004 - .012	.008 - .016	.008 - .016			.004 - .012	.008 - .016	.008 - .016
	Number of flutes		4	6	6			4	6	6
	V _c ft/min		f	f	f	V _c ft/min		f	f	f
	3xD	5xD	inch/rev.	inch/rev.	inch/rev.	3xD	5xD	inch/rev.	inch/rev.	inch/rev.
P.1.1						30 (20-30)	30 (20-30)	.012-.020	.035-.051	.043-.059
P.1.2						100 (50-150)	100 (50-150)	.012-.020	.035-.051	.043-.059
P.1.3						30 (20-30)	30 (20-30)	.012-.020	.035-.051	.043-.059
P.1.4						30 (20-30)	30 (20-30)	.012-.020	.035-.051	.043-.059
P.1.5						30 (20-30)	30 (20-30)	.012-.020	.035-.051	.043-.059
P.2.1						30 (20-30)	30 (20-30)	.012-.020	.035-.051	.043-.059
P.2.2						30 (20-30)	30 (20-30)	.012-.020	.035-.051	.043-.059
P.2.3						30 (20-30)	30 (20-30)	.012-.020	.035-.051	.043-.059
P.2.4										
P.3.1										
P.3.2										
P.3.3										
P.4.1										
P.4.2										
M.1.1										
M.2.1										
M.3.1										
K.1.1						50 (40-80)	50 (40-80)	.016-.024	.043-.059	.051-.075
K.1.2						50 (40-80)	50 (40-80)	.016-.024	.043-.059	.051-.075
K.2.1						40 (30-60)	40 (30-60)	.016-.024	.043-.059	.051-.075
K.2.2						40 (30-50)	40 (30-50)	.012-.020	.035-.051	.043-.059
K.3.1						40 (30-60)	40 (30-60)	.012-.020	.035-.051	.043-.059
K.3.2						40 (30-60)	40 (30-60)	.012-.020	.035-.051	.043-.059
N.1.1	50 (30-100)	50 (30-100)	.012-.020	.035-.051	.043-.059	50 (40-100)	50 (40-100)	.012-.020	.035-.051	.043-.059
N.1.2	50 (30-100)	50 (30-100)	.012-.020	.035-.051	.043-.059	50 (40-100)	50 (40-100)	.012-.020	.035-.051	.043-.059
N.2.1	40 (30-70)	12 (10-20)	.016-.024	.043-.059	.047-.075	50 (40-100)	50 (40-100)	.016-.024	.043-.059	.047-.075
N.2.2	40 (30-70)	40 (30-70)	.016-.024	.043-.059	.047-.075	50 (40-100)	50 (40-100)	.016-.024	.043-.059	.047-.075
N.2.3	40 (30-70)	40 (30-70)	.016-.024	.043-.059	.047-.075	40 (30-70)	40 (30-70)	.016-.024	.043-.059	.047-.075
N.3.1	50 (30-100)	50 (30-100)	.016-.024	.043-.059	.047-.075	50 (40-100)	50 (40-100)	.016-.024	.043-.059	.047-.067
N.3.2	50 (30-100)	50 (30-100)	.016-.024	.043-.059	.047-.075	40 (30-70)	40 (30-70)	.012-.020	.035-.051	.039-.055
N.3.3	40 (30-70)	40 (30-70)	.012-.020	.035-.051	.039-.055	40 (30-70)	40 (30-70)	.012-.020	.035-.051	.039-.055
N.4.1	50 (30-100)	50 (30-100)	.016-.024	.043-.059	.047-.075	50 (40-100)	50 (40-100)	.016-.024	.043-.059	.047-.075
S.1.1										
S.1.2										
S.2.1										
S.2.2										
S.2.3										
S.3.1										
S.3.2										
S.3.3										
H.1.1										
H.1.2										
H.1.3										
H.1.4										
H.2.1										
H.3.1										
O.1.1										
O.1.2										
O.2.1										
O.2.2										
O.3.1										

3

 The cutting data depend extremely on the external conditions, the material and machine type. The indicated values are possible values which have to be increased or reduced, inside the bracket, according to the application conditions.

Cutting Data Standard Values for PCD Reamers

Index	Grade / coating		PCD		PCD	
	Article no. / type		49 200 ..., 49 204 ... / 690.10, 690.13 – ASG1101		49 201..., 49 205 ... / 690.11, 690.14 – ASG1101	
	Nominal Ø in inches		.1575 – .3150	.3151 – .7913	.3780 – .7913	
	Reaming allowance Ø		.004 – .012	.004 – .016	.004 – .016	
	Number of flutes		2	2	4	
	v_c ft/min	f inch/rev.	f inch/rev.	v_c ft/min	f inch/rev.	
P.1.1						
P.1.2						
P.1.3						
P.1.4						
P.1.5						
P.2.1						
P.2.2						
P.2.3						
P.2.4						
P.3.1						
P.3.2						
P.3.3						
P.4.1						
P.4.2						
M.1.1						
M.2.1						
M.3.1						
K.1.1						
K.1.2						
K.2.1						
K.2.2						
K.3.1						
K.3.2						
N.1.1	490 (360 – 1080)	.005 – .016	.005 – .016	490 (360 – 1080)	.009 – .031	
N.1.2	490 (360 – 1080)	.005 – .016	.005 – .016	490 (360 – 1080)	.009 – .031	
N.2.1	660 (360 – 1800)	.005 – .016	.005 – .016	660 (360 – 1800)	.009 – .031	
N.2.2	660 (360 – 1800)	.005 – .016	.005 – .016	660 (360 – 1800)	.009 – .031	
N.2.3	660 (360 – 1440)	.005 – .016	.005 – .016	660 (360 – 1440)	.009 – .031	
N.3.1						
N.3.2						
N.3.3						
N.4.1	490 (360 – 1080)	.005 – .016	.005 – .016	490 (360 – 1080)	.009 – .031	
S.1.1						
S.1.2						
S.2.1						
S.2.2						
S.2.3						
S.3.1						
S.3.2						
S.3.3						
H.1.1						
H.1.2						
H.1.3						
H.1.4						
H.2.1						
H.3.1						
O.1.1						
O.1.2						
O.2.1						
O.2.2						
O.3.1						

 The cutting data depend extremely on the external conditions, the material and machine type. The indicated values are possible values which have to be increased or reduced, inside the bracket, according to the application conditions.

REAMAX TS – Assembly instructions

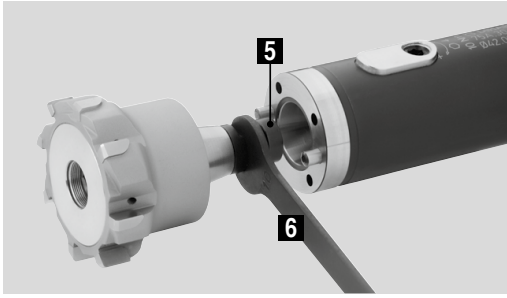

Clean the Morse taper adapter/face contact → grease-free.
Screw the pull stud (5) into the reaming head and tighten using the open-ended spanner (6).

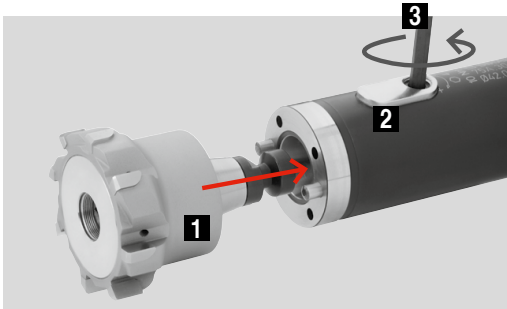

Use key (3) to open jaws (2), but do not fully release, and insert reaming head (1).

3

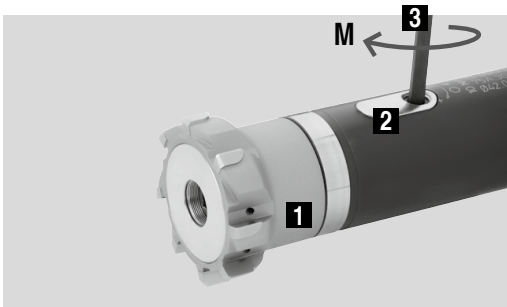

Use the key (3) to close the jaws (2), observe the recommended tightening torque.
When inserting the reaming head (1), this is pulled into its final position when the jaws (2) are closed.

Ø Range	Tightening torque (M)
.7087 - .7873	13 in-lbs
.7874 - .8661	22 in-lbs
.8662 - 1.0629	35 in-lbs
1.0630 - 1.3779	44 in-lbs
1.3780 - 1.6535	53 in-lbs
1.6536 - 2.0472	89 in-lbs
2.0473 - 2.7560	115 in-lbs

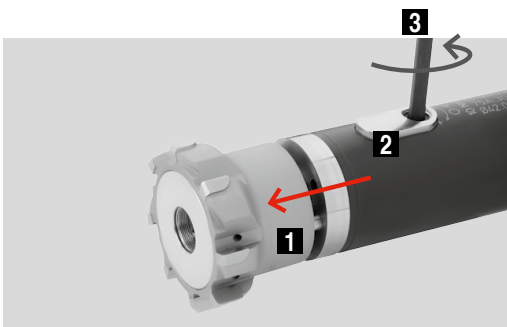

When removing the reamer head (1), it is pressed out of its position by the jaws (2) and can thus be easily removed from the holder:
Use key (3) to open the jaws (2) but do not fully release, and remove reamer head (1).

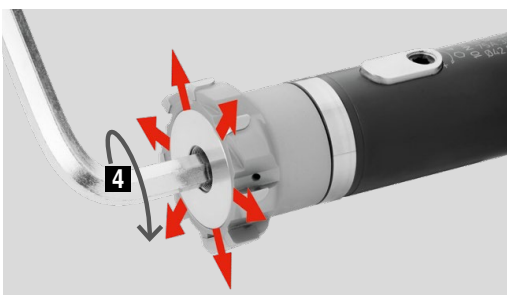

Expansion for wear compensation:
The smallest drilling tolerances up to IT4 can be achieved through adjustment with the hex key (4).

REAMAX TS – Operating instructions

Aligning the DAH Zero holder

The tool is recommended for radial alignment of max. .0008".

1. Loosen all adjustment screws and pre-load with 9 in-lbs. (new tools are already supplied like this).
2. Place dial gauge with .0001" display on the ground indicating band diameter.
3. Turn the tool to determine the point with the largest runout error using the dial gauge.
4. Adjust the corresponding adjustment screw with the hex key clockwise (1) until half the runout error has been corrected. In doing so, over-tighten by approx. .0002".
5. Release the opposite adjustment screw (2) by the over-tightened amount.
6. Adjust all 4 adjustment screws until the runout is < .0001".

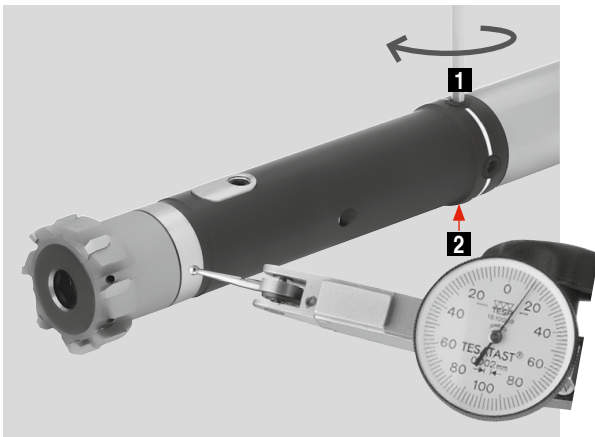

Please note:

- ▲ The run-out must be checked and if necessary, re-aligned after an adapter changeover, change of application, and after any adjustment for wear compensation, using adjustment steps 1 to 6.
- ▲ Adjustment screws must always be tightened during usage with at least 9 in-lbs.
- ▲ The max. re-adjustment torque is 40 in-lbs.

Caution!

- ▲ Uneven angle distribution!
- ▲ There are 2 cutting edges 180° opposite each other = measuring teeth
- ▲ Measure the diameter at the front on the cutting edge (due to back taper, see diagram)
- ▲ Avoid damage to the cutting edge

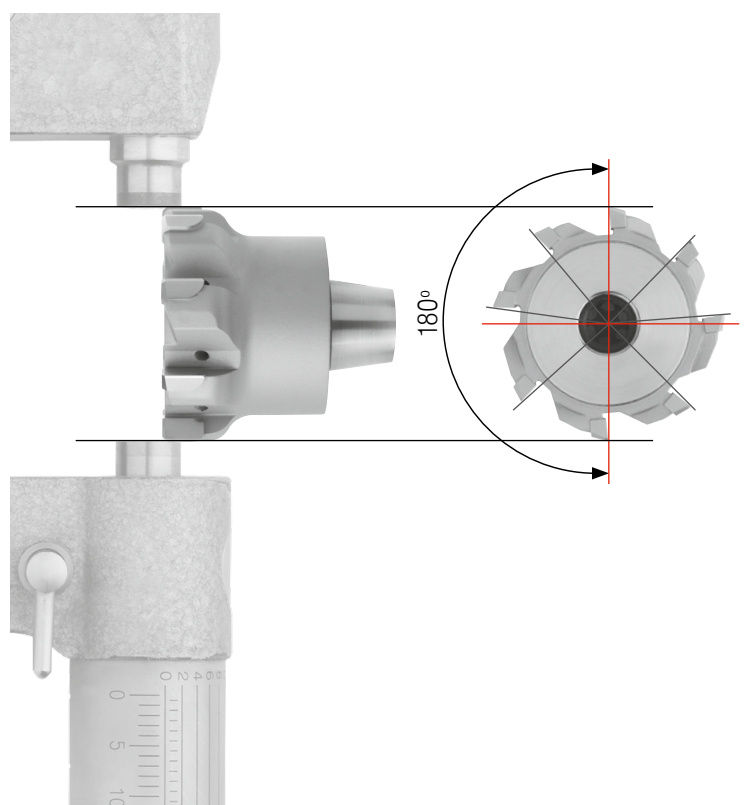

Rapid Set Head – Assembly instructions



Each rapid set head is delivered with slightly greased taper.
Do not wipe off!
Taper must be slightly greased with copper grease!
Clean taper in holder thoroughly → free of grease.
Turn the differential screw one rotation into the head
(counter-clockwise thread).

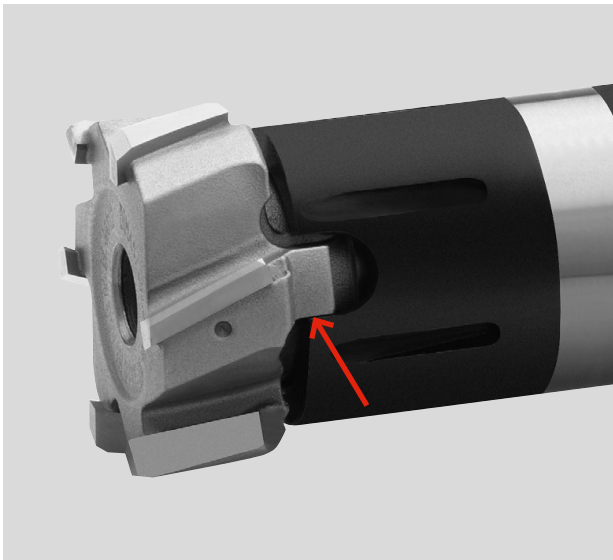

Before tightening turn the drive keys of the rapid set head
against the direction of machining until it hits the holder.

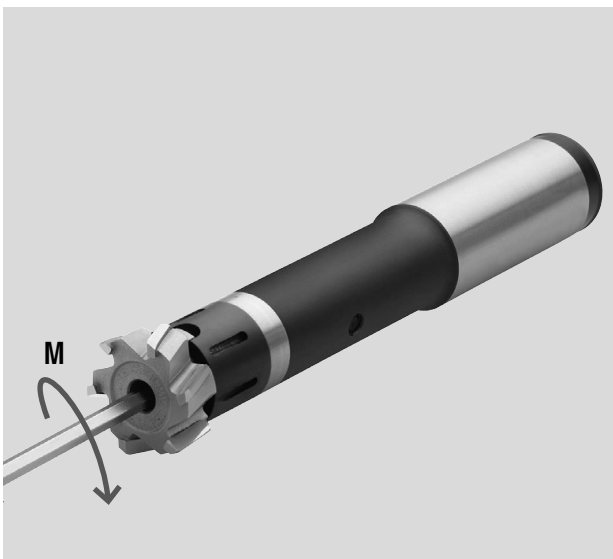

Tightening the left-/right screw.
Observe the specified tightening
torque M in the index table.

Ø range	Tightening torque (M)
0.496 - 0.614	6 - 8 in-lbs
0.615 - 0.732	10 - 12 in-lbs
0.733 - 0.945	16 - 20 in-lbs
0.946 - 1.575	27 - 34 in-lbs
1.576 - 2.362	46 - 58 in-lbs

Rapid set heads up to diameter 0.496" are assembled with
a clamping screw at the back of the holder. The screw has a
counter-clockwise thread.

Cutting Ring – Assembly Instructions on Holder for Through Hole Machining

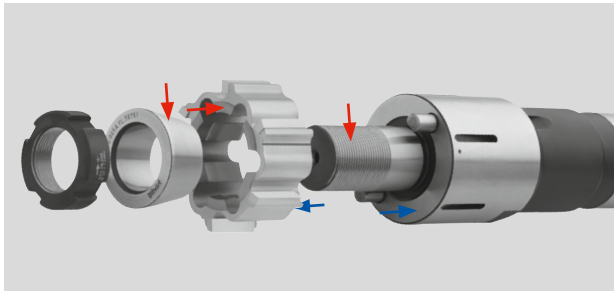

- Arrow markings:
- light grease
 - face surfaces on holder and cutting ring are grease-free

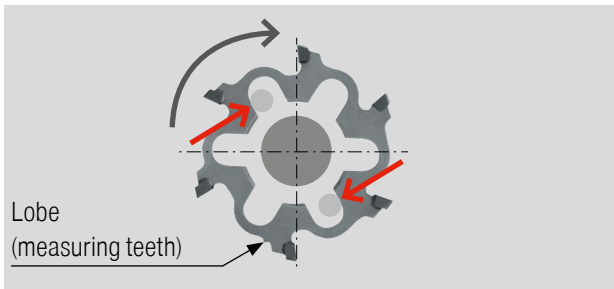

The position for the drive pins is marked with a lobe or in red. Before tightening and adjusting turn the cutting ring against the direction of machining until hitting the drive pins.

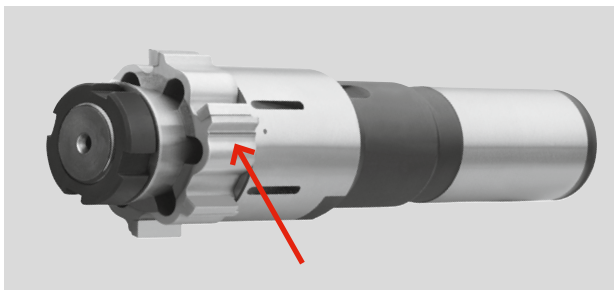

Please observe the marking on holder and cutting ring, check alignment of the coolant bores.

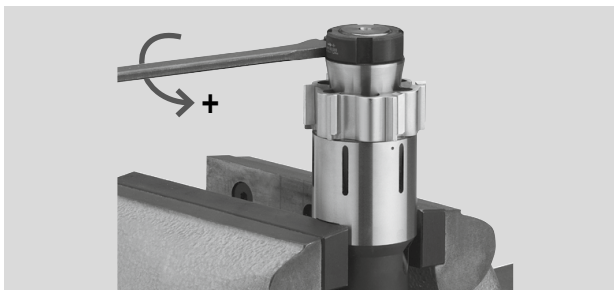

Adjust the diameter to the middle of the tolerance (counter-clockwise thread).

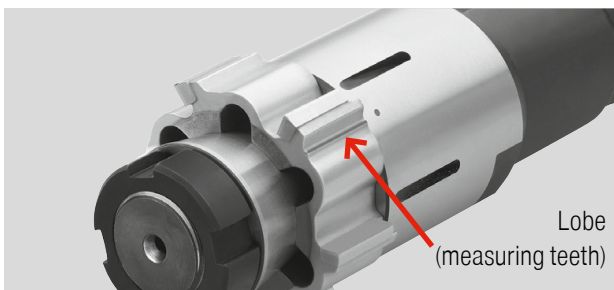

The diameter can only be measured at the marked cutting edges due to unequal angular position!

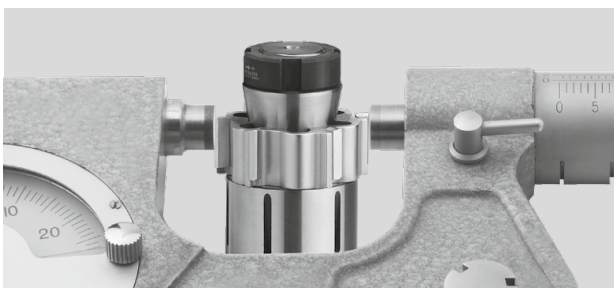

Measure the diameter. If the diameter was set too large, the conical ring must be loosened and the cutting ring readjusted.

Cutting Ring – Assembly Instructions on Holder for Blind Hole Machining

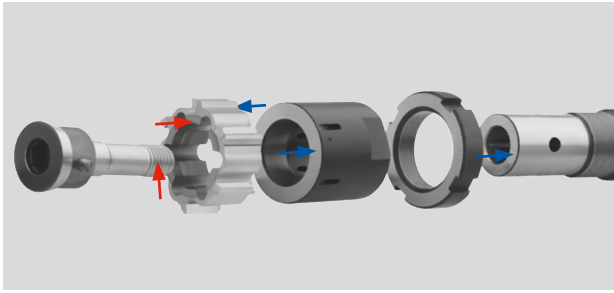

- Arrow markings:
- light grease
 - face surfaces on holder and cutting ring are grease-free

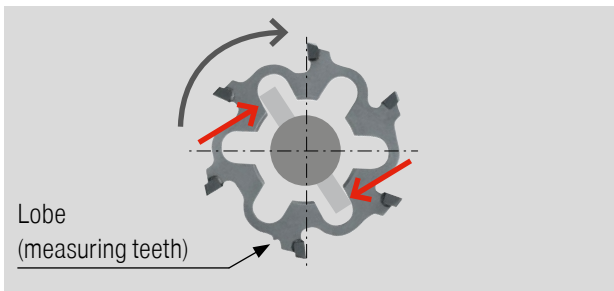

The position for the drive pins is marked with a lobe or in red. Before tightening and adjusting turn the cutting ring against the direction of machining until hitting the drive pin.

3

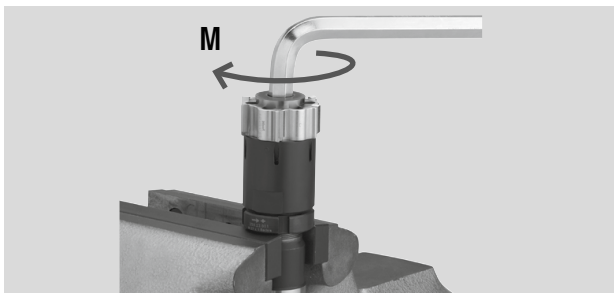

Screw the nut onto the holder with the smooth face against the bushing. Mount the cutting ring with the conical screw. After fastening the conical screw check that there is space between bushing and ring.

Fasten conical screw according to index table.

Ø range	Tightening torque (M)
2.3622	796 - 974 in-lbs.
2.4016 - 3.1102	1062 - 1239 in-lbs.
3.1496 - 3.9370	1593 - 1947 in-lbs.

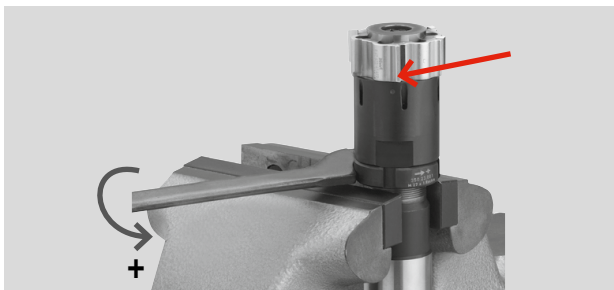

Please observe the marking on holder and cutting ring, check alignment of the coolant bores. Adjust the diameter to the middle of the tolerance.

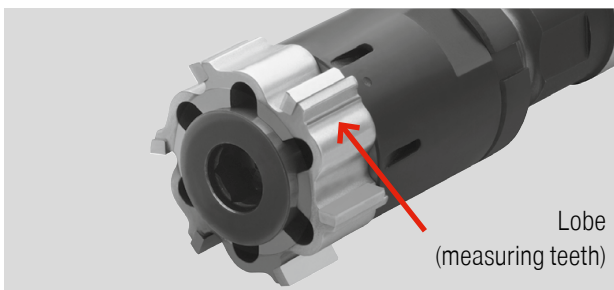

The diameter can only be measured at the marked cutting edges due to unequal angular position!

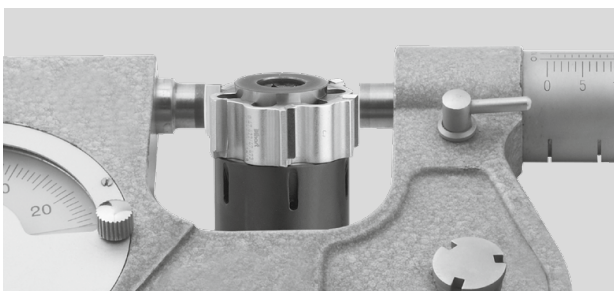

Measure the diameter. If the diameter was set too large, the nut must be loosened and the cutting ring readjusted.

Problems / possible causes / solutions

Hole too large

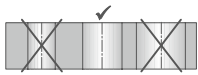

- ▲ Runout error for reamer in the spindle (rotating tool) → use DAH compensation system and correct runout
- ▲ Inaccurate alignment, reamer cuts at the back end (stationary tool) → correct alignment and use DPS floating holder
- ▲ Built-up edge → reduce cutting speed v_c for uncoated carbide cutting material, increase it for DST and coated cutting material or increase the oil content of the coolant
- ▲ Reamer too large → have reamer repaired

Hole too small

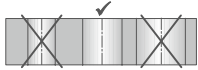

- ▲ Worn reamer → have reamer adjusted, replaced or repaired
- ▲ Reaming allowance too small → increase reaming allowance
- ▲ Cutting force too high → reduce feed or select other lead geometry (ASG)
- ▲ Reamer too small → have reamer adjusted, replaced or repaired

Conical hole, tapered backwards

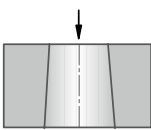

- ▲ Inaccurate alignment → correct alignment and use DPS floating holder
- ▲ Misalignment between headstock and turret → correct turret and use DPS floating holder

Conical hole, tapered forwards

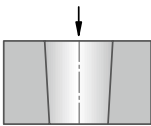

- ▲ Poor alignment, cutting edges push at start → correct alignment and use DPS floating holder

Hole is not round

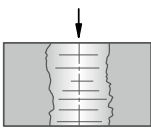

- ▲ Reamer runout error too large → correct the runout with DAH compensation system
- ▲ Alignment error → correct alignment error and use DPS floating holder
- ▲ Asymmetric initial cutting through angled entry surface → countersink hole
- ▲ Workpiece deforming due to clamping → correct clamping of the workpiece
- ▲ Poor pre-machining → optimize pre-machining
- ▲ Feed too high → reduce feed

Hole exhibits chatter marks

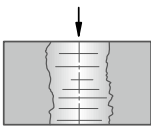

- ▲ Cutting speed v_c too high → reduce cutting speed
- ▲ L to D ratio too high → reduce the speed of entry, pilot the bore or select other lead geometry (ASG)

Poor surface quality

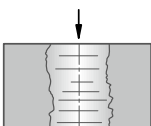

- ▲ Built-up edge → reduce cutting speed v_c for uncoated carbide cutting material, increase it for DST and coated cutting material or increase the oil content of the coolant
- ▲ Cutting edge worn → have cutting edge repaired or replace the tool
- ▲ Reamer runout error → correct the runout with DAH compensation system
- ▲ No or insufficient cooling, chips are getting trapped → use thru coolant supply and increase coolant pressure
- ▲ Unsuitable coolant → increase the oil content of the coolant
- ▲ Incorrect cutting data → use data according to catalog recommendation

Grooves in the hole "Feed marks"

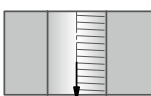

- ▲ Faulty cutting edge (edge breakage) → have reamer replaced or repaired
- ▲ Built-up edges → reduce cutting speed v_c for uncoated carbide cutting material, increase it for DST and coated cutting material or increase the oil content of the coolant

Grooves in the hole "Retraction marks"

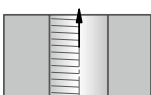

- ▲ Cutting edges moved too far out of the hole → move no more than lead length + .079" out of the hole
- ▲ Material springs back → do not retract at high speed but with increased (2-3 times) feed rate

Types of wear

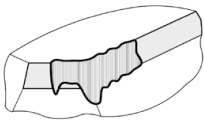

Wear on clearance face

Reduce the cutting speed and select a more wear resistant cutting material or coating.

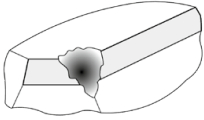

Cutting edge breakage

Reduce feed and reaming allowance. In the case of interrupted holes, use coated carbide instead of DST.

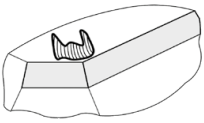

Cratering

Reduce the cutting speed and use a positive cutting edge geometry.

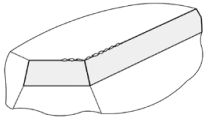

Edge breakages

Increase the cutting speed and use larger rake angle.

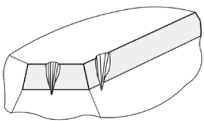

Notch wear

Reduce the cutting speed and select a more wear resistant cutting material or coating.

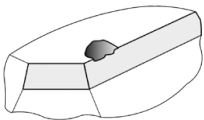

Fatigue fracture

Reduce feed, increase reamer stability.

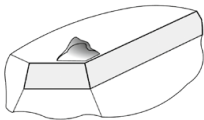

Built-up edge

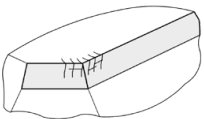

Use positive cutting edge geometry, increase the oil content of the coolant, reduce the cutting speed v_c for uncoated carbide cutting material, increase it for DST and coated cutting material.



Cracks at right angles to the cutting edge



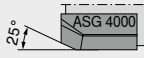
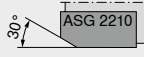

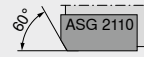
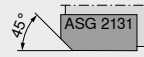
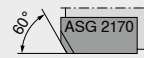
Use sufficient coolant and thru coolant, reduce the cutting speed.

Common cutting edge geometries in the performance area



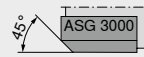

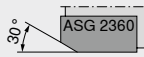

Standard geometries			
Geometry	Flute type	Chip flow	Lead angle
ASG4000	straight	←	25° 
ASG2210	left-hand helix	←	30° 
ASG2231	left-hand helix	←	30° 
ASG2270	straight	←	30° 
ASG2110	straight	→	60° 
ASG2131	straight	→	45° 
ASG2170	straight	→	60° 

Through hole

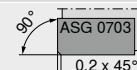
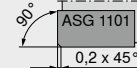
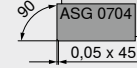
Blind hole

Standard geometries			
Geometry	Flute type	Chip flow	Lead angle
ASG3000	straight	↔	45° 
ASG0706	straight	↔	45° 
ASG0106	straight	↔	45° 
ASG2350	straight	↔	30° 
ASG2360	straight	↔	30° 

Through hole-Blind hole

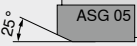
Special geometries			
Geometry	Flute type	Chip flow Comments	Lead angle
ASG0703	straight	Face cutting	90°  0,2 x 45°
ASG1101	straight	Face cutting	90°  0,2 x 45°
ASG0704	straight	Face cutting with increased positional accuracy	90°  0,05 x 45°
ASG09B	straight	Chip control < Ø 1.26 inch	
ASG1402	straight	Chip control > Ø 1.26 inch	
ASG02	straight	↔	45°  8°
ASG03	straight	↔	30°  12°
ASG05	left-handed		25° 

Achievable surface quality

Material group	Roughness	N11	N10	N9	N8	N7	N6	N5	N4	N3	N2	N1	
		Average roughness R _a											
		Surface roughness R _z											
P	1.0 - 4.2												
M	1.1 - 3.1												
K	1.1 + 2.1 + 3.1												
	1.2 + 2.2 + 3.2												
N	1.1 - 2.3												
	3.1 - 3.3												
S	1.1 - 3.3												
H	1.1 - 1.3												

reachable  conditionally reachable 

This information is based on experience and may vary from case to case, depending on the prevailing conditions.
(all other surface values on request)

Tolerances

IT tolerance class DIN 7151

Nominal dimension range (inch)	IT tolerance class (inch)											
	IT 1	IT 2	IT 3	IT 4	IT 5	IT 6	IT 7	IT 8	IT 9	IT 10	IT 11	IT 12
.039 – .118	.00003	.00005	.00008	.00012	.00016	.00024	.00039	.00055	.00098	.00158	.00236	.00394
> .118 – .236	.00004	.00006	.00010	.00016	.00020	.00032	.00047	.00071	.00118	.00189	.00295	.00472
> .236 – .394	.00004	.00006	.00010	.00016	.00024	.00035	.00059	.00087	.00142	.00228	.00354	.00591
> .394 – .709	.00005	.00008	.00012	.00020	.00032	.00043	.00071	.00106	.00169	.00276	.00433	.00709
> .709 – 1.181	.00006	.00010	.00016	.00024	.00035	.00051	.00083	.00130	.00205	.00331	.00512	.00827
> 1.181 – 1.969	.00006	.00010	.00016	.00028	.00043	.00063	.00098	.00154	.00244	.00394	.00630	.00984
> 1.969 – 3.150	.00008	.00012	.00020	.00032	.00051	.00075	.00118	.00181	.00291	.00472	.00748	.01181
> 3.150 – 4.724	.00010	.00016	.00024	.00039	.00059	.00087	.00138	.00213	.00343	.00551	.00866	.01378
> 4.724 – 7.087	.00014	.00020	.00032	.00047	.00071	.00098	.00158	.00248	.00394	.00630	.00984	.01575
> 7.087 – 9.843	.00018	.00028	.00039	.00055	.00079	.00114	.00181	.00284	.00453	.00728	.01142	.01811
> 9.843 – 12.402	.00024	.00032	.00047	.00063	.00091	.00126	.00205	.00319	.00512	.00827	.01260	.02047

Nominal dimension range (mm)	IT tolerance class (metric) (in 0.001 mm)											
	IT 1	IT 2	IT 3	IT 4	IT 5	IT 6	IT 7	IT 8	IT 9	IT 10	IT 11	IT 12
1 – 3	0.8	1.2	2	3	4	6	10	14	25	40	60	100
> 3 – 6	1	1.5	2.5	4	5	8	12	18	30	48	75	120
> 6 – 10	1	1.5	2.5	4	6	9	15	22	36	58	90	150
> 10 – 18	1.2	2	3	5	8	11	18	27	43	70	110	180
> 18 – 30	1.5	2.5	4	6	9	13	21	33	52	84	130	210
> 30 – 50	1.5	2.5	4	7	11	16	25	39	62	100	160	250
> 50 – 80	2	3	5	8	13	19	30	46	74	120	190	300
> 80 – 120	2.5	4	6	10	15	22	35	54	87	140	220	350
> 120 – 180	3.5	5	8	12	18	25	40	63	100	160	250	400
> 180 – 250	4.5	7	10	14	20	29	46	72	115	185	290	460
> 250 – 315	6	8	12	16	23	32	52	81	130	210	320	520

Manufacturer's tolerance of the reamer

T = Hole tolerance range

D = Manufacturer's tolerance of the reamer

max. hole-Ø

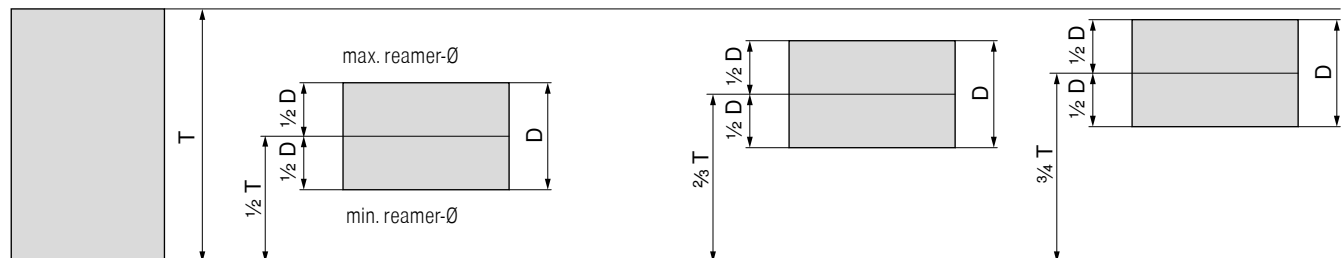

min. hole-Ø

Manufacturer's tolerance of adjustable reamers

Manufacturer's tolerance of fixed reamers

The diameter of an adjustable reamer is ground to the middle of drilling tolerance T (REAMAX TS / Monomax). The adjustment capability of the reamer facilitates wear compensation.

The manufacturer tolerance D of fixed reamers is two thirds (REAMAX) or three quarters (Fullmax) of the drilling tolerance T.

Coatings – Reaming

DBC

- ▲ Diamond-like carbon coating
- ▲ Specially for machining non-ferrous metals
- ▲ Maximum application temperature: 400 °C

TiN

- ▲ TiN coating
- ▲ Maximum application temperature: 450 °C

DBG-P

- ▲ AlTiN Multilayer coating
- ▲ Especially for universal use in a variety of materials at high cutting speeds
- ▲ Suitable for MMS application
- ▲ Maximum application temperature: 1000 °C

Grade description – Reamers

DST

- ▲ Cermet, uncoated
- ▲ ISO | **P15** | **M10** | K10
- ▲ The uncoated cermet grade for finish machining stainless and hardened steel
- ▲ Particularly wear resistant thanks to high heat resistance

K10

- ▲ Carbide, uncoated
- ▲ ISO | **K10**
- ▲ Uncoated carbide grade for machining grey cast iron or non-ferrous metals, depending on the cutting edge geometry

PCD-U

- ▲ Polycrystalline diamond cutting material, uncoated
- ▲ Particularly wear-resistant PCD grade for process reliable machining of aluminium



New products for machining technicians

NEW CTPX710 and CTPX715 the universal multi-material grade

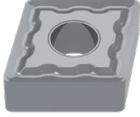

CTPX710 and CTPX715 are the first multi-application grade for turning from CERATIZIT. It impresses thanks to outstanding performance in the processing of steel, stainless steel, super alloys and non-ferrous metals.

NEW CTCM120 and CTCM130 for stainless turning

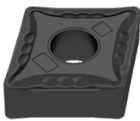

In addition to the all-rounder CTPM125 grade, the CTCM120 and CTCM130 stainless turning grades now provide a tougher and a more wear-resistant option for finer adjustment to the material to be machined. What's more, the stainless range offers geometric compatibility across all three grades.

NEW Standard line



Attractively priced indexable inserts for steel machining – our ISO turning standard line not only impresses on price but also by providing the best levels of performance!

NEW CBN/PCD update

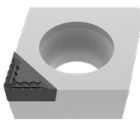

Various cutting edge finishes and chip breakers are being added to the CBN and PCD range to provide a specialist for every application.

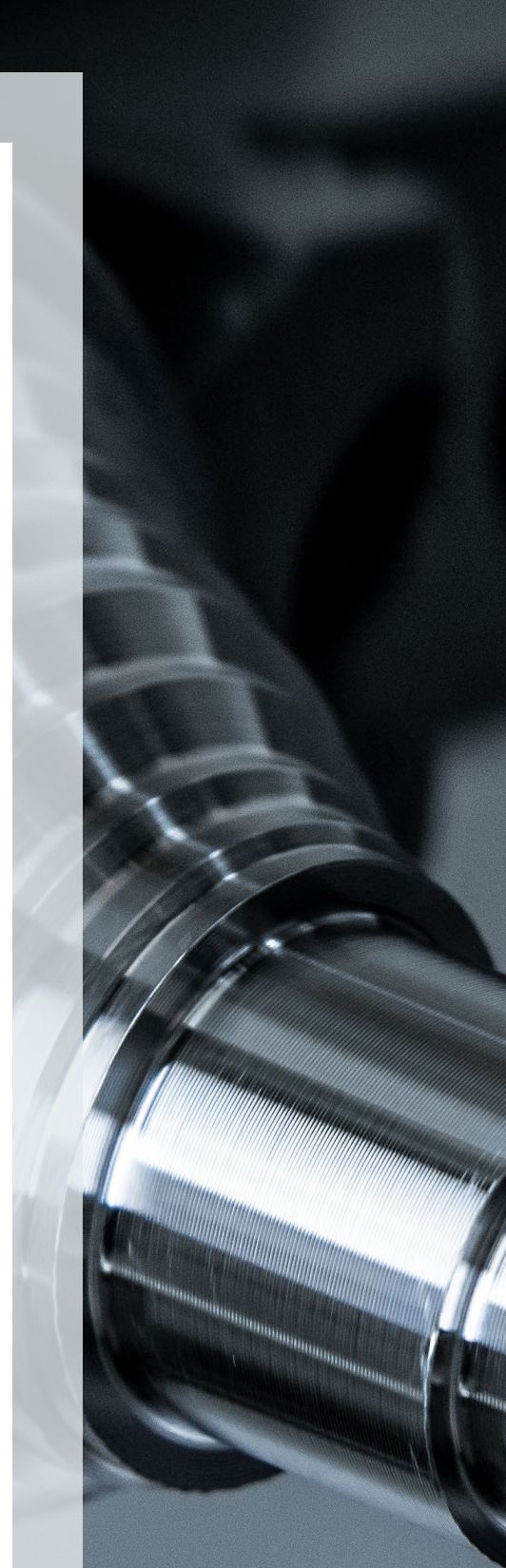



1 Indexable Drilling

Holemaking

2 Indexable Boring

3 Reaming

4 Indexable Turning

4

Turning

5 Parting and Grooving

6 Multifunction

Milling

7 Indexable Milling

8 Solid Milling

9 Material examples and
article no. index

Table of contents

Symbol explanation / Coding of the chip breaker	3
Toolfinder – Application	2+3
Toolfinder – negative inserts	4+5
Toolfinder – positive inserts	6+7
Toolfinder – holders	8
Product program	9-159
Technical Information	
Cutting Data	160-181
Application range of CBN grades	182
Diamond as a cutting material	183
Chip breakers	184-191
Masterfinish – wiper geometry – notes	192+193
ISO designation system	194-199
Wear types in indexable inserts	200+201
Grades Overview	202+203

CERATIZIT \ Performance

Premium quality tools for high performance.

The premium quality tools from the **CERATIZIT Performance** product line have been designed for specific applications and are distinguished by their outstanding performance. If you make high demands on the performance of your production and want to achieve the very best results, we recommend the Premium tools in this product line.

CERATIZIT \ Standard

Quality tools for standard applications.

The quality tools of the **CERATIZIT Standard** product line are high quality, powerful and reliable and enjoy the highest trust of our customers worldwide. Tools from this product line are the first choice for many standard applications and guarantee optimal results.

Toolfinder – Application

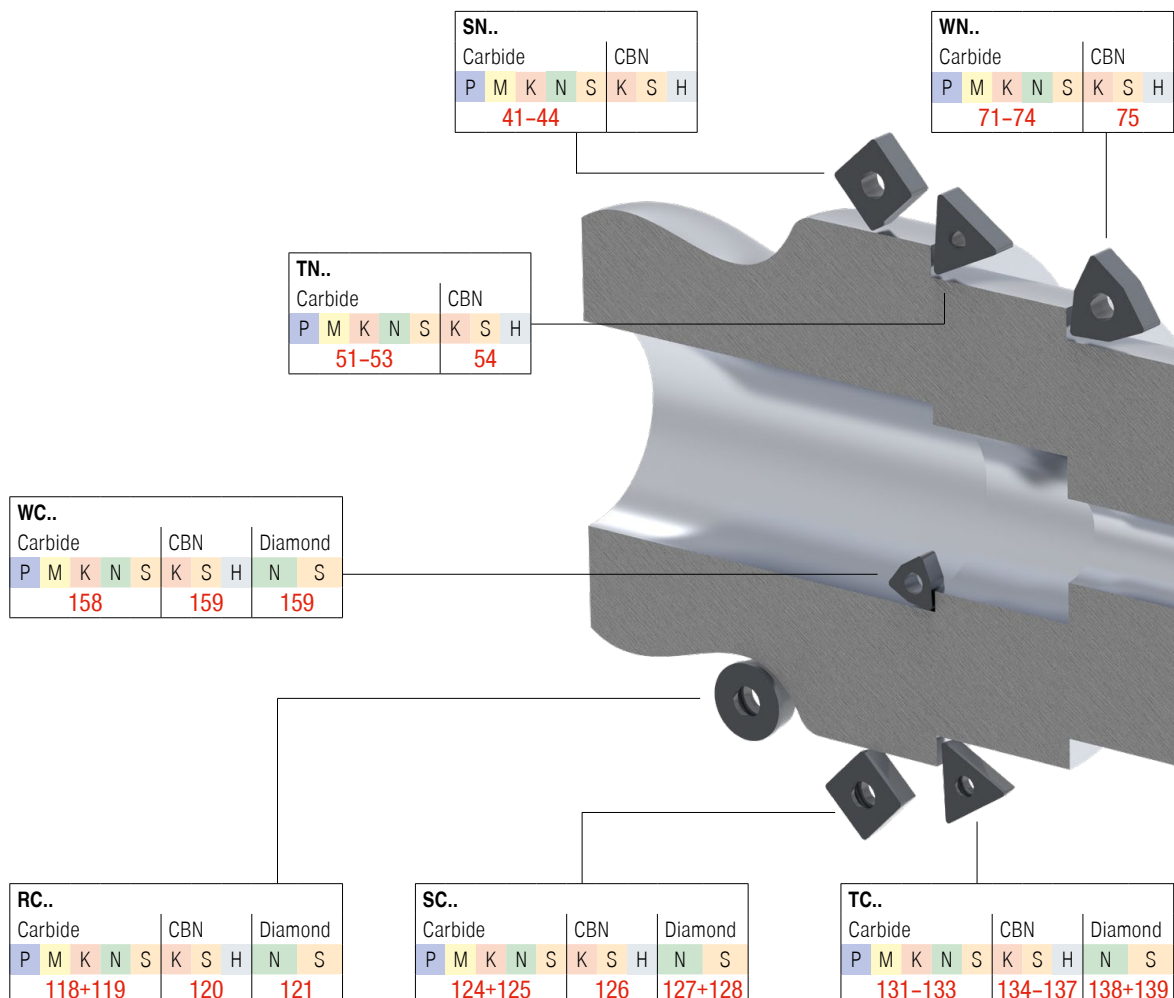

Coding of the chip breakers

All new chip breakers are coded according to the following key:

-M50

Inserts – Basic Type	Application range	Material		Chip breaker width
	F = Fine	1 = Steel	5 = Heat Resistant alloys	1 = Narrow
0 N = Negative Inserts	M = Medium	2 = Stainless steel	6 = Hard	↑ ↓ 9 = Wide
5 P = Positive Inserts	R = Rough	3 = Cast Iron	7 = Universal	
		4 = Non Ferrous Metals		

i Detailed information on the chip breakers can be found in the technical appendix → **pages 184–191.**

Symbol explanation

CTCP125
Carbide Grade

- F** Fine Machining
- M** Medium Machining
- R** Rough Machining



- Smooth cut
- Irregular cutting depth
- Interrupted cut

i A detailed overview of grades can be found in the technical appendix on → **page 202.**

CN..

Carbide					CBN			Diamond	
P	M	K	N	S	K	S	H	N	S
9-14					15-18			19	

DN..

Carbide					CBN			Diamond	
P	M	K	N	S	K	S	H	N	S
28-32					33+34			35	

VN..

Carbide					CBN		
P	M	K	N	S	K	S	H
64-66					67		

KN..

Carbide					CBN		
P	M	K	N	S	K	S	H
metric							

CC..

Carbide					CBN			Diamond	
P	M	K	N	S	K	S	H	N	S
78-83					84-90			91-95	

VC..

Carbide					CBN			Diamond	
P	M	K	N	S	K	S	H	N	S
143-146					148-151			152-154	

DC..

Carbide					CBN			Diamond	
P	M	K	N	S	K	S	H	N	S
98-102					103-110			111-115	

Additional metric items are available in our Online-Shop at cuttingtools.ceratizit.com and in the metric main catalog

Toolfinder – negative inserts



			Material							Geometry							
			P	M	K	N	S	H	O	CN..	DN..	KN..	SN..	TN..	VN..	WN..	
Main application: Steel and cast iron	Sharp	Fine	-CF / -CF20	●	○	○					9	28			51		71
			-F40	●		○										64	
			-F50	●		○					9	28		41	51	64	71
			-TFQ	●	○	○					9+10	28+29					71
			-XU	●		○					10	29				64	72
			-FMS	●		○					14	32				66	74
	Medium	-M40	●		○										64		
		-M50	●	○	○					10	29+30		41	51	64	72	
		-TMQ	●		○					10	30					72	
		-MRS	●	○						14	32					74	
		-M70 -11, -12	●	○	○					10+11	30		41+42	52		72	
		.NMA	●	○						11	30		42+43	52		73	
		Rough	-R28	●	○	○					11	30		43	52		
-R58	●		○	○					11+12	30+31		43	52+53				
-R88	●		○	○					12			44					
Main application: Stainless	Sharp	Fine	-F30	○	●		○			13	31		44	53	64	73	
			-M30	○	●		○			13	31		44	53	64+65	73	
	Medium	-M42	○	●		●											
		-M60	○	●		○			13	31		44	53		73		
Main application: Heat-resistant	Sharp	Fine	-F32	○	●		○	●									
			-M34	●	●		○	●		13	31		44	53	65	73	
	Medium	-M42	○	●		○	●										
		-M52	○	●		○	●										



Additional metric items are available in our Online-Shop at cuttingtools.ceratizit.com and in the metric main catalog.

Toolfinder – negative inserts



	Steel	Stainless steel	Cast iron	Non-ferrous metals	Heat-resistant	Tempered steel	Non-metal materials	Geometry						
	P	M	K	N	S	H	O							

Main application:		Material	Material Group							Geometry							
			P	M	K	N	S	H	O	CN..	DN..	KN..	SN..	TN..	VN..	WN..	
Cast iron, sintered steels, heat resistant, hardened	Fine	CTBS05U			•											75	
		CTBS10U		•		•				15+16							
		CTBS10C		•		•				15+16							
		CTBS20U		•		•				15+16	33						
		CTBS20C		•		•				15+16	33						75
		CTBH15U						•									
	Rough	CTBH15C					•			17	33						
		CTBH20U					•			17	33			54			
		CTBH20C	48–62 HRC				•			17	34			54	67		75
		CTBH21U	52–65 HRC				•										
		CTBH40U	54–65 HRC				•			18	34			54	67		
		CTBH40C	48–65 HRC				•			18	34			54	67		75
		CTBH41U	48–65 HRC				•			18							
Diamond	CTD PD20			•			•		19	35							
	CTD PS30			•			•		19								

4

With the PCBN grades CTB S10 and CTB S20, sintered steels can also be machined. You can find the cutting data on → [page 164–166](#).

Toolfinder – positive inserts



			Steel	Stainless steel	Cast iron	Non-ferrous metals	Heat-resistant	Tempered steel	Non-metal materials	Geometry									
			P	M	K	N	S	H	O	CC..	DC..	RC..	SC..	SP..	TC..	TP..	VC..	WC..	
Main application: Steel and cast iron	Fine	Sharp	-CF05	●	○	○				78	98		124		131		143		
			-SF	●	○	○					78+79	98		124		131		143	158
			-CF55	●	○	○						78	98		124		131		143
	Medium	stable	-SMF	●	○	○					78+79	98	118	124		131+132		143+144	
			-FMS	●	○						82	102						146	
			-SM	●	○	●					79	98+99	118	124		132		144	
			-SMQ	●	○	○					79+80	99							
			-MRS	●	○						82	102						146	
			EN, EL, ER	●	○	●									124	metric		metric	
Main application: Stainless	Fine	Sharp	-F43	○	●		●			metric	metric				metric				
			-M81	○	●		○				metric	metric					metric		
	Medium	stable	-M25	○	●		●			80	99				132		144		
			-M55	○	●		●				80	99		125		132		144	
Main application: Non-ferrous metals	Fine	Sharp	-23P		○	●		○		80	100								
			-25P	●	●	○	●	●	○		80	100		125				145	
	Medium	stable	-25Q	●	●	○	●	●	○		80	100						145	
			-27	●	●	○	●	●	○		80+81	100+101	119	125		133		145	
			-29	●	○	●		○			81	101						145	
Main application: Heat-resistant	Fine	Sharp	-F05	●	●	●	●				101						145		
			-F23	●	○	○	●				metric	metric					metric		



Additional metric items are available in our Online-Shop at cuttingtools.ceratizit.com and in the metric main catalog.

Toolfinder – positive inserts



Steel	Stainless steel	Cast iron	Non-ferrous metals	Heat-resistant	Tempered steel	Non-metal materials
P	M	K	N	S	H	O

Geometry

CC..	DC..	RC..	SC..	SP..	TC..	TP..	VC..	WC..

Main application: Cast iron, sintered steels, heat resistant, hardened	Fine	CTBS10U			•	•			84	103	120	126		134+135		148+149	159	
		CTBS10C			•	•					104+105							
		CTBS20U			•	•			85+86	104+105					134+135		148+149	
		CTBS20C			•	•			85+86	104+105					134+135		148+149	
		CTBH15U	< 32 HRC					•		87	104-106				134+135		148+149	159
		CTBH15C	< 32 HRC					•		87	106				136+137		148+149	
		CTBH21U	52-65 HRC					•		88	106-108						150	
		CTBH21C	52-65 HRC					•			107+108							
		CTBH20U						•		88	107+108				134+135		150	159
		CTBH20C	48-62 HRC					•		85-89	106-108				136+137		150	
	Rough	CTBH40U	54-65 HRC				•		89	107-110				136+137		151	159	
		CTBH40C	48-65 HRC				•		90	109+110				136+137		151		
		CTBH41U	48-65 HRC				•									151		
		CTBH41C	48-65 HRC				•			109+110								
	Diamond	CTD PD20			•		•		91+92	111+113	121	127		138		152+153	159	
		CTD PS30			•		•		93+94	112-114	121	127+128		138+139		153		
		CTD PU20			•		•		94	112-115		128		139		153+154		
		CTD CD10			•		•		95	115				139		154		
		CTD MD05			•		•		91	111						152		



With the PCBN grades CTB S10 and CTB S20, sintered steels can also be machined. You can find the cutting data on → [page 164-166](#).

Toolfinder – holders

Toolholders and boring bars for negative inserts



Geometry	Tool holder	Boring bars	Metric Tool holders and boring bars	HSK-T	PSC	Exchangeable head system	
						Exchangeable cutting heads	Basic holder
CN..	20-25	26+27	metric 	metric 	metric 	metric 	metric
DN..	36-38	39+40	metric 	metric 	metric 	metric 	metric
SN..	45-50	50	metric 	metric 			
TN..	55-61	62+63	metric 				
VN..	68+69	70		metric 	metric 		
WN..	76	77	metric 	metric 	metric 	metric 	metric

Toolholders and boring bars for positive inserts



Geometry	Tool holder	Boring bars	Metric Tool holders and boring bars	HSK-T	PSC	Exchangeable head system	
						Exchangeable cutting heads	Basic holder
CC..	96	97	metric 	metric 	metric 	metric 	metric
DC..	116	117	metric 	metric 	metric 	metric 	metric
RC..	122+123			metric 			
SC..	129	130	metric 				
TC..	140+141	142	metric 				
VC..	155+156	157	metric 	metric 	metric 		
WC..		metric 	metric 				



Additional metric items are available in our Online-Shop at cuttingtools.ceratizit.com and in the metric main catalog.



CNMG / CNMA / CNMM

Designation	L inch	S inch	D1 inch	IC inch
CNMG 32..	0.382	0.125	0.150	0.375
CNM. 43..	0.508	0.187	0.203	0.500
CNM. 54..	0.634	0.250	0.250	0.625
CNM. 64..	0.760	0.250	0.313	0.750
CNMM 86..	1.016	0.375	0.359	1.000

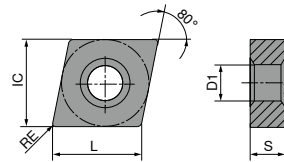

CNMG

		-CF TCM10	-CF20 CTEP110	-TFQ CTEP110	-F50 CTCP115	-F50 CTCP125	-F50 CTCP135	-TFQ CTCP115
			DRAGONSKIN	DRAGONSKIN	DRAGONSKIN	DRAGONSKIN	DRAGONSKIN	DRAGONSKIN
		F CERMET CNMG	F CERMET CNMG	F CERMET CNMG	F CNMG	F CNMG	F CNMG	F CNMG
		70 101 ...	76 101 ...	76 110 ...	76 132 ...	76 132 ...	76 132 ...	76 110 ...
ANSI	RE inch							
321EN	0.016				316	516	716	
322EN	0.031				318	518	718	
431EN	0.016	904	028	028	328	528	728	328
432EN	0.031	908	030	030	330	530	730	330
433EN	0.047			032	332	532	732	320
P		●	●	●	●	●	●	●
M		○	○	○	○	○	○	○
K		○	○	○	○	○	○	○
N								
S								
H								
O								

4













CNMG

		-TFQ CTCP125	-XU CTCP115	-XU CTCP125	-M50 CTCK110	-M50 CTCK120	-M50 CTCP115	-M50 CTCP125
		F CNMG	M CNMG	M CNMG	M CNMG	M CNMG	M CNMG	M CNMG
		76 110 ...	76 290 ...	76 290 ...	70 132 ...	70 132 ...	76 135 ...	76 135 ...
ANSI	RE inch							
431EN	0.016	528	328	528	028		328	528
432EN	0.031	530	330	530	030	530	330	530
433EN	0.047	532	332	532	032	532	320	532
434EN	0.063						334	534
542EN	0.031						342	542
543EN	0.047						344	544
544EN	0.063						346	546
P		●	●	●	○	○	●	●
M								
K		○	○	○	●	●	○	○
N								
S								
H								
O								

CNMG

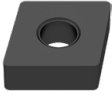

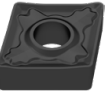
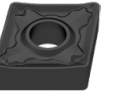
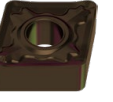



		-M50 CTCP135	-TMQ CTCP115	-TMQ CTCP125	-M70 CTCK110	-M70 CTCK120	-M70 CTCP115	-M70 CTCP125
		M CNMG	M CNMG	M CNMG	M CNMG	M CNMG	M CNMG	M CNMG
		76 135 ...	76 196 ...	76 196 ...	70 119 ...	70 119 ...	76 119 ...	76 119 ...
ANSI	RE inch							
431EN	0.016	728						
432EN	0.031	730	33000	530	030	530	330	530
433EN	0.047	732	320	532	032	532	320	532
434EN	0.063	734			034	534	334	534
542EN	0.031	742			042	542	342	542
543EN	0.047	744			044	544	344	544
544EN	0.063	746			046	546	346	546
546EN	0.094						348	548
642EN	0.031						354	554
643EN	0.047				056	556	356	556
644EN	0.063				058	558	358	558
646EN	0.094						360	560
P		●	●	●	○	○	●	●
M		○						
K			○	○	●	●	○	○
N								
S								
H								
O								

CNMG / CNMA / CNMM

		-M70 CTCP135	CTCK110	CTCK120	-R28 CTCP115	-R28 CTCP125	-R28 CTCP135	-R58 CTCP115
		DRAGONSKIN	DRAGONSKIN	DRAGONSKIN	DRAGONSKIN	DRAGONSKIN	DRAGONSKIN	DRAGONSKIN
								
								
		M	R	R	R	R	R	R
		CNMG	CNMA	CNMA	CNMM	CNMM	CNMM	CNMM
		76 119 ...	70 100 ...	70 100 ...	76 114 ...	76 114 ...	76 114 ...	76 115 ...
ANSI	RE inch							
431EN	0.016							
432EN	0.031	730	028	528	330	530		330
433EN	0.047	732	030	530	332	532	732	332
434EN	0.063	734	032	532	334	534	734	334
542EN	0.031	742	042	542				
543EN	0.047	744	044	544	344	544	744	344
544EN	0.063	746	046	546	346	546	746	346
546EN	0.094	748						348
642EN	0.031	754						
643EN	0.047	756	056	556	356	556	756	356
644EN	0.063	758	058	558	358	558	758	358
646EN	0.094	760			360	560	760	360
866EN	0.094				38400	58400	78400	384
P		●	○	○	●	●	●	●
M		○					○	
K			●	●	○	○		○
N								
S								
H								
O								

4

CNMM

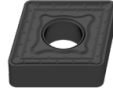
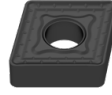
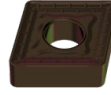
		-R58 CTCP125	-R58 CTCP135	-R88 CTCP115	-R88 CTCP125	-R88 CTCP135
		DRAGONSKIN	DRAGONSKIN	DRAGONSKIN	DRAGONSKIN	DRAGONSKIN
						
						
		R	R	R	R	R
		CNMM	CNMM	CNMM	CNMM	CNMM
		76 115 ...	76 115 ...	76 133 ...	76 133 ...	76 133 ...
ANSI	RE					
	inch					
432EN	0.031	530	730			
433EN	0.047	532	732			
434EN	0.063	534	734			
543EN	0.047	544	744			
544EN	0.063	546	746			
546EN	0.094	548	748			
546SN	0.094			348	548	748
643EN	0.047	556	756			
644EN	0.063	558	758			
644SN	0.063			358	558	758
646EN	0.094	524	760			
646SN	0.094			360	560	760
866EN	0.094	584	784			
866SN	0.094			384	584	784
P		●	●	●	●	●
M			○			○
K		○		○	○	
N						
S						
H						
O						

CNMG

ANSI	RE inch							
431EN	0.016		12800	280	32800	13000	230	33000
432EN	0.031		13000	230	33000	13200	232	33200
433EN	0.047					13400	234	33400
434EN	0.063							

P		○	○	○	○	○	○
M		●	●	●	●	●	●
K							
N							
S				○			○
H							
O							

CNMG

ANSI	RE inch						
431EN	0.016						62800
432EN	0.031		13000	230	33000		63000
433EN	0.047		13200	232	33200		63200
434EN	0.063		13400	234	33400		63400

P			○	○	○	○	●
M			●	●	●	●	●
K							
N							○
S					○		●
H							
O							

4

CNMG

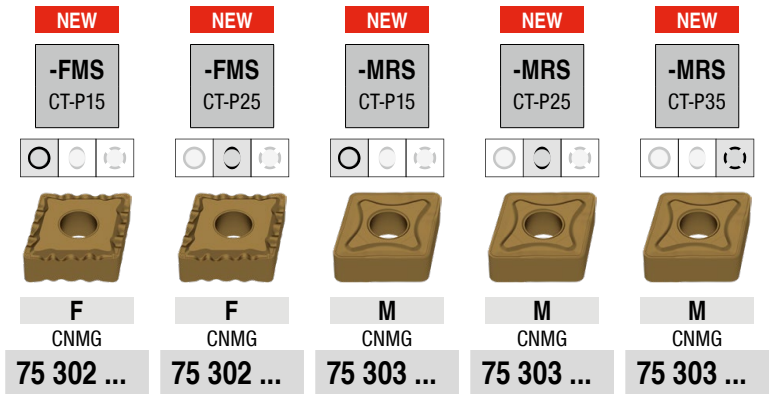

ANSI	RE inch	75 302 ...	75 302 ...	75 303 ...	75 303 ...	75 303 ...
431EN	0.016	02809	12809			
432EN	0.031	03009	13009	03009	13009	23009
433EN	0.047	03209	13209	03209	13209	23209
434EN	0.063			03409	13409	23409
543EN	0.047			04409	14409	24409
544EN	0.063			04609	14609	24609
643EN	0.047			05609	15609	25609
644EN	0.063			05809	15809	25809
P		●	●	●	●	●
M		○	○	○	○	○
K						
N						
S						
H						
O						

CNGA

Designation	L inch	S inch	D1 inch	IC inch
CNGA 43..	0.508	0.187	0.202	0.500

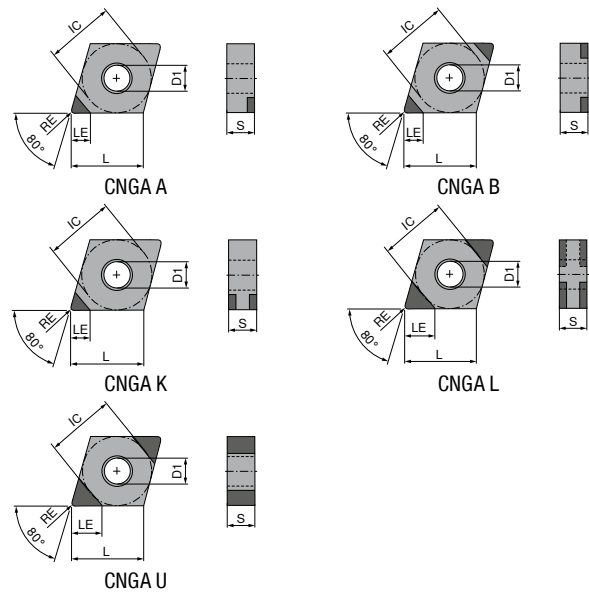

CNGA

▲ TCE(NOI) = Design and number of equipped cutting edge corners

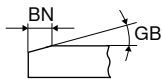

	NEW CTBS10U	NEW CTBS10C	NEW CTBS20U	CTBS20C	CTBS20C
	F	F	F	F	F
	CBN	CBN	CBN	CBN	CBN
	CNGA	CNGA	CNGA	CNGA	CNGA
	71 406 ...	71 408 ...	71 406 ...	71 400 ...	71 401 ...
ANSI	RE	BN	GB	TCE (NOI)	LE
	inch	inch			inch
43.5FN	0.008			A (1)	0.134
43.5TN	0.008	0.005	20°	A (1)	0.134
431SN	0.016	0.004	10°	L (4)	0.110
431TN	0.016	0.004	15°	A (1)	0.122
431SN	0.016	0.004	15°	L (4)	0.110
431TN	0.016	0.004	15°	L (4)	0.110
431SN	0.016	0.004	15°	K (2)	0.110
431SN	0.016	0.004	15°	L (4)	0.110
431SN	0.016	0.004	20°	L (4)	0.110
431TN	0.016	0.005	20°	A (1)	0.122
431SN	0.016	0.006	20°	K (2)	0.110
431SN	0.016	0.006	20°	L (4)	0.110
431FN	0.016			A (1)	0.122
431TN	0.016	0.006	25°	L (4)	0.110
431SN	0.016	0.007	30°	K (2)	0.110
431SN	0.016	0.007	30°	L (4)	0.110
432TN	0.031	0.004	10°	L (4)	0.098
432SN	0.031	0.004	10°	L (4)	0.098
432TN	0.031	0.004	15°	L (4)	0.098
432SN	0.031	0.004	15°	L (4)	0.098
432SN	0.031	0.004	15°	K (2)	0.098

P					
M					
K	•	•	•	•	•
N					
S	•	•	•	•	•
H					
O					

CNGA

▲ TCE(NOI) = Design and number of equipped cutting edge corners

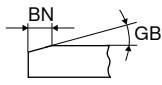

	NEW CTBS10U	NEW CTBS10C	NEW CTBS20U	CTBS20C	CTBS20C
	F	F	F	F	F
	CBN	CBN	CBN	CBN	CBN
	CNGA	CNGA	CNGA	CNGA	CNGA
	71 406 ...	71 408 ...	71 406 ...	71 400 ...	71 401 ...
432SN					16300
432SN					154
432TN					
432TN			80400		
432SN	10500			164	
432SN					17200
432FN	10400				
432TN			80500		
432SN					18000
432SN					184
432SN				184	
433SN					126
433SN					136
433TN					
433SN			80600		
433SN				146	
433FN	10600				16400
433SN			20100		
433TN	10700				156
433SN				166	
433SN					17300
433TN			80700		
433SN				186	
433SN					186

P					
M					
K		•	•	•	•
N					
S		•	•	•	•
H					
O					

CNGA

▲ TCE(NOI) = Design and number of equipped cutting edge corners

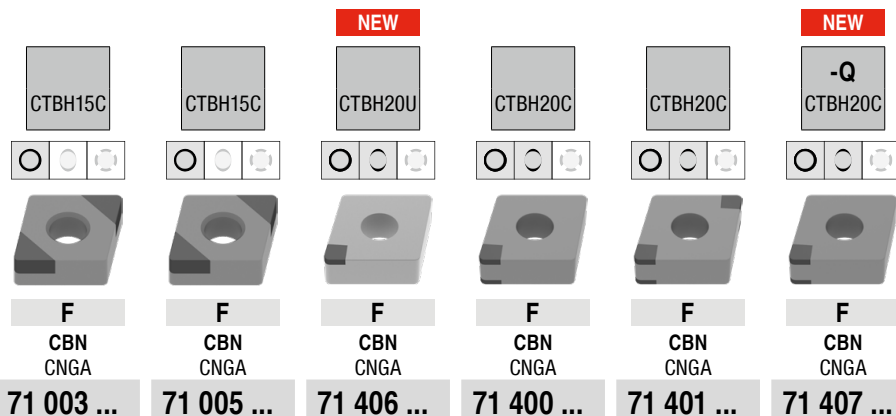
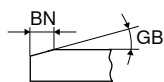

ANSI	RE inch	BN inch	GB	TCE (NOI)	LE inch	71 003 ...	71 005 ...	71 406 ...	71 400 ...	71 401 ...	71 407 ...
43.5FN	0.008			A (1)	0.134			40000			
43.5TN	0.008	0.005	20°	A (1)	0.134			40100			
431TN	0.016	0.004	15°	K (2)	0.110				222		
431TN	0.016	0.004	15°	L (4)	0.110					21200	
431SN	0.016	0.004	15°	B (2)	0.118	32814					
431SN	0.016	0.004	20°	K (2)	0.110				25800		
431SN	0.016	0.004	20°	L (4)	0.110					242	
431TN	0.016	0.005	20°	A (1)	0.122			40300			
431TN	0.016	0.004	25°	K (2)	0.110				252		
431FN	0.016			L (4)	0.110					20200	
431TN	0.016	0.004	25°	L (4)	0.110					25200	
431FN	0.016			K (2)	0.110				212		
431FN	0.016			A (1)	0.122			40200			
431RN	0.016			B (2)	0.118	22800					
431SN	0.016	0.005	25°	L (4)	0.110					262	
431SN	0.016	0.006	25°	B (2)	0.118	32829					
432TN	0.031	0.004	15°	K (2)	0.098				224		
432SN	0.031	0.004	15°	B (2)	0.106	33014					
432TN	0.031	0.004	20°	K (2)	0.098				234		
432FN	0.031			K (2)	0.098						30000
432FN	0.031			L (4)	0.098					20300	
432FN	0.031			A (1)	0.110			40400			
432RN	0.031			B (2)	0.106	23000					
432SN	0.031	0.004	20°	K (2)	0.098				26000		
432SN	0.031	0.004	20°	L (4)	0.098					244	
432TN	0.031	0.005	20°	A (1)	0.110			40500			
432TN	0.031	0.004	25°	K (2)	0.098				254		
432TN	0.031	0.004	25°	L (4)	0.098					25300	
432SN	0.031	0.005	25°	L (4)	0.098					264	
432SN	0.031	0.006	25°	B (2)	0.106	33029					
432SN	0.031	0.006	30°	L (4)	0.098					274	
433TN	0.047	0.004	15°	K (2)	0.087				226		
433FN	0.047			K (2)	0.087				216		
433RN	0.047			B (2)	0.094		23200				
433SN	0.047	0.004	15°	B (2)	0.094		33214				
433SN	0.047	0.004	20°	K (2)	0.087				26200		
433SN	0.047	0.004	20°	L (4)	0.087					246	
433TN	0.047	0.004	25°	K (2)	0.087				256		
433TN	0.047	0.004	25°	L (4)	0.087					25400	
433SN	0.047	0.005	25°	L (4)	0.087					266	
433SN	0.047	0.006	25°	B (2)	0.094		33229				

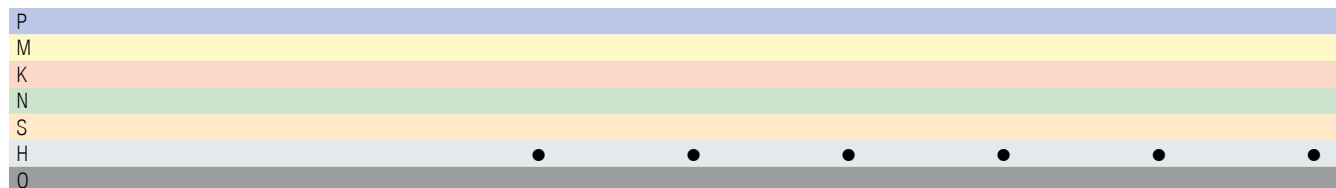

4

CNGA

▲ TCE(NOI) = Design and number of equipped cutting edge corners

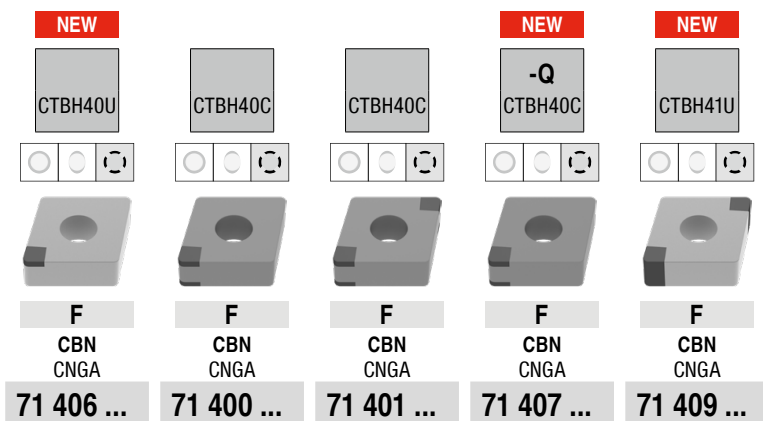
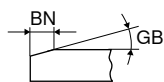

ANSI	RE inch	BN inch	GB	TCE (NOI)	LE inch	71 406 ...	71 400 ...	71 401 ...	71 407 ...	71 409 ...
43.5FN	0.008			A (1)	0.134	50000				
43.5TN	0.008	0.005	25°	A (1)	0.134	50100				
431SN	0.016	0.004	20°	L (4)	0.110					
431SN	0.016	0.004	20°	L (4)	0.110					
431SN	0.016	0.004	25°	K (2)	0.110					
431SN	0.016	0.004	25°	L (4)	0.110		352			
431FN	0.016			A (1)	0.122	50200				
431TN	0.016	0.005	25°	A (1)	0.122	50300				
431TN	0.016	0.003	30°	U (2)	0.110					70000
431SN	0.016	0.006	30°	L (4)	0.110				372	
431SN	0.016	0.006	35°	L (4)	0.110				38000	
431SN	0.016	0.006	35°	K (2)	0.110		382			
432SN	0.031	0.004	15°	L (4)	0.098				31200	
432EN	0.031			L (4)	0.098				30200	
432EN	0.031			K (2)	0.098		314			
432FN	0.031			A (1)	0.110	50400				
432SN	0.031	0.004	20°	L (4)	0.098				334	
432SN	0.031	0.004	20°	L (4)	0.098				34300	
432SN	0.031	0.004	20°	K (2)	0.098		35800			
432SN	0.031	0.004	25°	K (2)	0.098		354			
432SN	0.031	0.004	25°	L (4)	0.098				354	
432TN	0.031	0.005	25°	A (1)	0.110	50500				
432SN	0.031	0.005	25°	K (2)	0.098					
432SN	0.031	0.005	25°	L (4)	0.098		36200			
432TN	0.031	0.003	30°	U (2)	0.102					70100
432SN	0.031	0.006	30°	L (4)	0.098				364	
432SN	0.031	0.006	30°	K (2)	0.098				374	
432SN	0.031	0.006	30°	K (2)	0.098		38800		60000	
432SN	0.031	0.006	35°	L (4)	0.098				38100	
432SN	0.031	0.006	35°	K (2)	0.098		384		60100	
433SN	0.047	0.004	20°	L (4)	0.087				336	
433SN	0.047	0.004	25°	K (2)	0.087		356			
433SN	0.047	0.004	25°	L (4)	0.087				356	
433TN	0.047	0.005	25°	A (1)	0.098	50700				
433SN	0.047	0.005	25°	L (4)	0.087				366	
433TN	0.047	0.003	30°	U (2)	0.094					70200
433SN	0.047	0.006	30°	L (4)	0.087				376	
433FN	0.047			A (1)	0.098	50600				
433SN	0.047	0.006	35°	K (2)	0.087		386			

P	
M	
K	
N	
S	
H	•
O	•

For fast and efficient determination of the most appropriate edge preparation CNGA test inserts are available. → Page 182

CNGA

Designation	L inch	S inch	D1 inch	IC inch
CNGA 43..	0.508	0.187	0.202	0.500

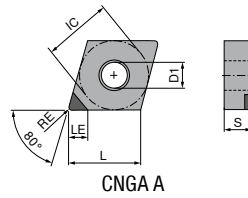

CNGA

▲ TCE(NOI) = Design and number of equipped cutting edge corners

NEW	NEW
CTDPD20	CTDPS30
○ ○ ○	○ ○ ○
F	F
DIAMOND CNGA	DIAMOND CNGA
71 127 ...	71 127 ...
10001	20001
10101	20101
10201	20201

ANSI	RE inch	TCE (NOI)	LE inch
431FN	0.016	A (1)	0.248
432FN	0.031	A (1)	0.236
433FN	0.047	A (1)	0.224

P		
M		
K		
N	•	•
S		
H		
O	•	•

4

MaxiLock-D – DCLN 95° – Toolholder with top clamping

▲ A... = with thru coolant

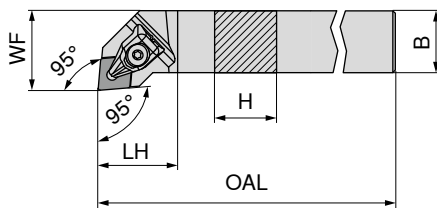

Illustrations show right-hand versions

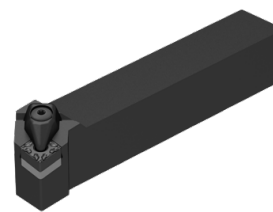

Designation	H inch	B inch	OAL inch	LH inch	WF inch	Insert
DCLN R/L 12-4B-N	0.750	0.750	4.500	1.250	1.000	CN..43..
DCLN R/L 16-4D-N	1.000	1.000	6.000	1.250	1.250	CN..43..
DCLN R/L 16-4DA-N	1.000	1.000	6.000	1.250	1.250	CN..43..
DCLN R/L 20-4D-N	1.250	1.250	6.000	1.250	1.500	CN..43..
DCLN R/L 20-4DA-N	1.250	1.250	6.000	1.250	1.500	CN..43..
DCLN L 20-5DA-N	1.250	1.250	6.000	1.380	1.500	CN..54..
DCLN R/L 20-5D-N	1.250	1.250	6.000	1.380	1.500	CN..54..
DCLN R/L 24-5E-N	1.500	1.500	7.000	1.380	2.000	CN..54..
DCLN R/L 24-5EA-N	1.500	1.500	7.000	1.380	2.000	CN..54..
DCLN L 20-6D-N	1.250	1.250	6.000	1.650	1.500	CN..64..
DCLN R/L 20-6DA-N	1.250	1.250	6.000	1.650	1.500	CN..64..
DCLN R/L 24-6EA-N	1.500	1.500	7.000	1.650	2.000	CN..64..
DCLN R/L 24-6E-N	1.500	1.500	7.000	1.650	2.000	CN..64..

Left-hand 78 501 ...	Right-hand 78 500 ...
01293	01293
01689	01689
01690	01690
02089	02089
02090	02090
02085	02085
02084	02084
02482	02482
02483	02483
02080	02080
02081	02081
02478	02478
02477	02477

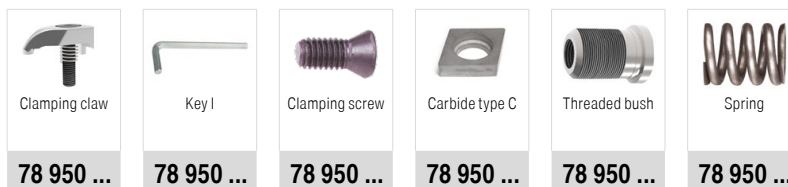

**Spare parts
for Article no.**

Article no.	78 950 ...	78 950 ...	78 950 ...	78 950 ...	78 950 ...	78 950 ...
78 500 01293 / 78 501 01293	07600	08100	08300	08800	08500	04900
78 500 01689 / 78 501 01689	07600	08100	08300	08800	08500	04900
78 500 01690 / 78 501 01690	07600	08100	08300	08800	08500	04900
78 500 02089 / 78 501 02089	07600	08100	08300	08800	08500	04900
78 500 02090 / 78 501 02090	07600	08100	08300	08800	08500	04900
78 500 02085 / 78 501 02085	07700	08100	08300	04100	08600	04900
78 500 02084 / 78 501 02084	07700	08100	08300	04100	08600	04900
78 500 02482 / 78 501 02482	07700	08100	08300	04100	08600	04900
78 500 02483 / 78 501 02483	07700	08100	08300	04100	08600	04900
78 500 02080 / 78 501 02080	07800	08100	08300	00900	08700	04900
78 500 02081 / 78 501 02081	07800	08100	08300	00900	08700	04900
78 500 02478 / 78 501 02478	07800	08100	08300	00900	08700	04900
78 500 02477 / 78 501 02477	07800	08100	08300	00900	08700	04900

MaxiLock-M – MCFN 90° – Toolholder with top clamping

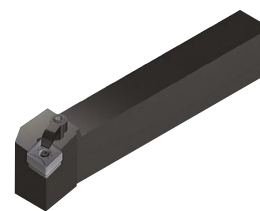
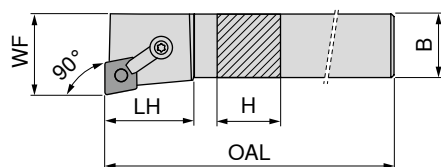

Illustrations show right-hand versions

Designation	H inch	B inch	OAL inch	LH inch	WF inch	Insert	Left-hand 78 517 ...		Right-hand 78 516 ...	
							MCFN R/L 12-4B	0.750	0.750	4.500
MCFN R/L 16-4D	1.000	1.000	6.000	1.120	1.250	CN..43..	01644	01644	01644	01644
MCFN R/L 20-4D	1.250	1.250	6.000	1.120	1.500	CN..43..	02044	02044	02044	02044
MCFN R/L 85-4D	1.250	1.000	6.000	1.120	1.250	CN..43..	08544	08544	08544	08544
MCFN R/L 16-5D	1.000	1.000	6.000	1.250	1.250	CN..54..	01645	01645	01645	01645
MCFN R/L 20-5D	1.250	1.250	6.000	1.250	1.500	CN..54..	02045	02045	02045	02045
MCFN R/L 24-5D	1.500	1.500	6.000	1.250	2.000	CN..54..	02445	02445	02445	02445
MCFN R/L 16-6D	1.000	1.000	6.000	1.310	1.250	CN..64..	01646	01646	01646	01646
MCFN R/L 20-6D	1.250	1.250	6.000	1.310	1.500	CN..64..	02046	02046	02046	02046
MCFN R/L 24-6D	1.500	1.500	6.000	1.250	2.000	CN..64..	02446	02446	02446	02446

Clamp	Key I	Dowel pin	Clamping screw	Carbide type C
78 950 ...	78 950 ...	78 950 ...	78 950 ...	78 950 ...

Spare parts
for Article no.

78 516 01224 / 78 517 01224	00400	06900	03100	03800	00800
78 516 01644 / 78 517 01644	00400	06900	03100	03800	00800
78 516 02044 / 78 517 02044	00400	06900	03100	03800	00800
78 516 08544 / 78 517 08544	00400	06900	03100	03800	00800
78 516 01645 / 78 517 01645	00300	08100	03200	03900	04100
78 516 02045 / 78 517 02045	00300	08100	03200	03900	04100
78 516 02445 / 78 517 02445	00300	08100	03200	03900	04100
78 516 01646 / 78 517 01646	00300	08100	03300	03900	00900
78 516 02046 / 78 517 02046	00300	08100	03300	03900	00900
78 516 02446 / 78 517 02446	00300	08100	03300	03900	00900

MaxiLock-M – MCGN 90° – Toolholder with top clamping

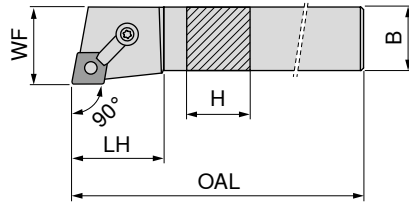

Illustrations show right-hand versions

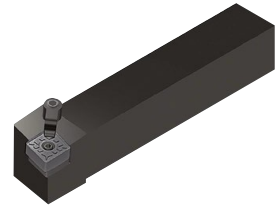

Designation	H inch	B inch	OAL inch	LH inch	WF inch	Insert	Left-hand	Right-hand
							78 519 ...	78 518 ...
MCGN R/L 12-4B	0.750	0.750	4.500	1.120	1.000	CN..43..	01224	01224
MCGN R/L 16-4D	1.000	1.000	6.000	1.120	1.250	CN..43..	01644	01644
MCGN R/L 20-4D	1.250	1.250	6.000	1.120	1.500	CN..43..	02044	02044
MCGN R/L 24-4D	1.500	1.500	6.000	1.250	2.000	CN..43..	02444	02444
MCGN R/L 16-5D	1.000	1.000	6.000	1.500	1.250	CN..54..	01645	01645
MCGN R/L 20-5D	1.250	1.250	6.000	1.500	1.500	CN..54..	02045	02045
MCGN R/L 24-5D	1.500	1.500	6.000	1.500	2.000	CN..54..	02445	02445
MCGN R/L 20-6D	1.250	1.250	6.000	1.650	1.500	CN..64..	02046	02046
MCGN R/L 24-6D	1.500	1.500	6.000	1.650	2.000	CN..64..	02446	02446

Clamp	Key I	Dowel pin	Clamping screw	Carbide type C
78 950 ...	78 950 ...	78 950 ...	78 950 ...	78 950 ...

Spare parts for Article no.	Clamp	Key I	Dowel pin	Clamping screw	Carbide type C
78 518 01224 / 78 519 01224	00400	06900	03100	03800	00800
78 518 01644 / 78 519 01644	00400	06900	03100	03800	00800
78 518 02044 / 78 519 02044	00400	06900	03100	03800	00800
78 518 02444 / 78 519 02444	00400	06900	03100	03800	00800
78 518 01645 / 78 519 01645	00300	08100	03200	03900	04100
78 518 02045 / 78 519 02045	00300	08100	03200	03900	04100
78 518 02445 / 78 519 02445	00300	08100	03200	03900	04100
78 518 02046 / 78 519 02046	00300	08100	03300	03900	00900
78 518 02446 / 78 519 02446	00300	08100	03300	03900	00900

MaxiLock-M – MCKN 75° – Toolholder with top clamping

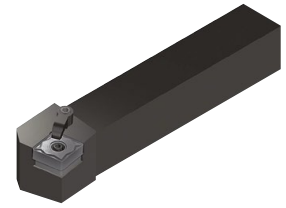
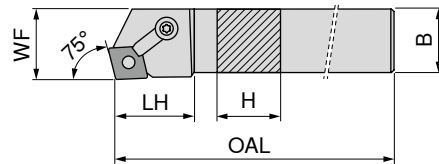

Illustrations show right-hand versions

Designation	H inch	B inch	OAL inch	LH inch	WF inch	Insert	Left-hand	Right-hand
							78 521 ...	78 520 ...
MCKN R/L 12-4B	0.750	0.750	4.500	1.200	1.000	CN..43..	01224	01224
MCKN R/L 16-4D	1.000	1.000	6.000	1.200	1.250	CN..43..	01644	01644
MCKN R/L 20-4D	1.250	1.250	6.000	1.200	1.500	CN..43..	02044	02044
MCKN R/L 16-5D	1.000	1.000	6.000	1.350	1.250	CN..54..	01645	01645
MCKN R/L 20-5D	1.250	1.250	6.000	1.350	1.500	CN..54..	02045	02045
MCKN R/L 16-6D	1.000	1.000	6.000	1.470	1.250	CN..64..	01646	01646
MCKN R/L 20-6D	1.250	1.250	6.000	1.470	1.500	CN..64..	02046	02046
MCKN R/L 24-6D	1.500	1.500	6.000	1.470	2.000	CN..64..	02446	02446

	Clamp	Key I	Dowel pin	Clamping screw	Carbide type C
	78 950 ...	78 950 ...	78 950 ...	78 950 ...	78 950 ...
Spare parts for Article no.					
78 520 01224 / 78 521 01224	00400	06900	03100	03800	00800
78 520 01644 / 78 521 01644	00400	06900	03100	03800	00800
78 520 02044 / 78 521 02044	00400	06900	03100	03800	00800
78 520 01645 / 78 521 01645	00300	08100	03200	03900	04100
78 520 02045 / 78 521 02045	00300	08100	03200	03900	04100
78 520 01646 / 78 521 01646	00300	08100	03300	03900	00900
78 520 02046 / 78 521 02046	00300	08100	03300	03900	00900
78 520 02446 / 78 521 02446	00300	08100	03300	03900	00900

MaxiLock-M – MCLN 95° – Toolholder with top clamping

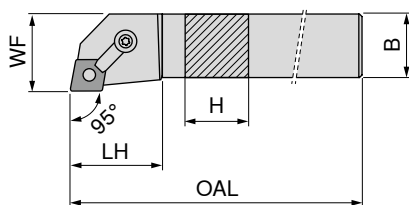

Illustrations show right-hand versions

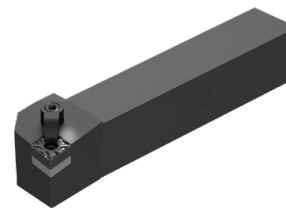

Designation	H inch	B inch	OAL inch	LH inch	WF inch	Insert	Left-hand	Right-hand
							78 523 ...	78 522 ...
MCLN R/L 12-4B	0.750	0.750	4.500	1.130	1.000	CN..43..	01224	01224
MCLN R/L 16-4D	1.000	1.000	6.000	1.130	1.250	CN..43..	01644	01644
MCLN R/L 85-4D	1.250	1.000	6.000	1.130	1.250	CN..43..	08544	08544
MCLN R/L 20-4D	1.250	1.250	6.000	1.130	1.500	CN..43..	02044	02044
MCLN R/L 16-5D	1.000	1.000	6.000	1.470	1.250	CN..54..	01645	01645
MCLN R/L 20-5D	1.250	1.250	6.000	1.470	1.500	CN..54..	02045	02045
MCLN R/L 24-5D	1.500	1.500	6.000	1.470	2.000	CN..54..	02445	02445
MCLN R/L 16-6D	1.000	1.000	6.000	1.510	1.250	CN..64..	01646	01646
MCLN R/L 20-6D	1.250	1.250	6.000	1.510	1.500	CN..64..	02046	02046
MCLN R/L 85-6D	1.250	1.000	6.000	1.510	1.250	CN..64..	08546	08546
MCLN R/L 24-6D	1.500	1.500	6.000	1.510	2.000	CN..64..	02446	02446
MCLN R/L 24-6E	1.500	1.500	7.000	1.500	2.000	CN..64..	02456	02456
MCLN R/L 86-6E	1.500	1.000	7.000	1.510	1.250	CN..64..	08656	08656

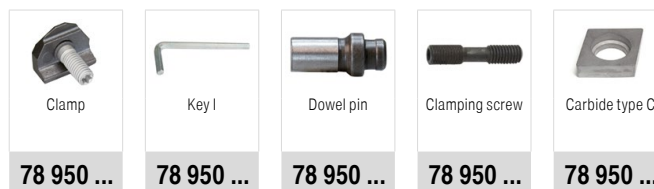

Spare parts for Article no.	78 950 ...	78 950 ...	78 950 ...	78 950 ...	78 950 ...
78 522 01224 / 78 523 01224	00400	06900	03100	03800	00800
78 522 01644 / 78 523 01644	00400	06900	03100	03800	00800
78 522 08544 / 78 523 08544	00400	06900	03100	03800	00800
78 522 02044 / 78 523 02044	00400	06900	03100	03800	00800
78 522 01645 / 78 523 01645	00300	08100	03200	03900	04100
78 522 02045 / 78 523 02045	00300	08100	03200	03900	04100
78 522 02445 / 78 523 02445	00300	08100	03200	03900	04100
78 522 01646 / 78 523 01646	00300	08100	03300	03900	00900
78 522 02046 / 78 523 02046	00300	08100	03300	03900	00900
78 522 08546 / 78 523 08546	00300	08100	03300	03900	00900
78 522 02446 / 78 523 02446	00300	08100	03300	03900	00900
78 522 02456 / 78 523 02456	00300	08100	03300	03900	00900
78 522 08656 / 78 523 08656	00300	08100	03300	03900	00900

MaxiLock-M – MCRN 75° – Toolholder with top clamping

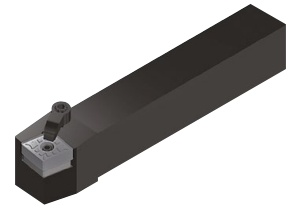
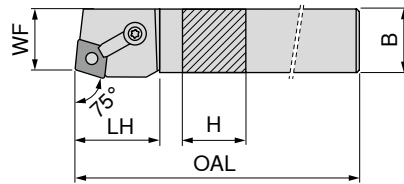

Illustrations show right-hand versions

Designation	H	B	OAL	LH	WF	Insert
	inch	inch	inch	inch	inch	
MCRN R/L 12-4B	0.750	0.750	4.500	1.180	0.878	CN..43..
MCRN R/L 16-4D	1.000	1.000	6.000	1.180	1.128	CN..43..
MCRN R/L 20-4D	1.250	1.250	6.000	1.180	1.318	CN..43..
MCRN R/L 16-5D	1.000	1.000	6.000	1.100	1.101	CN..54..
MCRN R/L 20-5D	1.250	1.250	6.000	1.350	1.351	CN..54..
MCRN R/L 20-6D	1.250	1.250	6.000	1.318	1.318	CN..64..
MCRN R/L 24-6D	1.500	1.500	6.000	1.818	1.818	CN..64..

Left-hand 78 525 ...	Right-hand 78 524 ...
01224	01224
01644	01644
02044	02044
01645	01645
02045	02045
02046	02046
02446	02446

Clamp	Key I	Dowel pin	Clamping screw	Carbide type C
78 950 ...	78 950 ...	78 950 ...	78 950 ...	78 950 ...

Spare parts for Article no.

78 524 01224 / 78 525 01224	00400	06900	03100	03800	00800
78 524 01644 / 78 525 01644	00400	06900	03100	03800	00800
78 524 02044 / 78 525 02044	00400	06900	03100	03800	00800
78 524 01645 / 78 525 01645	00300	08100	03200	03900	04100
78 524 02045 / 78 525 02045	00300	08100	03200	03900	04100
78 524 02046 / 78 525 02046	00300	08100	03300	03900	00900
78 524 02446 / 78 525 02446	00300	08100	03300	03900	00900

MaxiLock-D – DCLN 95° – Boring bar with top clamping

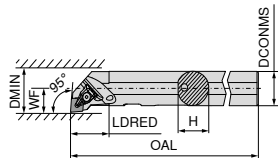

Illustrations show right-hand versions



Designation	DCONMS inch	H inch	OAL inch	LDRED inch	WF inch	DMIN inch	Insert	Left-hand	Right-hand
								78 701 ...	78 700 ...
S16T DCLN R/L 4N	1.000	0.900	12.000	1.575	0.640	1.280	CN..43..	41626	41626
S20U DCLN R/L 4N	1.250	1.180	14.000	1.771	0.765	1.530	CN..43..	42030	42030
S24U DCLN R/L 4N	1.500	1.370	14.000	1.968	0.890	1.780	DN..43..	42434	42434

Clamping claw	Key I	Clamping screw	Carbide type C	Threaded bush	Spring
78 950 ...	78 950 ...	78 950 ...	78 950 ...	78 950 ...	78 950 ...

Spare parts for Article no.

78 700 41626 / 78 701 41626	07600	08100	08300	07200	08500	04900
78 700 42030 / 78 701 42030	07600	08100	08300	07200	08500	04900
78 700 42434 / 78 701 42434	07600	08100	08300	07200	08500	04900

MaxiLock-M – MCLN 95° – Boring bar with top clamping

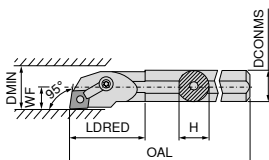

Illustrations show right-hand versions



Designation	DCONMS inch	H inch	OAL inch	LDRED inch	WF inch	DMIN inch	Insert	Left-hand	Right-hand
								78 705 ...	78 704 ...
A16T MCLN R/L 4	1.000	0.900	12.000	2.500	0.640	1.280	CN..32..	41616	41616
S16T MCLN R/L 4	1.000	0.900	12.000	2.500	0.640	1.280	CN..43..	41626	41626
S20U MCLN R/L 4	1.250	1.118	14.000	3.000	0.765	1.530	CN..43..	42030	42030
A20U MCLN R/L 4	1.250	1.118	14.000	3.000	0.765	1.530	CN..43..	42020	42020
S24U MCLN R/L 4	1.500	1.370	14.000	3.000	0.890	1.780	CN..43..	42434	42434
A24U MCLN R/L 4	1.500	1.370	14.000	3.000	0.890	1.780	CN..43..	42424	42424
S28U MCLN R/L 4	1.750	1.630	14.000	4.000	1.015	2.030	CN..43..	42838	42838
A28U MCLN R/L 4	1.750	1.630	14.000	4.000	1.015	2.030	CN..43..	42828	42828
S32V MCLN R/L 4	2.000	1.870	16.000	4.000	1.281	2.562	CN..43..	43242	43242
S40V MCLN R/L 4	2.500	2.380	16.000	4.000	1.531	3.062	CN..43..	44050	44050
S32V MCLN R/L 5	2.000	1.870	16.000	4.000	1.281	2.562	CN..54..	53242	53242
A32V MCLN R/L 5	2.000	1.870	16.000	4.000	1.281	2.562	CN..54..	53233	53233
S40V MCLN R/L 5	2.500	2.380	16.000	4.000	1.531	3.062	CN..54..	54050	54050
A32V MCLN R/L 6	2.000	1.870	16.000	4.000	1.281	2.562	CN..64..	63233	63233
S32V MCLN R/L 6	2.000	1.870	16.000	4.000	1.281	2.562	CN..64..	63242	63242
S40V MCLN R/L 6	2.500	2.380	16.000	4.000	1.531	3.062	CN..64..	64050	64050

4

	Clamp	Key I	Dowel pin	Clamping screw	Carbide type C
	78 950 ...	78 950 ...	78 950 ...	78 950 ...	78 950 ...
Spare parts for Article no.					
78 704 41616 / 78 705 41616	00400	06900	03000	03700	
78 704 41626 / 78 705 41626	00400	06900	03000	03700	
78 704 42030 / 78 705 42030	00400	06900	03100	03800	00800
78 704 42020 / 78 705 42020	00400	06900	03100	03800	00800
78 704 42434 / 78 705 42434	00400	06900	03100	03800	00800
78 704 42424 / 78 705 42424	00400	06900	03100	03800	00800
78 704 42838 / 78 705 42838	00400	06900	03100	03800	00800
78 704 42828 / 78 705 42828	00400	06900	03100	03800	00800
78 704 43242 / 78 705 43242	00400	06900	03100	03800	00800
78 704 44050 / 78 705 44050	00400	06900	03100	03800	00800
78 704 53242 / 78 705 53242	00300	08100	03200	03900	04100
78 704 53233 / 78 705 53233	00300	08100	03200	03900	04100
78 704 54050 / 78 705 54050	00300	08100	03200	03900	04100
78 704 63233 / 78 705 63233	00300	08100	03300	03900	00900
78 704 63242 / 78 705 63242	00300	08100	03300	03900	00900
78 704 64050 / 78 705 64050	00300	08100	03300	03900	00900

DNMG / DNMA / DNMM

Designation	L inch	S inch	D1 inch	IC inch
DNMG 33..	0.457	0.187	0.150	0.375
DNM. 43..	0.610	0.187	0.203	0.500
DNM. 44..	0.610	0.250	0.203	0.500

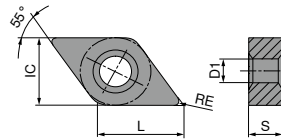

DNMG

		-CF TCM10	-CF20 CTEP110	-TFQ CTEP110	-F50 CTCP115	-F50 CTCP125	-F50 CTCP135	-TFQ CTCP115
		DRAGONSKIN	DRAGONSKIN	DRAGONSKIN	DRAGONSKIN	DRAGONSKIN	DRAGONSKIN	DRAGONSKIN
		F	F	F	F	F	F	F
		CERMET DNMG	CERMET DNMG	CERMET DNMG	DNMG	DNMG	DNMG	DNMG
		70 155 ...	76 102 ...	76 153 ...	76 134 ...	76 134 ...	76 134 ...	76 153 ...
ANSI	RE inch							
33.5EN	0.008							
331EN	0.016	904			302	502		702
332EN	0.031		004		304	504		704
333EN	0.047		006		306	506		706
					308	508		708
431EN	0.016							
432EN	0.031				316	516		716
433EN	0.047				318	518		718
					320	520		720
441EN	0.016	914	028	028	328	528	728	32800
442EN	0.031		030	030	330	530	730	330
443EN	0.047		032		332	532	732	
P		●	●	●	●	●	●	●
M		○	○	○	○	○	○	○
K		○	○	○	○	○	○	○
N								
S								
H								
O								

DNMG

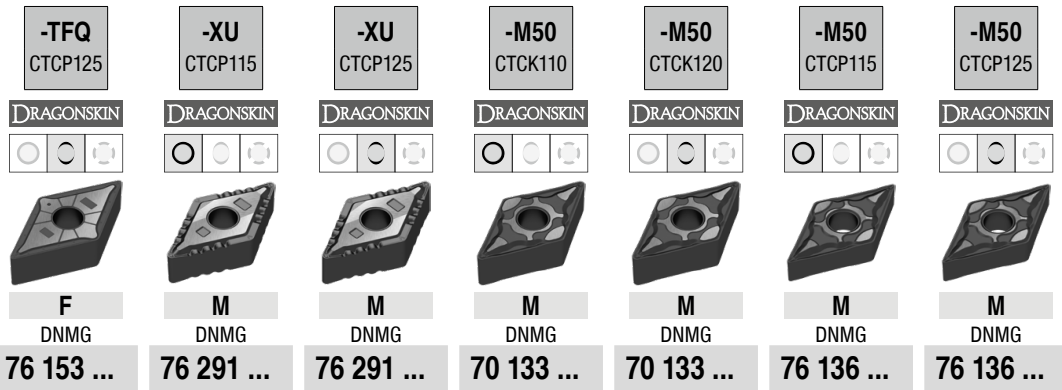

ANSI	RE inch	76 153 ...	76 291 ...	76 291 ...	70 133 ...	70 133 ...	76 136 ...	76 136 ...
331EN	0.016						304	504
332EN	0.031						306	506
333EN	0.047						308	508
431EN	0.016						316	514
432EN	0.031				018	518	318	518
433EN	0.047				020	520	320	516
434EN	0.063						322	522
441EN	0.016	528	328	528			328	528
442EN	0.031	530	330	530	030	530	330	530
443EN	0.047		332	532	032	532	332	532
444EN	0.063						334	534
P		●	●	●	○	○	●	●
M								
K		○	○	○	●	●	○	○
N								
S								
H								
O								

4

DNMG

		-M50 CTCP135	-TMQ CTCP125	-M70 CTCK110	-M70 CTCK120	-M70 CTCP115	-M70 CTCP125	-M70 CTCP135
		DRAGONSKIN	DRAGONSKIN	DRAGONSKIN	DRAGONSKIN	DRAGONSKIN	DRAGONSKIN	DRAGONSKIN
		M DNMG	M DNMG	M DNMG	M DNMG	M DNMG	M DNMG	M DNMG
		76 136 ...	76 197 ...	70 263 ...	70 263 ...	76 263 ...	76 263 ...	76 263 ...
ANSI	RE inch							
331EN	0.016	704						
332EN	0.031	706				306	506	706
333EN	0.047	708				308	508	708
431EN	0.016	716						
432EN	0.031	718		018	518	318	518	718
433EN	0.047	720		020	520	320	520	720
434EN	0.063	722				322	522	722
441EN	0.016	728						
442EN	0.031	730	530	030	530	330	530	730
443EN	0.047	732	532	032	532	332	532	732
444EN	0.063	734		034	534	334	534	734
P		●	●	○	○	●	●	●
M		○						○
K			○	●	●	○	○	
N								
S								
H								
O								

DNMA / DNMM

		CTCK110	CTCK120	-R28 CTCP115	-R28 CTCP125	-R28 CTCP135	-R58 CTCP115	-R58 CTCP125
		DRAGONSKIN	DRAGONSKIN	DRAGONSKIN	DRAGONSKIN	DRAGONSKIN	DRAGONSKIN	DRAGONSKIN
		R DNMA	R DNMA	R DNMM	R DNMM	R DNMM	R DNMM	R DNMM
		70 156 ...	70 156 ...	76 165 ...	76 165 ...	76 165 ...	76 166 ...	76 166 ...
ANSI	RE inch							
432EN	0.031	018	518					
433EN	0.047	020	520					
442EN	0.031	030	530					
443EN	0.047	032	532	332	532	732	332	532
444EN	0.063			334	534	734	334	534
P		○	○	●	●	●	●	●
M						○		
K		●	●	○	○		○	○
N								
S								
H								
O								

DNMM / DNMG

			NEW		NEW	NEW		NEW
		-R58 CTCP135	-F30 CTCM120	-F30 CTPM125	-F30 CTCM130	-M30 CTCM120	-M30 CTPM125	-M30 CTCM130
		DRAGONSKIN	DRAGONSKIN	DRAGONSKIN	DRAGONSKIN	DRAGONSKIN	DRAGONSKIN	DRAGONSKIN
		R	F	F	F	M	M	M
		DNMM	DNMG	DNMG	DNMG	DNMG	DNMG	DNMG
		76 166 ...	75 013 ...	75 013 ...	75 013 ...	75 014 ...	75 014 ...	75 014 ...
ANSI	RE inch							
331EN	0.016		10400	204	30400			
332EN	0.031		10600	206	30600	10600	206	30600
333EN	0.047					10800	208	30800
431EN	0.016		11600		31600			
432EN	0.031		11800		31800	11800		31800
433EN	0.047					12000		32000
441EN	0.016		12800	228	32800			
442EN	0.031		13000	230	33000	13000	230	33000
443EN	0.047	732				13200	232	33200
444EN	0.063	734						
P		●	○	○	○	○	○	○
M		○	●	●	●	●	●	●
K								
N								
S					○			○
H								
O								

4

DNMG

			NEW		NEW	NEW
			-M60 CTCM120	-M60 CTPM125	-M60 CTCM130	-M34 CTPX710
			DRAGONSKIN	DRAGONSKIN	DRAGONSKIN	DRAGONSKIN
			M	M	M	M
			DNMG	DNMG	DNMG	DNMG
			75 015 ...	75 015 ...	75 015 ...	75 004 ...
ANSI	RE inch					
431EN	0.016					61600
432EN	0.031		11800		31800	61800
433EN	0.047		12000		32000	62000
442EN	0.031		13000	230	33000	63000
443EN	0.047		13200	232	33200	63200
P			○	○	○	●
M			●	●	●	●
K						
N						○
S					○	●
H						
O						

DNMG

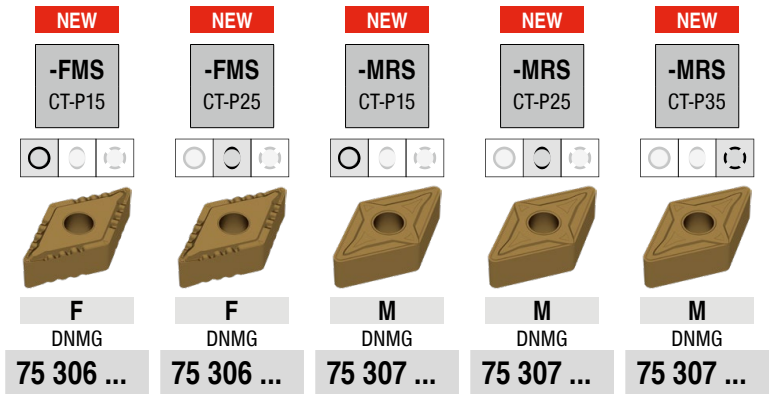

ANSI	RE inch	75 306 ...	75 306 ...	75 307 ...	75 307 ...	75 307 ...
431EN	0.016	01609	11609			
432EN	0.031	01809	11809	01809	11809	
441EN	0.016	02809	12809			
442EN	0.031	03009	13009	03009	13009	23009
443EN	0.047	03209	13209	03209	13209	23209
444EN	0.063			03409	13409	23409
P		●	●	●	●	●
M		○	○	○	○	○
K						
N						
S						
H						
O						

DNGA

Designation	L inch	S inch	D1 inch	IC inch
DNGA 43..	0.610	0.187	0.203	0.500
DNGA 44..	0.610	0.250	0.203	0.500

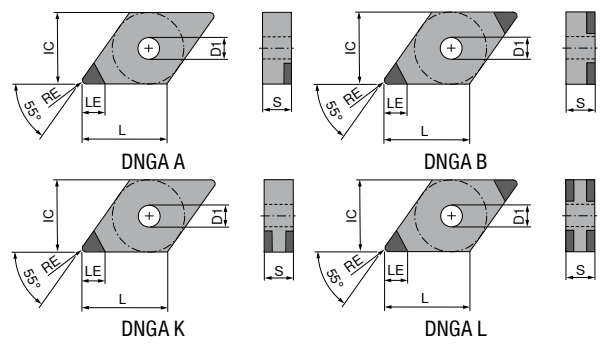

DNGA

▲ TCE(NOI) = Design and number of equipped cutting edge corners

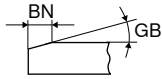

NEW	NEW		NEW	NEW
CTBS20U	CTBS20C	CTBS20C	CTBH15C	CTBH20U
F	F	F	F	F
CBN	CBN	CBN	CBN	CBN
DNGA	DNGA	DNGA	DNGA	DNGA
71 410 ...	71 411 ...	71 403 ...	71 017 ...	71 410 ...
441SN 0.016 0.004 10° L (4) 0.110				
431FN 0.016 A (1) 0.138				
441FN 0.016 A (1) 0.138				40000
441SN 0.016 0.004 15° L (4) 0.110				40400
441TN 0.016 0.004 15° A (1) 0.138	20000			
441SN 0.016 0.004 15° B (2) 0.110				
441SN 0.016 0.004 20° L (4) 0.110			32814	
431SN 0.016 0.004 20° L (4) 0.110				
441SN 0.016 0.004 20° K (2) 0.110				
441TN 0.016 0.005 20° A (1) 0.138	20000			
431TN 0.016 0.005 20° A (1) 0.138				40500
441SN 0.016 0.006 25° B (2) 0.110				40100
441SN 0.016 0.007 30° L (4) 0.110			32829	
			182	
442SN 0.031 0.004 10° L (4) 0.102				
432FN 0.031 A (1) 0.118				
442FN 0.031 A (1) 0.118				40200
442TN 0.031 0.004 15° A (1) 0.118	20100			40600
442SN 0.031 0.004 15° L (4) 0.102				
442TN 0.031 0.004 15° A (1) 0.197	20200			
442SN 0.031 0.004 15° K (2) 0.102		20100		
442SN 0.031 0.004 15° B (2) 0.102				
442SN 0.031 0.004 20° L (4) 0.102				
432SN 0.031 0.004 20° L (4) 0.102			33014	
442TN 0.031 0.005 20° A (1) 0.118				
432TN 0.031 0.005 20° A (1) 0.118				40700
442SN 0.031 0.006 25° B (2) 0.102				40300
442SN 0.031 0.006 25° K (2) 0.102	20200		33029	
442SN 0.031 0.007 30° L (4) 0.102				
			184	
443SN 0.047 0.004 15° B (2) 0.110				
443SN 0.047 0.006 25° B (2) 0.110			33214	
			33229	

P				
M				
K		•	•	•
N				
S		•	•	•
H				•
O				•

DNGA

▲ TCE(NOI) = Design and number of equipped cutting edge corners

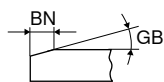

	CTBH20C	CTBH20C	NEW CTBH40U	CTBH40C	CTBH40C
	F	F	F	F	F
	CBN DNGA	CBN DNGA	CBN DNGA	CBN DNGA	CBN DNGA
	71 402 ...	71 403 ...	71 410 ...	71 402 ...	71 403 ...
ANSI	RE	BN	GB	TCE (NOI)	LE
	inch	inch			inch
441FN	0.016			A (1)	0.138
441SN	0.016	0.004	20°	L (4)	0.110
441SN	0.016	0.004	25°	L (4)	0.110
441SN	0.016	0.006	30°	L (4)	0.110
431SN	0.016	0.004	20°	L (4)	0.110
431SN	0.016	0.004	20°	L (4)	0.110
431SN	0.016	0.004	25°	L (4)	0.110
441SN	0.016	0.006	35°	L (4)	0.110
441SN	0.016	0.004	25°	K (2)	0.110
441SN	0.016	0.006	35°	K (2)	0.110
441SN	0.016	0.004	20°	K (2)	0.110
431FN	0.016			A (1)	0.138
431TN	0.016	0.005	25°	A (1)	0.138
441TN	0.016	0.005	25°	A (1)	0.138
441SN	0.016	0.004	20°	L (4)	0.110
441SN	0.016	0.005	25°	L (4)	0.110
431TN	0.016	0.004	25°	L (4)	0.110
431SN	0.016	0.005	25°	L (4)	0.110
441FN	0.016			L (4)	0.110
441TN	0.016	0.004	25°	L (4)	0.110
441FN	0.016			K (2)	0.110
441TN	0.016	0.004	15°	K (2)	0.110
441TN	0.016	0.004	25°	K (2)	0.110
441SN	0.016	0.004	20°	K (2)	0.110
432FN	0.031			A (1)	0.118
442SN	0.031	0.004	20°	L (4)	0.102
442SN	0.031	0.004	25°	L (4)	0.102
442SN	0.031	0.005	25°	L (4)	0.102
442SN	0.031	0.006	30°	L (4)	0.102
432SN	0.031	0.004	20°	L (4)	0.102
432SN	0.031	0.004	25°	L (4)	0.102
432SN	0.031	0.006	30°	L (4)	0.102
442SN	0.031	0.004	20°	L (4)	0.102
442SN	0.031	0.006	35°	L (4)	0.102
442SN	0.031	0.004	25°	K (2)	0.102
442SN	0.031	0.006	35°	K (2)	0.102
442SN	0.031	0.004	20°	K (2)	0.102
432TN	0.031	0.005	25°	A (1)	0.118
442FN	0.031			A (1)	0.118
442TN	0.031	0.005	25°	A (1)	0.118
432FN	0.031			L (4)	0.102
432TN	0.031	0.004	25°	L (4)	0.102
442FN	0.031			L (4)	0.102
442TN	0.031	0.004	25°	L (4)	0.102
442FN	0.031			K (2)	0.102
442TN	0.031	0.004	15°	K (2)	0.102
442TN	0.031	0.004	25°	K (2)	0.102
442SN	0.031	0.005	25°	K (2)	0.102

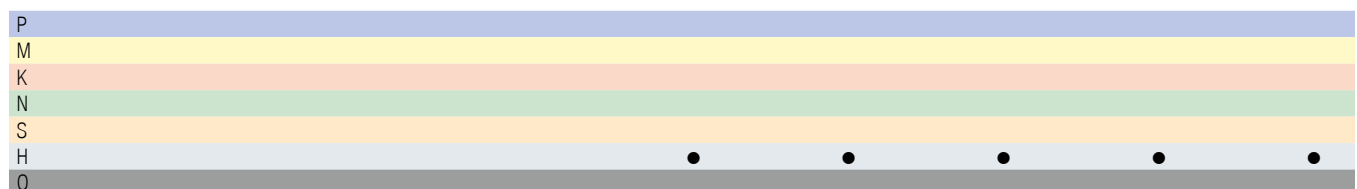

DNGA

Designation	L inch	S inch	D1 inch	IC inch
DNGA 43..	0.610	0.187	0.203	0.500
DNGA 44..	0.610	0.250	0.203	0.500

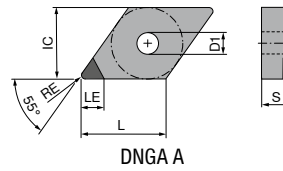

DNGA

▲ TCE(NOI) = Design and number of equipped cutting edge corners

NEW

CTDPD20

F
DIAMOND
DNGA
71 128 ...

ANSI	RE inch	TCE (NOI)	LE inch	
441FN	0.016	A (1)	0.252	10301
431FN	0.016	A (1)	0.252	10001
432FN	0.031	A (1)	0.236	10101
433FN	0.047	A (1)	0.220	10201
442FN	0.031	A (1)	0.236	10401
443FN	0.047	A (1)	0.220	10501
P				
M				
K				
N				•
S				
H				
O				•

4

MaxiLock-D – DDJN 93° – Toolholder with top clamping

▲ A... = with thru coolant

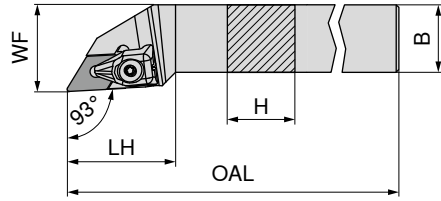

Illustrations show right-hand versions

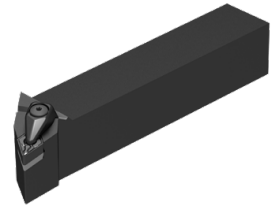

Designation	H inch	B inch	OAL inch	LH inch	WF inch	Insert	Left-hand	Right-hand
							78 503 ...	78 502 ...
DDJN R/L 12-4B-N	0.750	0.750	4.500	1.535	1.000	DN..43..	01293	01293
DDJN R/L 16-4D-N	1.000	1.000	6.000	1.535	1.250	DN..43..	01689	01689
DDJN R/L 16-4DA-N	1.000	1.000	6.000	1.535	1.250	DN..43..	01692	01692
DDJN R/L 20-4D-N	1.250	1.250	6.000	1.535	1.500	DN..43..	02089	02089
DDJN R/L 20-4DA-N	1.250	1.250	6.000	1.535	1.500	DN..43..	02092	02092
DDJN R/L 24-4EA-N	1.500	1.500	7.000	1.535	2.000	DN..43..	02488	02488
DDJN R/L 24-4E-N	1.500	1.500	7.000	1.535	2.000	DN..43..	02486	02486

Spare parts for Article no.

	78 950 ...	78 950 ...	78 950 ...	78 950 ...	78 950 ...	78 950 ...
78 502 01293 / 78 503 01293	07600	08100	08300	06700	08500	04900
78 502 01689 / 78 503 01689	07600	08100	08300	06700	08500	04900
78 502 01692 / 78 503 01692	07600	08100	08300	06700	08500	04900
78 502 02089 / 78 503 02089	07600	08100	08300	06700	08500	04900
78 502 02092 / 78 503 02092	07600	08100	08300	06700	08500	04900
78 502 02488 / 78 503 02488	07600	08100	08300	06700	08500	04900
78 502 02486 / 78 503 02486	07600	08100	08300	06700	08500	04900

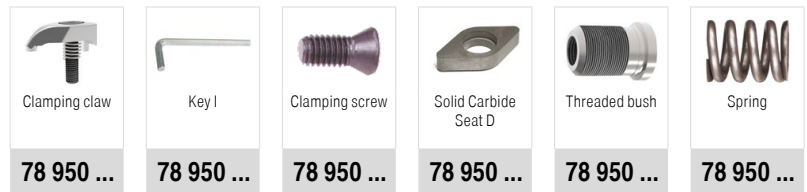

MaxiLock-M – MDJN 93° – Toolholder with top clamping

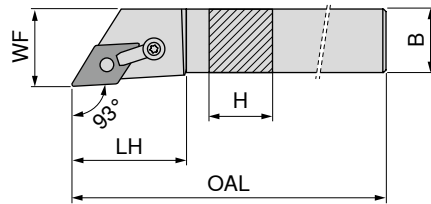

Illustrations show right-hand versions

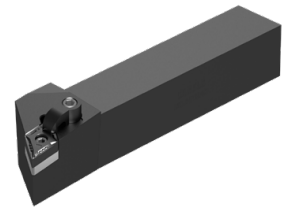

Designation	H	B	OAL	LH	WF	Insert
	inch	inch	inch	inch	inch	
MDJN R/L 08-3A	0.500	0.500	4.000	1.060	0.625	DN..33..
MDJN R/L 10-3B	0.625	0.625	4.500	1.250	0.875	DN..33..
MDJN R/L 12-4B	0.750	0.750	4.500	1.500	1.000	DN..43..
MDJN R/L 16-4D	1.000	1.000	6.000	1.500	1.250	DN..43..
MDJN R/L 20-4D	1.250	1.250	6.000	1.500	1.500	DN..43..
MDJN R/L 85-4D	1.250	1.000	6.000	1.500	1.250	DN..43..
MDJN R/L 24-4D	1.500	1.500	6.000	1.500	2.000	DN..43..

Left-hand 78 527 ...	Right-hand 78 526 ...
00813	00813
01023	01023
01224	01224
01644	01644
02044	02044
08544	08544
02444	02444

Clamp	Key I	Dowel pin	Clamping screw	Solid Carbide Seat D	
78 950 ...	78 950 ...	78 950 ...	78 950 ...	78 950 ...	
Spare parts for Article no.					
78 526 00813 / 78 527 00813	00700	06800	02700	03600	
78 526 01023 / 78 527 01023	00700	06800	02700	03600	
78 526 01224 / 78 527 01224	00400	06900	03100	03800	04200
78 526 01644 / 78 527 01644	00400	06900	03100	03800	04200
78 526 02044 / 78 527 02044	00400	06900	03100	03800	04200
78 526 08544 / 78 527 08544	00400	06900	03100	03800	04200
78 526 02444 / 78 527 02444	00400	06900	03100	03800	04200

MaxiLock-M – MDPN 62.5° – Toolholder with top clamping

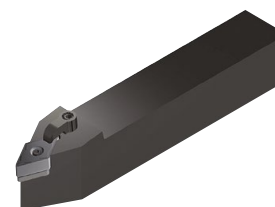
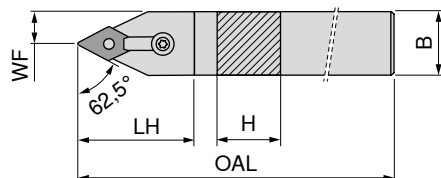

Neutral
78 576 ...

Designation	H inch	B inch	OAL inch	LH inch	WF inch	Insert
MDPN N 12-4B	0.750	0.750	4.500	1.620	0.375	DN..43..
MDPN N 16-4D	1.000	1.000	6.000	1.620	0.500	DN..43..
MDPN N 20-4D	1.250	1.250	6.000	1.620	0.625	DN..43..

01224
01644
02044

Clamp	Key I	Dowel pin	Clamping screw	Solid Carbide Seat D
78 950 ...	78 950 ...	78 950 ...	78 950 ...	78 950 ...
09000	06900	03100	03800	04200
09000	06900	03100	03800	04200
09000	06900	03100	03800	04200

Spare parts
for Article no.
78 576 01224
78 576 01644
78 576 02044

MaxiLock-M – MDQN 107.5° – Toolholder with top clamping

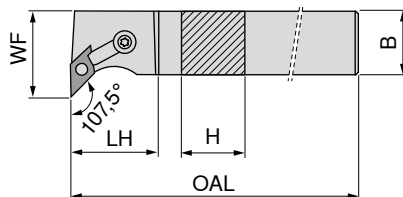

Illustrations show right-hand versions

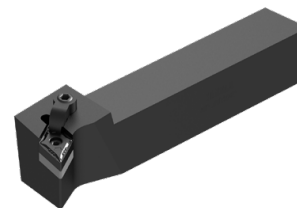

Left-hand **78 529 ...**
Right-hand **78 528 ...**

Designation	H inch	B inch	OAL inch	LH inch	WF inch	Insert
MDQN R/L 12-4B	0.750	0.750	4.500	1.370	1.000	DN..43..
MDQN R/L 16-4D	1.000	1.000	6.000	1.370	1.250	DN..43..
MDQN R/L 20-4D	1.250	1.250	6.000	1.370	1.500	DN..43..
MDQN R/L 24-4E	1.500	1.500	7.000	1.370	2.000	DN..43..

01293
01689
02089
02486

01293
01689
02089
02486

Clamp	Key I	Dowel pin	Clamping screw	Solid Carbide Seat D
78 950 ...	78 950 ...	78 950 ...	78 950 ...	78 950 ...
00400	06900	03100	03800	04200
00400	06900	03100	03800	04200
00400	06900	03100	03800	04200
00400	06900	03100	03800	04200

Spare parts
for Article no.
78 528 01293 / 78 529 01293
78 528 01689 / 78 529 01689
78 528 02089 / 78 529 02089
78 528 02486 / 78 529 02486

MaxiLock-D – DDUN 93° – Boring bar with top clamping

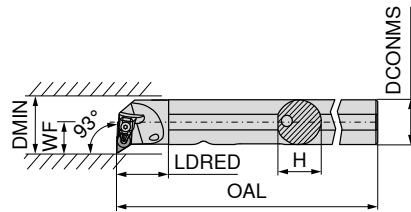

Illustrations show right-hand versions



Designation	DCONMS inch	H inch	OAL inch	LDRED inch	WF inch	DMIN inch	Insert	Left-hand	Right-hand
								78 703 ...	78 702 ...
S20U DDUN R/L 4N	1.250	1.118	14.000	1.771	0.765	1.530	DN..43..	42030	42030
S24U DDUN R/L 4N	1.500	1.370	14.000	1.968	0.890	1.780	DN..43..	42434	42434

**Spare parts
for Article no.**

	78 950 ...	78 950 ...	78 950 ...	78 950 ...	78 950 ...	78 950 ...
78 702 42030 / 78 703 42030	07600	08100	08300	04200	08500	04900
78 702 42434 / 78 703 42434	07600	08100	08300	04200	08500	04900

Clamping claw	Key I	Clamping screw	Solid Carbide Seat D	Threaded bush	Spring
78 950 ...	78 950 ...	78 950 ...	78 950 ...	78 950 ...	78 950 ...

MaxiLock-M – MDUL 93° – Boring bar with top clamping

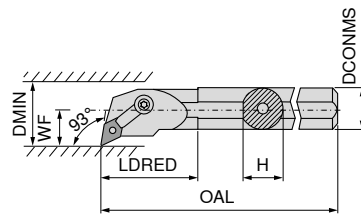

Illustrations show right-hand versions



Designation	DCONMS inch	H inch	OAL inch	LDRED inch	WF inch	DMIN inch	Insert	Left-hand	Right-hand
								78 707 ...	78 706 ...
S16T MDUN R/L 4	1.000	0.900	12.000	2.500	0.875	1.750	DN..43..	41626	41626
A16T MDUN R/L 4	1.000	0.900	12.000	2.500	0.875	1.750	DN..43..	41616	41616
S20U MDUN R/L 4	1.250	1.118	14.000	3.000	1.000	2.000	DN..43..	42030	42030
A20U MDUN R/L 4	1.250	1.118	14.000	3.000	1.000	2.000	DN..43..	42020	42020
S24U MDUN R/L 4	1.500	1.370	14.000	3.000	1.125	2.250	DN..43..	42434	42434
A24U MDUN R/L 4	1.500	1.370	14.000	3.000	1.125	2.250	DN..43..	42424	42424
S32V MDUN R/L 4	2.000	1.870	16.000	4.000	1.375	3.000	DN..43..	43242	43242
A32V MDUN R/L 4	2.000	1.870	16.000	4.000	1.375	3.000	DN..43..	43233	43233

	Clamp	Key I	Dowel pin	Clamping screw	Solid Carbide Seat D
	78 950 ...	78 950 ...	78 950 ...	78 950 ...	78 950 ...
Spare parts for Article no.					
78 706 41626 / 78 707 41626	00400	06900	03000	03700	
78 706 41616 / 78 707 41616	00400	06900	03000	03700	
78 706 42030 / 78 707 42030	00400	06900	03100	03800	04200
78 706 42020 / 78 707 42020	00400	06900	03100	03800	04200
78 706 42434 / 78 707 42434	00400	06900	03100	03800	04200
78 706 42424 / 78 707 42424	00400	06900	03100	03800	04200
78 706 43242 / 78 707 43242	00400	06900	03100	03800	04200
78 706 43233 / 78 707 43233	00400	06900	03100	03800	04200

SNMG / SNMA / SNMM

Designation	L inch	S inch	D1 inch	IC inch
SNMG 32..	0.375	0.125	0.150	0.375
SNM. 43..	0.500	0.187	0.203	0.500
SNM. 54..	0.625	0.250	0.250	0.625
SNM. 64..	0.750	0.250	0.313	0.750
SNMM 85..	1.000	0.313	0.359	1.000
SNMM 86..	1.000	0.375	0.359	1.000

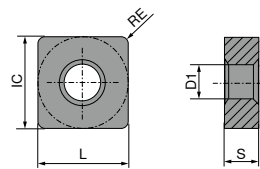

SNMG

		-F50 CTCP115	-F50 CTCP125	-F50 CTCP135	-M50 CTCP115	-M50 CTCP125	-M50 CTCP135	-M70 CTCK110
		DRAGONSKIN	DRAGONSKIN	DRAGONSKIN	DRAGONSKIN	DRAGONSKIN	DRAGONSKIN	DRAGONSKIN
		F SNMG	F SNMG	F SNMG	M SNMG	M SNMG	M SNMG	M SNMG
		76 140 ...	76 140 ...	76 140 ...	76 137 ...	76 137 ...	76 137 ...	70 225 ...
ANSI	RE inch							
322EN	0.031	306	506	706				
431EN	0.016	316	516	716				
432EN	0.031	318	518	718	318	518	718	018
433EN	0.047	320	520	720	320	520	720	020
434EN	0.063				322	522	722	022
542EN	0.031				330	530	730	
543EN	0.047				332	532	732	032
544EN	0.063				334	534	734	034
643EN	0.047							044
644EN	0.063							046
P		●	●	●	●	●	●	○
M				○			○	
K		○	○		○	○		●
N								
S								
H								
O								

4

SNMG / SNMA

		-M70 CTCK120	-M70 CTCP115	-M70 CTCP125	-M70 CTCP135	CTCP125	CTCP135	CTCK110
		DRAGONSKIN	DRAGONSKIN	DRAGONSKIN	DRAGONSKIN	DRAGONSKIN	DRAGONSKIN	DRAGONSKIN
		M	M	M	M	M	M	R
		SNMG	SNMG	SNMG	SNMG	SNMG	SNMG	SNMA
		70 225 ...	76 225 ...	76 225 ...	76 225 ...	76 116 ...	76 116 ...	70 114 ...
ANSI	RE inch							
322EN	0.031					506	706	
432EN	0.031	518	318	518	718			018
433EN	0.047	520	320	520	720			020
434EN	0.063	522	322	522	722			022
543EN	0.047	532	332	532	732			032
544EN	0.063	534	334	534	734			034
643EN	0.047	544	344	544	744			044
644EN	0.063	546	346	546	746			046
646EN	0.094		348	548	748			
P		○	●	●	●	●	●	○
M					○		○	
K		●	○	○		○		●
N								
S								
H								
O								

SNMA / SNMM

		CTCK120	-R28 CTCP115	-R28 CTCP125	-R28 CTCP135	-R58 CTCP115	-R58 CTCP125	-R58 CTCP135
		DRAGONSKIN	DRAGONSKIN	DRAGONSKIN	DRAGONSKIN	DRAGONSKIN	DRAGONSKIN	DRAGONSKIN
		R	R	R	R	R	R	R
		SNMA	SNMM	SNMM	SNMM	SNMM	SNMM	SNMM
		70 114 ...	76 128 ...	76 128 ...	76 128 ...	76 129 ...	76 129 ...	76 129 ...
ANSI	RE inch							
432EN	0.031	518				318	518	718
433EN	0.047	520				320	520	720
434EN	0.063	522						
543EN	0.047	532	332	532	732	332	532	732
544EN	0.063	534	334	534	734	334	534	734
643EN	0.047	544				344	544	744
644EN	0.063	546	346	546	746	346	546	746
646EN	0.094					348	548	748
856EN	0.094				760	360	560	760
866EN	0.094		370	570	770	370	570	770
P		○	●	●	●	●	●	●
M					○			○
K		●	○	○		○	○	
N								
S								
H								
O								

4

SNMM / SNMG

		-R88 CTCP115	-R88 CTCP125	-R88 CTCP135	NEW -F30 CTCM120	-F30 CTPM125	NEW -F30 CTCM130	NEW -M30 CTCM120
		R SNMM	R SNMM	R SNMM	F SNMG	F SNMG	F SNMG	M SNMG
		76 130 ...	76 130 ...	76 130 ...	75 016 ...	75 016 ...	75 016 ...	75 017 ...
ANSI	RE inch							
431EN	0.016				11600	216	31600	
432EN	0.031				11800	218	31800	11800
433EN	0.047							12000
644SN	0.063	346	546	746				
646SN	0.094	348	548	748				
856SN	0.094	36000	56000	760				
866SN	0.094	37000	57000	770				
P		●	●	●	○	○	○	○
M					●	●	●	●
K		○	○					
N								
S							○	
H								
O								

SNMG

		-M30 CTPM125	NEW -M30 CTCM130	NEW -M60 CTCM120	-M60 CTPM125	NEW -M60 CTCM130	NEW -M34 CTPX710
		M SNMG	M SNMG	M SNMG	M SNMG	M SNMG	M SNMG
		75 017 ...	75 017 ...	75 018 ...	75 018 ...	75 018 ...	75 005 ...
ANSI	RE inch						
432EN	0.031		218	31800	11800	218	31800
433EN	0.047			32000	12000	210	32000
434EN	0.063				12200	220	32200
P			○	○	○	○	○
M		●	●	●	●	●	●
K							
N							○
S			○				○
H							●
O							

MaxiLock-D – DSDN 45° – Toolholder with top clamping

▲ A... = with thru coolant

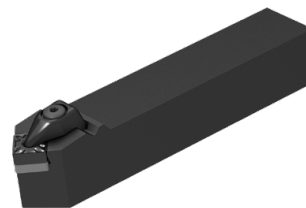
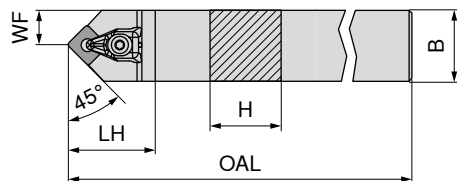

Neutral
78 574 ...

Designation	H inch	B inch	OAL inch	LH inch	WF inch	Insert	
DSDN N 12-4BA-N	0.750	0.750	4.500	1.380	0.375	SN..43..	01224
DSDN N 20-6DA-N	1.250	1.250	6.000	1.535	0.625	SN..64..	02081
DSDN N 24-6EA-N	1.500	1.500	7.000	1.650	0.750	SN..64..	02479

Clamping claw	Key I	Clamping screw	Solid Carbide support S	Threaded bush	Spring
78 950 ...	78 950 ...	78 950 ...	78 950 ...	78 950 ...	78 950 ...

Spare parts
for Article no.

78 574 01224	07600	08100	08300	08900	08500	04900
78 574 02081	07800	08100	08300	01700	08700	04900
78 574 02479	07800	08100	08300	01700	08700	04900

4

MaxiLock-D – DSSN 45° – Toolholder with top clamping

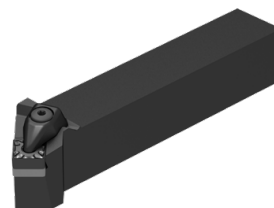
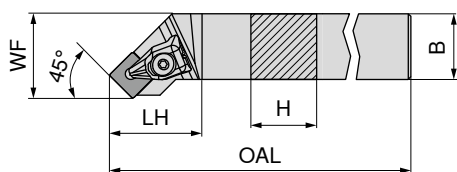

Illustrations show right-hand versions

Left-hand **78 507 ...** Right-hand **78 506 ...**

Designation	H inch	B inch	OAL inch	LH inch	WF inch	Insert		
DSSN R/L 12-4B-N	0.750	0.750	4.500	1.457	1.000	SN..43..	01293	01293
DSSN R/L 16-4D-N	1.000	1.000	6.000	1.457	1.250	SN..43..	01689	01689
DSSN R/L 20-4D-N	1.250	1.250	6.000	1.457	1.500	SN..43..	02089	02089
DSSN R/L 20-6D-N	1.250	1.250	6.000	1.772	1.500	SN..64..	02080	02080
DSSN R/L 24-6E-N	1.500	1.500	7.000	1.772	2.000	SN..64..	02477	02477

Clamping claw	Key I	Clamping screw	Solid Carbide support S	Threaded bush	Spring
78 950 ...	78 950 ...	78 950 ...	78 950 ...	78 950 ...	78 950 ...

Spare parts
for Article no.

78 506 01293 / 78 507 01293	07600	08100	08300	08900	08500	04900
78 506 01689 / 78 507 01689	07600	08100	08300	08900	08500	04900
78 506 02089 / 78 507 02089	07600	08100	08300	08900	08500	04900
78 506 02080 / 78 507 02080	07800	08100	08300	01700	08700	04900
78 506 02477 / 78 507 02477	07800	08100	08300	01700	08700	04900

MaxiLock-D – DSRN 75° – Toolholder with top clamping

▲ A... = with thru coolant

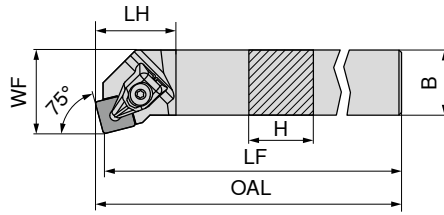

Illustrations show right-hand versions

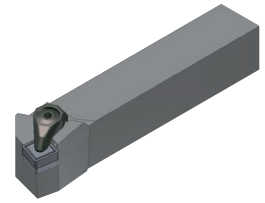

Designation	H inch	B inch	OAL inch	LH inch	WF inch	Insert
DSRN R/L 12-4BA-N	0.750	0.750	4.500	1.380	0.880	SN..43..
DSRN R/L 16-4DA-N	1.000	1.000	6.000	1.380	1.130	SN..43..
DSRN R/L 20-5DA-N	1.250	1.250	6.000	1.380	1.353	SN..54..
DSRN R/L 20-6DA-N	1.250	1.250	6.000	1.380	1.321	SN..64..

Left-hand 78 505 ...	Right-hand 78 504 ...
01294	01294
01690	01690
02085	02085
02081	02081

Clamping claw	Key I	Clamping screw	Solid Carbide support S	Threaded bush	Spring
78 950 ...	78 950 ...	78 950 ...	78 950 ...	78 950 ...	78 950 ...

**Spare parts
for Article no.**



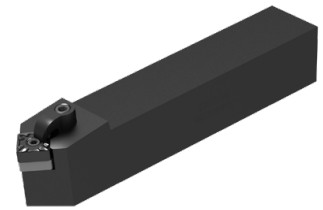
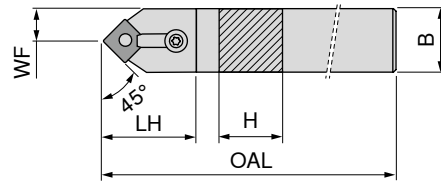

78 504 01294 / 78 505 01294	07600	08100	08300	08900	08500	04900
78 504 01690 / 78 505 01690	07600	08100	08300	08900	08500	04900
78 504 02085 / 78 505 02085	07700	08100	08300	01600	08600	04900
78 504 02081 / 78 505 02081	07800	08100	08300	01700	08700	04900

MaxiLock-M – MSDN 45° – Toolholder with top clamping



Neutral
78 577 ...

Designation	H inch	B inch	OAL inch	LH inch	WF inch	Insert	
MSDN N 08-3A	0.500	0.500	4.000	1.000	0.250	SN..32..	00813
MSDN N 10-3B	0.625	0.625	4.500	1.000	0.313	SN..32..	01023
MSDN N 12-4B	0.750	0.750	4.500	1.300	0.375	SN..43..	01224
MSDN N 16-4D	1.000	1.000	6.000	1.300	0.500	SN..43..	01644
MSDN N 85-4D	1.250	1.000	6.000	1.300	0.625	SN..43..	08544
MSDN N 16-5D	1.000	1.000	6.000	1.500	0.500	SN..54..	01645
MSDN N 85-5D	1.250	1.000	6.000	1.500	0.625	SN..54..	08545
MSDN N 20-5D	1.250	1.250	6.000	1.500	0.625	SN..54..	02045
MSDN N 16-6D	1.000	1.000	6.000	1.730	0.500	SN..64..	01646
MSDN N 85-6D	1.250	1.000	6.000	1.750	0.625	SN..64..	08546
MSDN N 20-6D	1.250	1.250	6.000	1.750	0.625	SN..64..	02046
MSDN N 24-6E	1.500	1.500	7.000	1.750	0.750	SN..64..	02456

				
Clamp	Key I	Dowel pin	Clamping screw	Solid Carbide support S
78 950 ...	78 950 ...	78 950 ...	78 950 ...	78 950 ...

Spare parts for Article no.	78 950 ...	78 950 ...	78 950 ...	78 950 ...	78 950 ...
78 577 00813	00600	07000	02800	03600	01500
78 577 01023	00600	07000	02800	03600	01500
78 577 01224	00400	06900	03100	03800	04300
78 577 01644	00400	06900	03100	03800	04300
78 577 08544	00400	06900	03100	03800	04300
78 577 01645	00300	08100	03200	03900	01600
78 577 08545	00300	08100	03200	03900	01600
78 577 02045	00300	08100	03200	03900	01600
78 577 01646	00300	08100	03300	03900	01700
78 577 08546	00300	08100	03300	03900	01700
78 577 02046	00300	08100	03300	03900	01700
78 577 02456	00300	08100	03300	03900	01700

MaxiLock-M – MSKN 75° – Toolholder with top clamping

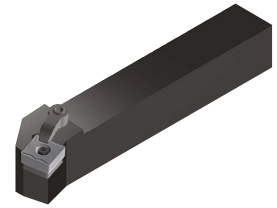
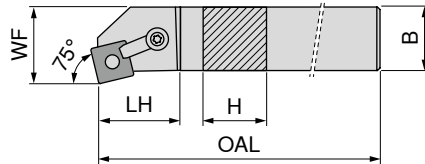

Illustrations show right-hand versions

Designation	H	B	OAL	LH	WF	Insert
	inch	inch	inch	inch	inch	
MSKN R/L 12-4B	0.750	0.750	4.500	1.220	1.000	SN..43..
MSKN R/L 16-4D	1.000	1.000	6.000	1.220	1.250	SN..43..
MSKN R/L 16-5D	1.000	1.000	6.000	1.410	1.250	SN..54..
MSKN R/L 85-5D	1.250	1.000	6.000	1.410	1.250	SN..54..
MSKN R/L 20-5D	1.250	1.250	6.000	1.410	1.500	SN..54..
MSKN R/L 20-6D	1.250	1.250	6.000	1.500	1.500	SN..64..
MSKN R/L 24-6E	1.500	1.500	7.000	1.500	2.000	SN..64..

Left-hand 78 533 ...	Right-hand 78 532 ...
01224	01224
01644	01644
01645	01645
08545	08545
02045	02045
02046	02046
02456	02456

Clamp	Key I	Dowel pin	Clamping screw	Solid Carbide support S
78 950 ...	78 950 ...	78 950 ...	78 950 ...	78 950 ...

**Spare parts
for Article no.**

78 532 01224 / 78 533 01224	00400	06900	03100	03800	04300
78 532 01644 / 78 533 01644	00400	06900	03100	03800	04300
78 532 01645 / 78 533 01645	00300	08100	03200	03900	01600
78 532 08545 / 78 533 08545	00300	08100	03200	03900	01600
78 532 02045 / 78 533 02045	00300	08100	03200	03900	01600
78 532 02046 / 78 533 02046	00300	08100	03300	03900	01700
78 532 02456 / 78 533 02456	00300	08100	03300	03900	01700

MaxiLock-M – MSRN 75° – Toolholder with top clamping

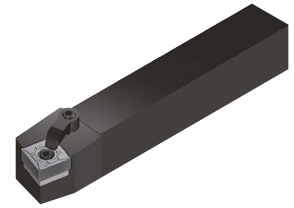
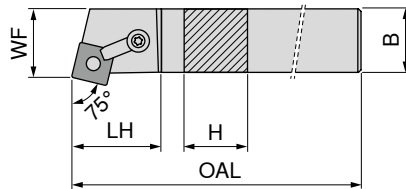

Illustrations show right-hand versions

Designation	H inch	B inch	OAL inch	LH inch	WF inch	Insert	Left-hand	Right-hand
							78 535 ...	78 534 ...
MSRN R/L 12-4B	0.750	0.750	4.500	1.250	0.880	SN..43..	01224	01224
MSRN R/L 16-4D	1.000	1.000	6.000	1.250	1.130	SN..43..	01644	01644
MSRN R/L 16-5D	1.000	1.000	6.000	1.500	1.103	SN..54..	01645	01645
MSRN R/L 20-5D	1.250	1.250	6.000	1.500	1.353	SN..54..	02045	02045
MSRN R/L 20-6D	1.250	1.250	6.000	1.590	1.321	SN..64..	02046	02046
MSRN R/L 24-6E	1.500	1.500	7.000	1.590	1.821	SN..64..	02456	02456

**Spare parts
for Article no.**

	Clamp 78 950 ...	Key I 78 950 ...	Dowel pin 78 950 ...	Clamping screw 78 950 ...	Solid Carbide support S 78 950 ...
78 534 01224 / 78 535 01224	00400	06900	03100	03800	04300
78 534 01644 / 78 535 01644	00400	06900	03100	03800	04300
78 534 01645 / 78 535 01645	00300	08100	03200	03900	01600
78 534 02045 / 78 535 02045	00300	08100	03200	03900	01600
78 534 02046 / 78 535 02046	00300	08100	03300	03900	01700
78 534 02456 / 78 535 02456	00300	08100	03300	03900	01700

MaxiLock-M – MSSN 45° – Toolholder with top clamping

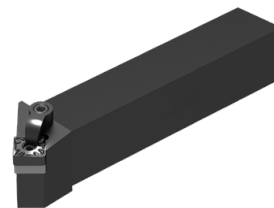
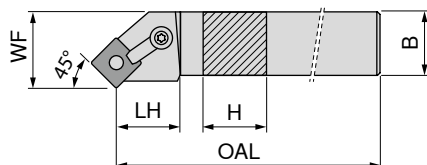

Illustrations show right-hand versions

Designation	H inch	B inch	OAL inch	LH inch	WF inch	Insert
MSSN R/L 12-4B	0.750	0.750	4.500	1.230	0.675	SN..43..
MSSN R/L 16-4D	1.000	1.000	6.000	1.230	0.925	SN..43..
MSSN R/L 16-5D	1.000	1.000	6.000	1.380	0.847	SN..54..
MSSN R/L 20-5D	1.250	1.250	6.000	1.380	1.097	SN..54..
MSSN R/L 20-6D	1.250	1.250	6.000	1.470	1.010	SN..64..
MSSN R/L 24-6E	1.500	1.500	7.000	1.470	1.511	SN..64..
MSSN R/L 86-6E	1.500	1.000	7.000	1.470	0.761	SN..64..

Left-hand 78 537 ...	Right-hand 78 536 ...
01224	01224
01644	01644
01645	01645
02045	02045
02046	02046
02456	02456
08656	08656

Spare parts for Article no.

Article no.	Clamp	Key I	Dowel pin	Clamping screw	Solid Carbide support S
78 536 01224 / 78 537 01224	00400	06900	03100	03800	04300
78 536 01644 / 78 537 01644	00400	06900	03100	03800	04300
78 536 01645 / 78 537 01645	00300	08100	03200	03900	01600
78 536 02045 / 78 537 02045	00300	08100	03200	03900	01600
78 536 02046 / 78 537 02046	00300	08100	03300	03900	01700
78 536 02456 / 78 537 02456	00300	08100	03300	03900	01700
78 536 08656 / 78 537 08656	00300	08100	03300	03900	01700

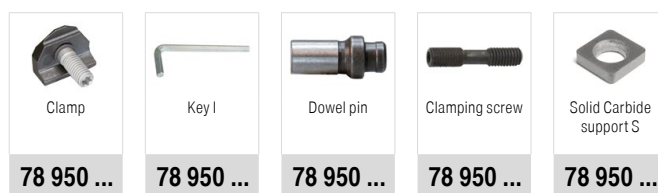

MaxiLock-M – MSKN 75° – Boring bar with top clamping

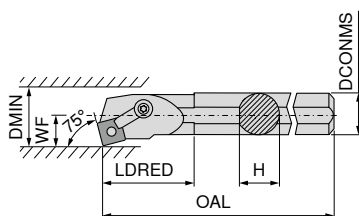

Illustrations show right-hand versions

Designation	H inch	OAL inch	LDRED inch	WF inch	Insert
S20U MSKN R/L 4	1.180	14.000	3.000	0.765	SN..43..
S24U MSKN R/L 4	1.370	14.000	3.000	0.890	SN..43..
S32V MSKN R/L 5	1.870	16.000	4.000	1.281	SN..54..
S32V MSKN R/L 6	1.870	16.000	4.000	1.281	SN..64..
S40V MSKN R/L 6	2.380	16.000	4.000	1.531	SN..64..

Left-hand 78 709 ...	Right-hand 78 708 ...
42030	42030
42434	42434
53242	53242
63242	63242
64050	64050

Spare parts for Article no.

Article no.	Clamp	Key I	Dowel pin	Clamping screw	Solid Carbide support S
78 708 42030 / 78 709 42030	00400	06900	03100	03800	04300
78 708 42434 / 78 709 42434	00400	06900	03100	03800	04300
78 708 53242 / 78 709 53242	00300	08100	03200	03900	01600
78 708 63242 / 78 709 63242	00300	08100	03300	03900	01700
78 708 64050 / 78 709 64050	00300	08100	03300	03900	01700

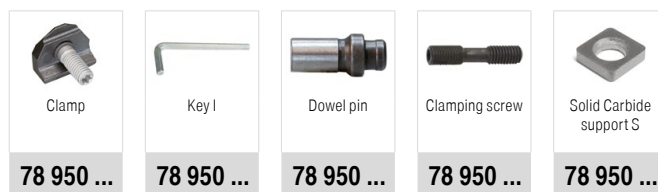

TNMG / TNMA / TNMM

Designation	L inch	S inch	D1 inch	IC inch
TNMG 22..	0.433	0.125	0.089	0.250
TNM. 33..	0.650	0.187	0.150	0.375
TNM. 43..	0.866	0.187	0.203	0.500

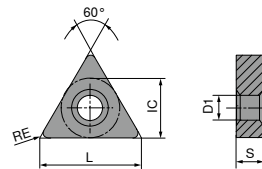

TNMG

		-CF20 CTCP110	-F50 CTCP115	-F50 CTCP125	-F50 CTCP135	-M50 CTCP115	-M50 CTCP125	-M50 CTCP135
		DRAGONSKIN	DRAGONSKIN	DRAGONSKIN	DRAGONSKIN	DRAGONSKIN	DRAGONSKIN	DRAGONSKIN
		F	F	F	F	M	M	M
		CERMET TNMG	TNMG	TNMG	TNMG	TNMG	TNMG	TNMG
		76 149 ...	76 146 ...	76 146 ...	76 146 ...	76 138 ...	76 138 ...	76 138 ...
ANSI	RE inch							
221EN	0.016		304	504	704			
222EN	0.031		306	506	706			
331EN	0.016	016	316	516	716	316	516	716
332EN	0.031	018	318	518	718	318	518	718
333EN	0.047	020	320	520	720	320	520	720
432EN	0.031					330	530	730
433EN	0.047					332	532	732
P		●	●	●	●	●	●	●
M		○			○			○
K		○	○	○		○	○	○
N								
S								
H								
O								

4

TNMG

		-M70 CTCK110	-M70 CTCK120	-M70 CTCP115	-M70 CTCP125	-M70 CTCP135	CTCP125	CTCP135
		M TNMG	M TNMG	M TNMG	M TNMG	M TNMG	M TNMG	M TNMG
		70 155 ...	70 155 ...	76 155 ...	76 155 ...	76 155 ...	76 142 ...	76 142 ...
ANSI	RE inch							
22.5EN	0.008							702
331ER	0.016						516	716
332EL	0.031						518	
332EN	0.031	018	518	318	518	718		717
332ER	0.031						517	
333EN	0.047	020	520	320	520	720		
431EN	0.016				528			
432EN	0.031	030	530	330	530	730		
433EN	0.047	032	532	332	532	732		
434EN	0.063	034	534	334	534	734		
P		○	○	●	●	●	●	●
M						○		○
K		●	●	○	○		○	
N								
S								
H								
O								

TNMA / TNMM

		CTCK110	CTCK120	-R28 CTCP115	-R28 CTCP125	-R28 CTCP135	-R58 CTCP115	-R58 CTCP125
		R TNMA	M TNMA	R TNMM	R TNMM	R TNMM	R TNMM	R TNMM
		70 134 ...	70 134 ...	76 154 ...	76 154 ...	76 154 ...	76 152 ...	76 152 ...
ANSI	RE inch							
332EN	0.031	018	518					
333EN	0.047	020	520					
334EN	0.063	022	522					
432EN	0.031	030	530					
433EN	0.047	032	532				332	532
434EN	0.063	034	534	334	534	734		
P		○	○	●	●	●	●	●
M						○		
K		●	●	○	○		○	○
N								
S								
H								
O								

TNMM / TNMG

ANSI	RE inch	-R58 CTCP135	NEW -F30 CTCM120	-F30 CTPM125	NEW -F30 CTCM130	NEW -M30 CTCM120	-M30 CTPM125	NEW -M30 CTCM130
		DRAGONSKIN	DRAGONSKIN	DRAGONSKIN	DRAGONSKIN	DRAGONSKIN	DRAGONSKIN	DRAGONSKIN
		R TNMM	F TNMG	F TNMG	F TNMG	M TNMG	M TNMG	M TNMG
		76 152 ...	75 019 ...	75 019 ...	75 019 ...	75 020 ...	75 020 ...	75 020 ...
331EN	0.016		11600	216	31600			
332EN	0.031		11800	218	31800	11800	218	31800
333EN	0.047					12000	220	32000
433EN	0.047	732						
P		●	○	○	○	○	○	○
M		○	●	●	●	●	●	●
K								
N								
S					○			○
H								
O								

4

TNMG

ANSI	RE inch	NEW -M60 CTCM120	-M60 CTPM125	NEW -M60 CTCM130	NEW -M34 CTPX710
		DRAGONSKIN	DRAGONSKIN	DRAGONSKIN	DRAGONSKIN
		M TNMG	M TNMG	M TNMG	M TNMG
		75 021 ...	75 021 ...	75 021 ...	75 006 ...
332EN	0.031	11800	218	31800	61800
333EN	0.047	12000	220	32000	
431EN	0.016				62800
432EN	0.031				63000
434EN	0.063				63400
P		○	○	○	●
M		●	●	●	●
K					
N					○
S				○	●
H					
O					

TNGA

Designation	L inch	S inch	D1 inch	IC inch
TNGA 22..	0.433	0.125	0.089	0.250
TNGA 33..	0.650	0.187	0.150	0.375

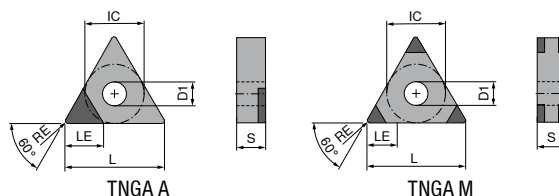

TNGA

▲ TCE(NOI) = Design and number of equipped cutting edge corners



	CTBH20U	CTBH20C	CTBH40U	CTBH40C
	F	F	F	F
	CBN	CBN	CBN	CBN
	TNGA	TNGA	TNGA	TNGA
	71 108 ...	71 404 ...	71 108 ...	71 404 ...
221TN	500			
222FN			802 ¹⁾	
222TN	502			
331FN	404 ¹⁾		804 ¹⁾	
331SN		242		332
331SN				342
331SN				352
331SN				372
331SN				382
331TN			904	
331FN		212		
331TN		222		
331TN		252		
331SN		262		
331TN	504			
332TN		224		
332SN				324
332TN		234		
332SN				334
332SN		244		344
332TN	506			
332SN		254		
332TN			906	
332EN				314
332FN	406 ¹⁾		80500	
332FN		214		
332SN		264		364
332SN		27200		374
332SN				384
333TN		226		
333SN				336
333SN		246		346
333SN				356
333TN		256		
333FN		216		
333SN		266		366
333SN				376
333SN				386

P				
M				
K				
N				
S				
H		•	•	•
O				

1) Machining to 60 HRC

MaxiLock-D – DTJN 93° – Toolholder with top clamping

▲ A... = with thru coolant

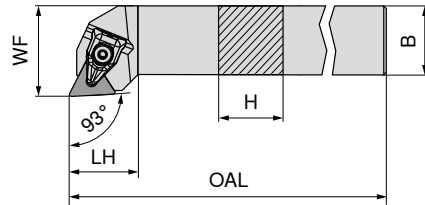

Illustrations show right-hand versions

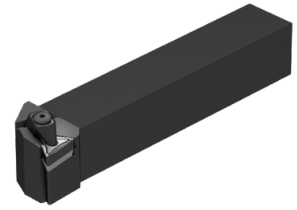

Designation	H inch	B inch	OAL inch	LH inch	WF inch	Insert
DTJN R/L 16-3DA-N	1.000	1.000	6.000	1.250	1.250	TN..33..
DTJN R/L 16-4DA-N	1.000	1.000	6.000	1.380	1.250	TN..43..
DTJN R/L 20-4DA-N	1.250	1.250	6.000	1.250	1.500	TN..43..
DTJN R/L 24-4EA-N	1.500	1.500	7.000	1.380	2.000	TN..43..

Left-hand 78 511 ...	Right-hand 78 510 ...
01698	01698
01690	01690
02090	02090
02487	02487

78 950 ...	78 950 ...	78 950 ...	78 950 ...	78 950 ...	78 950 ...

Spare parts for Article no.

78 510 01698 / 78 511 01698	07500	08100	07900	07400	08400	08000
78 510 01690 / 78 511 01690	07600	08100	08300	01900	08500	04900
78 510 02090 / 78 511 02090	07600	08100	08300	01900	08500	04900
78 510 02487 / 78 511 02487	07600	08100	08300	01900	08500	04900

MaxiLock-D – DTGN 90° – Toolholder with top clamping

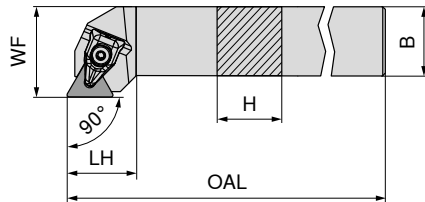

Illustrations show right-hand versions

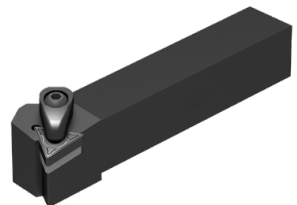

Designation	H inch	B inch	OAL inch	LH inch	WF inch	Insert
DTGN R/L 12-3B-N	0.750	0.750	4.500	1.100	1.000	TN..33..
DTGN R/L 16-3D-N	1.000	1.000	6.000	1.100	1.250	TN..33..
DTGN R/L 16-4D-N	1.000	1.000	6.000	1.338	1.250	TN..43..
DTGN R/L 20-4D-N	1.250	1.250	6.000	1.338	1.500	TN..43..

Left-hand 78 509 ...	Right-hand 78 508 ...
01299	01299
01697	01697
01689	01689
02089	02089

78 950 ...	78 950 ...	78 950 ...	78 950 ...	78 950 ...	78 950 ...

Spare parts for Article no.

78 508 01299 / 78 509 01299	07500	08100	07900	07400	08400	08000
78 508 01697 / 78 509 01697	07500	08100	07900	07400	08400	08000
78 508 01689 / 78 509 01689	07600	08100	08300	01900	08500	04900
78 508 02089 / 78 509 02089	07600	08100	08300	01900	08500	04900

MaxiLock-M – MTAN 90° – Toolholder with top clamping

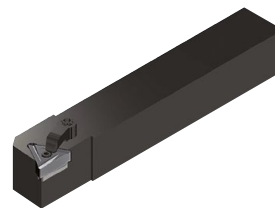
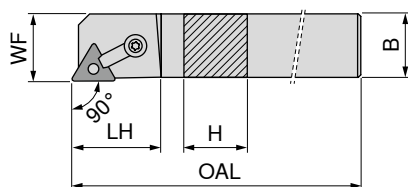

Illustrations show right-hand versions

Designation	H	B	OAL	LH	WF	Insert
	inch	inch	inch	inch	inch	
MTAN R/L 08-2A	0.500	0.500	4.000	0.875	0.500	TN..22..
MTAN R/L 12-3B	0.750	0.750	4.500	1.060	0.750	TN..33..
MTAN R/L 16-3D	1.000	1.000	6.000	1.060	1.000	TN..33..
MTAN R/L 16-4D	1.000	1.000	6.000	1.220	1.000	TN..43..

Left-hand	Right-hand
78 539 ...	78 538 ...
00812	00812
01223	01223
01643	01643
01644	01644

Spare parts for Article no.

Article no.	Clamp	Key I	Dowel pin	Clamping screw	Solid Carbide Seat T
78 538 00812 / 78 539 00812	00700	07000	02500	05000	
78 538 01223 / 78 539 01223	00400	06900	02900	03800	01800
78 538 01643 / 78 539 01643	00400	06900	02900	03800	01800
78 538 01644 / 78 539 01644	00400	06900	03100	03800	01900

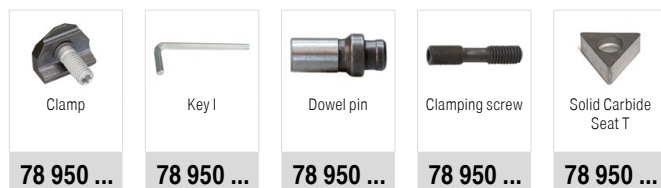

MaxiLock-M – MTCN 90° – Toolholder with top clamping

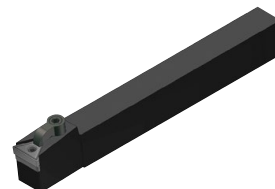
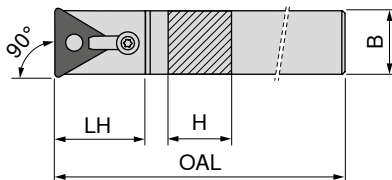

Designation	H	B	OAL	LH	WF	Insert
	inch	inch	inch	inch	inch	
MTCN N 44-3F	1.000	0.500	8.000	1.000	0.325	TN..33..
MTCN N 12-4B	0.750	0.750	4.500	1.380	0.433	TN..43..
MTCN N 64-4F	1.000	0.750	8.000	1.380	0.433	TN..43..
MTCN N 66-4F	1.500	0.750	8.000	1.380	0.433	TN..43..

Neutral
78 578 ...

Spare parts for Article no.

Article no.	Clamp	Key I	Dowel pin	Clamping screw	Solid Carbide Seat T
78 578 04463	00400	06800	02900	04000	01800
78 578 01224	00400	07000	03100	03800	01900
78 578 06464	00300	07000	03100	03900	01900
78 578 06664	00300	07000	03100	03900	01900

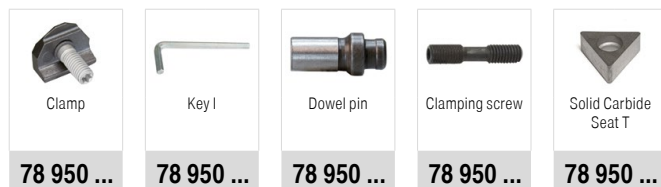

MaxiLock-M – MTEN 60° – Toolholder with top clamping

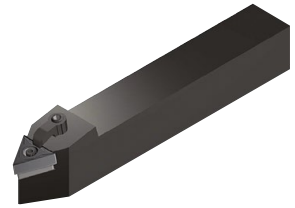
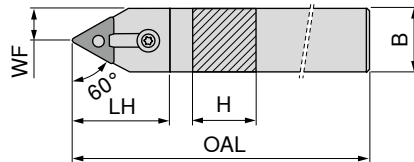

Neutral
78 580 ...

Designation	H inch	B inch	OAL inch	LH inch	WF inch	Insert	
MTEN NS 08-2A	0.500	0.500	4.000	1.000	0.250	TN..22..	00812
MTEN NS 10-3B	0.625	0.625	4.500	1.130	0.313	TN..33..	01023
MTEN NS 12-3B	0.750	0.750	4.500	1.300	0.375	TN..33..	01223
MTEN NS 16-3D	1.000	1.000	6.000	1.300	0.500	TN..33..	01643
MTEN NS 16-4D	1.000	1.000	6.000	1.500	0.500	TN..43..	01644

	Clamp	Key I	Dowel pin	Clamping screw	Solid Carbide Seat T
	78 950 ...	78 950 ...	78 950 ...	78 950 ...	78 950 ...
Spare parts for Article no.					
78 580 00812	00700	07000	02500	05000	
78 580 01023	00600	06800	02900	03600	01800
78 580 01223	00400	06800	02900	03800	01800
78 580 01643	00400	06800	02900	03800	01800
78 580 01644	00400	07000	03100	03800	01900

MaxiLock-M – MTFN 90° – Toolholder with top clamping

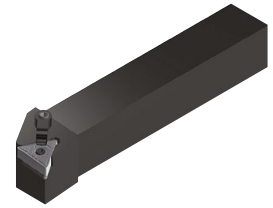
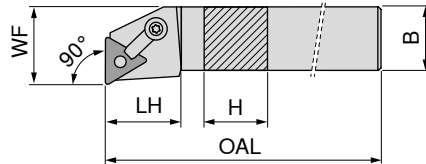

Illustrations show right-hand versions

Designation	H inch	B inch	OAL inch	LH inch	WF inch	Insert	Left-hand	Right-hand
							78 541 ...	78 540 ...
MTFN R/L 12-3B	0.750	0.750	4.500	1.000	1.000	TN..33..	01223	01223
MTFN R/L 16-3D	1.000	1.000	6.000	1.250	1.250	TN..33..	01643	01643
MTFN R/L 16-4D	1.000	1.000	6.000	1.250	1.250	TN..43..	01644	01644
MTFN R/L 20-4D	1.250	1.250	6.000	1.500	1.500	TN..43..	02044	02044
MTFN R/L 85-4D	1.250	1.000	6.000	1.250	1.250	TN..43..	08544	08544
MTFN R/L 86-4D	1.500	1.000	6.000	1.250	1.250	TN..43..	08644	08644

**Spare parts
for Article no.**

	78 950 ...	78 950 ...	78 950 ...	78 950 ...	78 950 ...
78 540 01223 / 78 541 01223	00400	06800	02900	03800	01800
78 540 01643 / 78 541 01643	00400	06800	02900	03800	01800
78 540 01644 / 78 541 01644	00400	07000	03100	03800	01900
78 540 02044 / 78 541 02044	00400	07000	03100	03800	01900
78 540 08544 / 78 541 08544	00400	07000	03100	03800	01900
78 540 08644 / 78 541 08644	00400	07000	03100	03800	01900

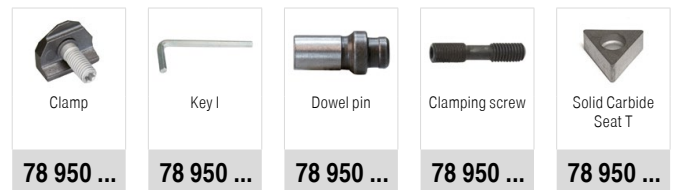

MaxiLock-M – MTGN 90° – Toolholder with top clamping

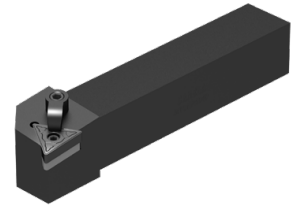
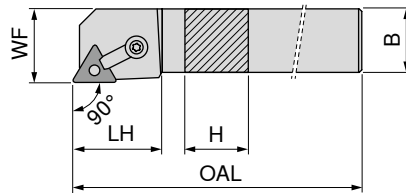

Illustrations show right-hand versions

Designation	H inch	B inch	OAL inch	LH inch	WF inch	Insert	Left-hand		Right-hand	
							78 543 ...	78 542 ...	78 543 ...	78 542 ...
MTGN R/L 08-2A	0.500	0.500	4.000	0.875	0.625	TN..22..	00812		00812	
MTGN R/L 10-3B	0.625	0.625	4.500	1.000	0.875	TN..33..	01023		01023	
MTGN R/L 12-3B	0.750	0.750	4.500	1.060	1.000	TN..33..	01223		01223	
MTGN R/L 16-3D	1.000	1.000	6.000	1.060	1.250	TN..33..	01643		01643	
MTGN R/L 16-4D	1.000	1.000	6.000	1.220	1.250	TN..43..	01644		01644	
MTGN R/L 20-4D	1.250	1.250	6.000	1.220	1.500	TN..43..	02044		02044	
MTGN R/L 85-4D	1.250	1.000	6.000	1.220	1.250	TN..43..	08544		08544	
MTGN R/L 86-4D	1.500	1.000	6.000	1.220	1.250	TN..43..	08644		08644	

**Spare parts
for Article no.**

	78 950 ...	78 950 ...	78 950 ...	78 950 ...	78 950 ...
78 542 00812 / 78 543 00812	00700	07000	02500	05000	
78 542 01023 / 78 543 01023	00400	06800	02900	03800	01800
78 542 01223 / 78 543 01223	00400	06800	02900	03800	01800
78 542 01643 / 78 543 01643	00400	06800	02900	03800	01800
78 542 01644 / 78 543 01644	00400	07000	03100	03800	01900
78 542 02044 / 78 543 02044	00400	07000	03100	03800	01900
78 542 08544 / 78 543 08544	00400	07000	03100	03800	01900
78 542 08644 / 78 543 08644	00400	07000	03100	03800	01900

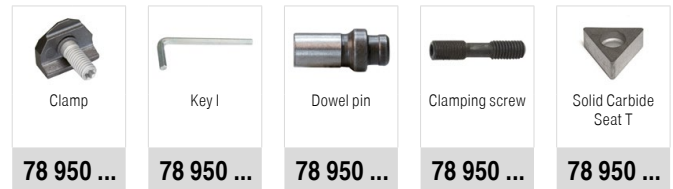

MaxiLock-M – MTJN 93° – Toolholder with top clamping

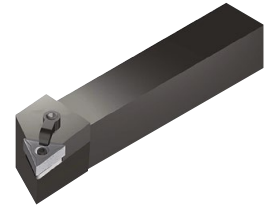
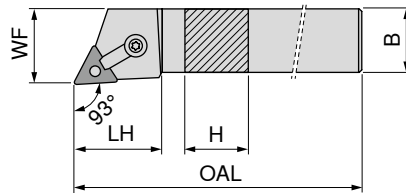

Illustrations show right-hand versions

Designation	H	B	OAL	LH	WF	Insert
	inch	inch	inch	inch	inch	
MTJN R/L 12-3B	0.750	0.750	4.500	1.030	1.000	TN..33..
MTJN R/L 16-3D	1.000	1.000	6.000	1.030	1.250	TN..33..
MTJN R/L 16-4D	1.000	1.000	6.000	1.250	1.250	TN..43..
MTJN R/L 20-4D	1.250	1.250	6.000	1.250	1.500	TN..43..

Left-hand	Right-hand
78 545 ...	78 544 ...
01223	01223
01643	01643
01644	01644
02044	02044

Clamp	Key I	Dowel pin	Clamping screw	Solid Carbide Seat T
78 950 ...	78 950 ...	78 950 ...	78 950 ...	78 950 ...

Spare parts for Article no.

78 544 01223 / 78 545 01223	00400	06800	02900	03800	01800
78 544 01643 / 78 545 01643	00400	06800	02900	03800	01800
78 544 01644 / 78 545 01644	00400	07000	03100	03800	01900
78 544 02044 / 78 545 02044	00400	07000	03100	03800	01900

MaxiLock-M – MTRN 75° – Toolholder with top clamping

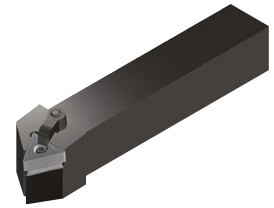
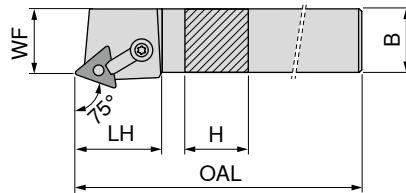

Illustrations show right-hand versions

Designation	H inch	B inch	OAL inch	LH inch	WF inch	Insert	Left-hand 78 547 ...		Right-hand 78 546 ...	
							MTRN R/L 12-3B	0.750	0.750	4.500
MTRN R/L 16-3D	1.000	1.000	6.000	1.160	1.105	TN..33..	01643	01643	01643	01643
MTRN R/L 16-4D	1.000	1.000	6.000	1.380	1.048	TN..43..	01644	01644	01644	01644
MTRN R/L 20-4D	1.250	1.250	6.000	1.380	1.298	TN..43..	02044	02044	02044	02044

	Clamp	Key I	Dowel pin	Clamping screw	Solid Carbide Seat T
	78 950 ...	78 950 ...	78 950 ...	78 950 ...	78 950 ...
Spare parts for Article no.					
78 546 01223 / 78 547 01223	00400	06800	02900	03800	01800
78 546 01643 / 78 547 01643	00400	06800	02900	03800	01800
78 546 01644 / 78 547 01644	00400	07000	03100	03800	01900
78 546 02044 / 78 547 02044	00400	07000	03100	03800	01900

MaxiLock-M – MTFN 90° – Boring bar with top clamping

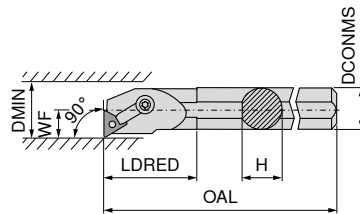

Illustrations show right-hand versions

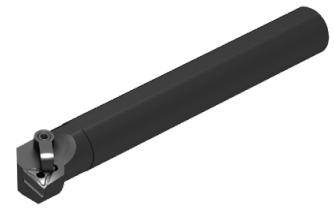

Designation	DCONMS inch	H inch	OAL inch	LDRED inch	WF inch	DMIN inch	Insert	Left-hand	Right-hand
								78 711 ...	78 710 ...
A16T MTFN R/L 3	1.000	0.900	12.000	2.500	0.640	1.280	TN..33..	31616	31616
S16T MTFN R/L 3	1.000	0.900	12.000	2.500	0.640	1.280	TN..33..	31626	31626
S20U MTFN R/L 3	1.250	1.180	14.000	3.000	0.765	1.530	TN..33..	32030	32030
A20U MTFN R/L 3	1.250	1.180	14.000	3.000	0.765	1.530	TN..33..	32020	32020
S24U MTFN R/L 3	1.500	1.370	14.000	3.000	0.890	1.780	TN..33..	32434	32434
S20U MTFN R/L 4	1.250	1.180	14.000	3.000	0.765	1.530	TN..43..	42030	42030
S24U MTFN R/L 4	1.500	1.370	14.000	3.000	0.890	1.780	TN..43..	42434	42434
A24U MTFN R/L 4	1.500	1.370	14.000	3.000	0.890	1.780	TN..43..	42424	42424
S28U MTFN R/L 4	1.750	1.630	14.000	4.000	1.015	2.030	TN..43..	42838	42838
A28U MTFN R/L 4	1.750	1.630	14.000	4.000	1.015	2.030	TN..43..	42828	42828
S32V MTFN R/L 4	2.000	1.870	16.000	4.000	1.281	2.562	TN..43..	43242	43242
A32V MTFN R/L 4	2.000	1.870	16.000	4.000	1.281	2.562	TN..43..	43233	43233
S40V MTFN R/L 4	2.500	2.380	16.000	4.000	1.531	3.062	TN..43..	44050	44050

Clamp	Key I	Dowel pin	Clamping screw	Solid Carbide Seat T
78 950 ...	78 950 ...	78 950 ...	78 950 ...	78 950 ...
00400	06800	02700	03700	
00400	06800	02700	03700	
00400	06800	02900	03800	01800
00400	06800	02900	03800	01800
00400	06800	02900	03800	01800
00400	06900	03100	03800	01900
00400	06900	03100	03800	01900
00400	06900	03100	03800	01900
00400	06900	03100	03800	01900
00400	06900	03100	03800	01900
00400	06900	03100	03800	01900
00400	06900	03100	03800	01900

**Spare parts
for Article no.**

78 710 31616 / 78 711 31616	00400	06800	02700	03700	
78 710 31626 / 78 711 31626	00400	06800	02700	03700	
78 710 32030 / 78 711 32030	00400	06800	02900	03800	01800
78 710 32020 / 78 711 32020	00400	06800	02900	03800	01800
78 710 32434 / 78 711 32434	00400	06800	02900	03800	01800
78 710 42030 / 78 711 42030	00400	06900	03100	03800	01900
78 710 42434 / 78 711 42434	00400	06900	03100	03800	01900
78 710 42424 / 78 711 42424	00400	06900	03100	03800	01900
78 710 42838 / 78 711 42838	00400	06900	03100	03800	01900
78 710 42828 / 78 711 42828	00400	06900	03100	03800	01900
78 710 43242 / 78 711 43242	00400	06900	03100	03800	01900
78 710 43233 / 78 711 43233	00400	06900	03100	03800	01900
78 710 44050 / 78 711 44050	00400	06900	03100	03800	01900

MaxiLock-M – MTUN 93° – Boring bar with top clamping

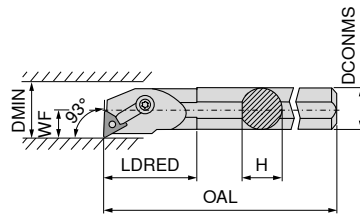

Illustrations show right-hand versions

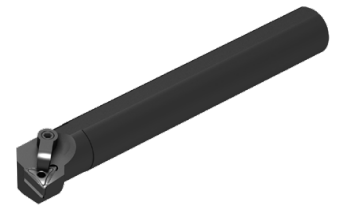

Designation	DCONMS inch	H inch	OAL inch	LDRED inch	WF inch	DMIN inch	Insert	Left-hand		Right-hand	
								78 713 ...	78 712 ...	78 713 ...	78 712 ...
S16T MTUN R/L 3	1.000	0.900	12.000	2.500	0.640	1.280	TN..33..	31626	31626	31626	31626
S24U MTUN R/L 4	1.500	1.370	14.000	3.000	0.890	1.780	TN..43..	42434	42434	42434	42434

Image	Part Name	78 950 ...	78 950 ...	78 950 ...	78 950 ...
	Clamp	78 950 ...	78 950 ...	78 950 ...	78 950 ...
	Key I	00400	06800	02700	03700
	Dowel pin	00400	06900	03100	03800
	Clamping screw				

**Spare parts
for Article no.**

78 712 31626 / 78 713 31626
78 712 42434 / 78 713 42434

VNMG

Designation	L inch	S inch	D1 inch	IC inch
VNMG 33..	0.654	0.187	0.150	0.375

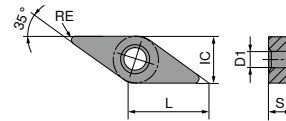







VNMG

		-F40 CTCP125	-F50 CTCP115	-F50 CTCP125	-F50 CTCP135	-XU CTCP115	-XU CTCP125	-M40 CTCP125				
		DRAGONSKIN										
		F VNMG	F VNMG	F VNMG	F VNMG	M VNMG	M VNMG	M VNMG				
		76 000 ...	76 156 ...	76 156 ...	76 156 ...	76 294 ...	76 294 ...	76 001 ...				
ANSI	RE inch			516	316	516	716	316	516	316	516	518
331EN	0.016			518	318	518	718	318	518	518	518	
332EN	0.031											
P		●	●	●	●	●	●	●	●	●	●	
M							○					
K		○	○	○	○	○	○	○	○	○	○	
N												
S												
H												
O												

VNMG

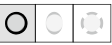
		-M50 CTCK120	-M50 CTCP115	-M50 CTCP125	NEW -F30 CTCM120	-F30 CTPM125	NEW -F30 CTCM130	NEW -M30 CTCM120
		DRAGONSKIN						
		M VNMG	M VNMG	M VNMG	F VNMG	F VNMG	F VNMG	M VNMG
		70 131 ...	76 131 ...	76 131 ...	75 022 ...	75 022 ...	75 022 ...	75 023 ...
ANSI	RE inch			516	11600	216	31600	11800
331EN	0.016			518	11800	218	31800	11800
332EN	0.031			520				
333EN	0.047							
P		○	●	●	○	○	○	○
M					●	●	●	●
K		●	○	○				
N								
S							○	
H								
O								

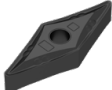
VNMG

	NEW	NEW
-M30 CTPM125	-M30 CTCM130	-M34 CTPX710
DRAGONSKIN	DRAGONSKIN	DRAGONSKIN
		
		
M VNMG	M VNMG	M VNMG
75 023 ...	75 023 ...	75 009 ...
218	31800	61600 61800 62000

ANSI	RE inch
331EN	0.016
332EN	0.031
333EN	0.047

P	○	○	●
M	●	●	●
K			
N			○
S		○	●
H			
O			

4

VNMG

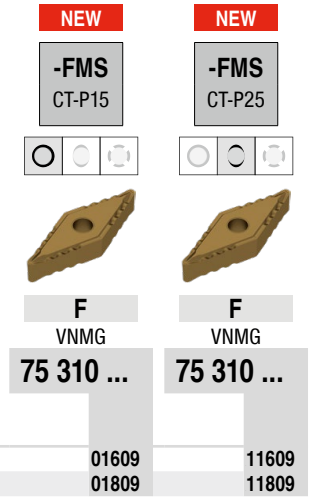

ANSI	RE inch		
331EN	0.016		
332EN	0.031		
P		●	●
M		○	○
K			
N			
S			
H			
O			

VNGA

Designation	L inch	S inch	D1 inch	IC inch
VNGA 33..	0.654	0.187	0.150	0.375

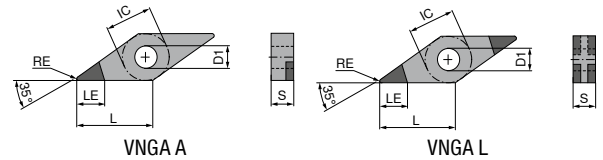

VNGA

▲ TCE(NOI) = Design and number of equipped cutting edge corners

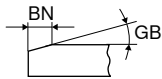

NEW	NEW	NEW
CTBH20C	CTBH40U	CTBH40C
F CBN VNGA	F CBN VNGA	F CBN VNGA
71 413 ...	71 412 ...	71 413 ...
	50000	60000
		60100
		60200
		60300
		60400
30000	50100	
30100		
30200		
		60500
30400		60600
		60700
30500	50300	
30600		60800
		60900
	50200	61000
30300		

ANSI	RE inch	BN inch	GB	TCE (NOI)	LE inch
331FN	0.016			A (1)	0.197
331SN	0.016	0.004	20°	L (4)	0.110
331SN	0.016	0.004	25°	L (4)	0.110
331SN	0.016	0.005	25°	L (4)	0.110
331SN	0.016	0.006	30°	L (4)	0.110
331SN	0.016	0.006	35°	L (4)	0.110
331TN	0.016	0.005	25°	A (1)	0.197
331FN	0.016			L (4)	0.110
331SN	0.016	0.004	20°	L (4)	0.110
331TN	0.016	0.004	25°	L (4)	0.110
332SN	0.031	0.004	15°	L (4)	0.087
332SN	0.031	0.004	20°	L (4)	0.087
332SN	0.031	0.004	25°	L (4)	0.087
332TN	0.031	0.004	25°	L (4)	0.087
332TN	0.031	0.005	25°	A (1)	0.173
332SN	0.031	0.005	25°	L (4)	0.087
332SN	0.031	0.006	30°	L (4)	0.087
332SN	0.031	0.006	35°	L (4)	0.087
332FN	0.031			A (1)	0.173
332FN	0.031			L (4)	0.087

P			
M			
K			
N			
S			
H			
O			

4

MaxiLock-D – DVJN 93° – Toolholder with top clamping

▲ A... = with thru coolant

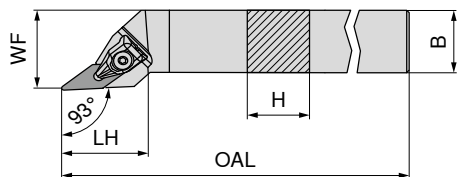

Illustrations show right-hand versions

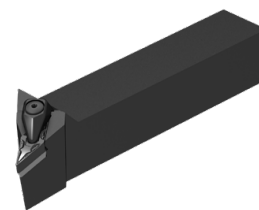

Designation	H inch	B inch	OAL inch	LH inch	WF inch	Insert	Left-hand		Right-hand	
							78 513 ...	78 512 ...	78 513 ...	78 512 ...
DVJN R/L 20-3DA-N	1.250	1.250	6.000	1.750	1.500	VN..33..	02098		02098	
DVJN R/L 24-3EA-N	1.500	1.500	7.000	1.750	2.000	VN..33..	02495		02495	

Spare parts for Article no.

Article no.	78 950 ...	78 950 ...	78 950 ...	78 950 ...	78 950 ...	78 950 ...
78 512 02098 / 78 513 02098	07500	08100	07900	02200	08400	08000
78 512 02495 / 78 513 02495	07500	08100	07900	02200	08400	08000

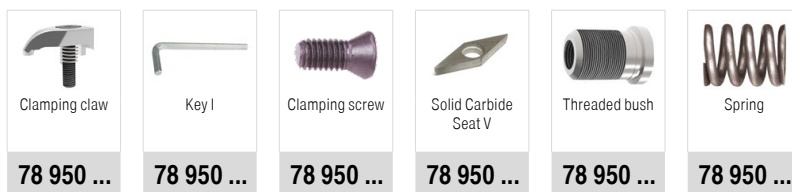

MaxiLock-M – MVJN 93° – Toolholder with top clamping

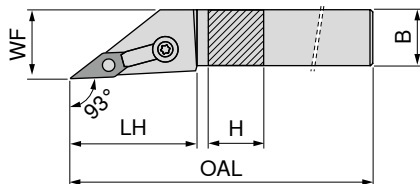

Illustrations show right-hand versions

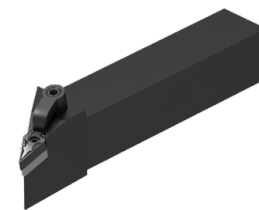

Designation	H inch	B inch	OAL inch	LH inch	WF inch	Insert	Left-hand		Right-hand	
							78 549 ...	78 548 ...	78 549 ...	78 548 ...
MVJN R/L 12-3B	0.750	0.750	4.500	1.620	1.000	VN..33..	01223		01223	
MVJN R/L 16-3D	1.000	1.000	6.000	1.620	1.250	VN..33..	01643		01643	
MVJN R/L 20-3D	1.250	1.250	6.000	1.620	1.500	VN..33..	02043		02043	

Spare parts for Article no.

Article no.	78 950 ...	78 950 ...	78 950 ...	78 950 ...	78 950 ...
78 548 01223 / 78 549 01223	09000	06800	02900	03800	02200
78 548 01643 / 78 549 01643	09000	06800	02900	03800	02200
78 548 02043 / 78 549 02043	09000	06800	02900	03800	02200

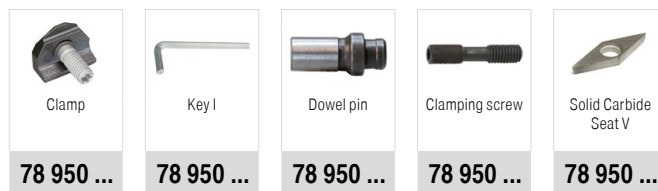

MaxiLock-M – MVVN 72.5° – Toolholder with top clamping

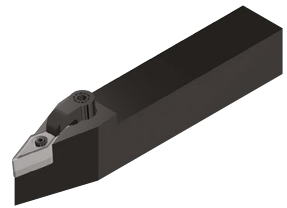
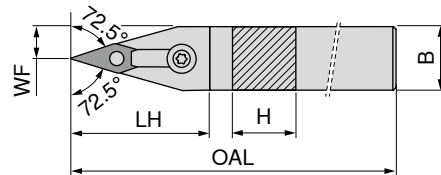

Neutral
78 581 ...

Designation	H inch	B inch	OAL inch	LH inch	WF inch	Insert	
MVVN N 12-3B	0.750	0.750	4.500	1.620	0.375	VN..33..	01223
MVVN N 16-3B	1.000	1.000	4.500	1.620	0.500	VN..33..	01623
MVVN N 20-3D	1.250	1.250	6.000	1.620	0.625	VN..33..	02043
MVVN N 24-3E	1.500	1.500	7.000	1.620	0.750	VN..33..	02453

Image	Part Name	Article No.
	Clamp	78 950 ...
	Key I	78 950 ...
	Dowel pin	78 950 ...
	Clamping screw	78 950 ...
	Solid Carbide Seat V	78 950 ...

Spare parts for Article no.	Clamp	Key I	Dowel pin	Clamping screw	Solid Carbide Seat V
78 581 01223	09000	06800	02900	03800	02200
78 581 01623	09000	06800	02900	03800	02200
78 581 02043	09000	06800	02900	03800	02200
78 581 02453	09000	06800	02900	03800	02200

MaxiLock-M – MVUN 93° – Boring bar with top clamping

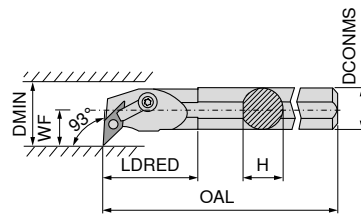

Illustrations show right-hand versions



Designation	DCONMS inch	H inch	OAL inch	LDRED inch	WF inch	DMIN inch	Insert	Left-hand	Right-hand
								78 715 ...	78 714 ...
A16T MVUN R/L 3	1.000	0.900	12.000	2.500	1.000	2.000	VN..33..	31616	31616
S16T MVUN R/L 3	1.000	0.900	12.000	2.500	1.000	2.000	VN..33..	31626	31626
A20U MVUN R/L 3	1.250	1.180	14.000	3.000	1.125	2.250	VN..33..	32020	32020
S20U MVUN R/L 3	1.250	1.180	14.000	3.000	1.125	2.250	VN..33..	32030	32030
S24U MVUN R/L 3	1.500	1.370	14.000	3.000	1.250	2.500	VN..33..	32434	32434
A24U MVUN R/L 3	1.500	1.370	14.000	3.000	1.250	2.500	VN..33..	32424	32424

**Spare parts
for Article no.**

	78 950 ...	78 950 ...	78 950 ...	78 950 ...	78 950 ...
78 714 31616 / 78 715 31616	09000	06800	02900	03700	02200
78 714 31626 / 78 715 31626	09000	06800	02900	03700	02200
78 714 32020 / 78 715 32020	09000	06800	02900	03800	02200
78 714 32030 / 78 715 32030	09000	06800	02900	03800	02200
78 714 32434 / 78 715 32434	09000	06800	02900	03800	02200
78 714 32424 / 78 715 32424	09000	06800	02900	03800	02200

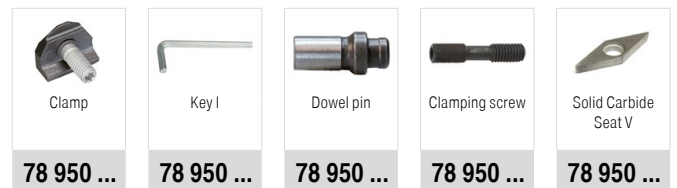

WNMG / WNMA

Designation	L inch	S inch	D1 inch	IC inch
WNMG 33..	0.256	0.187	0.150	0.375
WNM. 43..	0.339	0.187	0.203	0.500

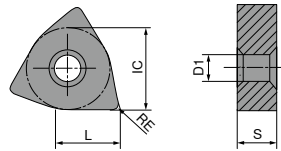

WNMG

		-CF20 CTEP110	-TFQ CTEP110	-F50 CTCP115	-F50 CTCP125	-F50 CTCP135	-TFQ CTCP115	-TFQ CTCP125
		DRAGONSKIN	DRAGONSKIN	DRAGONSKIN	DRAGONSKIN	DRAGONSKIN	DRAGONSKIN	DRAGONSKIN
		F	F	F	F	F	F	F
		CERMET WNMG	CERMET WNMG	WNMG	WNMG	WNMG	WNMG	WNMG
		76 171 ...	76 177 ...	76 157 ...	76 157 ...	76 157 ...	76 177 ...	76 177 ...
ANSI	RE inch							
331EN	0.016	004		304	504	704	304	514
332EN	0.031	006	006	306	506	706	306	506
431EN	0.016		016	316	516	716		
432EN	0.031	018	018	318	518	718	318	518
433EN	0.047			320	520	720	320	520
P		●	●	●	●	●	●	●
M		○	○			○		
K		○	○	○	○		○	○
N								
S								
H								
O								

4

WNMG

		-XU CTCP115	-XU CTCP125	-M50 CTCK110	-M50 CTCK120	-M50 CTCP115	-M50 CTCP125	-M50 CTCP135
		DRAGONSKIN						
		M WNMG	M WNMG	M WNMG	M WNMG	M WNMG	M WNMG	M WNMG
		76 295 ...	76 295 ...	70 139 ...	70 139 ...	76 139 ...	76 139 ...	76 139 ...
ANSI	RE inch							
331EN	0.016					304	504	704
332EN	0.031					306	506	706
333EN	0.047					308	508	708
431EN	0.016	316	516			316	516	716
432EN	0.031	318	518	018	518	318	518	718
433EN	0.047	320	520	020	520	320	520	720
434EN	0.063					322	522	722
P		●	●	○	○	●	●	●
M								○
K		○	○	●	●	○	○	
N								
S								
H								
O								

WNMG

		-TMQ CTCP115	-TMQ CTCP125	-M70 CTCK110	-M70 CTCK120	-M70 CTCP115	-M70 CTCP125	-M70 CTCP135
		DRAGONSKIN						
		M WNMG	M WNMG	M WNMG	M WNMG	M WNMG	M WNMG	M WNMG
		76 198 ...	76 198 ...	70 273 ...	70 273 ...	76 273 ...	76 273 ...	76 273 ...
ANSI	RE inch							
332EN	0.031					306	506	706
333EN	0.047					308	508	708
432EN	0.031	31800	518	018	518	318	518	718
433EN	0.047	320	520	020	520	320	520	720
434EN	0.063			022	522	322	522	722
P		●	●	○	○	●	●	●
M								○
K		○	○	●	●	○	○	
N								
S								
H								
O								

WNMA / WNMG

		CTCK110	CTCK120	NEW -F30 CTCM120	-F30 CTPM125	NEW -F30 CTCM130	NEW -M30 CTCM120	-M30 CTPM125
		R WNMA	R WNMA	F WNMG	F WNMG	F WNMG	M WNMG	M WNMG
		70 169 ...	70 169 ...	75 024 ...	75 024 ...	75 024 ...	75 025 ...	75 025 ...
ANSI	RE inch							
331EN	0.016			10400	204	30400		
332EN	0.031			10600	206	30600	10600	206
333EN	0.047						10800	208
431EN	0.016			11600	216	31600		
432EN	0.031	018	518	11800	218	31800	11800	218
433EN	0.047	020	520				12000	220
434EN	0.063	022	522					
P		○	○	○	○	○	○	○
M				●	●	●	●	●
K		●	●					
N								
S						○		
H								
O								

4

WNMG

		NEW -M30 CTCM130	NEW -M60 CTCM120	-M60 CTPM125	NEW -M60 CTCM130	NEW -M34 CTPX710
		M WNMG	M WNMG	M WNMG	M WNMG	M WNMG
		75 025 ...	75 026 ...	75 026 ...	75 026 ...	75 008 ...
ANSI	RE inch					
332EN	0.031	30600	10600	206	30600	
333EN	0.047	30800	10800	208	30800	
432EN	0.031	31800	11800	218	31800	61800
433EN	0.047	32000	12000	220	32000	62000
P		○	○	○	○	●
M		●	●	●	●	●
K						
N						○
S		○			○	●
H						
O						

WNMG

	NEW -FMS CT-P15	NEW -FMS CT-P25	NEW -MRS CT-P15	NEW -MRS CT-P25	NEW -MRS CT-P35
	F WNMG	F WNMG	M WNMG	M WNMG	M WNMG
	75 311 ...	75 311 ...	75 312 ...	75 312 ...	75 312 ...
ANSI					
RE					
inch					
431EN	01609	11609			
432EN	01809	11809	01809	11809	21809
433EN	02009	12009	02009	12009	22009
P	●	●	●	●	●
M	○	○	○	○	○
K					
N					
S					
H					
O					

WNGA

Designation	L inch	S inch	D1 inch	IC inch
WNGA 43..	0.335	0.187	0.202	0.500

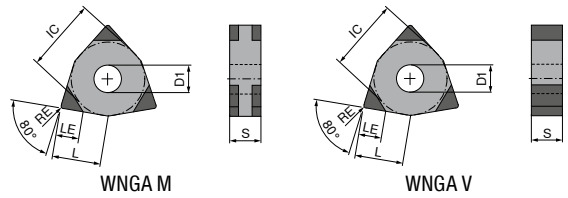

WNGA

▲ TCE(NOI) = Design and number of equipped cutting edge corners

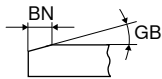

						NEW				NEW	
						CTBS05U	CTBS20C	CTBH20C	CTBH40C	CTBH40C	-Q
						F	F	F	F	F	
						CBN	CBN	CBN	CBN	CBN	
						WNGA	WNGA	WNGA	WNGA	WNGA	
						71 415 ...	71 405 ...	71 405 ...	71 405 ...	71 414 ...	
431FN	0.016			M (6)	0.110			20200			
431SN	0.016	0.004	20°	M (6)	0.110		152		332		
431SN	0.016	0.004	25°	M (6)	0.110				352		
431SN	0.016	0.006	30°	M (6)	0.110				372		
431SN	0.016	0.004	20°	M (6)	0.110			242			
431SN	0.016	0.005	25°	M (6)	0.110			262			
431TN	0.016	0.004	15°	M (6)	0.110			23200			
431TN	0.016	0.004	25°	M (6)	0.110			25200			
431SN	0.016	0.004	10°	M (6)	0.110		122				
431SN	0.016	0.004	15°	M (6)	0.110		132				
431TN	0.016	0.008	30°	V (3)	0.110						
431TN	0.016	0.008	30°	V (3)	0.177	00100					
						00200					
432SN	0.031	0.004	10°	M (6)	0.098		124				
432TN	0.031	0.004	15°	M (6)	0.098			23300			
432SN	0.031	0.004	15°	M (6)	0.098		134				
432SN	0.031	0.004	20°	M (6)	0.098		154		334		
432SN	0.031	0.004	20°	M (6)	0.098			244			
432EN	0.031			M (6)	0.098					60000	
432TN	0.031	0.004	25°	M (6)	0.098			25300			
432SN	0.031	0.004	25°	M (6)	0.098				354	60100	
432SN	0.031	0.005	25°	M (6)	0.098				364		
432SN	0.031	0.006	25°	M (6)	0.098		174				
432SN	0.031	0.006	30°	M (6)	0.098			274			
432TN	0.031	0.008	30°	V (3)	0.102	00300			376		
432TN	0.031	0.008	30°	V (3)	0.165	00400					
432SN	0.031	0.006	35°	M (6)	0.098				38200		
433SN	0.047	0.004	20°	M (6)	0.087				34200		
433SN	0.047	0.004	25°	M (6)	0.087				35100		
433SN	0.047	0.006	30°	M (6)	0.087				36100		
433TN	0.047	0.008	30°	V (3)	0.157						
433TN	0.047	0.008	30°	V (3)	0.094	00600					
433SN	0.047	0.006	35°	M (6)	0.087	00500			38300		

P					
M					
K					
N					
S					
H					
O					

4

MaxiLock-D – DWLN 95° – Toolholder with top clamping

▲ A... = with thru coolant

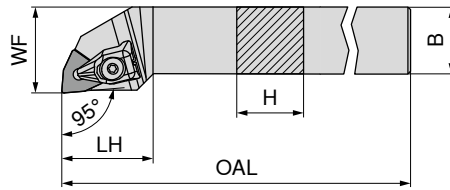

Illustrations show right-hand versions

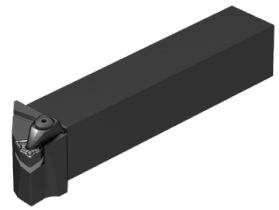

Designation	H inch	B inch	OAL inch	LH inch	WF inch	Insert	Left-hand	Right-hand
							78 515 ...	78 514 ...
DWLN R/L 12-4B-N	0.750	0.750	4.500	1.250	1.000	WN..43..	01293	01293
DWLN R/L 16-4D-N	1.000	1.000	6.000	1.250	1.250	WN..43..	01689	01689
DWLN R/L 20-4D-N	1.250	1.250	6.000	1.250	1.500	WN..43..	02089	02089
DWLN R/L 20-4DA-N	1.250	1.250	6.000	1.250	1.500	WN..43..	02092	02091
DWLN R/L 24-4E-N	1.500	1.500	7.000	1.250	2.000	WN..43..	02486	02486
DWLN R/L 24-4EA-N	1.500	1.500	7.000	1.250	2.000	WN..43..	02488	02488

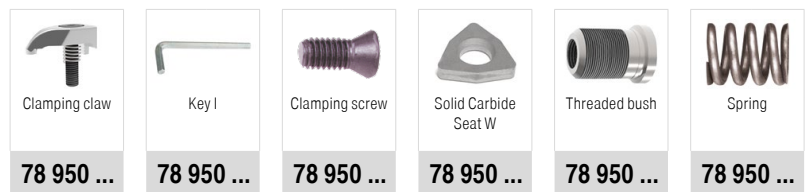

Spare parts for Article no.

Article no.	Clamping claw	Key I	Clamping screw	Solid Carbide Seat W	Threaded bush	Spring
78 514 01293 / 78 515 01293	07600	08100	08300	02400	08500	04900
78 514 01689 / 78 515 01689	07600	08100	08300	02400	08500	04900
78 514 02089 / 78 515 02089	07600	08100	08300	02400	08500	04900
78 514 02091 / 78 515 02092	07600	08100	08300	02400	08500	04900
78 514 02486 / 78 515 02486	07600	08100	08300	02400	08500	04900
78 514 02488 / 78 515 02488	07600	08100	08300	02400	08500	04900

MaxiLock-M – MWLN 95° – Toolholder with top clamping

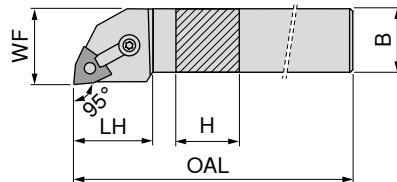

Illustrations show right-hand versions

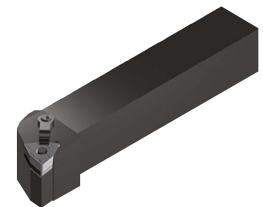

Designation	H inch	B inch	OAL inch	LH inch	WF inch	Insert	Left-hand	Right-hand
							78 551 ...	78 550 ...
MWLN L 12-3B	0.750	0.750	4.500	1.000	1.000	WN..33..	01223	01223
MWLN R/L 16-3D	1.000	1.000	6.000	1.000	1.250	WN..33..	01643	01643
MWLN R/L 12-4B	0.750	0.750	4.500	1.070	1.000	WN..43..	01224	01224
MWLN R/L 16-4D	1.000	1.000	6.000	1.070	1.250	WN..43..	01644	01644
MWLN R/L 20-4D	1.250	1.250	6.000	1.070	1.500	WN..43..	02044	02044
MWLN R/L 24-4E	1.500	1.500	7.000	1.070	2.000	WN..43..	02454	02454

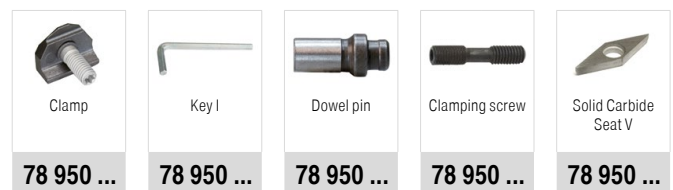

Spare parts for Article no.

Article no.	Clamp	Key I	Dowel pin	Clamping screw	Solid Carbide Seat V
78 551 01223	00600	06800	02900	03600	02200
78 550 01643 / 78 551 01643	00600	06800	02900	03600	02200
78 550 01224 / 78 551 01224	00400	07000	03100	03800	02300
78 550 01644 / 78 551 01644	00400	07000	03100	03800	02300
78 550 02044 / 78 551 02044	00400	07000	03100	03800	02300
78 550 02454 / 78 551 02454	00400	07000	03100	03800	02300

MaxiLock-M – MWLN 95° – Boring bar with top clamping

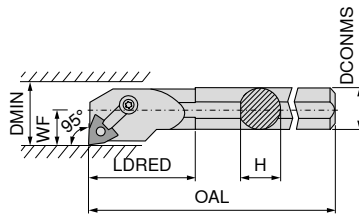



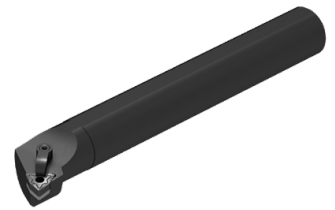

Illustrations show right-hand versions



Designation	DCONMS inch	H inch	OAL inch	LDRED inch	WF inch	DMIN inch	Insert	Left-hand	Right-hand
								78 717 ...	78 716 ...
S16T MWLN R/L 4	1.000	0.900	12.000	2.500	0.640	1.280	WN..43..	41626	41626
A16T MWLN R/L 4	1.000	0.900	12.000	2.500	0.640	1.280	WN..43..	41616	41616
S20U MWLN R/L 4	1.250	1.180	14.000	3.000	0.765	1.530	WN..43..	42030	42030
A20U MWLN R/L 4	1.250	1.180	14.000	3.000	0.765	1.530	WN..43..	42020	42020
S24U MWLN R/L 4	1.500	1.370	14.000	3.000	0.890	1.780	WN..43..	42434	42434
A24U MWLN R/L 4	1.500	1.370	14.000	3.000	0.890	1.780	WN..43..	42424	42424

Spare parts
for Article no.

	78 950 ...	78 950 ...	78 950 ...	78 950 ...	78 950 ...
78 716 41626 / 78 717 41626	00400	06900	03000	03700	
78 716 41616 / 78 717 41616	00400	06900	03000	03700	
78 716 42030 / 78 717 42030	00400	06900	03100	03800	02400
78 716 42020 / 78 717 42020	00400	06900	03100	03800	02400
78 716 42434 / 78 717 42434	00400	06900	03100	03800	02400
78 716 42424 / 78 717 42424	00400	06900	03100	03800	02400

 Clamp	 Key I	 Dowel pin	 Clamping screw	 Solid Carbide Seat W
78 950 ...	78 950 ...	78 950 ...	78 950 ...	78 950 ...

CCGT / CCMT

Designation	L inch	S inch	D1 inch	IC inch
CC.T 21..	0.252	0.094	0.110	0.250
CC.T 32..	0.382	0.156	0.173	0.375
CC.T 43..	0.508	0.187	0.217	0.500

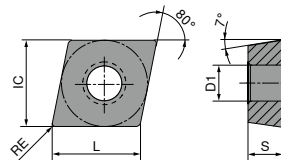

CCGT / CCMT

		-CF05 CTEP110	-CF55 CTEP110	-SF TCM10	-SMF TCM10	-SF TCM407	-SF CTCP125	-SF CTCP135
		DRAGONSKIN	DRAGONSKIN				DRAGONSKIN	DRAGONSKIN
		F	F	F	F	F	F	F
		CERMET CCGT	CERMET CCMT	CERMET CCGT	CERMET CCMT	CERMET CCGT	CCGT	CCGT
		76 247 ...	76 248 ...	70 251 ...	70 249 ...	70 251 ...	76 251 ...	76 251 ...
ANSI	RE inch							
21.5EN	0.008	002		900		850	502	702
21.51EN	0.016	004	004	902	900	852		
32.5EN	0.008	014		904		854		
32.51EN	0.016	016	016	906	904			
32.52EN	0.031	018	018	908	906			
431EN	0.016		028	910				
P		●	●	●	●	●	●	●
M		○	○	○	○	○		○
K		○	○	○	○	○	○	
N								
S								
H								
O								

CCMT / CCGT

		-SF CTCP115	-SF CTCP125	-SF CTCP135	-SMF CTCP115	-SMF CTCP125	-SMF CTCP135	-SM CTCP125
		DRAGONSKIN						
		F	F	F	F	F	F	M
		CCMT	CCMT	CCMT	CCMT	CCMT	CCMT	CCGT
		76 253 ...	76 253 ...	76 253 ...	76 249 ...	76 249 ...	76 249 ...	76 250 ...
ANSI	RE inch							
21.5EN	0.008							502
21.51EN	0.016	304	504	704		504	704	
21.52EN	0.031					506		
32.51EN	0.016	316	516	716	316	516	716	
32.52EN	0.031	318	518		318	518		
431EN	0.016		528			528		
432EN	0.031		530		330		730	
P		•	•	•	•	•	•	•
M								
K		○	○	○	○	○	○	○
N								
S								
H								
O								

4

CCGT / CCMT

		-SM CTCP135	-SM CTCK110	-SM CTCK120	-SM CTCP115	-SM CTCP125	-SM CTCP135	-SMQ CTCP115
		DRAGONSKIN						
		M	M	M	M	M	M	F
		CCGT	CCMT	CCMT	CCMT	CCMT	CCMT	CCMT
		76 250 ...	70 252 ...	70 252 ...	76 252 ...	76 252 ...	76 252 ...	76 194 ...
ANSI	RE inch							
21.5EN	0.008	702						
21.51EN	0.016		004	554	304	504	704	
21.52EN	0.031		006	506	306		706	
32.51EN	0.016		016	516	316	516	716	31600
32.52EN	0.031		018	518	318	518	718	31800
32.53EN	0.047		020	520				
431EN	0.016		028	528	328	528	728	32800
432EN	0.031		030	530	330	530	730	330
433EN	0.047					532		
P		•	○	○	•	•	•	•
M		○					○	
K			•	•	○	○		○
N								
S								
H								
O								

CCMT

		NEW		NEW		NEW		NEW	
		-SMQ CTCP125	-M25 CTCM120	-M25 CTPM125	-M25 CTCM130	-M55 CTCM120	-M55 CTPM125	-M55 CTCM130	
		DRAGONSKIN	DRAGONSKIN	DRAGONSKIN	DRAGONSKIN	DRAGONSKIN	DRAGONSKIN	DRAGONSKIN	
		F	F	F	F	M	M	M	
		CCMT	CCMT	CCMT	CCMT	CCMT	CCMT	CCMT	
		76 194 ...	75 210 ...	75 210 ...	75 210 ...	75 211 ...	75 211 ...	75 211 ...	
ANSI	RE inch								
21.51EN	0.016		10400	204	30400	10400	204		
32.51EN	0.016	516	11600	216	31600	11600	216	31600	
32.52EN	0.031	518	11800	218	31800	11800	218	31800	
431EN	0.016	528				12800	228	32800	
432EN	0.031	530				13000	230	33000	
P		●	○	○	○	○	○	○	○
M			●	●	●	●	●	●	●
K		○							
N									
S					○				○
H									
O									

CCGT

		-23P H216T	-25P H210T	NEW -25P CTPX710	-25Q H210T	NEW -25Q CTPX710	-27 H10T	-27 CWN15
				DRAGONSKIN 		DRAGONSKIN 		
		F	F	M	M	M	M	M
		CCGT	CCGT	CCGT	CCGT	CCGT	CCGT	CCGT
		70 255 ...	70 248 ...	70 248 ...	70 248 ...	70 248 ...	70 254 ...	70 254 ...
ANSI	RE inch							
21.5.FN	0.008	652	636	70200			600	300
21.51FN	0.016	654	638	70400	678	75400	602	302
32.5.FN	0.008		639	71400			604	304
32.51FN	0.016	656	640	71600	680	76600	606	306
32.52FN	0.031	658	641	71800	681	76800	608	308
43.5.FN	0.008		643				610	310
431FN	0.016		642	72800	682	77800	612	312
432FN	0.031		644	73000	686	78000	614	314
P				•		•		
M				•		•		○
K		○	○		○		○	
N		•	•	•	•	•	•	•
S			○	•	○	•		
H								
O		○	○		○		○	

4

CCGT / CCMT

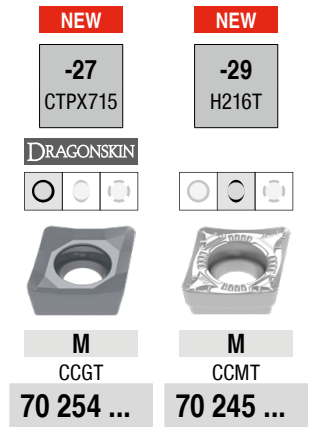

ANSI	RE inch	CCGT 70 254 ...	CCMT 70 245 ...
21.5.FN	0.008	80200	
21.51EN	0.016	80400	60400
21.51FN	0.016		
32.5.FN	0.008	81400	
32.51EN	0.016	81600	61600
32.51FN	0.016		
32.52EN	0.031	81800	61800
32.52FN	0.031		
43.5FN	0.008	82600	
431FN	0.016	82800	
432FN	0.031	83000	
P		●	
M		●	
K		○	○
N		●	●
S		●	
H			
O		○	○

CCMT

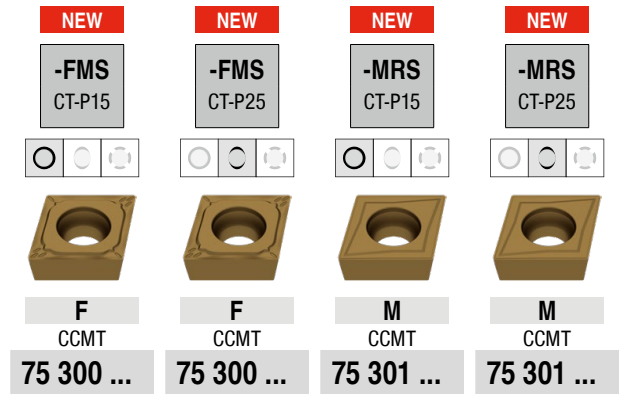

ANSI	RE inch	75 300 ...	75 300 ...	75 301 ...	75 301 ...
32.51EN	0.016	01609	11609	01609	11609
32.52EN	0.031	01809	11809	01809	11809
431EN	0.016	02809	12809	02809	12809
432EN	0.031	03009	13009	03009	13009
433EN	0.047			03209	13209
P		●	●	●	●
M		○	○	○	○
K					
N					
S					
H					
O					

4

CCGW / CCGT

Designation	L inch	S inch	D1 inch	IC inch
CCG. 21..	0.252	0.094	0.110	0.250
CCGW 21..	0.254	0.094	0.110	0.250
CCG. 32..	0.382	0.156	0.173	0.375
CCGW 43..	0.508	0.187	0.217	0.500

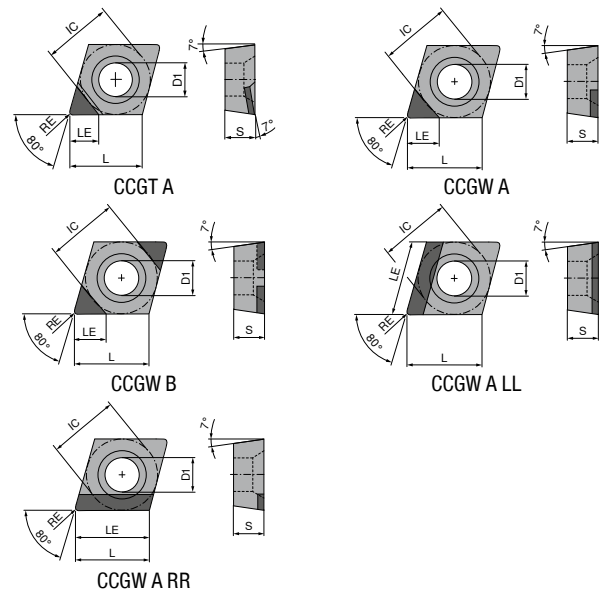

CCGW / CCGT

▲ TCE(NOI) = Design and number of equipped cutting edge corners

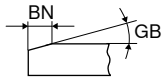

ANSI	RE	BN	GB	TCE (NOI)	LE inch	NEW	NEW	NEW		
21.5.5TN	0.008	0.005	20°	A (1)	0.134	CTBS10U	CTBS10U	CTBS10U		
21.5.5FN	0.008			A (1)	0.134					
21.51TN	0.016	0.005	20°	A (1)	0.122					
21.51FN	0.016			A (1)	0.122					
21.52TN	0.031	0.005	20°	A (1)	0.110					
32.5.5FN	0.008			A (1)	0.134					
32.51FN	0.016			A (1)	0.110					
32.51TLL	0.016	0.005	20°	A (1)	0.382					
32.51TRR	0.016	0.005	20°	A (1)	0.382					
32.51FN	0.016			A (1)	0.122					
32.51TN	0.016	0.005	20°	A (1)	0.110					
32.51FN	0.016			B (2)	0.122					
32.51TN	0.016	0.005	20°	B (2)	0.122					
32.52FN	0.031			A (1)	0.098					
32.52TLL	0.031	0.005	20°	A (1)	0.382					
32.52TRR	0.031	0.005	20°	A (1)	0.382					
32.52TN	0.031	0.005	20°	A (1)	0.098					
431FN	0.016			A (1)	0.122					
431TN	0.016	0.005	20°	A (1)	0.122					
432TN	0.031	0.005	20°	A (1)	0.110					
432FN	0.031			A (1)	0.110					
						71 419 ...	71 120 ...	71 124 ...	71 420 ...	71 420 ...
							300			
							200	200		
							302			
							202	202		
							30300			
								25000		
							204			
									10100	10000
							304	25200		
						10000				
						10100				
							206			
									10300	10200
							306			
							208			
							308			
							310			
							210			

P					
M					
K	•	•	•	•	•
N					
S	•	•	•	•	•
H					
O					

CCGW

▲ TCE(NOI) = Design and number of equipped cutting edge corners

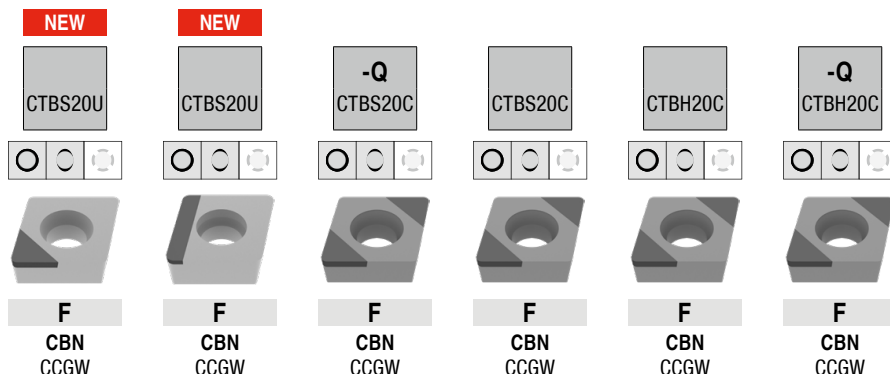
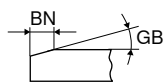

ANSI	RE inch	BN inch	GB	TCE (NOI)	LE inch	71 418 ...	71 420 ...	71 162 ...	71 161 ...	71 161 ...	71 162 ...
21.5.5SN	0.008	0.004	10°	B (2)	0.134						
21.5.5SN	0.008	0.004	15°	B (2)	0.134						
21.5.5TN	0.008	0.005	15°	A (1)	0.134	20000					
21.5.5SN	0.008	0.004	20°	B (2)	0.134					230	
21.5.5TN	0.008	0.006	20°	B (2)	0.134					250	
21.5.5SN	0.008	0.006	20°	B (2)	0.134				150		
21.5.5TN	0.008	0.006	25°	B (2)	0.134					260	
21.5.5SN	0.008	0.006	25°	B (2)	0.134					270	
21.5.5FN	0.008			B (2)	0.134						
21.5.5EN	0.008			B (2)	0.134						210
21.5.5TN	0.008	0.007	25°	B (2)	0.134						220
21.51SN	0.016	0.004	10°	B (2)	0.122						
21.51SN	0.016	0.004	15°	B (2)	0.122						
21.51SN	0.016	0.005	15°	A (1)	0.122	20200					
21.51SN	0.016	0.004	20°	B (2)	0.122						
21.51TN	0.016	0.006	20°	B (2)	0.122						
21.51EN	0.016			B (2)	0.122						
21.51FN	0.016			A (1)	0.122	20100					
21.51SN	0.016	0.006	20°	B (2)	0.122						
21.51TN	0.016	0.006	25°	B (2)	0.122						
21.51SN	0.016	0.006	25°	B (2)	0.122						
21.51TN	0.016	0.007	25°	B (2)	0.122						
21.51SN	0.016	0.007	25°	B (2)	0.122						
21.52EN	0.031			B (2)	0.110						
21.52FN	0.031			B (2)	0.110						
21.52SN	0.031	0.004	10°	B (2)	0.110						
21.52SN	0.031	0.004	20°	B (2)	0.110						
21.52TN	0.031	0.006	25°	B (2)	0.110						
21.52SN	0.031	0.007	30°	B (2)	0.110						
21.52TN	0.031	0.006	20°	B (2)	0.110						
21.52TN	0.031	0.007	25°	B (2)	0.110						
21.52SN	0.031	0.004	15°	B (2)	0.110						
21.52SN	0.031	0.007	25°	B (2)	0.110						
32.5.5SN	0.008	0.004	10°	B (2)	0.134						
32.5.5SN	0.008	0.004	15°	B (2)	0.134						
32.5.5SN	0.008	0.004	20°	B (2)	0.134						
32.5.5SN	0.008	0.006	20°	B (2)	0.134						
32.5.5SN	0.008	0.006	25°	B (2)	0.134						
32.5.5EN	0.008			B (2)	0.134						
32.5.5TN	0.008	0.007	25°	B (2)	0.134						
32.5.5SN	0.008	0.007	25°	B (2)	0.134						
32.51SN	0.016	0.004	10°	B (2)	0.122						
32.51SN	0.016	0.004	15°	B (2)	0.122						
32.51SN	0.016	0.005	15°	A (1)	0.110	20400					
32.51SN	0.016	0.004	20°	B (2)	0.122						
32.51TN	0.016	0.006	20°	B (2)	0.122						
32.51EN	0.016			B (2)	0.122						
32.51FN	0.016			A (1)	0.110	20300					
32.51SN	0.016	0.006	20°	B (2)	0.122						
32.51TN	0.016	0.006	25°	B (2)	0.122						
32.51SN	0.016	0.006	25°	B (2)	0.122						
32.51TN	0.016	0.007	25°	B (2)	0.122						

P											
M											
K											
N											
S											
H											
O											

4

CCGW

▲ TCE(NOI) = Design and number of equipped cutting edge corners

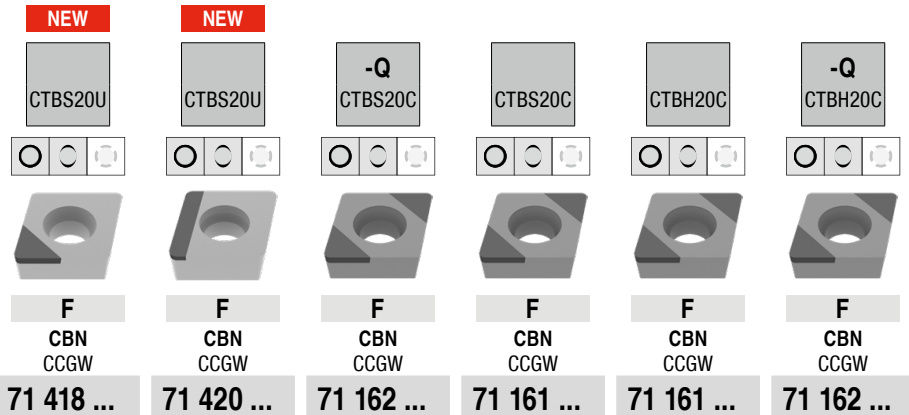
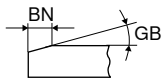

ANSI	RE inch	BN inch	GB	TCE (NOI)	LE inch	71 418 ...	71 420 ...	71 162 ...	71 161 ...	71 161 ...	71 162 ...
32.51SN	0.016	0.007	25°	B (2)	0.122			174	174		
32.51SN	0.016	0.007	30°	B (2)	0.122				184	284	
32.52SN	0.031	0.004	10°	B (2)	0.110			125	125	235	235
32.52SN	0.031	0.004	15°	B (2)	0.110			135		245	245
32.52TLL	0.031	0.005	15°	A (1)	0.382						
32.52TN	0.031	0.005	15°	A (1)	0.098	20600	20000				
32.52SN	0.031	0.004	20°	B (2)	0.110						255
32.52TN	0.031	0.006	20°	B (2)	0.110			145	145		
32.52SN	0.031	0.006	20°	B (2)	0.110			155	155		
32.52FN	0.031			B (2)	0.110						215
32.52EN	0.031			B (2)	0.110			115			225
32.52FN	0.031			A (1)	0.098	20500					
32.52TN	0.031	0.006	25°	B (2)	0.110					265	265
32.52SN	0.031	0.006	25°	B (2)	0.110					275	
32.52TN	0.031	0.007	25°	B (2)	0.110			165	165		
32.52SN	0.031	0.007	25°	B (2)	0.110				175		
32.52SN	0.031	0.007	30°	B (2)	0.110				185		
431TN	0.016	0.005	15°	A (1)	0.122	20800					
431FN	0.016			A (1)	0.122	20700					
432TN	0.031	0.005	15°	A (1)	0.110	20900					

P											
M											
K						•	•	•	•		
N											
S						•	•	•	•		
H										•	•
O											

CCGW

▲ TCE(NOI) = Design and number of equipped cutting edge corners

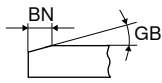

NEW	NEW	NEW
CTBH15U	CTBH15C	-Q CTBH15C
F	F	F
CBN CCGW	CBN CCGW	CBN CCGW
71 001 ...	71 000 ...	71 002 ...
30214	30214	
00200	00200	
30414	30414	
00400	00400	
30429	30429	
00600	00600	
30614	30614	
30629	30629	
	31414	
	31429	
	31614	31614
	31629	31629
	31814	31814
	31829	31829

ANSI	RE inch	BN inch	GB	TCE (NOI)	LE inch
21.5.5SN	0.008	0.004	15°	B (2)	0.134
21.5.5EN	0.008			B (2)	0.134
21.51SN	0.016	0.004	15°	B (2)	0.122
21.51EN	0.016			B (2)	0.122
21.51SN	0.016	0.006	25°	B (2)	0.122
21.52EN	0.031			B (2)	0.110
21.52SN	0.031	0.004	15°	B (2)	0.110
21.52SN	0.031	0.006	25°	B (2)	0.110
32.5.5SN	0.008	0.004	15°	B (2)	0.134
32.5.5SN	0.008	0.006	25°	B (2)	0.134
32.51SN	0.016	0.004	15°	B (2)	0.122
32.51SN	0.016	0.006	25°	B (2)	0.122
32.52SN	0.031	0.004	15°	B (2)	0.110
32.52SN	0.031	0.006	25°	B (2)	0.110

P			
M			
K			
N			
S			
H			
O			

4

CCGW / CCGT

▲ TCE(NOI) = Design and number of equipped cutting edge corners

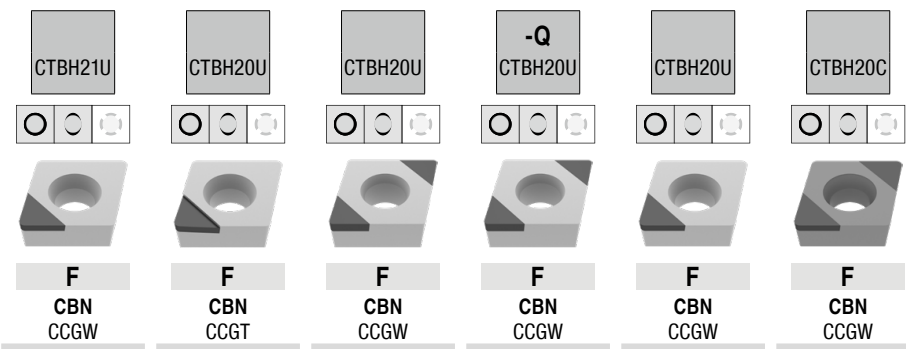

ANSI	RE inch	BN inch	GB	TCE (NOI)	LE inch	71 120 ...	71 124 ...	71 121 ...	71 123 ...	71 120 ...	71 161 ...
21.5.5SN	0.008	0.004	10°	B (2)	0.134						230
21.5.5SN	0.008	0.004	20°	B (2)	0.134						250
21.5.5TN	0.008	0.005	20°	A (1)	0.134					500	260
21.5.5TN	0.008	0.006	25°	B (2)	0.134						270
21.5.5SN	0.008	0.006	25°	B (2)	0.134						270
21.5.5FN	0.008			A (1)	0.134		400			400 ¹⁾	
21.51SN	0.016	0.004	10°	B (2)	0.122						231
21.51SN	0.016	0.004	15°	B (2)	0.122						241
21.51SN	0.016	0.004	20°	B (2)	0.122						251
21.51TN	0.016	0.005	20°	A (1)	0.122					502	
21.51TN	0.016	0.006	25°	B (2)	0.122						261
21.51SN	0.016	0.006	25°	B (2)	0.122						271
21.51EN	0.016			B (2)	0.122						221
21.51FN	0.016			A (1)	0.122		402			402 ¹⁾	
21.52SN	0.031	0.004	10°	B (2)	0.110						232
21.52SN	0.031	0.004	20°	B (2)	0.110						252
21.52FN	0.031			B (2)	0.110						212
21.52TN	0.031	0.006	25°	B (2)	0.110						262
21.52SN	0.031	0.007	30°	B (2)	0.110						282
32.5.5SN	0.008	0.004	10°	B (2)	0.134						233
32.5.5SN	0.008	0.004	15°	B (2)	0.134						243
32.5.5SN	0.008	0.004	20°	B (2)	0.134						253
32.5.5TN	0.008	0.005	20°	B (2)	0.134			50100			
32.5.5SN	0.008	0.006	25°	B (2)	0.134						273
32.51SN	0.016	0.004	10°	B (2)	0.122						234
32.51SN	0.016	0.004	15°	B (2)	0.122						244
32.51SN	0.016	0.004	20°	B (2)	0.122						254
32.51TN	0.016	0.005	20°	A (1)	0.110					504	
32.51TN	0.016	0.005	20°	B (2)	0.122			502	502		
32.51TN	0.016	0.006	25°	B (2)	0.122						264
32.51SN	0.016	0.006	25°	B (2)	0.122						274
32.51EN	0.016			B (2)	0.122						224
32.51FN	0.016			A (1)	0.110					404 ¹⁾	
32.51FN	0.016			B (2)	0.122						
32.51FN	0.016			A (1)	0.122	40500	45000	402 ¹⁾			
32.51SN	0.016	0.007	30°	B (2)	0.122						284
32.52SN	0.031	0.004	10°	B (2)	0.110						235
32.52SN	0.031	0.004	15°	B (2)	0.110						245
32.52TN	0.031	0.005	20°	A (1)	0.098					506	
32.52FN	0.031			A (1)	0.098					406 ¹⁾	
32.52FN	0.031			B (2)	0.110						
32.52TN	0.031	0.005	20°	B (2)	0.110			404 ¹⁾	404 ¹⁾		
32.52FN	0.031			A (1)	0.110		45200	504	504		
32.52TN	0.031	0.006	25°	B (2)	0.110						265
32.52SN	0.031	0.006	25°	B (2)	0.110						275
431TN	0.016	0.005	20°	A (1)	0.122					508	
432TN	0.031	0.005	20°	A (1)	0.110					510	



1) Machining to 60 HRC

CCGW / CCGT

▲ TCE(NOI) = Design and number of equipped cutting edge corners

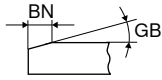

	-Q CTBH20C	CTBH40U	CTBH40U	CTBH40U	-Q CTBH40U
	F	F	F	F	F
	CBN CCGW	CBN CCGW	CBN CCGT	CBN CCGW	CBN CCGW
	71 162 ...	71 120 ...	71 124 ...	71 121 ...	71 123 ...
21.5.5SN					
21.5.5FN					
21.5.5EN					
21.5.5SN					
21.5.5TN					
21.51SN					
21.51FN					
21.51SN					
21.51SN					
21.51TN					
21.51TN					
21.52TN					
32.5.5FN					
32.51FN					
32.51FN					
32.51TN					
32.51FN					
32.51TN					
32.52FN					
32.52FN					
32.52TN					
32.52TN					
32.52EN					
32.52SN					
32.52SN					
32.52SN					
32.52SN					
32.52TN					
431TN					
431FN					
432TN					

ANSI	RE inch	BN inch	GB	TCE (NOI)	LE inch
21.5.5SN	0.008	0.004	10°	B (2)	0.134
21.5.5FN	0.008			A (1)	0.134
21.5.5FN	0.008			B (2)	0.134
21.5.5EN	0.008			B (2)	0.134
21.5.5SN	0.008	0.004	15°	B (2)	0.134
21.5.5TN	0.008	0.005	25°	A (1)	0.134
21.51SN	0.016	0.004	10°	B (2)	0.122
21.51FN	0.016			A (1)	0.122
21.51SN	0.016	0.004	15°	B (2)	0.122
21.51SN	0.016	0.004	20°	B (2)	0.122
21.51TN	0.016	0.005	25°	A (1)	0.122
21.51TN	0.016	0.006	25°	B (2)	0.122
21.52TN	0.031	0.005	25°	A (1)	0.110
32.5.5FN	0.008			B (2)	0.134
32.51FN	0.016			A (1)	0.122
32.51FN	0.016			B (2)	0.122
32.51TN	0.016	0.005	25°	B (2)	0.122
32.51FN	0.016			A (1)	0.110
32.51TN	0.016	0.005	25°	A (1)	0.110
32.52FN	0.031			A (1)	0.098
32.52FN	0.031			B (2)	0.110
32.52TN	0.031	0.005	25°	B (2)	0.110
32.52TN	0.031	0.005	25°	A (1)	0.098
32.52EN	0.031			B (2)	0.110
32.52SN	0.031	0.004	10°	B (2)	0.110
32.52SN	0.031	0.004	15°	B (2)	0.110
32.52SN	0.031	0.004	20°	B (2)	0.110
32.52TN	0.031	0.006	25°	B (2)	0.110
431TN	0.016	0.005	25°	A (1)	0.122
431FN	0.016			A (1)	0.122
432TN	0.031	0.005	25°	A (1)	0.110

P					
M					
K					
N					
S					
H					
O					

4

CCGW

▲ TCE(NOI) = Design and number of equipped cutting edge corners

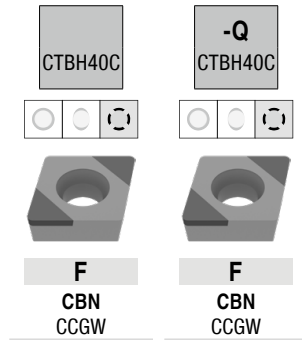
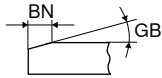

ANSI	RE inch	BN inch	GB	TCE (NOI)	LE inch	71 161 ...	71 162 ...
21.5.5TN	0.008	0.004	20°	B (2)	0.134		
21.5.5SN	0.008	0.004	20°	B (2)	0.134	320	
21.5.5TN	0.008	0.004	25°	B (2)	0.134		330
21.5.5SN	0.008	0.004	25°	B (2)	0.134	350	350
21.5.5TN	0.008	0.004	25°	B (2)	0.134	340	340
21.5.5TN	0.008	0.006	30°	B (2)	0.134	360	360
21.51SN	0.016	0.004	20°	B (2)	0.122		
21.51TN	0.016	0.004	20°	B (2)	0.122	331	
21.51SN	0.016	0.004	25°	B (2)	0.122	32100	
21.51TN	0.016	0.004	25°	B (2)	0.122	351	351
21.51TN	0.016	0.004	25°	B (2)	0.122	341	341
21.51TN	0.016	0.006	30°	B (2)	0.122	361	361
21.51SN	0.016	0.006	30°	B (2)	0.122	371	371
21.51SN	0.016	0.007	35°	B (2)	0.122	381	381
21.52TN	0.031	0.004	20°	B (2)	0.110		
21.52SN	0.031	0.004	25°	B (2)	0.110	322	
21.52TN	0.031	0.004	25°	B (2)	0.110	352	
21.52TN	0.031	0.004	25°	B (2)	0.110	342	
21.52TN	0.031	0.006	30°	B (2)	0.110	362	
21.52SN	0.031	0.006	30°	B (2)	0.110	372	
21.52SN	0.031	0.007	35°	B (2)	0.110	382	
32.5.5TN	0.008	0.004	20°	B (2)	0.134		
32.5.5SN	0.008	0.004	25°	B (2)	0.134	323	
32.5.5TN	0.008	0.004	25°	B (2)	0.134	353	
32.5.5SN	0.008	0.006	30°	B (2)	0.134	343	
32.5.5SN	0.008	0.006	30°	B (2)	0.134	373	
32.5.5SN	0.008	0.007	35°	B (2)	0.134	383	
32.51SN	0.016	0.004	20°	B (2)	0.122		
32.51TN	0.016	0.004	20°	B (2)	0.122	334	334
32.51SN	0.016	0.004	25°	B (2)	0.122	324	324
32.51TN	0.016	0.004	25°	B (2)	0.122	354	354
32.51TN	0.016	0.004	25°	B (2)	0.122	344	344
32.51TN	0.016	0.006	30°	B (2)	0.122	364	364
32.51EN	0.016			B (2)	0.122	314	
32.51SN	0.016	0.006	30°	B (2)	0.122	374	
32.51SN	0.016	0.007	35°	B (2)	0.122	384	
32.52SN	0.031	0.004	20°	B (2)	0.110		
32.52TN	0.031	0.004	20°	B (2)	0.110	335	335
32.52SN	0.031	0.004	25°	B (2)	0.110	325	325
32.52SN	0.031	0.004	25°	B (2)	0.110	355	355
32.52TN	0.031	0.004	25°	B (2)	0.110	345	345
32.52TN	0.031	0.006	30°	B (2)	0.110	365	365
32.52SN	0.031	0.006	30°	B (2)	0.110	375	375
32.52EN	0.031			B (2)	0.110	385	315
32.52SN	0.031	0.007	35°	B (2)	0.110		

P
M
K
N
S
H
O

CCGW / CCGT

Designation	L inch	S inch	D1 inch	IC inch
CCG. 21..	0.252	0.094	0.110	0.250
CCG. 32..	0.382	0.156	0.173	0.375
CCG. 43..	0.508	0.187	0.217	0.500

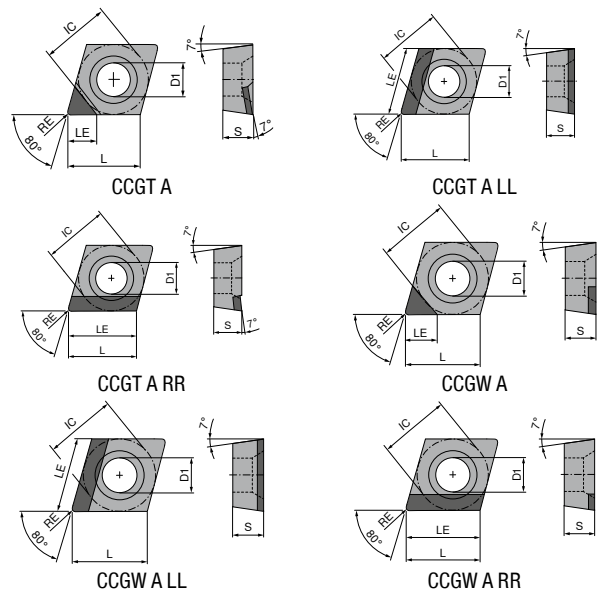

CCGW / CCGT

▲ TCE(NOI) = Design and number of equipped cutting edge corners

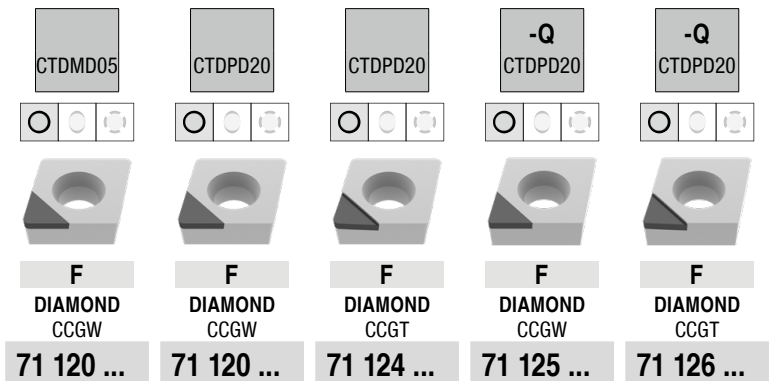

ANSI	RE inch	TCE (NOI)	LE inch	71 120 ...	71 120 ...	71 124 ...	71 125 ...	71 126 ...
21.50FN	0.004	A (1)	0.134					101
21.50FN	0.004	A (1)	0.138					
21.5.5FN	0.008	A (1)	0.098	050		10100		102
21.5.5FN	0.008	A (1)	0.130		100	100	102	102
21.5.5FN	0.008	A (1)	0.134					
21.51FN	0.016	A (1)	0.098	052				104
21.51FN	0.016	A (1)	0.122		102	102	104	104
21.51FN	0.016	A (1)	0.126					
21.52FN	0.031	A (1)	0.098	05300	10300	10300		
21.52FN	0.031	A (1)	0.118					
32.50FN	0.004	A (1)	0.177				111	111
32.5.5FN	0.008	A (1)	0.173				112	112
32.5.5FN	0.008	A (1)	0.177					
32.51FN	0.016	A (1)	0.098	054	10500	10500		
32.51FN	0.016	A (1)	0.165				114	114
32.51FN	0.016	A (1)	0.169		104	104		
32.52FN	0.031	A (1)	0.098	056	106	106		
32.52FN	0.031	A (1)	0.161					
43.5FN	0.008	A (1)	0.173				122	122
431FN	0.016	A (1)	0.165				124	124
431FN	0.016	A (1)	0.169		108	108		
432FN	0.031	A (1)	0.161		110	110		

P								
M								
K								
N		•		•		•		•
S								
H								
O		•		•		•		•

CCGW / CCGT

▲ TCE(NOI) = Design and number of equipped cutting edge corners

ANSI	RE inch	TCE (NOI)	LE inch						
				71 172 ...	71 172 ...	71 300 ...	71 168 ...	71 305 ...	71 169 ...
				F DIAMOND CCGW	F DIAMOND CCGW	F DIAMOND CCGT	M DIAMOND CCGT	F DIAMOND CCGT	M DIAMOND CCGT
21.5.5FN	0.008	A (1)	0.134						
21.51FN	0.016	A (1)	0.122						
21.51FN	0.016	A (1)	0.126						
21.51FRR	0.016	A (1)	0.254						
21.51FLL	0.016	A (1)	0.254	10001	10101				
21.52FN	0.031	A (1)	0.118						
32.5.5FN	0.008	A (1)	0.173						
32.5.5FN	0.008	A (1)	0.177						
32.51FN	0.016	A (1)	0.165						
32.51FN	0.016	A (1)	0.169						
32.52FN	0.031	A (1)	0.161						
32.52FRR	0.031	A (1)	0.382						
32.52FLL	0.031	A (1)	0.382	10201	10301				
32.53FLL	0.047	A (1)	0.382	10401					
431FN	0.016	A (1)	0.165						
431FN	0.016	A (1)	0.169						
432FN	0.031	A (1)	0.161						
433FRR	0.047	A (1)	0.508						
433FLL	0.047	A (1)	0.508	10501	10601				
P									
M									
K									
N				•	•	•	•	•	•
S									
H									
O				•	•	•	•	•	•

CCGT / CCGW

▲ TCE(NOI) = Design and number of equipped cutting edge corners

ANSI	RE inch	TCE (NOI)	LE inch							
				71 166 ...	71 125 ...	71 126 ...	71 170 ...	71 170 ...	71 301 ...	
21.50FN	0.004	A (1)	0.138	20001						
21.5.5FN	0.008	A (1)	0.130		152	152				
21.5.5FN	0.008	A (1)	0.134	20101						202
21.51FN	0.016	A (1)	0.126							204
21.51FRR	0.016	A (1)	0.254					20101		
21.51FLL	0.016	A (1)	0.254				20001			
21.52FN	0.031	A (1)	0.118						20301	208
21.52FRR	0.031	A (1)	0.254				20201			
21.52FLL	0.031	A (1)	0.254							
32.50FN	0.004	A (1)	0.177							
32.5.5FN	0.008	A (1)	0.173		16300	162				
32.5.5FN	0.008	A (1)	0.177	20201	162	162				212
32.51FN	0.016	A (1)	0.169							214
32.52FN	0.031	A (1)	0.161							218
32.52FRR	0.031	A (1)	0.382					20501		
32.52FLL	0.031	A (1)	0.382				20401			
43.5FN	0.008	A (1)	0.173			172				
431FN	0.016	A (1)	0.165			174				
431FN	0.016	A (1)	0.169	20301						224
432FN	0.031	A (1)	0.161							228
433FRR	0.047	A (1)	0.508					20701		
433FLL	0.047	A (1)	0.508				20601			
P										
M										
K										
N				•	•	•	•	•	•	•
S										
H										
O				•	•	•	•	•	•	•

4

CCGT / CCGW

▲ TCE(NOI) = Design and number of equipped cutting edge corners

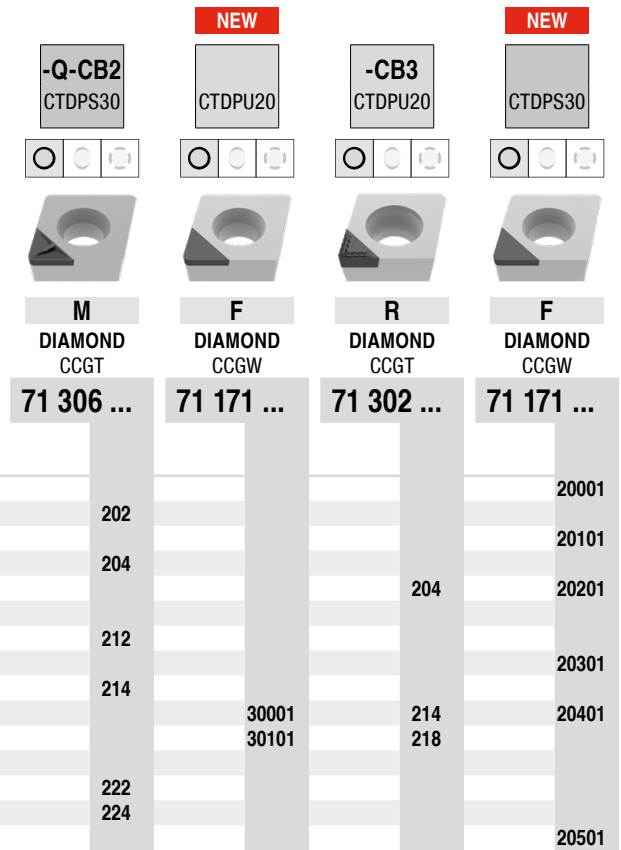

ANSI	RE inch	TCE (NOI)	LE inch
21.50FN	0.004	A (1)	0.138
21.5.5FN	0.008	A (1)	0.130
21.5.5FN	0.008	A (1)	0.134
21.51FN	0.016	A (1)	0.122
21.51FN	0.016	A (1)	0.126
32.5.5FN	0.008	A (1)	0.173
32.5.5FN	0.008	A (1)	0.177
32.51FN	0.016	A (1)	0.165
32.51FN	0.016	A (1)	0.169
32.52FN	0.031	A (1)	0.161
43.5FN	0.008	A (1)	0.173
431FN	0.016	A (1)	0.165
431FN	0.016	A (1)	0.169

P				
M				
K				
N				
S				
H				
O				

CCGW / CCGT

▲ TCE(NOI) = Design and number of equipped cutting edge corners

		NEW CTDCD10	-CB1 CTDCD10	NEW -Q-CB1 CTDCD10	-CB2 CTDCD10	-Q-CB2 CTDCD10
		F	F	F	M	M
		DIAMOND CCGW	DIAMOND CCGT	DIAMOND CCGT	DIAMOND CCGT	DIAMOND CCGT
		71 171 ...	71 300 ...	71 167 ...	71 301 ...	71 306 ...
ANSI	RE	TCE	LE			
	inch	(NOI)	inch			
21.5.5FN	0.008	A (1)	0.091			
21.5.5FN	0.008	A (1)	0.094	40001	302	
21.51FN	0.016	A (1)	0.083	40101	304	304
21.51FN	0.016	A (1)	0.087		30600	
21.52FN	0.031	A (1)	0.079			
32.5.5FN	0.008	A (1)	0.091			31200
32.5.5FN	0.008	A (1)	0.094	40201		31200
32.51FN	0.016	A (1)	0.083			314
32.51FN	0.016	A (1)	0.087	40301	314	314
32.52FN	0.031	A (1)	0.079	40401		31600
431FN	0.016	A (1)	0.083			324
431FN	0.016	A (1)	0.087			32600
432FN	0.031	A (1)	0.079	40501		
432FN	0.031	A (1)	0.083		328	

P						
M						
K						
N		•	•	•	•	•
S						
H						
O		•	•	•	•	•

4

MaxiLock-S – SCLC 95° – Toolholder with screw clamping

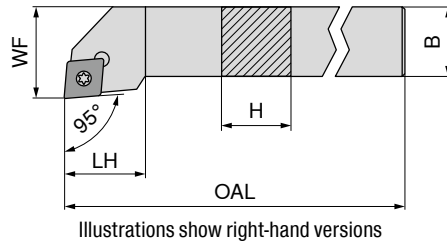

Designation	H inch	B inch	OAL inch	LH inch	WF inch	Insert
SCLC R/L 06-2	0.375	0.375	2.500	0.390	0.500	CC..21.5..
SCLC R/L 08-3	0.500	0.500	3.500	0.630	0.625	CC..32.5..
SCLC R/L 10-3	0.625	0.625	4.000	0.630	0.750	CC..32.5..
SCLC R/L 12-3B	0.750	0.750	4.500	0.630	1.000	CC..32.5..
SCLC R/L 16-3D	1.000	1.000	6.000	0.630	1.250	CC..32.5..
SCLC R/L 12-4B	0.750	0.750	4.500	1.000	1.000	CC..43..
SCLC R/L 16-4D	1.000	1.000	6.000	1.000	1.250	CC..43..
SCLC R/L 20-4D	1.250	1.250	6.000	1.000	1.500	CC..43..

Left-hand 78 553 ...	Right-hand 78 552 ...
00602	00602
00803	00803
01003	01003
01223	01223
01643	01643
01224	01224
01644	01644
02044	02044

**Spare parts
for Article no.**

	Key I 78 950 ...	Clamping screw 78 950 ...	Carbide type C 78 950 ...	Threaded sleeve 78 950 ...
78 552 00602 / 78 553 00602	06400	06200		
78 552 00803 / 78 553 00803	05700	05600		
78 552 01003 / 78 553 01003	05700	05600		
78 552 01223 / 78 553 01223	05700	05600		
78 552 01643 / 78 553 01643	05700	05600		
78 552 01224 / 78 553 01224	04700		04500	04800
78 552 01644 / 78 553 01644	04700		04500	04800
78 552 02044 / 78 553 02044	04700		04500	04800

MaxiLock-S – SCLC 95° – Boring bar with screw clamping

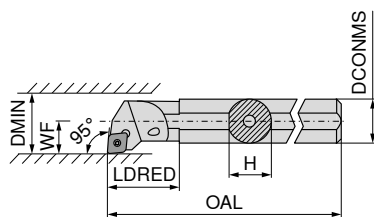

Illustrations show right-hand versions



Designation	DCONMS inch	H inch	OAL inch	LDRED inch	WF inch	DMIN inch	Insert	Left-hand	Right-hand
								78 719 ...	78 718 ...
S06M SCLC R/L 2	0.375	0.340	6.000	0.830	0.250	0.500	CC..21.5..	20617	20617
A06M SCLC R/L 2	0.375	0.340	6.000	0.830	0.250	0.500	CC..21.5..	20606	20606
S08M SCLC R/L 2	0.500	0.460	6.000	0.910	0.312	0.625	CC..21.5..	20818	20818
A08M SCLC R/L 2	0.500	0.460	6.000	0.910	0.312	0.625	CC..21.5..	20808	20808
S10R SCLC R/L 2	0.625	0.580	8.000	1.060	0.406	0.812	CC..21.5..	21021	21021
A10R SCLC R/L 2	0.625	0.580	8.000	1.060	0.406	0.812	CC..21.5..	21010	21010
S10R SCLC R/L 3	0.625	0.580	8.000	1.060	0.406	0.812	CC..32.5..	31021	31021
A10R SCLC R/L 3	0.625	0.580	8.000	1.060	0.406	0.812	CC..32.5..	31010	31010
S12S SCLC R/L 3M	0.750	0.710	10.000	1.580	0.500	1.000	CC..32.5..	91222	91222
A12S SCLC R/L 3M	0.750	0.710	10.000	1.580	0.500	1.000	CC..32.5..	91212	91212
S16T SCLC R/L 3M	1.000	0.900	12.000	1.810	0.640	1.280	CC..32.5..	91626	91626
S16T SCLC R/L 4	1.000	0.900	12.000	3.000	0.640	1.280	CC..43..	41626	41626
S20U SCLC R/L 4	1.250	1.180	14.000	3.000	0.765	1.530	CC..43..	42030	42030
S24V SCLC R/L 4	1.500	1.370	16.000	3.000	0.890	1.780	CC..43..	42435	42435

4

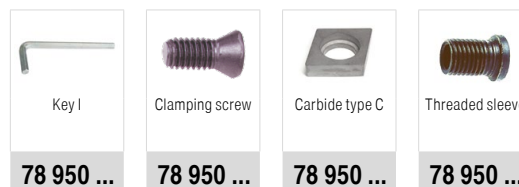

**Spare parts
for Article no.**

78 718 20617 / 78 719 20617	06400	05200		
78 718 20606 / 78 719 20606	06400	05200		
78 718 20818 / 78 719 20818	06400	05200		
78 718 20808 / 78 719 20808	06400	05200		
78 718 21021 / 78 719 21021	06400	05200		
78 718 21010 / 78 719 21010	06400	05200		
78 718 31021 / 78 719 31021	06400	05200		
78 718 31010 / 78 719 31010	05700	05800		
78 718 91222 / 78 719 91222	05700	05800		
78 718 91212 / 78 719 91212	05700	05800		
78 718 91626 / 78 719 91626	05700	05800		
78 718 41626 / 78 719 41626	06600	06500		
78 718 42030 / 78 719 42030	04700	04600	04500	04800
78 718 42435 / 78 719 42435	04700	04600	04500	04800

DCGT / DCMT / DCET

Designation	L inch	S inch	D1 inch	IC inch
DC.T 21..	0.305	0.094	0.110	0.250
DC.T 32..	0.457	0.156	0.173	0.375

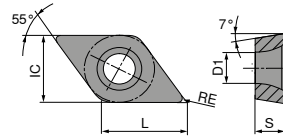

DCGT / DCMT

		-CF05 CTEP110	-CF55 CTEP110	-SF TCM10	-SMF TCM10	-SF TCM407	-SF CTCP125	-SF CTCP115
		DRAGONSKIN	DRAGONSKIN				DRAGONSKIN	DRAGONSKIN
		F	F	F	F	F	F	F
		CERMET DCGT	CERMET DCMT	CERMET DCGT	CERMET DCMT	CERMET DCGT	DCGT	DCMT
		76 245 ...	76 246 ...	70 257 ...	70 265 ...	70 257 ...	76 257 ...	76 259 ...
ANSI	RE inch							
21.5.5EN	0.008	002	002	900	898		502	
21.50EN	0.004			898	900			304
21.51EN	0.016	004	004	902		852		
32.5.5EN	0.008	014		904		854		
32.51EN	0.016	016	016	906	904	856		316
32.52EN	0.031	018	018	908	906	858		318
P		●	●	●	●	●	●	●
M		○	○	○	○	○		
K		○	○	○	○	○	○	○
N								
S								
H								
O								

DCMT / DCGT

		-SF CTCP125	-SF CTCP135	-SMF CTCP115	-SMF CTCP125	-SMF CTCP135	-SM CTCP125	-SM CTCP135
		DRAGONSKIN	DRAGONSKIN	DRAGONSKIN	DRAGONSKIN	DRAGONSKIN	DRAGONSKIN	DRAGONSKIN
		F	F	F	F	F	M	M
		DCMT	DCMT	DCMT	DCMT	DCMT	DCGT	DCGT
		76 259 ...	76 259 ...	76 265 ...	76 265 ...	76 265 ...	76 256 ...	76 256 ...
ANSI	RE inch							
21.5.5EN	0.008						502	
21.51EN	0.016	504	704		504	704		702
21.52EN	0.031					706		
32.51EN	0.016	516	716	316	516	716		
32.52EN	0.031	518	718	318	518	718		
P		●	●	●	●	●	●	●
M			○			○		○
K		○	○	○	○	○	○	○
N								
S								
H								
O								

DCMT

		-SM CTCK110	-SM CTCK120	-SM CTCP115	-SM CTCP125	-SM CTCP135	-SMQ CTCP115	-SMQ CTCP125
		M DCMT	M DCMT	M DCMT	M DCMT	M DCMT	M DCMT	M DCMT
		70 258 ...	70 258 ...	76 258 ...	76 258 ...	76 258 ...	76 195 ...	76 195 ...
ANSI	RE inch							
21.51EN	0.016	004	554	304	504	704	304	504
21.52EN	0.031	006	506	306	506	706		
32.51EL	0.016						31600	516
32.51EN	0.016	016	516	316	516	716	31500	515
32.51ER	0.016						31700	517
32.52EN	0.031	018	518	318	518	718	31800	518
32.53EN	0.047				520			
P		○	○	●	●	●	●	●
M						○		
K		●	●	○	○		○	○
N								
S								
H								
O								

4

DCMT

		NEW -M25 CTCM120	-M25 CTPM125	NEW -M25 CTCM130	NEW -M55 CTCM120	-M55 CTPM125	NEW -M55 CTCM130
		F DCMT	F DCMT	F DCMT	M DCMT	M DCMT	M DCMT
		75 213 ...	75 213 ...	75 213 ...	75 214 ...	75 214 ...	75 214 ...
ANSI	RE inch						
21.5.5EN	0.008	10200	202	30200			
21.51EN	0.016	10400	204	30400	10400	204	30400
21.52EN	0.031				10600	206	30600
32.5.5EN	0.008	11400	214	31400			
32.51EN	0.016	11600	216	31600	11600	216	31600
32.52EN	0.031	11800	218	31800	11800	218	31800
P		○	○	○	○	○	○
M		●	●	●	●	●	●
K							
N							
S					○		○
H							
O							

DCGT

		-23P H216T	-25P H210T	NEW -25P CTPX710	-25Q H210T	NEW -25Q CTPX710	-27 H10T	-27 CWN15
				DRAGONSKIN 		DRAGONSKIN 		
		F	F	M	M	M	M	M
		DCGT	DCGT	DCGT	DCGT	DCGT	DCGT	DCGT
		70 261 ...	70 263 ...	70 263 ...	70 263 ...	70 263 ...	70 260 ...	70 260 ...
ANSI	RE inch							
21.5.5FN	0.008		632	70200			600	300
21.51FN	0.016	654	634	70400			602	302
32.5.5FN	0.008		635	71400			604	304
32.51FL	0.016				670	75700		
32.51FN	0.016	664	636	71600	660	75600	606	306
32.51FR	0.016				680	75800		
32.52FL	0.031				672			
32.52FN	0.031	666	638	71800	662	76000	608	308
32.52FR	0.031				682			
P				●		●		
M				●		●		○
K		○	○		○		○	
N		●	●	●	●	●	●	●
S			○	●	○	●		
H								
O		○	○		○		○	

DCGT / DCMT / DCET

NEW	NEW	NEW
-27 CTPX715	-29 H216T	-F05 CTPX710
DRAGONSKIN		DRAGONSKIN
M	M	F
DCGT	DCMT	DCET
70 260 ...	70 246 ...	76 254 ...

ANSI	RE inch	70 260 ...	70 246 ...	76 254 ...
21.5X0FN	0.002			10200
21.50FN	0.004			10400
21.505FN	0.006			10600
21.5.5FN	0.008			10800
21.51FN	0.016	80200		
21.51EN	0.016	80400		
32.5X0FN	0.002			11400
32.50FN	0.004			11600
32.5X0FN	0.006			11800
32.5.5FN	0.008	81400		12000
32.51EN	0.016			
32.51FN	0.016	81600	61600	12200
32.52EN	0.031		61800	
32.52FN	0.031	81800		
P		●		●
M		●		●
K		○	○	
N		●	●	●
S		●		●
H				
O		○	○	

4

DCMT

	NEW -FMS CT-P15	NEW -FMS CT-P25	NEW -MRS CT-P15	NEW -MRS CT-P25
	F DCMT	F DCMT	M DCMT	M DCMT
	75 304 ...	75 304 ...	75 305 ...	75 305 ...
ANSI				
RE				
inch				
21.51EN	00409	10409	00409	10409
21.52EN	00609	10609	00609	10609
32.51EN	01609	11609	01609	11609
32.52EN	01809	11809	01809	11809
P	●	●	●	●
M	○	○	○	○
K				
N				
S				
H				
O				

DCGW / DCGT

Designation	L inch	S inch	D1 inch	IC inch
DCG. 21..	0.305	0.094	0.110	0.250
DCG. 32..	0.457	0.156	0.173	0.375

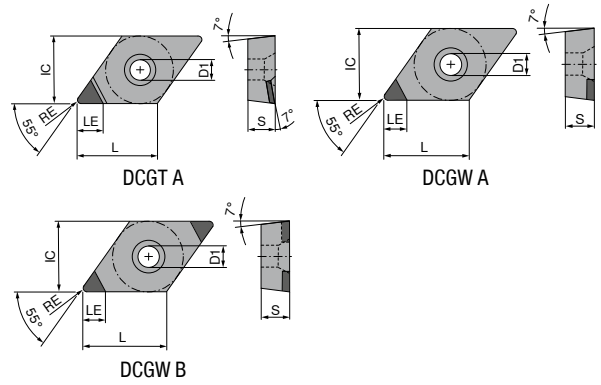

DCGW / DCGT

▲ TCE(NOI) = Design and number of equipped cutting edge corners

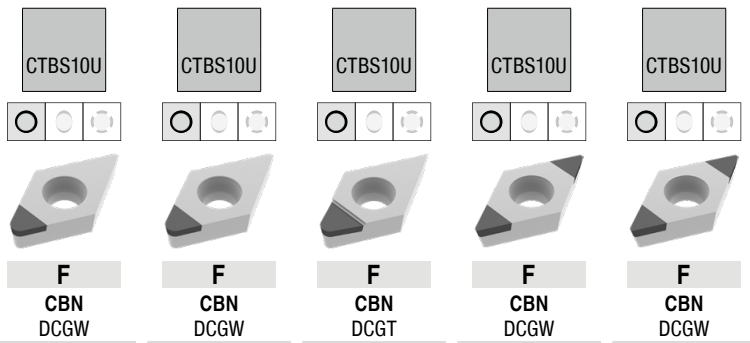
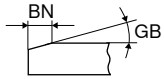

ANSI	RE inch	BN inch	GB	TCE (NOI)	LE inch	71 130 ...	71 130 ...	71 134 ...	71 131 ...	71 131 ...
21.5.5TN	0.008	0.005	20°	A (1)	0.154	300				
21.5.5FN	0.008			A (1)	0.154		200	200		
21.51TN	0.016	0.005	20°	A (1)	0.138	302				
21.51FN	0.016			A (1)	0.138		202	202		
21.52TN	0.031	0.005	20°	A (1)	0.118	304				
21.52FN	0.031			A (1)	0.118		204	204		
32.5.5FN	0.008			A (1)	0.154					
32.5.5FN	0.008			B (2)	0.154					200
32.5.5TN	0.008	0.005	20°	B (2)	0.154				300	
32.5.5TN	0.008	0.005	20°	A (1)	0.154	306				
32.51FN	0.016			A (1)	0.138					
32.51FN	0.016			B (2)	0.138					202
32.51TN	0.016	0.005	20°	B (2)	0.138				302	
32.51TN	0.016	0.005	20°	A (1)	0.138	308				
32.52FN	0.031			A (1)	0.118					
32.52FN	0.031			B (2)	0.118					204
32.52TN	0.031	0.005	20°	B (2)	0.118				304	
32.52TN	0.031	0.005	20°	A (1)	0.118	310				

P					
M					
K	•	•	•	•	•
N					
S	•	•	•	•	•
H					
O					

4

DCGW / DCGT

▲ TCE(NOI) = Design and number of equipped cutting edge corners

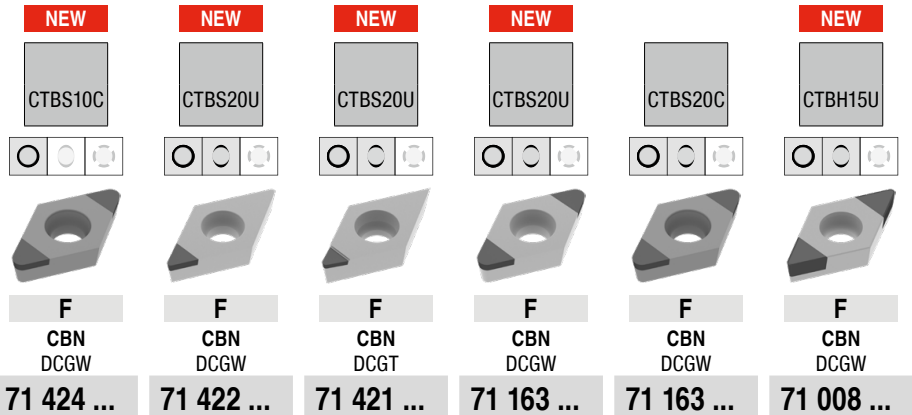
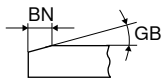

ANSI	RE inch	BN inch	GB	TCE (NOI)	LE inch	71 424 ...	71 422 ...	71 421 ...	71 163 ...	71 163 ...	71 008 ...
21.5.5SN	0.008	0.004	10°	B (2)	0.154	80100				120	
21.5.5SN	0.008	0.004	15°	B (2)	0.154					130	30214
21.5.5TN	0.008	0.005	15°	A (1)	0.154		20100			140	
21.5.5TN	0.008	0.006	20°	B (2)	0.154					150	
21.5.5SN	0.008	0.006	20°	B (2)	0.154					160	
21.5.5TN	0.008	0.007	25°	B (2)	0.154						00200
21.5.5EN	0.008			B (2)	0.154						
21.5.5FN	0.008			A (1)	0.154		20000				
21.5.5FN	0.008			B (2)	0.154	80000					
21.51SN	0.016	0.004	10°	B (2)	0.138					121	
21.51TN	0.016	0.004	15°	B (2)	0.138	80300				131	30414
21.51SN	0.016	0.004	15°	B (2)	0.138						
21.51TN	0.016	0.005	15°	A (1)	0.138		20200				
21.51SN	0.016	0.006	15°	B (2)	0.138	80400				141	
21.51TN	0.016	0.006	20°	B (2)	0.138					151	
21.51SN	0.016	0.006	20°	B (2)	0.138						30429
21.51SN	0.016	0.006	25°	B (2)	0.138						
21.51TN	0.016	0.007	25°	B (2)	0.138					161	
21.51EN	0.016			B (2)	0.138						00400
21.51FN	0.016			B (2)	0.138	80200					
21.51SN	0.016	0.007	30°	B (2)	0.138					181	
21.52SN	0.031	0.004	15°	B (2)	0.118					132	
21.52TN	0.031	0.006	20°	B (2)	0.118					142	
21.52SN	0.031	0.006	20°	B (2)	0.118					152	
21.52TN	0.031	0.007	25°	B (2)	0.118					162	
21.52SN	0.031	0.007	25°	B (2)	0.118					172	
21.52EN	0.031			B (2)	0.118					112	
32.5.5SN	0.008	0.004	15°	B (2)	0.154					133	
32.5.5TN	0.008	0.005	15°	A (1)	0.154		20400			143	
32.5.5TN	0.008	0.006	20°	B (2)	0.154					153	
32.5.5SN	0.008	0.006	20°	B (2)	0.154					163	
32.5.5TN	0.008	0.007	25°	B (2)	0.154					113	
32.5.5EN	0.008			B (2)	0.154						
32.5.5FN	0.008			A (1)	0.154		20300				
32.51SN	0.016	0.004	10°	B (2)	0.138					124	
32.51TN	0.016	0.004	15°	B (2)	0.138	80600					
32.51SN	0.016	0.005	15°	A (1)	0.138		20500				
32.51SN	0.016	0.005	15°	B (2)	0.138				13400		
32.51SN	0.016	0.006	15°	B (2)	0.138	80700					
32.51SN	0.016	0.006	20°	B (2)	0.138	80800					
32.51TN	0.016	0.006	20°	B (2)	0.138					144	
32.51SN	0.016	0.006	20°	B (2)	0.138					154	
32.51TN	0.016	0.007	25°	B (2)	0.138					164	
32.51FN	0.016			A (1)	0.138			20000			
32.51FN	0.016			B (2)	0.138	80500					
32.51SN	0.016	0.007	25°	B (2)	0.138					174	
32.51SN	0.016	0.007	30°	B (2)	0.138					184	

P											
M											
K						•	•	•	•	•	
N											
S						•	•	•	•	•	
H											•
O											

DCGW / DCGT

▲ TCE(NOI) = Design and number of equipped cutting edge corners

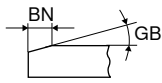

NEW CTBS10C	NEW CTBS20U	NEW CTBS20U	NEW CTBS20U	CTBS20C	NEW CTBH15U
F CBN DCGW	F CBN DCGW	F CBN DCGT	F CBN DCGW	F CBN DCGW	F CBN DCGW
71 424 ...	71 422 ...	71 421 ...	71 163 ...	71 163 ...	71 008 ...

ANSI	RE inch	BN inch	GB	TCE (NOI)	LE inch	71 424 ...	71 422 ...	71 421 ...	71 163 ...	71 163 ...	71 008 ...
32.52SN	0.031	0.004	10°	B (2)	0.118	81000					
32.52TN	0.031	0.004	15°	B (2)	0.118	81100					
32.52SN	0.031	0.004	15°	B (2)	0.118					135	
32.52TN	0.031	0.005	15°	A (1)	0.118		20600				
32.52SN	0.031	0.006	15°	B (2)	0.118	81200					
32.52SN	0.031	0.006	20°	B (2)	0.118	81300					
32.52TN	0.031	0.006	20°	B (2)	0.118					145	
32.52SN	0.031	0.006	20°	B (2)	0.118					155	
32.52TN	0.031	0.007	25°	B (2)	0.118					165	
32.52EN	0.031			B (2)	0.118	80900				115	
32.52FN	0.031			A (1)	0.118			20100			
32.52SN	0.031	0.007	30°	B (2)	0.118					185	

P											
M											
K						•	•	•	•	•	
N											
S						•	•	•	•	•	
H											•
O											

4

DCGW / DCGT

▲ TCE(NOI) = Design and number of equipped cutting edge corners

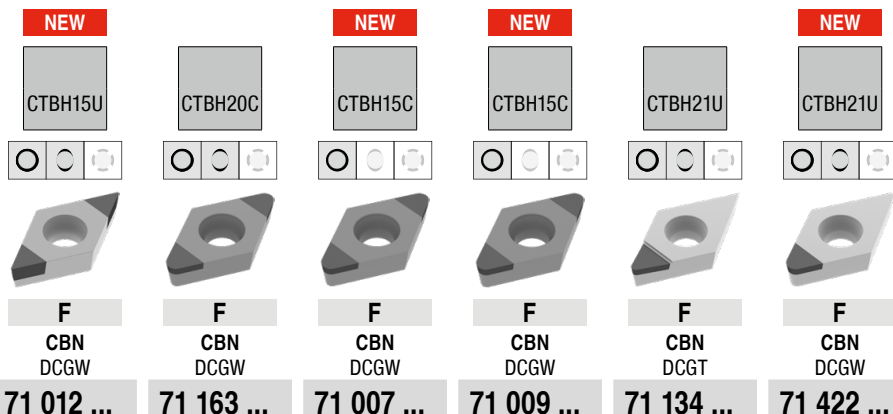
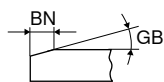

ANSI	RE inch	BN inch	GB	TCE (NOI)	LE inch	71 012 ...	71 163 ...	71 007 ...	71 009 ...	71 134 ...	71 422 ...
21.5.5SN	0.008	0.004	10°	B (2)	0.154		230				
21.5.5SN	0.008	0.004	15°	B (2)	0.154		240	30214			
21.5.5FN	0.008			A (1)	0.154					400	
21.5.5EN	0.008			B (2)	0.154			00200			
21.5.5SN	0.008	0.004	20°	B (2)	0.154		250				
21.5.5TN	0.008	0.005	25°	A (1)	0.154						40000
21.5.5TN	0.008	0.006	25°	B (2)	0.154		260				
21.51FN	0.016			B (2)	0.138		211				
21.51TN	0.016	0.005	25°	A (1)	0.138						40100
21.51FN	0.016			A (1)	0.138					402	
21.51EN	0.016			B (2)	0.138			00400			
21.51SN	0.016	0.004	15°	B (2)	0.138		241	30414			
21.51SN	0.016	0.006	25°	B (2)	0.138			30429			
21.51SN	0.016	0.004	10°	B (2)	0.138		231				
21.51SN	0.016	0.004	20°	B (2)	0.138		251				
21.51TN	0.016	0.006	25°	B (2)	0.138		261				
21.51SN	0.016	0.006	25°	B (2)	0.138		271				
21.52FN	0.031			B (2)	0.118		212				
21.52EN	0.031			B (2)	0.118	00600	222		00600		
21.52SN	0.031	0.004	15°	B (2)	0.118	30614			30614		
21.52SN	0.031	0.006	25°	B (2)	0.118	30629			30629		
21.52SN	0.031	0.004	10°	B (2)	0.118		232				
21.52SN	0.031	0.004	20°	B (2)	0.118		252				
21.52TN	0.031	0.006	25°	B (2)	0.118		262				
32.5.5SN	0.008	0.004	15°	B (2)	0.154		233				
32.5.5FN	0.008			A (1)	0.154					406	
32.5.5RN	0.008			B (2)	0.154			21400			
32.5.5SN	0.008	0.004	15°	B (2)	0.154		243	31414			
32.5.5SN	0.008	0.004	20°	B (2)	0.154		253				
32.5.5TN	0.008	0.006	25°	B (2)	0.154		263				
32.5.5SN	0.008	0.006	25°	B (2)	0.154			31429			
32.5.5SN	0.008	0.006	25°	B (2)	0.154		273				
32.51FN	0.016			B (2)	0.138		214				
32.51FN	0.016			A (1)	0.138					408	
32.51SN	0.016	0.004	15°	B (2)	0.138		244	31614			
32.51SN	0.016	0.006	25°	B (2)	0.138			31629			
32.51RN	0.016			B (2)	0.138			21600			
32.51EN	0.016			B (2)	0.138		224				
32.51SN	0.016	0.004	10°	B (2)	0.138		234				
32.51SN	0.016	0.004	20°	B (2)	0.138		254				
32.51TN	0.016	0.006	25°	B (2)	0.138		264				
32.51SN	0.016	0.006	25°	B (2)	0.138		274				
32.51SN	0.016	0.007	30°	B (2)	0.138		284				
32.52FN	0.031			B (2)	0.118		215				
32.52FN	0.031			A (1)	0.118					410	
32.52SN	0.031	0.004	15°	B (2)	0.118		245	31814			
32.52SN	0.031	0.006	25°	B (2)	0.118			31829			
32.52RN	0.031			B (2)	0.118			21800			
32.52EN	0.031			B (2)	0.118		225				
32.52SN	0.031	0.004	20°	B (2)	0.118		255				
32.52TN	0.031	0.006	25°	B (2)	0.118		265				
32.52SN	0.031	0.007	30°	B (2)	0.118		285				

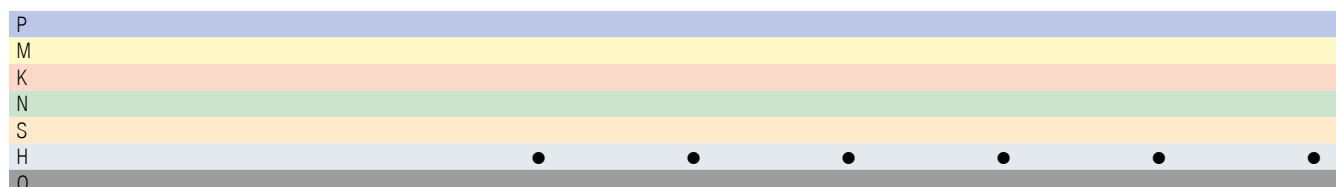

DCGW / DCGT

▲ TCE(NOI) = Design and number of equipped cutting edge corners

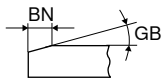

						NEW					NEW
						-Q					
						CTBH21U	CTBH20U	CTBH20U	CTBH40U	CTBH20C	CTBH21C
						F	F	F	F	F	F
						CBN	CBN	CBN	CBN	CBN	CBN
						DCGW	DCGW	DCGW	DCGT	DCGW	DCGW
						71 423 ...	71 130 ...	71 131 ...	71 134 ...	71 163 ...	71 424 ...
ANSI	RE	BN	GB	TCE	LE						
	inch	inch		(NOI)	inch						
21.50FL	0.004			A (1)	0.118	40000					
21.50FR	0.004			A (1)	0.118	40100					
21.5.5SN	0.008	0.004	10°	B (2)	0.154					230	
21.5.5SN	0.008	0.004	15°	B (2)	0.154					240	
21.5.5SN	0.008	0.004	20°	B (2)	0.154					250	
21.5.5EN	0.008			B (2)	0.134						90000
21.5.5FN	0.008			A (1)	0.154						
21.5.5TN	0.008	0.004	20°	B (2)	0.134	400 ¹⁾			800		90100
21.5.5TN	0.008	0.005	20°	B (2)	0.154			53000			
21.5.5TN	0.008	0.005	20°	A (1)	0.154	500					
21.5.5TN	0.008	0.006	25°	B (2)	0.154					260	
21.51SN	0.016	0.004	10°	B (2)	0.138					231	
21.51SN	0.016	0.004	10°	B (2)	0.118						90300
21.51SN	0.016	0.004	15°	B (2)	0.138					241	
21.51SN	0.016	0.004	20°	B (2)	0.138					251	
21.51EN	0.016			B (2)	0.118						90200
21.51FN	0.016			B (2)	0.138					211	
21.51FN	0.016			A (1)	0.138				802		
21.51TN	0.016	0.004	20°	B (2)	0.118	402 ¹⁾					90400
21.51TN	0.016	0.005	20°	B (2)	0.138			53200			
21.51TN	0.016	0.005	20°	A (1)	0.138	502					
21.51TN	0.016	0.006	25°	B (2)	0.138					261	
21.51SN	0.016	0.006	25°	B (2)	0.138					271	
21.52SN	0.031	0.004	10°	B (2)	0.118					232	
21.52SN	0.031	0.004	20°	B (2)	0.118					252	
21.52EN	0.031			B (2)	0.102						90500
21.52FN	0.031			B (2)	0.118					212	
21.52EN	0.031			B (2)	0.118					222	
21.52FN	0.031			A (1)	0.118						
21.52TN	0.031	0.004	20°	B (2)	0.102	404 ¹⁾					90600
21.52TN	0.031	0.005	20°	A (1)	0.118	504					
21.52TN	0.031	0.006	25°	B (2)	0.118					262	
21.52TN	0.031	0.006	35°	B (2)	0.102						90700
32.5.5SN	0.008	0.004	15°	B (2)	0.154					233	
32.5.5SN	0.008	0.004	15°	B (2)	0.154					243	
32.5.5SN	0.008	0.004	20°	B (2)	0.154					253	
32.5.5EN	0.008			B (2)	0.134						90800
32.5.5FN	0.008			A (1)	0.154						
32.5.5FN	0.008			B (2)	0.154	406 ¹⁾			806		
32.5.5TN	0.008	0.004	20°	B (2)	0.134			400 ¹⁾			90900
32.5.5TN	0.008	0.005	20°	B (2)	0.154			500			
32.5.5TN	0.008	0.005	20°	A (1)	0.154	506					
32.5.5TN	0.008	0.006	25°	B (2)	0.154					263	
32.5.5SN	0.008	0.006	25°	B (2)	0.154					273	
32.51SN	0.016	0.004	10°	B (2)	0.138					234	
32.51SN	0.016	0.004	10°	B (2)	0.118						91000
32.51TN	0.016	0.004	15°	B (2)	0.118						91100
32.51SN	0.016	0.004	15°	B (2)	0.138						
										244	

P											
M											
K											
N											
S											
H											
O											

1) Machining to 60 HRC

DCGW / DCGT

▲ TCE(NOI) = Design and number of equipped cutting edge corners

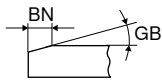

NEW					NEW
-Q					
CTBH21U	CTBH20U	CTBH20U	CTBH40U	CTBH20C	CTBH21C
F	F	F	F	F	F
CBN DCGW	CBN DCGW	CBN DCGW	CBN DCGT	CBN DCGW	CBN DCGW
71 423 ...	71 130 ...	71 131 ...	71 134 ...	71 163 ...	71 424 ...

ANSI	RE inch	BN inch	GB	TCE (NOI)	LE inch	71 423 ...	71 130 ...	71 131 ...	71 134 ...	71 163 ...	71 424 ...
32.51SN	0.016	0.004	20°	B (2)	0.138					254	
32.51FN	0.016			B (2)	0.138					214	
32.51EN	0.016			B (2)	0.138			402 ¹⁾		224	
32.51FN	0.016			A (1)	0.138		408 ¹⁾		808		
32.51TN	0.016	0.004	20°	B (2)	0.118						91200
32.51TN	0.016	0.005	20°	B (2)	0.138			502			
32.51TN	0.016	0.005	20°	A (1)	0.138		508				
32.51TN	0.016	0.006	25°	B (2)	0.138					264	
32.51SN	0.016	0.006	25°	B (2)	0.118						91300
32.51SN	0.016	0.006	25°	B (2)	0.138					274	
32.51TN	0.016	0.006	30°	B (2)	0.118						91400
32.51SN	0.016	0.007	30°	B (2)	0.138					284	
32.52SN	0.031	0.004	15°	B (2)	0.118					245	
32.52SN	0.031	0.004	20°	B (2)	0.118					255	
32.52EN	0.031			B (2)	0.102						91500
32.52FN	0.031			B (2)	0.118			404 ¹⁾		215	
32.52EN	0.031			B (2)	0.118					225	
32.52FN	0.031			A (1)	0.118		410 ¹⁾		810		
32.52TN	0.031	0.004	20°	B (2)	0.102						91600
32.52TN	0.031	0.005	20°	B (2)	0.118			504			
32.52TN	0.031	0.005	20°	A (1)	0.118		510				
32.52TN	0.031	0.006	25°	B (2)	0.118					265	
32.52TN	0.031	0.006	30°	B (2)	0.102						91700
32.52SN	0.031	0.007	30°	B (2)	0.118					285	

P											
M											
K											
N											
S											
H						•	•	•	•	•	•
O											

1) Machining to 60 HRC

DCGW

▲ TCE(NOI) = Design and number of equipped cutting edge corners

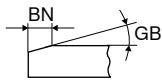

	CTBH40U	CTBH40U	CTBH40C	NEW CTBH41C					
	F	F	F	F					
	CBN DCGW	CBN DCGW	CBN DCGW	CBN DCGW					
	71 130 ...	71 131 ...	71 163 ...	71 424 ...					
ANSI									
RE									
BN									
GB									
TCE (NOI)									
LE									
21.5.5TN	0.008	0.004	10°	B (2)	0.134				
21.5.5TN	0.008	0.004	20°	B (2)	0.154				
21.5.5SN	0.008	0.004	25°	B (2)	0.154			320	
21.5.5FN	0.008			B (2)	0.134			350	
21.5.5EN	0.008			B (2)	0.154				00101
21.5.5FN	0.008			A (1)	0.154			310	
21.5.5TN	0.008	0.004	25°	B (2)	0.154	800		340	
21.5.5TN	0.008	0.005	25°	B (2)	0.118				
21.5.5TN	0.008	0.005	25°	A (1)	0.154	900		93000	
21.5.5TN	0.008	0.006	30°	B (2)	0.154			360	
21.5.5SN	0.008	0.006	30°	B (2)	0.154			370	
21.5.5SN	0.008	0.007	35°	B (2)	0.154			380	
21.51TN	0.016	0.004	10°	B (2)	0.118				00401
21.51SN	0.016	0.004	20°	B (2)	0.138			331	
21.51SN	0.016	0.004	25°	B (2)	0.138			351	
21.51FN	0.016			B (2)	0.118				00301
21.51FN	0.016			A (1)	0.138	802			
21.51TN	0.016	0.004	25°	B (2)	0.138			341	
21.51TN	0.016	0.005	25°	B (2)	0.118				
21.51TN	0.016	0.005	25°	A (1)	0.138	902		93200	
21.51SN	0.016	0.006	25°	B (2)	0.118				00501
21.51TN	0.016	0.006	30°	B (2)	0.138			361	
21.51SN	0.016	0.006	30°	B (2)	0.138			371	
21.51SN	0.016	0.006	35°	B (2)	0.118				00601
21.51SN	0.016	0.007	35°	B (2)	0.138			381	
21.52SN	0.031	0.004	20°	B (2)	0.118			332	
21.52SN	0.031	0.005	20°	B (2)	0.102				00701
21.52SN	0.031	0.004	25°	B (2)	0.118			352	
21.52EN	0.031			B (2)	0.118			312	
21.52FN	0.031			A (1)	0.118	804			
21.52TN	0.031	0.004	25°	B (2)	0.118			342	
21.52TN	0.031	0.005	25°	B (2)	0.118				
21.52TN	0.031	0.005	25°	A (1)	0.118	904		93400	
21.52TN	0.031	0.006	30°	B (2)	0.118			362	
21.52SN	0.031	0.006	30°	B (2)	0.118			372	
21.52SN	0.031	0.006	35°	B (2)	0.102				00801
21.52SN	0.031	0.007	35°	B (2)	0.118			382	
32.5.5TN	0.008	0.004	20°	B (2)	0.154			323	
32.5.5SN	0.008	0.005	20°	B (2)	0.134				01001
32.5.5SN	0.008	0.004	25°	B (2)	0.154			353	
32.5.5FN	0.008			B (2)	0.134				00901
32.5.5EN	0.008			B (2)	0.154			313	
32.5.5FN	0.008			B (2)	0.154				
32.5.5FN	0.008			A (1)	0.154	806			
32.5.5TN	0.008	0.004	25°	B (2)	0.154			800 ¹⁾	
32.5.5TN	0.008	0.005	25°	A (1)	0.154	906		343	
32.5.5TN	0.008	0.005	25°	B (2)	0.118				
32.5.5TN	0.008	0.005	25°	B (2)	0.118			900	
32.5.5TN	0.008	0.006	30°	B (2)	0.154			363	
32.5.5SN	0.008	0.007	35°	B (2)	0.154			383	

P	
M	
K	
N	
S	
H	●
O	●

1) Machining to 60 HRC

DCGW

▲ TCE(NOI) = Design and number of equipped cutting edge corners

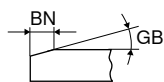

	CTBH40U	CTBH40U	CTBH40C	NEW CTBH41C
	F	F	F	F
	CBN DCGW	CBN DCGW	CBN DCGW	CBN DCGW
	71 130 ...	71 131 ...	71 163 ...	71 424 ...
ANSI				
RE				
BN				
GB				
TCE (NOI)				
LE				
32.51SN				01201
32.51TN				
32.51SN			324	
32.51SN			334	
32.51SN				01301
32.51SN			354	
32.51TN			344	
32.51FN				01101
32.51EN				
32.51FN			314	
32.51FN				
32.51FN				
32.51TN	808	802 ¹⁾		
32.51TN		902		
32.51TN	908			
32.51SN				01401
32.51TN			364	
32.51SN				01501
32.51SN			374	
32.51SN			384	
32.52TN				01701
32.52SN				
32.52TN			335	
32.52SN			325	
32.52SN			355	
32.52FN				01601
32.52FN				
32.52TN				
32.52TN		804 ¹⁾		
32.52TN		904	345	
32.52TN	910			
32.52SN				01801
32.52TN			365	
32.52SN				01901
32.52SN			375	
32.52SN			385	

P	
M	
K	
N	
S	
H	•
O	•

1) Machining to 60 HRC

DCGW / DCGT

Designation	L inch	S inch	D1 inch	IC inch
DCG. 21..	0.305	0.094	0.110	0.250
DCG. 32..	0.457	0.156	0.173	0.375

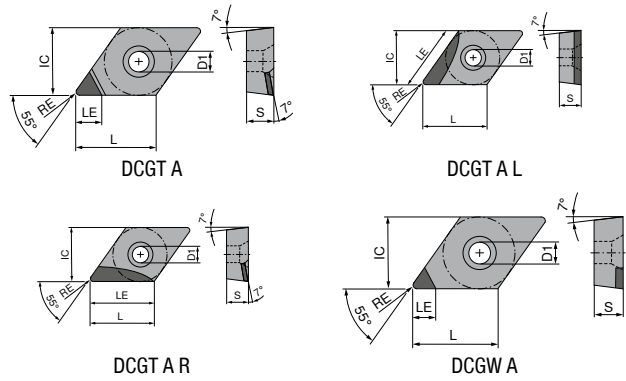

DCGW / DCGT

▲ TCE(NOI) = Design and number of equipped cutting edge corners

ANSI	RE inch	TCE (NOI)	LE inch	CTDMD05		NEW -Q CTDMD05		CTDPD20	
				71 130 ...	71 134 ...	71 178 ...	71 176 ...	71 130 ...	71 134 ...
21.5.FN	0.008	A (1)	0.098	00200	050				
21.5.FN	0.008	A (1)	0.146					100	100
21.51.FN	0.016	A (1)	0.098	00400	052				
21.51.FR	0.016	A (1)	0.098				50001		
21.51.FN	0.016	A (1)	0.134					102	102
21.52.FN	0.031	A (1)	0.098	00600	054			104	104
21.52.FN	0.031	A (1)	0.118						
32.5.FN	0.008	A (1)	0.098		056				
32.5.FN	0.008	A (1)	0.118	056					
32.5.FN	0.008	A (1)	0.185					106	106
32.51.FN	0.016	A (1)	0.098		058				
32.51.FL	0.016	A (1)	0.118			50001			
32.51.FN	0.016	A (1)	0.118	058					
32.51.FN	0.016	A (1)	0.169					108	108
32.52.FN	0.031	A (1)	0.098		060				
32.52.FN	0.031	A (1)	0.157					110	110
32.53.FN	0.047	A (1)	0.138						11200
32.53.FN	0.047	A (1)	0.142					11200	

P									
M									
K									
N									
S				•	•	•	•	•	•
H									
O				•	•	•	•	•	•

DCGW / DCGT

▲ TCE(NOI) = Design and number of equipped cutting edge corners

ANSI	RE inch	TCE (NOI)	LE inch	NEW					
				CTDPS30	CTDPS30	CTDPS30	CTDPS30	-CB1 CTDPU20	-CB2 CTDPU20
				F	F	F	F	F	M
				DIAMOND DCGW	DIAMOND DCGT	DIAMOND DCGT	DIAMOND DCGT	DIAMOND DCGT	DIAMOND DCGT
				71 177 ...	71 173 ...	71 173 ...	71 173 ...	71 174 ...	71 175 ...
21.50FN	0.004	A (1)	0.150	20001		20001			
21.5.5FN	0.008	A (1)	0.146	20101		20101		30001	
21.51FN	0.016	A (1)	0.134	20201				30101	30001
21.51FL	0.016	A (1)	0.217		20201				
21.52FN	0.031	A (1)	0.118	20301					
32.50FN	0.004	A (1)	0.189	20401		20301			
32.5.5FN	0.008	A (1)	0.185	20501		20401			
32.51FN	0.016	A (1)	0.169	20601				30201	30101
32.51FL	0.016	A (1)	0.295		20501				
32.52FN	0.031	A (1)	0.157	20701				30301	
32.52FL	0.031	A (1)	0.276		20601				
32.52FR	0.031	A (1)	0.276				20701		
32.53FN	0.047	A (1)	0.142	20801					
32.53FL	0.047	A (1)	0.256		20801				
32.53FR	0.047	A (1)	0.256				20901		
P									
M									
K									
N				•	•	•	•	•	•
S									
H									
O				•	•	•	•	•	•

DCGT / DCGW

▲ TCE(NOI) = Design and number of equipped cutting edge corners

ANSI	RE inch	TCE (NOI)	LE inch	71 136 ...	71 135 ...	71 144 ...	71 145 ...	71 310 ...	71 138 ...
21.50FN	0.004	A (1)	0.150					10100	
21.5.5FN	0.008	A (1)	0.146					102	
21.51FL	0.016	A (1)	0.118						
21.51FR	0.016	A (1)	0.118			104	104		
21.51FN	0.016	A (1)	0.134					104	
21.51FR	0.016	A (1)	0.217		102				
21.51FL	0.016	A (1)	0.217	102					
21.52FN	0.031	A (1)	0.118		104			108	
21.52FR	0.031	A (1)	0.197						
21.52FL	0.031	A (1)	0.197	104					
32.50FN	0.004	A (1)	0.189					11100	
32.5.5FR	0.008	A (1)	0.157						162
32.5.5FN	0.008	A (1)	0.185					112	
32.51FL	0.016	A (1)	0.157						
32.51FR	0.016	A (1)	0.157			114	114		164
32.51FN	0.016	A (1)	0.169					114	
32.51FR	0.016	A (1)	0.295		108				
32.51FL	0.016	A (1)	0.295	108					
32.52FN	0.031	A (1)	0.157		110			118	
32.52FR	0.031	A (1)	0.276						
32.52FL	0.031	A (1)	0.276	110					

P									
M									
K									
N		•	•	•	•	•	•	•	•
S									
H									
O		•	•	•	•	•	•	•	•

4

DCGW / DCGT

▲ TCE(NOI) = Design and number of equipped cutting edge corners

ANSI	RE inch	TCE (NOI)	LE inch	Insert Options					
				-Q CTDPS30	-Q CTDPS30	-Q CTDPS30	-CB1 CTDPS30	-CB2 CTDPS30	-CB3 CTDPU20
				F DIAMOND DCGW	F DIAMOND DCGT	F DIAMOND DCGT	F DIAMOND DCGT	M DIAMOND DCGT	R DIAMOND DCGT
				71 139 ...	71 144 ...	71 145 ...	71 310 ...	71 311 ...	71 312 ...
21.50FL	0.004	A (1)	0.118			151			
21.50FR	0.004	A (1)	0.118		15000				
21.50FN	0.004	A (1)	0.150				20100		
21.5.5FL	0.008	A (1)	0.118			152			
21.5.5FR	0.008	A (1)	0.118		152				
21.5.5FN	0.008	A (1)	0.146				202 204	202 204 208	
21.51FN	0.016	A (1)	0.134						204
21.52FN	0.031	A (1)	0.118						
32.50FR	0.004	A (1)	0.157		161				
32.50FL	0.004	A (1)	0.157			161			
32.50FN	0.004	A (1)	0.189				21100	21100	
32.5.5FL	0.008	A (1)	0.157			162			
32.5.5FR	0.008	A (1)	0.157		162				
32.5.5FN	0.008	A (1)	0.185				212	212	
32.51FL	0.016	A (1)	0.157	164			214 218		
32.51FN	0.016	A (1)	0.169					214 218	214 218
32.52FN	0.031	A (1)	0.157						
P									
M									
K									
N				•	•	•	•	•	•
S									
H									
O				•	•	•	•	•	•

DCGT / DCGW

▲ TCE(NOI) = Design and number of equipped cutting edge corners

	-CB3 CTDPU20	NEW CTDPU20	NEW CTDCD10	-CB1 CTDCD10	-CB2 CTDCD10
	R DIAMOND DCGT	F DIAMOND DCGW	F DIAMOND DCGW	F DIAMOND DCGT	M DIAMOND DCGT
	71 312 ...	71 177 ...	71 177 ...	71 310 ...	71 311 ...
21.5.5FN			40001	302	30200
21.51FN			40101	304	304
21.51FN	204	30001			
21.52FN			40201		308
21.52FN		30101			
32.5.5FN			40301	31200	31200
32.51FN			40401	314	314
32.51FN	214	30201			
32.52FN			40501	318	318
32.52FN	218	30301			

ANSI	RE inch	TCE (NOI)	LE inch
21.5.5FN	0.008	A (1)	0.102
21.51FN	0.016	A (1)	0.091
21.51FN	0.016	A (1)	0.134
21.52FN	0.031	A (1)	0.079
21.52FN	0.031	A (1)	0.118
32.5.5FN	0.008	A (1)	0.102
32.51FN	0.016	A (1)	0.091
32.51FN	0.016	A (1)	0.169
32.52FN	0.031	A (1)	0.079
32.52FN	0.031	A (1)	0.157

P					
M					
K					
N		•	•	•	•
S					
H					
O		•	•	•	•

4

MaxiLock-S – SDJC 93° – Toolholder with screw clamping

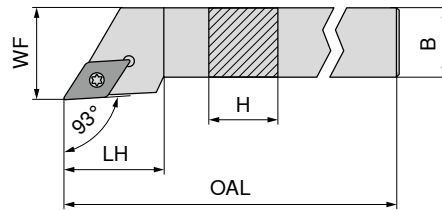

Illustrations show right-hand versions



Designation	H inch	B inch	OAL inch	LH inch	WF inch	Insert
SDJC R/L 06-2	0.375	0.375	2.500	0.590	0.500	DC..21.5..
SDJC R/L 08-2	0.500	0.500	3.500	0.670	0.625	DC..21.5..
SDJC R/L 10-2	0.625	0.625	4.000	0.670	0.750	DC..21.5..
SDJC R/L 12-2B	0.750	0.750	4.500	0.708	1.000	DC..21.5..
SDJC R/L 12-3B	0.750	0.750	4.500	1.000	1.000	DC..32.5..
SDJC R/L 16-3D	1.000	1.000	6.000	1.100	1.250	DC..32.5..

Left-hand 78 555 ...	Right-hand 78 554 ...
00602	00602
00802	00802
01002	01002
01222	01222
01223	01223
01643	01643

Spare parts for Article no.

78 554 00602 / 78 555 00602	06400	06200		
78 554 00802 / 78 555 00802	06400	06200		
78 554 01002 / 78 555 01002	06400	06200		
78 554 01222 / 78 555 01222	06400	06200		
78 554 01223 / 78 555 01223	05400	05100	06000	05300
78 554 01643 / 78 555 01643	05400	05100	06000	05300

Key I	Clamping screw	Solid Carbide Seat D	Threaded sleeve
78 950 ...	78 950 ...	78 950 ...	78 950 ...

MaxiLock-S – SDPC 62.5° – Toolholder with screw clamping

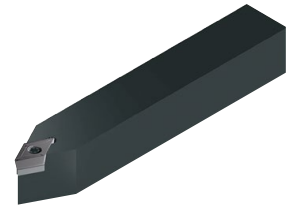
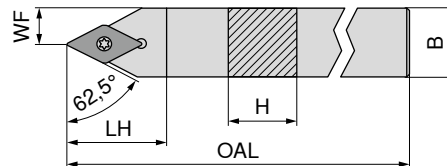

Designation	H inch	B inch	OAL inch	LH inch	WF inch	Insert
SDPC N 06-2	0.375	0.375	2.500	0.370	0.197	DC..21.5..
SDPC N 08-2	0.500	0.500	3.500	0.492	0.260	DC..21.5..
SDPC N 10-3	0.625	0.625	4.000	0.630	0.232	DC..32.5..
SDPC N 12-3B	0.750	0.750	4.500	0.744	0.382	DC..32.5..
SDPC N 16-3D	1.000	1.000	6.000	0.984	0.520	DC..32.5..

Neutral
78 582 ...

Spare parts for Article no.

78 582 00602	06400	06200		
78 582 00802	06400	06200		
78 582 01003	05400	05100	06000	05300
78 582 01223	05400	05100	06000	05300
78 582 01643	05400	05100	06000	05300

Key I	Clamping screw	Solid Carbide Seat D	Threaded sleeve
78 950 ...	78 950 ...	78 950 ...	78 950 ...

MaxiLock-S – SDUC 93° – Boring bar with screw clamping

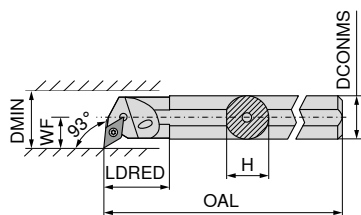

Illustrations show right-hand versions



Designation	DCONMS inch	H inch	OAL inch	LDRED inch	WF inch	DMIN inch	Insert	Left-hand		Right-hand	
								78 721 ...	78 720 ...	78 721 ...	78 720 ...
S06M SDUC R/L 2	0.375	0.340	6.000	0.830	0.375	0.750	DC..21.5..	20617		20617	
A06M SDUC R/L 2	0.375	0.340	6.000	0.830	0.375	0.750	DC..21.5..	20606		20606	
S08M SDUC R/L 2	0.500	0.460	6.000	0.910	0.438	0.875	DC..21.5..	20818		20818	
A08M SDUC R/L 2	0.500	0.460	6.000	0.910	0.438	0.875	DC..21.5..	20808		20808	
S10R SDUC R/L 2	0.625	0.580	8.000	1.060	0.500	1.000	DC..21.5..	21021		21021	
A10R SDUC R/L 2	0.625	0.580	8.000	1.060	0.500	1.000	DC..21.5..	21010		21010	
S12S SDUC R/L 2EX	0.750	0.710	10.000	0.760	0.625	1.250	DC..21.5..	21222		21222	
S16T SDUC R/L 2DX	1.000	0.900	12.000	1.000	0.750	1.500	DC..21.5..	21626		21626	
S12S SDUC R/L 3M	0.750	0.710	10.000	1.580	0.625	1.250	DC..32.5..	91222		91222	
A12S SDUC R/L 3M	0.750	0.710	10.000	1.580	0.625	1.250	DC..32.5..	91212		91212	
S16T SDUC R/L 3M	1.000	0.910	12.000	1.810	0.750	1.500	DC..32.5..	91626		91626	
S20U SDUC R/L 3M	1.250	1.180	14.000	1.890	0.875	1.750	DC..32.5..	92030		92030	
S20U SDUC R/L 3X	1.250	1.180	14.000	1.270	0.765	1.750	DC..32.5..	32030		32030	

4

Key I	Clamping screw	Solid Carbide Seat D	Threaded sleeve
78 950 ...	78 950 ...	78 950 ...	78 950 ...
	06400	05200	
	06400	05200	
	06400	05200	
	06400	06200	
	06400	05200	
	06400	06200	
	06400	06200	
	05700	05600	
	05700	05600	
	05700	05600	
	05400	05100	06000
	05400	05100	06000
			05300
			05300

**Spare parts
for Article no.**

78 720 20617 / 78 721 20617
78 720 20606 / 78 721 20606
78 720 20818 / 78 721 20818
78 720 20808 / 78 721 20808
78 720 21021 / 78 721 21021
78 720 21010 / 78 721 21010
78 720 21222 / 78 721 21222
78 720 21626 / 78 721 21626
78 720 91222 / 78 721 91222
78 720 91212 / 78 721 91212
78 720 91626 / 78 721 91626
78 720 92030 / 78 721 92030
78 720 32030 / 78 721 32030

RCMT / RCGT

Designation	S inch	D1 inch	IC inch
RCGT 06..	0.094	0.110	0.236
RCGT 08..	0.125	0.134	0.315
RC.T 10..	0.125	0.157	0.394
RCMT 12..	0.187	0.193	0.472
RCMT 16..	0.250	0.209	0.630
RCMT 20..	0.250	0.256	0.787
RCMT 25..	0.313	0.283	0.984

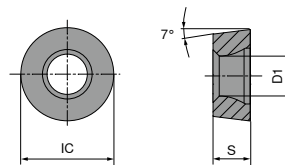

RCMT / RCGT

ANSI	RE inch	Insert Options					
		-SMF CTCK110	-SM CTCP115	-SM CTCP125	-SM CTCP125	-SM CTCP135	-SM CTCP135
		DRAGONSKIN					
		F RCMT	M RCMT	M RCGT	M RCMT	M RCGT	M RCMT
		70 188 ...	76 264 ...	76 262 ...	76 264 ...	76 262 ...	76 264 ...
0602MOEN	0.118			502		702	
0803MOEN	0.157			512		712	
1003MOSN	0.197				514		714
1204MOSN	0.236		328		526		726
1606MOEN	0.315	038			538		738
1606MOSN	0.315		340		550		750
2006MOSN	0.394				562		762
2507MOSN	0.492		36200				
P		○	●	●	●	●	●
M							
K		●	○	○	○	○	○
N							
S							
H							
O							

RCGT

	-27 H10T	-27 CWN15	NEW -27 CTPX715
			DRAGONSKIN
	M	M	M
	RCGT	RCGT	RCGT
	70 266 ...	70 266 ...	70 266 ...
	600	300	
	602	302	80200
	604		80400

ANSI	RE inch			
0602MOFN	0.118			
0803MOFN	0.157			
082MOFN	0.157			
1003MOFN	0.197			
102MOFN	0.197			
P				●
M			○	●
K		○		○
N		●	●	●
S				●
H				
O		○		○

4

RCGW

Designation	S inch	D1 inch	IC inch
RCGW 12..	0.187	0.173	0.472

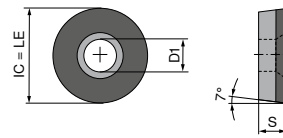

RCGW F

RCGW

▲ TCE(NOI) = Design and number of equipped cutting edge corners

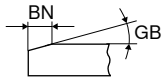

NEW

CTBS10U

F
CBN
RCGW

71 425 ...

10000

ANSI	RE inch	BN inch	GB	TCE (NOI)	LE inch
1204M0TN	0.236	0.005	20°	F	0.472

P	
M	
K	•
N	
S	•
H	
O	

RCGW / RCGT

Designation	S inch	D1 inch	IC inch
RCG. 06..	0.094	0.110	0.236
RCGW 08..	0.125	0.134	0.315
RCG. 10..	0.156	0.173	0.394
RCGW 12..	0.187	0.173	0.472

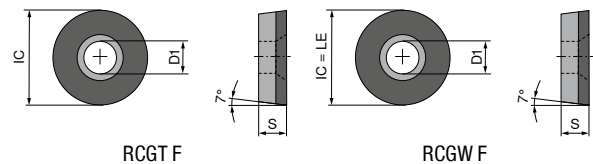

RCGW / RCGT

▲ TCE(NOI) = Design and number of equipped cutting edge corners

	NEW CTDPD20	-CB1 CTDPD20	NEW CTDPS30	-CB1 CTDPS30	-CB2 CTDPS30
	F	F	F	F	M
	DIAMOND RCGW	DIAMOND RCGT	DIAMOND RCGW	DIAMOND RCGT	DIAMOND RCGT
	71 179 ...	71 315 ...	71 179 ...	71 315 ...	71 316 ...
ANSI	RE inch	TCE (NOI)	LE inch		
0803M0FN	0.157	F	0.315	10101	20101
0602M0FN	0.118	F	0.236	10001	102 20001 202
10T3M0FN	0.197	F	0.394	104	204
1003M0FN	0.236	F	0.394	10201	
1204M0FN	0.236	F	0.472	10301	

P					
M					
K					
N		•	•	•	•
S					
H					
O		•	•	•	•

4

MaxiLock-S – SRDC 0° – Toolholder with screw clamping

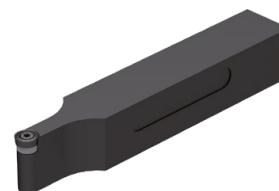
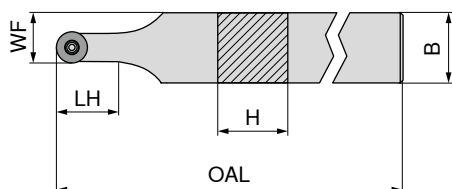

Neutral
78 583 ...

Designation	H inch	B inch	OAL inch	LH inch	WF inch	Insert
SRDC N 08-2	0.500	0.500	3.500	0.500	0.407	RC..0803M0
SRDC N 10-3	0.625	0.625	4.000	0.630	0.510	RC..10T3M0
SRDC N 12-3B	0.750	0.750	4.500	1.000	0.570	RC..10T3M0
SRDC N 16-4D	1.000	1.000	6.000	1.000	0.756	RC..1204M0
SRDC N 20-4D	1.250	1.250	6.000	1.000	0.861	RC..1204M0

00802
01003
01223
01644
02044

Key I	Clamping screw	Solid carbide support R	Threaded sleeve
78 950 ...	78 950 ...	78 950 ...	78 950 ...

Spare parts for Article no.

78 583 00802	00100	00200		
78 583 01003	05400	05100	05900	05300
78 583 01223	05400	05100	05900	05300
78 583 01644	05400	05100	06300	05300
78 583 02044	05400	05100	06300	05300

MaxiLock-S – SRGC – Toolholder with screw clamping

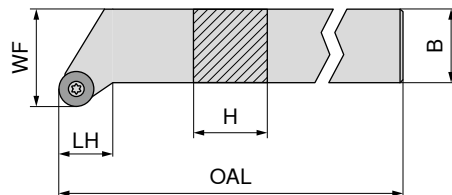

Illustrations show right-hand versions

Left-hand
78 557 ...

Right-hand
78 556 ...

Designation	H inch	B inch	OAL inch	WF inch	Insert
SRGC R/L 12-3B	0.750	0.750	4.500	1.000	RC..10T3M0
SRGC R/L 16-3D	1.000	1.000	6.000	1.250	RC..10T3M0
SRGC R/L 16-4D	1.000	1.000	6.000	1.250	RC..1204M0
SRGC R/L 20-4D	1.250	1.250	6.000	1.500	RC..1204M0
SRGC R/L 85-4D	1.250	1.000	6.000	1.250	RC..1204M0

01223
01643
01644
02044
08544

01223
01643
01644
02044
08544

Key I	Clamping screw	Solid carbide support R	Threaded sleeve
78 950 ...	78 950 ...	78 950 ...	78 950 ...

Spare parts for Article no.

78 556 01223 / 78 557 01223	05400	05100	05900	05300
78 556 01643 / 78 557 01643	05400	05100	05900	05300
78 556 01644 / 78 557 01644	05400	05100	06300	05300
78 556 02044 / 78 557 02044	05400	05100	06300	05300
78 556 08544 / 78 557 08544	05400	05100	06300	05300

MaxiLock-S – SRSC 45° – Toolholder with screw clamping

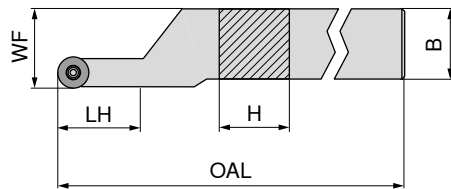

Illustrations show right-hand versions

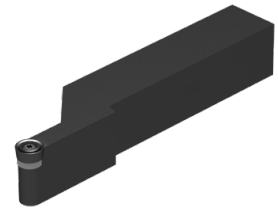

Designation	H inch	B inch	OAL inch	LH inch	WF inch	Insert
SRSC R/L 16-3D	1.000	1.000	6.000	0.750	1.250	RC..10T3M0
SRSC R/L 20-3D	1.250	1.250	6.000	0.750	1.500	RC..10T3M0
SRSC R/L 12-4B	0.750	0.750	4.500	0.750	1.000	RC..1204M0
SRSC R/L 16-4D	1.000	1.000	6.000	1.000	1.250	RC..1204M0
SRSC R/L 20-4D	1.250	1.250	6.000	1.000	1.500	RC..1204M0

Left-hand 78 559 ...	Right-hand 78 558 ...
01643	01643
02043	02043
01224	01224
01644	01644
02044	02044

Spare parts
for Article no.

Article no.	Key I 78 950 ...	Clamping screw 78 950 ...	Solid carbide support R 78 950 ...	Threaded sleeve 78 950 ...
78 558 01643 / 78 559 01643	05400	05100	05900	05300
78 558 02043 / 78 559 02043	05400	05100	05900	05300
78 558 01224 / 78 559 01224	05400	05100	06300	05300
78 558 01644 / 78 559 01644	05400	05100	06300	05300
78 558 02044 / 78 559 02044	05400	05100	06300	05300

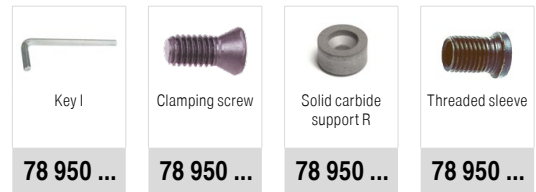

SCGT / SCMT / SCMX

Designation	L inch	S inch	D1 inch	IC inch
SC.T 32..	0.375	0.156	0.173	0.375
SC.. 43..	0.500	0.187	0.217	0.500

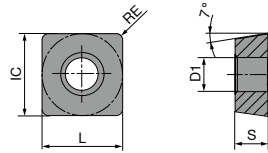

SCGT / SCMT

		-CF05 CTEP110	-CF55 CTEP110	-SF TCM10	-SF TCM407	-SF CTCP125	-SMF CTCP115	-SMF CTCP135
		DRAGONSKIN	DRAGONSKIN			DRAGONSKIN	DRAGONSKIN	DRAGONSKIN
		F	F	F	F	F	F	F
		CERMET SCGT	CERMET SCMT	CERMET SCGT	CERMET SCGT	SCMT	SCMT	SCMT
		76 261 ...	76 260 ...	70 271 ...	70 271 ...	76 269 ...	76 267 ...	76 267 ...
ANSI	RE inch							
32.51EN	0.016	004	004	902		504	304	
32.52EN	0.031	006	006	904	852	506	306	
432EN	0.031					518		718
P		●	●	●	●	●	●	●
M		○	○	○	○			○
K		○	○	○	○	○	○	
N								
S								
H								
O								

SCMT / SCMX

		-SM CTCK110	-SM CTCK120	-SM CTCP115	-SM CTCP125	-SM CTCP135	CTCP135
		DRAGONSKIN	DRAGONSKIN	DRAGONSKIN	DRAGONSKIN	DRAGONSKIN	DRAGONSKIN
		M	M	M	M	M	M
		SCMT	SCMT	SCMT	SCMT	SCMT	SCMX
		70 268 ...	70 268 ...	76 268 ...	76 268 ...	76 268 ...	76 182 ...
ANSI	RE inch						
32.51EN	0.016		004	504	304	504	704
32.52EN	0.031		006	506	306	506	706
432EN	0.031		018	518	318	518	718
433EN	0.047		020	520		520	718
P			○	○	●	●	●
M							○
K			●	●	○	○	
N							
S							
H							
O							

SCMT

ANSI	RE inch			
32.52EN	0.031		10600	206
432EN	0.031		11800	218
P			○	○
M			●	●
K				
N				
S				○
H				
O				

NEW		NEW		NEW
-M55 CTCM120	-M55 CTPM125	-M55 CTCM130		
DRAGONSKIN	DRAGONSKIN	DRAGONSKIN		
M	M	M		
SCMT	SCMT	SCMT		
75 216 ...	75 216 ...	75 216 ...		

4

SCGT

ANSI	RE inch				
32.51FN	0.016			80400	600
32.52FN	0.031			80600	602
432FN	0.031	634	71600		604
P			●	●	
M			●	●	○
K		○		○	○
N		●	●	●	●
S		○	●	●	
H					
O		○		○	○

	NEW	NEW		
-25P H210T	-25P CTPX710	-27 CTPX715	-27 H10T	-27 CWN15
	DRAGONSKIN	DRAGONSKIN		
F	M	M	M	M
SCGT	SCGT	SCGT	SCGT	SCGT
70 283 ...	70 283 ...	70 270 ...	70 270 ...	70 270 ...

SCGW

Designation	L inch	S inch	D1 inch	IC inch
SCGW 32..	0.375	0.156	0.173	0.375
SCGW 43..	0.500	0.187	0.217	0.500

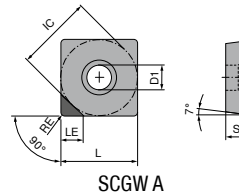

SCGW

▲ TCE(NOI) = Design and number of equipped cutting edge corners

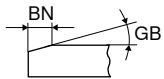

NEW

CTBS10U

F

CBN
SCGW

71 426 ...

ANSI	RE inch	BN inch	GB	TCE (NOI)	LE inch	
32.51TN	0.016	0.005	20°	A (1)	0.138	10100
32.51FN	0.016			A (1)	0.138	10000
32.52FN	0.031			A (1)	0.134	10200
32.52TN	0.031	0.005	20°	A (1)	0.134	10300
431FN	0.016			A (1)	0.138	10400
431TN	0.016	0.005	20°	A (1)	0.138	10500
432TN	0.031	0.005	20°	A (1)	0.134	10700
432FN	0.031			A (1)	0.134	10600

P	
M	
K	•
N	
S	•
H	
O	

SCGW / SCGT

Designation	L inch	S inch	D1 inch	IC inch
SCG. 32..	0.375	0.156	0.173	0.375
SCG. 43..	0.500	0.187	0.217	0.500

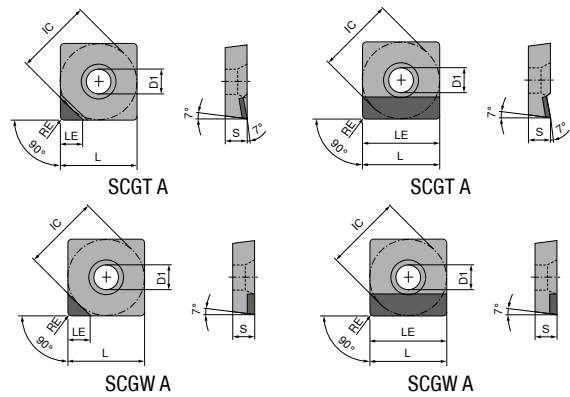

SCGW / SCGT

▲ TCE(NOI) = Design and number of equipped cutting edge corners

	NEW CTDPD20	NEW CTDPD20	-CB1 CTDPD20	NEW CTDPS30	NEW CTDPS30
	F	F	F	F	F
	DIAMOND SCGW	DIAMOND SCGW	DIAMOND SCGT	DIAMOND SCGW	DIAMOND SCGT
	71 182 ...	71 183 ...	71 320 ...	71 182 ...	71 180 ...
ANSI	RE inch	TCE (NOI)	LE inch		
32.51FN	0.016	A (1)	0.173		
32.51FNN	0.016	A (1)	0.375		
32.52FN	0.031	A (1)	0.169		
32.52FNN	0.031	A (1)	0.375		
32.53FN	0.047	A (1)	0.165		
431FN	0.016	A (1)	0.173		
431FNN	0.016	A (1)	0.500		
432FN	0.031	A (1)	0.169		
432FNN	0.031	A (1)	0.500		
433FN	0.047	A (1)	0.165		
433FNN	0.047	A (1)	0.500		

P					
M					
K					
N		•	•	•	•
S					
H					
O		•	•	•	•

4

SCGT

▲ TCE(NOI) = Design and number of equipped cutting edge corners

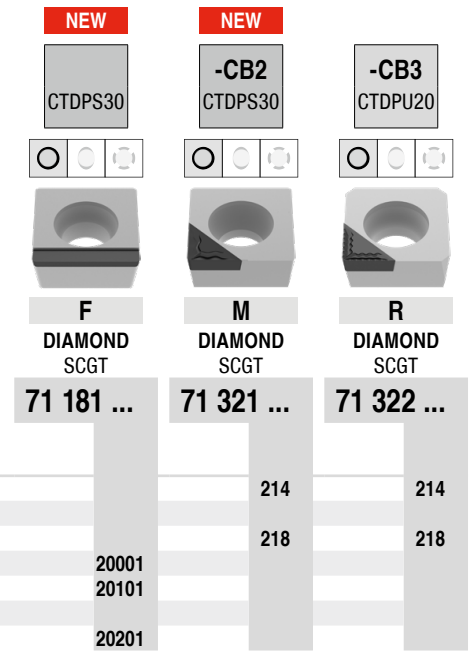

ANSI	RE inch	TCE (NOI)	LE inch
32.51FN	0.016	A (1)	0.173
32.52FN	0.031	A (1)	0.169
32.52FNN	0.031	A (1)	0.374
432FNN	0.031	A (1)	0.500
433FNN	0.047	A (1)	0.472

P			
M			
K			
N		•	•
S		•	•
H			
O		•	•

MaxiLock-S – SSDC 45° – Toolholder with screw clamping

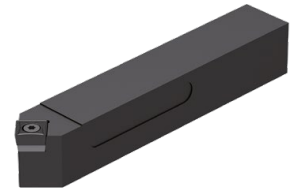
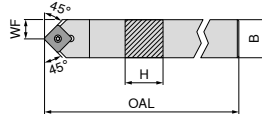

Neutral
78 584 ...

Designation	H inch	B inch	OAL inch	WF inch	Insert
SSDC N 08-3	0.500	0.500	3.500	0.263	SC..32.5..
SSDC N 10-3	0.625	0.625	4.000	0.325	SC..32.5..
SSDC N 12-4B	0.750	0.750	4.500	0.388	SC..43..

00803
01003
01224



Key I

78 950 ...



Clamping screw

78 950 ...



Solid Carbide support S

78 950 ...



Threaded sleeve

78 950 ...

**Spare parts
for Article no.**
78 584 00803
78 584 01003
78 584 01224

05700 **05600**
05700 **05600**
04700 **04600** **04400** **04800**

MaxiLock-S – SSKC 75° – Boring bar with screw clamping

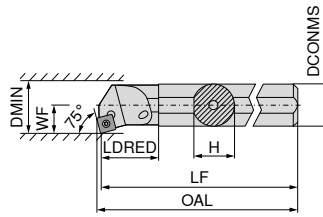

Illustrations show right-hand versions



Designation	DCONMS inch	H inch	OAL inch	LDRED inch	WF inch	DMIN inch	Insert
S10R SSKC R/L 3	0.625	0.580	8.000	1.060	0.406	0.812	SC..32.5..
S12S SSKC R/L 3	0.750	0.710	10.000	1.580	0.500	1.000	SC..32.5..
S16T SSKC R/L 3	1.000	0.900	12.000	1.810	0.640	1.280	SC..32.5..

Left-hand 78 723 ...	Right-hand 78 722 ...
31021	31021
31222	31222
31626	31626

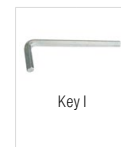

Key I

78 950 ...

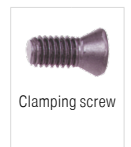

Clamping screw

78 950 ...

**Spare parts
for Article no.**

78 722 31021 / 78 723 31021	05700	05800
78 722 31222 / 78 723 31222	05700	05600
78 722 31626 / 78 723 31626	05700	05600

TCGT / TCMT

Designation	L inch	S inch	D1 inch	IC inch
TCMT 1...	0.378	0.094	0.098	0.219
TC.T 21..	0.433	0.094	0.110	0.250
TC.T 32..	0.650	0.156	0.173	0.375
TCMT 43..	0.866	0.187	0.203	0.500

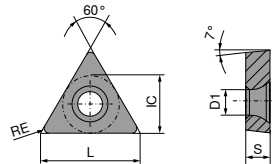

TCGT / TCMT

ANSI	RE inch	-CF05 CTEP110		-CF55 CTEP110		-SF TCM10		-SMF TCM10		-SF CTCP125		-SMF CTCP115	
		DRAGONSKIN		DRAGONSKIN		DRAGONSKIN		DRAGONSKIN		DRAGONSKIN		DRAGONSKIN	
		F CERMET TCGT		F CERMET TCMT		F CERMET TCGT		F CERMET TCMT		F CERMET TCMT		F CERMET TCMT	
		76 272 ...		76 266 ...		70 273 ...		70 284 ...		76 275 ...		76 284 ...	
21.5EN	0.008	014				900							
21.51EN	0.016	016		016		902		902		516			
21.52EN	0.031	018								518			318
32.51EN	0.016	028				906				528			328
32.52EN	0.031			030						530			330
P		●	●	●	●	●	●	●	●	●	●	●	●
M		○	○	○	○	○	○	○	○	○	○	○	○
K		○	○	○	○	○	○	○	○	○	○	○	○
N													
S													
H													
O													

4

TCMT / TCGT

		-SMF CTCP135	-SM CTCP135	-SM CTCK110	-SM CTCK120	-SM CTCP115	-SM CTCP125	-SM CTCP135
		DRAGONSKIN	DRAGONSKIN	DRAGONSKIN	DRAGONSKIN	DRAGONSKIN	DRAGONSKIN	DRAGONSKIN
		F	M	M	M	M	M	M
		TCMT	TCGT	TCMT	TCMT	TCMT	TCMT	TCMT
		76 284 ...	76 270 ...	70 274 ...	70 274 ...	76 274 ...	76 274 ...	76 274 ...
ANSI	RE inch							
1.81.51EN	0.016						504	704
21.5.5EN	0.008		714					
21.51EN	0.016			016	516	316	516	716
21.52EN	0.031	718		018	518	318		718
32.51EN	0.016			028	528	328	528	728
32.52EN	0.031			030	530	330	530	730
32.53EN	0.047			032	532			
432EN	0.031						542	742
P		●	●	○	○	●	●	●
M		○	○					○
K				●	●	○	○	
N								
S								
H								
O								

TCMT

		NEW -M25 CTCM120	-M25 CTPM125	NEW -M25 CTCM130	NEW -M55 CTCM120	-M55 CTPM125	NEW -M55 CTCM130
		DRAGONSKIN	DRAGONSKIN	DRAGONSKIN	DRAGONSKIN	DRAGONSKIN	DRAGONSKIN
		F	F	F	M	M	M
		TCMT	TCMT	TCMT	TCMT	TCMT	TCMT
		75 217 ...	75 217 ...	75 217 ...	75 218 ...	75 218 ...	75 218 ...
ANSI	RE inch						
1.81.51EN	0.016				10400	204	30400
21.51EN	0.016		11600	216	11600	216	31600
32.51EN	0.016		12800	228	32800		
32.52EN	0.031		13000	230	33000	230	33000
P		○	○	○	○	○	○
M		●	●	●	●	●	●
K							
N							
S					○		○
H							
O							

TCGT

	-27 H10T	-27 CWN15	NEW -27 CTPX715
			DRAGONSKIN
	M TCGT	M TCGT	M TCGT
	70 276 ...	70 276 ...	70 276 ...
	600		
	602	302	81600
		300	
	604	304	
	606	306	
	608	308	83000

ANSI	RE inch
21.5.FN	0.008
21.51FN	0.016
21.5FN	0.008
32.5.FN	0.008
32.51FN	0.016
32.52FN	0.031

P			●
M		○	●
K	○		○
N	●	●	●
S			●
H			
O	○		○

4

TCGW

Designation	L inch	S inch	D1 inch	IC inch
TCGW 1...	0.378	0.094	0.098	0.219
TCGW 21..	0.433	0.094	0.110	0.250
TCGW 32..	0.650	0.156	0.173	0.375

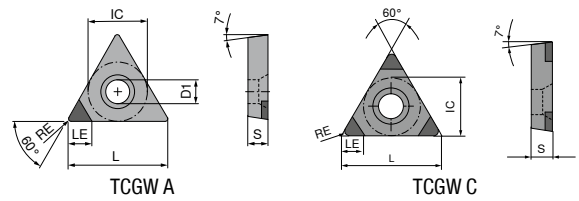

TCGW

▲ TCE(NOI) = Design and number of equipped cutting edge corners

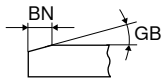

ANSI	RE inch	BN inch	GB	TCE (NOI)	LE inch	CTBS10U		NEW CTBH15U		NEW CTBH15U		CTBH20U		NEW CTBS20U		CTBS20C	
						F	CBN TCGW	F	CBN TCGW	F	CBN TCGW	F	CBN TCGW	F	CBN TCGW	F	CBN TCGW
						71 140 ...	71 028 ...	71 029 ...	71 140 ...	71 427 ...	71 164 ...						
1.81.5.5SN	0.008	0.004	10°	C (3)	0.102												120
1.81.5.5FN	0.008			A (1)	0.150												
1.81.5.5EN	0.008			C (3)	0.102												
1.81.5.5SN	0.008	0.004	15°	C (3)	0.102												130
1.81.5.5TN	0.008	0.005	20°	A (1)	0.150	300											140
1.81.5.5TN	0.008	0.006	20°	C (3)	0.102												150
1.81.5.5SN	0.008	0.006	20°	C (3)	0.102												
1.81.5.1SN	0.016	0.004	10°	C (3)	0.087												121
1.81.5.1SN	0.016	0.004	15°	C (3)	0.087			30414									131
1.81.5.1TN	0.016	0.005	15°	A (1)	0.138												
1.81.5.1TN	0.016	0.005	20°	A (1)	0.138	302								20000			
1.81.5.1SN	0.016	0.006	20°	C (3)	0.087												151
1.81.5.1EN	0.016			C (3)	0.087			00400									111
1.81.5.1FN	0.016			A (1)	0.138	202											161
1.81.5.1TN	0.016	0.007	25°	C (3)	0.087												
1.81.5.2SN	0.031	0.004	10°	C (3)	0.071												122
1.81.5.2SN	0.031	0.004	15°	C (3)	0.071			30614									132
1.81.5.2TN	0.031	0.005	20°	A (1)	0.118												
1.81.5.2TN	0.031	0.006	20°	C (3)	0.071												142
1.81.5.2EN	0.031			C (3)	0.071			00600									
1.81.5.2TN	0.031	0.007	25°	C (3)	0.071												162
21.5.5SN	0.008	0.004	10°	C (3)	0.114												123
21.5.5FN	0.008			A (1)	0.150	206											
21.5.5SN	0.008	0.004	15°	C (3)	0.114												133
21.5.5TN	0.008	0.005	20°	A (1)	0.150	306											
21.5.5TN	0.008	0.006	20°	C (3)	0.114												143
21.5.5SN	0.008	0.006	20°	C (3)	0.114												153
21.51SN	0.016	0.004	10°	C (3)	0.098												124
21.51SN	0.016	0.004	15°	C (3)	0.098												134
21.51TN	0.016	0.005	20°	A (1)	0.138	308											
21.51TN	0.016	0.006	20°	C (3)	0.098												144
21.51SN	0.016	0.006	20°	C (3)	0.098												154
21.51TN	0.016	0.007	25°	C (3)	0.098												164
21.51EN	0.016			C (3)	0.098												114
21.51FN	0.016			A (1)	0.138	208						40700					

P							
M							
K							
N							
S							
H							
O							

TCGW

▲ TCE(NOI) = Design and number of equipped cutting edge corners

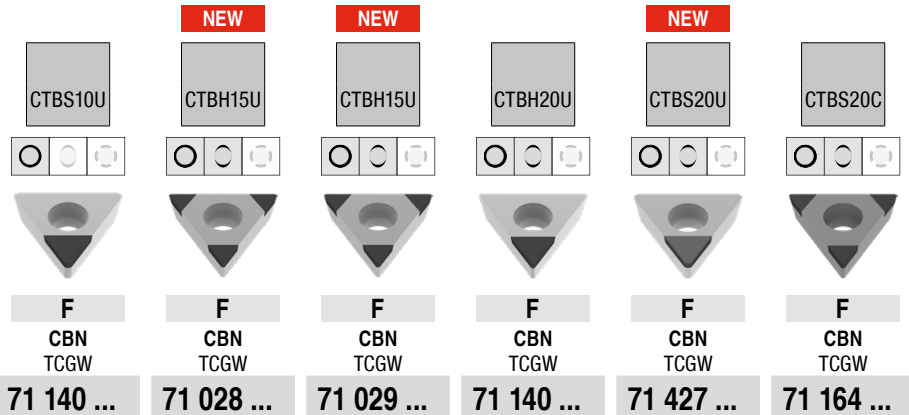
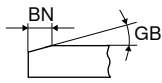

ANSI	RE inch	BN inch	GB	TCE (NOI)	LE inch	71 140 ...	71 028 ...	71 029 ...	71 140 ...	71 427 ...	71 164 ...
21.52SN	0.031	0.004	10°	C (3)	0.083						125
21.52SN	0.031	0.004	15°	C (3)	0.083						135
21.52TN	0.031	0.005	20°	A (1)	0.118	310			510		145
21.52TN	0.031	0.006	20°	C (3)	0.083						165
21.52TN	0.031	0.007	25°	C (3)	0.083						165
21.52FN	0.031			A (1)	0.118	210			410		
32.51SN	0.016	0.004	10°	C (3)	0.126						126
32.51SN	0.016	0.004	15°	C (3)	0.126						136
32.52SN	0.031	0.004	10°	C (3)	0.106						127
32.52SN	0.031	0.004	15°	C (3)	0.106						137
32.52SN	0.031	0.006	20°	C (3)	0.106						157
32.52EN	0.031			C (3)	0.106						117
32.52TN	0.031	0.007	25°	C (3)	0.106						167

P											
M											
K						•				•	•
N											
S						•				•	•
H							•	•	•		
O											

4

TCGW

▲ TCE(NOI) = Design and number of equipped cutting edge corners

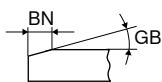

	NEW		NEW						
	CTBH15C	CTBH15C	CTBH20C	CTBH40U	CTBH40C				
	F	F	F	F	F				
	CBN	CBN	CBN	CBN	CBN				
	TCGW	TCGW	TCGW	TCGW	TCGW				
	71 027 ...	71 034 ...	71 164 ...	71 140 ...	71 164 ...				
1.81.5.5SN	0.008	0.004	15°	C (3)	0.102				
1.81.5.5SN	0.008	0.004	20°	C (3)	0.102				
1.81.5.5TN	0.008	0.004	20°	C (3)	0.102				
1.81.5.5TN	0.008	0.004	25°	C (3)	0.102				
1.81.5.5TN	0.008	0.005	25°	A (1)	0.150				
1.81.5.5FN	0.008			A (1)	0.150				
1.81.5.5FN	0.008			C (3)	0.102				
1.81.5.5EN	0.008			C (3)	0.102				
1.81.5.1FN	0.016			A (1)	0.138				
1.81.5.1TN	0.016	0.004	20°	C (3)	0.087				
1.81.5.1TN	0.016	0.004	25°	C (3)	0.087				
1.81.5.1SN	0.016	0.004	25°	C (3)	0.087				
1.81.5.1TN	0.016	0.006	30°	C (3)	0.087				
1.81.5.1SN	0.016	0.006	30°	C (3)	0.087				
1.81.5.1TN	0.016	0.005	25°	A (1)	0.138				
1.81.5.1EN	0.016			C (3)	0.087	00400			
1.81.5.1SN	0.016	0.004	15°	C (3)	0.087	30414			
1.81.5.1TN	0.016	0.006	25°	C (3)	0.087				
1.81.5.1SN	0.016	0.006	25°	C (3)	0.087				
1.81.5.2SN	0.031	0.004	10°	C (3)	0.071				
1.81.5.2SN	0.031	0.004	15°	C (3)	0.071	30614			
1.81.5.2SN	0.031	0.004	20°	C (3)	0.071				
1.81.5.2TN	0.031	0.006	20°	C (3)	0.071				
1.81.5.2SN	0.031	0.004	25°	C (3)	0.071				
1.81.5.2TN	0.031	0.004	25°	C (3)	0.071				
1.81.5.2TN	0.031	0.005	25°	A (1)	0.118				
1.81.5.2EN	0.031			C (3)	0.071	00600			
21.5.5FN	0.008			A (1)	0.150				
21.5.5TN	0.008	0.004	20°	C (3)	0.114				
21.5.5SN	0.008	0.004	20°	C (3)	0.114				
21.5.5TN	0.008	0.004	25°	C (3)	0.114				
21.5.5TN	0.008	0.006	30°	C (3)	0.114				
21.5.5TN	0.008	0.005	25°	A (1)	0.150				
21.5.5FN	0.008			C (3)	0.114				
21.5.5EN	0.008			C (3)	0.114				
21.5.5SN	0.008	0.004	15°	C (3)	0.114				
21.5.5SN	0.008	0.006	25°	C (3)	0.114	31414			
						31429			
21.51FN	0.016			A (1)	0.138				
21.51TN	0.016	0.004	20°	C (3)	0.098				
21.51TN	0.016	0.004	25°	C (3)	0.098				
21.51SN	0.016	0.004	25°	C (3)	0.098				
21.51TN	0.016	0.006	30°	C (3)	0.098				
21.51SN	0.016	0.006	30°	C (3)	0.098				
21.51TN	0.016	0.005	25°	A (1)	0.138				
21.51FN	0.016			C (3)	0.098				
21.51EN	0.016			C (3)	0.098				
21.51SN	0.016	0.004	10°	C (3)	0.098				

P									
M									
K									
N									
S									
H									
O									

TCGW

▲ TCE(NOI) = Design and number of equipped cutting edge corners

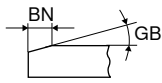

	NEW CTBH15C	NEW CTBH15C	CTBH20C	CTBH40U	CTBH40C
	F	F	F	F	F
	CBN TCGW	CBN TCGW	CBN TCGW	CBN TCGW	CBN TCGW
	71 027 ...	71 034 ...	71 164 ...	71 140 ...	71 164 ...
21.51SN		31614	244		
21.51TN			264		
21.51SN			274		
21.51SN		31629			
21.52EN					315
21.52TN					325
21.52SN					355
21.52TN					365
21.52SN					375
21.52TN				910	
21.52SN			235		
21.52SN	31814		245		
21.52SN			255		
21.52TN			265		
21.52SN	31829				
32.51SN			256		336
32.51SN					356
32.51TN					346
32.51SN			276		
32.51TN					366
32.51SN					386
32.51FN			216		
32.51EN			226		
32.52SN			247		
32.52SN					337
32.52SN					357
32.52TN					347
32.52TN			267		
32.52SN			277		
32.52TN					367
32.52SN					377
32.52EN			227		317
32.52SN			287		



4

TCGW / TCGT

Designation	L inch	S inch	D1 inch	IC inch
TCGT 18..	0.378	0.094	0.098	0.219
TCGW 1...	0.378	0.094	0.098	0.219
TCG. 21..	0.433	0.094	0.110	0.250
TCG. 32..	0.650	0.156	0.173	0.375

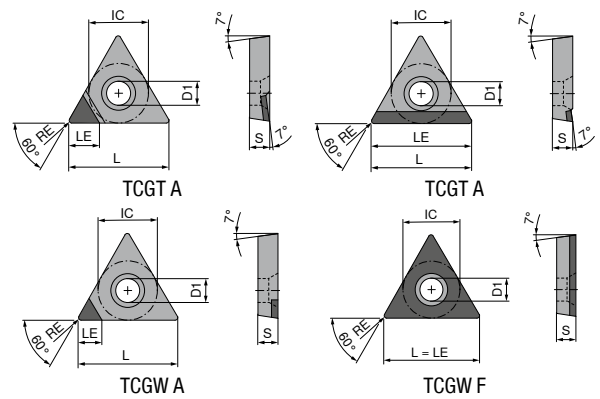

TCGW / TCGT

▲ TCE(NOI) = Design and number of equipped cutting edge corners

ANSI	RE inch	TCE (NOI)	LE inch	Insert Options					
				CTDPD20	CTDPD20	CTDPD20	CTDPD20	-CB1 CTDPD20	CTDPS30
				NEW	NEW		NEW		NEW
				F	F	F	F	F	F
				DIAMOND TCGW	DIAMOND TCGW	DIAMOND TCGW	DIAMOND TCGT	DIAMOND TCGT	DIAMOND TCGT
				71 188 ...	71 187 ...	71 140 ...	71 184 ...	71 325 ...	71 184 ...
1.81.5.5FN	0.008	A (1)	0.146			100			
181.5.5FN	0.008	A (1)	0.146					112	20001
1.81.5.1FN	0.016	A (1)	0.134			102		114	20101
181.5.1FN	0.016	A (1)	0.134						
1.81.5.2FN	0.031	A (1)	0.118			104			
181.5.2FN	0.031	A (1)	0.118				10001		
1.81.5.2FNN	0.031	A (1)	0.378	10001					
21.5.5FN	0.008	A (1)	0.146			106	10101	122	
21.5.5FN	0.008	F	0.433		10001				
21.51FN	0.016	A (1)	0.134			108	10201	124	20201
21.51FN	0.016	F	0.433		10101				
21.51FNN	0.016	A (1)	0.433	10101					
21.52FN	0.031	A (1)	0.118			110	10301		
21.52FNN	0.031	A (1)	0.433	10201					
32.51FN	0.016	A (1)	0.181			112	10401	134	20301
32.51FNN	0.016	A (1)	0.650	10301					
32.52FN	0.031	A (1)	0.165			114	10501	13600	
32.52FNN	0.031	A (1)	0.650	10401					
32.53FN	0.047	A (1)	0.150			11600			
P									
M									
K									
N				•	•	•	•	•	•
S									
H									
O				•	•	•	•	•	•

TCGW / TCGT

▲ TCE(NOI) = Design and number of equipped cutting edge corners

ANSI	RE inch	TCE (NOI)	LE inch	71 186 ...	71 185 ...	71 326 ...	71 188 ...	71 327 ...	71 186 ...
181.5.5FN	0.008	A (1)	0.146			212			
1.81.5.5FN	0.008	A (1)	0.146	20001					
181.5.1FN	0.016	A (1)	0.134			214			
181.5.1FNN	0.016	A (1)	0.378		20001				
21.5.5FN	0.008	A (1)	0.102						40001
21.5.5FN	0.008	A (1)	0.146	20101		222			
21.51FN	0.016	A (1)	0.091						40101
21.51FN	0.016	A (1)	0.134	20201		224		224	
21.51FNN	0.016	A (1)	0.433		20101		30001		
21.52FN	0.031	A (1)	0.079						40201
21.52FNN	0.031	A (1)	0.433		20201				
32.51FN	0.016	A (1)	0.091						40301
32.51FN	0.016	A (1)	0.181			234			
32.51FNN	0.016	A (1)	0.650		20301				
32.52FN	0.031	A (1)	0.079						40401
32.52FN	0.031	A (1)	0.165					238	
32.52FNN	0.031	A (1)	0.650		20401				

P									
M									
K									
N		•	•	•	•	•	•	•	•
S									
H									
O		•	•	•	•	•	•	•	•

4

MaxiLock-S – STGC 90° – Toolholder with screw clamping

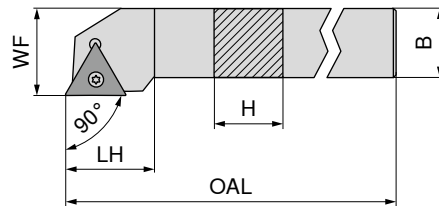

Illustrations show right-hand versions



Designation	H inch	B inch	OAL inch	LH inch	WF inch	Insert
STGC R/L 06-2	0.375	0.375	2.500	0.500	0.500	TC..21.5..
STGC R/L 08-2	0.500	0.500	3.500	0.560	0.625	TC..21.5..
STGC R/L 10-3	0.625	0.625	4.000	1.000	0.750	TC..32.5..
STGC R/L 12-3B	0.750	0.750	4.500	1.000	1.000	TC..32.5..
STGC R/L 16-3D	1.000	1.000	6.000	1.000	1.250	TC..32.5..

Left-hand 78 565 ...	Right-hand 78 564 ...
00602	00602
00802	00802
01003	01003
01223	01223
01643	01643

Spare parts for Article no.

78 564 00602 / 78 565 00602	06400	06200		
78 564 00802 / 78 565 00802	06400	06200		
78 564 01003 / 78 565 01003	05400	05100	06100	05300
78 564 01223 / 78 565 01223	05400	05100	06100	05300
78 564 01643 / 78 565 01643	05400	05100	06100	05300

Key I	Clamping screw	Solid Carbide Seat T	Threaded sleeve
78 950 ...	78 950 ...	78 950 ...	78 950 ...

MaxiLock-S – STFC 90° – Toolholder with screw clamping

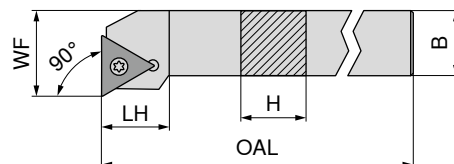

Illustrations show right-hand versions



Designation	H inch	B inch	OAL inch	LH inch	WF inch	Insert
STFC R/L 06-2	0.375	0.375	2.500	0.400	0.500	TC..21.5..
STFC R/L 08-2	0.500	0.500	3.500	0.689	0.625	TC..21.5..
STFC R/L 10-3	0.625	0.625	4.000	1.000	0.750	TC..32.5..
STFC R/L 12-3B	0.750	0.750	4.500	1.000	1.000	TC..32.5..
STFC R/L 16-3D	1.000	1.000	6.000	1.000	1.250	TC..32.5..

Left-hand 78 563 ...	Right-hand 78 562 ...
00602	00602
00802	00802
01003	01003
01223	01223
01643	01643

Spare parts for Article no.

78 562 00602 / 78 563 00602	06400	06200		
78 562 00802 / 78 563 00802	06400	06200		
78 562 01003 / 78 563 01003	05400	05100	06100	05300
78 562 01223 / 78 563 01223	05400	05100	06100	05300
78 562 01643 / 78 563 01643	05400	05100	06100	05300

Key I	Clamping screw	Solid Carbide Seat T	Threaded sleeve
78 950 ...	78 950 ...	78 950 ...	78 950 ...

MaxiLock-S – STDC 45° – Toolholder with screw clamping

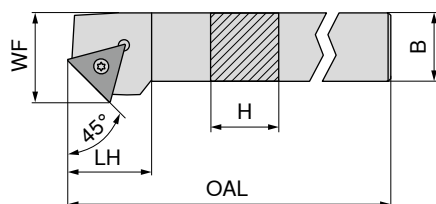

Illustrations show right-hand versions

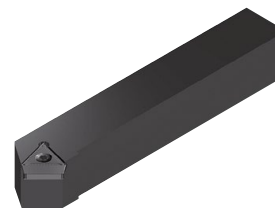

Designation	H inch	B inch	OAL inch	LH inch	WF inch	Insert
STDC R/L 06-2	0.375	0.375	2.500	0.410	0.433	TC..21.5..
STDC R/L 08-2	0.500	0.500	3.500	0.570	0.512	TC..21.5..
STDC R/L 10-3	0.625	0.625	4.000	1.000	0.669	TC..32.5..
STDC R/L 12-3B	0.750	0.750	4.500	1.000	0.866	TC..32.5..
STDC R/L 16-3D	1.000	1.000	6.000	1.000	1.063	TC..32.5..

Left-hand 78 561 ...	Right-hand 78 560 ...
00602	00602
00802	00802
01003	01003
01223	01223
01643	01643

Spare parts for Article no.

78 560 00602 / 78 561 00602	06400	06200		
78 560 00802 / 78 561 00802	06400	06200		
78 560 01003 / 78 561 01003	05400	05100	06100	05300
78 560 01223 / 78 561 01223	05400	05100	06100	05300
78 560 01643 / 78 561 01643	05400	05100	06100	05300

Key I	Clamping screw	Solid Carbide Seat T	Threaded sleeve
78 950 ...	78 950 ...	78 950 ...	78 950 ...

4

MaxiLock-S – STTC 60° – Toolholder with screw clamping

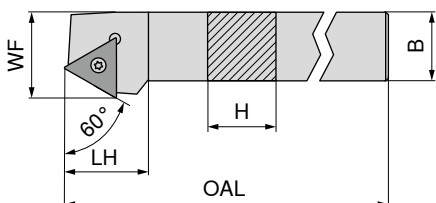

Illustrations show right-hand versions



Designation	H inch	B inch	OAL inch	LH inch	WF inch	Insert
STTC R/L 12-3B	0.750	0.750	4.500	1.000	0.718	TC..32.5..
STTC R/L 16-3D	1.000	1.000	6.000	1.000	0.860	TC..32.5..

Left-hand 78 567 ...	Right-hand 78 566 ...
01223	01223
01643	01643

Spare parts for Article no.

78 566 01223 / 78 567 01223	05400	05100	06100	05300
78 566 01643 / 78 567 01643	05400	05100	06100	05300

Key I	Clamping screw	Solid Carbide Seat T	Threaded sleeve
78 950 ...	78 950 ...	78 950 ...	78 950 ...



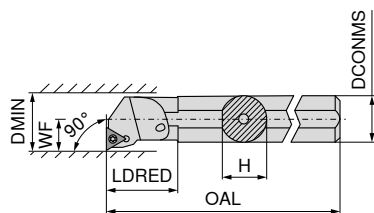

MaxiLock-S – STFC 90° – Boring bar with screw clamping



Illustrations show right-hand versions



Designation	DCONMS inch	H inch	OAL inch	LDRED inch	WF inch	DMIN inch	Insert	Left-hand	Right-hand
								78 725 ...	78 724 ...
S06M STFC R/L 2	0.375	0.340	6.000	0.850	0.250	0.500	TC..21.5..	20617	20617
A06M STFC R/L	0.375	0.340	6.000	0.850	0.250	0.500	TC..21.5..	20606	20606
S08M STFC R/L 2	0.500	0.460	6.000	0.800	0.312	0.625	TC..21.5..	20818	20818
A08M STFC R/L	0.500	0.460	6.000	0.800	0.312	0.625	TC..21.5..	20808	20808
S10R STFC R/L 2	0.625	0.580	8.000	0.960	0.406	0.812	TC..21.5..	21021	21021
A10R STFC R/L	0.625	0.580	8.000	0.960	0.406	0.812	TC..21.5..	21010	21010
S12S STFC R/L 2	0.750	0.710	10.000	1.420	0.500	1.000	TC..21.5..	21222	21222
A12S STFC R/L	0.750	0.710	10.000	1.420	0.500	1.000	TC..21.5..	21212	21212
S16T STFC R/L 3	1.000	0.900	12.000	1.930	0.640	1.280	TC..32.5..	31626	31626
S20U STFC R/L 3	1.250	1.180	14.000	1.970	0.765	1.530	TC..32.5..	32030	32030
S24V STFC R/L 3	1.500	1.370	16.000	2.360	0.890	1.780	TC..32.5..	32435	32435

 Key I	 Clamping screw	 Solid Carbide Seat T	 Threaded sleeve
78 950 ...	78 950 ...	78 950 ...	78 950 ...

Spare parts

for Article no.

78 724 20617 / 78 725 20617	06400	05200		
78 724 20606 / 78 725 20606	06400	05200		
78 724 20818 / 78 725 20818	06400	05200		
78 724 20808 / 78 725 20808	06400	06200		
78 724 21021 / 78 725 21021	06400	06200		
78 724 21010 / 78 725 21010	06400	06200		
78 724 21222 / 78 725 21222	06400	06200		
78 724 21212 / 78 725 21212	06400	06200		
78 724 31626 / 78 725 31626	05700	05600		
78 724 32030 / 78 725 32030	05400	05100	06100	05300
78 724 32435 / 78 725 32435	05400	05100	06100	05300

VCGT / VCMT / VCET

Designation	L inch	S inch	D1 inch	IC inch
VC.T 22..	0.437	0.125	0.114	0.250
VC.T 33..	0.654	0.187	0.173	0.375
VCGT 43..	0.870	0.219	0.217	0.500

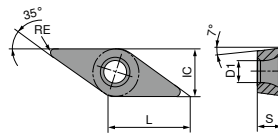

VCGT / VCMT

		-CF05 CTEP110	-CF55 CTEP110	-SF TCM10	-SF TCM407	-SMF TCM10	-SF CTCP115	-SF CTCP115
		DRAGONSKIN	DRAGONSKIN				DRAGONSKIN	DRAGONSKIN
		F CERMET VCGT	F CERMET VCMT	F CERMET VCGT	F CERMET VCGT	F CERMET VCMT	F VCMT	F VCGT
		76 276 ...	76 292 ...	70 277 ...	70 277 ...	70 288 ...	76 279 ...	76 277 ...
ANSI	RE inch							
22.5EN	0.008		014	894	844			314
220EN	0.004			892	846			316
221EN	0.016		016	896		896		318
222EN	0.031							
331EN	0.016	028	028	900	850	900	328	
332EN	0.031	030	030	902		902	330	
P		●	●	●	●	●	●	●
M		○	○	○	○	○	○	○
K		○	○	○	○	○	○	○
N								
S								
H								
O								

4

VCGT / VCMT

		-SF CTCP125	-SF CTCP125	-SF CTCP135	-SF CTCP135	-SMF CTCP115	-SMF CTCP125	-SMF CTCP135
		DRAGONSKIN	DRAGONSKIN	DRAGONSKIN	DRAGONSKIN	DRAGONSKIN	DRAGONSKIN	DRAGONSKIN
		F VCGT	F VCMT	F VCGT	F VCMT	F VCMT	F VCMT	F VCGT
		76 277 ...	76 279 ...	76 277 ...	76 279 ...	76 288 ...	76 288 ...	76 285 ...
ANSI	RE inch							
22.5EN	0.008	514		714				714
221EN	0.016	516		716		316	516	
222EN	0.031	518		718				
331EN	0.016		528		728	328	528	
332EN	0.031		530			330	530	
P		●	●	●	●	●	●	●
M		○	○	○	○	○	○	○
K		○	○	○	○	○	○	○
N								
S								
H								
O								

VCMT

		-SMF CTCP135	-SM CTCK110	-SM CTCK120	-SM CTCP115	-SM CTCP125	-SM CTCP135
		DRAGONSKIN	DRAGONSKIN	DRAGONSKIN	DRAGONSKIN	DRAGONSKIN	DRAGONSKIN
		F VCMT	M VCMT	M VCMT	M VCMT	M VCMT	M VCMT
		76 288 ...	70 278 ...	70 278 ...	76 278 ...	76 278 ...	76 278 ...
ANSI	RE inch						
221EN	0.016	716					
331.5EN	0.024				329		
331EN	0.016	728	028	528	328	528	728
332EN	0.031	730	030	530	330	530	730
333EN	0.047		032	532	33200	53200	732
P		●	○	○	●	●	●
M		○					○
K			●	●	○	○	
N							
S							
H							
O							

VCMT

		NEW -M25 CTCM120	-M25 CTPM125	NEW -M25 CTCM130	NEW -M55 CTCM120	-M55 CTPM125	NEW -M55 CTCM130
		DRAGONSKIN	DRAGONSKIN	DRAGONSKIN	DRAGONSKIN	DRAGONSKIN	DRAGONSKIN
		F VCMT	F VCMT	F VCMT	M VCMT	M VCMT	M VCMT
		75 219 ...	75 219 ...	75 219 ...	75 220 ...	75 220 ...	75 220 ...
ANSI	RE inch						
331EN	0.016	12800	228	32800	12800	228	32800
332EN	0.031	13000	23000	33000	13000	230	33000
P		○	○	○	○	○	○
M		●	●	●	●	●	●
K							
N							
S				○			○
H							
O							

VCGT / VCMT

		-25P H210T	NEW -25P CTPX710	-25Q H210T	-27 H10T	-27 CWN15	NEW -27 CTPX715	NEW -29 H216T
			DRAGONSKIN 				DRAGONSKIN 	
		F	M	M	M	M	M	M
		VCGT	VCGT	VCGT	VCGT	VCGT	VCGT	VCMT
		70 282 ...	70 282 ...	70 282 ...	70 280 ...	70 280 ...	70 280 ...	70 247 ...
ANSI	RE inch							
22.5FN	0.008	638	71400		606	306	81400	
221FL	0.016			670				
221FN	0.016	640	71600		608	308	81600	
221FR	0.016			680				
222FN	0.031				610	310		
331EN	0.016							62800
331FN	0.016	642	72800		612	312	82800	
332EN	0.031							63000
332FN	0.031	644	73000		614	314	83000	
333EN	0.047							63200
333FN	0.047	646	73200		616	316		
43.57.5FN	0.118	648	75000		618			
P			●				●	
M			●			○	●	
K		○		○	○		○	○
N		●	●	●	●	●	●	●
S		○	●	○			●	
H								
O		○		○	○		○	○

4

VCET

NEW

-F05
CTPX710

DRAGONSKIN



F
VCET
76 255 ...

ANSI	RE inch		
22.5FN	0.008		12000
2205FN	0.006		11800
220FN	0.004		11600
221FN	0.016		12200
22X0FN	0.002		11400
P			•
M			•
K			•
N			•
S			•
H			
O			

VCMT

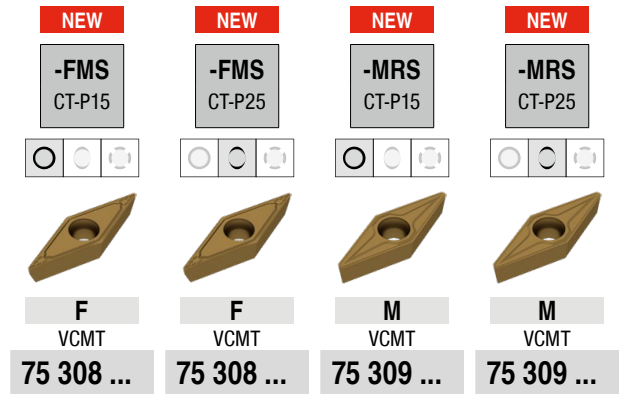

ANSI	RE inch	75 308 ...	75 308 ...	75 309 ...	75 309 ...
221EN	0.016	01609	11609		
331EN	0.016	02809	12809	02809	12809
332EN	0.031	03009	13009	03009	13009
P		●	●	●	●
M		○	○	○	○
K					
N					
S					
H					
O					

VCGW / VCGT

Designation	L inch	S inch	D1 inch	IC inch
VCG. 22..	0.437	0.125	0.114	0.250
VCG. 33..	0.654	0.187	0.173	0.375
VCGW 1...	0.272	0.094	0.087	0.156

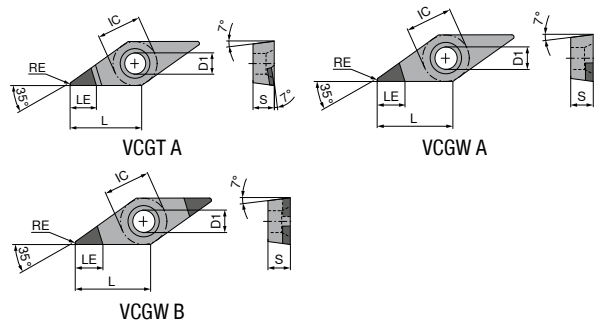

VCGW

▲ TCE(NOI) = Design and number of equipped cutting edge corners

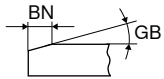

	NEW		NEW	NEW
	CTBS20U	CTBS20C	CTBH15U	CTBH15C
CTBS10U				
F	F	F	F	F
CBN	CBN	CBN	CBN	CBN
VCGW	VCGW	VCGW	VCGW	VCGW
71 160 ...	71 429 ...	71 165 ...	71 036 ...	71 035 ...

ANSI	RE inch	BN inch	GB	TCE (NOI)	LE inch				
22.5SN	0.008	0.004	15°	B (2)	0.134				32014
22.5TN	0.008	0.005	15°	A (1)	0.185				32014
22.5EN	0.008			B (2)	0.134		20000		02000
22.5FN	0.008			A (1)	0.185	200			02000
22.5TN	0.008	0.005	20°	A (1)	0.185	300			
22.5SN	0.008	0.006	25°	B (2)	0.134				32029
22.5SN	0.008	0.006	25°	B (2)	0.134				32029
221SN	0.016	0.004	10°	B (2)	0.122			121	
221SN	0.016	0.004	15°	B (2)	0.122			131	32214
221TN	0.016	0.005	20°	A (1)	0.177	302			32214
221TN	0.016	0.006	20°	B (2)	0.122			141	
221EN	0.016			B (2)	0.122				02200
221FN	0.016			A (1)	0.177	202			02200
221SN	0.016	0.006	20°	B (2)	0.122			151	
221SN	0.016	0.006	25°	B (2)	0.122				32229
221SN	0.016	0.007	25°	B (2)	0.122			171	
222SN	0.031	0.004	10°	B (2)	0.098			122	
222EN	0.031			B (2)	0.098			112	02400
222FN	0.031			A (1)	0.165	204			02400
222SN	0.031	0.004	15°	B (2)	0.098			132	32414
222TN	0.031	0.005	20°	A (1)	0.165	304			32414
222SN	0.031	0.006	20°	B (2)	0.098			152	
221SN	0.031	0.006	25°	B (2)	0.122				32229
222SN	0.031	0.006	25°	B (2)	0.098				32429
222TN	0.031	0.007	25°	B (2)	0.098			162	
222SN	0.031	0.007	25°	B (2)	0.098			172	
33.5RN	0.008			B (2)	0.134				23600
33.5SN	0.008	0.004	15°	B (2)	0.134				33614
33.5SN	0.008	0.006	25°	B (2)	0.134				33629
33.5FN	0.008			A (1)	0.209	205			
33.5TN	0.008	0.005	20°	A (1)	0.209	305			
331SN	0.016	0.004	10°	B (2)	0.122			125	
331SN	0.016	0.004	15°	B (2)	0.122			135	
331TN	0.016	0.005	15°	A (1)	0.197		20100		33814

P									
M									
K		•		•				•	
N									
S		•		•				•	
H									•
O									•

VCGW

▲ TCE(NOI) = Design and number of equipped cutting edge corners

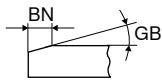

	CTBS10U	NEW CTBS20U	CTBS20C	NEW CTBH15U	NEW CTBH15C
	F	F	F	F	F
	CBN VCGW	CBN VCGW	CBN VCGW	CBN VCGW	CBN VCGW
	71 160 ...	71 429 ...	71 165 ...	71 036 ...	71 035 ...
331TN	306				
331RN			145	23800	23800
331FN	206			23600	
331SN			155	33829	33829
332SN			175		
332RN			126		
332FN			136	34014	34014
332TN	308	20200			
332RN			156	24000	24000
332EN			116		
332FN	208			34029	34029
332SN			166		
332TN			176		
332SN					

P					
M					
K		•	•	•	
N					
S		•	•	•	
H				•	•
O					

4

VCGW / VCGT

▲ TCE(NOI) = Design and number of equipped cutting edge corners

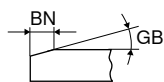

	CTBH20U	CTBH21U	NEW CTBH21U	NEW CTBH21U	CTBH20C					
	F	F	F	F	F					
	CBN VCGW	CBN VCGW	CBN VCGW	CBN VCGT	CBN VCGW					
	71 160 ...	71 160 ...	71 430 ...	71 428 ...	71 165 ...					
1.21.5.5TN	0.008	0.005	25°	A (1)	0.138					
1.21.51FN	0.016			A (1)	0.126					
22.5TN	0.008	0.005	20°	A (1)	0.185					
22.5TN	0.008	0.005	25°	B (2)	0.138					
22.5FN	0.008			B (2)	0.138					
22.5FN	0.008			A (1)	0.185					
221FN	0.016			A (1)	0.126					
221FN	0.016			B (2)	0.122					
221EN	0.016			B (2)	0.122					
221SN	0.016	0.004	20°	B (2)	0.122					
221TN	0.016	0.006	25°	B (2)	0.122					
221SN	0.016	0.006	25°	B (2)	0.122					
221FN	0.016			B (2)	0.126					
221TN	0.016	0.005	25°	B (2)	0.126					
221FN	0.016	0.005	20°	A (1)	0.177					
221TN	0.016	0.005	20°	A (1)	0.177					
222SN	0.031	0.004	15°	B (2)	0.098					
222SN	0.031	0.004	20°	B (2)	0.098					
222TN	0.031	0.005	20°	A (1)	0.165					
222TN	0.031	0.006	25°	B (2)	0.098					
222SN	0.031	0.006	25°	B (2)	0.098					
222EN	0.031			B (2)	0.098					
222FN	0.031			A (1)	0.165					
222SN	0.031	0.007	30°	B (2)	0.098					
33.5FN	0.008			A (1)	0.138					
33.5TN	0.008	0.005	25°	B (2)	0.138					
33.5TN	0.008	0.005	25°	A (1)	0.138					
33.5FN	0.008			A (1)	0.209					
33.5TN	0.008	0.005	20°	A (1)	0.209					
331FN	0.016			B (2)	0.126					
331FN	0.016			B (2)	0.122					
331EN	0.016			B (2)	0.122					
331SN	0.016	0.004	20°	B (2)	0.122					
331TN	0.016	0.006	25°	B (2)	0.122					
331SN	0.016	0.004	15°	B (2)	0.122					
331TN	0.016	0.005	25°	B (2)	0.126					
331FN	0.016			A (1)	0.126					
331TN	0.016	0.005	25°	A (1)	0.126					
331FN	0.016	0.005	20°	A (1)	0.197					
331TN	0.016	0.005	20°	A (1)	0.197					
332SN	0.031	0.004	15°	B (2)	0.098					
332SN	0.031	0.004	20°	B (2)	0.098					
332TN	0.031	0.005	20°	A (1)	0.173					
332TN	0.031	0.005	25°	B (2)	0.110					
332TN	0.031	0.006	25°	B (2)	0.098					
332SN	0.031	0.006	25°	B (2)	0.098					
332SN	0.031	0.007	30°	B (2)	0.098					
332EN	0.031			B (2)	0.098					
332FN	0.031			B (2)	0.110					
332FN	0.031			A (1)	0.173					
333TN	0.047	0.005	20°	A (1)	0.154					

P					
M					
K					
N					
S					
H					
O					

1) Machining to 60 HRC

VCGW

▲ TCE(NOI) = Design and number of equipped cutting edge corners

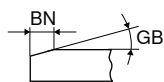

	CTBH40U	CTBH40C	NEW CTBH41U	NEW CTBH41U
	F	F	F	F
	CBN VCGW	CBN VCGW	CBN VCGW	CBN VCGW
	71 160 ...	71 165 ...	71 429 ...	71 430 ...
ANSI				
RE				
BN				
GB				
TCE (NOI)				
LE				
1.21.5.FN	0.008			
			70000	
1.21.51.FN	0.016			
			70100	
22.5.FN	0.008			
				70000
22.5.FN	0.008			
22.5.TN	0.008	0.005	25°	
221.SN	0.016	0.004	20°	
221.SN	0.016	0.004	25°	
			331	
			351	
221.FN	0.016			
				70100
221.FN	0.016			
221.TN	0.016	0.004	25°	
221.TN	0.016	0.005	25°	
			341	
221.TN	0.016	0.006	30°	
221.SN	0.016	0.007	35°	
			361	
			381	
222.SN	0.031	0.004	20°	
222.SN	0.031	0.004	25°	
			332	
			352	
222.EN	0.031			
222.FN	0.031			
222.TN	0.031	0.004	25°	
222.TN	0.031	0.006	30°	
			342	
			362	
222.SN	0.031	0.006	30°	
			372	
222.SN	0.031	0.007	35°	
			382	
33.5.FN	0.008			
33.5.FN	0.008			
33.5.FN	0.008			
33.5.TN	0.008	0.005	25°	
			70200	
				70200
331.SN	0.016	0.004	20°	
331.SN	0.016	0.004	25°	
			335	
			355	
331.FN	0.016			
331.FN	0.016			
331.FN	0.016			
331.TN	0.016	0.004	25°	
331.TN	0.016	0.005	25°	
331.TN	0.016	0.003	30°	
331.TN	0.016	0.006	30°	
331.SN	0.016	0.007	35°	
			365	
			385	
			70300	
				70300
332.SN	0.031	0.004	20°	
332.SN	0.031	0.004	25°	
			336	
			356	
332.TN	0.031	0.004	25°	
332.TN	0.031	0.005	25°	
332.TN	0.031	0.006	30°	
332.FN	0.031			
332.FN	0.031			
332.EN	0.031			
332.FN	0.031			
332.SN	0.031	0.006	30°	
332.SN	0.031	0.007	35°	
			366	
			70400	
				70400
333.TN	0.047	0.005	25°	
			316	
			70500	
			376	
			386	
			90900	

P				
M				
K				
N				
S				
H				
O				

4

VCGT / VCGW

Designation	L inch	S inch	D1 inch	IC inch
VCG. 1...	0.272	0.094	0.087	0.156
VCG. 22...	0.437	0.125	0.114	0.250
VCG. 2...	0.524	0.125	0.134	0.313
VCG. 33...	0.654	0.187	0.173	0.375

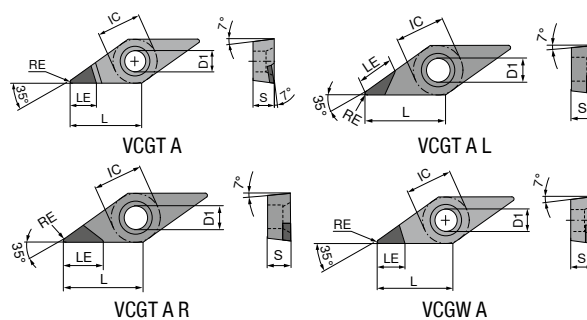

VCGT / VCGW

▲ TCE(NOI) = Design and number of equipped cutting edge corners

ANSI	RE inch	TCE (NOI)	LE inch	NEW						
				CTDMD05	CTDMD05	CTDPD20	CTDPD20	CTDPD20	CTDPD20	
				F	F	F	F	F	F	F
				DIAMOND	DIAMOND	DIAMOND	DIAMOND	DIAMOND	DIAMOND	DIAMOND
				VCGT	VCGW	VCGW	VCGT	VCGT	VCGT	VCGT
				71 189 ...	71 160 ...	71 160 ...	71 062 ...	71 063 ...	71 064 ...	71 064 ...
1.21.5.FN	0.008	A (1)		50001						
1.21.51FN	0.016	A (1)		50101						
220FN	0.004	A (1)	0.213				10100			
22.5FN	0.008	A (1)	0.118							
22.5FN	0.008	A (1)	0.181	50201	050		100			
221FN	0.016	A (1)	0.118							
221FN	0.016	A (1)	0.154	50301	052		102			
221FR	0.016	A (1)	0.256						102	
221FL	0.016	A (1)	0.256							102
222FN	0.031	A (1)	0.130				104			
222FR	0.031	A (1)	0.236						104	
222FL	0.031	A (1)	0.236							104
330FN	0.004	A (1)	0.236							
33.5FN	0.008	A (1)	0.232				10700			
33.5FN	0.008	A (1)		50401			105			
331FN	0.016	A (1)	0.217							
331FN	0.016	A (1)		50501			106			
331FR	0.016	A (1)	0.295						106	
331FL	0.016	A (1)	0.295							106
332FN	0.031	A (1)	0.197							
332FR	0.031	A (1)	0.276				108		108	
332FL	0.031	A (1)	0.276							108
332FN	0.031	A (1)		50601	07800		108		108	
333FN	0.047	A (1)	0.177							
333FR	0.047	A (1)	0.276				110		110	
333FL	0.047	A (1)	0.276							110

P										
M										
K										
N				•	•	•	•	•	•	•
S										
H										
O				•	•	•	•	•	•	•

VCGT / VCGW

▲ TCE(NOI) = Design and number of equipped cutting edge corners

ANSI	RE inch	TCE (NOI)	LE inch	Product Line						
				71 330 ...	71 191 ...	71 189 ...	71 330 ...	71 331 ...	71 191 ...	
1.21.50FN	0.004	A (1)	0.150			20001				
1.21.5.5FN	0.008	A (1)	0.142		20001					
1.21.51FN	0.016	A (1)	0.126		20101					
220FN	0.004	A (1)	0.213	11000	20201	20101				
22.5FN	0.008	A (1)	0.181	112	20301	20201	21200	212		
221FN	0.016	A (1)	0.154	114	20401	20301	214	214		
222FN	0.031	A (1)	0.130					21800		
2.52.5FN	0.008	A (1)	0.232		20501	20401				
330FN	0.004	A (1)	0.236		20601	20501				
33.5FN	0.008	A (1)	0.232	13200		20601		23200		
331FN	0.016	A (1)	0.217	134	20701	20701	234	234		30001
332FN	0.031	A (1)	0.197	138	20801		238	238		
333FN	0.047	A (1)	0.177	14000	20901		24000	242		

P									
M									
K									
N				•	•	•	•	•	•
S									
H									
O				•	•	•	•	•	•

4

VCGT / VCGW

▲ TCE(NOI) = Design and number of equipped cutting edge corners

	NEW		NEW		
	-CB2 CTDPU20	-CB3 CTDPU20	CTDCD10	-CB1 CTDCD10	-CB2 CTDCD10
	M DIAMOND VCGT	R DIAMOND VCGT	F DIAMOND VCGW	F DIAMOND VCGT	M DIAMOND VCGT
	71 190 ...	71 332 ...	71 191 ...	71 330 ...	71 331 ...
220FN				31000	
22.5FN				312	
221FN			40001	314	312
221FN			40101		314
222FN		214	40201		
33.5FN			40301	32200	33200
331FN			40401	32400	334
331FN	30001	234			
332FN			40501	32600	338
333FN				32800	34000

ANSI	RE inch	TCE (NOI)	LE inch
220FN	0.004	A (1)	0.118
22.5FN	0.008	A (1)	0.118
221FN	0.016	A (1)	0.118
221FN	0.016	A (1)	0.154
222FN	0.031	A (1)	0.118
33.5FN	0.008	A (1)	0.118
331FN	0.016	A (1)	0.118
331FN	0.016	A (1)	0.217
332FN	0.031	A (1)	0.118
333FN	0.047	A (1)	0.118

P					
M					
K					
N		•	•	•	•
S					
H					
O		•	•	•	•

MaxiLock-S – SVJC 93° – Toolholder with screw clamping

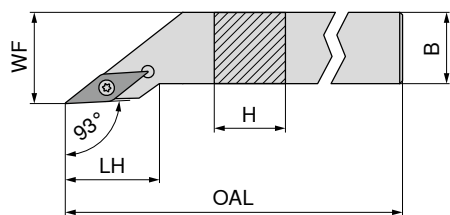

Illustrations show right-hand versions



Designation	H inch	B inch	OAL inch	LH inch	WF inch	Insert
SVJC R/L 12-3B	0.750	0.750	4.500	1.610	1.000	VC..33..
SVJC R/L 16-3D	1.000	1.000	6.000	1.610	1.250	VC..33..
SVJC R/L 20-3D	1.250	1.250	6.000	1.610	1.500	VC..33..

Left-hand 78 571 ...	Right-hand 78 570 ...
01223	01223
01643	01643
02043	02043

**Spare parts
for Article no.**

78 570 01223 / 78 571 01223	05400	05100	05500	05300
78 570 01643 / 78 571 01643	05400	05100	05500	05300
78 570 02043 / 78 571 02043	05400	05100	05500	05300

Key I	Clamping screw	Solid Carbide Seat V	Threaded sleeve
78 950 ...	78 950 ...	78 950 ...	78 950 ...

4

MaxiLock-S – SVHC 107.5° – Toolholder with screw clamping

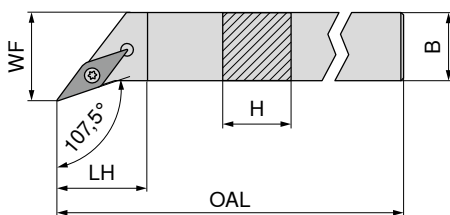

Illustrations show right-hand versions



Designation	H inch	B inch	OAL inch	LH inch	WF inch	Insert
SVHC R/L 12-3B	0.750	0.750	4.500	0.744	1.000	VC..33..
SVHC R/L 16-3D	1.000	1.000	6.000	0.756	1.250	VC..33..

Left-hand 78 569 ...	Right-hand 78 568 ...
01223	01223
01643	01643

**Spare parts
for Article no.**

78 568 01223 / 78 569 01223	05400	05100	05500	05300
78 568 01643 / 78 569 01643	05400	05100	05500	05300

Key I	Clamping screw	Solid Carbide Seat V	Threaded sleeve
78 950 ...	78 950 ...	78 950 ...	78 950 ...

MaxiLock-S – SVVC 72.5° – Toolholder with screw clamping

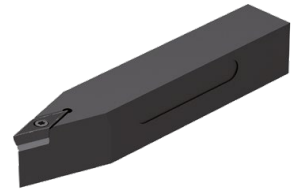
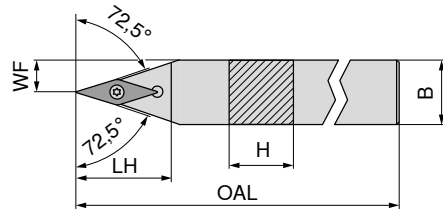

Neutral
78 585 ...

Designation	H inch	B inch	OAL inch	LH inch	WF inch	Insert
SVVC N 12-3B	0.750	0.750	4.500	1.212	0.398	VC..33..
SVVC N 16-3D	1.000	1.000	6.000	1.610	0.523	VC..33..
SVVC N 20-3D	1.250	1.250	6.000	2.008	0.648	VC..33..

01223
01643
02043

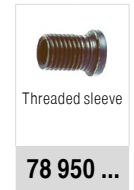
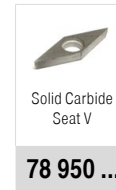
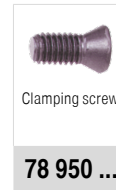
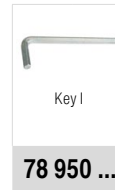

**Spare parts
for Article no.**

78 585 01223	05400	05100	05500	05300
78 585 01643	05400	05100	05500	05300
78 585 02043	05400	05100	05500	05300

MaxiLock-S – SVUC 93° – Boring bar with screw clamping

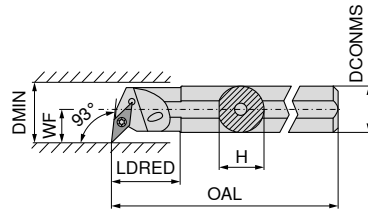

Illustrations show right-hand versions



Designation	DCONMS inch	H inch	OAL inch	LDRED inch	WF inch	DMIN inch	Insert	Left-hand		Right-hand	
								78 729 ...	78 728 ...	78 729 ...	78 728 ...
S10R SVUC R/L 2E	0.625	0.580	8.000	1.060	0.500	0.867	VC..22..	21021		21021	
S12S SVUC R/L 2E	0.750	0.710	10.000	1.580	0.625	1.060	VC..22..	21222		21222	
S16T SVUC R/L 2D	1.000	0.900	12.000	1.810	0.750	1.300	VC..22..	21626		21626	
S20U SVUC R/L 3	1.250	1.180	14.000	3.000	1.000	2.000	VC..33..	32030		32030	
S24V SVUC R/L 3	1.500	1.370	16.000	3.000	1.250	2.250	VC..33..	32435		32435	
S32W SVUC R/L 3	2.000	1.870	18.000	4.000	1.375	2.750	VC..33..	33243		33243	

**Spare parts
for Article no.**

Article no.	Key I	Clamping screw	Solid Carbide Seat V	Threaded sleeve
78 728 21021 / 78 729 21021	06400	06200		
78 728 21222 / 78 729 21222	06400	06200		
78 728 21626 / 78 729 21626	06400	06200		
78 728 32030 / 78 729 32030	05400	05100	05500	05300
78 728 32435 / 78 729 32435	05400	05100	05500	05300
78 728 33243 / 78 729 33243	05400	05100	05500	05300

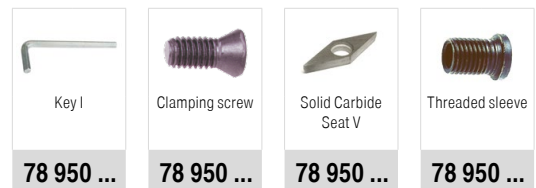

MaxiLock-S – SVQC 107.5° – Boring bar with screw clamping

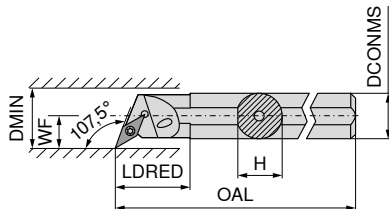

Illustrations show right-hand versions



Designation	DCONMS inch	H inch	OAL inch	LDRED inch	WF inch	DMIN inch	Insert	Left-hand		Right-hand	
								78 727 ...	78 726 ...	78 727 ...	78 726 ...
S16T SVQC R/L 3	1.000	0.900	12.000	0.910	0.750	1.375	VC..33..	31626		31626	
S20U SVQC R/L 3	1.250	1.180	14.000	1.060	0.875	1.625	VC..33..	32030		32030	
S24V SVQC R/L 3	1.500	1.370	16.000	1.370	1.063	2.000	VC..33..	32435		32435	

**Spare parts
for Article no.**

Article no.	Key I	Clamping screw	Solid Carbide Seat V	Threaded sleeve
78 726 31626 / 78 727 31626	05700	05600		
78 726 32030 / 78 727 32030	05400	05100	05500	05300
78 726 32435 / 78 727 32435	05400	05100	05500	05300

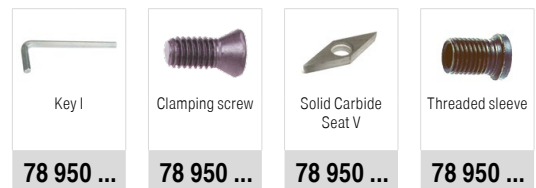

WCGT / WCGW

Designation	L inch	S inch	D1 inch	IC inch
WCGW 1..	0.106	0.062	0.091	0.156
WCGW 1..	0.106	0.063	0.091	0.156
WCGT 1..	0.107	0.063	0.083	0.156

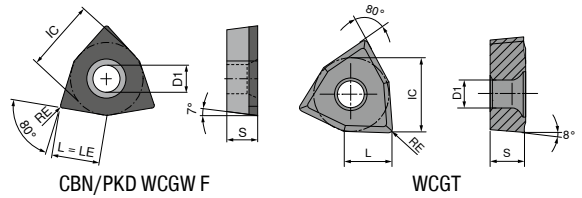

WCGT

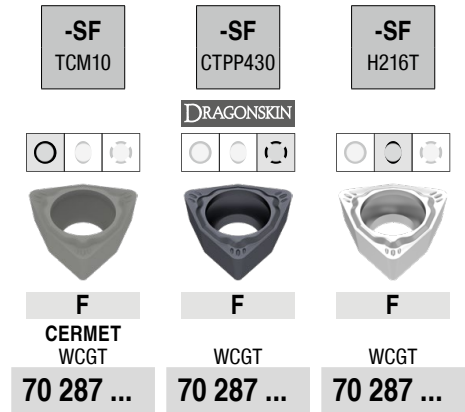

ANSI	RE inch	70 287 ...	70 287 ...	70 287 ...
1.21.5EN	0.008		450	
1.21.5FN	0.008	900		600
1.211EN	0.016		452	
1.211FN	0.016	902		602
P		●	●	
M		○	●	
K		○	○	○
N			○	●
S			○	
H				
O				○

WCGW

▲ TCE(NOI) = Design and number of equipped cutting edge corners

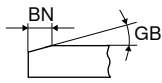

	CTBS10U	NEW CTBH15U	CTBH20U	CTBH40U
	F	F	F	F
	CBN WCGW	CBN WCGW	CBN WCGW	CBN WCGW
	71 154 ...	71 037 ...	71 154 ...	71 154 ...
		30214	500	800
	200	00200	400 ¹⁾	900
		30414	502	80100
		00400	402 ¹⁾	902

ANSI	RE inch	BN inch	GB	TCE (NOI)	LE inch
1.21.5SN	0.008	0.004	15°	F	0.106
1.21.5TN	0.008	0.005	20°	F	0.106
1.21.5FN	0.008			F	0.106
1.21.5TN	0.008	0.005	25°	F	0.106
1.211SN	0.016	0.004	15°	F	0.106
1.211TN	0.016	0.005	20°	F	0.106
1.211FN	0.016			F	0.106
1.211EN	0.016			F	0.106
1.211TN	0.016	0.005	25°	F	0.106

P
M
K
N
S
H
O

1) Machining to 60 HRC

4

WCGW

▲ TCE(NOI) = Design and number of equipped cutting edge corners

CTDPD20
F
DIAMOND WCGW
71 154 ...

ANSI	RE inch	TCE (NOI)	LE inch
1.21.5FN	0.008	F	0.106
1.211FN	0.016	F	0.106

P
M
K
N
S
H
O

Material examples for cutting data tables

	Material sub-group	Index	Composition / Structure / Heat treatment	Tensile strength lbf/in ² / HB / HRC	Material number	Material designation	Material number	Material designation
P	Unalloyed steel	P.1.1	< 0.15 % C Annealed	60900 lbf/in ² / 125 HB	1.0401	1015	1.0301	1010
		P.1.2	< 0.45 % C Annealed	92800 lbf/in ² / 190 HB	1.1191	1045	1.0737	12L14
		P.1.3	< 0.45 % C Tempered	121800 lbf/in ² / 250 HB	1.1191	1045	1.0503	1043
		P.1.4	< 0.75 % C Annealed	132000 lbf/in ² / 270 HB	1.1223	1060	1.0535	1055
		P.1.5	< 0.75 % C Tempered	146500 lbf/in ² / 300 HB	1.1223	1060	1.1274	1095
	Low-alloy steel	P.2.1	Annealed	88500 lbf/in ² / 180 HB	1.7131	5115	1.6523	8620
		P.2.2	Tempered	134900 lbf/in ² / 275 HB	1.7131	5115	1.6582	4340
		P.2.3	Tempered	146500 lbf/in ² / 300 HB	1.7225	4142	1.7131	5115
		P.2.4	Tempered	174000 lbf/in ² / 375 HB	1.7225	4142	1.7223	4140
	High-alloy steel and high-alloy tool steel	P.3.1	Annealed	98600 lbf/in ² / 200 HB	1.4021	420	1.2379	D2
		P.3.2	Hardened and tempered	159500 lbf/in ² / 300 HB	1.2343	H11	1.3343	M2
		P.3.3	Hardened and tempered	188500 lbf/in ² / 400 HB	1.2343	H11	1.2363	A2
	Stainless steel	P.4.1	Ferritic / martensitic Annealed	98600 lbf/in ² / 200 HB	1.4016	430	1.4125	440C
		P.4.2	Martensitic Tempered	117500 lbf/in ² / 250 HB	1.4112	S44003	1.4021	420
M	Stainless steel	M.1.1	Austenitic / austenitic-ferritic Quenched	88500 lbf/in ² / 200 HB	1.4301	304	1.4401	316
		M.2.1	Austenitic Tempered	300 HB	1.4841	314	1.4568	17-7 PH
		M.3.1	Austenitic / ferritic (Duplex)	113100 lbf/in ² / 230 HB	1.4462	S32205	1.4410	S32750
K	Grey cast iron	K.1.1	Pearlitic / ferritic	88500 lbf/in ² / 180 HB	0.6010	A48-20B	0.6025	A48-40 B
		K.1.2	Pearlitic (martensitic)	127600 lbf/in ² / 260 HB	0.6030	A48-45B	0.6040	A48-60 B
	Spherulitic graphite cast iron	K.2.1	Ferritic	78300 lbf/in ² / 160 HB	0.7040	60-40-18	0.7050	65-45-12
		K.2.2	Pearlitic	122600 lbf/in ² / 250 HB	0.7070	100-70-03	0.7660	A439 Type D2
	Malleable iron	K.3.1	Ferritic	63800 lbf/in ² / 130 HB	0.8035	GTW-35-04		
		K.3.2	Pearlitic	113100 lbf/in ² / 230 HB	0.8170	70003		
N	Aluminium wrought alloy	N.1.1	Non-hardenable	60 HB	3.0255	A91060	3.0255	A91060
		N.1.2	Hardenable	49300 lbf/in ² / 100 HB	3.1355	2024	3.1355	2024
	Cast aluminium alloy	N.2.1	≤ 12 % Si, non-hardenable	36300 lbf/in ² / 75 HB	3.2581	A04130 / A413-0	3.2581	A04130 / A413-0
		N.2.2	≤ 12 % Si, hardenable	43500 lbf/in ² / 90 HB	3.2134	G-AISi5Cu1Mg		
		N.2.3	> 12 % Si, non-hardenable	63800 lbf/in ² / 130 HB		G-AISi17Cu4Mg		
	Copper and copper alloys (bronze/brass)	N.3.1	Free-machining alloys, PB > 1 %	54400 lbf/in ² / 110 HB	2.0380	CuZn39Pb2 (Ms58)	2.0380	C37700
		N.3.2	CuZn, CuSnZn	43500 lbf/in ² / 90 HB	2.0331	CuZn15	2.0331	C34000
		N.3.3	CuSn, lead-free copper and electrolytic copper	49300 lbf/in ² / 100 HB	2.0060	E-Cu57		
	Magnesium alloys	N.4.1	Magnesium and magnesium alloys	70 HB	3.5612	MgAl6Zn		
	S	Heat-resistant alloys	S.1.1	Fe - basis Annealed	98600 lbf/in ² / 200 HB	1.4864	X12NiCrSi 36-16	1.4864
S.1.2			Fe - basis	137800 lbf/in ² / 280 HB	1.4980	X6NiCrTiMoVB25-15-2	1.4980	S66286
S.2.1			Annealed	121800 lbf/in ² / 250 HB	2.4856	Inconel 625	2.4812	Hastelloy C
S.2.2			Ni or Co basis	171100 lbf/in ² / 350 HB	2.4952	Nimonic 80A	2.4668	Inconel 718
S.2.3			Cast	156600 lbf/in ² / 320 HB	2.4674	Nimocast PK24	2.4670	Nimocast 713
Titanium alloys		S.3.1	Pure titanium	5800 lbf/in ²	3.7025	Ti99,8		
		S.3.2	Alpha + beta alloys	152300 lbf/in ²	3.7165	TiAl6V4		
		S.3.3	Beta alloys	203100 lbf/in ² / 410 HB	Ti555.3	Ti-5Al-5V-5Mo-3Cr		
H	Hardened steel	H.1.1	Hardened and tempered	46-55 HRC				
		H.1.2	Hardened and tempered	56-60 HRC				
		H.1.3	Hardened and tempered	61-65 HRC				
		H.1.4	Hardened and tempered	66-70 HRC				
	Chilled iron	H.2.1	Cast	400 HB				
	Hardened cast iron	H.3.1	Hardened and tempered	55 HRC				
O	Non-metal materials	O.1.1	Plastics, duroplastic	≤ 21800 lbf/in ²				
		O.1.2	Plastics, thermoplastic	≤ 14500 lbf/in ²				
		O.2.1	Aramid fibre-reinforced	≤ 145000 lbf/in ²				
		O.2.2	Glass/carbon-fibre reinforced	≤ 145000 lbf/in ²				
		O.3.1	Graphite					

* Tensile Strength at Rupture (Rm)

Cutting data standard values

Index	DRAGONSKIN													H210T	H10T/ H216T	CWN15	
	TCM407	TCM10	CTEP110	CTCP115	CTCP125	CTCP135	CTCK110	CTCK120	CTPM125	CTCM120	CTCM130	CTPX710 -M34	CTPX710 -25P/25Q				CTPX715 -27
	v _c in ft/min																
P.1.1	1250	1020	1530	1220	970	690	1300	1080	670	750	610	1070	1120	910			
P.1.2	1080	880	1330	1040	830	580	1140	930	560	660	500	940	990	780			
P.1.3	930	750	1150	890	690	480	980	780	470	570	400	830	860	660			
P.1.4	870	700	1090	830	660	450	930	740	440	540	370	790	830	620			
P.1.5	790	640	1000	760	590	400	850	670	390	500	320	730	780	560			
P.2.1	1110	900	1360	1070	860	590	1160	950	580	670	520	960	990	800			
P.2.2	860	690	1070	830	640	430	920	730	430	530	360	780	830	610			
P.2.3	790	640	1000	760	590	400	850	670	390	500	320	730	780	560			
P.2.4	600	480	770	560	430	280	660	490	270	380	200	580	630	410			
P.3.1	930	720	1140	660	560	500	900	730	470	520	410	460	500	450			
P.3.2	740	550	920	460	350	310	740	580	320	380	270	280	310	270			
P.3.3	550	380	700	280	130	120	590	430	170	240	130	100	120	80			
P.4.1	930	720	1140	660	560	510			470	520	410	460	510	450			
P.4.2	830	640	1030	560	450	410			390	450	340	370	430	360			
M.1.1	930	720	1140			510			470	520	410	460	500	450			330
M.2.1						310			320	380	270	280	300	270			180
M.3.1						450			420	480	370	410	430	400			280
K.1.1			1350	840	560		1320	910						660	560	460	
K.1.2			1020	780	530		1020	870						530	430	380	
K.2.1	1170	860	1450	890	590		1060	960						630	590	500	
K.2.2	1040	710	1160	680	530		910	760						500	430	360	
K.3.1	1070	990	1370	830	660		1020	910						690	630	560	
K.3.2	830	680	830	690	530		870	760						590	530	460	
N.1.1												6070	6070	5780	5450	4620	5450
N.1.2												5280	5280	4950	4460	3630	4620
N.2.1												4130	4130	3960	3960	3140	4130
N.2.2												4130	4130	3960	3630	3140	3960
N.2.3												2480	2480	2310	1980	1650	2480
N.3.1												2150	2150	2060	1730	1400	1980
N.3.2												2080	2080	1980	1650	1320	1880
N.3.3												1650	1650	1570	1240	910	1520
N.4.1												1120	1120	1070	910	740	920
S.1.1											115	330	365	130	140		
S.1.2											85	265	280	100	110		
S.2.1											65	210	250	100	110		
S.2.2											65	130	150	80	80		
S.2.3											60	125	140	65	65		
S.3.1											365	315	330	365	365		
S.3.2											210	180	200	230	230		
S.3.3											150	130	150	165	165		
H.1.1																	
H.1.2																	
H.1.3																	
H.1.4																	
H.2.1																	
H.3.1																	
O.1.1														460	530	430	
O.1.2																	
O.2.1														495	460	350	
O.2.2																	
O.3.1																	

4

 The cutting data is strongly influenced by external conditions, such as the stability of the tool and workpiece clamping, material and type of machine. The specified values represent guideline cutting data that can be adjusted by approx. ±20% according to the usage conditions.

Cutting data standard values

	CT-P15	CT-P25	CT-P35
Index	v _c in ft/min		
P.1.1	960	780	540
P.1.2	830	660	460
P.1.3	710	560	380
P.1.4	660	530	360
P.1.5	610	480	330
P.2.1	860	690	480
P.2.2	660	510	350
P.2.3	610	480	310
P.2.4	450	350	210
P.3.1	530	450	400
P.3.2	380	280	250
P.3.3	210	110	90
P.4.1	530	450	400
P.4.2	460	360	330
M.1.1	500	430	400
M.2.1	410	350	250
M.3.1	460	400	360
K.1.1			
K.1.2			
K.2.1			
K.2.2			
K.3.1			
K.3.2			
N.1.1			
N.1.2			
N.2.1			
N.2.2			
N.2.3			
N.3.1			
N.3.2			
N.3.3			
N.4.1			
S.1.1			
S.1.2			
S.2.1			
S.2.2			
S.2.3			
S.3.1			
S.3.2			
S.3.3			
H.1.1			
H.1.2			
H.1.3			
H.1.4			
H.2.1			
H.3.1			
O.1.1			
O.1.2			
O.2.1			
O.2.2			
O.3.1			



The cutting data is strongly influenced by external conditions, such as the stability of the tool and workpiece clamping, material and type of machine. The specified values represent guideline cutting data that can be adjusted by approx. **±20%** according to the usage conditions.

Machinability of non-ferrous metals with carbide indexable inserts

	Material group	Material examples		Machinability of aluminium alloys	Comments	
				*		
N	Pure aluminium	non hardenable	Al 99,5	W7	5	<ul style="list-style-type: none"> ▲ Snarl chips ▲ Possibly bad surface ▲ Excessive built-up edge ▲ Long tool life ▲ Use coolant emulsion
			Al 99,5	F13	4	
			Al 99	W8	5	
			Al 99	F14	4	
	Aluminium wrought alloys	non hardenable	Al Mn	W10	5	<ul style="list-style-type: none"> ▲ Snarl, continuous or fragmented chip ▲ Large feed rates necessary for good chip control ▲ Built-up edge ▲ Long tool life ▲ Emulsion coolant is advantageous
			Al Mn	F16	4	
			Al Mg 1	W10	5	
			Al Mg 1	F19	4	
			Al Mg 3	W18	4	
			Al Mg 3	F25	3	
			Al Mg 5	W25	4	
			AL Mg 5	F28	2	
			Al Mg 4,5 Mn	W27	4	
			Al Mg 4,5 Mn	G35	3	
		hardenable	Al Mg Si 0,5	W	4	<ul style="list-style-type: none"> ▲ Good chip control with higher feed rates ▲ Very good chip control ▲ No built up edge ▲ Very good surface quality ▲ Good chip control ▲ Good surface quality ▲ Little built-up edge
			Al Mg Si 0,5	F13-25	3	
			Al Mg Si 1	W	4	
			Al Mg Si 1	F21-30	3	
			Al Mg Si Pb	F20-28	2	
			Al Cu Si Pb	F28-37	1	
			Al Cu Mg Pb	F34-37	1	
			Al Cu Mg 1	W	3	
			Al Cu Mg 1	F33-40	2	
			Al Cu Mg 2	W	3	
	Cast Aluminium Alloys	non hardenable	G-Al Si 12		3	<ul style="list-style-type: none"> ▲ Good chip control ▲ Built-up edge ▲ Higher Si content results in lower tool life ▲ High wear of the carbide ▲ Good chip control ▲ Good surface quality ▲ Long tool life
			G-Al Si 10 Mg		3	
			G-Al Si 5 Mg		2	
			G-Al Si 7 Mg (9 Mg)		2	
			G-Al Si Cu 3		2	
			G-Al Si 6 Cu 4		2	
			G-Al Mg 3 (Mg 5)		2	
			G-Al Mg 9		2	
			G-Al Mg 10		2	
			G-Al Mg 3 Si (5 Si)		2	
	G-Al Cu 4 Ti (Mg)		2			
	G-Al Si 12 Cu Mg Ni		2			
	Copper wrought alloys		Cu Ag			
			Cu As			
			Cu Cd			
			Cu Cd Sn			
Cu Mg						
Cu Mn						
brass		Cu Zn Al				
		bronze	Cu Sn			
			Cu Sn Zn			
			Cu Ni			
Cu Ni Fe						
		Cu Al				
0	Non metal materials	Duroplastics				
		Fibre-reinforced plastics				
		hard rubber				

* 1 = good machinability, 5 = bad machinability

Cutting data values for CBN inserts

			CTB S05U					
Cutting edges code negative insert*			EN			F / TN-F		
Cutting edges code positive insert*			EN			TN-D		
Index	Material	Strength N/mm ² * / HB / HRC	v _c	f	a _p	v _c	f	a _p
	Sintered steels (< HV300)							
	general sintered steel (> HV300)							
	high density sintered steel (> HV600)							
K.1.1	Grey cast iron	350 N/mm ² / 180 HB	3000-5300	0.0008-0.010	0.0060-0.400	3000-5300	0.0008-0.010	0.0060-0.400
K.1.2		500 N/mm ² / 260 HB	3000-5300	0.0008-0.010	0.0060-0.400	3000-5300	0.0008-0.010	0.0060-0.400
K.2.1	Spherulitic graphite cast iron	540 N/mm ² / 160 HB	3300-5800	0.0008-0.010	0.0060-0.400	3300-5800	0.0008-0.010	0.0060-0.400
K.2.2		845 N/mm ² / 250 HB	3300-5800	0.0008-0.010	0.0060-0.400	3300-5800	0.0008-0.010	0.0060-0.400
K.3.1	Malleable iron	440 N/mm ² / 130 HB	3300-5800	0.0008-0.010	0.0060-0.400	3300-5800	0.0008-0.010	0.0060-0.400
K.3.2		780 N/mm ² / 220 HB	3300-5800	0.0008-0.010	0.0060-0.400	3300-5800	0.0008-0.010	0.0060-0.400
S.1.1	Heat-resistant alloys	680 N/mm ² / 200 HB						
S.1.2		950 N/mm ² / 280 HB						
S.2.1		840 N/mm ² / 250 HB						
S.2.2		1180 N/mm ² / 350 HB						
S.2.3		1080 N/mm ² / 320 HB						
S.3.1		400 N/mm ²						
S.3.2		Titanium alloys	1050 N/mm ² / 320 HB					
S.3.3		1400 N/mm ² / 410 HB						

* Tensile strength

			CTB S10U / CTB S10C					
Cutting edges code negative insert*			EN			F / FN		
Cutting edges code positive insert*			EN / FN			TN-D		
Index	Material	Strength N/mm ² * / HB / HRC	v _c	f	a _p	v _c	f	a _p
	Sintered steels (< HV300)		800-2500	0.0008-0.010	0.0008-0.016	700-1800	0.0032-0.014	0.0040-0.016
	general sintered steel (> HV300)		660-2300	0.0008-0.010	0.0008-0.016	500-1300	0.0032-0.014	0.0040-0.016
	high density sintered steel (> HV600)		150-1150	0.0008-0.010	0.0008-0.016	330-700	0.0032-0.014	0.0040-0.016
K.1.1	Grey cast iron	350 N/mm ² / 180 HB	3000-5300	0.0008-0.010	0.0008-0.010	2300-4000	0.0032-0.014	0.0032-0.016
K.1.2		500 N/mm ² / 260 HB	3000-5300	0.0008-0.010	0.0008-0.010	2300-4000	0.0032-0.014	0.0032-0.016
K.2.1	Spherulitic graphite cast iron	540 N/mm ² / 160 HB	3300-5800	0.0008-0.010	0.0008-0.010	2600-4100	0.0032-0.014	0.0032-0.016
K.2.2		845 N/mm ² / 250 HB	3300-5800	0.0008-0.010	0.0008-0.010	2600-4100	0.0032-0.014	0.0032-0.016
K.3.1	Malleable iron	440 N/mm ² / 130 HB	3300-5800	0.0008-0.010	0.0008-0.010	2600-4100	0.0032-0.014	0.0032-0.016
K.3.2		780 N/mm ² / 220 HB	3300-5800	0.0008-0.010	0.0008-0.010	2600-4100	0.0032-0.014	0.0032-0.016
S.1.1	Heat-resistant alloys	680 N/mm ² / 200 HB	300-700	0.0008-0.010	0.0008-0.016	250-400	0.0032-0.014	0.0032-0.016
S.1.2		950 N/mm ² / 280 HB	300-700	0.0008-0.010	0.0008-0.016	250-400	0.0032-0.014	0.0032-0.016
S.2.1		840 N/mm ² / 250 HB	300-700	0.0008-0.010	0.0008-0.016	250-400	0.0032-0.014	0.0032-0.016
S.2.2		1180 N/mm ² / 350 HB	300-700	0.0008-0.010	0.0008-0.016	250-400	0.0032-0.014	0.0032-0.016
S.2.3		1080 N/mm ² / 320 HB	300-700	0.0008-0.010	0.0008-0.016	250-400	0.0032-0.014	0.0032-0.016
S.3.1		400 N/mm ²						
S.3.2		Titanium alloys	1050 N/mm ² / 320 HB					
S.3.3		1400 N/mm ² / 410 HB						

* Tensile strength

 * Note chamfer width: The wider the chamfer, the more stable the cutting edge.

 The cutting data is strongly influenced by external conditions, such as the stability of the tool and workpiece clamping, material and type of machine. The specified values represent guideline cutting data that can be adjusted by approx. ±20% according to the usage conditions.

CTB S10C								
TN-B			TN-C			TN-D / TN-E		
SN-B			SN-C / TN-C			TN-D / SN-D		
v _c	f	a _p	v _c	f	a _p	v _c	f	a _p
660-1300	0.0020-0.016	0.0024-0.016	500-1150	0.0024-0.020	0.0032-0.020	500-1000	0.0040-0.014	0.0040-0.016
1150-1800	0.0020-0.016	0.0024-0.016	1000-1650	0.0024-0.020	0.0032-0.020	800-1500	0.0040-0.014	0.0040-0.016
1000-1650	0.0020-0.016	0.0024-0.016	650-1300	0.0024-0.020	0.0032-0.020	650-1300	0.0040-0.014	0.0040-0.016
2500-4000	0.0020-0.016	0.0024-0.016	2650-4300	0.0024-0.020	0.0032-0.020	2000-3600	0.0040-0.014	0.0040-0.016
2500-4000	0.0020-0.016	0.0024-0.016	2650-4300	0.0024-0.020	0.0032-0.020	2000-3600	0.0040-0.014	0.0040-0.016
2500-4000	0.0020-0.016	0.0024-0.016	2650-4300	0.0024-0.020	0.0032-0.020	2000-3600	0.0040-0.014	0.0040-0.016
2500-4000	0.0020-0.016	0.0024-0.016	2650-4300	0.0024-0.020	0.0032-0.020	2000-3600	0.0040-0.014	0.0040-0.016
2500-4000	0.0020-0.016	0.0024-0.016	2650-4300	0.0024-0.020	0.0032-0.020	2000-3600	0.0040-0.014	0.0040-0.016
2500-4000	0.0020-0.016	0.0024-0.016	2650-4300	0.0024-0.020	0.0032-0.020	2000-3600	0.0040-0.014	0.0040-0.016
400-600	0.0020-0.016	0.0024-0.016	300-500	0.0024-0.020	0.0032-0.020	250-450	0.0040-0.014	0.0040-0.016
400-600	0.0020-0.016	0.0024-0.016	300-500	0.0024-0.020	0.0032-0.020	250-450	0.0040-0.014	0.0040-0.016
400-600	0.0020-0.016	0.0024-0.016	300-500	0.0024-0.020	0.0032-0.020	250-450	0.0040-0.014	0.0040-0.016
400-600	0.0020-0.016	0.0024-0.016	300-500	0.0024-0.020	0.0032-0.020	250-450	0.0040-0.014	0.0040-0.016
400-600	0.0020-0.016	0.0024-0.016	300-500	0.0024-0.020	0.0032-0.020	250-450	0.0040-0.014	0.0040-0.016

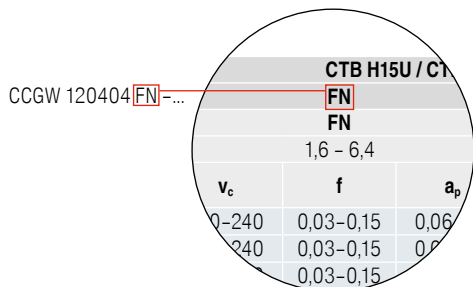

Cutting data values for CBN inserts

			CTB S20C / CTB S20U					
Index	Material	Strength N/mm ² * / HB / HRC	EN / FN			SN-B		
			EN / FN			SN-B		
			v _c	f	a _p	v _c	f	a _p
	Sintered steels (< HV300)		800-2300	0.0008-0.010	0.0008-0.016	800-2300	0.0032-0.010	0.0012-0.016
	general sintered steel (> HV300)		650-2300	0.0008-0.010	0.0008-0.016	650-2300	0.0032-0.010	0.0012-0.016
	high density sintered steel (> HV600)		500-1150	0.0008-0.010	0.0008-0.016	500-1150	0.0032-0.010	0.0012-0.016
K.1.1	Grey cast iron	350 N/mm ² / 180 HB	2650-4800	0.0008-0.010	0.0020-0.010	2300-4600	0.0016-0.010	0.0020-0.010
K.1.2		500 N/mm ² / 260 HB	2650-4800	0.0008-0.010	0.0020-0.010	2300-4600	0.0016-0.010	0.0020-0.010
K.2.1	Spherulitic graphite cast iron	540 N/mm ² / 160 HB	3000-5300	0.0008-0.010	0.0020-0.010	2600-5300	0.0016-0.010	0.0020-0.010
K.2.2		845 N/mm ² / 250 HB	3000-5300	0.0008-0.010	0.0020-0.010	2600-5300	0.0016-0.010	0.0020-0.010
K.3.1	Malleable iron	440 N/mm ² / 130 HB	3000-5300	0.0008-0.010	0.0020-0.010	2600-5300	0.0016-0.010	0.0020-0.010
K.3.2		780 N/mm ² / 220 HB	3000-5300	0.0008-0.010	0.0020-0.010	2600-5300	0.0016-0.010	0.0020-0.010
S.1.1	Heat-resistant alloys	680 N/mm ² / 200 HB	200-600	0.0008-0.010	0.0008-0.016	200-550	0.0016-0.010	0.0012-0.016
S.1.2		950 N/mm ² / 280 HB	200-600	0.0008-0.010	0.0008-0.016	200-550	0.0016-0.010	0.0012-0.016
S.2.1		840 N/mm ² / 250 HB	200-600	0.0008-0.010	0.0008-0.016	200-550	0.0016-0.010	0.0012-0.016
S.2.2		1180 N/mm ² / 350 HB	200-600	0.0008-0.010	0.0008-0.016	200-550	0.0016-0.010	0.0012-0.016
S.2.3		1080 N/mm ² / 320 HB	200-600	0.0008-0.010	0.0008-0.016	200-550	0.0016-0.010	0.0012-0.016
S.3.1		400 N/mm ²						
S.3.2		1050 N/mm ² / 320 HB						
S.3.3	Titanium alloys	1400 N/mm ² / 410 HB						

* Tensile strength

			CTB S20C / CTB S20U					
Index	Material	Strength N/mm ² * / HB / HRC	TN-E			SN-E		
			TN-E			SN-E		
			v _c	f	a _p	v _c	f	a _p
	Sintered steels (< HV300)		700-1800	0.0032-0.014	0.0040-0.016	650-1700	0.0040-0.014	0.0040-0.016
	general sintered steel (> HV300)		500-1300	0.0032-0.014	0.0040-0.016	450-1150	0.0040-0.014	0.0040-0.016
	high density sintered steel (> HV600)		350-750	0.0032-0.014	0.0040-0.016	350-650	0.0040-0.014	0.0040-0.016
K.1.1	Grey cast iron	350 N/mm ² / 180 HB	1800-3300	0.0032-0.014	0.0032-0.016	1800-3150	0.0040-0.014	0.0040-0.016
K.1.2		500 N/mm ² / 260 HB	1800-3300	0.0032-0.014	0.0032-0.016	1800-3150	0.0040-0.014	0.0040-0.016
K.2.1	Spherulitic graphite cast iron	540 N/mm ² / 160 HB	2300-4000	0.0032-0.014	0.0032-0.016	2300-3600	0.0040-0.014	0.0040-0.016
K.2.2		845 N/mm ² / 250 HB	2300-4000	0.0032-0.014	0.0032-0.016	2300-3600	0.0040-0.014	0.0040-0.016
K.3.1	Malleable iron	440 N/mm ² / 130 HB	2300-4000	0.0032-0.014	0.0032-0.016	2300-3600	0.0040-0.014	0.0040-0.016
K.3.2		780 N/mm ² / 220 HB	2300-4000	0.0032-0.014	0.0032-0.016	2300-3600	0.0040-0.014	0.0040-0.016
S.1.1	Heat-resistant alloys	680 N/mm ² / 200 HB	150-350	0.0032-0.014	0.0032-0.016	150-320	0.0040-0.014	0.0040-0.016
S.1.2		950 N/mm ² / 280 HB	150-350	0.0032-0.014	0.0032-0.016	150-320	0.0040-0.014	0.0040-0.016
S.2.1		840 N/mm ² / 250 HB	150-350	0.0032-0.014	0.0032-0.016	150-320	0.0040-0.014	0.0040-0.016
S.2.2		1180 N/mm ² / 350 HB	150-350	0.0032-0.014	0.0032-0.016	150-320	0.0040-0.014	0.0040-0.016
S.2.3		1080 N/mm ² / 320 HB	150-350	0.0032-0.014	0.0032-0.016	150-320	0.0040-0.014	0.0040-0.016
S.3.1		400 N/mm ²						
S.3.2		1050 N/mm ² / 320 HB						
S.3.3	Titanium alloys	1400 N/mm ² / 410 HB						

* Tensile strength

 * Note chamfer width: The wider the chamfer, the more stable the cutting edge.



 The cutting data is strongly influenced by external conditions, such as the stability of the tool and workpiece clamping, material and type of machine. The specified values represent guideline cutting data that can be adjusted by approx. ±20% according to the usage conditions.

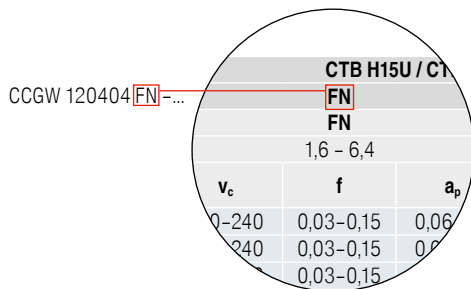

CTB S20C / CTB S20U								
SN-C / TN-C			SN-C / TN-C			SN-D		
TN-C			TN-D			SN-D		
v_c	f	a_p	v_c	f	a_p	v_c	f	a_p
800-2000	0.0020-0.010	0.0024-0.016	800-2000	0.0020-0.014	0.0024-0.016	750-1900	0.0024-0.014	0.0032-0.016
660-2000	0.0020-0.010	0.0024-0.016	600-1800	0.0020-0.014	0.0024-0.016	550-1700	0.0024-0.014	0.0032-0.016
500-1650	0.0020-0.010	0.0024-0.016	450-1000	0.0020-0.014	0.0024-0.016	400-850	0.0024-0.014	0.0032-0.016
2150-4300	0.0020-0.010	0.0024-0.016	2150-3650	0.0020-0.014	0.0024-0.016	2000-3300	0.0024-0.014	0.0032-0.020
2150-4300	0.0020-0.010	0.0024-0.016	2150-3650	0.0020-0.014	0.0024-0.016	2000-3300	0.0024-0.014	0.0032-0.020
2600-4600	0.0020-0.010	0.0024-0.016	2500-4300	0.0020-0.014	0.0024-0.016	2300-4100	0.0024-0.014	0.0032-0.020
2600-4600	0.0020-0.010	0.0024-0.016	2500-4300	0.0020-0.014	0.0024-0.016	2300-4100	0.0024-0.014	0.0032-0.020
2600-4600	0.0020-0.010	0.0024-0.016	2500-4300	0.0020-0.014	0.0024-0.016	2300-4100	0.0024-0.014	0.0032-0.020
200-550	0.0020-0.010	0.0024-0.016	180-500	0.0020-0.016	0.0024-0.016	180-450	0.0024-0.020	0.0032-0.020
200-550	0.0020-0.010	0.0024-0.016	180-500	0.0020-0.016	0.0024-0.016	180-450	0.0024-0.020	0.0032-0.020
200-550	0.0020-0.010	0.0024-0.016	180-500	0.0020-0.016	0.0024-0.016	180-450	0.0024-0.020	0.0032-0.020
200-550	0.0020-0.010	0.0024-0.016	180-500	0.0020-0.016	0.0024-0.016	180-450	0.0024-0.020	0.0032-0.020
200-550	0.0020-0.010	0.0024-0.016	180-500	0.0020-0.016	0.0024-0.016	180-450	0.0024-0.020	0.0032-0.020



CTB S20C / CTB S20U		
SN-F		
SN-F		
v_c	f	a_p
600-1600	0.0048-0.014	0.0048-0.016
250-850	0.0048-0.014	0.0048-0.016
250-500	0.0048-0.014	0.0048-0.016
1600-2800	0.0048-0.014	0.0048-0.016
1600-2800	0.0048-0.014	0.0048-0.016
2150-3300	0.0048-0.014	0.0048-0.016
2150-3300	0.0048-0.014	0.0048-0.016
2150-3300	0.0048-0.014	0.0048-0.016
2150-3300	0.0048-0.014	0.0048-0.016
130-300	0.0048-0.014	0.0048-0.016
130-300	0.0048-0.014	0.0048-0.016
130-300	0.0048-0.014	0.0048-0.016
130-300	0.0048-0.014	0.0048-0.016
130-300	0.0048-0.014	0.0048-0.016







Cutting data values for CBN inserts

				CTB H15U / CTB H15C					
Cutting edges code negative insert*				FN			EN		
Cutting edges code positive insert*				FN			EN		
Ra (theo.)				1,6-6,4			1,0-3,2		
Index	Material	Strength	 	v _c	f	a _p	v _c	f	a _p
H.1.1	Hardened steel	46-55 HRC	x	525-800	0.0012-0.006	0.0024-0.012	525-800	0.0012-0.006	0.0024-0.012
H.1.2		56-60 HRC	x	525-800	0.0012-0.006	0.0024-0.012	525-800	0.0012-0.006	0.0024-0.012
H.1.3		61-65 HRC	x	525-800	0.0012-0.006	0.0024-0.012	525-800	0.0012-0.006	0.0024-0.012
H.1.4		66-70 HRC	x	525-800	0.0012-0.006	0.0024-0.012	525-800	0.0012-0.006	0.0024-0.012
H.2.1	Chilled iron	400 HB	x	525-800	0.0012-0.006	0.0024-0.012	525-800	0.0012-0.006	0.0024-0.012
H.3.1	Hardened cast iron	55 HRC							

				CTB H21U / CTB H20C / CTB H21C					
Cutting edges code negative insert*				FN			TN-C		
Cutting edges code positive insert*				EN / FN			TN-C		
Ra (theo.)				1,6-6,4			1,0-4,5		
Index	Material	Strength	 	v _c	f	a _p	v _c	f	a _p
H.1.1	Hardened steel	46-55 HRC	x	1000-1250	0.0016-0.020	0.0020-0.020	925-1150	0.0020-0.006	0.0020-0.020
H.1.2		56-60 HRC	x	1000-1250	0.0016-0.020	0.0020-0.020	925-1150	0.0020-0.006	0.0020-0.020
H.1.3		61-65 HRC	x	1000-1250	0.0016-0.020	0.0020-0.020	925-1150	0.0020-0.006	0.0020-0.020
H.1.4		66-70 HRC	x	1000-1250	0.0016-0.020	0.0020-0.020	925-1150	0.0020-0.006	0.0020-0.020
H.2.1	Chilled iron	400 HB	x	1000-1250	0.0016-0.020	0.0020-0.020	925-1150	0.0020-0.006	0.0020-0.020
H.3.1	Hardened cast iron	55 HRC							

				CTB H21U / CTB H20C / CTB H21C					
Cutting edges code negative insert*				TN-E / SN-E			SN-F		
Cutting edges code positive insert*				TN-E			TN-F / SN-E		
Ra (theo.)				0,35-1,6			0,2-0,8		
Index	Material	Strength	 	v _c	f	a _p	v _c	f	a _p
H.1.1	Hardened steel	46-55 HRC	x	700-850	0.0020-0.006	0.0040-0.020	600-750	0.0024-0.008	0.0040-0.020
H.1.2		56-60 HRC	x	700-850	0.0020-0.006	0.0040-0.020	600-750	0.0024-0.008	0.0040-0.020
H.1.3		61-65 HRC	x	700-850	0.0020-0.006	0.0040-0.020	600-750	0.0024-0.008	0.0040-0.020
H.1.4		66-70 HRC	x	700-850	0.0020-0.006	0.0040-0.020	600-750	0.0024-0.008	0.0040-0.020
H.2.1	Chilled iron	400 HB	x	700-850	0.0020-0.006	0.0040-0.020	600-750	0.0024-0.008	0.0040-0.020
H.3.1	Hardened cast iron	55 HRC							

				CTB H40U / CTB H40C / CTB H41U / CTB H41C					
Cutting edges code negative insert*				FN / EN			SN-B / TN-B		
Cutting edges code positive insert*				FN / EN			SN-B / TN-B		
Ra (theo.)				1,0-3,2			1,6-3,2		
Index	Material	Strength	 	v _c	f	a _p	v _c	f	a _p
H.1.1	Hardened steel	46-55 HRC	x	625-825	0.0012-0.006	0.0012-0.020	600-825	0.0012-0.008	0.0020-0.003
H.1.2		56-60 HRC	x	625-825	0.0012-0.006	0.0012-0.020	600-825	0.0012-0.008	0.0020-0.003
H.1.3		61-65 HRC	x	625-825	0.0012-0.006	0.0012-0.020	600-825	0.0012-0.008	0.0020-0.003
H.1.4		66-70 HRC	x	625-825	0.0012-0.006	0.0012-0.020	600-825	0.0012-0.008	0.0020-0.003
H.2.1	Chilled iron	400 HB	x	625-825	0.0012-0.006	0.0012-0.020	600-825	0.0012-0.008	0.0020-0.003
H.3.1	Hardened cast iron	55 HRC							

				CTB H40U / CTB H40C / CTB H41U / CTB H41C					
Cutting edges code negative insert*				EN-T / SN-E			TN-E / SN-E		
Cutting edges code positive insert*				EN-T / TN-E / SN-E			TN-F		
Ra (theo.)				0,5-1,6			0,4-1,0		
Index	Material	Strength	 	v _c	f	a _p	v _c	f	a _p
H.1.1	Hardened steel	46-55 HRC	x	450-650	0.0020-0.006	0.0032-0.020	600-750	0.0020-0.010	0.0040-0.020
H.1.2		56-60 HRC	x	450-650	0.0020-0.006	0.0032-0.020	600-750	0.0020-0.010	0.0040-0.020
H.1.3		61-65 HRC	x	450-650	0.0020-0.006	0.0032-0.020	600-750	0.0020-0.010	0.0040-0.020
H.1.4		66-70 HRC	x	450-650	0.0020-0.006	0.0032-0.020	600-750	0.0020-0.010	0.0040-0.020
H.2.1	Chilled iron	400 HB	x	450-650	0.0020-0.006	0.0032-0.020	600-750	0.0020-0.010	0.0040-0.020
H.3.1	Hardened cast iron	55 HRC							

 * Note chamfer width: The wider the chamfer, the more stable the cutting edge.

 The cutting data is strongly influenced by external conditions, such as the stability of the tool and workpiece clamping, material and type of machine. The specified values represent guideline cutting data that can be adjusted by approx. ±20% according to the usage conditions.

CTB H15U / CTB H15C								
SN-C			SN-E			RN (Rounded chamfer)		
SN-C			SN-E			RN (Rounded chamfer)		
0,5-1,6			0,1-0,8			0,1-0,8		
v _c	f	a _p	v _c	f	a _p	v _c	f	a _p
450-650	0.0024-0.008	0.0032-0.012	400-600	0.0024-0.010	0.0040-0.016	425-700	0.0024-0.008	0.0032-0.012
450-650	0.0024-0.008	0.0032-0.012	400-600	0.0024-0.010	0.0040-0.016	425-700	0.0024-0.008	0.0032-0.012
450-650	0.0024-0.008	0.0032-0.012	400-600	0.0024-0.010	0.0040-0.016	425-700	0.0024-0.008	0.0032-0.012
450-650	0.0024-0.008	0.0032-0.012	400-600	0.0024-0.010	0.0040-0.016	425-700	0.0024-0.008	0.0032-0.012
450-650	0.0024-0.008	0.0032-0.012	400-600	0.0024-0.010	0.0040-0.016	425-700	0.0024-0.008	0.0032-0.012

CTB H21U / CTB H20C / CTB H21C								
TN-D			TN-D / SN-D			TN-E		
SN-B			TN-D / SN-C			SN-D		
0,8-3,0			0,5-2,0			0,35-2,5		
v _c	f	a _p	v _c	f	a _p	v _c	f	a _p
900-1100	0.0024-0.010	0.0020-0.020	825-1050	0.0024-0.010	0.0032-0.004	725-950	0.0020-0.006	0.0032-0.020
900-1100	0.0024-0.010	0.0020-0.020	825-1050	0.0024-0.010	0.0032-0.004	725-950	0.0020-0.006	0.0032-0.020
900-1100	0.0024-0.010	0.0020-0.020	825-1050	0.0024-0.010	0.0032-0.004	725-950	0.0020-0.006	0.0032-0.020
900-1100	0.0024-0.010	0.0020-0.020	825-1050	0.0024-0.010	0.0032-0.004	725-950	0.0020-0.006	0.0032-0.020
900-1100	0.0024-0.010	0.0020-0.020	825-1050	0.0024-0.010	0.0032-0.004	725-950	0.0020-0.006	0.0032-0.020

CTB H21U / CTB H20C / CTB H21C		
SN-G		
TN-G / SN-F		
0,1-0,5		
v _c	f	a _p
525-650	0.0020-0.005	0.0040-0.020
525-650	0.0020-0.005	0.0040-0.020
525-650	0.0020-0.005	0.0040-0.020
525-650	0.0020-0.005	0.0040-0.020
525-650	0.0020-0.005	0.0040-0.020

CTB H40U / CTB H40C / CTB H41U / CTB H41C								
SN-C			SN-D			TN-D		
SN-C / TN-D			SN-D			TN-D		
0,8-3,0			0,8-2,0			0,5-1,6		
v _c	f	a _p	v _c	f	a _p	v _c	f	a _p
600-800	0.0016-0.006	0.0012-0.020	525-725	0.0016-0.006	0.0012-0.020	500-700	0.0016-0.010	0.0032-0.020
600-800	0.0016-0.006	0.0012-0.020	525-725	0.0016-0.006	0.0012-0.020	500-700	0.0016-0.010	0.0032-0.020
600-800	0.0016-0.006	0.0012-0.020	525-725	0.0016-0.006	0.0012-0.020	500-700	0.0016-0.010	0.0032-0.020
600-800	0.0016-0.006	0.0012-0.020	525-725	0.0016-0.006	0.0012-0.020	500-700	0.0016-0.010	0.0032-0.020
600-800	0.0016-0.006	0.0012-0.020	525-725	0.0016-0.006	0.0012-0.020	500-700	0.0016-0.010	0.0032-0.020

CTB H40U / CTB H40C / CTB H41U / CTB H41C					
TN-F / SN-F			SN-G		
SN-F			SN-G		
0,2-0,8			0,1-0,5		
v _c	f	a _p	v _c	f	a _p
425-650	0.0016-0.006	0.0040-0.020	400-625	0.0016-0.005	0.0040-0.020
425-650	0.0016-0.006	0.0040-0.020	400-625	0.0016-0.005	0.0040-0.020
425-650	0.0016-0.006	0.0040-0.020	400-625	0.0016-0.005	0.0040-0.020
425-650	0.0016-0.006	0.0040-0.020	400-625	0.0016-0.005	0.0040-0.020
425-650	0.0016-0.006	0.0040-0.020	400-625	0.0016-0.005	0.0040-0.020

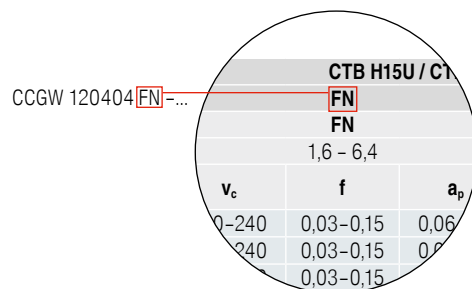

Cutting data standard values for diamond cutting materials CTD PD20 / PS30 / PU20 / CD10 / MD05

Index	Material group		$a_p = 0.0015'' - 0.016''$ Surface roughness R_z in μm		$a_p = 0.0016'' - 0.040''$ Surface roughness R_z in μm		$a_p = 0.0016'' - 0.100''$ Surface roughness R_z in μm			
			2,5-5,0		5,0-10		2,5-5,0		5,0-10	
			CTD ...	CTD ...	CTD ...	CTD ...	CTD ...	CTD ...		
N.1.1 N.1.2	Aluminium wrought alloys without Si $f=0.002-0.020$ inch/rev.	Tool Material v_c in ft/min	PD20 / PU20 / CD10 / MD05 1300-8250	PD20 / PU20 / CD10 / MD05 1300-8250	PD20 / PU20 / CD10 / MD05 1300-6600	PD20 / PU20 / CD10 / MD05 1300-6600	PD20 / PU20 / CD10 / MD05 1300-5300	PD20 / PU20 / CD10 / MD05 1300-5300		
		Tool Material v_c in ft/min		PD20 / CD10 1300-8250		PD20 / CD10 1300-6600		PD20 / CD10 1300-5300		
		Tool Material v_c in ft/min	PD20 / PU20 1300-8250	PD20 / PU20 1300-8250	PD20 / PU20 1300-6600	PD20 / PU20 1300-6600	PD20 / PU20 1300-5300	PD20 / PU20 1300-5300		
N.2.1	Cast Aluminium Alloys $Si \leq 12\%$ - hardened or $Si = 12-20\%$ - non hardened $f=0.002-0.020$ inch/rev.	Tool Material v_c in ft/min	PS30 / PU20 / CD10 / MD05 2000-6600	PS30 / PU20 / CD10 / MD05 2000-7000	PS30 / PU20 / CD10 / MD05 2000-6000	PS30 / PU20 / CD10 / MD05 2000-6600	PS30 / PU20 / CD10 / MD05 2000-5000	PS30 / PU20 / CD10 / MD05 2000-6000		
		Tool Material v_c in ft/min	PD20 / PU20 / CD10 1300-6600	PD20 / PU20 / CD10 1300-7000	PD20 / PU20 / CD10 1300-6000	PS30 / PU20 / CD10 2000-6600	PS30 / PU20 / CD10 1000-5000	PS30 / PU20 / CD10 1300-6000		
		Tool Material v_c in ft/min	PS30 2000-6600	PS30 2000-7000	PS30 2000-6000	PS30 2000-6600	PS30 2000-5000	PS30 2000-5000		
N.2.2 N.2.3	Aluminium cast alloys $Si = 12-20\%$ $f=0.002-0.020$ inch/rev.	Tool Material v_c in ft/min	PU20 / CD10 / MD05 2600-4000	PU20 / CD10 / MD05 1300-6000	PU20 / CD10 / MD05 2300-3300	PU20 / CD10 / MD05 1000-5000	PU20 / CD10 / MD05 2000-3000	PU20 / CD10 / MD05 1200-4000		
		Tool Material v_c in ft/min		PU20 / CD10 2000-6000		PU20 / CD10 2000-5000		PU20 / CD10 2000-4000		
		Tool Material v_c in ft/min		PU20 2000-6000		PU20 2000-5000				
N.3.1 N.3.2 N.3.3	Copper and copper wrought alloys $f=0.002-0.020$ inch/rev.	Tool Material v_c in ft/min	PD20 / PU20 / CD10 / MD05 1300-6000	PD20 / PU20 / CD10 / MD05 1000-5200	PD20 / PU20 / CD10 / MD05 1300-5300	PS30 / PU20 / CD10 / MD05 1000-5000	PD20 / PU20 / CD10 / MD05 1300-4600	PD20 / PU20 / CD10 / MD05 1300-5300		
		Tool Material v_c in ft/min	PU20 / CD10 1000-5000	PD20 / PU20 / CD10 1000-5000	PD20 / PU20 / CD10 1300-5300	PS30 / PU20 / CD10 1000-5000	PD20 / PU20 / CD10 1300-5300	PD20 / PU20 / CD10 1000-5000		
		Tool Material v_c in ft/min		PD20 / PU20 1000-6000		PS30 / PU20 1000-5700	PD20 / PU20 1000-5000	PS30 / PU20 650-4300		
O.1.1 O.1.2	Plastic materials without reinforcement (acrylic glass) $f=0.002-0.028$ inch/rev.	Tool Material v_c in ft/min		PD20 / CD10 / MD05 1200-4000		PD20 / CD10 / MD05 1000-3300		PS30 / CD10 / MD05 650-3300		
		Tool Material v_c in ft/min		PD20 / CD10 1000-4000		PD20 / CD10 650-3300		PS30 / CD10 650-3000		
		Tool Material v_c in ft/min		PD20 / CD10 1200-4000		PD20 / CD10 1000-3300		PD20 / CD10 650-3300		
O.2.1 O.2.2	Plastic materials with reinforcement (glass-fibre, carbon-fibre reinforced) $f=0.002-0.028$ inch/rev.	Tool Material v_c in ft/min	PS30 / PU20 / CD10 / MD05 1650-3300		PS30 / PU20 / CD10 / MD05 1200-3000	PS30 / PU20 / CD10 / MD05 1000-3000	PS30 / PU20 / CD10 / MD05 1300-5300	PS30 / PU20 / CD10 / MD05 650-4000		
		Tool Material v_c in ft/min	PS30 / PU20 / CD10 1300-3000		PS30 / PU20 / CD10 1300-5300	PS30 / PU20 / CD10 650-3000	PS30 / PU20 / CD10 650-3000	PS30 / PU20 / CD10 650-4600		
		Tool Material v_c in ft/min	PU20 1650-3300		PU20 1300-2600	PU20 1000-3300	PU20 1300-5300			
O.3.1	Graphite	Tool Material v_c in ft/min	PD20 / PS30 / PU20 / CD10 330-11000		PD20 / PS30 / PU20 / CD10 330-10000		PD20 / PS30 / PU20 / CD10 330-10000			

Smooth cut	Irregular cutting depth	Interrupted cut
------------	-------------------------	-----------------

Cutting data standard values for the CB chip breaker geometries

-CB1

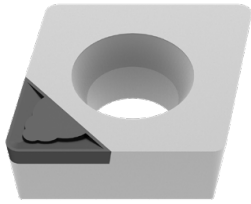

3D-Chip Breaker -CB1				
Corner Radius	a _p inch		f _z inch/rev.	
	min.	max.	min.	max.
0.004	0.002	0.012	0.001	0.002
0.008	0.002	0.016	0.001	0.003
0.016	0.004	0.031	0.002	0.006
0.032	0.006	0.039	0.003	0.008
0.064	0.012	0.059	0.005	0.010

- ▲ Finish and Superfinish
- ▲ Extremely sharp cutting edge geometry
- ▲ Depth of Cut a_p: 0.002–0.06 inch
- ▲ Smallest cutting pressure for highest accuracies
- ▲ For machining of thin-walled and unstable workpieces

-CB2

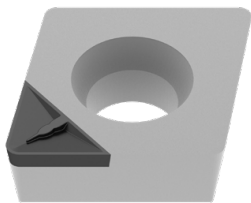

3D-Chip Breaker -CB2				
Corner Radius	a _p inch		f _z inch/rev.	
	min.	max.	min.	max.
0.008	0.020	0.031	0.003	0.005
0.016	0.024	0.059	0.003	0.008
0.032	0.028	0.059	0.006	0.012
0.064	0.031	0.079	0.008	0.016

- ▲ Semi-finish and Finish machining
- ▲ Negative edge preparation
- ▲ Cutting Depth a_p: 0.020–0.078 inch
- ▲ High surface quality and tight tolerances
- ▲ Machining of solid workpieces under stable conditions

-CB3

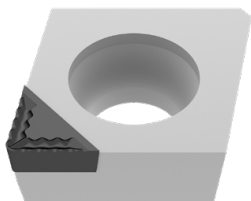

3D-Chip Breaker -CB3				
Corner Radius	a _p inch		f _z inch/rev.	
	min.	max.	min.	max.
0.016	0.039	0.118	0.004	0.008
0.032	0.039	0.118	0.006	0.014

- ▲ Medium and rough machining
- ▲ Highly aggressive chip breaker
- ▲ Cutting depth a_p: 0.04–0.12 inch
- ▲ Stable component conditions necessary
- ▲ Cooling must be ensured

Cutting data standard values for negative inserts

Designation	-CF20 (Cermet)						-F50					
	f			a _p			f			a _p		
	min.	Recommended	max.	min.	Recommended	max.	min.	Recommended	max.	min.	Recommended	max.
	inch/rev.			inch			inch/rev.			inch		
CN.. 321							0.002	0.006	0.010	0.008	0.020	0.059
CN.. 322							0.004	0.008	0.012	0.016	0.039	0.079
CN.. 431	0.002	0.006	0.010	0.012	0.020	0.059	0.002	0.006	0.010	0.008	0.024	0.059
CN.. 432	0.003	0.006	0.010	0.012	0.020	0.059	0.004	0.008	0.012	0.016	0.039	0.079
CN.. 433							0.006	0.010	0.014	0.024	0.055	0.102
CN.. 434												
CN.. 542												
CN.. 543												
CN.. 544												
CN.. 546												
CN.. 642												
CN.. 643												
CN.. 644												
CN.. 646												
CN.. 866												
DN.. 330.5							0.002	0.004	0.008	0.004	0.016	0.091
DN.. 331	0.002	0.006	0.010	0.012	0.020	0.059	0.002	0.006	0.010	0.008	0.024	0.059
DN.. 332	0.003	0.006	0.010	0.012	0.020	0.059	0.004	0.008	0.012	0.016	0.039	0.079
DN.. 333							0.006	0.010	0.014	0.024	0.055	0.102
DN.. 431							0.002	0.006	0.010	0.008	0.024	0.059
DN.. 432							0.004	0.008	0.012	0.016	0.039	0.079
DN.. 433							0.006	0.010	0.014	0.024	0.055	0.102
DN.. 434												
DN.. 441	0.002	0.006	0.010	0.012	0.020	0.059	0.002	0.006	0.010	0.008	0.024	0.059
DN.. 442	0.003	0.006	0.010	0.012	0.020	0.059	0.004	0.008	0.012	0.016	0.039	0.079
DN.. 443	0.004	0.008	0.012	0.020	0.028	0.059	0.006	0.010	0.014	0.024	0.055	0.102
DN.. 444												
SN.. 332							0.004	0.008	0.012	0.016	0.039	0.079
SN.. 431							0.002	0.006	0.010	0.008	0.024	0.059
SN.. 432							0.004	0.008	0.012	0.016	0.039	0.079
SN.. 433							0.006	0.010	0.014	0.024	0.055	0.102
SN.. 434												
SN.. 442												
SN.. 443												
SN.. 444												
SN.. 543												
SN.. 544												
SN.. 546												
SN.. 856												
SN.. 866												
TN.. 221							0.002	0.006	0.010	0.008	0.024	0.059
TN.. 222							0.004	0.008	0.012	0.016	0.039	0.079
TN.. 331	0.002	0.006	0.010	0.012	0.020	0.059	0.002	0.006	0.010	0.008	0.024	0.059
TN.. 332	0.003	0.006	0.010	0.012	0.020	0.059	0.004	0.008	0.012	0.016	0.039	0.079
TN.. 333	0.004	0.008	0.012	0.020	0.028	0.059	0.006	0.010	0.014	0.024	0.055	0.102
TN.. 431												
TN.. 432												
TN.. 433												
TN.. 434												
VN.. 331							0.002	0.006	0.010	0.008	0.024	0.059
VN.. 332							0.004	0.008	0.012	0.016	0.039	0.079
VN.. 333												
WN.. 331	0.002	0.006	0.010	0.012	0.020	0.059	0.002	0.006	0.010	0.008	0.024	0.059
WN.. 332	0.003	0.006	0.010	0.012	0.020	0.059	0.004	0.008	0.012	0.016	0.039	0.079
WN.. 333												
WN.. 431							0.002	0.006	0.010	0.008	0.024	0.059
WN.. 432	0.003	0.006	0.010	0.012	0.020	0.059	0.004	0.008	0.012	0.016	0.039	0.079
WN.. 433							0.006	0.010	0.014	0.024	0.055	0.102
WN.. 434												



The data shows reference values. An adjustment to the actual conditions may be required.

Cutting data standard values for negative inserts

Designation	-TMQ						-M70					
	f			a _p			f			a _p		
	min.	Recommended	max.	min.	Recommended	max.	min.	Recommended	max.	min.	Recommended	max.
inch/rev.			inch			inch/rev.			inch			
CN.. 321												
CN.. 322												
CN.. 431												
CN.. 432	0.008	0.016	0.026	0.031	0.118	0.197	0.008	0.012	0.018	0.031	0.118	0.236
CN.. 433	0.010	0.020	0.033	0.039	0.118	0.236	0.010	0.016	0.024	0.047	0.118	0.236
CN.. 434							0.012	0.018	0.028	0.063	0.118	0.236
CN.. 542							0.008	0.012	0.018	0.031	0.157	0.315
CN.. 543							0.010	0.016	0.024	0.047	0.157	0.315
CN.. 544							0.012	0.018	0.028	0.063	0.157	0.315
CN.. 546							0.016	0.028	0.047	0.094	0.157	0.315
CN.. 642							0.008	0.012	0.018	0.031	0.177	0.354
CN.. 643							0.010	0.016	0.024	0.047	0.177	0.354
CN.. 644							0.012	0.018	0.028	0.063	0.177	0.354
CN.. 646							0.016	0.028	0.047	0.094	0.177	0.354
CN.. 866							0.016	0.028	0.047	0.094	0.236	0.512
DN.. 330.5												
DN.. 331												
DN.. 332							0.008	0.010	0.018	0.031	0.079	0.197
DN.. 333							0.010	0.014	0.024	0.047	0.079	0.197
DN.. 431												
DN.. 432							0.008	0.010	0.018	0.031	0.098	0.236
DN.. 433							0.010	0.014	0.024	0.047	0.098	0.236
DN.. 434							0.012	0.016	0.028	0.063	0.098	0.236
DN.. 441												
DN.. 442	0.006	0.012	0.020	0.031	0.098	0.197	0.008	0.010	0.018	0.031	0.098	0.236
DN.. 443	0.008	0.016	0.024	0.039	0.118	0.197	0.010	0.014	0.024	0.047	0.098	0.236
DN.. 444							0.012	0.016	0.028	0.063	0.098	0.236
SN.. 332												
SN.. 431												
SN.. 432							0.008	0.012	0.020	0.031	0.118	0.236
SN.. 433							0.010	0.016	0.026	0.047	0.118	0.236
SN.. 434							0.012	0.018	0.028	0.063	0.118	0.236
SN.. 442												
SN.. 443							0.010	0.016	0.026	0.047	0.157	0.315
SN.. 444							0.012	0.018	0.030	0.063	0.157	0.315
SN.. 543							0.010	0.016	0.026	0.047	0.177	0.354
SN.. 544							0.012	0.018	0.030	0.063	0.177	0.354
SN.. 546							0.016	0.028	0.047	0.094	0.177	0.354
SN.. 856												
SN.. 866							0.016	0.028	0.047	0.094	0.236	0.512
TN.. 221												
TN.. 222												
TN.. 331												
TN.. 332							0.008	0.010	0.018	0.031	0.098	0.236
TN.. 333							0.010	0.014	0.024	0.047	0.098	0.236
TN.. 431							0.006	0.008	0.012	0.016	0.118	0.276
TN.. 432							0.008	0.010	0.018	0.031	0.118	0.276
TN.. 433							0.010	0.014	0.024	0.047	0.118	0.276
TN.. 434							0.012	0.016	0.028	0.063	0.118	0.276
VN.. 331												
VN.. 332												
VN.. 333												
WN.. 331												
WN.. 332							0.008	0.012	0.018	0.031	0.079	0.157
WN.. 333							0.010	0.016	0.024	0.047	0.079	0.157
WN.. 431												
WN.. 432	0.008	0.012	0.026	0.031	0.118	0.197	0.008	0.012	0.018	0.031	0.098	0.197
WN.. 433	0.010	0.016	0.033	0.039	0.118	0.236	0.010	0.016	0.024	0.047	0.098	0.197
WN.. 434							0.012	0.018	0.028	0.063	0.098	0.197

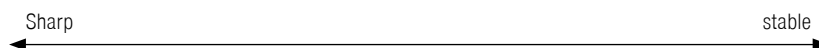

The data shows reference values. An adjustment to the actual conditions may be required.

Cutting data standard values for negative inserts

Designation	-F30						-M30					
	f			a _p			f			a _p		
	min.	Recommended	max.	min.	Recommended	max.	min.	Recommended	max.	min.	Recommended	max.
inch/rev.			inch			inch/rev.			inch			
CN.. 321												
CN.. 322												
CN.. 431	0.002	0.006	0.010	0.016	0.039	0.079						
CN.. 432	0.004	0.009	0.014	0.031	0.059	0.098	0.006	0.010	0.016	0.039	0.079	0.177
CN.. 433							0.008	0.012	0.020	0.047	0.098	0.197
CN.. 434							0.010	0.014	0.022	0.063	0.098	0.197
CN.. 542												
CN.. 543												
CN.. 544												
CN.. 546												
CN.. 642												
CN.. 643												
CN.. 644												
CN.. 646												
CN.. 866												
DN.. 330.5												
DN.. 331	0.002	0.006	0.010	0.016	0.039	0.079						
DN.. 332	0.004	0.008	0.014	0.031	0.059	0.098	0.006	0.010	0.016	0.039	0.079	0.177
DN.. 333							0.008	0.012	0.020	0.047	0.079	0.177
DN.. 431												
DN.. 432												
DN.. 433												
DN.. 434												
DN.. 441	0.002	0.006	0.010	0.016	0.039	0.079						
DN.. 442	0.004	0.008	0.014	0.031	0.059	0.098	0.006	0.010	0.016	0.039	0.079	0.217
DN.. 443							0.008	0.012	0.020	0.047	0.079	0.217
DN.. 444												
SN.. 332												
SN.. 431	0.004	0.006	0.012	0.016	0.039	0.079						
SN.. 432	0.006	0.008	0.016	0.031	0.059	0.098	0.008	0.010	0.018	0.039	0.079	0.177
SN.. 433	0.006	0.008	0.016	0.047	0.071	0.098	0.010	0.012	0.020	0.047	0.079	0.197
SN.. 434												
SN.. 442												
SN.. 443												
SN.. 444												
SN.. 543												
SN.. 544												
SN.. 546												
SN.. 856												
SN.. 866												
TN.. 221												
TN.. 222												
TN.. 331	0.002	0.006	0.010	0.016	0.039	0.079						
TN.. 332	0.004	0.006	0.014	0.031	0.059	0.098	0.006	0.010	0.016	0.039	0.079	0.177
TN.. 333							0.008	0.012	0.020	0.047	0.079	0.177
TN.. 431												
TN.. 432												
TN.. 433												
TN.. 434												
VN.. 331	0.003	0.004	0.008	0.016	0.039	0.079						
VN.. 332	0.004	0.006	0.012	0.031	0.059	0.098	0.006	0.010	0.016	0.039	0.059	0.157
VN.. 333												
WN.. 331	0.002	0.006	0.010	0.016	0.039	0.079						
WN.. 332	0.004	0.008	0.012	0.031	0.059	0.098	0.006	0.010	0.016	0.039	0.059	0.138
WN.. 333							0.008	0.012	0.018	0.047	0.059	0.157
WN.. 431	0.002	0.006	0.010	0.016	0.039	0.079						
WN.. 432	0.004	0.008	0.014	0.031	0.059	0.098	0.006	0.010	0.016	0.039	0.079	0.177
WN.. 433							0.008	0.012	0.020	0.047	0.079	0.197
WN.. 434												

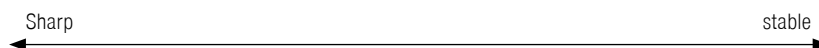

 The data shows reference values. An adjustment to the actual conditions may be required.

Designation	-M60						-M34					
	f			a _p			f			a _p		
	min.	Recommended	max.	min.	Recommended	max.	min.	Recommended	max.	min.	Recommended	max.
	inch/rev.			inch			inch/rev.			inch		
CN.. 321												
CN.. 322												
CN.. 431							0.003	0.005	0.007	0.039	0.059	0.118
CN.. 432	0.010	0.012	0.020	0.059	0.098	0.236	0.004	0.006	0.014	0.039	0.071	0.138
CN.. 433	0.012	0.014	0.022	0.079	0.118	0.236	0.005	0.008	0.016	0.059	0.079	0.157
CN.. 434	0.012	0.016	0.024	0.079	0.118	0.236	0.006	0.010	0.018	0.079	0.118	0.177
CN.. 542												
CN.. 543	0.012	0.014	0.022	0.079	0.118	0.315						
CN.. 544												
CN.. 546												
CN.. 642												
CN.. 643												
CN.. 644												
CN.. 646												
CN.. 866												
DN.. 330.5												
DN.. 331												
DN.. 332												
DN.. 333												
DN.. 431							0.003	0.005	0.007	0.031	0.047	0.098
DN.. 432							0.004	0.006	0.012	0.039	0.071	0.138
DN.. 433							0.005	0.008	0.015	0.059	0.079	0.157
DN.. 434												
DN.. 441												
DN.. 442	0.010	0.012	0.018	0.059	0.098	0.236	0.004	0.006	0.012	0.039	0.071	0.138
DN.. 443	0.012	0.016	0.022	0.059	0.098	0.236	0.005	0.008	0.015	0.059	0.079	0.157
DN.. 444												
SN.. 332												
SN.. 431												
SN.. 432	0.012	0.014	0.020	0.059	0.079	0.236	0.006	0.010	0.016	0.039	0.079	0.157
SN.. 433	0.012	0.016	0.022	0.079	0.098	0.236	0.006	0.010	0.018	0.059	0.098	0.177
SN.. 434	0.012	0.016	0.024	0.079	0.098	0.236						
SN.. 442												
SN.. 443												
SN.. 444												
SN.. 543												
SN.. 544												
SN.. 546												
SN.. 856												
SN.. 866												
TN.. 221												
TN.. 222												
TN.. 331												
TN.. 332	0.010	0.010	0.018	0.059	0.098	0.197	0.004	0.006	0.014	0.039	0.079	0.157
TN.. 333	0.012	0.012	0.022	0.079	0.098	0.217						
TN.. 431							0.004	0.006	0.014	0.039	0.079	0.157
TN.. 432							0.005	0.008	0.016	0.059	0.098	0.157
TN.. 433												
TN.. 434							0.006	0.010	0.018	0.079	0.098	0.177
VN.. 331							0.003	0.004	0.007	0.031	0.047	0.079
VN.. 332							0.004	0.006	0.008	0.039	0.059	0.098
VN.. 333							0.005	0.007	0.010	0.059	0.071	0.118
WN.. 331												
WN.. 332	0.010	0.012	0.018	0.059	0.079	0.157						
WN.. 333	0.012	0.014	0.020	0.079	0.098	0.177						
WN.. 431												
WN.. 432	0.010	0.012	0.020	0.059	0.079	0.197	0.004	0.006	0.014	0.039	0.079	0.157
WN.. 433	0.012	0.014	0.022	0.079	0.098	0.217	0.005	0.008	0.016	0.059	0.079	0.157
WN.. 434												

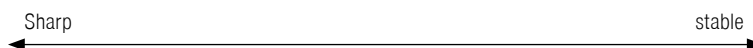

Cutting data values for positive inserts

Designation	-SMQ						-M25					
	f			a _p			f			a _p		
	min.	Recommended	max.	min.	Recommended	max.	min.	Recommended	max.	min.	Recommended	max.
	inch/rev.			inch			inch/rev.			inch		
CC.. 21.5X5												
CC.. 21.50												
CC.. 21.5.5												
CC.. 21.51							0.002	0.005	0.008	0.008	0.043	0.079
CC.. 21.52												
CC.. 32.5X5												
CC.. 32.50												
CC.. 32.5.5												
CC.. 32.51	0.004	0.010	0.016	0.016	0.079	0.157	0.002	0.006	0.009	0.008	0.047	0.087
CC.. 32.52	0.006	0.012	0.020	0.031	0.079	0.157	0.004	0.008	0.012	0.016	0.071	0.126
CC.. 32.53												
CC.. 430.5												
CC.. 431	0.004	0.010	0.016	0.016	0.079	0.157						
CC.. 432	0.006	0.012	0.020	0.031	0.079	0.157						
CC.. 433												
DC.. 21.5X5												
DC.. 21.50												
DC.. 21.50.3												
DC.. 21.5.5							0.002	0.004	0.005	0.004	0.035	0.063
DC.. 21.51	0.004	0.007	0.010	0.016	0.059	0.118	0.002	0.005	0.007	0.008	0.043	0.079
DC.. 21.52												
DC.. 32.5X5												
DC.. 32.50												
DC.. 32.50.3												
DC.. 32.5.5							0.002	0.004	0.006	0.004	0.043	0.079
DC.. 32.51	0.004	0.010	0.016	0.016	0.079	0.157	0.002	0.006	0.009	0.008	0.047	0.087
DC.. 32.52	0.006	0.012	0.020	0.031	0.079	0.157	0.004	0.008	0.012	0.016	0.071	0.126
DC.. 32.53												
RC.. 0602MO												
RC.. 0803MO												
RC.. 1003MO												
RC.. 1204MO												
RC.. 1606MO												
RC.. 2006MO												
RC.. 2507MO												
SC.. 32.51												
SC.. 32.52												
SC.. 432												
SC.. 433												
TC.. 1.81.51												
TC.. 21.5.5												
TC.. 21.51							0.002	0.005	0.008	0.008	0.047	0.087
TC.. 21.52												
TC.. 32.5.5												
TC.. 32.51							0.002	0.006	0.009	0.008	0.063	0.118
TC.. 32.52							0.004	0.008	0.012	0.016	0.075	0.134
TC.. 32.53												
TC.. 432												
VC.. 220.X12												
VC.. 220.X25												
VC.. 220.X37												
VC.. 220.5												
VC.. 221												
VC.. 222												
VC.. 330.5												
VC.. 331												
VC.. 332												
VC.. 333							0.002	0.005	0.008	0.008	0.047	0.087
VC.. 220530							0.004	0.006	0.010	0.016	0.055	0.118
WC.. 1.21.50												
WC.. 1.21.51												

Sharp ← → stable

The data shows reference values. An adjustment to the actual conditions may be required.

Designation	-M55						-F05					
	f			a _p			f			a _p		
	min.	Recommended	max.	min.	Recommended	max.	min.	Recommended	max.	min.	Recommended	max.
	inch/rev.			inch			inch/rev.			inch		
CC.. 21.5X5												
CC.. 21.50												
CC.. 21.5.5												
CC.. 21.51	0.002	0.005	0.008	0.016	0.059	0.102						
CC.. 21.52												
CC.. 32.5X5												
CC.. 32.50												
CC.. 32.5.5												
CC.. 32.51	0.003	0.006	0.009	0.016	0.067	0.118						
CC.. 32.52	0.005	0.009	0.014	0.031	0.094	0.157						
CC.. 32.53												
CC.. 430.5												
CC.. 431	0.003	0.007	0.011	0.016	0.087	0.157						
CC.. 432	0.005	0.010	0.016	0.031	0.110	0.189						
CC.. 433												
DC.. 21.5X5							0.001	0.001	0.002	0.004	0.039	0.079
DC.. 21.50							0.001	0.001	0.002	0.004	0.039	0.079
DC.. 21.50.3							0.001	0.002	0.003	0.004	0.039	0.079
DC.. 21.5.5							0.001	0.002	0.004	0.004	0.039	0.079
DC.. 21.51	0.002	0.006	0.009	0.016	0.051	0.087						
DC.. 21.52	0.003	0.006	0.009	0.031	0.063	0.094						
DC.. 32.5X5							0.001	0.001	0.002	0.004	0.049	0.098
DC.. 32.50							0.001	0.001	0.002	0.004	0.049	0.098
DC.. 32.50.3							0.001	0.002	0.003	0.004	0.049	0.098
DC.. 32.5.5							0.001	0.003	0.004	0.004	0.049	0.098
DC.. 32.51	0.003	0.006	0.009	0.016	0.067	0.118	0.001	0.004	0.010	0.004	0.049	0.098
DC.. 32.52	0.005	0.009	0.014	0.031	0.094	0.157						
DC.. 32.53												
RC.. 0602MO												
RC.. 0803MO												
RC.. 1003MO												
RC.. 1204MO												
RC.. 1606MO												
RC.. 2006MO												
RC.. 2507MO												
SC.. 32.51	0.005	0.009	0.014	0.031	0.094	0.157						
SC.. 32.52	0.005	0.010	0.016	0.031	0.110	0.189						
SC.. 432												
SC.. 433												
TC.. 1.81.51	0.002	0.005	0.007	0.016	0.051	0.087						
TC.. 21.5.5												
TC.. 21.51	0.002	0.006	0.009	0.016	0.055	0.094						
TC.. 21.52												
TC.. 32.5.5												
TC.. 32.51												
TC.. 32.52	0.005	0.009	0.014	0.031	0.102	0.173						
TC.. 32.53												
TC.. 432												
VC.. 220.X12							0.001	0.001	0.002	0.004	0.049	0.098
VC.. 220.X25							0.001	0.001	0.002	0.004	0.049	0.098
VC.. 220.X37							0.001	0.002	0.003	0.004	0.049	0.098
VC.. 220.5							0.001	0.003	0.004	0.004	0.049	0.098
VC.. 221							0.001	0.006	0.010	0.004	0.049	0.098
VC.. 222												
VC.. 330.5												
VC.. 331	0.003	0.006	0.008	0.016	0.067	0.118						
VC.. 332	0.005	0.008	0.012	0.031	0.083	0.134						
VC.. 333												
VC.. 220530												
WC.. 1.21.50												
WC.. 1.21.51												

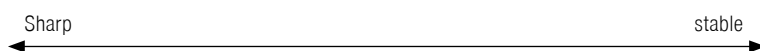

4

Application range of CBN grades

Cutting material grade	Cutting material designation	Properties		Application range	Interrupted cut	Material suitability/ ISO hardness			
		PCBN content	Main binder			Cast iron	Sintered steels	Heat-resistant	hardened
High PCBN content	CTB S05U	90 %		Chilled iron (NiHard), grey cast iron	Smooth to strongly interrupted cut	05		05	
	CTB S10C	95 %		Grey cast iron (GG252), sintered steels, super alloys	Smooth to medium interrupted cut	10	10	10	
	CTB S10U	95 %		Grey cast iron, sintered steels, super alloys		10	10	10	
	CTB S20C	90 %		Spheroidal graphite cast iron, sintered steels, super alloys	20	20	20		
Low PCBN content	CTB H15C	40 %	TiN	Tempered steels from 32 HRC	Smooth cut				15
	CTB H15U	40 %	TiN						15
	CTB H20C	65 %	TiCN	48–62 HRC	Smooth to slightly interrupted cut				20
	CTB H21C	65 %	TiCN	52–65 HRC					20
	CTB H21U	65 %	TiCN	52–65 HRC					20
	CTB H40C	55 %	TiN	48–65 HRC	Interrupted cut				40
	CTB H40U	65 %	TiN	54–65 HRC					40
	CTB H41C	65 %	TiN	48–65 HRC	Strongly interrupted cut				40
CTB H41U	65 %	TiN	54–65 HRC					40	

CBN – The Next Generation

The “sandwich” Technology

The singular system (patent), to apply CBN segments on a tungsten carbide base in a single process reduces the edge price significantly and opens up the possibility for the development of different CBN grades.

Specialized edge preparations! To achieve the highest efficiency for each application, the new CBN sandwich inserts are available with up to 8 edge preparations.

CBN Test Insert

The type CNGA test insert was specifically used, in order to identify the **quickest and most effective** type. The insert is manufactured with four edge preparations for trial. The cutting edge with highest performance gives the correct chamfer style.

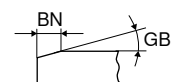

Article no.	Designation	Chamfers (BN x GB)			
		Cutting edge 1	Cutting edge 2	Cutting edge 3	Cutting edge 4
71 499 ...					
290	CNGA 120408XN_L2 CTBS20C	009B (0.004 inch x 10°)	011C (0.004 inch x 15°)	014D (0.006 inch x 20°)	018F (0.007 inch x 30°)
292	CNGA 120408XN_L2 CTBH20C	009D (0.004 inch x 20°)	011E (0.004 inch x 25°)	014F (0.006 inch x 30°)	018F (0.007 inch x 30°)
294	CNGA 120408XN_L2 CTBH40C	009D (0.004 inch x 20°)	011E (0.004 inch x 25°)	013E (0.005 inch x 25°)	014F (0.006 inch x 30°)

Diamond as a cutting material



Ensures

- ▲ Optimal surface quality
- ▲ burr-free workpieces
- ▲ high service lives
- ▲ lowest cutting forces
- ▲ High Process Security

Complete programme of roughing, finishing and wiper inserts for machining aluminium, non ferrous metals, plastics, ...

The cutting materials

	CTD CD10 (CVD)	CTD PD20 (PKD)	CTD PU20 (PKD)	CTD PS30 (PKD)
	Fine grain Size (N10)	Fine grain grade (N20)	Coarse grain grade (N20)	Coarse grain Size (N30)
Properties	<ul style="list-style-type: none"> ▲ perfect sharp edges ▲ no cutting pressure ▲ very close tolerances ▲ highest abrasion resistance with highest toughness ▲ very high heat conductivity 	<ul style="list-style-type: none"> ▲ high sharpness ▲ lower cutting pressure than PDC-S ▲ close tolerance ▲ lower abrasion resistance with increased toughness 	<ul style="list-style-type: none"> ▲ Very sharp cutting edge ▲ Reduced cutting pressure ▲ Tight tolerances ▲ Very high level of wear resistance and toughness 	<ul style="list-style-type: none"> ▲ high sharpness ▲ lower cutting pressure ▲ close tolerance ▲ lower abrasion resistance than with the PDC, with increased toughness
Material	suitable for superfinishing and semi-finishing of all non ferrous metals and NE-composite materials with small to high levels of abrasiveness	suitable for fine machining of all NE-materials with low abrasiveness	suitable for finishing to roughing non-ferrous metals and non-ferrous materials with highly abrasive alloying element. High chip removal on fibre-reinforced plastics such as CFRP and GFRP.	suitable for fine machining of all NE-materials and non-ferrous metals with low to very high levels of abrasiveness

4

Cutting Geometries

Neutral rake angle:

- ▲ higher cutting force
- ▲ higher temperature
- ▲ improved surface quality
- ▲ for stable workpieces

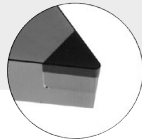

Positive rake angle:

- ▲ Lower cutting force
- ▲ Lower temperature
- ▲ reduction in surface quality
- ▲ for unstable workpieces
- ▲ improved accuracy

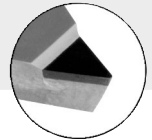

CB chip breaker geometries:



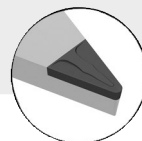









- ▲ Reliable chip control
- ▲ Ideal for low-alloy aluminium
- ▲ For F | M | R applications

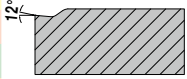

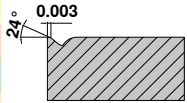
Notes on diamond usage

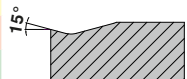

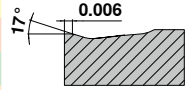

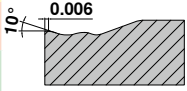
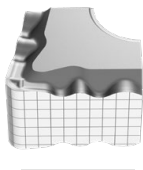
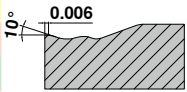

- ▲ Coolant is not generally needed, however it facilitates chip removal
- ▲ Note the chemical reaction to carbide-forming elements (PCD)
- ▲ Note the thermal interaction and critical temperature:
PCD: 600 °C, CVD: 700 °C
Depending on the material, use cooling.

Standard chip breakers / application notes

Negative	Model	Smooth cut	Irregular cutting depth	Interrupted cut	Sectional illustration		Geometry
					a_p inch	f inch	
<p>-CF / -CF20</p> <ul style="list-style-type: none"> ▲ Fine finishing ▲ Sharp cutting edge for low cutting forces ▲ Good chip control even at small depths of cut 	 F	CTEP110 / TCM10			 12°	CN.. DN.. TN.. WN..	
		CTEP110 / TCM10					
		CTEP110 / TCM10					
<p>-F40</p> <ul style="list-style-type: none"> ▲ Fine turning chip breaker for machining steels ▲ Good chip control ▲ Ideal for copy turning work 	 F	CTCP125	CTCP125		 24° 0.003	VN..	
		CTCP125	CTCP125				
<p>-F50</p> <ul style="list-style-type: none"> ▲ Fine turning chip breaker for fine machining ▲ Steel and stainless steels ▲ Excellent chip control ▲ High surface quality 	 F	CTCP115 / CTCP125	CTCP115 / CTCP125 / CTCP135	CTCP135	 15°	CN.. DN.. SN.. VN.. WN..	
			CTCP135	CTCP135			
<p>-TFQ</p> <ul style="list-style-type: none"> ▲ Wiper geometry ▲ Finishing to medium machining ▲ Very high feedrate ▲ High surface quality 	 F	CTEP110 / CTCP115	CTCP115 / CTCP125		 17° 0.006	CN.. DN.. WN..	
		CTEP110					
		CTEP110 / CTCP115	CTCP115 / CTCP125				
<p>-XU</p> <ul style="list-style-type: none"> ▲ Finishing to light roughing ▲ Universal chip breaker ▲ Copy turning ▲ Excellent chip formation ▲ Low cutting forces 	 M	CTCP115 / CTCP125	CTCP115 / CTCP125	CTCP125	 10° 0.006	CN.. DN.. VN.. WN..	
		CTCP115	CTCP115 / CTCP125				
<p>-FMS</p> <ul style="list-style-type: none"> ▲ Finishing to medium machining ▲ very good chip control ▲ universal chip breaker ▲ low cutting forces 	 F M	CT-P15 / CT-P25	CT-P15 / CT-P25	CT-P25	 10° 0.006	CN.. DN.. VN.. WN..	
		CT-P15 / CT-P25	CT-P25				
		CT-P15 / CT-P25	CT-P15 / CT-P25				



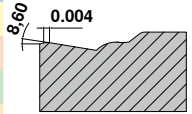
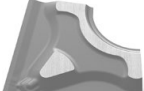
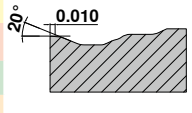
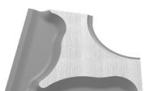
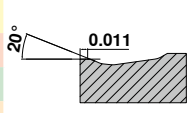
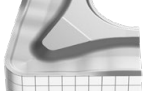
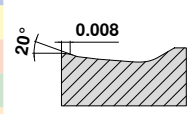
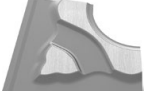
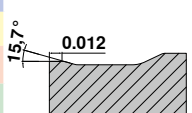

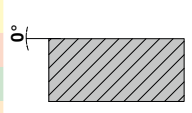
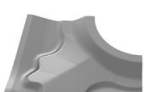
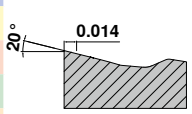
Main application steel and cast iron, secondary application stainless steels



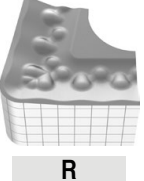
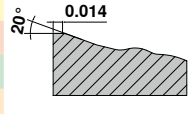

Standard chip breakers / application notes

Negative	Model	Smooth cut	Irregular cutting depth	Interrupted cut	Sectional illustration		Geometry
					a_p inch	f inch	
-M40 ▲ Stable geometry ▲ Medium feed rates ▲ Can be used for any application ▲ Good chip control	 M	CTCP125	CTCP125		 8,60° 0.004	VN..	
		CTCP125	CTCP125				
					0.020-0.118	0.020-0.118	
-M50 ▲ Medium machining ▲ First choice for steel machining ▲ Universal application ▲ Wide range of applications	 M	CTCP115 / CTCP125 / CTCK110 / CTCK120	CTCP115 / CTCP125	CTCP125 / CTCP135	 20° 0.010	CN.. DN.. SN.. TN.. VN.. WN..	
		CTCP115	CTCP125	CTCP135			
		CTCP115 / CTCP125 / CTCK110 / CTCK120	CTCP115 / CTCP125 / CTCK110 / CTCK120	CTCP125 / CTCK120			
					0.020-0.197	0.005-0.016	
-TMQ ▲ Wiper geometry ▲ Light to medium rough machining ▲ Very high feedrate ▲ High surface quality	 M	CTCP115	CTCP125		 20° 0.011	CN.. DN.. WN..	
		CTCP125	CTCP125				
		CTCP125	CTCP125				
					0.031-0.236	0.008-0.033	
-MRS ▲ medium to rough machining ▲ well suited for components with cast crust or forged skin ▲ works well with interrupted cuts	 M R	CT-P15 / CT-P25 / CT-P35	CT-P15 / CT-P25 / CT-P35	CT-P25 / CT-P35	 20° 0.008	CN.. DN.. WN..	
		CT-P15 / CT-P25	CT-P25 / CT-P35	CT-P35			
					0.020-0.177	0.008-0.024	
-M70 ▲ Light to medium rough machining ▲ Cast crust and forging skin ▲ Stable cutting edge ▲ Interrupted cut ▲ Raw materials and forgings	 M R	CTCK110 / CTCK120 / CTCP115	CTCP115 / CTCP125	CTCP125 / CTCP135	 15,7° 0.012	CN.. DN.. SN.. TN.. WN..	
		CTCP115	CTCP125	CTCP135			
		CTCK110 / CTCK120 / CTCP115 / CTCP125	CTCK120 / CTCP125	CTCP125 / CTCK120			
					0.059-0.177	0.008-0.031	
.NMA ▲ Rough machining ▲ Stable cutting edge ▲ For short-chipping materials ▲ First choice for grey cast iron	 R				 0°	CN.. DN.. SN.. TN.. WN..	
		CTCK110	CTCK110 / CTCK120	CTCK120			
					0.059-0.177	0.008-0.031	
-R28 ▲ Single sided roughing geometry ▲ Longitudinal, face and copy turning ▲ Varying depths of cut ▲ Steels with low tensile strength (800 N / mm ²) ▲ Good chip control	 R	CTCP115 / CTCP125	CTCP115 / CTCP135 / CTCP125	CTCP135	 20° 0.014	CN.. DN.. SN..	
		CTCP115 / CTCP125	CTCP125 / CTCP135	CTCP135			
		CTCP115	CTCP125	CTCP135			
					0.039-0.472	0.010-0.031	

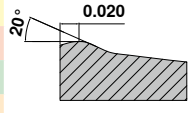

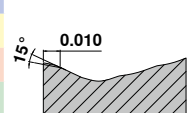

Main application steel and cast iron, secondary application stainless steels

Standard chip breakers / application notes







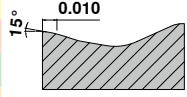

Negative		Model	Smooth cut	Irregular cutting depth	Interrupted cut	Sectional illustration		Geometry	
						a _p inch	f inch		
Main application steel and cast iron, secondary application stainless steels	-R58	 R	CTCP115 / CTCP125	CTCP115 / CTCP135 / CTCP125	CTCP135		0.059-0.472	0.012-0.047	CN.. DN.. SN.. TN..
	▲ Single sided roughing geometry		CTCP115 / CTCP125	CTCP125 / CTCP135	CTCP135				
	▲ Longitudinal and face turning		CTCP115	CTCP115 / CTCP125	CTCP125				
	▲ Light interrupted cut								
	▲ Low cutting forces								
	▲ Unstable machines								
Main application stainless steel and cast iron, secondary application stainless steels	-R88	 R	CTCP115 / CTCP125	CTCP115 / CTCP125 / CTCP135	CTCP135		0.138-0.630	0.020-0.059	SN..
	▲ Single sided roughing geometry		CTCP115 / CTCP125	CTCP115 / CTCP125	CTCP135				
	▲ Longitudinal and face turning		CTCP115	CTCP115 / CTCP125	CTCP125				
	▲ High feedrate								
	▲ Large depths of cut								
	▲ Heavily interrupted cut								

Negative		Model	Smooth cut	Irregular cutting depth	Interrupted cut	Sectional illustration		Geometry	
						a _p inch	f inch		
Main application stainless steels, secondary application steel and super alloys	-F30	 F	CTCM120 / CTPM125	CTCM120 / CTPM125 / CTCM130	CTCM130		0.003-0.098	0.004-0.014	CN.. DN.. SN.. TN.. VN.. WN..
	▲ Finishing of stainless steels		CTCM120 / CTPM125	CTCM120 / CTPM125 / CTCM130	CTCM130				
	▲ Continuous cut								
	▲ High surface quality								
	▲ Good swarf control								
Main application stainless steels, secondary application steel and super alloys	-M30	 F M	CTCM120 / CTPM125	CTCM120 / CTPM125 / CTCM130	CTCM130		0.039-0.177	0.006-0.016	CN.. DN.. SN.. TN.. VN.. WN..
	▲ Option for stainless steel machining		CTCM120 / CTPM125	CTCM120 / CTPM125 / CTCM130	CTCM130				
	▲ Good swarf control								
	▲ Little edge build up								
	▲ Low cutting forces								
	▲ Little built-up edge								
	▲ Applicable on unstable machines								
Main application stainless steels, secondary application steel and super alloys	-M60	 M R	CTCM120 / CTPM125	CTCM120 / CTPM125 / CTCM130	CTCM130		0.059-0.236	0.010-0.020	CN.. DN.. SN.. TN.. WN..
	▲ Light to medium roughing		CTCM120 / CTPM125	CTCM120 / CTPM125 / CTCM130	CTCM130				
	▲ Stable cutting edge								
	▲ Interrupted cut								
	▲ Forged skin and cast crust								



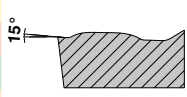

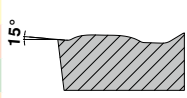

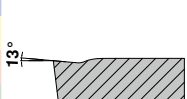



Standard chip breakers / application notes

	Negative	Model	Smooth cut	Irregular cutting depth	Interrupted cut	Sectional illustration		Geometry
						a_p inch	f inch	
Main application super alloys, secondary application stainless steels	-M34	 M	CTPX710	CTPX710		 15° 0.010	CN.. DN.. SN.. VN.. WN..	
	<ul style="list-style-type: none"> ▲ First choice for superalloys ▲ Light cutting geometry ▲ Little built-up edge ▲ Low cutting forces 		CTPX710	CTPX710				
			CTPX710	CTPX710				
			CTPX710	CTPX710				
								0.031-0.118

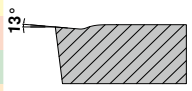

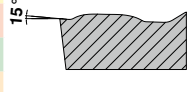
4

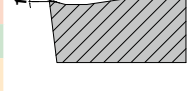
	Positive	Model	Smooth cut	Irregular cutting depth	Interrupted cut	Sectional illustration		Geometry
						a_p inch	f inch	
Main application steel and cast iron, secondary application stainless steels and super alloys	-CF05	 F	CTEP110 / TCM407	TCM10 / TCM407		 15°	CC.. DC.. SC.. TC.. VC..	
	<ul style="list-style-type: none"> ▲ Fine finishing ▲ For all common steel materials, stainless steels and GGG ▲ Good swarf control ▲ High surface quality 		CTEP110					
			CTEP110	TCM10 / TCM407				0.008-0.051
		-SF	 F	CTCP115	CTCP125	CTCP125 / CTCP135	 15°	CC.. DC.. SC.. TC.. VC.. WC..
	<ul style="list-style-type: none"> ▲ Finishing / contour turning ▲ Good swarf control ▲ High surface quality ▲ Low cutting forces 			CTCP125	CTCP125			
		-CF55	 F M	CTEP110	TCM10 / CTEP110		 13°	CC.. DC.. SC.. TC.. VC..
	<ul style="list-style-type: none"> ▲ Finishing to medium machining ▲ Suitable for general and stainless steels ▲ Low cutting forces ▲ Good swarf control ▲ High surface quality 	CTEP110		CTEP110				
		CTEP110		CTEP110		0.008-0.051		

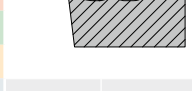
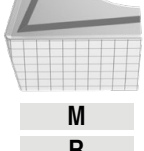
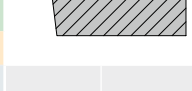

Standard chip breakers / application notes

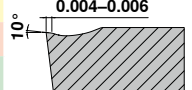
	Positive	Model	Smooth cut	Irregular cutting depth	Interrupted cut	Sectional illustration		Geometry	
						a_p inch	f inch		
Main application steel and cast iron, secondary application stainless steels and super alloys	-SMF	 F M	CTEP110 / CTCP115	TCM10 / CTCP125 / CTCP115	CTCP135		0.008-0.051	0.002-0.010	CC.. DC.. SC.. TC.. VC..
	<ul style="list-style-type: none"> ▲ Finishing to medium machining ▲ Low cutting forces ▲ Good swarf control ▲ High surface quality 		CTEP110	CTCP135	CTCP135				
	-FMS	 F M	CT-P15 / CT-P25	CT-P15 / CT-P25	CT-P25		0.004-0.079	0.002-0.008	CC.. DC.. VC..
	<ul style="list-style-type: none"> ▲ Finishing to medium machining ▲ very good chip control ▲ universal chip breaker ▲ low cutting forces 		CT-P15 / CT-P25	CT-P15 / CT-P25	CT-P25				
	-SM	 M	CTCP115 / CTCP125	CTCP125 / CTCP135 / CTCP115	CTCP125 / CTCP135		0.002-0.197	0.006-0.018	CC.. DC.. SC.. TC.. VC..
	<ul style="list-style-type: none"> ▲ Medium machining ▲ Universal application ▲ Stable cutting edge ▲ Varying depths of cut ▲ Wide range of applications 		CTCP115 / CTCK110 / CTCK120	CTCP125 / CTCK110 / CTCK120	CTCK120				
-SMQ	 M	CTCP115	CTCP125	CTCP125		0.039-0.157	0.006-0.018	CC.. DC..	
<ul style="list-style-type: none"> ▲ Positive wiper geometry ▲ Finishing to medium machining ▲ Very high feedrate ▲ High surface quality 		CTCP125 / CTCP115	CTCP125	CTCP125					
-MRS	 M R	CT-P15 / CT-P25	CT-P15 / CT-P25	CT-P25		0.006-0.138	0.006-0.014	CC.. DC.. VC..	
<ul style="list-style-type: none"> ▲ light to medium roughing ▲ universal chip breaker ▲ stable cutting edge 		CT-P15 / CT-P25	CT-P15 / CT-P25	CT-P25					

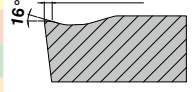
Positive

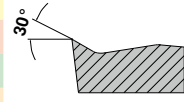
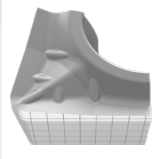
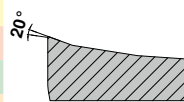
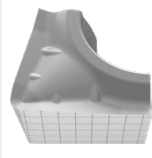
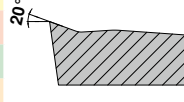

-M25	 F M	CTCM120 / CTPM125	CTCM120 / CTPM125 / CTCM130	CTCM130		0.016-0.126	0.004-0.012	CC.. DC.. TC.. VC..
		CTCM120 / CTPM125	CTCM120 / CTPM125 / CTCM130	CTCM130				
-M55	 M	CTCM120 / CTPM125	CTCM120 / CTPM125 / CTCM130	CTCM130		0.016-0.189	0.002-0.014	CC.. DC.. SC.. TC.. VC..
		CTCM120 / CTPM125	CTCM120 / CTPM125 / CTCM130	CTCM130				

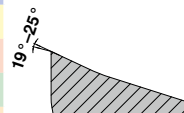
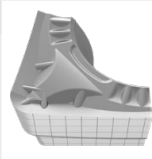
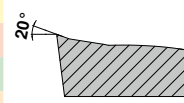
Standard chip breakers / application notes



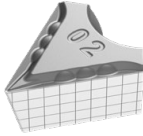
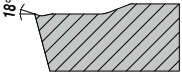

Positive	Model	Smooth cut	Irregular cutting depth	Interrupted cut	Sectional illustration		Geometry
					a_p inch	f inch	
-23P ▲ Low adhesion ▲ Good chip control with soft aluminium alloys	 F					0.008-0.157 0.002-0.012	CC.. DC..
		H216T	H216T	H216T			
		H216T	H216T	H216T			
		H216T	H216T	H216T			
		H216T	H216T	H216T			
-25P ▲ Sharp cutting edge ▲ Good swarf control on soft aluminium alloys ▲ Low adhesion	 F M	CTPX710	CTPX710			0.020-0.177 0.002-0.024	CC.. DC.. SC.. VC..
		CTPX710	CTPX710				
		CTPX710 / H216T	CTPX710 / H216T	CTPX710 / H216T			
		CTPX710	CTPX710				
		CTPX710	CTPX710				
-25Q ▲ Wiper geometry ▲ High feed rates ▲ High surface quality ▲ Good swarf control on soft aluminium alloys ▲ Low adhesion	 M	CTPX710	CTPX710			0.002-0.256 0.002-0.024	CC.. DC.. VC..
		CTPX710	CTPX710				
		H210T	H210T				
		H210T / CTPX710	H210T / CTPX710	H210T / CTPX710			
		H210T / CTPX710	H210T / CTPX710				
-27 ▲ The universal Alu geometry ▲ Sharp cutting edge ▲ Extremely positive rake angle ▲ Low adhesion ▲ High feed rates	 M R	CTPX715	CTPX715			0.039-0.394 0.004-0.030	CC.. DC.. RC.. SC.. TC.. VC..
		CTPX715	CTPX715				
		CTPX715 / H216T	CTPX715 / H216T				
		CTPX715 / H216T	CTPX715 / H216T	CTPX715 / H216T			
		CTPX715	CTPX715				
-29 ▲ Direct sintered aluminium geometry ▲ Positive rake angle ▲ Good chip control ▲ For medium to rough machining	 F R					0.039-0.236 0.010-0.024	CC.. DC.. VC..
		H216	H216	H216T			
		H216	H216	H216T			

Main application non-ferrous metals, secondary application stainless steels, steels, super alloys, cast iron

Standard chip breakers / application notes

Positive	Model	Smooth cut	Irregular cutting depth	Interrupted cut	Sectional illustration		Geometry
					a _p inch	f inch	
Main application super alloys and stainless steels, secondary application steels and non-ferrous metals -F05 ▲ Maximum tolerance class ▲ Outstanding chip control, even with the smallest cutting depths ▲ Very low cutting forces	 F	CTPX710	CTPX710			DC.. VC..	
		CTPX710	CTPX710				
		CTPX710	CTPX710				
		CTPX710	CTPX710				
		CTPX710	CTPX710				
		CTPX710	CTPX710				
					0.004-0.098	0.001-0.010	

Supplementary chip breakers / application notes

	Model	Smooth cut 	Irregular cutting depth 	Interrupted cut 
<p>-EN</p> <p>▲ Universal chip breaker for general steels</p>  <p>M</p>		CTCP115	CTCP125	CTCP135
		CTCP125	CTCP135	CTCP135
		CTCK110	CTCK120	CTCP125
<p>-ER EL</p> <p>▲ A problem solver for unstable conditions</p> <p>▲ Can be used on less powerful machines</p> <p>▲ Can be used for general steels and on stainless materials as a secondary application</p>  <p>M</p>			CTCP125	CTCP135

Masterfinish – wiper geometry – notes

Through the use of indexable inserts with wiper edge (-TFQ; -TMQ; -SMQ; -25Q) high quality surfaces can be produced economically.

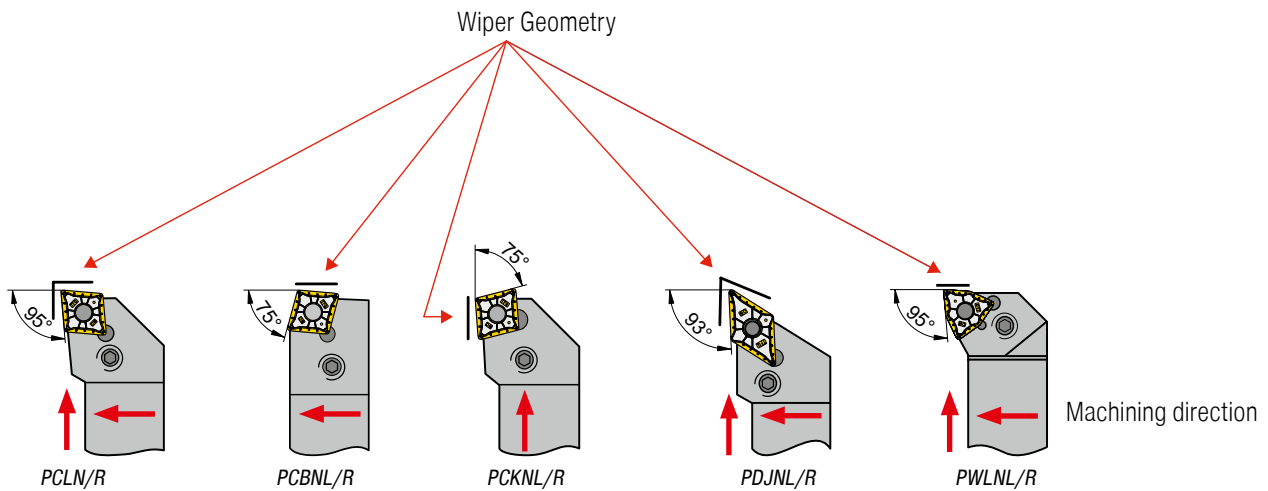

All turning inserts with wiper cutting edge are clamped in standard ISO tool holders.

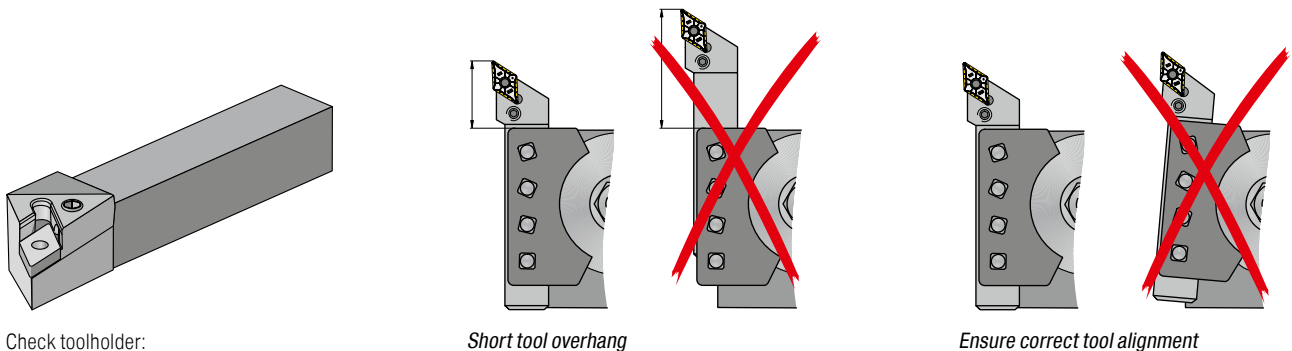

Check toolholder:

- ▲ Insert seat
- ▲ Shim
- ▲ Clamping Lever

Feed rate guide values for surface finish quality

Roughness range R_z in μm	$R_{t\text{max}}$	Corresponds to R_a	Roughness index	ISO 1302	Corner radius r_e in inch and feed rate f in inch/rev.			
					$r_e = 0.016$	$r_e = 0.032$	$r_e = 0.048$	$r_e = 0.064$
63-100	$\sqrt{R_t 100}$	12.5-25	N11	$\frac{25}{\nabla}$		0.020	0.027	0.035
40-63	$\sqrt{R_t 63}$	6.3-25	N10	$\frac{12.5}{\nabla}$	0.011	0.017	0.022	0.027
31.5-40	$\sqrt{R_t 40}$	4.9-6.3	N9	$\frac{6.3}{\nabla}$	0.010	0.015	0.019	0.022
25-31.5	$\sqrt{R_t 31.5}$	4.0-4.9			0.009	0.013	0.016	0.019
16-25	$\sqrt{R_t 25}$	2.5-4.0	N8	$\frac{3.2}{\nabla}$	0.008	0.011	0.014	0.015
10-16	$\sqrt{R_t 16}$	1.6-2.5			0.006	0.009	0.011	0.012
6.3-10	$\sqrt{R_t 10}$	1.0-1.6	N7	$\frac{1.6}{\nabla}$	0.004	0.005	0.007	0.008

Masterfinish – wiper geometry – functional principle

Relationship of feed rate to surface roughness

Improved Surface Quality

With the same feed rate an insert with wiper cutting edge reaches a roughness value R_t which is many times better than a conventional insert.



Shorter machining time

To achieve the same R_t -value as with a standard insert, double the feed rate can be applied for the insert with wiper cutting edge (= shorter production time per component!)



4

Theoretical Surface Quality

The maximum theoretical surface roughness with turning $R_{t,theor.}$ is the combination of feed rate and corner radius:

or approximately:

$$R_{t,theor.} = \left(r_\epsilon - \sqrt{r_\epsilon^2 - \frac{f^2}{4}} \right) \cdot 1000$$

$$R_{t,theor.} = \frac{125 \cdot f^2}{r_\epsilon} \text{ [}\mu\text{m]}$$

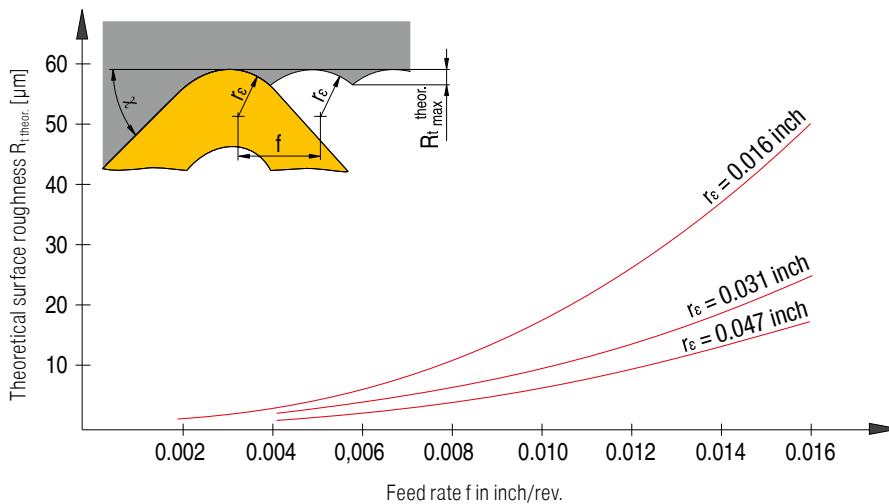

ISO designation system for inserts

Indexable inserts – inch

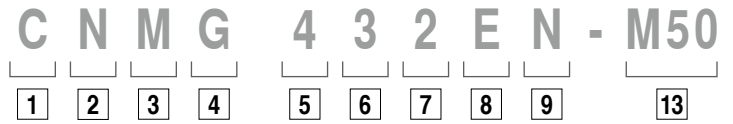

Indexable inserts – metric

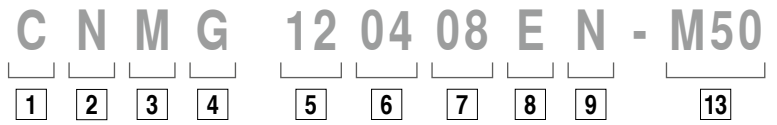

Indexable inserts, CBN, ceramic – inch

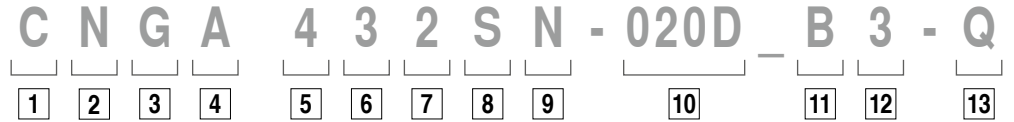

Indexable inserts, CBN, ceramic – metric

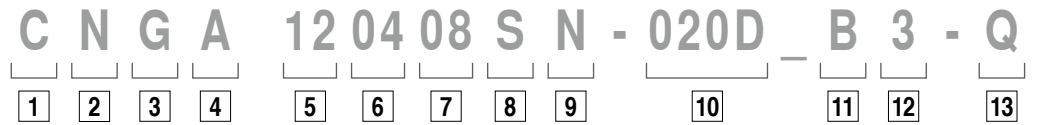

1

Insert shape

V	35°	Included angle
D	55°	
E	75°	
C	80°	Included angle
M	86°	
K	55°	Included angle
B	82°	
A	85°	Other shapes
L	90°	
P	108°	
H	120°	
O	135°	
R	-	
S	90°	
T	60°	
W	80°	

2

Clearance angle

α	α
A 3°	F 25°
B 5°	G 30°
C 7°	N 0°
D 15°	P 11°
E 20°	

O Clearance angles not included within the standard for which particular information is necessary.

3

Tolerances

	IC±		BS		S	
	mm	inch	mm	inch	mm	inch
A	0,025	0.0010	0,005	0.0002	0,025	0.001
F	0,013	0.0005	0,005	0.0002	0,025	0.001
C	0,025	0.0010	0,013	0.0005	0,025	0.001
H	0,013	0.0005	0,013	0.0005	0,025	0.001
E	0,025	0.0010	0,025	0.0010	0,025	0.001
G	0,025	0.0010	0,025	0.0010	0,13	0.005
J	0,05-0,15*	0.002-0.006*	0,005	0.0002	0,025	0.001
K	0,05-0,15*	0.002-0.006*	0,013	0.0005	0,025	0.001
L	0,05-0,15*	0.002-0.006*	0,025	0.0010	0,025	0.001
M	0,05-0,15*	0.002-0.006*	0,05-0,20*	0.003-0.008*	0,13	0.005
N	0,05-0,15*	0.002-0.006*	0,05-0,20*	0.003-0.008*	0,025	0.001
U	0,08-0,25*	0.003-0.010*	0,13-0,38*	0.005-0.015*	0,13	0.005

* Depends on insert size

6

Insert thickness

mm		inch		Code	
1,59	1/16	01	1		
2,38	3/32	02			
3,18	1/8	03	2		
3,97	5/32	T3			
4,76	3/16	04	3		
5,56	7/32	05			
6,35	1/4	06	4		
7,94	5/16	07	5		
9,52	3/8	09	6		

7

Corner radius

mm		inch		Code		RN 00 RC MO
≤ 0,05	0.0015	00	X0			
0,1	0.004	01	0			
0,2	0.008	02	.5			
0,4	1/64	04	1			
0,8	1/32	08	2			
1,2	3/64	12	3			
1,6	1/16	16	4			
2,0	5/64	20	5			
2,4	3/32	24	6			
2,8	7/64	28	7			
3,2	1/8	32	8			

8

Cutting edge

F	Sharp
E	rounded
T	chamfered
S	Chamfered and honed
K	Double-chamfered
P	Double-chamfered and honed
R	Round chamfer

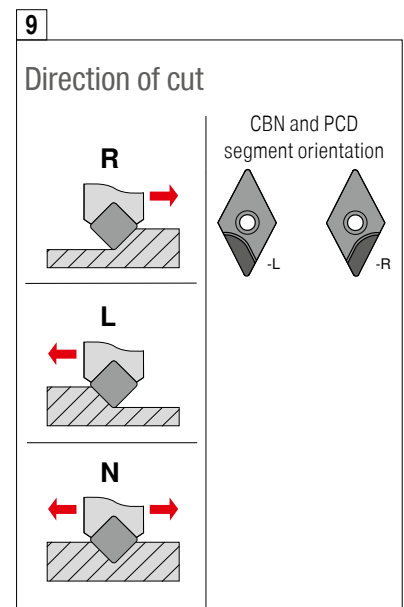



4

Characteristics

N		
R		
F		
A		
M, P		
G, P		
W		
T		
Q		
U		
B		
H		
C		
J		
X	Special version	

inch
Change at inscribed circle
IK < 1/4"

IK > 1/4"	IK < 1/4"
N / R / F	E
A / M / G	D
X	X

5

Cutting length

Type	ISO	ANSI	L		d	
			mm	inch	mm	inch
	06	2	6,4	0.250	6,35	0.250
	09	3	9,7	0.382	9,525	0.375
	12	4	12,9	0.508	12,70	0.500
	16	5	16,1	0.634	15,875	0.625
	19	6	19,3	0.760	19,05	0.750
	25	8	25,8	1.016	25,4	1.000
	06	2	6,35	0.250	6,35	0.250
	09	3	9,525	0.375	9,525	0.375
	12	4	12,7	0.500	12,7	0.500
	15	5	15,875	0.625	15,875	0.625
	19	6	19,05	0.750	19,05	0.750
	25	8	25,4	1.000	25,4	1.000
	07	2	7,7	0.303	6,35	0.250
	11	3	11,6	0.457	9,525	0.375
	15	4	15,5	0.610	12,70	0.500
	11	2	11,1	0.437	6,35	0.250
	16	3	16,6	0.653	9,525	0.375
	22	4	22,10	0.870	12,70	0.500

Type	ISO	ANSI	L		d		
			mm	inch	mm	inch	
	06	1.2	6,9	0.272	3,97	0.156	
	09	1.8	9,6	0.378	5,56	0.219	
	11	2	11,0	0.433	6,35	0.250	
	16	3	16,5	0.650	9,525	0.375	
	22	4	22,	0.079	12,70	0.039	
	27	5	27,5	1.083	15,875	0.625	
	33	6	33,0	1.299	19,05	0.750	
		06	3	6,5	0.256	9,525	0.375
		08	4	8,7	0.331	12,70	0.039
		10	5	10,9	0.429	15,875	0.625
		06	2	6,35	0.250	6,35	0.250
		08	-	8,0	0.315	8,0	0.315
09		3	9,52	0.375	9,52	0.375	
10		-	10,0	0.394	10,0	0.394	
12*		-	12,0	0.472	12,0	0.472	
12		4	12,7	0.488	12,70	0.488	
15		5	15,875	0.625	15,875	0.625	
16		-	16,0	0.630	16,0	0.630	
19		6	19,05	0.750	19,05	0.750	
25		8	25,0	0.984	25,0	0.984	
25*		-	25,4	1.000	25,4	1.000	
31		10	31,75	1.250	31,75	1.250	
32	-	32,0	1.260	32,0	1.260		

* inch version

4

10

Chamfer type

T/S **K/P¹⁾**

	mm	inch		
015	0,15	0.006	A	05°
020	0,20	0.008	B	10°
025	0,25	0.010	C	15°
050	0,50	0.020	D	20°
075	0,75	0.030	E	25°
100	1,00	0.040	F	30°
			G	35°

1) Two letters are assigned for double-chamfered cutting edges
e.g. BE =
chamfer angle 1 (y₁) = 10°
chamfer angle 2 (y₂) = 25°

11

Number of cutting edges

Single sided		Complete insert thickness	
A		T	
B		U	
C		V	
D		W	
G		X	
H		Y	
Double sided		Entire clamping flat	
K		S	
L		F	
M		E	
N			
P			
Q			

12

Segment length

Approx. specification in mm

13

Grade description

ISO designation system for tool holders

M C L N R 20 20 K 12 - T
 1 2 3 4 5 6 7 8 9 10

HSK-T63 - D C L N R -12
 0 1 2 3 4 5 6 7 8 9 10

0

System/size
HSK-T
 according to ISO 12164
 HSK-T63 = 63 mm
 HSK-T100 = 100 mm

1

Tool holder

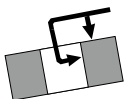
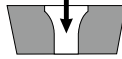
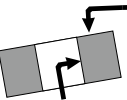
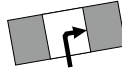
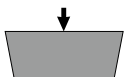
D  Retained from above and via bore	S  Retained via centre screw
M  Retained from above and via bore	P  Retained via the bore
C  Retained from above	X Special version

2

Insert shape

V 35°	Included angle
D 55°	
E 75°	Included angle
C 80°	
M 86°	Included angle
K 55°	
B 82°	Included angle
A 85°	
L 90°	Other shapes
P 108°	
H 120°	
O 135°	
R -	
S 90°	
T 60°	
W 80°	

6

Shank height

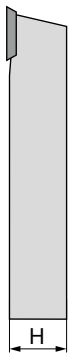

7

Shank width



8

Tool length

OAL			OAL		
mm	inch		mm	inch	
32	4.000	A	160	4.500	N
40	4.500	B	170	5.500	P
50	5.000	C	180	-	Q
60	6.000	D	200	6.000	R
70	7.000	E	250	7.000	S
80	8.000	F	300	8.000	T
90	5.500	G	350	5.500	U
100	5.625	H	400	3.500	V
110	5.300	J	450	3.500	W
125	14.000	K	500	3.750	Y
140	6.800	L	Special version		X
150	4.400	M			





3

Style

4

Clearance angle

α		α	
A	3°	F	25°
B	5°	G	30°
C	7°	N	0°
D	15°	P	11°
E	20°		

O Clearance angles not included within the standard for which particular information is necessary.

5

Direction of cut

4

9

Cutting length

10

Manufacturer specification

T = Toggle
 Special length (mm)
 Insert thickness (deviating from standard)
 Special version (X...)
 Machine manufacturer (specific)

ISO designation system for boring bars

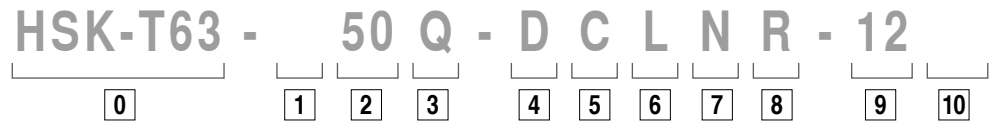
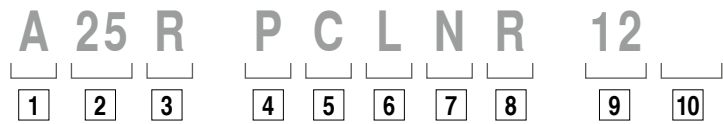

0

System/size

HSK-T
according to ISO 12164
HSK-T63 = 63 mm
HSK-T100 = 100 mm



1

Shank type

S Steel shank	E As C with coolant hole
A Steel shank with coolant hole	F As C with antivibration system
B Steel shank with antivibration system	G As C with coolant hole and antivibration system
D Steel shank with coolant hole and antivibration system	H Heavy metal
C Carbide shank with steel head	J Heavy metal with coolant hole

5

Insert shape

V 35°	Included angle
D 55°	
E 75°	
C 80°	
M 86°	
K 55°	Included angle
B 82°	
A 85°	
L 90°	Other shapes
P 108°	
H 120°	
O 135°	
R -	
S 90°	
T 60°	
W 80°	

6

Style

*) CERATIZIT factory standard

7

Clearance angle

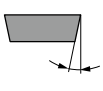

A 3°	F 25°
B 5°	G 30°
C 7°	N 0°
D 15°	P 11°
E 20°	

O Clearance angles not included within the standard for which particular information is necessary.



2

Shank type & size

DCONMS mm	DCONMS inch
08	
10	
12	
16	
20	
25	
32	
40	
50	
60	

A two-digit figure indicating the boring bar diameter in 1/16 of an inch.

3

Tool length

OAL		
mm	inch	
80	3	F
100	3.5	H
110	4	J
125	4.5	K
140	5	L
150	5.5	M
160	6	N
170	6.5	P
180	6.75	Q
200	7	R
250	8	S
300	10	T
350	12	U
400	14	V
450	16	W
500	18	Y
	20	
Special version		X

4

Clamping method

<p>D</p> <p>Retained from above and via bore</p>	<p>S</p> <p>Retained via centre screw</p>
<p>M</p> <p>Retained from above and via bore</p>	<p>P</p> <p>Retained via the bore</p>
<p>C</p> <p>Retained from above</p>	<p>X</p> <p>Special version</p>

4

8

Direction of cut

R

L

9

Cutting length

10

Manufacturer specification

T = Toggle
 Special length (mm)
 Insert thickness (deviating from standard)
 Special version (X..)
 Machine manufacturer (specific)

Types of wear

Wear on clearance face



Abrasion on flank: normal wear after a certain machining time

Cause

- ▲ Too high cutting speed
- ▲ Carbide grade with too low wear resistance
- ▲ Feed rate not adapted

Remedy

- ▲ Reduce cutting speed
- ▲ Use grade with higher wear resistance
- ▲ Adapt feed rate to cutting speed and cutting depth

Edge chipping

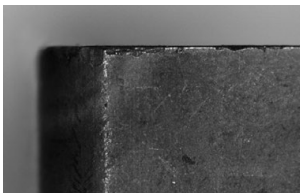

Through excessive mechanical stress at the cutting edge fracture and chipping can occur.

Cause

- ▲ Grade with too high wear resistance
- ▲ Vibration
- ▲ Too high cutting speed and / or feed rate
- ▲ Interrupted cut
- ▲ Swarf damage

Remedy

- ▲ Use tougher grade
- ▲ Use negative cutting edge geometry with chip groove
- ▲ Improve stability (tool, work piece)

Cratering



The hot chip which is being evacuated causes cratering at the rake face of the cutting edge.

Cause

- ▲ Too high cutting speed and / or feed rate
- ▲ Rake angle too shallow
- ▲ Grade with insufficient wear resistance
- ▲ Insufficient coolant supply

Remedy

- ▲ Reduce cutting speed and / or feed rate
- ▲ Use grade with higher wear resistance
- ▲ Increase coolant quantity and / or pressure, optimise coolant supply
- ▲ Use grade which is more resistant to cratering

Plastic deformation

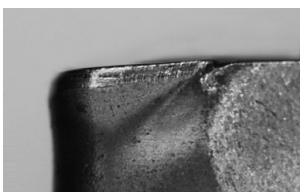

High machining temperature and simultaneous mechanical stress can lead to plastic deformation.

Cause

- ▲ Too high machining temperature resulting in softening of substrate
- ▲ Damage of coating
- ▲ Grade with insufficient wear resistance
- ▲ Insufficient coolant supply

Remedy

- ▲ Reduce cutting speed
- ▲ Use grade with higher wear resistance
- ▲ Provide cooling

Built-up edge

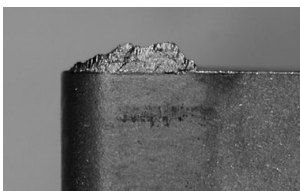

Built-up material / edges occur when the chip is not evacuated properly due to insufficient cutting temperature.

Cause

- ▲ Insufficient cutting speed
- ▲ Rake angle too shallow
- ▲ Wrong cutting material
- ▲ Lack of cooling / lubrication

Remedy

- ▲ Increase cutting speed
- ▲ Increase rake angle
- ▲ Apply TiN coating
- ▲ Use emulsion with higher concentration

Insert breakage

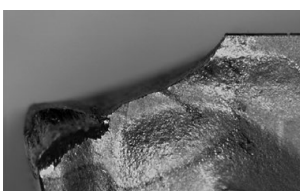

Excessive stress of the insert causes breakage.

Cause

- ▲ Excessive stress of cutting material
- ▲ Lack of stability
- ▲ Clearance angle too small

Remedy

- ▲ Use tougher grade
- ▲ Use protective edge chamfer
- ▲ Increase edge hone
- ▲ Use geometry with higher stability

Recommendation for Optimum Results

Type of problem																		
Type of wear						Work piece problems				Swarf control								
Wear on clearance face	Cratering	Edge chipping	Plastic deformation	Insert breakage	Built-up edge	Vibration	Formation of pits and burrs	Chattered surface	Surface quality	Chip too long (snarl chip)	Chip too short (fragmented chip)							
↓	↓		↓		↓	↓			↑	↓		Cutting speed		Cutting data	Remedy measures			
~		↓	↓	↓		↑		↓	↓	↑	↓	Feed rate						
↓	↓	↓	↓				↓	↓	↓			Feed rate at centre						
		↑	~		↓	~	↓	↓	↓	↓	↑	Chip groove		↑		↓	Insert selection	
↑		↑	↑	↑		↓	↓	↓	↑			Corner radius		↑		larger smaller		↓
↑	↑	↓	↑	↓								Tool Material		↑		Wear resistance toughness		↓
		~		~		~		~	~			Tool clamping		General criteria				
		~		~		~		~	~			Work piece clamping						
		~		~		~			↓			Overhang						
~		~				~	~		~			Tip height						
●	~		●		●		●		●	●		Cooling lubricant						

raise, increase large influence
 raise, increase small influence

avoid, reduce large influence
 avoid, reduce small influence

check, optimise
 use

Grades Overview

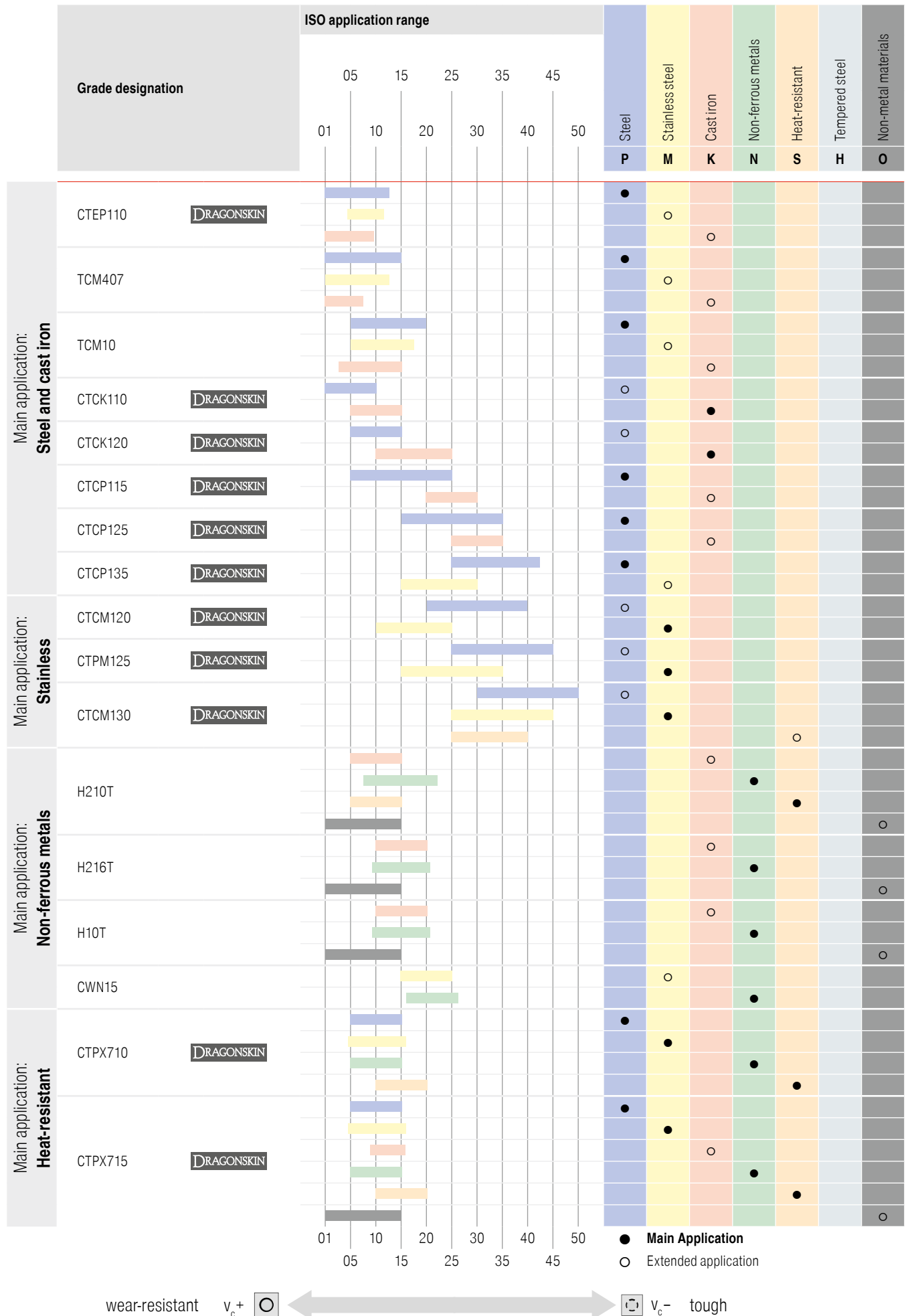

Grade description

TCM407	<ul style="list-style-type: none"> ▲ Cermet, uncoated ▲ ISO P10 M05 K05 ▲ The uncoated cermet grade for super-fine finishing steel materials 	CTPM125	<ul style="list-style-type: none"> ▲ ISO P35 M25 ▲ The universal carbide grade with maximum toughness, without affecting the necessary hot hardness and wear resistance for stainless machining
CTEP110	<ul style="list-style-type: none"> ▲ Cermet, TiCN-Al₂O₃-coated ▲ ISO P10 M10 K05 ▲ The cermet grade with reserves of toughness for finish machining at high cutting speeds 	CTCK110	<ul style="list-style-type: none"> ▲ Carbide, TiCN-Al₂O₃-coated ▲ ISO P05 K10 ▲ The wear-resistant grade for machining cast iron materials at high cutting speeds in a continuous cut
TCM10	<ul style="list-style-type: none"> ▲ Cermet, uncoated ▲ ISO P15 M10 K10 ▲ The uncoated cermet grade for finish machining stainless and hardened steel ▲ Particularly wear resistant thanks to high heat resistance 	CTCK120	<ul style="list-style-type: none"> ▲ Carbide, TiCN-Al₂O₃-coated ▲ ISO P10 K20 ▲ The grade for cast iron machining, with high toughness reserves for difficult conditions and interrupted cuts
CTCP115	<ul style="list-style-type: none"> ▲ Carbide, TiCN-Al₂O₃-coated ▲ ISO P15 K25 ▲ The wear-resistant high-performance grade for stable conditions and a continuous cut 	H10T	<ul style="list-style-type: none"> ▲ Carbide, uncoated ▲ ISO K15 N15 O10 ▲ The uncoated carbide grade for machining aluminium and other non-ferrous metals
CTCP125	<ul style="list-style-type: none"> ▲ Carbide, TiCN-Al₂O₃-coated ▲ ISO P25 K30 ▲ The first choice for universal machining of steels 	H210T	<ul style="list-style-type: none"> ▲ Carbide, uncoated ▲ ISO N10 S10 K10 O10 ▲ The wear-resistant carbide grade for machining aluminium and other non-ferrous metals
CTCP135	<ul style="list-style-type: none"> ▲ Carbide, TiCN-Al₂O₃-coated ▲ ISO P35 M25 ▲ The tough alternative for heavily interrupted cut and unstable conditions 	H216T	<ul style="list-style-type: none"> ▲ Carbide, uncoated ▲ ISO K15 N15 O10 ▲ The uncoated carbide grade for machining aluminium and other non-ferrous metals ▲ Also highly suitable for HSC machining
CT-P15	<ul style="list-style-type: none"> ▲ Carbide, coated ▲ ISO P15 M10 ▲ Wear-resistant standard steel grade for smooth cut 	CWN15	<ul style="list-style-type: none"> ▲ Carbide, TiN-coated ▲ ISO M15 K15 ▲ Special carbide grade for abrasive aluminium alloys
CT-P25	<ul style="list-style-type: none"> ▲ Carbide, coated ▲ ISO P25 M20 ▲ Standard steel grade for universal steel machining 	CTPX710	<ul style="list-style-type: none"> ▲ Carbide, AlTiN-coated ▲ ISO P10 M10 K10 N10 S15 ▲ Universal multi-material grade from the X7 line for highest machining requirements
CT-P35	<ul style="list-style-type: none"> ▲ Carbide, coated ▲ ISO P35 M25 ▲ Tough standard steel grade for interrupted cutting 	CTPX715	<ul style="list-style-type: none"> ▲ Carbide, AlTiN-coated ▲ ISO P10 M10 K10 N10 S15 O10 ▲ Universal multi-material grade from the X7 line for highest machining requirements
CTCM120	<ul style="list-style-type: none"> ▲ Carbide, TiCN-Al₂O₃-coated ▲ ISO P15 M20 ▲ Wear-resistant turning grade for austenitic stainless steel; top performance for smooth cuts 		
CTCM130	<ul style="list-style-type: none"> ▲ Carbide, TiCN-Al₂O₃-coated ▲ ISO P25 M30 ▲ Robust turning grade for austenitic stainless steel with interrupted cuts 		

Grade description

C T C P 1 2 5 (Example)

Main application – material

1 P	Steel
2 M	Stainless steel
3 K	Cast iron
4 N	Light and non ferrous metals
5 S	Super alloys, titanium
6 H	Hard materials
7 X	Universal application

Application

1	Turning
2	Milling
3	Grooving
4	Drilling
5	Thread turning
6	Others
7	Several processes

Degree of hardness

05	ISO 05
10	ISO 10
15	ISO 15
	...





1 Indexable Drilling

Holemaking

2 Indexable Boring

3 Reaming

4 Indexable Turning

Turning

5 Parting and Grooving

5

6 Multifunction

Milling

7 Indexable Milling

8 Solid Milling

9 Material examples and
article no. index

Table of contents

Symbol explanation	2
Toolfinder – System Overview	3
Toolfinder – External Machining	4+5
Toolfinder – Internal Machining	6+7
Product program	8–75
Technical Information	
Cutting Data	76
Depths of Cut and Feedrates	78–83
TC – Reference values for profile depth and number of passes	84
Comparison threading system with TC and conventional	85
Grooving depth reduction	86+87
Clamping Methods	88+89
Torque Moment ModularClamp Module Screws	90
Advantages due to DirectCooling	91
Advantages of the trochoidal turning strategy	91
General references	92
Causes of Wear and Corrective Measures	93–95
Chip Breakers Overview	96–99
Example of Coding Grooving Tools	100
Grade overview and application	101+102

CERATIZIT \ Performance

Premium quality tools for high performance.

The premium quality tools from the **CERATIZIT Performance** product line have been designed for specific applications and are distinguished by their outstanding performance. If you make high demands on the performance of your production and want to achieve the very best results, we recommend the Premium tools in this product line.

Advantages of the DirectCooling blade

- ▲ The best machining results, even with reduced pump output
Highest flow volume of all thru coolant blades on the market
- ▲ User friendly
Reinforced blades without sealing screw
- ▲ Process-secure spare part for easy handling and a long service life
Single-piece sealing screw made from steel (for standard blades)

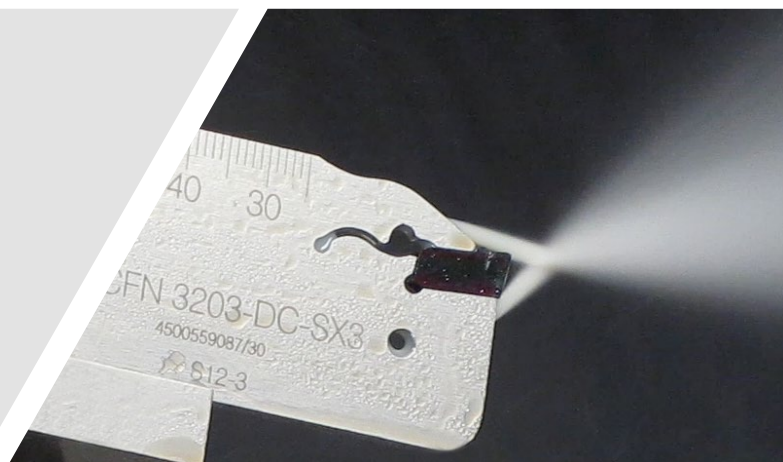

Symbol explanation

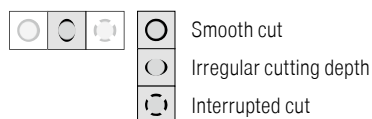
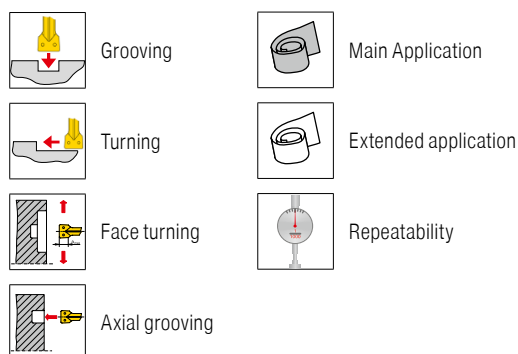

Additional metric items are available in our Online-Shop at cuttingtools.ceratizit.com and in the metric main catalog

Toolfinder – System Overview

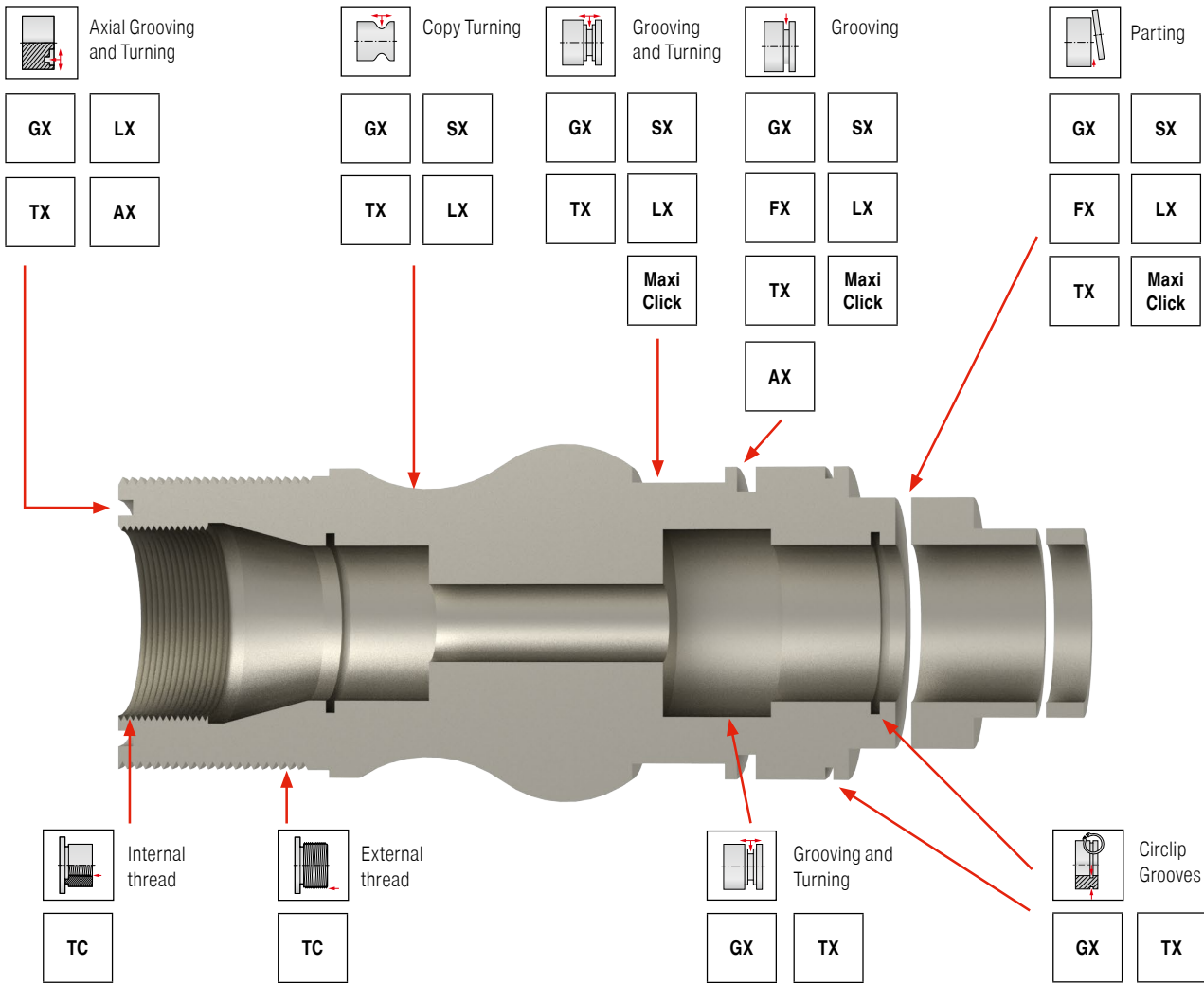

System Description

Page No.

SX	The single edged SX grooving system is even more versatile with the -M3 chip breaker. Besides grooving / parting with the -F2, -M2, or -27P chip breakers, the SX -M3 type also allows copying turning operations with the highest chip control. With this additional option, the SX grooving system can cover all areas of grooving making it a universal grooving tool. Available as a Modular or Mono system.	8
SX-DC	Our tried-and-tested single-edged SX grooving system is now available with targeted DirectCooling (DC) thru coolant supply. The coolant is guided through two coolant holes – one above and one below the grooving insert – straight to the point where it will be most effective: the cutting edge itself.	metric
FX	A single-edged grooving system with a variety of specialized chip geometries. From fine machining in unstable parts through to high-performance machining under stable conditions. Available as a Modular or Mono system.	20–27
GX	Double edged grooving system for grooving, parting off, turning and for producing circlip grooves. Available in sizes GX09, GX16 and GX24. Available as a Modular or Mono system.	28
TX	Three-edged system for parting, grooving, axial grooving, radial grooving, and fine turning. Positive ground cutting geometries, with a very soft cut with minimum cutting forces. Universally applicable for almost all materials. Available as a Monosystem.	metric
LX	Single edged system for extreme applications starting from a cutting width of 0.315 inch. The LX system is for use in stable conditions. Available as a Modular or Mono system	55–58
AX	Double-edged Axial grooving system for grooving and groove turning with high precision. Due to the three different depths (0.1969 inch, 0.3937 inch and 0.5906 inch) stable tools are available for each application.	59
TC	Double-edged thread turning system for the production of external and internal threads. Advantage is the use without pitch angle correction and in narrow or difficult areas of application. Available as a Modular or Mono system.	61
Maxi Click	Five-edged grooving system for grooving and parting	metric

Toolfinder – External Machining

ModularClamp

0° 69 45° 70 90° 71

GX 09 **GX 16** **GX 24**

- 36
- 37
- 36
- 37
- 49
- 51
- 52

Deep Radial Grooving,
Parting and Turning

Axial Grooving and Face
Turning

Deep Axial Grooving and
Face Turning

GX 09 **GX 16** **GX 24**

<p>Circlip grooves</p> 33	<p>Grooving and Turning</p> <p>-F2</p> 28
<p>Cutting width CW = 0.0197-0.1240 (H13)</p>	<p>Standard</p> 29
<p>Radius grooves</p> <p>Standard</p> 34	<p>-M40</p> 30
<p>Radius CRE = 0.0315-0.0472</p>	<p>Cutting width CW = 0.0787-0.1378</p>

<p>Circlip grooves</p> 33	<p>Grooving and Turning</p> <p>-F2</p> 28
<p>Cutting width CW = 0.0197-0.2028 (H13)</p>	<p>Standard</p> 29
<p>Radius grooves</p> <p>Standard</p> 34	<p>-M40</p> 30
<p>Radius CRE = 0.0315-0.1181</p>	<p>-M1</p> 31
<p>-27P</p> 35	<p>-27P</p> 32
<p>Radius CRE = 0.0315-0.1181</p>	<p>Cutting width CW = 0.0787-0.2362</p>

<p>Radial, axial and deep axial grooving and parting, face turning and turning</p> <p>-F2</p> 42	<p>-M3</p> 46
<p>-E</p> 43	<p>-27P</p> 48
<p>-M1</p> 44	<p>Radius CRE = 0.0591-0.1575</p>
<p>-M40</p> 45	
<p>-27P</p> 47	
<p>Cutting width CW = 0.0787-0.2362</p>	

MonoClamp

GX 09 **GX 16** **GX 24**

40 40 53

54

metric

metric



Additional metric items are available in our Online-Shop at cuttingtools.ceratizit.com and in the metric main catalog

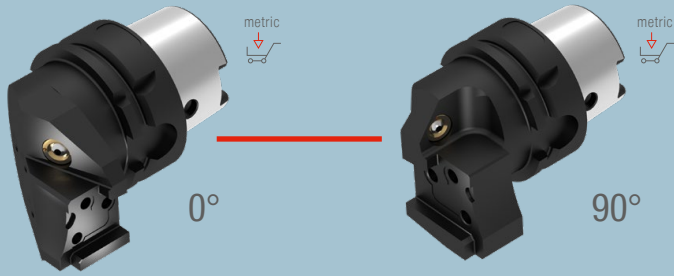

SX

FX

LX

TC

AX



SX

FX

LX

TC

AX

Parting, Grooving and Turning

-F2 8	-27P 11
Parting and Grooving	Grooving and copy turning
-M1 9	-M3 12
-M2 10	Radius CRE = 0.0591-0.1181
Cutting width CW = 0.0787-0.2362	

Parting and Grooving

-F1 20
-M1 21+22
-27P 23
-R2 24
Cutting width CW = 0.0866-0.3819

Deep Parting and Grooving

-M2 55
-M3 56
Cutting width CW = 0.3150-0.3937

Thread turning

Full profile
60° 61+62
55° 64
Partial profile
60° 63
55° 65

Axial Grooving and Turning

-F50 59
Groove width CW = 0.1181



TX

Maxi Click

Parting	-F2 0.1969
Circlip Grooves	-F2 0.3937
Corner undercut	-F3 0.3937
Fine and copy turning	Cutting width CW = 0.0394-0.0984
Axial grooving	

SX - SX-DC Direct Cooling

FX

LX

TC

AX

TX

Maxi Click

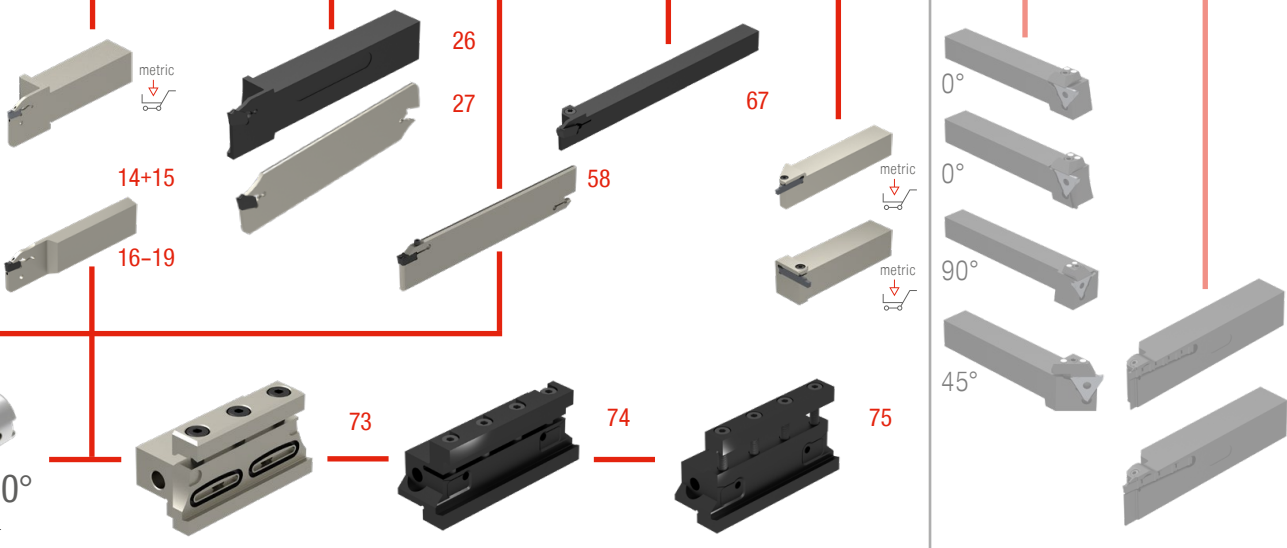

Toolfinder – Internal Machining

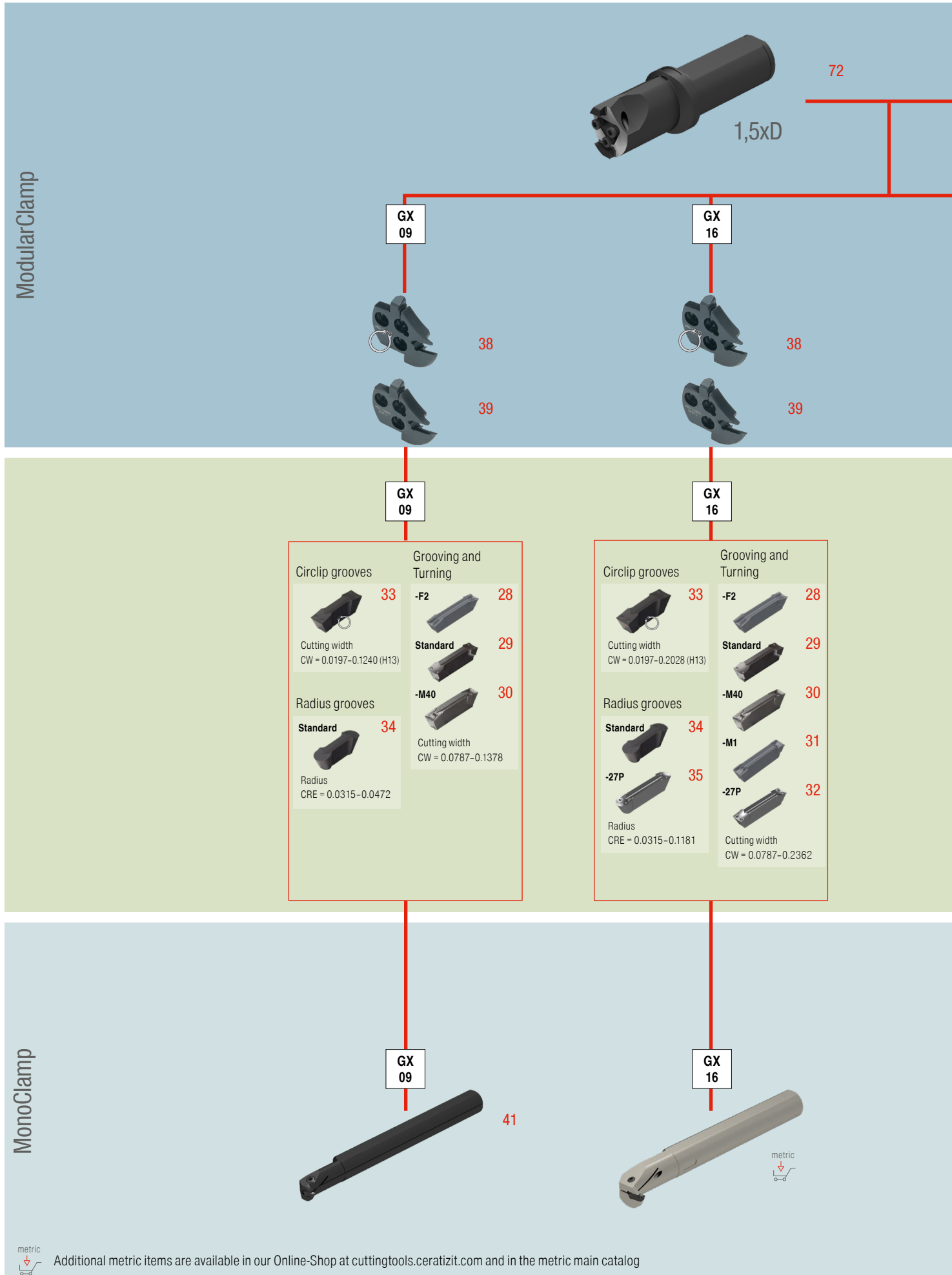

Additional metric items are available in our Online-Shop at cuttingtools.ceratizit.com and in the metric main catalog

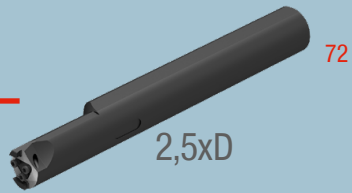

GX
24

TC

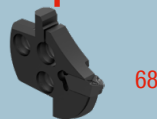

GX
24

TC







TX

Radial, axial and deep axial grooving and parting, face turning and turning

- | | | | |
|---|-----------|--|-----------|
|  -M1 | 44 |  -M3 | 46 |
|  -M40 | 45 |  -27PF | 48 |
|  -E | 43 | Radius
CRE = 0.0591-0.1575 | |
|  -F2 | 42 | | |
|  -27P | 47 | | |
| Cutting width
CW = 0.0787-0.2362 | | | |

Thread turning

- | | | |
|------------------------|---|-----------|
| Partial profile
60° |  | 63 |
| Full profile
60° |  | 62 |
| Full profile
55° |  | 64 |
| Partial profile
55° |  | 65 |

Parting

Circlip Grooving
Inserts

For corner relief

Fine and copy
turning

Axial grooving



GX
24

TC

TX

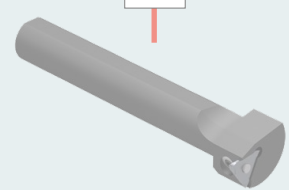
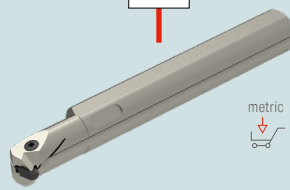
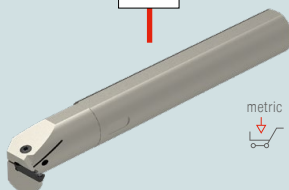

Insert SX

▲ High precision ground geometry

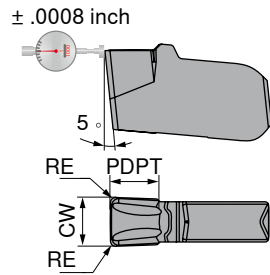
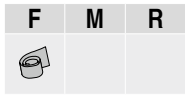
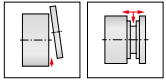

Designation	CW ± 0.02 inch	RE ± 0.05 inch	PDPT inch	for tool holder	70 346 ...	70 346 ...	70 346 ...	70 346 ...
SX E2.00 N 0.20	0.079	0.008	0.059	-SX2			822	622
SX E3.00 N 0.30	0.118	0.012	0.079	-SX3	923	523	823	623
SX E4.00 N 0.40	0.157	0.016	0.098	-SX4			824	624
P					●	●	●	●
M					○	○	●	●
K					●	●		●
N								○
S					○		○	●
H								
O								○

→ v_c Page 77
→ Application recommendation on page 81

Internal machining

External machining



Insert SX

▲ Specially developed geometry with negative edge-chamfers available in right, left and neutral types

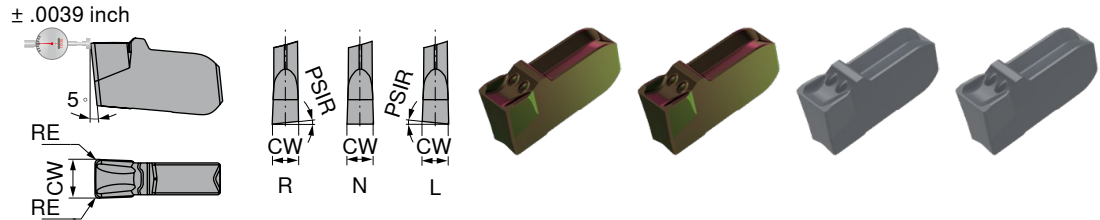
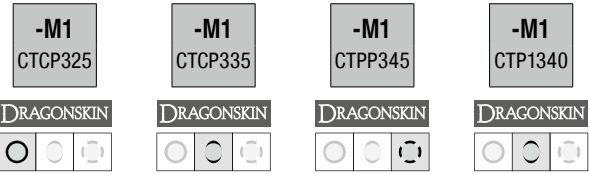

Designation	IH inch	CW ± 0.05 inch	RE ± 0.05 inch	PSIR	for tool holder	70 342 ...			
SX E2.00 L 6	L	0.079	0.008	6°	-SX2				612
SX E3.00 L 6	L	0.118	0.008	6°	-SX3	913			613
SX E4.00 L 6	L	0.157	0.012	6°	-SX4				614
SX E2.00 N 0.20	N	0.079	0.008		-SX2	922		822	622
SX E3.00 N 0.20	N	0.118	0.008		-SX3	923	523	823	623
SX E4.00 N 0.30	N	0.157	0.012		-SX4	924	524	824	624
SX E5.00 N 0.30	N	0.197	0.012		-SX5	925		825	625
SX E6.00 N 0.40	N	0.236	0.016		-SX6	926		826	626
SX E2.00 R 6	R	0.079	0.008	6°	-SX2				602
SX E3.00 R 6	R	0.118	0.008	6°	-SX3	903			603
SX E4.00 R 6	R	0.157	0.012	6°	-SX4				604
P						●	●	●	●
M						○	○	●	●
K						●	●		●
N									○
S						○		○	●
H									
O									○

→ v_c Page 77

→ Application recommendation on page 82

Note: reduce feed rate by 20–50 % with R/L version!

Internal machining	External machining		
	→ 13	→ 14–19	metric

Insert SX

▲ All purpose geometry for parting, grooving & turning.

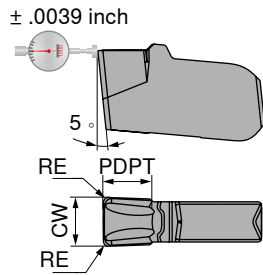
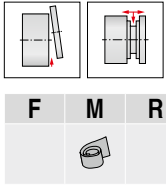

Designation	CW ± 0.05 inch	RE ± 0.05 inch	PDPT inch	for tool holder	70 343 ...		70 343 ...		70 343 ...		70 343 ...	
SX E2.00 N 0.20	0.079	0.008	0.059	-SX2	922	522	822	622				
SX E3.00 N 0.30	0.118	0.012	0.079	-SX3	923	523	823	623				
SX E4.00 N 0.40	0.157	0.016	0.098	-SX4	924	524	824	624				
SX E5.00 N 0.40	0.197	0.016	0.106	-SX5	925	525	825	625				
SX E6.00 N 0.50	0.236	0.020	0.118	-SX6	926	526	826	626				
P					●	●	●	●				
M					○	○	●	●				
K					●	●	●	●				
N												○
S					○		○	●				
H												
O												○

→ v_c Page 77
→ Application recommendation on page 81

Internal machining

External machining

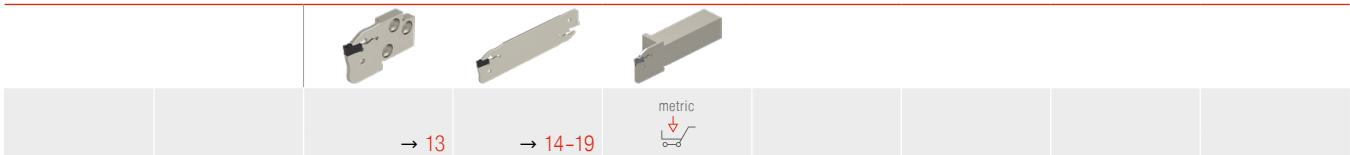

Insert SX

- ▲ Insert with highly positive cutting edge geometry and sharp cutting edge, polished chip breaker
- ▲ Specialist for aluminum and other soft long-chipping non-ferrous metals

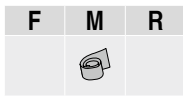
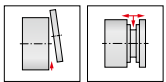

-27P
H216T

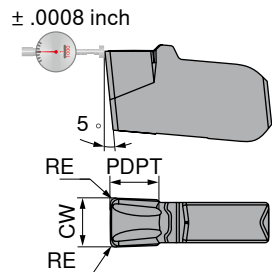
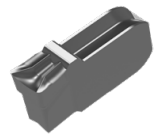

70 349 ...

Designation	CW ± 0.02 inch	RE ± 0.05 inch	PDPT inch	for tool holder	
SX E2.00 N 0.20	0.079	0.008	0.079	-SX2	122
SX E3.00 N 0.30	0.118	0.012	0.098	-SX3	123
SX E4.00 N 0.40	0.157	0.016	0.118	-SX4	124

P	
M	
K	●
N	●
S	○
H	
O	○

→ v_c Page 77
→ Application recommendation on page 81

Internal machining

External machining

		→ 13	→ 14-19	metric 				

Radius Grooving Insert SX

- ▲ for grooving and copy turning
- ▲ very good chip control

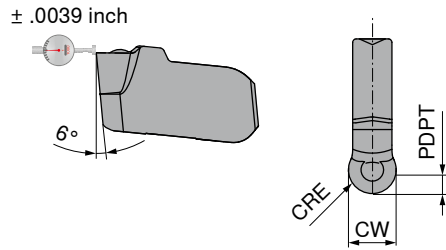
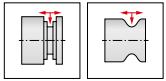

-M3
CTCP335

-M3
CTP1340



Designation	CW $_{-0.05}$ inch	CRE inch	PDPT inch	for tool holder	70 344 ...	
					531	631
SX R3.00 N 1.50	0.118	0.059	0.059	-SX3	531	631
SX R4.00 N 2.00	0.157	0.079	0.079	-SX4	532	632
SX R5.00 N 2.50	0.197	0.098	0.098	-SX5	533	633
SX R6.00 N 3.00	0.236	0.118	0.118	-SX6		634
P					●	●
M					○	●
K					●	●
N						○
S						●
H						
O						○

→ v_c Page 77

→ Application recommendation on page 82

Internal machining

External machining



		→ 13	→ 14-19	metric ↓ ↕					

ModularClamp MSS – Radial grooving module SX

▲ for parting, grooving and finish turning

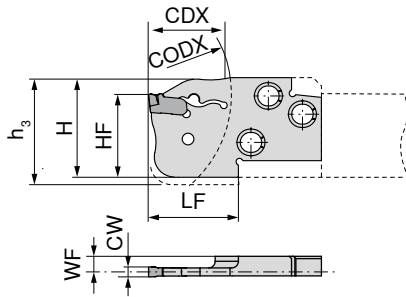

Illustrations show right-hand versions

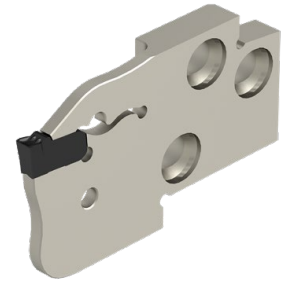

Designation	HF inch	CW inch	WF inch	LF inch	H inch	h ₃ inch	CODX inch	CDX inch	for grooving inserts	Left-hand	Right-hand
										70 897 ...	70 896 ...
E20 R/L 20-SX2	0.787	0.079	0.141	0.866	0.945	1.063	2.362	0.787	SX .2..	020	020
E20 R/L 20-SX3	0.787	0.118	0.126	0.866	0.945	1.063	2.362	0.787	SX .3..	120	120
E25 R/L 20-SX2	0.984	0.079	0.200	0.866	1.181		2.953	0.787	SX .2..	025	025
E25 R/L 25-SX3	0.984	0.118	0.185	1.063	1.181		2.953	0.984	SX .3..	125	125
E25 R/L 35-SX3	0.984	0.118	0.185	1.457	1.181		2.953	1.378	SX .3..	225	225
E25 R/L 25-SX4	0.984	0.157	0.169	1.063	1.181		2.953	0.984	SX .4..	325	325
E25 R/L 35-SX4	0.984	0.157	0.169	1.457	1.181		2.953	1.378	SX .4..	425	425
E32 R/L 35-SX3	1.260	0.118	0.185	1.457	1.496		3.780	1.378	SX .3..	032	032
E32 R/L 35-SX4	1.260	0.157	0.169	1.457	1.496		3.780	1.378	SX .4..	132	132

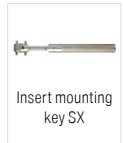

Insert mounting
key SX

70 950 ...

Spare parts for grooving inserts		
SX .2..	SX 2-3	836
SX .3..	SX 2-3	836
SX .4..	SX 4-6	837



→ 8-12	→ 69-71	metric						
--------	---------	--------	--	--	--	--	--	--

Please order insert mounting key SX separately if required.

MonoClamp – Radial Blade SX-DC Standard

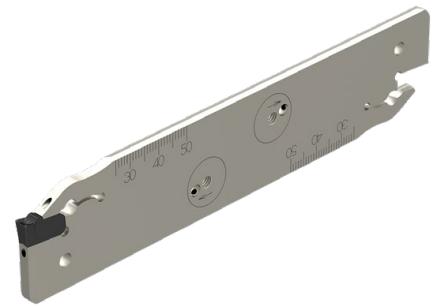
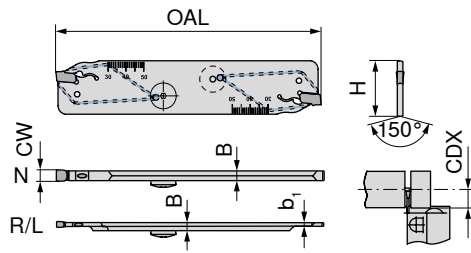

Designation	CW inch	H inch	B inch	b ₁ inch	OAL inch	CDX inch	for grooving inserts	R/L/N	70 884 ...
XLCF L 2602-DC-SX2	0.079	1.024	0.094	0.063	4.331	0.984	SX .2..	L	712
XLCF L 3202-DC-SX2	0.079	1.260	0.094	0.063	5.906	1.024	SX .2..	L	702
XLCF R 2602-DC-SX2	0.079	1.024	0.094	0.063	4.331	0.984	SX .2..	R	512
XLCF R 3202-DC-SX2	0.079	1.260	0.094	0.063	5.906	1.024	SX .2..	R	502
XLCF N 2603-DC-SX3	0.118	1.024	0.098		4.331	1.378	SX .3..	N	613
XLCF N 3203-DC-SX3	0.118	1.260	0.098		5.906	1.969	SX .3..	N	603
XLCF N 2604-DC-SX4	0.157	1.024	0.130		4.331	1.575	SX .4..	N	614
XLCF N 3204-DC-SX4	0.157	1.260	0.130		5.906	1.969	SX .4..	N	604
XLCF N 3205-DC-SX5	0.197	1.260	0.169		5.906	2.165	SX .5..	N	605
XLCF N 3206-DC-SX6	0.236	1.260	0.205		5.906	2.362	SX .6..	N	606

Spare parts for grooving inserts	Screwdriver		Insert mounting key SX		Sealing screw	
	80 950 ...	70 950 ...	70 950 ...			
SX .2..	T15 - IP	128	SX 2-3	836	M4 x 3	450
SX .3..	T15 - IP	128	SX 2-3	836	M4 x 3	450
SX .4..	T15 - IP	128	SX 4-6	837	M4 x 3	450
SX .5..	T15 - IP	128	SX 4-6	837	M4 x 3	450
SX .6..	T15 - IP	128	SX 4-6	837	M4 x 3	450

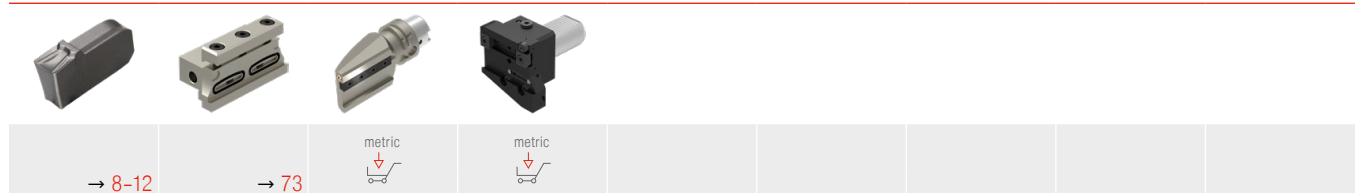

Please order insert mounting key SX separately if required.

MonoClamp – Radial Blade SX Standard

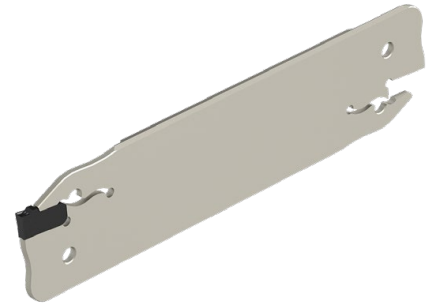
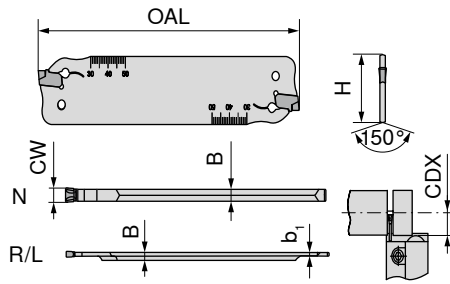

70 884 ...

Designation	CW inch	H inch	B inch	b ₁ inch	OAL inch	CDX inch	for grooving inserts	R/L/N	
XLCF L 2602-SX2	0.079	1.024	0.094	0.059	4.331	0.984	SX .2..	L	212
XLCF L 3202-SX2	0.079	1.260	0.094	0.059	5.906	0.984	SX .2..	L	202
XLCF R 2602-SX2	0.079	1.024	0.094	0.059	4.331	0.984	SX .2..	R	012
XLCF R 3202-SX2	0.079	1.260	0.094	0.059	5.906	0.984	SX .2..	R	002
XLCF N 2603-SX3	0.118	1.024	0.094		4.331	1.378	SX .3..	N	113
XLCF N 3203-SX3	0.118	1.260	0.094		5.906	1.969	SX .3..	N	103
XLCF N 2604-SX4	0.157	1.024	0.126		4.331	1.575	SX .4..	N	114
XLCF N 3204-SX4	0.157	1.260	0.126		5.906	1.969	SX .4..	N	104
XLCF N 3205-SX5	0.197	1.260	0.165		5.906	2.165	SX .5..	N	105
XLCF N 3206-SX6	0.236	1.260	0.205		5.906	2.362	SX .6..	N	106



70 950 ...

**Spare parts
for grooving inserts**

SX .2..	SX 2-3	836
SX .3..	SX 2-3	836
SX .4..	SX 4-6	837
SX .5..	SX 4-6	837
SX .6..	SX 4-6	837

5



→ 8-12	→ 74+75	metric	metric				
--------	---------	--------	--------	--	--	--	--

Please order insert mounting key SX separately if required.

MonoClamp – Radial Blade SX-DC reinforced

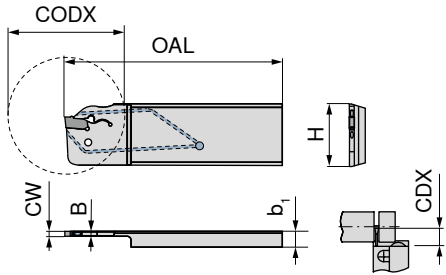

Illustrations show right-hand versions

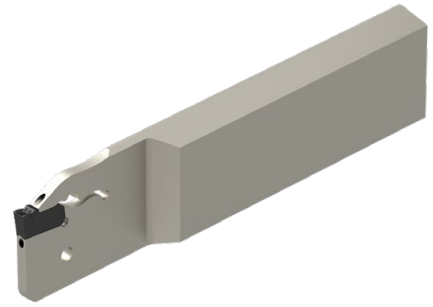

Designation	CW inch	H inch	B inch	b ₁ inch	OAL inch	CODX inch	CDX inch	for grooving inserts	R/L/N	70 879 ...
XLCF L 2608-DC-SX3	0.118	1.024	0.098	0.315	4.331	2.598	1.299	SX .3..	L	713
XLCF L 3208-DC-SX3	0.118	1.260	0.098	0.315	4.331	2.598	1.299	SX .3..	L	703
XLCF R 2608-DC-SX3	0.118	1.024	0.098	0.315	4.331	2.598	1.299	SX .3..	R	513
XLCF R 3208-DC-SX3	0.118	1.260	0.098	0.315	4.331	2.598	1.299	SX .3..	R	503



Insert mounting
key SX

Spare parts for grooving inserts

Part	Part	70 950 ...
SX .2..	SX 2-3	836
SX .3..	SX 2-3	836
SX .4..	SX 4-6	837

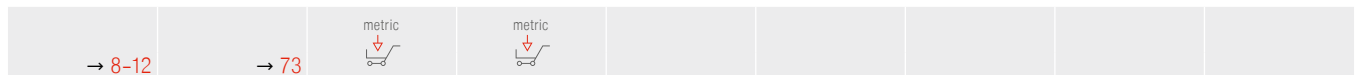

Correct Tool Selection

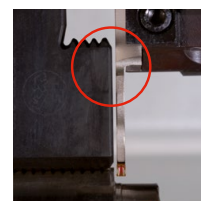
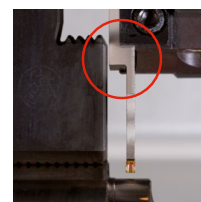
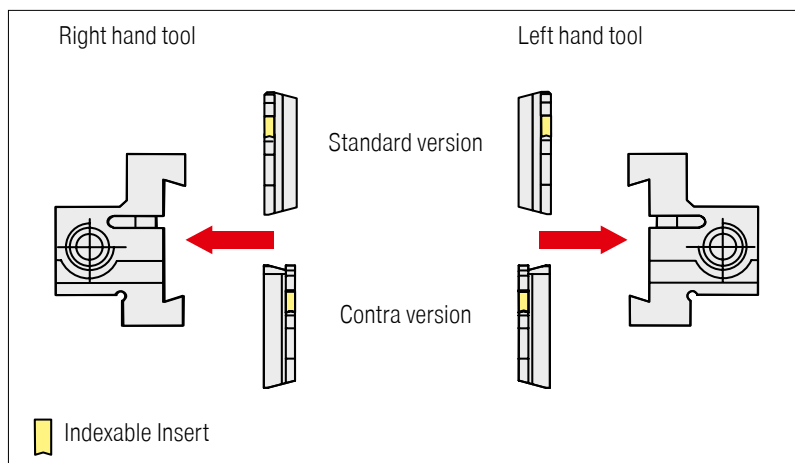

1 Please order insert mounting key SX separately if required.

MonoClamp – Radial Blade SX reinforced

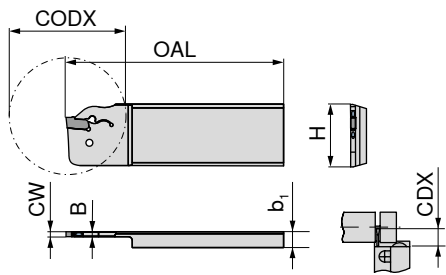

Illustrations show right-hand versions

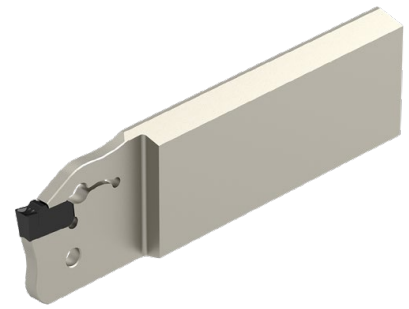

Designation	CW	H	B	b ₁	OAL	CODX	CDX	for grooving inserts	R/L/N
	inch	inch	inch	inch	inch	inch	inch		
XLCF L 2608-SX2	0.079	1.024	0.059	0.315	4.331	1.732	0.866	SX 2..	L
XLCF L 2608-SX3	0.118	1.024	0.098	0.315	4.331	1.732	0.866	SX 3..	L
XLCF L 3208-SX3	0.118	1.260	0.098	0.315	4.331	2.598	1.299	SX 3..	L
XLCF L 3208-SX4	0.157	1.260	0.134	0.315	4.331	2.598	1.299	SX 4..	L
XLCF R 2608-SX2	0.079	1.024	0.059	0.315	4.331	1.732	0.866	SX 2..	R
XLCF R 2608-SX3	0.118	1.024	0.098	0.315	4.331	1.732	0.866	SX 3..	R
XLCF R 3208-SX3	0.118	1.260	0.098	0.315	4.331	2.598	1.299	SX 3..	R
XLCF R 3208-SX4	0.157	1.260	0.134	0.315	4.331	2.598	1.299	SX 4..	R

70 879 ...

212 ¹⁾
213 ¹⁾
203
204

012 ¹⁾
013 ¹⁾
003
004

1) can be used in both directions



70 950 ...

Spare parts
for grooving inserts

SX 2..	SX 2-3	836
SX 3..	SX 2-3	836
SX 4..	SX 4-6	837

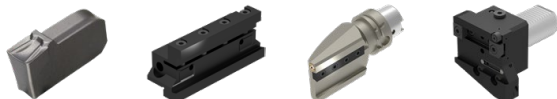

→ 8-12	→ 74+75	metric	metric				
--------	---------	--------	--------	--	--	--	--

Please order insert mounting key SX separately if required.

MonoClamp – SX-DC reinforced Contra radial blade

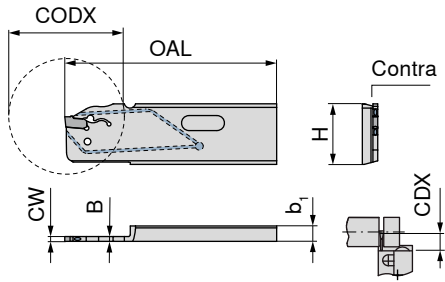

Illustrations show right-hand versions

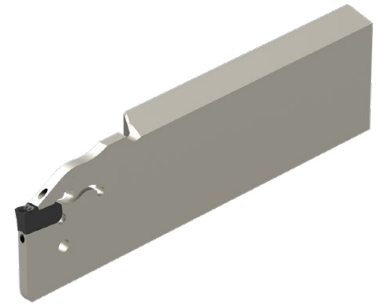

Designation	CW inch	H inch	B inch	b ₁ inch	OAL inch	CODX inch	CDX inch	for grooving inserts	R/L/N
XLCF L 3208C-DC-SX3	0.118	1.260	0.098	0.315	4.331	2.598	1.299	SX.3..	L
XLCF R 3208C-DC-SX3	0.118	1.260	0.098	0.315	4.331	2.598	1.299	SX.3..	R

70 877 ...

703

503



Insert mounting
key SX

70 950 ...

Spare parts
for grooving inserts
SX.3..

SX 2-3

836



→ 8-12

→ 73



Correct Tool Selection

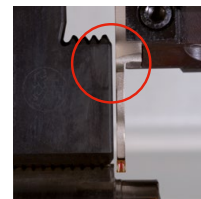
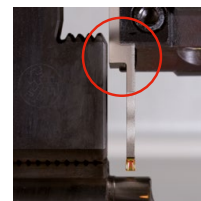
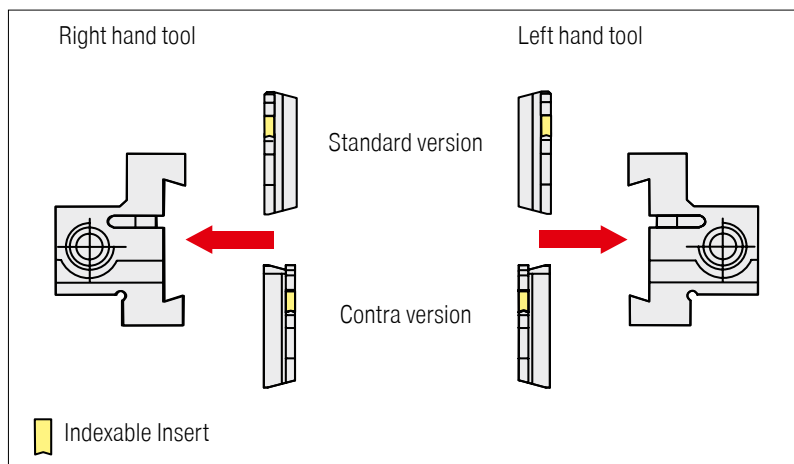

Please order insert mounting key SX separately if required.

MonoClamp – SX reinforced Contra radial blade

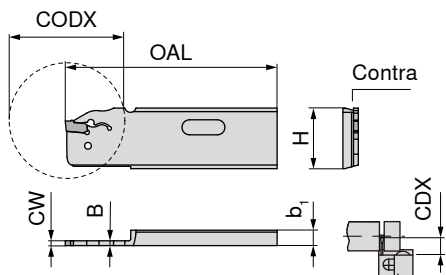

Illustrations show right-hand versions

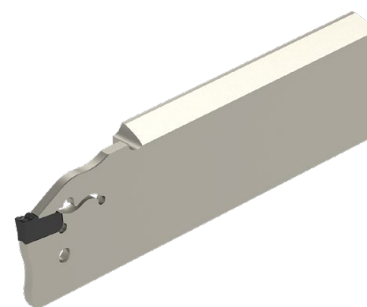

Designation	CW inch	H inch	B inch	b ₁ inch	OAL inch	CODX inch	CDX inch	for grooving inserts	R/L/N
XLCF L 3208C-SX3	0.118	1.260	0.098	0.315	4.331	2.598	1.299	SX.3..	L
XLCF R 3208C-SX3	0.118	1.260	0.098	0.315	4.331	2.598	1.299	SX.3..	R

70 877 ...

203

003



Insert mounting key SX

70 950 ...

**Spare parts
for grooving inserts**
SX.3..

SX 2-3

836

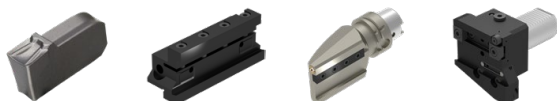

→ 8-12

→ 74+75



i Please order insert mounting key SX separately if required.

Insert FX

- ▲ Excellent cutting geometry with low cutting forces
- ▲ Very good chip control also with low feed rates
- ▲ Reduced built-up edge

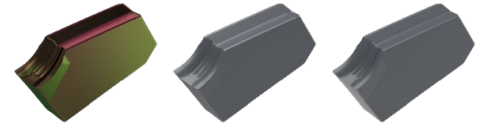
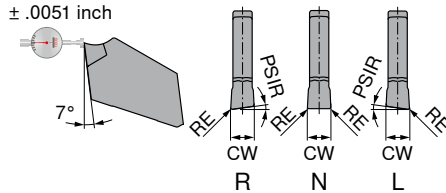
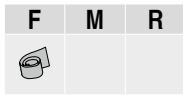
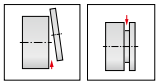

Designation	IH inch	CW _{.01} inch	RE _{+/-0.05} inch	PSIR	for tool holder	70 331 ...		
						70 331 ...	70 331 ...	70 331 ...
FX 2.2 L 5-F1	L	0.087	0.006	5°	-FX 2.2		847	647
FX 3.1 L 5-F1	L	0.122	0.008	5°	-FX 3.1		851	651
FX 3.1 L 8-F1	L	0.122	0.008	8°	-FX 3.1		855	
FX 2.2 N 0.15-F1	N	0.087	0.006		-FX 2.2	998	848	648
FX 3.1 N 0.40-F1	N	0.122	0.016		-FX 3.1	906	856	656
FX 3.1 N 0.20-F1	N	0.122	0.008		-FX 3.1	902	852	652
FX 4.1 N 0.20-F1	N	0.161	0.008		-FX 4.1		860	660
FX 4.1 N 0.50-F1	N	0.161	0.020		-FX 4.1		864	
FX 2.2 R 5-F1	R	0.087	0.006	5°	-FX 2.2		849	649
FX 3.1 R 5-F1	R	0.122	0.008	5°	-FX 3.1		853	653
FX 3.1 R 8-F1	R	0.122	0.008	8°	-FX 3.1		857	
P						●	●	●
M						○	●	●
K						●		●
N								○
S						○	○	●
H								
O								○

→ v_c Page 77
→ Application recommendation on page 83

Note: reduce feed rate by 20–50 % with R/L version!

Internal machining

External machining



Insert FX

▲ narrow version

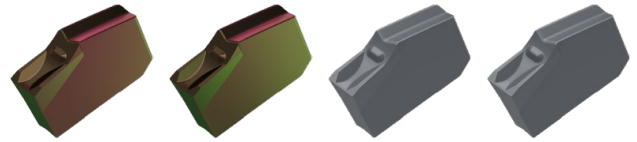
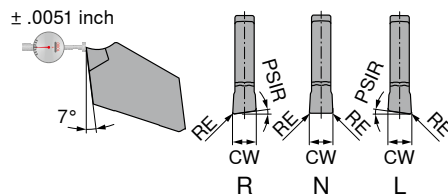
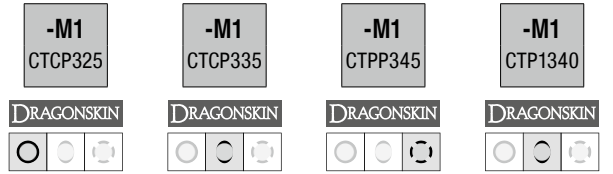
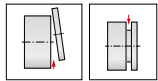

Designation	IH inch	CW _{-0.1} inch	RE _{+/-0.05} inch	PSIR	for tool holder	70 330 ...	70 330 ...	70 330 ...	70 330 ...
FX 2.2 L 4-M1	L	0.087	0.004	4°	-FX 2.2		550	800	600
FX 2.2 N 0.10-M1	N	0.087	0.004		-FX 2.2	902	552	802	602
FX 2.2 R 4-M1	R	0.087	0.004	4°	-FX 2.2		554	804	604
P						●	●	●	●
M						○	○	●	●
K						●	●	●	●
N									○
S						○		○	●
H									
O									○

→ v_c Page 77

→ Application recommendation on page 83

5

1 Note: reduce feed rate by 20–50 % with R/L version!

Internal machining

External machining



Insert FX

▲ wide version

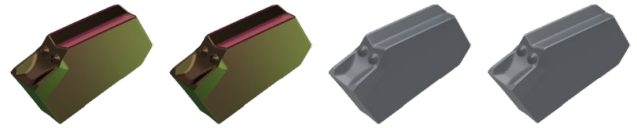
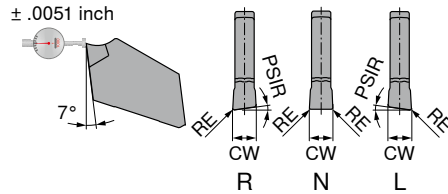
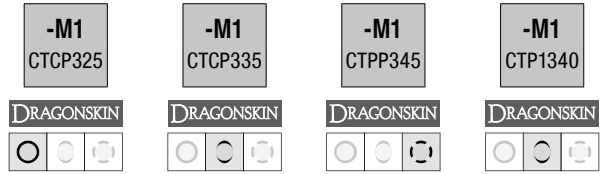
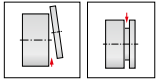

Designation	IH inch	CW ±0.05 inch	RE ±0.05 inch	PSIR	for tool holder	70 332 ...			
						900	550	800	600
FX 3.1 L 6-M1	L	0.122	0.006	6°	-FX 3.1	900	550	800	600
FX 4.1 L 6-M1	L	0.161	0.008	6°	-FX 4.1		556	806	606
FX 3.1 N 0.15-M1	N	0.122	0.006		-FX 3.1	902	552	802	602
FX 4.1 N 0.20-M1	N	0.161	0.008		-FX 4.1	908	558	808	608
FX 5.1 N 0.25-M1	N	0.201	0.010		-FX 5.1	914	564	814	614
FX 6.5 N 0.30-M1	N	0.256	0.012		-FX 6.5	920	570		620
FX 8.2 N 0.40-M1	N	0.323	0.016		XLCEN 4608	924	574		624
FX 9.7 N 0.40-M1	N	0.382	0.016		XLCEN 4609	926	576		626
FX 3.1 R 6-M1	R	0.122	0.006	6°	-FX 3.1	904	554	804	604
FX 4.1 R 6-M1	R	0.161	0.008	6°	-FX 4.1		560	810	610
FX 5.1 R 6-M1	R	0.201	0.010	6°	-FX 5.1			816	
P						●	●	●	●
M						○	○	●	●
K						●	●		●
N									○
S						○		○	●
H									
O									○

→ v_c Page 77

→ Application recommendation on page 83

Note: reduce feed rate by 20–50 % with R/L version!

Internal machining

External machining



Insert FX

- ▲ Insert with highly positive cutting edge geometry and sharp cutting edge, polished chip breaker
- ▲ Reduced built-up edge

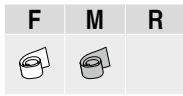
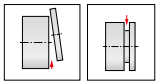

-27P
H216T

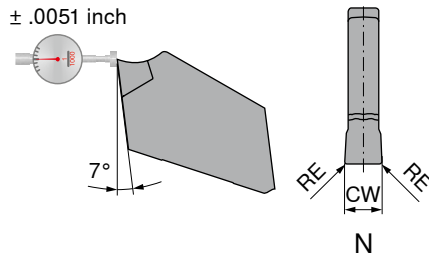
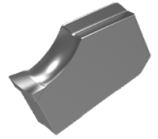

70 334 ...

Designation	IH inch	CW _{-0.1} inch	RE _{±0.05} inch	for tool holder
FX 2.2 N 0.10	N	0.087	0.004	-FX 2.2
FX 3.1 N 0.15	N	0.122	0.006	-FX 3.1
FX 4.1 N 0.15	N	0.161	0.006	-FX 4.1

650
652
654

P	
M	
K	●
N	●
S	○
H	
O	○

→ v_c Page 77
→ Application recommendation on page 83

5

Internal machining

External machining



Insert FX

- ▲ Insert with excellent chip control for a wide range of feed rates
- ▲ Very stable cutting edge

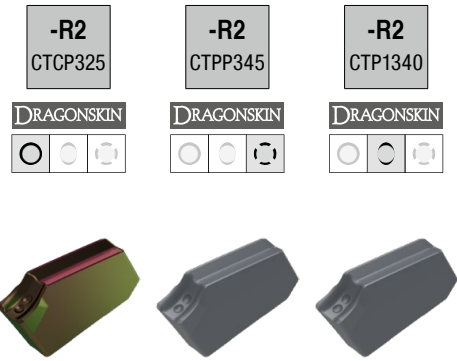
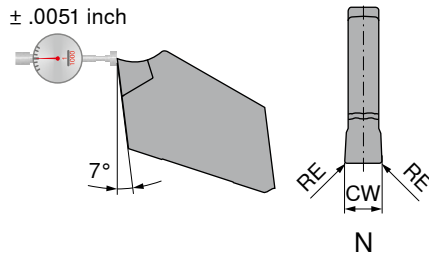
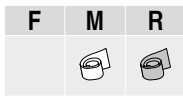
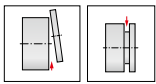

Designation	IH inch	CW ^{-0.1} inch	RE ^{+/-0.05} inch	for tool holder	70 335 ...	70 335 ...	70 335 ...
					902 908	852 858	652 658
FX 3.1 N 0.40-R2	N	0.122	0.016	-FX 3.1			
FX 4.1 N 0.50-R2	N	0.161	0.020	-FX 4.1			
P					●	●	●
M					○	●	●
K					●		●
N							○
S					○	○	●
H							
O							○

→ v_c Page 77
→ Application recommendation on page 83

Internal machining

External machining



ModularClamp MSS – Radial grooving module FX short/long

▲ For parting and grooving

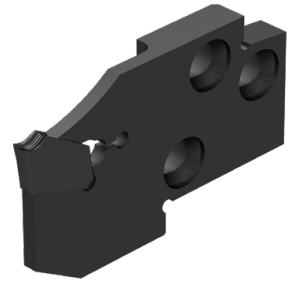
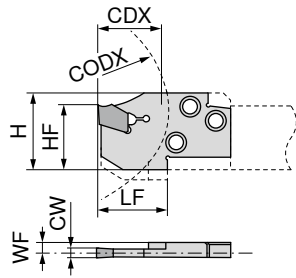

Illustrations show right-hand versions

Designation	HF inch	CW inch	WF inch	LF inch	H inch	CODX inch	CDX inch	for grooving inserts	Left-hand	Right-hand
									70 876 ...	70 875 ...
E20 R/L 20-FX 2.2	0.906	0.087	0.141	0.866	1.063	2.362	0.787	FX 2.2 ..	020	020
E20 R/L 20-FX 3.1	0.906	0.122	0.126	0.866	1.063	2.362	0.787	FX 3.1 ..	120	120
E20 R/L 20-FX 4.1	0.906	0.161	0.110	0.866	1.063	2.362	0.787	FX 4.1 ..	220	220
E25 R/L 20-FX 2.2	0.984	0.087	0.200	0.866	1.181	2.953	0.787	FX 2.2 ..	025	025
E25 R/L 25-FX 3.1	0.984	0.122	0.185	1.063	1.181	2.953	0.984	FX 3.1 ..	125	125
E25 R/L 25-FX 4.1	0.984	0.161	0.169	1.063	1.181	2.953	0.984	FX 4.1 ..	225	225
E25 R/L 25-FX 5.1	0.984	0.201	0.154	1.063	1.181	2.953	0.984	FX 5.1 ..	325	325
E25 R/L 25-FX 6.5	0.984	0.256	0.130	1.063	1.181	2.953	0.984	FX 6.5 ..	425	425
E25 R/L 35-FX 3.1	0.984	0.122	0.185	1.457	1.181	2.953	1.378	FX 3.1 ..	525	525
E25 R/L 35-FX 4.1	0.984	0.161	0.169	1.457	1.181	2.953	1.378	FX 4.1 ..	625	625
E25 R/L 35-FX 5.1	0.984	0.201	0.154	1.457	1.181	2.953	1.378	FX 5.1 ..	725	725
E25 R/L 35-FX 6.5	0.984	0.256	0.130	1.457	1.181	2.953	1.378	FX 6.5 ..	825	825
E32 R/L 32-FX 3.1	1.260	0.122	0.185	1.339	1.496	3.780	1.260	FX 3.1 ..	032	032
E32 R/L 32-FX 4.1	1.260	0.161	0.169	1.339	1.496	3.780	1.260	FX 4.1 ..	132	132
E32 R/L 32-FX 5.1	1.260	0.201	0.154	1.339	1.496	3.780	1.260	FX 5.1 ..	232	232
E32 R/L 32-FX 6.5	1.260	0.256	0.130	1.339	1.496	3.780	1.260	FX 6.5 ..	332	332
E32 R/L 45-FX 3.1	1.260	0.122	0.185	1.850	1.496	3.780	1.772	FX 3.1 ..	432	432
E32 R/L 45-FX 4.1	1.260	0.161	0.169	1.850	1.496	3.780	1.772	FX 4.1 ..	532	532
E32 R/L 45-FX 5.1	1.260	0.201	0.154	1.850	1.496	3.780	1.772	FX 5.1 ..	632	632
E32 R/L 45-FX 6.5	1.260	0.256	0.130	1.850	1.496	3.780	1.772	FX 6.5 ..	732	732



Insert mounting key

70 950 ...

Spare parts for grooving inserts

FX 2.2 ..	375
FX 3.1 ..	376
FX 4.1 ..	376
FX 5.1 ..	376
FX 6.5 ..	376



→ 20-24

→ 69-71



metric

MonoClamp – Radial Monoholder FX

Scope of supply:

Blade and insert mounting key

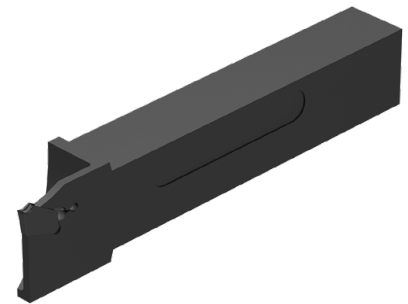
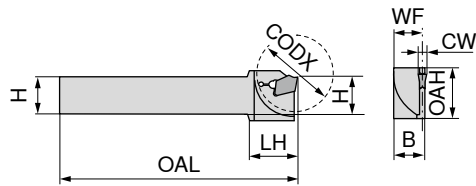

Illustrations show right-hand versions

Designation	H inch	B inch	OAL inch	LH inch	OAH inch	CW inch	WF inch	CODX inch	for grooving inserts	Left-hand	Right-hand
										78 837 ...	78 836 ...
XLCE R/L 06 M22 FX-E	0.375	0.375	6.000	0.709	0.498	0.087	0.343	1.181	FX 2.2 ..	37500	37500
XLCE R/L 08 F22 FX-E	0.500	0.500	3.000	0.709	0.623	0.087	0.497	1.181	FX 2.2 ..	50000	50000
XLCE R/L 08 M22 FX-E	0.500	0.500	6.000	0.709	0.623	0.087	0.497	1.181	FX 2.2 ..	50100	50100
XLCE R/L 09 M22 FX-E	0.563	0.563	6.000	0.709	0.686	0.087	0.530	1.181	FX 2.2 ..	56300	56300
XLCE R/L 10 H22 FX-E	0.625	0.625	4.000	0.709	0.748	0.087	0.593	1.181	FX 2.2 ..	62500	62500
XLCF R/L 10 H31 FX-E	0.625	0.625	4.000	0.827	0.748	0.122	0.578	1.378	FX 3.1 ..	62600	62600
XLCF R/L 12 K31 FX-E	0.750	0.750	5.000	0.984	0.906	0.122	0.703	1.575	FX 3.1 ..	75100	75100
XLCF R/L 64 M31 FX-E	1.000	0.750	6.000	1.220	1.118	0.122	0.703	1.969	FX 3.1 ..	00100	00100
XLCF R/L 12 K41 FX-E	0.750	0.750	5.000	0.984	0.906	0.161	0.687	1.575	FX 4.1 ..	75000	75000
XLCF R/L 64 M41 FX-E	1.000	0.750	6.000	1.220	1.118	0.161	0.687	1.969	FX 4.1 ..	00000	00000

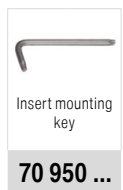

**Spare parts
for grooving inserts**

FX 2.2 ..	375
FX 3.1 ..	376
FX 4.1 ..	376



→ 20-24

MonoClamp – Radial Blade FX

Scope of supply:

Blade and insert mounting key

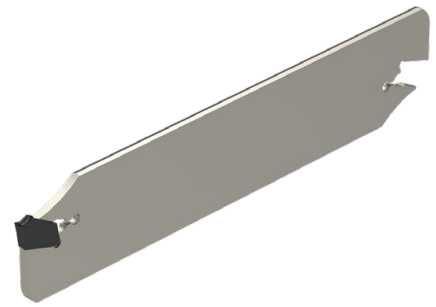
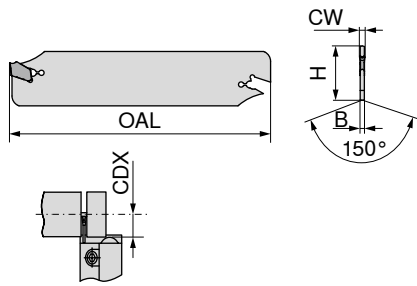

70 832 ...

Designation	H inch	B inch	OAL inch	CW inch	CDX inch	for grooving inserts	
XLCEN 2602 J 22 FX	1.024	0.065	4.331	0.087	0.984	FX 2.2 ..	101
XLCFN 2603 J 31 FX	1.024	0.094	4.331	0.122	1.378	FX 3.1 ..	102
XLCFN 2604 J 41 FX	1.024	0.126	4.331	0.161	1.575	FX 4.1 ..	103
XLCEN 3202 M 22 FX	1.260	0.065	5.906	0.087	1.181	FX 2.2 ..	004
XLCFN 3203 M 31 FX	1.260	0.094	5.906	0.122	1.969	FX 3.1 ..	104
XLCFN 3204 M 41 FX	1.260	0.126	5.906	0.161	1.969	FX 4.1 ..	105
XLCFN 3205 M 51 FX	1.260	0.157	5.906	0.201	2.165	FX 5.1 ..	106
XLCFN 3206 M 65 FX	1.260	0.205	5.906	0.256	2.165	FX 6.5 ..	107
XLCEN 4608 S 82 FX	1.811	0.268	9.843	0.323	3.150	FX 8.2 ..	108
XLCEN 4609 S 97 FX	1.811	0.315	9.843	0.382	3.150	FX 9.7 ..	109



Insert mounting
key

70 950 ...

**Spare parts
for grooving inserts**

FX 2.2 ..	375
FX 3.1 ..	376
FX 4.1 ..	376
FX 5.1 ..	376
FX 6.5 ..	376
FX 8.2 ..	377
FX 9.7 ..	377



→ 20-24

→ 74+75

Insert GX 09/16

- ▲ Insert with ground periphery
- ▲ Suitable also for parting off tubes and thin-walled workpieces

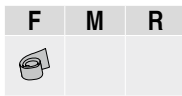
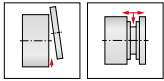

-F2
CTP1340

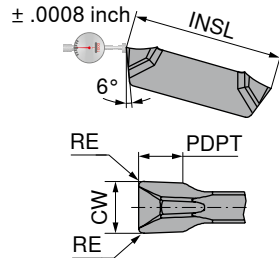

70 360 ...

Designation	INSL inch	CW ± 0.02 inch	RE ± 0.05 inch	PDPT inch	for tool holder	
GX 09-1 E2.00 N 0.20	0.354	0.079	0.008	0.059	GX 09-1	600
GX 09-1 E2.50 N 0.20	0.354	0.098	0.008	0.059	GX 09-1	602
GX 09-2 E3.00 N 0.30	0.354	0.118	0.012	0.079	GX 09-2	604
GX 16-1 E2.00 N 0.20	0.630	0.079	0.008	0.098	GX 16-1	650
GX 16-2 E3.00 N 0.30	0.630	0.118	0.012	0.118	GX 16-2	652
GX 16-3 E4.00 N 0.40	0.630	0.157	0.016	0.138	GX 16-3	654
GX 16-3 E5.00 N 0.40	0.630	0.197	0.016	0.138	GX 16-3	656

P	●
M	●
K	●
N	○
S	●
H	
O	○

→ v_c Page 77
→ Application recommendation on page 78

Internal machining

External machining

→ 38+39	→ 41		→ 36+37	→ 40	

Insert GX 09/16 – Standard

▲ Suitable for parting thin-walled workpieces

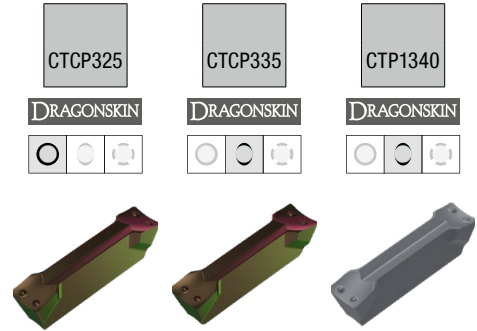
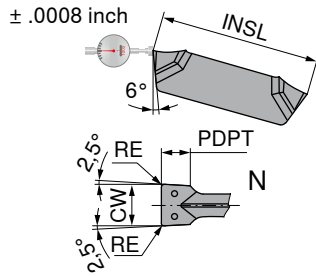

Designation	INSL inch	CW ± _{-0.02} inch	RE ± _{-0.05} inch	PDPT inch	for tool holder
GX 09-1 E2.00 N 0.20	0.354	0.079	0.008	0.059	GX 09-1
GX 09-1 E2.50 N 0.20	0.354	0.098	0.008	0.059	GX 09-1
GX 09-2 E3.00 N 0.30	0.354	0.118	0.012	0.079	GX 09-2
GX 16-1 E2.00 N 0.20	0.630	0.079	0.008	0.098	GX 16-1
GX 16-1 E2.50 N 0.20	0.630	0.098	0.008	0.098	GX 16-1
GX 16-2 E3.00 N 0.30	0.630	0.118	0.012	0.118	GX 16-2
GX 16-2 E3.00 N 0.50	0.630	0.118	0.020	0.118	GX 16-2
GX 16-2 E3.50 N 0.30	0.630	0.138	0.012	0.118	GX 16-2
GX 16-3 E4.00 N 0.60	0.630	0.157	0.024	0.138	GX 16-3
GX 16-3 E4.00 N 0.40	0.630	0.157	0.016	0.138	GX 16-3
GX 16-3 E5.00 N 0.40	0.630	0.197	0.016	0.138	GX 16-3
GX 16-4 E6.00 N 0.50	0.630	0.236	0.020	0.157	GX 16-4
GX 16-4 E6.00 N 0.80	0.630	0.236	0.031	0.157	GX 16-4

70 350 ...	70 350 ...	70 350 ...
984		634
988		638
992		642
900	500	600
904	504	604
908	508	608
910		
912	512	612
918		
916	516	616
924	524	624
928		628
930		

P	●	●	●
M	○	○	●
K	●	●	●
N			○
S	○		●
H			
O			○

→ v_c Page 77

→ Application recommendation on page 78

Internal machining

External machining



Insert GX 09/16

▲ Very good chip control

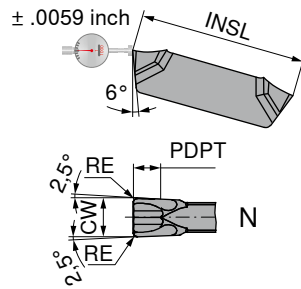
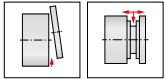

-M40
CTCP325

-M40
CTPP345

-M40
CTP1340



Designation	INSL inch	CW ± 0.05 inch	RE ± 0.05 inch	PDPT inch	for tool holder	70 351 ...		
GX 09-1 E2.00 N 0.20	0.354	0.079	0.008	0.059	GX 09-1	986	886	686
GX 09-2 E3.00 N 0.30	0.354	0.118	0.012	0.079	GX 09-2	994	894	694
GX 16-1 E2.00 N 0.20	0.630	0.079	0.008	0.098	GX 16-1	902	802	602
GX 16-2 E3.00 N 0.30	0.630	0.118	0.012	0.118	GX 16-2	910	810	610
GX 16-3 E4.00 N 0.40	0.630	0.157	0.016	0.138	GX 16-3	918	818	618
GX 16-3 E5.00 N 0.40	0.630	0.197	0.016	0.138	GX 16-3	926	826	626
GX 16-4 E6.00 N 0.50	0.630	0.236	0.020	0.157	GX 16-4	930	830	630

P	●	●	●
M	○	●	●
K	●	○	●
N	○	○	○
S	○	○	●
H			
O			○

→ v_c Page 77
→ Application recommendation on page 78

Internal machining

External machining



Insert GX 16

▲ Very good chip control

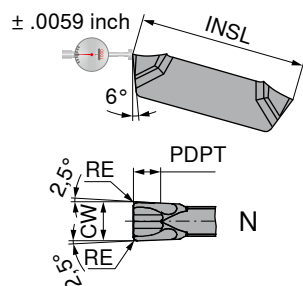
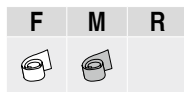

-M1
CTCP325

-M1
CTPP345

-M1
CTP1340



Designation	INSL inch	CW inch	RE inch	PDPT inch	for tool holder	70 362 ...		70 362 ...		70 362 ...	
GX 16-1 E2.00 N 0.20	0.630	0.079	0.008	0.079	GX 16-1				800		600
GX 16-2 E3.00 N 0.20	0.630	0.118	0.008	0.098	GX 16-2	902			802		602
GX 16-3 E4.00 N 0.30	0.630	0.157	0.012	0.118	GX 16-3	904					604
P						●			●		●
M						○			●		●
K						●					●
N											○
S						○			○		●
H											
O											○

→ v_c Page 77
→ Application recommendation on page 79

Internal machining

External machining

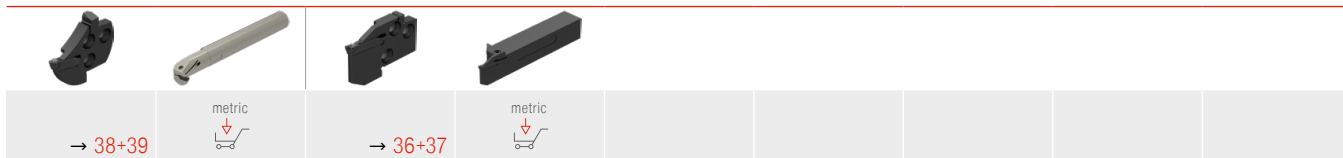

Insert GX 16

- ▲ Insert with highly positive cutting edge geometry and sharp cutting edge, polished chip breaker
- ▲ ground periphery

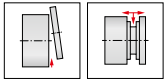

-27P
H216T

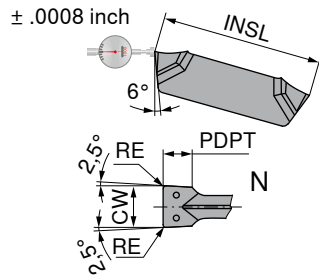
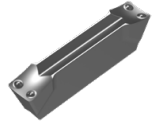

70 350 ...

Designation	INSL inch	CW ± 0.02 inch	RE ± 0.05 inch	PDPT inch	for tool holder	
GX 16-1 E2.00 N 0.20	0.630	0.079	0.008	0.098	GX 16-1	650
GX 16-2 E3.00 N 0.30	0.630	0.118	0.012	0.118	GX 16-2	658
GX 16-3 E4.00 N 0.40	0.630	0.157	0.016	0.138	GX 16-3	670
GX 16-4 E6.00 N 0.50	0.630	0.236	0.020	0.157	GX 16-4	678

P	
M	
K	●
N	●
S	○
H	
O	○

→ v_c Page 77

→ Application recommendation on page 78

Internal machining

External machining

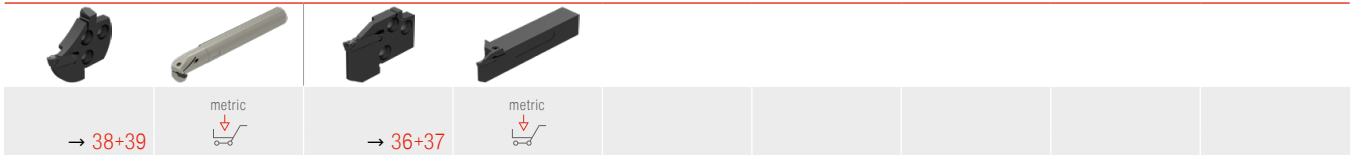

Circlip groove insert GX 09/16 – Standard

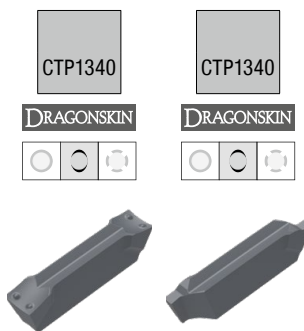
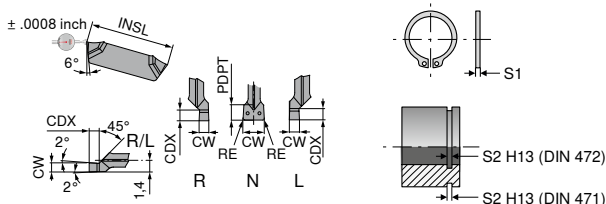
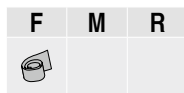

Designation	IH inch	INSL inch	s ₁ inch	s ₂ inch	CW ± 0.02 inch	RE ± 0.05 inch	CDX inch	PDPT inch	for tool holder	70 352 ...	70 352 ...
GX 09-1 S0.60 L	L	0.354	0.016	0.020	0.024		0.030		R/L 02-GX 09-1		679
GX 09-1 S0.80 L	L	0.354	0.024	0.028	0.031		0.037		R/L 02-GX 09-1		681
GX 09-1 S0.90 L	L	0.354	0.028	0.031	0.035		0.041		R/L 02-GX 09-1		683
GX 09-1 S1.00 L	L	0.354	0.031	0.035	0.039		0.045		R/L 02-GX 09-1		684
GX 09-1 S1.20 L	L	0.354	0.039	0.043	0.047		0.053		R/L 02-GX 09-1		686
GX 09-1 S1.40 L	L	0.354	0.047	0.051	0.055		0.060		R/L 02-GX 09-1		688
GX 09-1 S1.70 L	L	0.354	0.059	0.063	0.067		0.072		R/L 02-GX 09-1		690
GX 16-2 S0.60 L	L	0.630	0.016	0.020	0.024		0.030		R/L 03-GX 16-2		607
GX 16-2 S0.80 L	L	0.630	0.024	0.028	0.031		0.037		R/L 03-GX 16-2		609
GX 16-2 S0.90 L	L	0.630	0.028	0.031	0.035		0.041		R/L 03-GX 16-2		611
GX 16-2 S1.00 L	L	0.630	0.031	0.035	0.039		0.045		R/L 03-GX 16-2		612
GX 16-2 S1.20 L	L	0.630	0.039	0.043	0.047		0.053		R/L 03-GX 16-2		614
GX 16-2 S1.40 L	L	0.630	0.047	0.051	0.055		0.060		R/L 03-GX 16-2		616
GX 16-2 S1.70 L	L	0.630	0.059	0.063	0.067		0.072		R/L 03-GX 16-2		618
GX 16-2 S1.95 L	L	0.630	0.069	0.073	0.077		0.081		R/L 03-GX 16-2		620
GX 16-2 S2.25 L	L	0.630	0.079	0.085	0.089		0.093		R/L 03-GX 16-2		622
GX 09-1 S1.95 N	N	0.354	0.069	0.073	0.077	0.004		0.079	GX 09-1	692	
GX 09-1 S2.25 N	N	0.354	0.079	0.085	0.089	0.004		0.079	GX 09-1	694	
GX 09-2 S2.75 N	N	0.354	0.098	0.104	0.108	0.004		0.079	GX 09-2	696	
GX 09-2 S3.25 N	N	0.354	0.118	0.124	0.128	0.004		0.079	GX 09-2	698	
GX 16-2 S2.75 N	N	0.630	0.098	0.104	0.108	0.004		0.118	GX 16-2	624	
GX 16-2 S3.25 N	N	0.630	0.118	0.124	0.128	0.004		0.118	GX 16-2	626	
GX 16-3 S4.25 N	N	0.630	0.157	0.163	0.167	0.008		0.138	GX 16-3	628	
GX 16-4 S5.25 N	N	0.630	0.197	0.203	0.207	0.008		0.157	GX 16-4	630	
GX 09-1 S0.60 R	R	0.354	0.016	0.020	0.024		0.030		R/L 02-GX 09-1		670
GX 09-1 S0.80 R	R	0.354	0.024	0.028	0.031		0.037		R/L 02-GX 09-1		672
GX 09-1 S0.90 R	R	0.354	0.028	0.031	0.035		0.041		R/L 02-GX 09-1		674
GX 09-1 S1.00 R	R	0.354	0.031	0.035	0.039		0.045		R/L 02-GX 09-1		676
GX 09-1 S1.20 R	R	0.354	0.039	0.043	0.047		0.053		R/L 02-GX 09-1		678
GX 09-1 S1.40 R	R	0.354	0.047	0.051	0.055		0.060		R/L 02-GX 09-1		680
GX 09-1 S1.70 R	R	0.354	0.059	0.063	0.067		0.072		R/L 02-GX 09-1		682
GX 16-2 S0.60 R	R	0.630	0.016	0.020	0.024		0.030		R/L 03-GX 16-2		695
GX 16-2 S0.80 R	R	0.630	0.024	0.028	0.031		0.037		R/L 03-GX 16-2		697
GX 16-2 S0.90 R	R	0.630	0.028	0.031	0.035		0.041		R/L 03-GX 16-2		699
GX 16-2 S1.00 R	R	0.630	0.031	0.035	0.039		0.045		R/L 03-GX 16-2		600
GX 16-2 S1.20 R	R	0.630	0.039	0.043	0.047		0.053		R/L 03-GX 16-2		602
GX 16-2 S1.40 R	R	0.630	0.047	0.051	0.055		0.060		R/L 03-GX 16-2		604
GX 16-2 S1.70 R	R	0.630	0.059	0.063	0.067		0.072		R/L 03-GX 16-2		606
GX 16-2 S1.95 R	R	0.630	0.069	0.073	0.077		0.081		R/L 03-GX 16-2		608
GX 16-2 S2.25 R	R	0.630	0.079	0.085	0.089		0.093		R/L 03-GX 16-2		610
P										•	•
M										•	•
K										•	•
N										○	○
S										•	•
H											
O										○	○

5

→ v_c Page 77

→ Application recommendation on page 79



Attention – applies only to internal machining:

Right-hand insert → left-hand module or monobloc boring bar
 Left-hand insert → right-hand module or monobloc boring bar

Internal machining

External machining



Radius groove insert GX 09/16

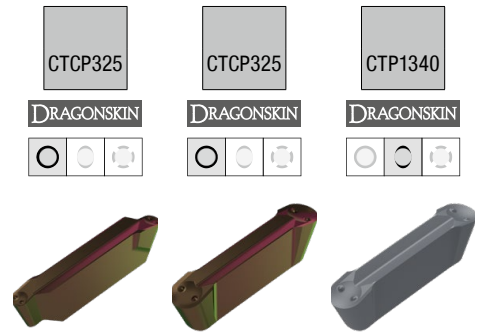
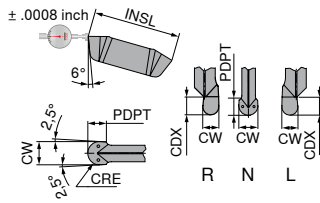

Designation	IH inch	INSL inch	CW ± 0.02 inch	CRE inch	PDPT inch	CDX inch	for tool holder
GX 09-1 R0.80 L	L	0.354	0.063	0.031		0.070	R/L 02-GX 09-1
GX 16-2 R0.80 L	L	0.630	0.063	0.031		0.070	R/L 03-GX 16-2
GX 16-2 R1.00 L	L	0.630	0.079	0.039		0.086	R/L 03-GX 16-2
GX 16-2 R1.20 L	L	0.630	0.094	0.047		0.102	R/L 03-GX 16-2
GX 09-1 R1.00 N	N	0.354	0.079	0.039	0.039		GX 09-1
GX 09-1 R1.20 N	N	0.354	0.094	0.047	0.047		GX 09-1
GX 16-2 R1.50 N	N	0.630	0.118	0.059	0.059		GX 16-2
GX 16-3 R2.00 N	N	0.630	0.157	0.079	0.079		GX 16-3
GX 16-3 R2.50 N	N	0.630	0.197	0.098	0.098		GX 16-3
GX 16-4 R3.00 N	N	0.630	0.236	0.118	0.118		GX 16-4
GX 09-1 R0.80 R	R	0.354	0.063	0.031		0.070	R/L 02-GX 09-1
GX 16-2 R0.80 R	R	0.630	0.063	0.031		0.070	R/L 03-GX 16-2
GX 16-2 R1.00 R	R	0.630	0.079	0.039		0.086	R/L 03-GX 16-2
GX 16-2 R1.20 R	R	0.630	0.094	0.047		0.102	R/L 03-GX 16-2

70 354 ...	70 354 ...	70 354 ...
988		
912		
916		
920		
	992	
	996	
	924	624
	928	628
	932	632
	936	636
984		
900		
904		
908		

P	●	●	●
M	○	○	●
K	●	●	●
N			○
S	○	○	●
H			
O			○

→ v_c Page 77

→ Application recommendation on page 79



Attention – applies only to internal machining:

Right-hand insert → left-hand module or monobloc boring bar
Left-hand insert → right-hand module or monobloc boring bar

Internal machining

External machining



Radius groove insert GX 16

- ▲ Insert with highly positive cutting edge geometry and sharp cutting edge, polished chip breaker
- ▲ ground periphery

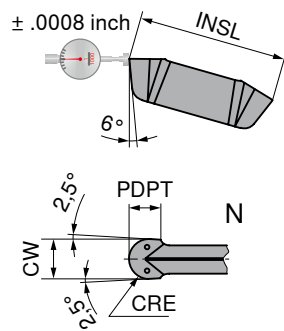

-27P
H216T



70 354 ...

Designation	INSL inch	CW $_{-0.02}^{+0.02}$ inch	CRE inch	PDPT inch	for tool holder
GX 16-2 R1.50 N	0.630	0.118	0.059	0.059	GX 16-2
GX 16-3 R2.00 N	0.630	0.157	0.079	0.079	GX 16-3
GX 16-3 R2.50 N	0.630	0.197	0.098	0.098	GX 16-3

674
678
682

P	
M	
K	●
N	●
S	○
H	
O	○

→ v_c Page 77
→ Application recommendation on page 79

Internal machining

External machining

→ 38+39	metric ↓ ↕	→ 36+37	metric ↓ ↕						

ModularClamp MSS – Radial grooving module GX 09/16

- ▲ For circlip grooves ≤ 0.1083 inch
- ▲ For radius grooves up to ≤ 0.0472 inch
- ▲ For external recessing

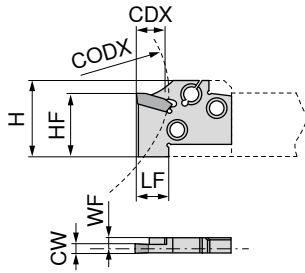

Illustrations show right-hand versions



Designation	CW inch	WF inch	LF inch	HF inch	H inch	CODX inch	CDX inch	for grooving inserts	Left-hand	Right-hand
									70 871 ...	70 870 ...
E12 R/L 02-GX 09-1	<0.077	0.124	0.315	0.472	0.571	1.417	0.079	GX 09-1 ..R/L	112	112
E16 R/L 02-GX 09-1	<0.077	0.124	0.315	0.630	0.768	1.890	0.079	GX 09-1 ..R/L	116	116
E20 R/L 03-GX 16-2	<0.108	0.134	0.512	0.787	0.945	2.362	0.118	GX 16-2 ..R/L	120	120
E25 R/L 03-GX 16-2	<0.108	0.193	0.512	0.984	1.181	2.953	0.118	GX 16-2 ..R/L	125	125
E32 R/L 03-GX 16-2	<0.108	0.193	0.512	1.260	1.496	3.780	0.118	GX 16-2 ..R/L	132	132



→ 28-35	→ 69-71	metric								
---------	---------	--------	--	--	--	--	--	--	--	--

ModularClamp MSS – Radial grooving module GX 09/16

- ▲ For grooving and turning
- ▲ For circlip grooves ≤ 0.2067 inch
- ▲ For radius grooves up to ≤ 0.0984 inch
- ▲ For external recessing

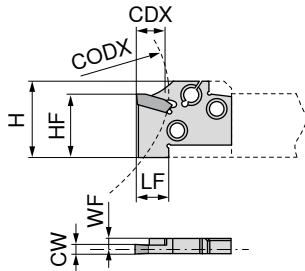

Illustrations show right-hand versions

Designation	CW inch	WF inch	LF inch	HF inch	H inch	CODX inch	CDX inch	for grooving inserts	Left-hand	Right-hand
									70 866 ...	70 865 ...
E12 R/L 07-GX 09-1	0.079 - 0.108	0.124	0.315	0.472	0.571	1.417	0.276	GX 09-1 ..N	012	012
E12 R/L 07-GX 09-2	0.109 - 0.148	0.124	0.315	0.472	0.571	1.417	0.276	GX 09-2 ..N	112	112
E16 R/L 07-GX 09-1	0.079 - 0.108	0.124	0.315	0.630	0.768	1.890	0.276	GX 09-1 ..N	016	016
E16 R/L 07-GX 09-2	0.109 - 0.148	0.124	0.315	0.630	0.768	1.890	0.276	GX 09-2 ..N	116	116
E20 R/L 12-GX 16-1	0.079 - 0.108	0.148	0.512	0.787	0.945	2.362	0.472	GX 16-1 ..N	020	020
E20 R/L 12-GX 16-2	0.109 - 0.148	0.134	0.512	0.787	0.945	2.362	0.472	GX 16-2 ..N	120	120
E20 R/L 12-GX 16-3	0.148 - 0.197	0.115	0.512	0.787	0.945	2.362	0.472	GX 16-3 ..N	220	220
E25 R/L 12-GX 16-1	0.079 - 0.108	0.207	0.512	0.984	1.181	2.953	0.472	GX 16-1 ..N	025	025
E25 R/L 12-GX 16-2	0.109 - 0.148	0.193	0.512	0.984	1.181	2.953	0.472	GX 16-2 ..N	125	125
E25 R/L 12-GX 16-3	0.148 - 0.197	0.174	0.512	0.984	1.181	2.953	0.472	GX 16-3 ..N	225	225
E25 R/L 12-GX 16-4	0.197 - 0.256	0.150	0.512	0.984	1.181	2.953	0.472	GX 16-4 ..N	325	325
E32 R/L 12-GX 16-2	0.109 - 0.148	0.193	0.512	1.260	1.496	3.780	0.472	GX 16-2 ..N	132	132
E32 R/L 12-GX 16-3	0.148 - 0.197	0.174	0.512	1.260	1.496	3.780	0.472	GX 16-3 ..N	232	232
E32 R/L 12-GX 16-4	0.197 - 0.256	0.150	0.512	1.260	1.496	3.780	0.472	GX 16-4 ..N	332	332



→ 28-35	→ 69-71	metric								
---------	---------	--------	--	--	--	--	--	--	--	--

ModularClamp MSS – Radial Grooving module GX 09/16 for Internal machining

- ▲ For circlip grooves ≤ 0.1083 inch
- ▲ For radius grooves up to ≤ 0.0472 inch

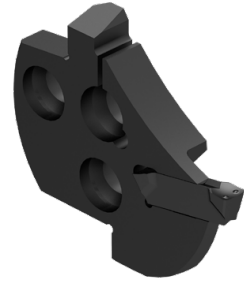
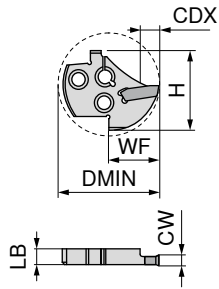

Illustrations show right-hand versions

Designation	CW inch	LB inch	WF inch	H inch	CDX inch	DMIN inch	for grooving inserts	Left-hand	Right-hand
								70 886 ...	70 885 ...
I16 R/L 02-GX 09-1	<0.077	0.150	0.394	0.646	0.079	0.787	GX 09-1 ..R/L	016	016
I20 R/L 02-GX 09-1	<0.077	0.150	0.472	0.799	0.079	0.984	GX 09-1 ..R/L	020	020
I25 R/L 02-GX 09-1	<0.077	0.150	0.610	0.980	0.079	1.260	GX 09-1 ..R/L	025	025
I32 R/L 03-GX 16-2	<0.108	0.232	0.787	1.268	0.118	1.575	GX 16-2 ..R/L	032	032
I40 R/L 03-GX 16-2	<0.108	0.232	0.965	1.559	0.118	1.969	GX 16-2 ..R/L	040	040

i Right hand module → left hand insert only
Left hand module → right hand insert only

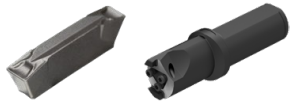

→ 28-35	→ 72								
---------	------	--	--	--	--	--	--	--	--

ModularClamp MSS – Radial Grooving module 09/16 for Internal machining

- ▲ For circlip grooves ≤ 0.2067 inch
- ▲ For radius grooves up to ≤ 0.0984 inch

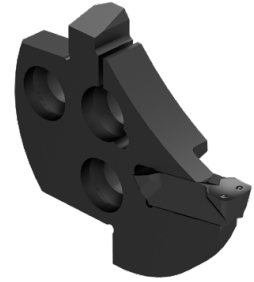
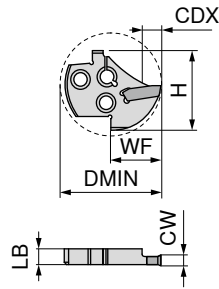

Illustrations show right-hand versions

Designation	CW inch	LB inch	WF inch	H inch	CDX inch	DMIN inch	for grooving inserts	Left-hand	Right-hand
								70 881 ...	70 880 ...
I16 R/L 04-GX 09-1	0.079 - 0.108	0.150	0.394	0.646	0.157	0.787	GX 09-1 ..N	017	017
I16 R/L 04-GX 09-2	0.109 - 0.148	0.150	0.394	0.646	0.157	0.787	GX 09-2 ..N	117	117
I20 R/L 05-GX 09-1	0.079 - 0.108	0.150	0.472	0.799	0.197	0.984	GX 09-1 ..N	021	021
I20 R/L 05-GX 09-2	0.109 - 0.148	0.150	0.472	0.799	0.197	0.984	GX 09-2 ..N	121	121
I25 R/L 06-GX 09-1	0.079 - 0.108	0.150	0.610	0.980	0.236	1.260	GX 09-1 ..N	026	026
I25 R/L 06-GX 09-2	0.109 - 0.148	0.150	0.610	0.980	0.236	1.260	GX 09-2 ..N	126	126
I32 R/L 09-GX 16-1	0.079 - 0.108	0.232	0.787	1.268	0.354	1.575	GX 16-1 ..N	033	033
I32 R/L 09-GX 16-2	0.109 - 0.148	0.232	0.787	1.268	0.354	1.575	GX 16-2 ..N	133	133
I32 R/L 09-GX 16-3	0.148 - 0.197	0.232	0.787	1.268	0.354	1.575	GX 16-3 ..N	233	233
I32 R/L 09-GX 16-4	0.197 - 0.256	0.232	0.787	1.268	0.354	1.575	GX 16-4 ..N	333	333
I40 R/L 10-GX 16-1	0.079 - 0.108	0.232	0.965	1.559	0.394	1.969	GX 16-1 ..N	041	041
I40 R/L 10-GX 16-2	0.109 - 0.148	0.232	0.965	1.559	0.394	1.969	GX 16-2 ..N	141	141
I40 R/L 10-GX 16-3	0.148 - 0.197	0.232	0.965	1.559	0.394	1.969	GX 16-3 ..N	241	241
I40 R/L 10-GX 16-4	0.197 - 0.256	0.232	0.965	1.559	0.394	1.969	GX 16-4 ..N	341	341

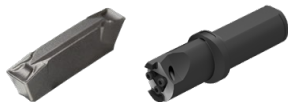

→ 28-35	→ 72								
---------	------	--	--	--	--	--	--	--	--

MonoClamp – Radial Monoholder GX 09

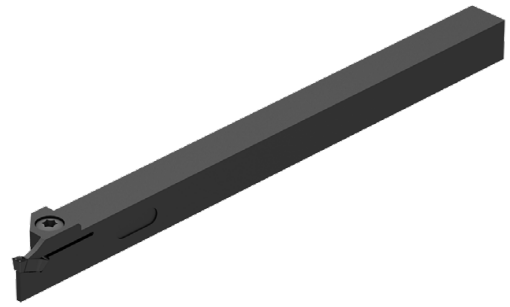
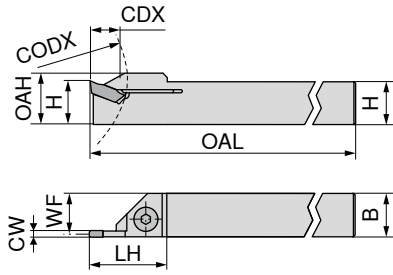

Illustrations show right-hand versions

Designation	H inch	B inch	CW inch	WF inch	OAH inch	OAL inch	LH inch	CODX inch	CDX inch	for grooving inserts GX 09 ..	Left-hand	Right-hand
											78 863 ...	78 862 ...
E10 R/L 00-06-GX09-E	0.375	0.375	0.079 - 0.138	0.349	0.472	6.000	0.709	1.181	0.270		03800	03800



When using "R" or "L" tools the tool must be modified at the end face to ensure cutting clearance.

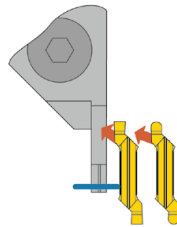

Spare parts
for grooving inserts
GX 09 ..

	80 950 ...	70 950 ...
Screwdriver		
Clamping screw		
T15	113	M4x11
		442



→ 28-34

MonoClamp – Radial Mono-boring bars GX 09

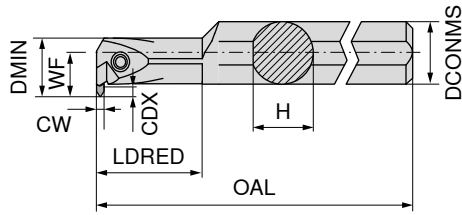

Illustrations show right-hand versions

Designation	H inch	DCONMS inch	DMIN inch	CW inch	CDX inch	WF inch	OAL inch	LDRED inch	for grooving inserts	Left-hand	Right-hand
										78 859 ...	78 858 ...
I12 R/L 90-2.5D-GX09-E	0.600	0.625	0.630	0.079 - 0.148	0.118	0.433	6.000	1.181	GX 09 ..	06300	06300

i Right hand boring bar → left hand insert only
Left hand boring bar → right hand insert only

i When using "R" or "L" tools the insert support seat requires modification to prevent the insert fouling.

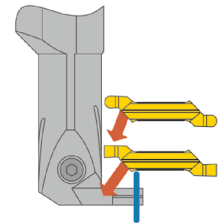

**Spare parts
for grooving inserts**
GX 09 ..

	Screwdriver	Clamping screw
80 950 ...	70 950 ...	
T15	113	M3,5x12,5
		441



→ 28-34

Insert GX 24

- ▲ Insert with ground periphery
- ▲ Suitable also for parting off tubes and thin-walled workpieces

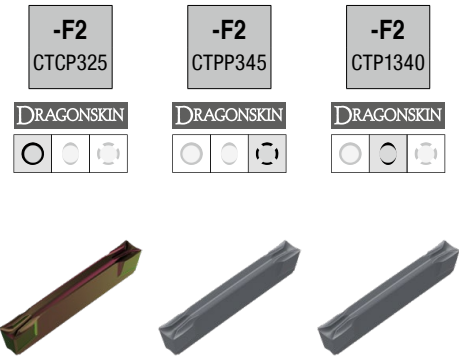
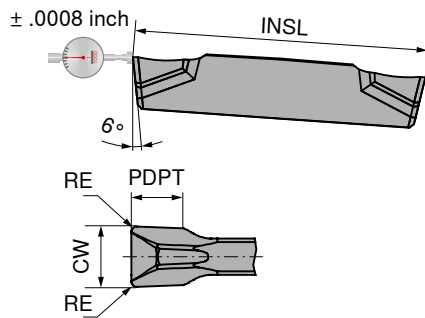
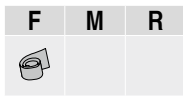
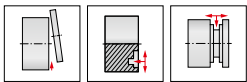

Designation	INSL inch	CW inch	RE inch	PDPT inch	for tool holder	70 350 ...	70 350 ...	70 350 ...
GX 24-2 E3.00 N 0.30	0.945	0.118	0.012	0.098	GX 24-2	962	862	662
GX 24-2 E3.50 N 0.30	0.945	0.138	0.012	0.098	GX 24-2		864	
GX 24-3 E4.00 N 0.40	0.945	0.157	0.016	0.118	GX 24-3	966	866	666
GX 24-3 E5.00 N 0.40	0.945	0.197	0.016	0.138	GX 24-3	970	870	671
GX 24-4 E6.00 N 0.50	0.945	0.236	0.020	0.157	GX 24-4		872	672
P						●	●	●
M						○	●	●
K						●		●
N								○
S						○	○	●
H								
O								○

→ v_c Page 77
→ Application recommendation on page 78

Internal machining

External machining



Insert GX 24

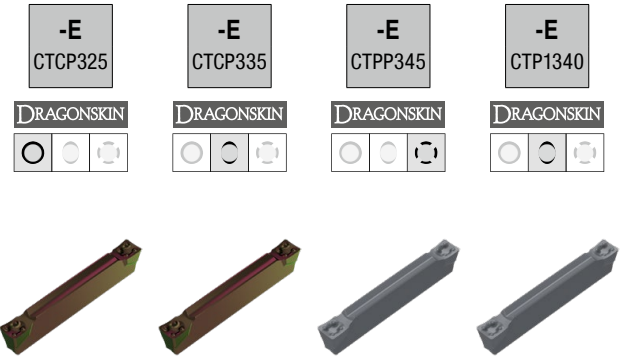
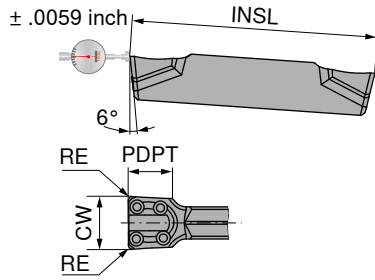
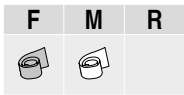
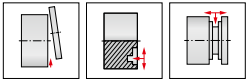

Designation	INSL inch	CW +/-0.05 inch	RE +/-0.05 inch	PDPT inch	for tool holder	70 350 ...		70 350 ...		70 350 ...		70 350 ...	
GX 24-2 E3.00 N 0.30	0.945	0.118	0.012	0.098	GX 24-2	932	532	832	632				
GX 24-3 E4.00 N 0.40	0.945	0.157	0.016	0.118	GX 24-3	936	536	836	636				
GX 24-3 E5.00 N 0.40	0.945	0.197	0.016	0.118	GX 24-3	940	540	840	640				
GX 24-4 E6.00 N 0.50	0.945	0.236	0.020	0.138	GX 24-4	944	544	844	644				
P						●	●	●	●				
M						○	○	●	●				
K						●	●						
N													○
S						○		○	●				
H													
O													○

→ v_c Page 77
→ Application recommendation on page 78

Internal machining

External machining



Insert GX 24

▲ Very good chip control

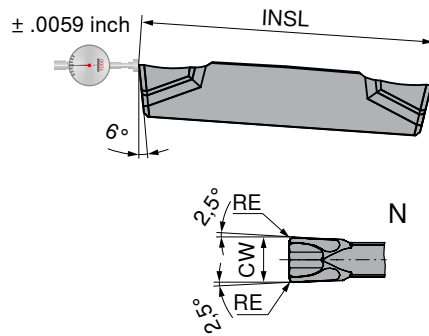
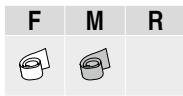

-M1
CTCP325

-M1
CTPP345

-M1
CTP1340



Designation	INSL inch	CW ± 0.05 inch	RE ± 0.05 inch	for tool holder
GX 24-1 E2.00 N 0.20	0.945	0.079	0.008	GX 24-1
GX 24-2 E3.00 N 0.20	0.945	0.118	0.008	GX 24-2
GX 24-3 E4.00 N 0.30	0.945	0.157	0.012	GX 24-3

70 363 ...	70 363 ...	70 363 ...
900	800	600
902	802	602
904	804	604

P	●	●	●
M	○	●	●
K	●	●	●
N	●	●	○
S	○	○	●
H			
O			○

→ v_c Page 77

→ Application recommendation on page 79

Internal machining

External machining



Insert GX 24

▲ Very good chip control

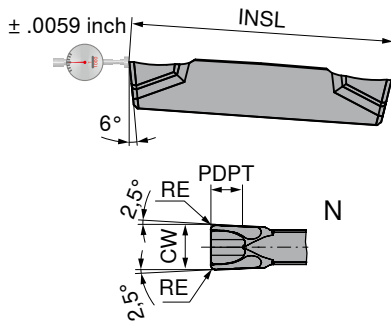
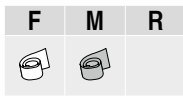
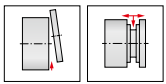

-M40
CTCP325

-M40
CTPP345

-M40
CTP1340



Designation	INSL inch	CW ± _{-0.05} inch	RE ± _{-0.05} inch	PDPT inch	for tool holder	70 364 ...		
						900	800	600
GX 24-2 E3.00 N 0.30	0.945	0.118	0.012	0.138	GX 24-2	900	800	600
GX 24-3 E4.00 N 0.40	0.945	0.157	0.016	0.157	GX 24-3	902	802	602
GX 24-3 E5.00 N 0.40	0.945	0.197	0.016	0.157	GX 24-3	904	804	604
GX 24-4 E6.00 N 0.50	0.945	0.236	0.020	0.157	GX 24-4	906	806	606
P						●	●	●
M						○	●	●
K						●	●	●
N								○
S						○	○	●
H								
O								○

→ v_c Page 77

→ Application recommendation on page 78

5

Internal machining

External machining



Radius groove insert GX 24

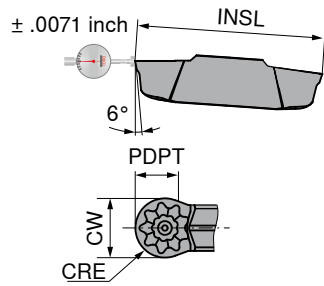
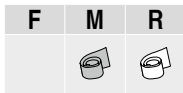
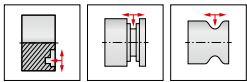

Designation	INSL inch	CW ± 0.05 inch	CRE inch	PDPT inch	for tool holder	70 354 ...	
GX 24-2 R1.50 N	0.961	0.118	0.059	0.059	GX 24-2	952	552
GX 24-3 R2.00 N	0.961	0.157	0.079	0.098	GX 24-3	954	554
GX 24-3 R2.50 N	0.961	0.197	0.098	0.118	GX 24-3	956	556
GX 24-4 R3.00 N	0.961	0.236	0.118	0.157	GX 24-4	958	558
P						●	●
M						○	○
K						●	●
N							
S						○	
H							
O							

→ v_c Page 77

→ Application recommendation on page 79

Internal machining

External machining



Insert GX 24

- ▲ Insert with highly positive cutting edge geometry and sharp cutting edge, polished chip breaker
- ▲ ground periphery

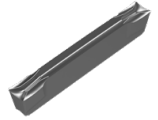
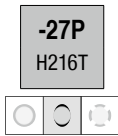
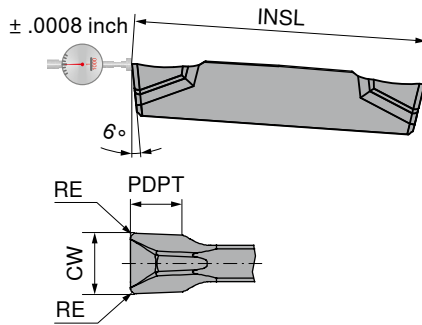
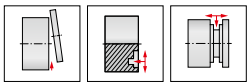

70 350 ...

Designation	INSL inch	CW inch	RE inch	PDPT inch	for tool holder	
GX 24-2 E3.00 N 0.30	0.945	0.118	0.012	0.098	GX 24-2	682
GX 24-3 E4.00 N 0.40	0.945	0.157	0.016	0.118	GX 24-3	684
GX 24-3 E5.00 N 0.40	0.945	0.197	0.016	0.138	GX 24-3	686
GX 24-4 E6.00 N 0.50	0.945	0.236	0.020	0.157	GX 24-4	688

P	
M	
K	●
N	●
S	○
H	
O	○

→ v_c Page 77
→ Application recommendation on page 78

5

Internal machining

External machining



Radius grooving insert GX 24

- ▲ Insert with highly positive cutting edge geometry and sharp cutting edge, polished chip breaker
- ▲ ground periphery

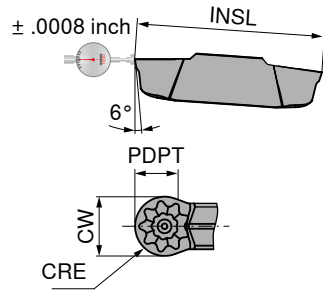
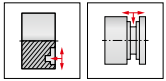

-27PF
H216T



70 353 ...

Designation	INSL inch	CW ± 0.02 inch	CRE inch	PDPT inch	for tool holder	
GX 24-4 R3.00 N	1.000	0.236	0.118	0.157	GX 24-4	500
GX 24-5 R4.00 N	1.000	0.315	0.157	0.197	GX 24-5	506

P	
M	
K	●
N	●
S	○
H	
O	○

→ v_c Page 77
→ Application recommendation on page 79

Internal machining

External machining



ModularClamp MSS – Radial grooving module GX 24

- ▲ For deep radial parting and grooving
- ▲ For turning

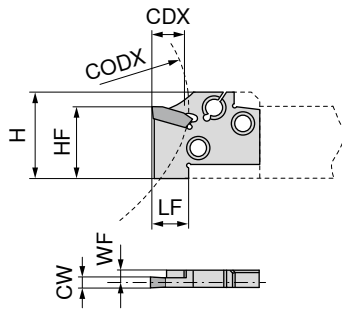

Illustrations show right-hand versions

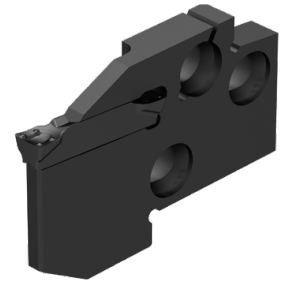

Designation	CW inch	WF inch	LF inch	HF inch	H inch	CODX inch	CDX inch	for grooving inserts	Left-hand	Right-hand
									70 868 ...	70 867 ...
E20 R/L 21-GX 24-1	0.079 - 0.108	0.152	0.866	0.787	0.945	2.362	0.827	GX 24-1	020	020
E20 R/L 21-GX 24-2	0.118	0.134	0.866	0.787	0.945	2.362	0.827	GX 24-2	120	120
E20 R/L 21-GX 24-3	0.157/0.197	0.118	0.866	0.787	0.945	1.181	0.827	GX 24-3	22000	22000
E25 R/L 21-GX 24-1	0.079 - 0.108	0.201	0.866	0.984	1.181	2.953	0.827	GX 24-1	025	025
E25 R/L 21-GX 24-2	0.118	0.193	0.866	0.984	1.181	2.953	0.827	GX 24-2	125	125
E25 R/L 21-GX 24-3	0.157/0.197	0.174	0.866	0.984	1.181	2.953	0.827	GX 24-3	225	225
E25 R/L 21-GX 24-4	0.236	0.150	0.866	0.984	1.181	2.953	0.827	GX 24-4	325	325
E25 R/L 21-GX 24-5	0.315	0.116	0.866	0.984	1.181	2.953	0.827	GX 24-5	425	425
E32 R 21-GX 24-2	0.118	0.195	0.866	1.260	1.496	1.890	0.827	GX 24-2		13200
E32 R/L 21-GX 24-3	0.157/0.197	0.174	0.866	1.260	1.496	3.780	0.827	GX 24-3	232	232
E32 R/L 21-GX 24-4	0.236	0.150	0.866	1.260	1.496	3.780	0.827	GX 24-4	332	332



→ 42-48	→ 69-71	metric								
---------	---------	--------	--	--	--	--	--	--	--	--

ModularClamp MSS – Radial Grooving module GX 24 for Internal machining

▲ for grooving and turning

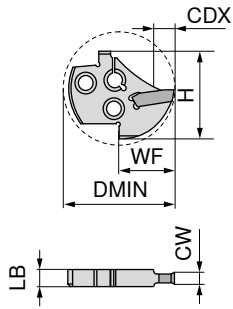

Neutral

70 880 ...

Designation	CW inch	LB inch	WF inch	H inch	CDX inch	DMIN inch	for grooving inserts	
I40 N 19-GX 24-2	0.109 - 0.148	0.244	1.319	1.602	0.748	2.362	GX 24-2 ..N	340
I40 N 19-GX 24-3	0.148 - 0.197	0.244	1.319	1.602	0.748	2.362	GX 24-3 ..N	440
I40 N 19-GX 24-4	0.197 - 0.256	0.244	1.319	1.602	0.748	2.362	GX 24-4 ..N	540

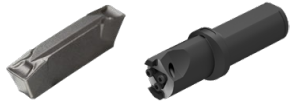

→ 42-48

→ 72

ModularClamp MSS – Axial grooving module GX 24 short

- ▲ For axial grooving
- ▲ For face turning

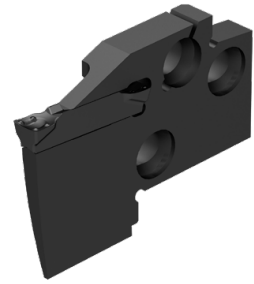
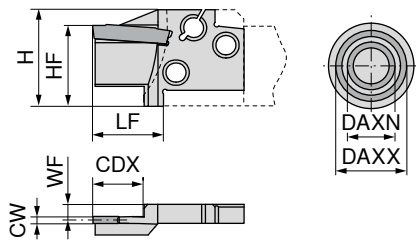

Illustrations show right-hand versions

Designation	DAXN inch	DAXX inch	CW inch	WF inch	LF inch	HF inch	H inch	CDX inch	for grooving inserts	Left-hand	Right-hand
										70 891 ...	70 890 ...
E20 R/L 14-GX 24-2 A	1.969	2.756	0.118	0.134	0.866	0.787	0.945	0.551	GX 24-2	100	100
E20 R/L 14-GX 24-2 A	2.756	3.937	0.118	0.134	0.866	0.787	0.945	0.551	GX 24-2	102	102
E20 R/L 14-GX 24-2 A	3.937	5.906	0.118	0.134	0.866	0.787	0.945	0.551	GX 24-2	104	104
E25 R/L 15-GX 24-2 A	1.969	2.756	0.118	0.193	0.866	0.984	1.181	0.591	GX 24-2	200	200
E25 R/L 15-GX 24-2 A	2.756	3.937	0.118	0.193	0.866	0.984	1.181	0.591	GX 24-2	202	202
E25 R/L 15-GX 24-2 A	3.937	5.906	0.118	0.193	0.866	0.984	1.181	0.591	GX 24-2	204	204
E25 R/L 15-GX 24-3 A	1.969	2.756	0.157/0.197	0.174	0.866	0.984	1.181	0.591	GX 24-3	206	206
E25 R/L 15-GX 24-3 A	2.756	3.937	0.157/0.197	0.174	0.866	0.984	1.181	0.591	GX 24-3	208	208
E25 R/L 15-GX 24-3 A	3.937	5.906	0.157/0.197	0.174	0.866	0.984	1.181	0.591	GX 24-3	210	210
E25 R/L 15-GX 24-3 A	5.906	11.811	0.157/0.197	0.174	0.866	0.984	1.181	0.591	GX 24-3	212	212
E25 R/L 15-GX 24-4 A	1.969	2.756	0.236	0.150	0.866	0.984	1.181	0.591	GX 24-4	214	214
E25 R/L 15-GX 24-4 A	2.756	3.937	0.236	0.150	0.866	0.984	1.181	0.591	GX 24-4	216	216
E25 R/L 15-GX 24-4 A	3.937	5.906	0.236	0.150	0.866	0.984	1.181	0.591	GX 24-4	218	218
E25 R/L 15-GX 24-4 A	5.906	11.811	0.236	0.150	0.866	0.984	1.181	0.591	GX 24-4	220	220
E32 R/L 15-GX 24-3 A	2.756	3.937	0.157/0.197	0.174	0.866	1.260	1.496	0.591	GX 24-3	300	300
E32 R/L 15-GX 24-3 A	3.937	5.906	0.157/0.197	0.174	0.866	1.260	1.496	0.591	GX 24-3	302	302
E32 R/L 15-GX 24-3 A	5.906	11.811	0.157/0.197	0.174	0.866	1.260	1.496	0.591	GX 24-3	304	304
E32 R/L 15-GX 24-4 A	2.756	3.937	0.236	0.150	0.866	1.260	1.496	0.591	GX 24-4	306	306
E32 R/L 15-GX 24-4 A	3.937	5.906	0.236	0.150	0.866	1.260	1.496	0.591	GX 24-4	308	308
E32 R/L 15-GX 24-4 A	5.906	11.811	0.236	0.150	0.866	1.260	1.496	0.591	GX 24-4	310	310
E32 R/L 15-GX 24-4 A	11.811	35.433	0.236	0.150	0.866	1.260	1.496	0.591	GX 24-4	312	312



→ 42-48	→ 69-71	metric								
---------	---------	--------	--	--	--	--	--	--	--	--

ModularClamp MSS – Axial grooving module GX 24 long

- ▲ For axial grooving
- ▲ For face turning

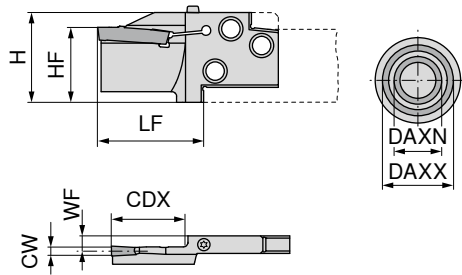

Illustrations show right-hand versions

Designation	DAXN inch	DAXX inch	CW inch	WF inch	LF inch	HF inch	H inch	CDX inch	for grooving inserts	Left-hand	Right-hand
										70 895 ...	70 894 ...
E25 R/L 21-GX 24-3 AS	1.969	2.756	0.157/0.197	0.178	1.378	0.984	1.181	0.827	GX 24-3	200	200
E25 R/L 21-GX 24-3 AS	2.756	3.937	0.157/0.197	0.178	1.378	0.984	1.181	0.827	GX 24-3	202	202
E25 R/L 21-GX 24-3 AS	3.937	5.906	0.157/0.197	0.178	1.378	0.984	1.181	0.827	GX 24-3	204	204
E25 R/L 21-GX 24-3 AS	5.906	11.811	0.157/0.197	0.178	1.378	0.984	1.181	0.827	GX 24-3	206	206
E25 R/L 25-GX 24-4 AS	1.969	2.756	0.236	0.154	1.378	0.984	1.181	0.984	GX 24-4	210	210
E25 R/L 25-GX 24-4 AS	2.756	3.937	0.236	0.154	1.378	0.984	1.181	0.984	GX 24-4	212	212
E25 R/L 25-GX 24-4 AS	3.937	5.906	0.236	0.154	1.378	0.984	1.181	0.984	GX 24-4	214	214
E25 R/L 25-GX 24-4 AS	5.906	11.811	0.236	0.154	1.378	0.984	1.181	0.984	GX 24-4	216	216

 Axial modules version „GX 24 long“ can be clamped on both sides.

Spare parts for grooving inserts			Screwdriver	Clamping screw
			80 950 ...	70 950 ...
GX 24-3	T15	113	M3,5x14	160
GX 24-4	T15	113	M3,5x14	160



→ 42-48	→ 69-71	metric						
---------	---------	--------	--	--	--	--	--	--

MonoClamp – Radial Blade GX 24

Scope of supply:

Blade incl. clamping screw and tightening wrench

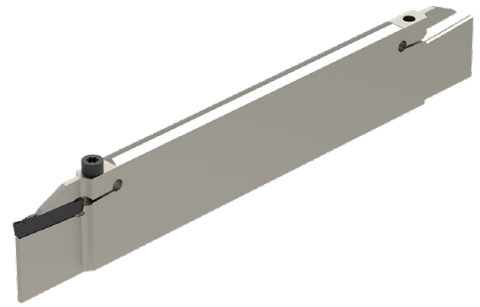
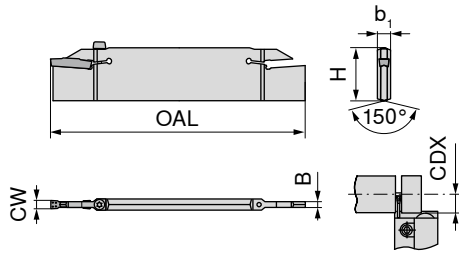

70 834 ...

Designation	CW inch	H inch	B inch	b ₁ inch	OAL inch	CDX inch	for grooving inserts	
XLCF N 3203-GX24-1S	0.079	1.260	0.041	0.244	7.087	0.827	GX 24-1	102
XLCF N 3203-GX24-2S	0.118	1.260	0.083	0.244	7.087	0.827	GX 24-2	103
XLCF N 3204-GX24-3S	0.157/0.197	1.260	0.120	0.244	7.087	0.827	GX 24-3	104
XLCF N 3206-GX24-4S	0.236	1.260	0.165	0.244	7.087	0.827	GX 24-4	106

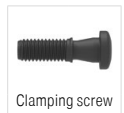
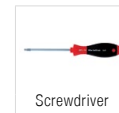

80 950 ...

70 950 ...

Spare parts for grooving inserts

GX 24-1	T15	113	M3,5x14	160
GX 24-2	T15	113	M3,5x14	160
GX 24-3	T15	113	M3,5x14	160
GX 24-4	T15	113	M3,5x14	160



→ 42-48	→ 74+75	metric						
---------	---------	--------	--	--	--	--	--	--

MonoClamp – Radial Monoholder GX 24

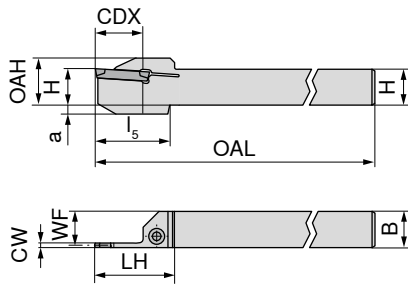

Illustrations show right-hand versions

Designation	H inch	B inch	CW inch	WF inch	OAH inch	OAL inch	LH inch	l ₅ inch	CDX inch	a inch	for grooving inserts	Left-hand	Right-hand
												78 863 ...	78 862 ...
E 16 R/L 0021-10C-GX24-2-E	0.625	0.625	0.109 - 0.148	0.586	0.822	5.000	1.378	1.260	0.827	0.162	GX 24-2	26300	26300
E 20 R/L 0021-12C-GX24-2-E	0.750	0.750	0.109 - 0.148	0.711	0.947	5.000	1.378		0.827		GX 24-2	27500	27500
E 20 R/L 0021-12C-GX24-3-E	0.750	0.750	0.148 - 0.197	0.692	0.947	5.000	1.378		0.827		GX 24-3	37500	37500
E 25 R/L 0021-16D-GX24-2-E	1.000	1.000	0.109 - 0.148	0.961	1.197	6.000	1.378		0.827		GX 24-2	20000	20000
E 25 R/L 0021-16D-GX24-3-E	1.000	1.000	0.148 - 0.197	0.942	1.197	6.000	1.378		0.827		GX 24-3	30000	30000
E 25 R/L 0021-16D-GX24-4-E	1.000	1.000	0.197 - 0.256	0.917	1.197	6.000	1.378		0.827		GX 24-4	40000	40000
E 32 R/L 0021-85D-GX24-2-E	1.250	1.000	0.109 - 0.148	0.961	1.447	6.000	1.378		0.827		GX 24-2	22500	22500
E 32 R/L 0021-85D-GX24-3-E	1.250	1.000	0.148 - 0.197	0.942	1.447	6.000	1.378		0.827		GX 24-3	32500	32500
E 32 R/L 0021-85D-GX24-4-E	1.250	1.000	0.197 - 0.256	0.917	1.447	6.000	1.378		0.827		GX 24-4	42500	42500

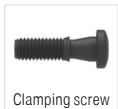

Spare parts for grooving inserts

		80 950 ...	70 950 ...
GX 24-2	T20	114	204
GX 24-3	T20	114	204
GX 24-4	T20	114	204



→ 42-48

Insert LX

- ▲ Grooving width 0.315 and 0.394 inch
- ▲ Axial grooving from Ø 19.7 inch onwards
- ▲ Internal grooving and turning, from Ø 7.9 inch onwards

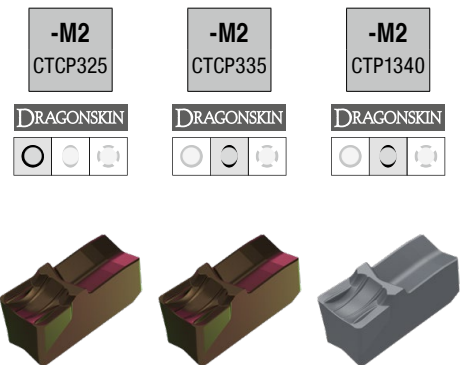
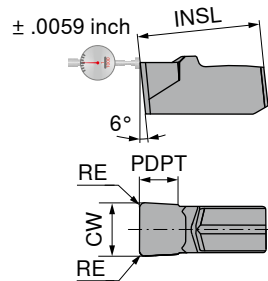
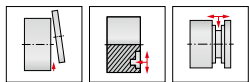

Designation	INSL inch	CW _{-/+0.08} inch	RE _{-/+0.1} inch	PDPT inch	for tool holder	70 337 ...		
						928	578	682
LXE 8.00N0.80-M2	0.748	0.315	0.031	0.197	E32 N ..-LX	928	578	682
LXE 10.00N0.80-M2	0.748	0.394	0.031	0.197	E32 N ..-LX	932	582	678
P						●	●	●
M						○	○	●
K						●	●	●
N								○
S						○		●
H								
O								○

→ v_c Page 77
→ Application recommendation on page 82

Internal machining

External machining

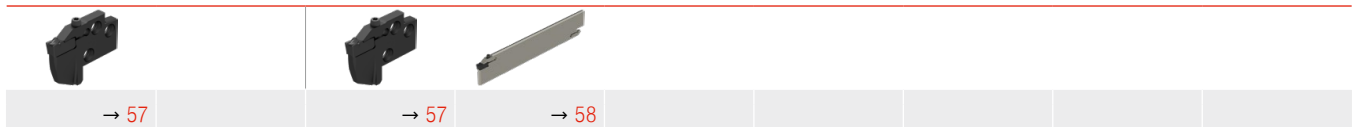

Radial Grooving Insert LX

- ▲ Grooving width 0.315 inch
- ▲ Axial grooving from \varnothing 19.7 inch
- ▲ Internal grooving and turning, from \varnothing 7.9 inch

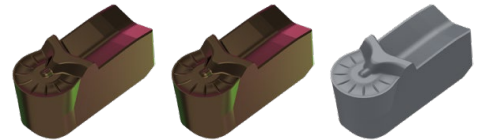
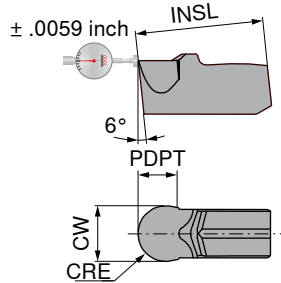
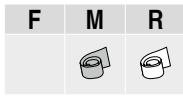
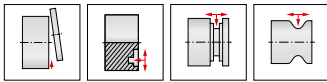

Designation	INSL inch	CW _r ^{+0.08} inch	CRE inch	PDPT inch	for tool holder E32 N ..LX	70 337 ...	70 337 ...	70 337 ...
						908	518	618
P						●	●	●
M						○	○	●
K						●	●	●
N								○
S						○		●
H								
O								○

→ v_c Page 77
→ Application recommendation on page 82

Internal machining

External machining

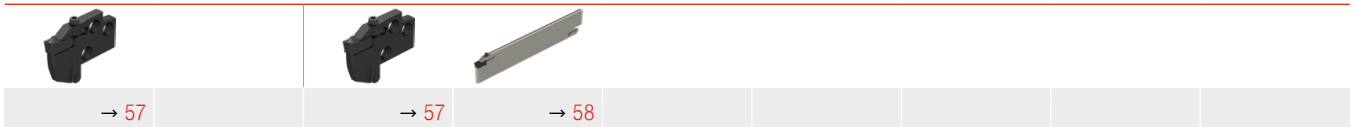

ModularClamp MSS – Axial and radial grooving module LX

- ▲ Grooving width 0.315 and 0.94 inch
- ▲ Axial grooving from Ø 19.7 inch onwards
- ▲ Internal grooving and turning, from Ø 7.9 inch onwards

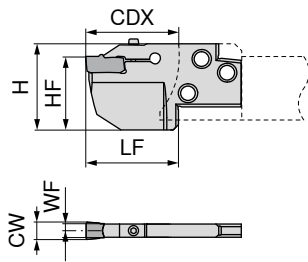

Neutral

70 835 ...

Designation	CW inch	WF inch	LF inch	HF inch	H inch	CDX (1) inch	CDX (2) inch	CDX (3) inch	for grooving inserts	
E32 N 25-LX	0.315/0.394	0.134	1.063	1.260	1.732	0.984	0.748	0.551	LX ..	032
E32 N 32-LX	0.315/0.394	0.134	1.457	1.260	1.732	1.260	1.024	0.827	LX ..	132
E32 N 45-LX	0.315/0.394	0.134	1.850	1.260	1.732	1.772	1.535	1.339	LX ..	232

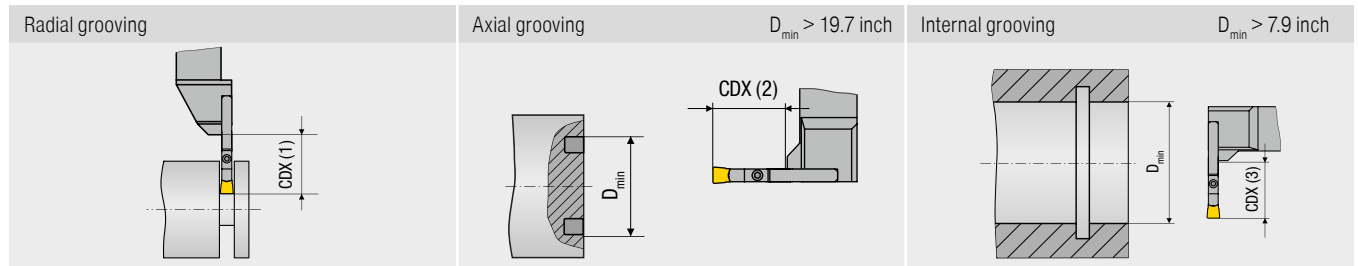

5



Screwdriver



Clamping screw

80 950 ...

70 950 ...

Spare parts for grooving inserts

LX ..	T20	114	M4x18	204
-------	-----	-----	-------	-----

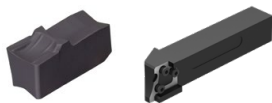

→ 55+56

→ 69-71

MonoClamp – Blade LX

Scope of supply:

Blade incl. clamping screw and tightening wrench

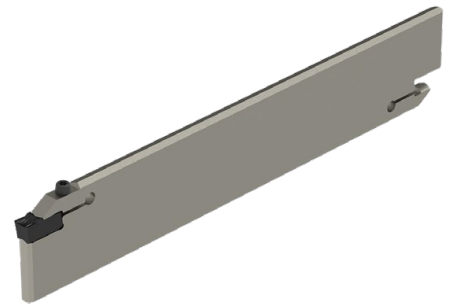
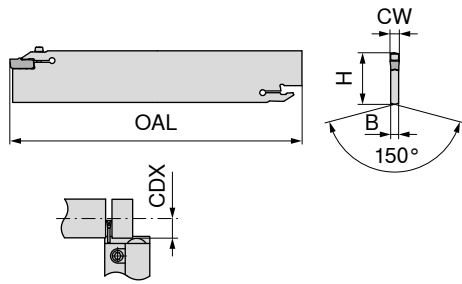

70 833 ...

Designation	H inch	B inch	OAL inch	CW inch	CDX inch	for grooving inserts
XLCEN 4608-LX	1.811	0.268	9.843	0.315/0.394	3.150	LX..

108



Screwdriver

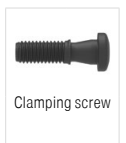

Clamping screw

80 950 ...

70 950 ...

**Spare parts
for grooving inserts**

LX ..

T20

114

M4x18

204



→ 55+56

→ 74+75



Grooving insert AX

- ▲ very good chip control
- ▲ DAXN minimum groove diameter refers to the outside diameter

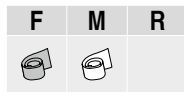

-F50
CTP1340

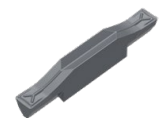
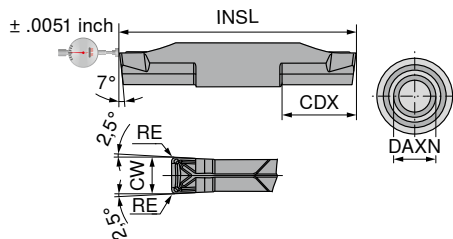

70 327 ...

Designation	IH inch	INSL inch	CW ± 0.02 inch	RE ± 0.05 inch	CDX inch	DAXN inch	for tool holder
AX 05 E3.00 N 0.30	N	0.945	0.118	0.012	0.197	0.394	E.. R/L..-AX 05
AX 10 E3.00 N 0.30	N	1.339	0.118	0.012	0.394	0.787	E.. R/L..-AX 10
AX 15 E3.00 N 0.30	N	1.732	0.118	0.012	0.591	1.181	E.. R/L..-AX 15

005
010
015

P	●
M	●
K	●
N	○
S	●
H	
O	○

→ v_c Page 77

→ Application recommendation on page 83

5

Internal machining

External machining



ModularClamp MSS – Axial grooving module AX

▲ for axial grooving and turning

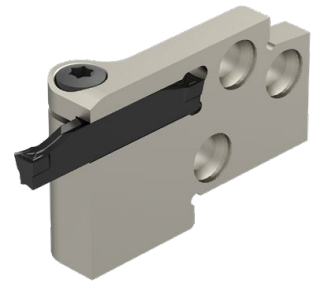
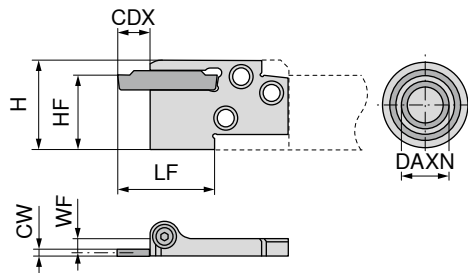

Illustrations show right-hand versions

Designation	HF inch	CW inch	WF inch	LF inch	H inch	DAXN inch	CDX inch	for grooving inserts	Left-hand	Right-hand
									70 827 ...	70 828 ...
E16 R/L 05-AX 05	0.630	0.118	0.098	0.945	0.807	0.394	0.197	AX05	016	016
E20 R/L 05-AX 05	0.787	0.118	0.122	1.102	0.984	0.394	0.197	AX05	020	020
E25 R/L 05-AX 05	0.984	0.118	0.181	1.083	1.181	0.394	0.197	AX05	025	025
E20 R/L 10-AX 10	0.787	0.118	0.122	1.299	0.984	0.787	0.394	AX10	120	120
E25 R/L 10-AX 10	0.984	0.118	0.181	1.280	1.181	0.787	0.394	AX10	125	125
E20 R/L 15-AX 15	0.787	0.118	0.122	1.732	0.984	1.181	0.591	AX15	220	220
E25 R/L 15-AX 15	0.984	0.118	0.181	1.713	1.181	1.181	0.591	AX15	225	225

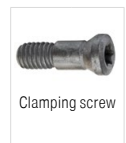

Spare parts for Article no.

Article no.	80 950 ...	70 950 ...	
70 827 016 / 70 828 016	T15	113 M3,5x12,5	441
70 827 020 / 70 828 020	T15	113 M4x14	403
70 827 025 / 70 828 025	T20	114 M5x18	404
70 827 120 / 70 828 120	T15	113 M4x14	403
70 827 125 / 70 828 125	T20	114 M5x18	404
70 827 220 / 70 828 220	T15	113 M4x14	403
70 827 225 / 70 828 225	T20	114 M5x18	404



→ 59	→ 69-71	metric						
------	---------	--------	--	--	--	--	--	--

Threading inserts TC full profile – External thread ISO 60°

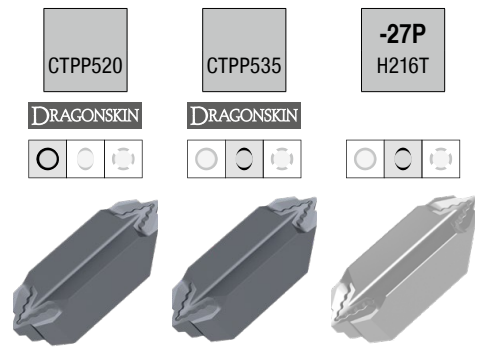
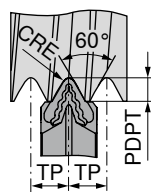
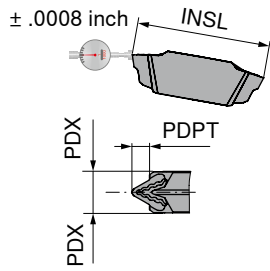

Designation	Size	TP mm	INSL inch	PDPT inch	PDX inch	CRE inch	for tool holder
TC 16-1 E 0.5 ISO	TC 16-1 ...	0.50	0.630	0.013	0.041	0.002	E.. R/L TC 16-1
TC 16-1 E 0.75 ISO	TC 16-1 ...	0.75	0.630	0.019	0.041	0.004	E.. R/L TC 16-1
TC 16-1 E 1.0 ISO	TC 16-1 ...	1.00	0.630	0.025	0.041	0.005	E.. R/L TC 16-1
TC 16-1 E 1.25 ISO	TC 16-1 ...	1.25	0.630	0.031	0.041	0.006	E.. R/L TC 16-1
TC 16-1 E 1.5 ISO	TC 16-1 ...	1.50	0.630	0.037	0.041	0.007	E.. R/L TC 16-1
TC 16-2 E 1.75 ISO	TC 16-2 ...	1.75	0.630	0.043	0.085	0.009	E.. R/L/N TC 16-2
TC 16-2 E 2.0 ISO	TC 16-2 ...	2.00	0.630	0.050	0.085	0.010	E.. R/L/N TC 16-2
TC 16-2 E 2.5 ISO	TC 16-2 ...	2.50	0.630	0.062	0.085	0.013	E.. R/L/N TC 16-2
TC 16-2 E 3.0 ISO	TC 16-2 ...	3.00	0.630	0.074	0.085	0.015	E.. R/L/N TC 16-2
TC 16-3 E 3.5 ISO	TC 16-3 ...	3.50	0.630	0.087	0.122	0.017	E25 N TC 16-3
TC 16-3 E 4.0 ISO	TC 16-3 ...	4.00	0.630	0.100	0.122	0.020	E25 N TC 16-3
TC 16-3 E 5.0 ISO	TC 16-3 ...	5.00	0.630	0.124	0.122	0.025	E25 N TC 16-3

70 357 ...	70 357 ...	70 357 ...
010	110	610
012	112	612
014	114	614
016	116	616
018	118	618
030	130	630
032	132	632
034	134	634
036	136	636
050	150	
052	152	
056	156	

P	●	●	
M	●	●	
K	●	●	●
N			●
S	○	●	
H	○		
O			○

→ v_c Page 77

→ Application recommendation on page 84

Internal machining

External machining

			→ 66	→ 67			

Threading inserts TC full profile – Internal thread ISO 60°

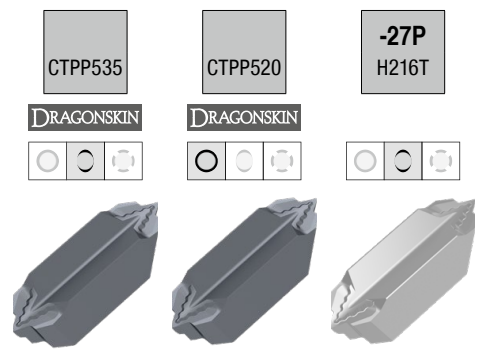
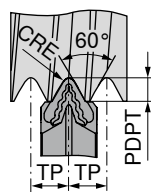
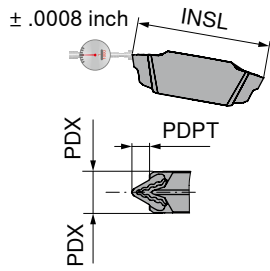

Designation	Size	TP mm	INSL inch	PDPT inch	PDX inch	CRE inch	for tool holder
TC 16-1 1.0 ISO	TC 16-1 ...	1.00	0.630	0.023	0.041	0.002	I32 R/L TC 16-1
TC 16-1 1.25 ISO	TC 16-1 ...	1.25	0.630	0.029	0.041	0.003	I32 R/L TC 16-1
TC 16-1 1.5 ISO	TC 16-1 ...	1.50	0.630	0.035	0.041	0.004	I32 R/L TC 16-1
TC 16-2 1.75 ISO	TC 16-2 ...	1.75	0.630	0.040	0.085	0.004	I32 R/L TC 16-2
TC 16-2 2.0 ISO	TC 16-2 ...	2.00	0.630	0.046	0.085	0.005	I32 R/L TC 16-2
TC 16-2 3.0 ISO	TC 16-2 ...	3.00	0.630	0.069	0.085	0.007	I32 R/L TC 16-2

70 358 ...	70 358 ...	70 358 ...
114	014	614
118	018	618
	030	
132	032	632
136	036	636

P	●	●	
M	●	●	
K	●	●	●
N			●
S	●	○	
H		○	
O			○

→ v_c Page 77
→ Application recommendation on page 84

Internal machining

External machining

→ 68	metric								

Threading inserts TC partial profile 60°

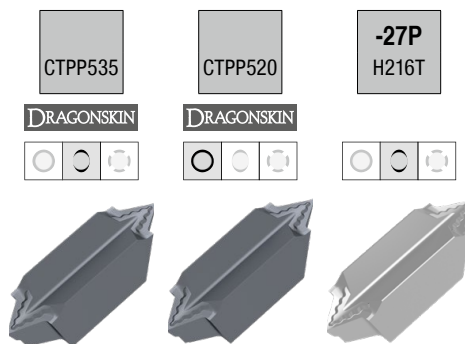
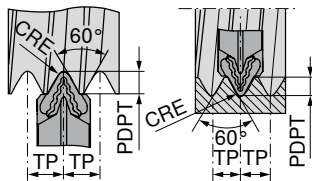
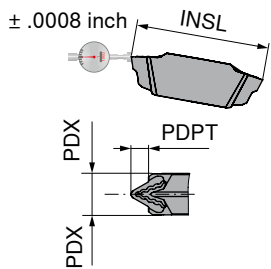

Designation	Size	TP mm	INSL inch	PDPT inch	PDX inch	CRE inch	for tool holder	70 355 ...	70 355 ...	70 355 ...
TC 16-1 EI A 60	TC 16-1 ...	0,5 - 1,5	0.630	0.050	0.041	0.001	E/l. R/L TC 16-1	110	010	610
TC 16-2 EI G 60	TC 16-2 ...	1,75 - 3,0	0.630	0.098	0.085	0.004	E/l. R/L/N TC 16-2	130	030	630
TC 16-2 EI AG 60	TC 16-2 ...	0,5 - 3,0	0.630	0.101	0.085	0.001	E/l. R/L/N TC 16-2	132	032	632
TC 16-3 EI N 60	TC 16-3 ...	3,5 - 5,0	0.630	0.162	0.122	0.009	E/l.. N TC 16-3	150	050	650
P								●	●	
M								●	●	
K								●	●	●
N										●
S								●	○	
H									○	
O										○

→ v_c Page 77

→ Application recommendation on page 84

Internal machining

External machining

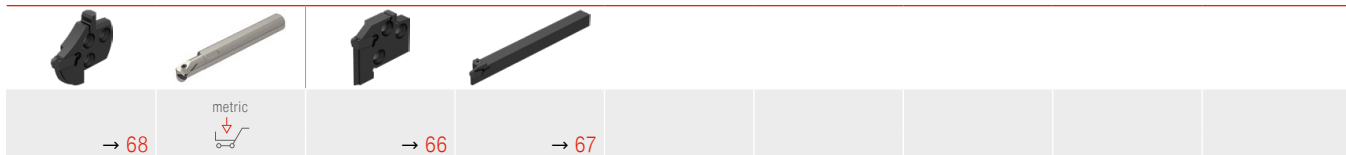

Threading inserts TC full profile Whitworth 55°

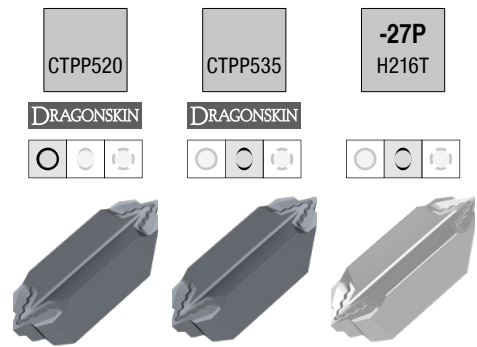
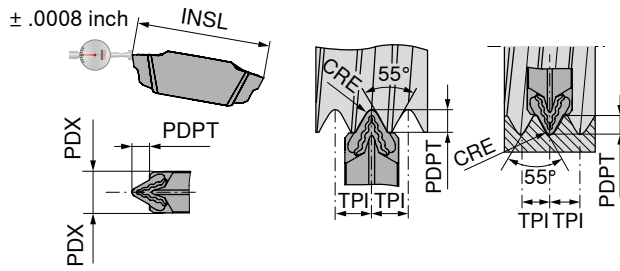
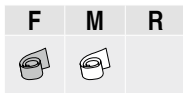

Designation	Size	TPI 1/"	INSL inch	PDPT inch	PDX inch	CRE inch	for tool holder	70 359 ...	70 359 ...	70 359 ...
TC 16-1 EI 28 W	TC 16-1 ...	28	0.630	0.024	0.041	0.005	E/l.. R/L TC 16-1	010	110	
TC 16-1 EI 20 W	TC 16-1 ...	20	0.630	0.033	0.041	0.007	E/l.. R/L TC 16-1	016		
TC 16-1 EI 19 W	TC 16-1 ...	19	0.630	0.035	0.041	0.007	E/l.. R/L TC 16-1	018	118	618
TC 16-1 EI 16 W	TC 16-1 ...	16	0.630	0.041	0.041	0.008	E/l.. R/L TC 16-1	022		
TC 16-2 EI 14 W	TC 16-2 ...	14	0.630	0.047	0.085	0.009	E/l.. R/L/N TC 16-2	030	130	630
TC 16-2 EI 12 W	TC 16-2 ...	12	0.630	0.055	0.085	0.011	E/l.. R/L/N TC 16-2		132	
TC 16-2 EI 11 W	TC 16-2 ...	11	0.630	0.060	0.085	0.012	E/l.. R/L/N TC 16-2	034	134	634
P								●	●	
M								●	●	
K								●	●	●
N										●
S								○	●	
H								○		
O										○

→ v_c Page 77
→ Application recommendation on page 84

Internal machining

External machining

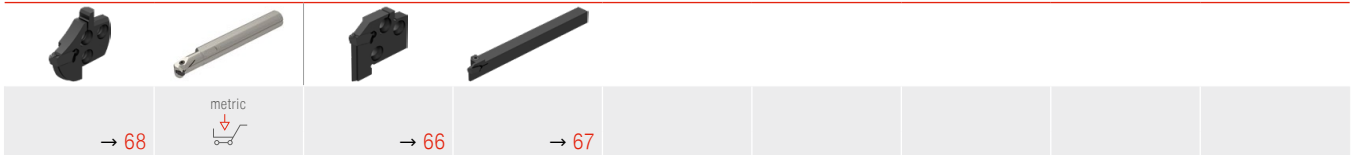

Threading inserts TC partial profile 55°

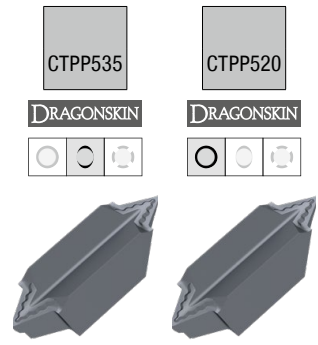
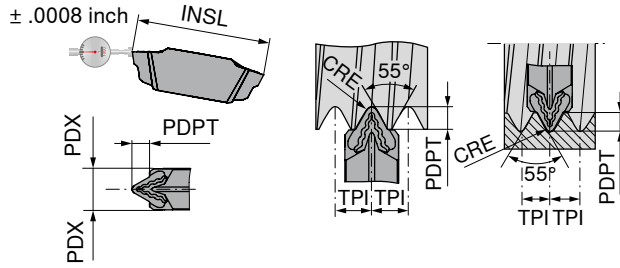

Designation	Size	TPI 1/"	INSL inch	PDPT inch	PDX inch	CRE inch	for tool holder	70 356 ...	70 356 ...
TC 16-1 EI A 55	TC 16-1 ...	28 - 16	0.630	0.055	0.041	0.005	E/l.. R/L TC 16-1	110	010
TC 16-2 EI AG 55	TC 16-2 ...	28 - 8	0.630	0.115	0.085	0.005	E/l.. R/L/N TC 16-2	132	032
TC 16-2 EI G 55	TC 16-2 ...	14 - 8	0.630	0.109	0.085	0.009	E/l.. R/L/N TC 16-2	130	030
TC 16-3 EI N 55	TC 16-3 ...	7 - 5	0.630	0.171	0.122	0.018	E/l.. N TC 16-3	150	050
P								●	●
M								●	●
K								●	●
N									
S								●	○
H									○
O									

→ v_c Page 77
→ Application recommendation on page 84

Internal machining

External machining

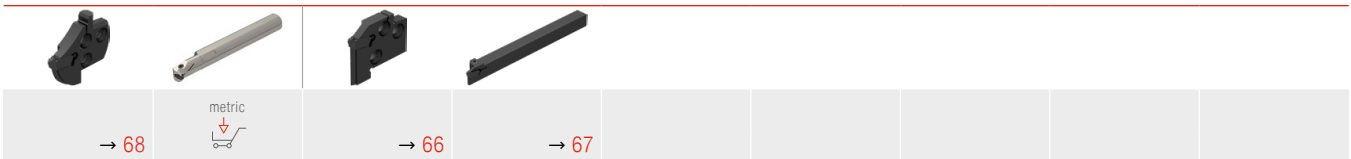

ModularClamp MSS – Threading module TC for external threads

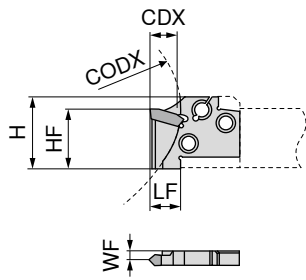

Illustrations show right-hand versions

Designation	TP inch	TPI 1/"	WF inch	HF inch	LF inch	H inch	CODX inch	CDX inch	for grooving inserts	Left-hand	Neutral	Right-hand
										70 872 ...	70 872 ...	70 872 ...
E20 R/L TC 16-1	0.020 - 0.059	28 - 16	0.136	0.512	0.787	0.945	2.362	0.315	TC 16-1 ...	120		020
E20 N TC 16-2	0.069 - 0.118	14 - 8	0.087	0.512	0.787	0.945		0.472	TC 16-2 ...		220	
E25 R/L TC 16-1	0.020 - 0.059	28 - 16	0.205	0.512	0.984	1.181	2.953	0.315	TC 16-1 ...	125		025
E25 R/L TC 16-2	0.069 - 0.118	14 - 8	0.161	0.512	0.984	1.181	2.953	0.394	TC 16-2 ...	325		225
E25 N TC 16-3	0.138 - 0.197	7 - 5	0.122	0.512	0.984	1.181		0.472	TC 16-3 ...		425	



→ 61-65	→ 69-71	metric ↓ ↕										
---------	---------	------------------	--	--	--	--	--	--	--	--	--	--

MonoClamp – Monoholder TC – external thread

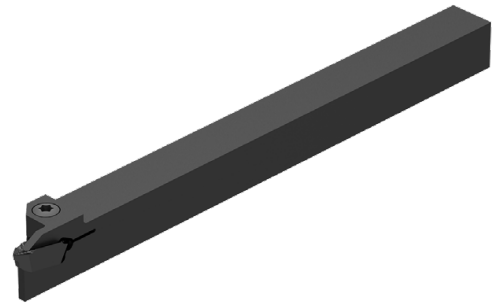
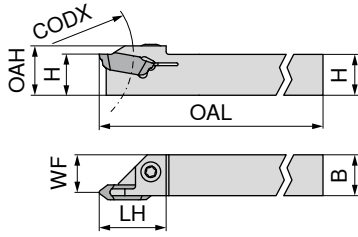

Illustrations show right-hand versions

Designation	TP mm	TPI 1/''	H inch	B inch	OAL inch	LH inch	OAH inch	WF inch	CODX inch	for grooving inserts	Left-hand	Right-hand
											78 883 ...	78 882 ...
E12 R/L 00-08 TC16-E	0,5-3	28-8	0.500	0.500	6.000	0.768	0.598	0.461	1.181	TC16-1/2..	05000	05000

Spare parts
for grooving inserts
TC16-1/2..



80 950 ...	70 950 ...
T15	M4x11
113	442



→ 61-65										
---------	--	--	--	--	--	--	--	--	--	--

ModularClamp MSS – Threading module TC for internal threads

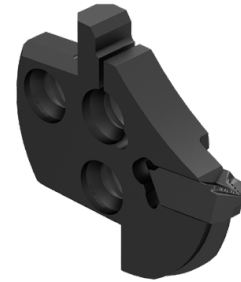
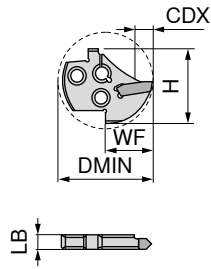

Left-hand Neutral Right-hand

70 887 ...	70 887 ...	70 887 ...
132		032
332	432	232

Designation	TP mm	TPI 1/''	LB inch	WF inch	H inch	DMIN inch	CDX inch	for grooving inserts
I32 R/L TC 16-1	0,5 - 1,5	28 - 16	0.244	0.205	1.268	1.575	0.276	TC 16-1 ...
I32 R/L TC 16-2	1,75 - 3,0	14 - 8	0.244	0.161	1.268	1.575	0.276	TC 16-2 ...
I32 N TC 16-3	3,5 - 5,0	7 - 5	0.244	0.122	1.268	1.575	0.276	TC 16-3 ...



→ 61-65	→ 72							
---------	------	--	--	--	--	--	--	--

ModularClamp MSS – Tool holder 0°

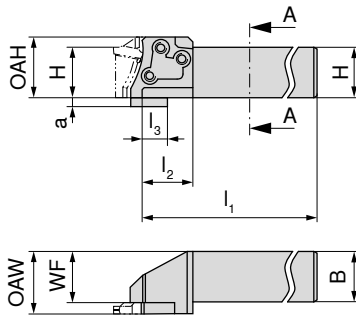

Illustrations show right-hand versions

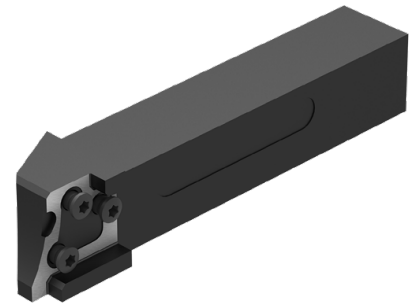

Designation	H inch	B inch	OAW inch	OAH inch	WF inch	l ₁ inch	l ₂ inch	l ₃ inch	for modules	Left-hand	Right-hand
										78 851 ...	78 850 ...
E12 R/L 00-08-E	0.500	0.500	0.650	0.598	0.512	3.000	0.472		E12 R/L ...	05000	05000
E16 R/L 00-10-E	0.625	0.625	0.787	0.763	0.650	3.500	0.630		E16 R/L ...	06300	06300
E 20 R/L 00-10-E	0.625	0.787	0.955	0.955	0.793	3.500	0.787		E20 R/L ...	06400	06400
E 20 R/L 00-12-E	0.750	0.750	0.955	0.955	0.793	4.500	0.787	0.393	E20 R/L ...	07500	07500
E 25 R/L 00-16-E	1.000	1.000	1.236	1.236	1.020	5.500	0.984		E25 R/L ...	10000	10000
E 32 R/L 00-20-E	1.250	1.000	1.236	1.236	1.020	6.500	1.260	0.630	E32 R/L ...	12500	12500
E 32 R/L 00-85-E	1.250	1.250	1.496	1.496	1.279	7.000	1.260	0.630	E32 R/L ...	12600	12600

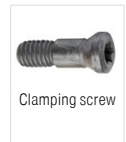
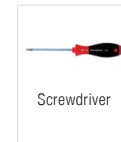

Spare parts for Article no.

Article no.	80 950 ...	70 950 ...
78 850 05000 / 78 851 05000	T08	110 M2,5x10 440
78 850 06300 / 78 851 06300	T15	113 M3,5x12,5 441
78 850 06400 / 78 851 06400	T15	113 M4x14 403
78 850 07500 / 78 851 07500	T15	113 M4x14 403
78 850 10000 / 78 851 10000	T20	114 M5x18 404
78 850 12500 / 78 851 12500	T25	115 M6x20 405
78 850 12600 / 78 851 12600	T25	115 M6x20 405

Module Overview



→ 4+5

ModularClamp MSS – Tool holder 45°

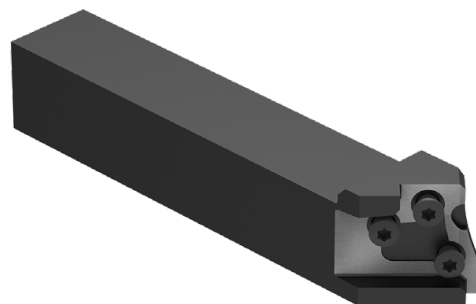
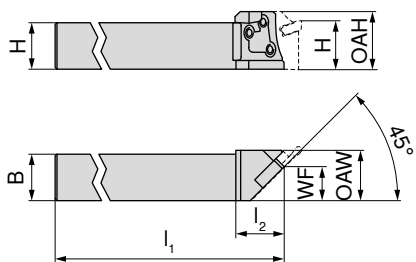

Illustrations show right-hand versions

Designation	H inch	B inch	OAW inch	OAH inch	WF inch	I ₁ inch	I ₂ inch	for modules	Left-hand	Right-hand
									78 853 ...	78 852 ...
E20 R/L 45-12-E	0.750	0.750	0.846	0.984	0.571	4.500	0.787	E20 R/L ...	07500	07500
E25 R/L 45-12-E	1.000	1.000	1.024	1.197	0.709	5.500	0.984	E25 R/L ...	10000	10000

i For right hand holder → left hand module only
For left hand holder → right hand module only

Spare parts for Article no.									Screwdriver	Clamping screw	Clamping screw
									80 950 ...	70 950 ...	70 950 ...
78 852 07500 / 78 853 07500	T15	113	M4x11	442	M4x14	403					
78 852 10000 / 78 853 10000	T20	114	M5x13,5	513	M5x18	404					

Module Overview



→ 4+5

ModularClamp MSS – Tool holder 90°

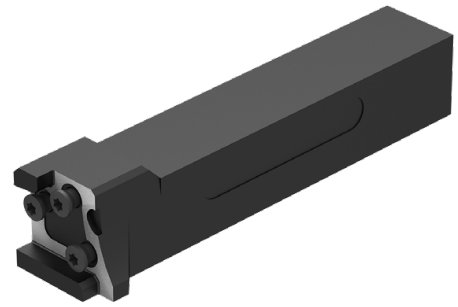
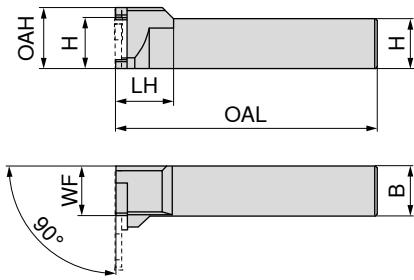

Illustrations show right-hand versions

Designation	H inch	B inch	OAH inch	WF inch	OAL inch	LH inch	for modules	Left-hand	Right-hand
								78 855 ...	78 854 ...
E20 R/L 90-12-E	0.750	0.750	0.907	0.787	4.500	0.783	E20 R/L ...	07500	07500
E25 R/L 90-16-E	1.000	1.000	1.197	1.000	5.500	1.098	E25 R/L ...	10000	10000
E32 R/L 90-85-E	1.250	1.000	1.486	1.260	6.500	1.339	E32 R/L ...	12500	12500
E32 R/L 90-20-E	1.250	1.250	1.528	1.260	8.000	1.339	E32 R/L ...	12600	12600

i For right hand holder → left hand module only
For left hand holder → right hand module only

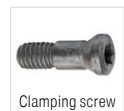

Spare parts for Article no.	80 950 ...	70 950 ...	5	
			80 950 ...	70 950 ...
78 854 07500 / 78 855 07500	T15	113	M4x14	403
78 854 10000 / 78 855 10000	T20	114	M5x18	404
78 854 12500 / 78 855 12500	T25	115	M6x20	405
78 854 12600 / 78 855 12600	T25	115	M6x20	405

Module Overview



→ 4+5

ModularClamp MSS – Boring bars GX / TC

▲ With internal coolant supply

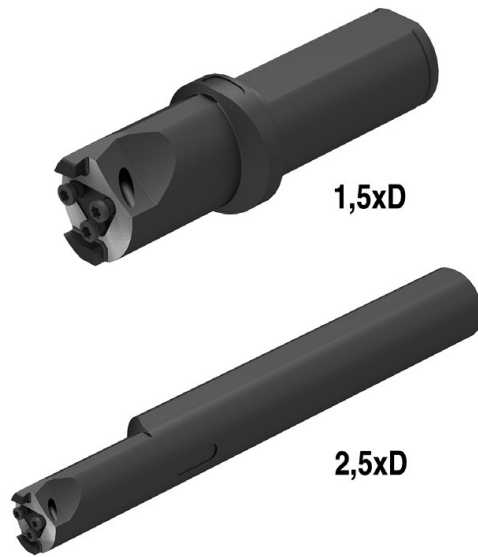
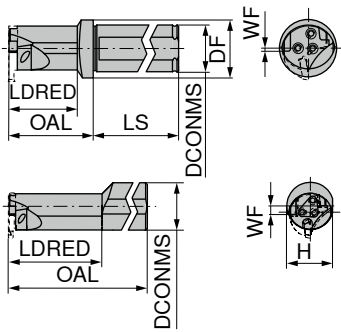

	Designation	DCONMS inch	DF inch	WF inch	H inch	OAL inch	LDRED inch	LS inch	for modules	Left-hand	Right-hand
										78 861 ...	78 860 ...
≤ 1,5xD	I16 R/L 90-1.5 D-E	0.750	1.000	0.039	0.693	7.000	0.945	2.000	I 16 R/L	07500	07500
	I20 R/L 90-1.5 D-E	0.750	1.000	0.039	0.842	8.000	1.181	2.000	I 20 R/L	07600	07600
	I25 R/L 90-1.5 D-E	1.000	1.260	0.059	1.086	10.000	1.496	2.250	I 25 R/L	10000	10000
	I32 R/L 90-1.5 D-E	1.250	1.575	0.079	1.378	12.000	1.890	2.250	I 32 R/L	12500	12500
	I40 R/L 90-1.5 D-E	1.500	1.969	0.098	1.724	14.000	2.362	3.000	I 40 R/L/N	15000	15000
≤ 2,5xD	I16 R/L 90-2.5 D-E	0.750	1.000	0.177	0.693	7.000	1.575	2.000	I 16 R/L	27500	27500
	I20 R/L 90-2.5 D-E	1.000	1.000	0.236	0.842	8.000	1.969	2.000	I 20 R/L	20000	20000
	I25 R/L 90-2.5 D-E	1.250	1.250	0.276	1.086	10.000	2.480	2.250	I 25 R/L	22500	22500
	I32 R/L 90-2.5 D-E	1.500	1.575	0.374	1.378	12.000	3.150	2.250	I 32 R/L	25000	25000
	I40 R/L 90-2.5 D-E	2.000	1.969	0.433	1.724	14.000	3.937	3.000	I 40 R/L/N	20100	20100

Spare parts for modules

		80 950 ...		70 950 ...
I 16 R/L	T08	110	M2,5x10	440
I 20 R/L	T10	112	M3x11	444
I 25 R/L	T15	113	M3,5x12,5	441
I 32 R/L	T20	114	M4,5x17	445
I 40 R/L/N	T20	114	M5x18	404

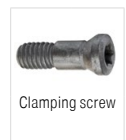

Module Overview

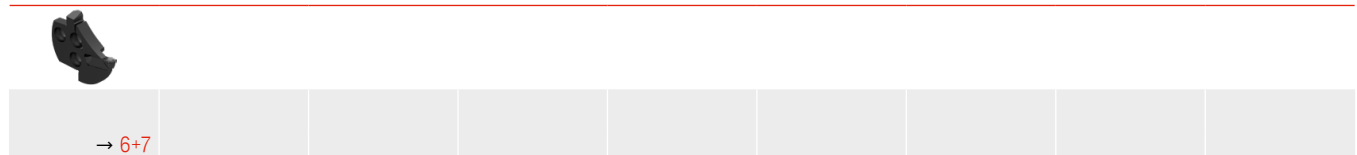

Split clamping block for blades DC

Scope of supply:

Complete clamping block, but without blade and coolant set

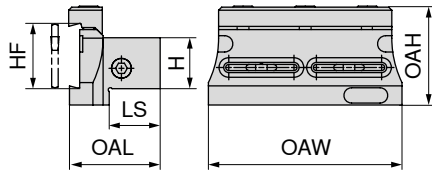

Designation	H	HF	OAH	LS	OAL	OAW	for blades	78 829 ...
	inch	inch	inch	inch	inch	inch		
SBN 12-26-DC-E	0.750	1.024	1.690	0.700	1.480	3.230	XLC.. 26..	07500
SBN 16-32-DC-E	1.000	1.260	1.910	0.950	1.750	3.740	XLC.. 32..	10000
SBN 20-32-DC-E	1.250	1.260	1.910	0.950	1.750	3.740	XLC.. 32..	12500

Spare parts for Article no.	Coolant screw plug		Clamping rail		clamping screw	
	70 950 ...		70 950 ...		70 950 ...	
78 829 07500	G 1/8"	294	CU70	290	M6x12	861
78 829 10000	G 1/8"	294	CU85	291	M6x12	861
78 829 12500	G 1/8"	294	CU85	291	M6x12	861

Spare parts for Article no.	O-Ring		O-Ring	
	70 950 ...		70 950 ...	
78 829 07500		19x2,5	293	
78 829 10000			23x2,5	292
78 829 12500			23x2,5	292

Clamping block for blades GX/LX/FX/SX

Scope of supply:

Clamping block complete, but without blade and coolant set

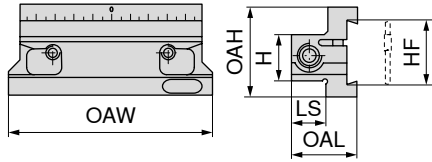

Designation	H inch	HF inch	OAH inch	LS inch	OAL inch	OAW inch	for blades	78 830 ...
SBN 12-26K-E	0.750	1.024	1.535	0.700	1.369	3.540	XLC.. 26..	07500
SBN 20-32K-E	1.250	1.260	1.890	1.200	1.909	4.720	XLC.. 32..	12500
SBN 16-32K-E	1.000	1.260	1.890	0.950	1.647	4.330	XLC.. 32..	10000
SBN 24-46K-E	1.500	1.811	2.756	1.450	2.362	5.910	XLC.. 46..	15000
SBN 20-46K-E	1.250	1.811	2.756	1.200	2.106	5.910	XLC.. 46..	12600

Spare parts for blades	70 950 ...			70 950 ...			70 950 ...		
	Key I	Cooling agent set	clamping screw	Key I	Cooling agent set	clamping screw	Key I	Cooling agent set	clamping screw
XLC.. 26..	SW5	265	278	M6x25	269				
XLC.. 32..	SW5	265	278	M6x25	269				
XLC.. 46..	SW6	266	279	M8x35	282				

Split clamping block for blades GX/LX/FX/SX

Scope of supply:

Clamping block complete, but without blade and coolant set

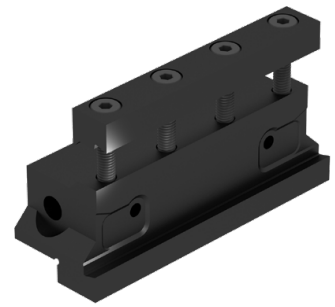
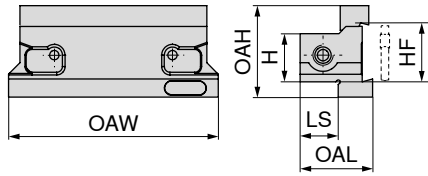

78 831 ...

Designation	H inch	HF inch	OAH inch	LS inch	OAL inch	OAW inch	for blades	
SBN 12-26KS-E	0.750	1.024	1.688	0.700	1.369	3.540	XLC.. 26..	07500
SBN 20-32KS-E	1.250	1.260	2.044	1.200	1.909	4.720	XLC.. 32..	12500
SBN 16-32KS-E	1.000	1.260	1.929	0.950	1.647	4.330	XLC.. 32..	10000

**Spare parts
for blades**

XLC.. 26..	SW5	265	278	M6x25	269
XLC.. 32..	SW5	265	278	M6x25	269

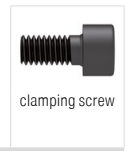
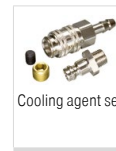
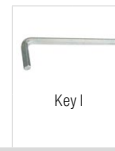

70 950 ...

70 950 ...

70 950 ...

Material examples for cutting data tables

	Material sub-group	Index	Composition / Structure / Heat treatment	Tensile strength lbf/in ² / HB / HRC	Material number	Material designation	Material number	Material designation
P	Unalloyed steel	P.1.1	< 0.15 % C Annealed	60900 lbf/in ² / 125 HB	1.0401	1015	1.0301	1010
		P.1.2	< 0.45 % C Annealed	92800 lbf/in ² / 190 HB	1.1191	1045	1.0737	12L14
		P.1.3	< 0.45 % C Tempered	121800 lbf/in ² / 250 HB	1.1191	1045	1.0503	1043
		P.1.4	< 0.75 % C Annealed	132000 lbf/in ² / 270 HB	1.1223	1060	1.0535	1055
		P.1.5	< 0.75 % C Tempered	146500 lbf/in ² / 300 HB	1.1223	1060	1.1274	1095
	Low-alloy steel	P.2.1	Annealed	88500 lbf/in ² / 180 HB	1.7131	5115	1.6523	8620
		P.2.2	Tempered	134900 lbf/in ² / 275 HB	1.7131	5115	1.6582	4340
		P.2.3	Tempered	146500 lbf/in ² / 300 HB	1.7225	4142	1.7131	5115
		P.2.4	Tempered	174000 lbf/in ² / 375 HB	1.7225	4142	1.7223	4140
	High-alloy steel and high-alloy tool steel	P.3.1	Annealed	98600 lbf/in ² / 200 HB	1.4021	420	1.2379	D2
		P.3.2	Hardened and tempered	159500 lbf/in ² / 300 HB	1.2343	H11	1.3343	M2
		P.3.3	Hardened and tempered	188500 lbf/in ² / 400 HB	1.2343	H11	1.2363	A2
	Stainless steel	P.4.1	Ferritic / martensitic Annealed	98600 lbf/in ² / 200 HB	1.4016	430	1.4125	440C
		P.4.2	Martensitic Tempered	117500 lbf/in ² / 250 HB	1.4112	S44003	1.4021	420
M	Stainless steel	M.1.1	Austenitic / austenitic-ferritic Quenched	88500 lbf/in ² / 200 HB	1.4301	304	1.4401	316
		M.2.1	Austenitic Tempered	300 HB	1.4841	314	1.4568	17-7 PH
		M.3.1	Austenitic / ferritic (Duplex)	113100 lbf/in ² / 230 HB	1.4462	S32205	1.4410	S32750
K	Grey cast iron	K.1.1	Pearlitic / ferritic	88500 lbf/in ² / 180 HB	0.6010	A48-20B	0.6025	A48-40 B
		K.1.2	Pearlitic (martensitic)	127600 lbf/in ² / 260 HB	0.6030	A48-45B	0.6040	A48-60 B
	Spherulitic graphite cast iron	K.2.1	Ferritic	78300 lbf/in ² / 160 HB	0.7040	60-40-18	0.7050	65-45-12
		K.2.2	Pearlitic	122600 lbf/in ² / 250 HB	0.7070	100-70-03	0.7660	A439 Type D2
	Malleable iron	K.3.1	Ferritic	63800 lbf/in ² / 130 HB	0.8035	GTW-35-04		
		K.3.2	Pearlitic	113100 lbf/in ² / 230 HB	0.8170	70003		
N	Aluminium wrought alloy	N.1.1	Non-hardenable	60 HB	3.0255	A91060	3.0255	A91060
		N.1.2	Hardenable	49300 lbf/in ² / 100 HB	3.1355	2024	3.1355	2024
	Cast aluminium alloy	N.2.1	≤ 12 % Si, non-hardenable	36300 lbf/in ² / 75 HB	3.2581	A04130 / A413-0	3.2581	A04130 / A413-0
		N.2.2	≤ 12 % Si, hardenable	43500 lbf/in ² / 90 HB	3.2134	G-AISi5Cu1Mg		
		N.2.3	> 12 % Si, non-hardenable	63800 lbf/in ² / 130 HB		G-AISi17Cu4Mg		
	Copper and copper alloys (bronze/brass)	N.3.1	Free-machining alloys, PB > 1 %	54400 lbf/in ² / 110 HB	2.0380	CuZn39Pb2 (Ms58)	2.0380	C37700
		N.3.2	CuZn, CuSnZn	43500 lbf/in ² / 90 HB	2.0331	CuZn15	2.0331	C34000
		N.3.3	CuSn, lead-free copper and electrolytic copper	49300 lbf/in ² / 100 HB	2.0060	E-Cu57		
	Magnesium alloys	N.4.1	Magnesium and magnesium alloys	70 HB	3.5612	MgAl6Zn		
	S	Heat-resistant alloys	S.1.1	Fe - basis Annealed	98600 lbf/in ² / 200 HB	1.4864	X12NiCrSi 36-16	1.4864
S.1.2			Fe - basis	137800 lbf/in ² / 280 HB	1.4980	X6NiCrTiMoVB25-15-2	1.4980	S66286
S.2.1			Annealed	121800 lbf/in ² / 250 HB	2.4856	Inconel 625	2.4812	Hastelloy C
S.2.2			Ni or Co basis	171100 lbf/in ² / 350 HB	2.4952	Nimonic 80A	2.4668	Inconel 718
S.2.3			Cast	156600 lbf/in ² / 320 HB	2.4674	Nimocast PK24	2.4670	Nimocast 713
Titanium alloys		S.3.1	Pure titanium	5800 lbf/in ²	3.7025	Ti99,8		
		S.3.2	Alpha + beta alloys	152300 lbf/in ²	3.7165	TiAl6V4		
		S.3.3	Beta alloys	203100 lbf/in ² / 410 HB	Ti555.3	Ti-5Al-5V-5Mo-3Cr		
H	Hardened steel	H.1.1	Hardened and tempered	46-55 HRC				
		H.1.2	Hardened and tempered	56-60 HRC				
		H.1.3	Hardened and tempered	61-65 HRC				
		H.1.4	Hardened and tempered	66-70 HRC				
	Chilled iron	H.2.1	Cast	400 HB				
	Hardened cast iron	H.3.1	Hardened and tempered	55 HRC				
O	Non-metal materials	O.1.1	Plastics, duroplastic	≤ 21800 lbf/in ²				
		O.1.2	Plastics, thermoplastic	≤ 14500 lbf/in ²				
		O.2.1	Aramid fibre-reinforced	≤ 145000 lbf/in ²				
		O.2.2	Glass/carbon-fibre reinforced	≤ 145000 lbf/in ²				
		O.3.1	Graphite					

* Tensile Strength at Rupture (Rm)

Cutting data values for grooving inserts GX/LX/FX/SX/AX/TC

	DRAGONSKIN CTCP325	DRAGONSKIN CTCP335	DRAGONSKIN CTPP345	DRAGONSKIN CTPP520	DRAGONSKIN CTPP535	DRAGONSKIN CTP1340	H216T (SX/FX/GX)	H216T (TC)	
Index	v _c in ft/min								
P.1.1	890	760	550	980	770	760			
P.1.2	890	760	550	980	770	760			
P.1.3	890	760	550	980	770	760			
P.1.4	890	760	550	980	770	760			
P.1.5	890	760	550	980	770	760			
P.2.1	890	760	550	980	770	760			
P.2.2	890	760	550	980	770	760			
P.2.3	890	760	550	980	770	760			
P.2.4	890	760	550	980	770	760			
P.3.1	840	670	470	970	590	610			
P.3.2	840	670	470	970	590	610			
P.3.3	840	670	470	970	590	610			
P.4.1	840	670	470	970	590	610			
P.4.2	840	670	470	970	590	610			
M.1.1	840	670	470	970	590	610			
M.2.1	840	670	470	970	590	610			
M.3.1	840	670	470	970	590	610			
K.1.1	560	450		460	540	500	460	460	
K.1.2	500	380		380	500	410	380	380	
K.2.1	530	430		590	480	460	500	500	
K.2.2	480	350		380	510	400	360	360	
K.3.1	690	500		430	630	560	560	560	
K.3.2	460	380		360	480	400	460	460	
N.1.1						990	1320	1490	
N.1.2						660	330	1490	
N.2.1						990	1490	990	
N.2.2						660	1490	990	
N.2.3						500	1650	740	
N.3.1						990	1400	630	
N.3.2						990	1320	960	
N.3.3						660	910	960	
N.4.1						660	740	960	
S.1.1	120			130	100	120	120		
S.1.2	100		100	100	80	100	90		
S.2.1	70		80	70	50	70	90		
S.2.2	50			50	50	50	80		
S.2.3	50			60	50	50	70		
S.3.1				410	280	280	300		
S.3.2				170	120	130	180		
S.3.3				120	80	100	130		
H.1.1				50					
H.1.2				50					
H.1.3									
H.1.4									
H.2.1				50					
H.3.1				130					
O.1.1						430	430	960	
O.1.2									
O.2.1						350	350	960	
O.2.2									
O.3.1									

 The cutting data is strongly influenced by external conditions, such as the stability of the tool and workpiece clamping, material and type of machine. The specified values represent guideline cutting data that can be adjusted by approx. ±20% according to the usage conditions.

GX – Depths of cut and feed rates

GX Standard / GX-E

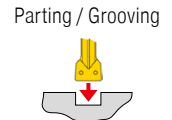
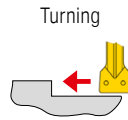

GX Standard / GX-E	Depth of Cut a_p in inch							GX Standard / GX-E
	.020	.040	.060	.080	.100	.120	.140	
Cutting width in inch	Feed rate f in inch/rev.							Feed rate f in inch/rev.
.0787	.0039 - .0059	.0020 - .0059	.0020 - .0047	.0020 - .0039				.0020 - .0079
.1181	.0039 - .0067	.0020 - .0067	.002 - .0067	.0020 - .0059	.0020 - .0047			.0039 - .0098
.1575	.0039 - .0079	.0028 - .0079	.0028 - .0079	.0028 - .0079	.0028 - .0067	.0028 - .0059		.0039 - .0098
.1969	.0039 - .0098	.0039 - .0098	.0028 - .0098	.0028 - .0098	.0028 - .0087	.0028 - .0079		.0039 - .0118
.2362	.0059 - .0118	.0059 - .0118	.0059 - .0118	.0059 - .0118	.0059 - .0118	.0059 - .0098	.0059 - .0087	.0059 - .0138

When axial grooving reduce feed by 40%.

GX-F2

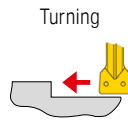

GX-F2	Depth of Cut a_p in inch									GX-F2
	.020	.030	.040	.050	.060	.070	.080	.090	.100	
Cutting width in inch	Feed rate f in inch/rev.									Feed rate f in inch/rev.
.0787	.0012 - .0059	.0012 - .0059	.0012 - .0059	.0012 - .0039						.0020 - .0059
.1181	.0016 - .0067	.0016 - .0067	.0016 - .0067	.0016 - .0059	.0016 - .0051	.0016 - .0047				.0028 - .0079
.1575	.0020 - .0079	.0020 - .0079	.0020 - .0079	.0020 - .0079	.0020 - .0079	.0020 - .0067	.0020 - .0059			.0039 - .0098
.1969	.0028 - .0079	.0028 - .0079	.0028 - .0079	.0028 - .0079	.0028 - .0079	.0028 - .0079	.0028 - .0067	.0028 - .0059		.0039 - .0118
.2362	.0039 - .0091	.0039 - .0091	.0039 - .0091	.0039 - .0091	.0039 - .0091	.0039 - .0091	.0039 - .0091	.0039 - .0075	.0039 - .0059	.0059 - .0128

When axial grooving reduce feed by 40%.

GX-M40

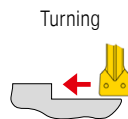

GX-M40	Depth of Cut a_p in inch								GX-M40
	.020	.040	.060	.080	.100	.120	.140	.160	
Cutting width in inch	Feed rate f in inch/rev.								Feed rate f in inch/rev.
.0787	.0039 - .0079	.0020 - .0079	.0020 - .0067	.0020 - .0059					.0020 - .0059
.1181	.0039 - .0087	.0039 - .0087	.0039 - .0083	.0039 - .0079	.0039 - .0067				.0028 - .0079
.1575	.0039 - .0098	.0039 - .0098	.0039 - .0098	.0039 - .0098	.0039 - .0087	.0039 - .0067			.0039 - .0098
.1969	.0039 - .0118	.0039 - .0118	.0039 - .0118	.0039 - .0118	.0039 - .0106	.0039 - .0091	.0039 - .0079		.0039 - .0118
.2362	.0039 - .0138	.0039 - .0138	.0039 - .0138	.0039 - .0138	.0039 - .0126	.0039 - .0106	.0039 - .0091	.0039 - .0079	.0059 - .0128

When axial grooving reduce feed by 40%.

GX-27P

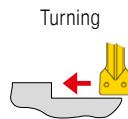

GX-27P	Depth of Cut a_p in inch								GX-27P
	.020	.040	.060	.080	.100	.120	.140	.160	
Cutting width in inch	Feed rate f in inch/rev.								Feed rate f in inch/rev.
.0787	.0020 - .0091	.0020 - .0091	.0020 - .0091	.0020 - .0079					.0020 - .0079
.1181	.0020 - .0098	.0020 - .0098	.0020 - .0098	.0020 - .0098	.0020 - .0079				.0020 - .0098
.1575	.0039 - .0118	.0039 - .0118	.0039 - .0118	.0039 - .0118	.0039 - .0118	.0039 - .0098			.0020 - .0118
.1969	.0039 - .0138	.0039 - .0138	.0039 - .0138	.0039 - .0138	.0039 - .0138	.0039 - .0126	.0039 - .0118		.0039 - .0138
.2362	.0039 - .0157	.0039 - .0157	.0039 - .0157	.0039 - .0157	.0039 - .0157	.0039 - .0142	.0039 - .013	.0039 - .0118	.0039 - .0157

When axial grooving reduce feed by 40%.

GX – Depths of cut and feed rates

GX-M3

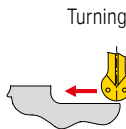

Parting / Grooving

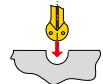

GX-M3	Depth of Cut a_p in inch								GX-M3
	.020	.040	.060	.080	.100	.120	.140	.160	
Radius RE in inch	Feed rate f in inch/rev.								Feed rate f in inch/rev.
.0591	.0059 - .0138	.0059 - .0138	.0059 - .0118						.0020 - .0079
.0787	.0059 - .0157	.0059 - .0157	.0059 - .0157	.0059 - .0118					.0039 - .0098
.0984	.0059 - .0197	.0059 - .0197	.0059 - .0197	.0059 - .0157	.0059 - .0138				.0039 - .0098
.1181	.0079 - .0276	.0079 - .0276	.0079 - .0276	.0079 - .0236	.0079 - .0197	.0079 - .0157			.0039 - .0138

GX-27P Full Radius

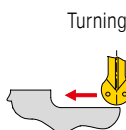

Parting / Grooving

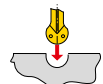

GX-27P Full Radius	Depth of Cut a_p in inch								GX-27P Full Radius
	.020	.040	.060	.080	.100	.120	.140	.160	
Radius RE in inch	Feed rate f in inch/rev.								Feed rate f in inch/rev.
.0591	.0039 - .0177	.002 - .0177	.002 - .0157						.0020 - .0059
.0787	.0059 - .0197	.0039 - .0197	.0039 - .0197	.0039 - .0157					.0030 - .0079
.0984	.0059 - .0236	.0039 - .0236	.0039 - .0236	.0039 - .0197	.0039 - .0177				.0039 - .0098
.1181	.0098 - .0276	.0079 - .0276	.0059 - .0276	.0059 - .0276	.0059 - .0256	.0059 - .0236	.0059 - .0217		.0039 - .0118
.1575	.0098 - .0315	.0079 - .0315	.0059 - .0315	.0059 - .0315	.0059 - .0315	.0059 - .0315	.0059 - .0295	.0059 - .0276	.0059 - .0138

GX-M1

Parting / Grooving



GX-M1	Feed rate f in inch/rev.
Cutting width in inch	
.0787	.0020 - .0059
.1181	.0039 - .0079
.1575	.0039 - .0098

GX Radius grooving inserts

Parting / Grooving



GX Radius grooving insert	Feed rate f in inch/rev.
Radius RE in inch	
.0315	.0020 - .0039
.0394	.0020 - .0059
.0472	.0020 - .0059

GX circlip grooving

Grooving



GX circlip grooves	Feed rate f in inch/rev.
Cutting width in inch	
.0236 - .0669	.0008 - .0035
.0768 - .0886	.0020 - .0039
.1083 - .1280	.0020 - .0047

Feed guide and machining instructions for axial grooving and face turning with GX 24 axial

Approximate feed rates

GX

Designation	f in inch/rev.		a _{p,max} inch
	Diagram 1	Diagram 2	
GX 24-2 E 3.00 ..	.0019 - .0057	.0019 - .0078	0.100
GX 24-3 E 4.00 ..	.0019 - .0057	.0019 - .0098	0.120
GX 24-3 E 5.00 ..	.0019 - .0057	.0039 - .0098	0.120
GX 24-4 E 6.00 ..	.0019 - .0078	.0039 - .0117	0.140

Axial grooving

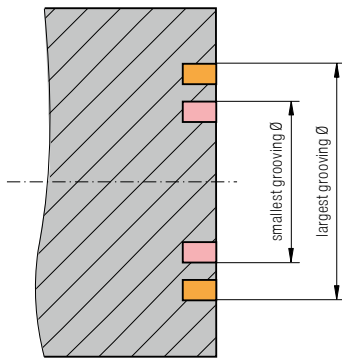

It is only possible to plunge within the fixed diameter range of the axial grooving module or monoholder (e.g. 1.9685 – 2.7559 inch).

Important: The indicated diameter range is always valid for the external diameter of the groove!

Axial grooving – Groove widening

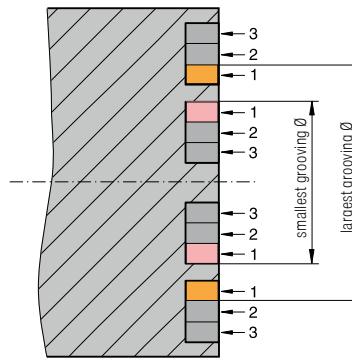

In case of face turning it is possible to widen the groove above and below the diameter range indicated on the Axial grooving module or monoholder.

Important: Only the first groove must lie within the diameter range of the axial grooving module or axial monoholder. The depth of the widening groove must not be larger than the depth of the original groove.

Axial grooving and face turning

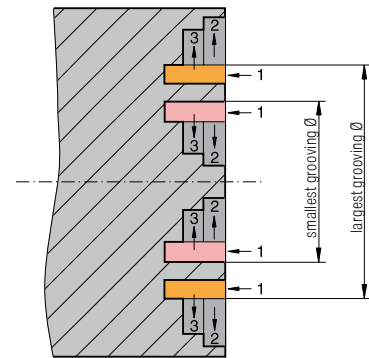

Groove widening by face turning in the diameter range above and below the values specified for the Axial grooving module and Axial monoholder are possible.

Important: Only the first groove must lie within the diameter range of the module.



Attention: The diameter of face grooves must lie within the diameter range indicated on the axial grooving module and axial monoholder. Not following this range will result in the tool being damaged or destroyed.

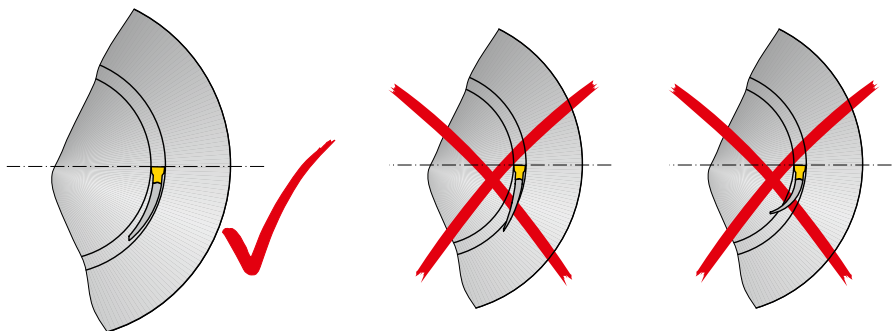

Correct Axial mono holder

Incorrect Axial mono holder

SX – Depths of cut and feed rates

SX-F2

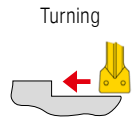

Parting / Grooving

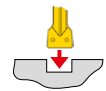

SX-F2	Depth of Cut a_p in inch									SX-F2
	.020	.003	.040	.050	.060	.070	.080	.090	.100	
Cutting width in inch	Feed rate f in inch/rev.									Feed rate f in inch/rev.
.0787	.0012 - .0059	.0012 - .0059	.0012 - .0059	.0012 - .0039						.0020 - .0059
.1181	.0016 - .0067	.0016 - .0067	.0016 - .0067	.0016 - .0059	.0016 - .0051	.0016 - .0047				.0028 - .0079
.1575	.0020 - .0079	.0020 - .0079	.0020 - .0079	.0020 - .0079	.0020 - .0079	.0020 - .0067	.0020 - .0059			.0039 - .0098

SX-M2

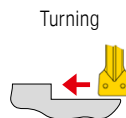

Parting / Grooving

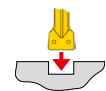

SX-M2	Depth of Cut a_p in inch								SX-M2
	.020	.040	.060	.080	.100	.120	.140	.160	
Cutting width in inch	Feed rate f in inch/rev.								Feed rate f in inch/rev.
.0787	.0020 - .0067	.0020 - .0051	.0020 - .0039						.0020 - .0059
.1181	.0028 - .0079	.0028 - .0079	.0028 - .0071	.0028 - .0059					.0028 - .0079
.1575	.0039 - .0098	.0039 - .0098	.0039 - .0098	.0039 - .0087	.0039 - .0071				.0039 - .0098
.1969	.0047 - .0106	.0047 - .0106	.0047 - .0106	.0047 - .0098	.0047 - .0087				.0039 - .0118
.2362	.0059 - .0118	.0059 - .0118	.0059 - .0118	.0059 - .0118	.0059 - .0098	.0059 - .0079			.0059 - .0138

SX-27P

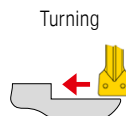

Parting / Grooving

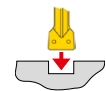

SX-27P	Depth of Cut a_p in inch								SX-27P
	.020	.040	.060	.080	.100	.120	.140	.160	
Cutting width in inch	Feed rate f in inch/rev.								Feed rate f in inch/rev.
.0787	.0029 - .0091	.0020 - .0091	.0020 - .0091	.0020 - .0079					.0020 - .0079
.1181	.0020 - .0098	.0020 - .0098	.0020 - .0098	.0020 - .0098	.0020 - .0079				.0020 - .0098
.1575	.0039 - .0118	.0039 - .0118	.0039 - .0118	.0039 - .0118	.0039 - .0118	.0039 - .0098			.0020 - .0118

SX/LX – Depths of cut and feed rates

SX-M1

Parting / Grooving



SX-M1	
Cutting width in inch	Feed rate f in inch/rev.
.0787	.0020 - .0059
.1181	.0039 - .0079
.1575	.0039 - .0098
.1969	.0059 - .0118
.2362	.0059 - .0138

SX-M3

Turning

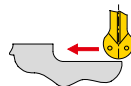

Parting / Grooving

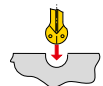

SX-M3	Depth of Cut a_p in inch								SX-M3
	.020	.040	.060	.080	.100	.120	.140	.160	
Radius in inch	Feed rate f in inch/rev.								Feed rate f in inch/rev.
.0591	.0059 - .0138	.0059 - .0138	.0059 - .0118						.0022 - .008
.0787	.0059 - .0157	.0059 - .0157	.0059 - .0157	.0059 - .0118					.004 - .0010
.0984	.0059 - .0197	.0059 - .0197	.0059 - .0197	.0059 - .0157	.0059 - .0138				.004 - .0010
.1181	.0079 - .0276	.0079 - .0276	.0079 - .0276	.0079 - .0236	.0079 - .0197	.0079 - .0157			.004 - .0014

LX-M2

Turning

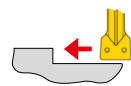

Parting / Grooving

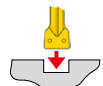

LX-M2	Depth of Cut a_p in inch								LX-M2
	.020	.040	.060	.080	.100	.120	.140	.160	
Cutting width in inch	Feed rate f in inch/rev.								Feed rate f in inch/rev.
.3150	.0067 - .0177	.0067 - .0177	.0067 - .0177	.0067 - .0177	.0067 - .0157	.0067 - .0146	.0067 - .0138		.0080 - .0020
.3937	.0079 - .0197	.0079 - .0197	.0079 - .0197	.0079 - .0197	.0079 - .0181	.0079 - .0165	.0079 - .0150	.0079 - .0138	.0080 - .0020

LX-M3

Turning

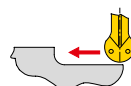

Parting / Grooving

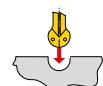

LX-M3	Depth of Cut a_p in inch								LX-M3
	.020	.040	.060	.080	.100	.120	.140	.160	
Radius in inch	Feed rate f in inch/rev.								Feed rate f in inch/rev.
.1575	.0098 - .0315	.0098 - .0315	.0098 - .0315	.0098 - .0315	.0098 - .0315	.0098 - .0276	.0098 - .0236	.0098 - .0197	.0060 - .0014

AX/FX – Depths of cut and feed rates

AX-F50

Face turning

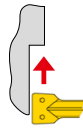

Axial grooving

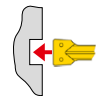

AX-F50	Depth of Cut a_p in inch			
	0,5	1,0	1,5	2,3
Size	Feed rate f in inch/rev.			
AX 05	.0012 - .0039	.0012 - .0039		
AX 10	.0012 - .0051	.0012 - .0051	.0012 - .0053	
AX 15	.0012 - .0059	.0012 - .0059	.0012 - .0059	.0012 - .0059

1. Plunging	
Feed rate f in inch/rev.	Feed rate f in inch/rev.
.0010 - .0031	.0008 - .0079
.0010 - .0026	.0020 - .0098
.0010 - .0020	.0020 - .0118

FX-F1

Parting / Grooving



FX-F1	Feed rate f in inch/rev.
Cutting width in inch	
.0866	.0008 - .0039
.1220	.0020 - .0059
.1614	.0020 - .0079

FX-M1

Parting / Grooving



FX-M1	Feed rate f in inch/rev.
Cutting width in inch	
.0866	.0020 - .0059
.1220	.0031 - .0071
.1614	.0039 - .0079
.2008	.0059 - .0110
.2559	.0059 - .013
.3228	.0079 - .0157
.3819	.0079 - .0157

FX-27P

Parting / Grooving



FX-27P	Feed rate f in inch/rev.
Cutting width in inch	
.0866	.0004 - .0039
.1220	.0004 - .0049
.1614	.0020 - .0059

FX-R2

Grooving



FX-R2	Feed rate f in inch/rev.
Cutting width in inch	
.1220	.0039 - .0108
.1614	.0059 - .0138

TC – Reference values for profile depth and number of passes



All listed values are guide values for steel machining

Metric ISO 60° external thread

Pitch in mm	0,5	0,75	1,0	1,25	1,5	1,75	2,0	2,5	3,0	3,5	4,0	4,5	5,0
Number/cuts	4-6	4-7	4-8	5-9	6-10	7-11	8-12	9-14	10-18	10-18	12-20	12-20	12-20
Thread profile depth in inch	.013	.019	.025	.031	.037	.043	.050	.062	.074	.087	0.100	0.112	0.124

Metric ISO 60° internal thread

Pitch in mm	0,5	0,75	1,0	1,25	1,5	1,75	2,0	2,5	3,0	3,5	4,0	4,5	5,0
Number/cuts	4-6	4-7	4-8	5-9	6-10	7-11	8-12	9-14	10-18	10-18	12-20	12-20	12-20
Thread profile depth in inch	.012	.018	.023	.029	.035	.040	.046	.057	.069	.080	.093	.104	.115

Whitworth 55° external and internal thread

TPI	28	26	24	20	19	18	16	14	12	11	10	9	8	7	6	5
Number/cuts	5-8	5-8	5-9	5-9	6-10	6-10	7-11	8-12	9-14	9-14	10-17	10-18	10-18	12-20	12-20	12-20
Thread profile depth in inch	.024	.026	.028	.033	.035	.037	.041	.047	.055	.060	.066	.074	.083	.095	.111	.133

Partial profile 60° external and internal thread

External	TC 16-2EI-AG60																
	TC 16-1EI-A60								TC 16-2EI-G60				TC 16-3EI-N60				
Pitch in mm	0,5	0,75	1,0	1,25	1,5	1,75	2,0	2,5	3,0	1,75	2,0	2,5	3,0	3,5	4,0	4,5	5,0
Number/cuts	4-6	4-7	5-9	6-10	7-11	8-12	9-14	10-15	12-19	8-12	9-14	10-15	12-20	12-20	13-21	14-22	14-22
Thread profile depth in inch	.013	.020	.028	.035	.043	.050	.058	.072	.087	.048	.056	.070	.085	.096	.111	.126	.141

Internal	TC 16-2EI-AG60																
	TC 16-1EI-A60								TC 16-2EI-G60				TC 16-3EI-N60				
Pitch in mm	0,5	0,75	1,0	1,25	1,5	1,75	2,0	2,5	3,0	1,75	2,0	2,5	3,0	3,5	4,0	4,5	5,0
Number/cuts	4-6	4-7	5-9	6-10	7-11	8-12	9-14	10-15	12-19	8-12	9-14	10-15	12-20	12-20	13-21	14-22	14-22
Thread profile depth in inch	.011	.017	.024	.030	.036	.043	.049	.062	.075	.041	.047	.060	.073	.081	.094	.107	.120

Partial profile 55° external and internal thread

External	TC 16-2EI-AG55													
	TC 16-1EI-A55													
TPI	28	26	24	20	19	18	16	14	12	11	10	9	8	
Number/cuts	5-8	5-8	6-9	6-9	7-12	7-12	8-14	9-14	10-16	10-16	11-18	12-20	12-20	
Thread profile depth in inch	.026	.028	.031	.037	.040	.042	.048	.055	.064	.070	.078	.087	.098	

Internal	TC 16-2EI-G55							TC 16-3EI-N55		
	TPI	14	12	11	10	9	8	7	6	5
Number/cuts	8-12	9-14	10-15	11-18	12-20	12-20	12-20	12-20	14-22	
Thread profile depth in inch	.048	.057	.061	.071	.080	.091	.094	.114	.140	

Comparison threading system with TC and conventional

TC

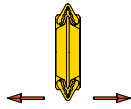

- ▲ Neutral configuration of insert makes operation in both directions possible
- ▲ Only one threading insert per pitch for partial profile and Whitworth thread; only two threading inserts (internal – external) per pitch for ISO threads
- ▲ Reduced stock holding
- ▲ good chip formation due to chip breaker with rake angle + 10 °

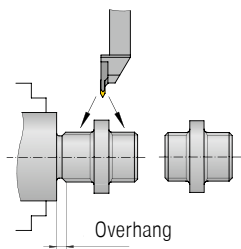

Greater efficiency through:

- ▲ shorter operating time
- ▲ Less tool changing
- ▲ High stability with small overhang
- ▲ Material saving
- ▲ Thread turning between shoulders
- ▲ Fewer tools and indexable inserts

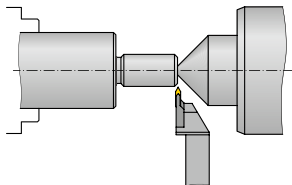

- ▲ Very good access to workpiece, therefore use of tailstock also possible with small thread diameters

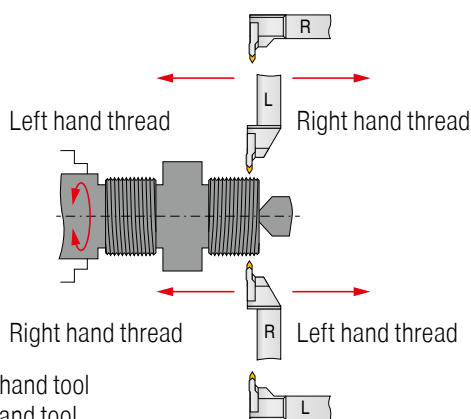

R = Right hand tool
L = Left hand tool

- ▲ ease of use, as the tools have no pitch angle correction they can be used in both directions

Conventional

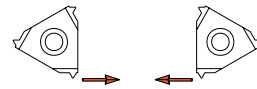

- ▲ Right-hand and left-hand version of indexable insert, therefore operation only in one direction
- ▲ For every pitch 4 threading inserts are necessary (right – left, internal – external)

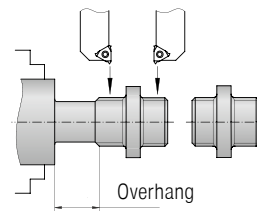

- ▲ For this machining method 2 tools are required
- ▲ additional material and stability loss with large overhang

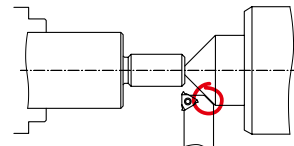

- ▲ poor accessibility
- ▲ Collision danger

Right hand thread

Left hand thread

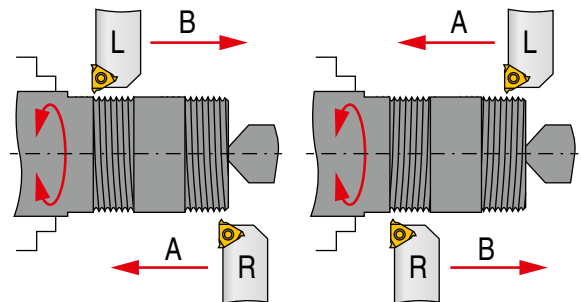

- ▲ With conventional thread turning the correction of the helix angle is necessary, therefore a high degree of application know-how is required
- ▲ Can only be operated in one direction

ModularClamp



The ModularClamp grooving modules are matched according to size on a particular workpiece diameter CODX. If the diameter of the workpiece is greater than CODX of the grooving Modules, this reduces the achievable penetration depth by the dimension „a“. The extent of reduction can be determined with the following table.

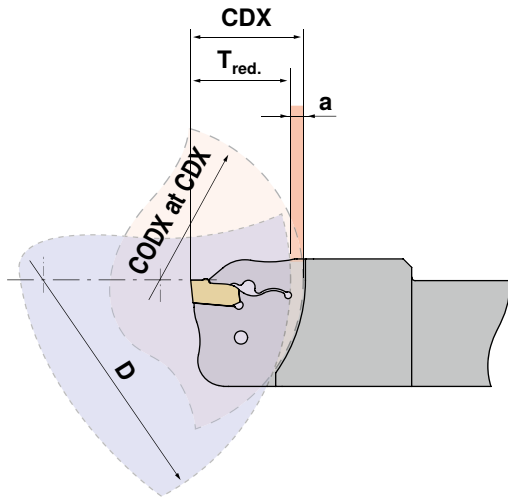

- CDX** maximum plunge depth in inch
- CODX** maximum workpiece Ø with full penetration depth in inch
- a** Reduction amount in inch

$$T_{red.} = CDX - a$$

Grooving depth reduction

Size	Reduction a (inch) of the maximum grooving depth (CDX)																
	.020	.040	.060	.080	.100	.120	.140	.160	.180	.200	.220	.240	.260	.280	.300	.320	
E12	1.38	1.57	1.77	2.36	2.95	4.53	9.84										
E16	1.97	2.17	2.36	2.76	3.15	3.94	5.12	7.87	16.54								
E20	2.36	2.56	2.76	2.95	3.35	3.74	4.33	5.12	6.50	8.66	12.99						
E25	2.95	3.15	3.35	3.54	3.94	4.33	4.92	5.51	6.30	7.48	9.45	12.60	19.69				
E32	3.74	3.94	4.13	4.33	4.72	4.92	5.31	5.71	6.30	7.09	7.87	8.86	10.63	12.60	15.75	20.87	31.50

Workpiece diameter D (inch)

Maximum workpiece diameter (CODX) with full penetration depth (CDX) in inch

Calculation example:

E25R21-GX24-3

Size 25 CDX = .826", Ø 2.95"

$$D = \text{Ø } 3.93" \qquad CDX - a = T_{red.}$$

$$\qquad \qquad \qquad .826" - .080" = .746"$$

MonoClamp

SX

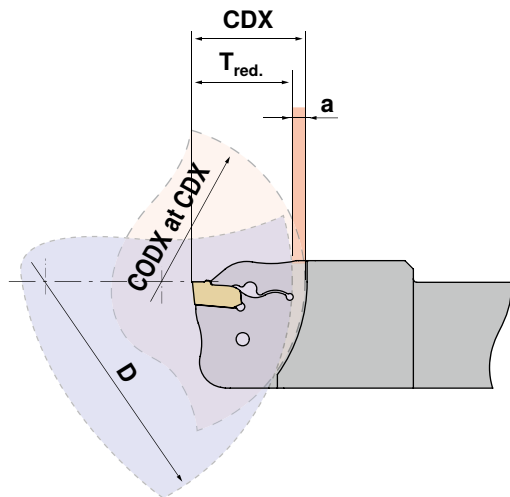

Depending on the groove width and shank size, the MonoClamp tools are designed for use with a specific workpiece tools diameter CODX. If the workpiece diameter is larger than the CODX of the grooving module, the achievable groove depth is reduced by the dimension „a“. The extent of the reduction is determined using the following table.

- CDX** maximum plunge depth in inch
- CODX** maximum workpiece Ø with full penetration depth in inch
- a** Reduction amount in inch

$$T_{red.} = CDX - a$$

Grooving depth reduction

Shank	Reduction a (inch) of the maximum grooving depth (CDX)															
	.020	.040	.060	.080	.100	.120	.140	.160	.180	.200	.220	.240	.260	.280	.300	.320
E12R/L0022...	1.73	2.76	3.15	3.74	4.53	5.91	8.86	17.72								
E16R/L0026...	2.05	3.54	4.13	4.92	6.10	8.27	12.01	23.62								
E20R/L0026...	2.05	4.33	4.92	5.51	6.30	7.68	9.45	12.60	18.70	37.40						
E20R/L0033...	2.60	4.33	4.92	5.51	6.30	7.68	9.45	12.60	18.70	37.40						
E25R/L0026...	2.05	5.51	6.30	7.48	9.25	12.20	18.31	36.61								
E25R/L0033...	2.60	6.10	6.89	7.87	9.06	10.83	13.39	17.72	26.57	53.15						
E25R/L0040...	3.15	6.10	6.89	7.87	9.06	10.83	13.39	17.72	26.57	53.15						

Workpiece diameter D (inch)

Maximum workpiece diameter (CODX) with full penetration depth (CDX) in inch

Calculation example:

E25R0033...

CDX = 1.30" Ø 2.60"

$$D = \text{Ø } 7.87" \qquad CDX - a = T_{red.}$$

$$1.30" - .060" = 1.24"$$

Clamping Method – SX-System

System function – inserting and removing the cutting inserts

Precision system for internal and external grooving.

The key has been designed in such a way that it will not stress the material beyond its 'elastic limit'.

With this alternate system the material always remains in its flexible range and provides a substantial increase in tool life.

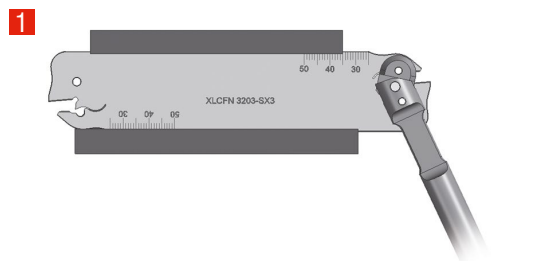

1 Locate wrench into blade with pins located in two holes

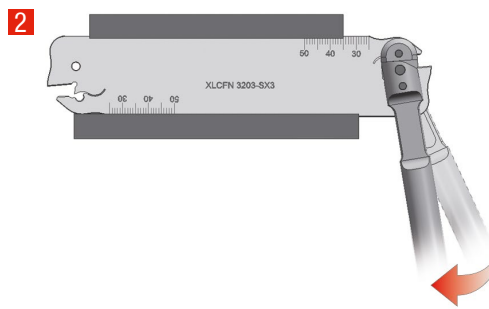

2 Movement of the fitting key in the direction of the insert seat opens the tool.

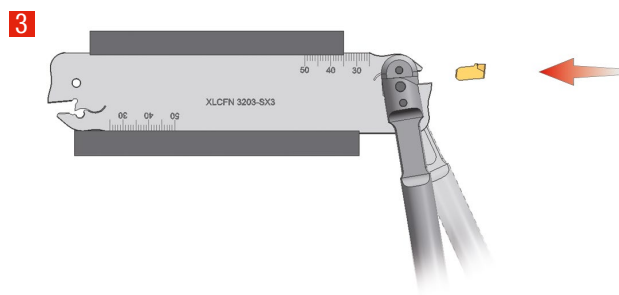

3 Load the grooving insert into position and press against the seat.

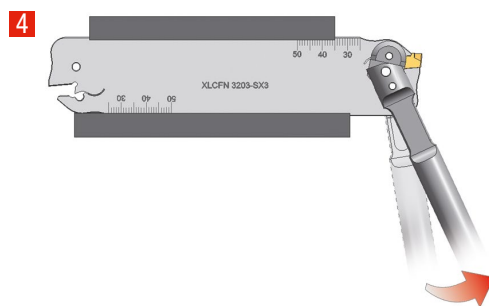

4 Moving the key forward causes the insert seat to close and clamp the insert.

 When changing the inserts, always maintain tension on the key!

The clamp is designed so that the wrench can be inserted from both sides of the blade according to the accessibility.

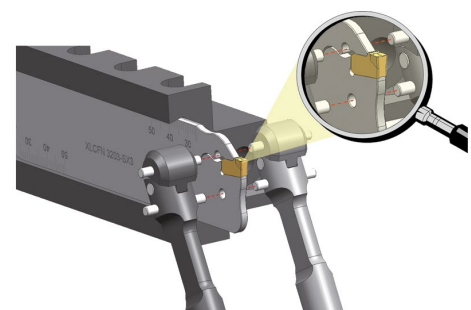

Maximum blade projection when turning

Blade	max. overhang
SX 2 – SX 3	.984 inch
SX 4 – SX 5	1.181 inch
SX 6	1.378 inch



Clamping function – ModularClamp-Module

Module unclamped

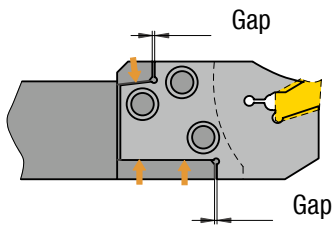

▲ Gap between module and support face for axial clamping

Module clamped

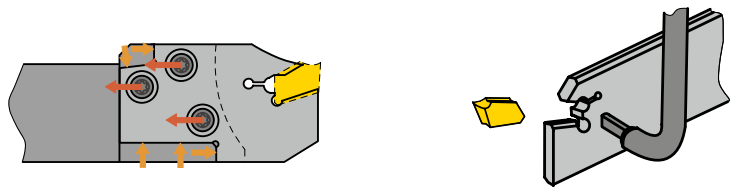

▲ Axial clamping with support face
▲ Connection free from play, therefore maximum stability

GX LX
AX

Active insert clamping

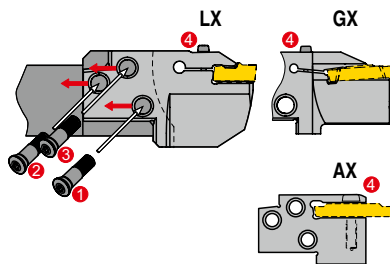

Clamping screws 1, 2 and 3 are used to clamp the modules.
The insert is clamped in the module via the additional screw 4.

FX SX

Self clamping of the insert

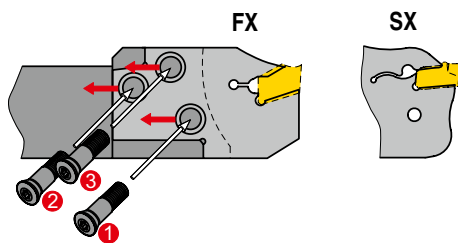

Clamping screws 1, 2 and 3 are used for clamping the module.
The insert is self-clamping.

GX TC

Active insert clamping

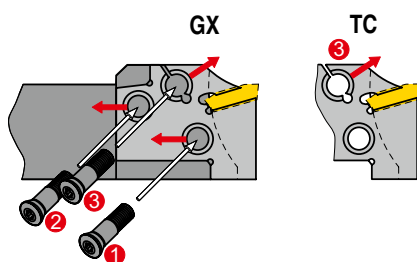

Clamping screws 1 and 2 are used for clamping the module.
Important: first tighten clamp screws 1 and 2.
Then clamp the insert with screw 3.

Torque Moment ModularClamp Module Screws

ModularClamp – Tool holder

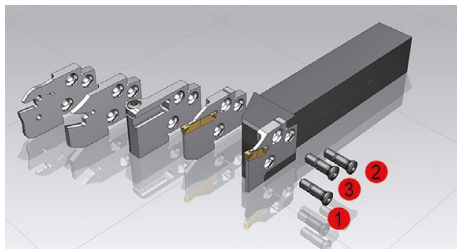

1 Tighten screws to the correct Torque moment in this order.

ModularClamp – Tool holder	Screw	Torx	Torque moment	
			Nm	in.lbs
E12..	M2,5x10	T08	1,2	10,6
E16..	M3,5x12,5	T15	3,2	28,3
E20..	M4x14	T15	4,0	35,4
E25..	M5x18	T20	5,0	44,3
E32..	M6x20	T25	6,0	53,1

ModularClamp – Boring bar

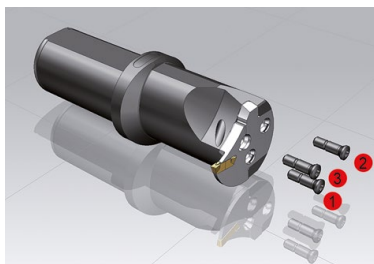

1 Tighten screws to the correct Torque moment in this order.

ModularClamp – Boring bar	Screw	Torx	Torque moment	
			Nm	in.lbs
I16..	M2,5x10	T08	1,2	10,6
I20..	M3x11	T10	2,0	17,7
I25..	M3,5x12,5	T15	3,2	28,3
I32..	M4,5x17	T20	4,0	35,4
I40..	M5x18	T20	5,0	44,3

Tightening torque for the insert clamping

Recommended tightening torque

Grooving systems	Screw	Torx	Torque moment	
			Nm	in.lbs
GX / AX / LX	M3,5	T15	3,2	28,3
	M4,0	T15/T20	4,0	35,4
	M5,0	T20	5,0	44,3

Advantages due to DirectCooling

Internal coolant supply with groove machining has a decisively positive effect on your turning process. In our CERATIZIT grooving range, the following grooving systems have an internal coolant supply:

- ▲ **GX** Grooving holder (single tool)

Advantages due to DirectCooling

- ▲ Improved chip control
- ▲ Longer service life of the indexable insert
- ▲ Greater process security
- ▲ Application of higher cutting data

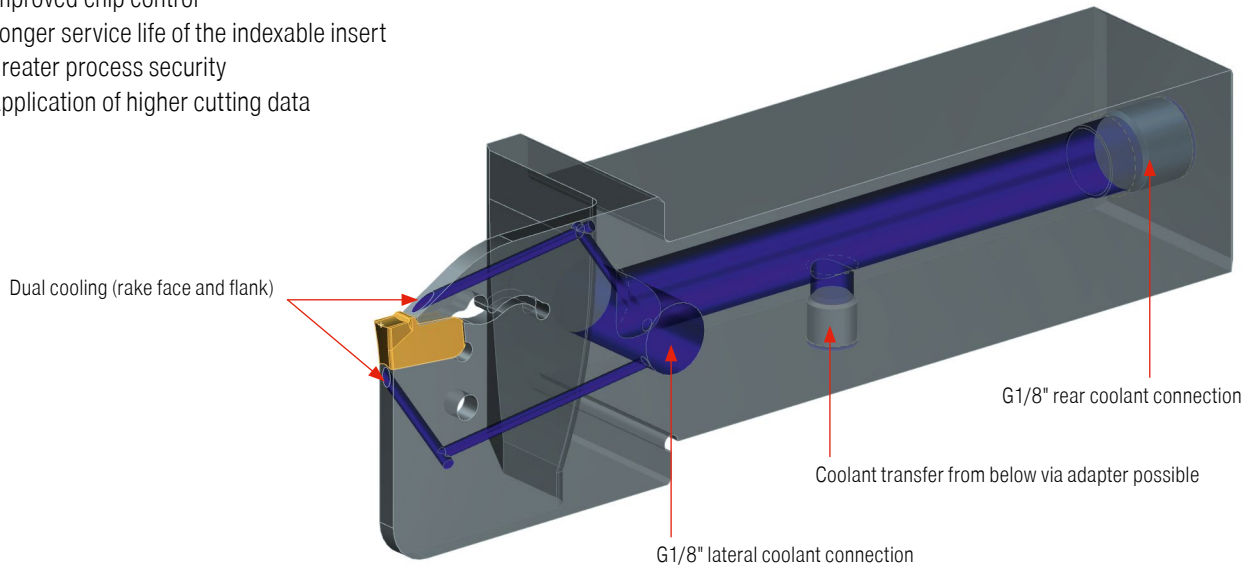

Advantages of the trochoidal turning strategy

- ▲ Less wear and longer tool life due to softer entry and exit
- ▲ Smaller angle of engagement = less vibration
- ▲ Up to 40% higher feed rate values possible
- ▲ Target application: austenitic steels, heat-resistant steels, Inconel and nickel-base alloys as well as long-chipping ductile materials
- ▲ Savings on tools

Trochoidal turning with support of the following CAM systems:

- ▲ hyperMILL – High-performance turning
- ▲ Esprit CAM – ProfitTurning
- ▲ SolidCAM – Turning
- ▲ EdgeCAM – Waveform turning
- ▲ MasterCAM – Dynamic turning

Possible applications

- ▲ Radial and axial recesses and grooves
- ▲ Rough machining – high-speed turning with button insert

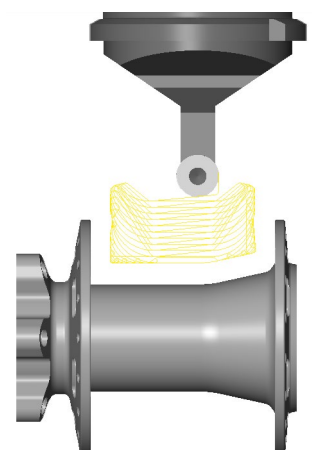
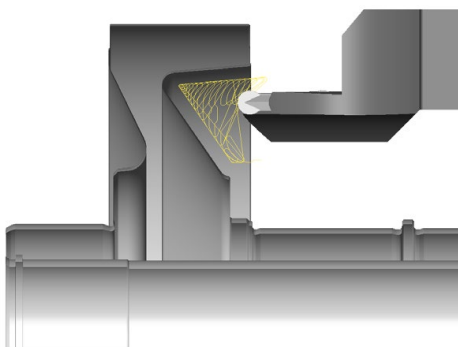

General references

Tool position

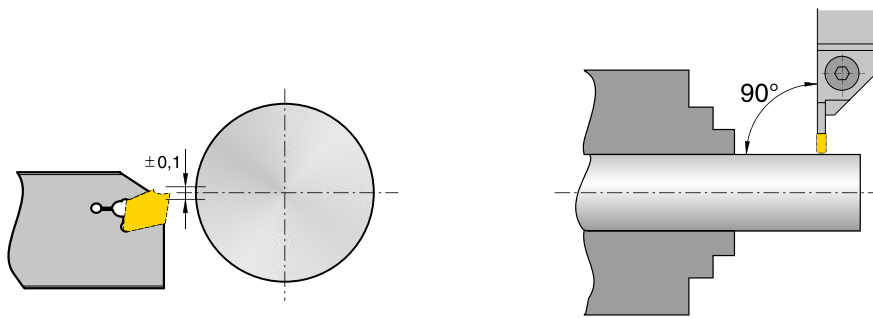

Tool overhang

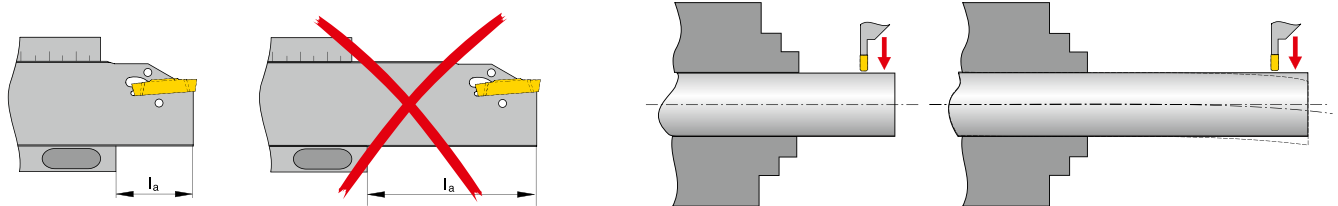

As a rule of thumb: Overhang l_a should not be greater than $8 \times s$ (Groove width).

References for Parting off

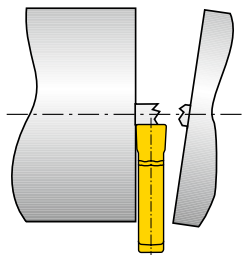

From $\varnothing 0.1969$ inch on, reduce feed "f" by approx. 50%. No parting across centre (risk of breakage).

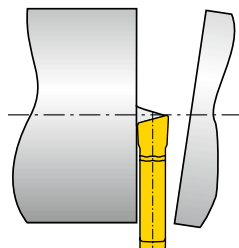

For parting pip-free, use R or L inserts. In order to minimize lateral deflection reduce feed by approx. 20–50 %.

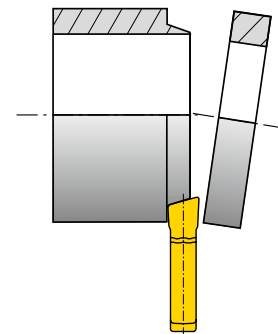

In order to prevent ring formation, use R or L inserts. Reduce feed "f" because of lateral deflection by approx. 20–50%.

References for grooving

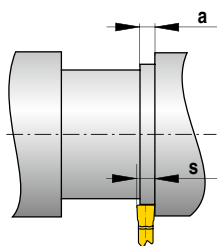

When grooving with an axial displacement the width "a" should amount to at least 70 % of the grooving width "s".

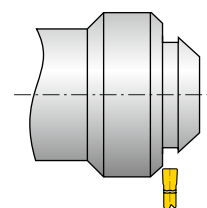

When grooving oblique surfaces the feed should be reduced by approx. 20–50 % until fully engaged.

Trouble shooting guide for grooving FX/SX/GX/LX

Type of problem															
Type of wear				Work piece problems				Chip control					Cutting data	Insert selection	Remedy measures
Edge breakage	Built-up edge	Wear on clearance face	Plastic deformation	Vibration	Formation of pips and burrs	Chattered surface	Surface quality	Chip too long (snarl chip)	Chip too short (fragmented chip)						
	↑	↓	↓	↓			↑	↓		Cutting speed					
↓			↓	↑		↓	↓	↑	↓	Feed rate					
↓		↓	↓		↓	↓	↓			Feed rate at centre	-R -F -M ↑ ↓				
↑	↓		⤿	⤿	↓	↓	↓	↓	↑	Chip groove					
					●					R/L execution					
↑		↑	↑	↓	↓	↓	↑			Corner radius	larger ↑ smaller ↓				
↓		↑	↑							Tool Material	Wear resistance ↑ toughness ↓				
				↓		↑	↑			Groove width					
⤿				⤿		⤿	⤿			Tool clamping					
⤿				⤿		⤿	⤿			Work piece clamping					
⤿				⤿			↓			Overhang					
⤿		⤿		⤿	⤿		⤿			Tip height					
	●	●	●		●		●	●		Cooling lubricant					

↑ raise, increase large influence
↑ raise, increase small influence

↓ avoid, reduce large influence
↓ avoid, reduce small influence

⤿ check, optimise
● use

Trouble shooting guide for TC threading

Type of problem														
Type of wear				Workpiece			Chip control							
Wear on clearance face	Break out cut	Plastic deformation	Built-up edge	Formation of a shoulder at the external thread Ø	Profile	Surface quality	Chatter marks, vibrations	Chip too thick	Chip too thin	Chip shape (snarl chip)				
↓		↓	↑			↑	↓				Cutting speed	Cutting data	Remedy measures	
a, b	a, b		a, b	a, b		a, b	a, b	a, b		a, b	Feed			a – over the flanks b – Alternating flanks
↑	↓	↓		↓	↓	↓	↓	↓	↑	↔	Feed (Cutting depth)			
↓	↑	↑		↔	↔	↑	↔	↑	↓	↓	Number of passes			
				●	●	●					Spring cut (Air cut)			
			●			●	●			●	Chip groove			
↑	↓	↑									Tool Material	↑ Wear resistance ↓ toughness	Indexable insert selection	
				●	●	●					Full profile			
											Partial profile			
	↔					↔	↔				Stable tool holder / insert	Various criteria		
	↔					↔	↔				Stable workpiece			
	↓					↓	↓				Overhang			
↔	↔	↔			↔	↔	↔				Tip height			
●	●	●	●	●		●					Cooling lubricant			

↑ raise, increase large influence
↑ raise, increase small influence

↓ avoid, reduce large influence
↓ avoid, reduce small influence

↔ check, optimise
● use

Wear causes

Wear on clearance face

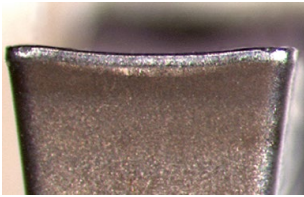

Abrasion on the flank, normal wear after a given operation time

Cause

- ▲ cutting speed too high
- ▲ grade with too low wear resistance
- ▲ insufficient coolant

Remedy

- ▲ Reduce the cutting speed
- ▲ select a more wear resistant grade
- ▲ Improve/check coolant feed

Edge chipping



Excessive mechanical stress on the cutting edge causing carbide particles to break out.

Cause

- ▲ too hard grade
- ▲ vibration
- ▲ too high feed and depth of cut
- ▲ chip impact

Remedy

- ▲ use tougher grade
- ▲ use negative geometry with chip breaker
- ▲ reduce overhang, check center height
- ▲ stabilize the cutting edge

Cratering



The outgoing hot chip causes cratering of the insert on the clamping surface.

Cause

- ▲ too high cutting speed, feed, or both
- ▲ too low rake angle
- ▲ grade with too low wear resistance
- ▲ incorrectly supplied cooling

Remedy

- ▲ Reduce cutting speed and / or feed
- ▲ Check coolant flow and / or increase pressure
- ▲ Use harder grade

Plastic deformation



Large mechanical load produces high temperature machining, this can lead to plastic deformation.

Cause

- ▲ too high operating temperature, thus softening the base material
- ▲ unsuitable grade
- ▲ inadequate coolant supply

Remedy

- ▲ Reduce the cutting speed
- ▲ select a more wear resistant grade
- ▲ use coolant

Built-up edge



Weld deposits of material on the cutting edge occurs when the chip does not flow caused by low average temperature.

Cause

- ▲ too low cutting speed
- ▲ too low rake angle
- ▲ Incorrect grade
- ▲ lack of cooling / lubrication

Remedy

- ▲ Increase the cutting speed
- ▲ Increase rake angle
- ▲ Use TiN coating
- ▲ increase coolant strength

Notch wear

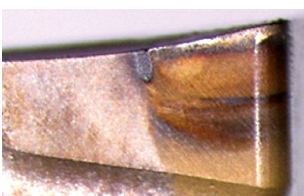

Contraction at maximum cutting depth.

Cause





- ▲ Oxidation at the cutting edge
- ▲ Too high a temperature at the edge

Remedy

- ▲ Use different cutting depths
- ▲ Reduce cutting speed
- ▲ Improve/check coolant feed

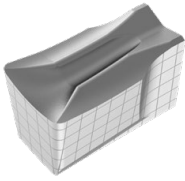
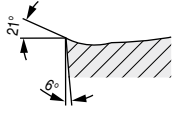
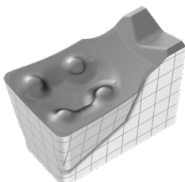
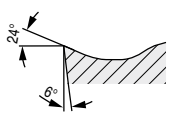

Chip breakers / Applications

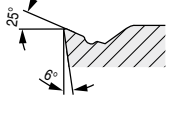
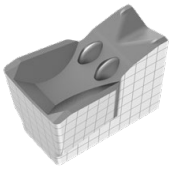
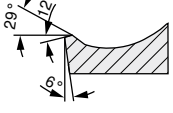
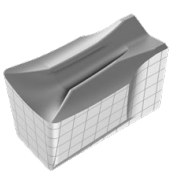
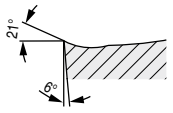
System GX

		Smooth cut 	irregular cut 	interrupted cut 	Model	f in inch/rev.
-F2 ▲ very positive geometry ▲ honed cutting edge ▲ low feed rates ▲ low cutting forces ▲ first choice for stainless materials		CTCP325	CTP1340	CTPP345		.002-.006
		CTP1340	CTP1340/CTPP345	CTPP345		
		CTCP325	CTP1340			
		CTP1340	CTP1340	CTPP345		
		CTCP325				
		CTP1340	CTP1340			
-Standard / -E ▲ positive geometry ▲ low-medium feed rates ▲ low cutting forces ▲ universal application ▲ first choice for axial grooving		CTCP325	CTCP335/CTP1340	CTPP345		.002-.007
		CTP1340	CTP1340/CTPP345	CTPP345		
		CTCP325	CTCP335/CTP1340	CTP1340		
		CTP1340	CTP1340	CTPP345		
		CTCP325				
		CTP1340	CTP1340			
-M40 ▲ stable geometry ▲ medium feed rates ▲ universal application ▲ good chip control		CTCP325	CTP1340	CTPP345		.003-.008
		CTP1340	CTP1340/CTPP345	CTPP345		
		CTCP325	CTCP325/CTP1340	CTP1340		
		CTP1340	CTP1340	CTPP345		
		CTCP325				
		CTP1340	CTP1340			
-M1 ▲ very stable cutting edge ▲ medium-high feed rates ▲ for interrupted cut ▲ for high tensile materials ▲ first choice for parting off		CTCP325	CTP1340	CTPP345		.004-.008
		CTP1340	CTP1340/CTPP345	CTPP345		
		CTCP325	CTCP325/CTP1340	CTP1340		
		CTP1340	CTP1340	CTPP345		
		CTCP325				
		CTP1340	CTP1340			
-27P ▲ very positive geometry ▲ ground periphery ▲ sharp cutting edge ▲ polished chip breaker ▲ first choice for non-ferrous metals						.002-.010
		H216T	H216T	H216T		
		H216T	H216T	H216T		
		H216T	H216T			
		H216T				
		H216T				

Chip breakers / Applications

System GX

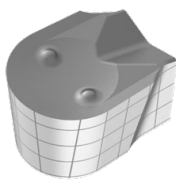
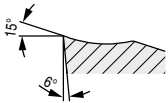
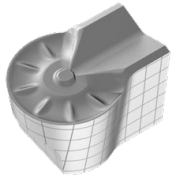
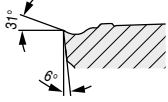
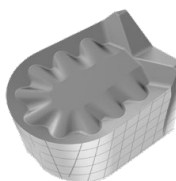
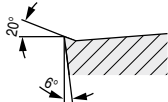
		Smooth cut 	irregular cut 	interrupted cut 	Model	f in inch/rev.
Standard – Radius ▲ positive geometry ▲ honed cutting edge ▲ low-medium feed rates ▲ low cutting forces ▲ Radius grooving/copy turning		CTCP325	CTCP325/CTP1340	CTP1340		.0018-.008
		CTP1340	CTP1340	CTP1340		
		CTCP325	CTCP325/CTP1340	CTP1340		
		CTP1340	CTP1340			
		CTCP325				
		CTP1340	CTP1340			
-M3 – Radius ▲ stable geometry ▲ medium-high feed rates ▲ high surface quality ▲ Radius grooving/copy turning		CTCP325	CTCP325/CTCP335	CTCP335		.003-.008
		CTCP335	CTCP335			
		CTCP325	CTCP325/CTCP335	CTCP335		
		CTCP325				
		CTCP325				
		CTCP325				
-27P – Radius ▲ very positive geometry ▲ ground periphery ▲ sharp cutting edge ▲ polished chip breaker ▲ first choice for non-ferrous metals						.002-.012
		H216T	H216T	H216T		
		H216T	H216T	H216T		
		H216T	H216T			
		H216T				

Circlip grooving

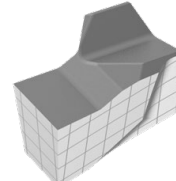
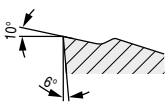



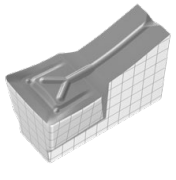
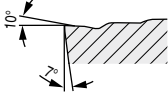





Standard ▲ positive geometry ▲ honed cutting edge ▲ low feed rates ▲ small corner radius ▲ Circlip grooves		CTP1340	CTP1340	CTP1340		.002-.012
		CTP1340	CTP1340	CTP1340		
		CTP1340	CTP1340	CTP1340		
		CTP1340	CTP1340	CTP1340		
		CTP1340	CTP1340	CTP1340		
		CTP1340	CTP1340			

System AX

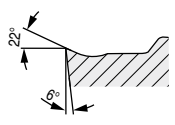
-F50 ▲ positive geometry ▲ honed cutting edge ▲ low feed rates ▲ small corner radius ▲ Circlip grooves		CTP1340	CTP1340	CTP1340		.001-.005
		CTP1340	CTP1340	CTP1340		
		CTP1340	CTP1340	CTP1340		
		CTP1340	CTP1340	CTP1340		
		CTP1340	CTP1340	CTP1340		
		CTP1340	CTP1340			

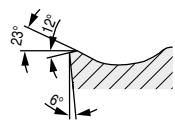
Chip breakers / Applications

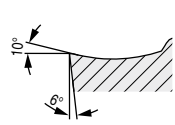
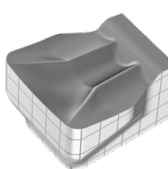
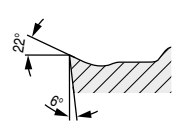

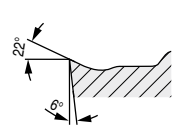
System SX

		Smooth cut 	irregular cut 	interrupted cut 	Model	f in inch/rev.
-F2 ▲ very positive geometry ▲ honed cutting edge ▲ low feed rates ▲ low cutting forces ▲ first choice for stainless materials		CTCP325	CTCP325/CTP1340	CTPP345		.002-.006
		CTP1340	CTP1340/CTPP345	CTPP345		
		CTCP325	CTCP325/CTP1340	CTP1340		
		CTP1340	CTP1340	CTPP345		
		CTCP325				
		CTP1340	CTP1340			
-M1 ▲ very stable cutting edge ▲ medium-high feed rates ▲ for interrupted cut ▲ for high tensile materials ▲ first choice for parting off		CTCP325	CTCP335/CTP1340	CTPP345		.004-.008
		CTP1340	CTP1340	CTPP345		
		CTCP325	CTCP325/CTP1340	CTP1340		
		CTP1340	CTP1340	CTPP345		
		CTCP325				
		CTP1340	CTP1340			
-M2 ▲ stable geometry ▲ medium feed rates ▲ universal application ▲ good chip control		CTCP325	CTCP335/CTP1340	CTPP345		.003-.008
		CTP1340	CTP1340	CTPP345		
		CTCP325	CTCP325/CTP1340	CTP1340		
		CTP1340	CTP1340	CTPP345		
		CTCP325				
		CTP1340	CTP1340			
-27P ▲ very positive geometry ▲ ground periphery ▲ sharp cutting edge ▲ polished chip breaker ▲ first choice for non-ferrous metals						.002-.010
		H216T	H216T	H216T		
		H216T	H216T	H216T		
		H216T	H216T			
		H216T				
-M3 – Radius ▲ stable geometry ▲ medium-high feed rates ▲ high surface quality ▲ Radius grooving / Copy turning		CTCP335	CTCP335/CTP1340	CTP1340		.002-.008
		CTP1340	CTP1340	CTP1340		
		CTCP335	CTCP335/CTP1340	CTP1340		
		CTP1340	CTP1340	CTP1340		
		CTCP325				
		CTP1340	CTP1340			

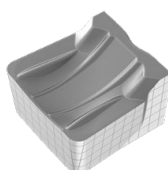
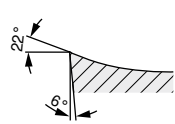
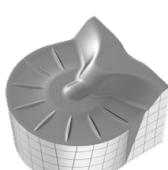
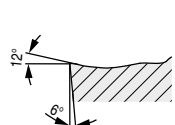
System LX

-M2 ▲ stable geometry ▲ medium feed rates ▲ universal application ▲ good chip control		CTCP325	CTCP335/CTP1340	CTCP335		.008-.020
		CTCP335	CTP1340	CTP1340		
		CTCP325	CTCP325	CTCP335		
		CTP1340	CTP1340	CTP1340		
		CTCP325				
		CTP1340	CTP1340			
-M3 – Radius ▲ stable geometry ▲ medium-high feed rates ▲ high surface quality ▲ Radius grooving/copy turning		CTCP325	CTCP335/CTP1340	CTCP335		.002-.014
		CTCP335	CTCP335/CTP1340	CTP1340		
		CTCP325	CTCP325/CTCP335	CTCP335		
		CTP1340	CTP1340	CTP1340		
		CTCP325				
		CTP1340	CTP1340			

Chip breakers / Applications

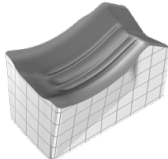
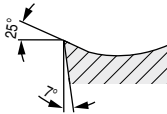
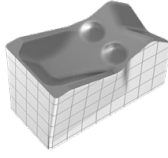
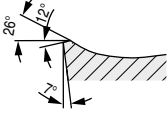
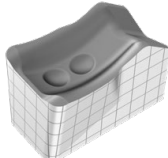
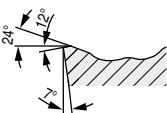
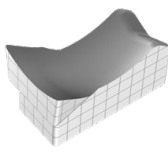
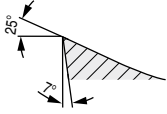
System FX		Smooth cut	irregular cut	interrupted cut	Model	f in inch/rev.
						
-F1 ▲ very positive geometry ▲ low-medium feed rates ▲ low cutting forces ▲ good chip control ▲ low cutting edge build up		CTCP325	CTCP325/CTP1340	CTPP345		.002-.006
		CTP1340	CTP1340/CTPP345	CTPP345		
		CTCP325	CTCP325/CTP1340	CTP1340		
		CTP1340	CTP1340	CTPP345		
		CTCP325				
		CTP1340	CTP1340			
		CTP1340	CTP1340			
-M1 ▲ very stable cutting edge ▲ medium-high feed rates ▲ for interrupted cut ▲ for high tensile materials ▲ first choice for parting off		CTCP325	CTCP335/CTP1340	CTPP345		.003-.008
		CTP1340	CTP1340/CTPP345	CTPP345		
		CTCP325	CTCP325/CTP1340	CTP1340		
		CTP1340	CTP1340	CTPP345		
		CTCP325				
		CTP1340	CTP1340			
		CTP1340	CTP1340			
-R2 ▲ very stable cutting edge ▲ high feed rates ▲ good chip control		CTCP325	CTCP325/CTP1340	CTPP345		.004-.011
		CTP1340	CTP1340/CTPP345	CTPP345		
		CTCP325	CTCP325/CTP1340	CTP1340		
		CTP1340	CTP1340	CTPP345		
		CTCP325				
		CTP1340	CTP1340			
		CTP1340	CTP1340			
-27P ▲ very positive geometry ▲ ground periphery ▲ sharp cutting edge ▲ polished chip breaker ▲ first choice for non-ferrous metals						.001-.005
		H216T	H216T	H216T		
		H216T	H216T	H216T		
		H216T	H216T			
		H216T				
		H216T				

Example of Coding Grooving Tools

Grooving insert

GX	16	E	2	3.00	N	0.50
Grooving system (GX)	Insert length (16 mm / .6299 inch)	Type of insert, application	Width class of the holder/ module or support surface (2 mm / .0787 inch)	Groove width (3.0 mm / .1181 inch)	Insert seat N=Neutral L=Left Handed R=Right Handed	Corner radius size (0.5 mm / .0197 inch)
E	25	R	R	GX	16	2
Application E = external I = internal	Size (25 mm / .9843 inch)	Module version R=Right Handed L=Left Handed	Maximum groove depth (12 mm / .4724 inch)	Grooving system (GX)	Insert size (16 mm / .6299 inch)	Width class ²

Basic holder

E	25	R	00	2525	L
Application E = external I = internal	Size (25 mm / .9843 inch)	Holder version R=Right Handed L=Left Handed	Approach angle 0°	Shank type 25x25mm / .9843 x .9843 inch	Shank length L = (sh. ISO)

Monobloc tool holder

E	25	R	00	2525	M	K	DC	SX3
Application E = external I = internal	Size (25 mm / .9843 inch)	Holder version R=Right Handed L=Left Handed	Approach angle 0°	Shank type 25x25mm / .9843 x .9843 inch	Shank length M = (sh. ISO)	Insert clamping K = Key	Cooling system DC = Direct Cooling	Grooving system/width (3 mm / .1181 inch)



Compilation

Basic holder

Module

E25 R 00 - 2525L

E25 R 12 - GX 16-2

Grooving insert

GX 16-2 E3.00 N 0.50

Grades Overview

CTCP325

- ▲ Carbide, TiCN-Al₂O₃-coated
- ▲ ISO | **P25** | M20 | **K30** | S25
- ▲ The wear-resistant solution for steel and cast iron materials at high cutting speeds

CTCP335

- ▲ Carbide, TiCN-Al₂O₃-coated
- ▲ ISO | **P35** | M30 | **K35**
- ▲ The reliable choice for machining steel and cast iron materials

CTPP345

- ▲ Carbide, TiAlTaN-coated
- ▲ ISO | **P45** | **M40** | S40
- ▲ The reliable solution for steel materials and austenitic steels under unstable conditions

CTP1340

- ▲ Carbide, TiAlTaN-coated
- ▲ ISO | **P30** | **M25** | **K30** | N30 | **S30** | O30
- ▲ The universal high-performance grade for steel materials, austenitic steel, cast iron materials and heat-resistant alloys

CTPP520

- ▲ Carbide, TiAlTaN-coated
- ▲ ISO | **P20** | **M15** | **K25** | S25 | H5
- ▲ The wear-resistant grade for wet machining of steels

CTPP535

- ▲ Carbide, AlTiN-coated
- ▲ ISO | **P35** | **M30** | **K25** | **S30**
- ▲ The tough thread turning grade for universal application

H216T

- ▲ Carbide, uncoated
- ▲ ISO | **K15** | **N15** | S15 | O5
- ▲ The uncoated carbide grade for machining aluminium and other non-ferrous metals
- ▲ Also highly suitable for HSC machining

Application

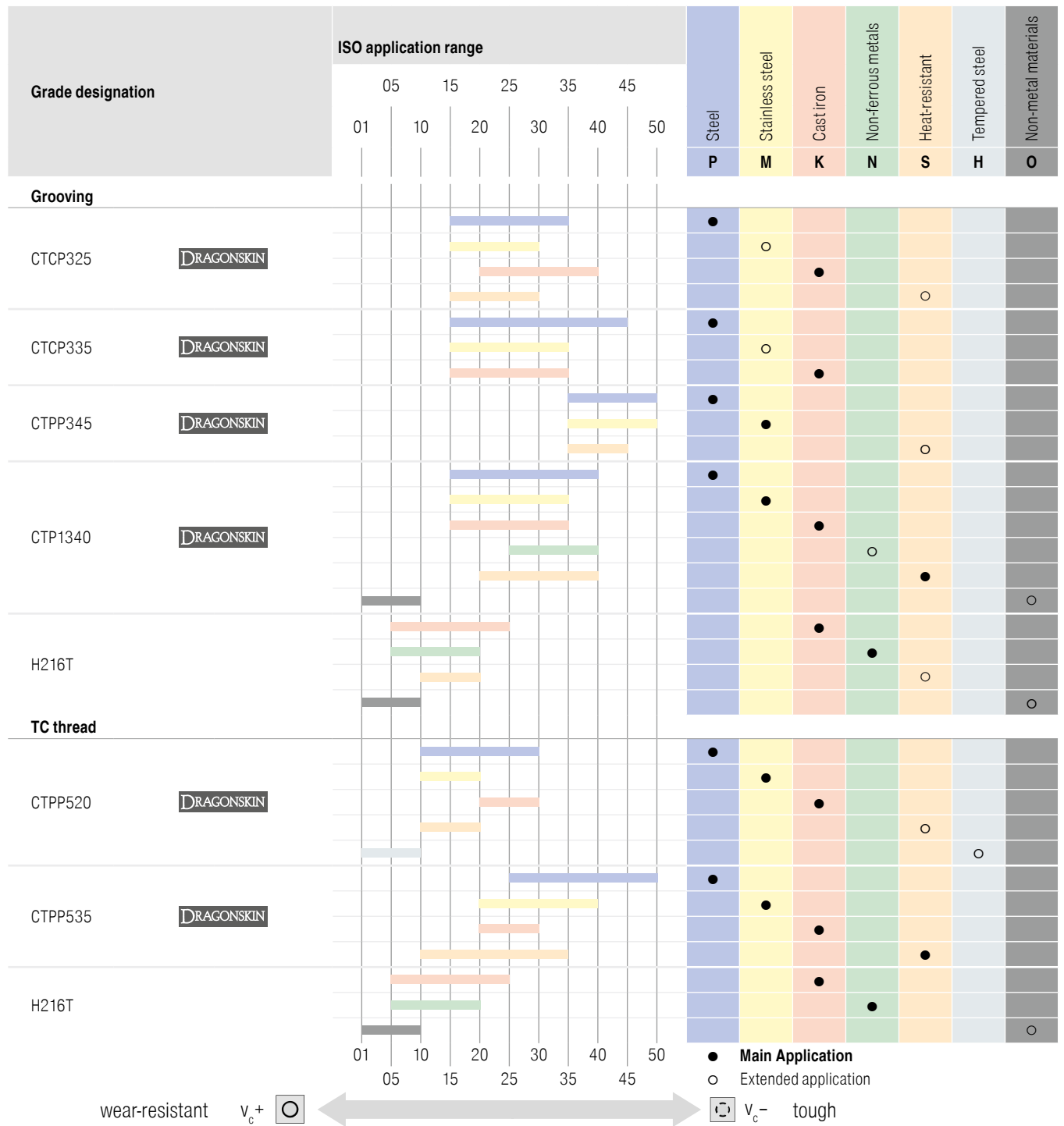

New products for machining technicians



→ Page 16-23

NEW FreeTurn

The innovative and extremely flexible FreeTurn tools have 3 cutting edges and are suitable for almost all external turning operations.

With High Dynamic Turning ("HDT", for short) and the dynamic FreeTurn turning tools, CERATIZIT is turning the conventional method of turning completely on its head. All familiar turning operations such as roughing, finishing, contour turning, facing and longitudinal turning can now be completed using just one tool.

Curious? More information about High Dynamic Turning and FreeTurn can be found on our website:



<https://cutting.tools/us/en/freeturn>

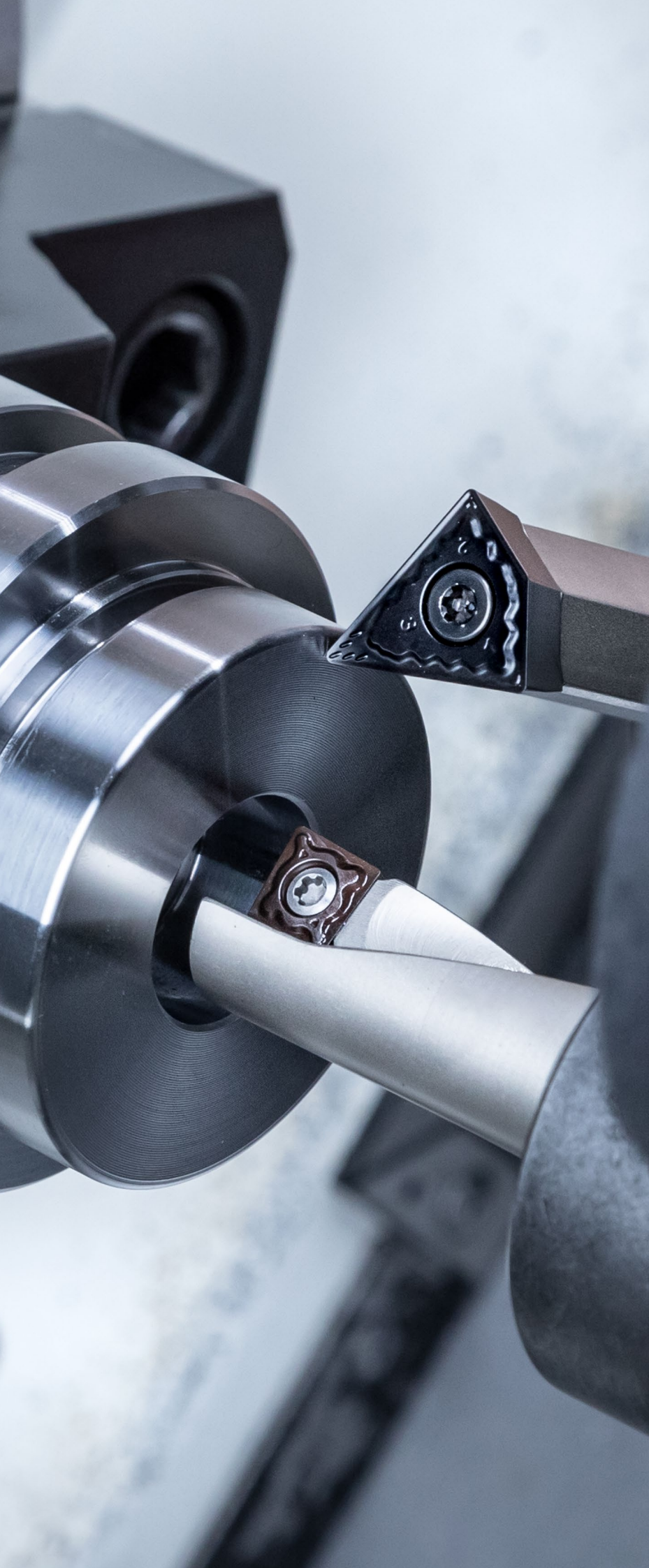

1 Indexable Drilling

Holemaking

2 Indexable Boring

3 Reaming

4 Indexable Turning

Turning

5 Parting and Grooving

6 Multifunction

6

Milling

7 Indexable Milling

8 Solid Milling

9 Material examples and
article no. index

Table of contents

Advantages of FreeTurn / EcoCut	2+3
Example applications / explanation of symbols	3
Toolfinder	4+5
Product program	6-23
Technical Information	
General cutting data	24-26
EcoCut Mini Cutting Data	27+28
EcoCut Classic Cutting Data	29+30
EcoCut ProfileMaster Cutting Data	31+32
FreeTurn cutting data	33
EcoCut chip breaker overview	34
FreeTurn chip breaker overview	35
Application information	36-44
Grade overview and application	45+46
FreeTurn / EcoCut designation system	47+48

CERATIZIT \ Performance

Premium quality tools for high performance.

The premium quality tools from the **CERATIZIT Performance** product line have been designed for specific applications and are distinguished by their outstanding performance. If you make high demands on the performance of your production and want to achieve the very best results, we recommend the Premium tools in this product line.

Advantages of FreeTurn

Flexibility



Productivity

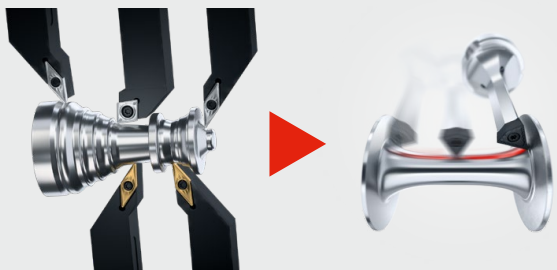

Stability

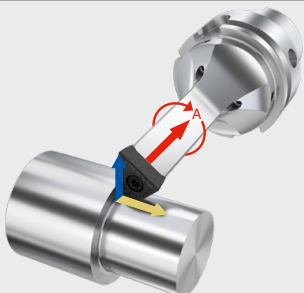



Advantages of EcoCut

- ▲ reduced machining time
- ▲ reduced need for tool positions
- ▲ generates flat bottom of hole
- ▲ less programming
- ▲ lower set-up costs / reduced setting time
- ▲ time savings due to fewer tool changes



Application examples

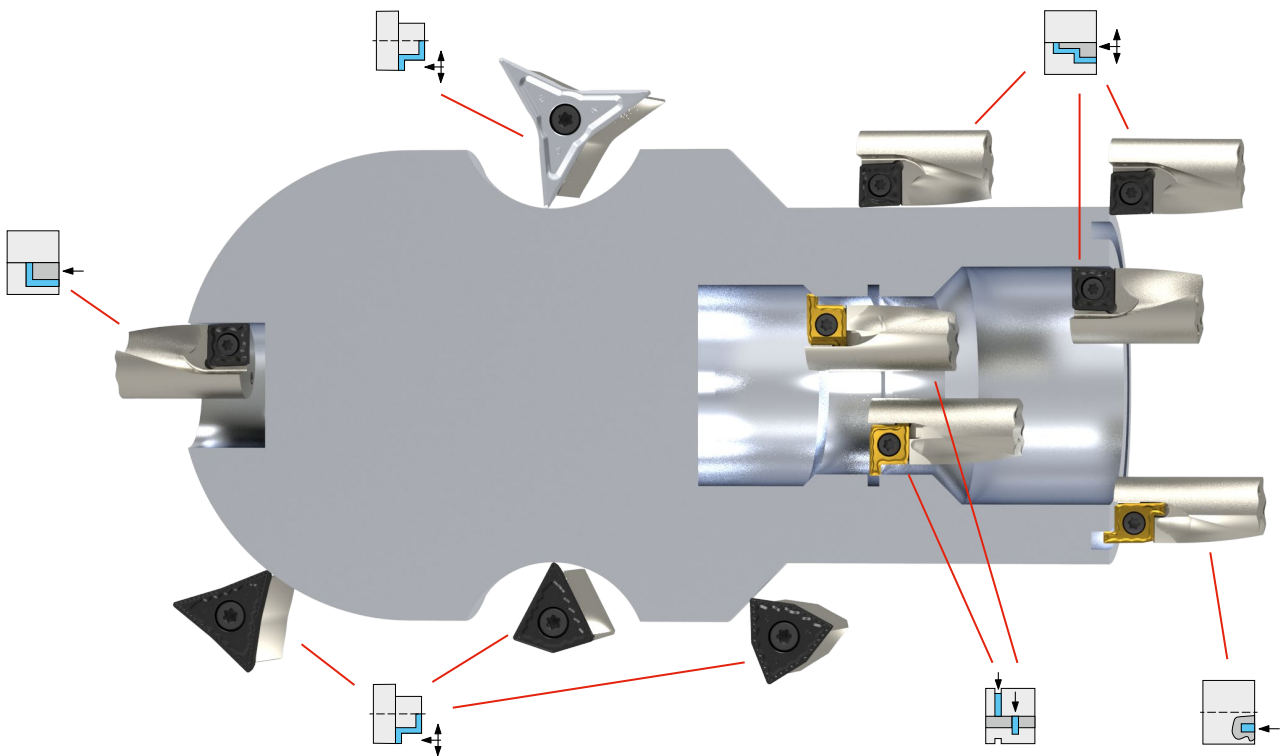

6

Symbol explanation

Turning outside profiles	Drilling into solid material	Turning internal profiles	External / internal radial grooving	Axial grooving	Int. coolant supply

-28P — Polished chip breaker	F — Fine Machining			Smooth cut
H216T — Carbide Grade	M — Medium Machining			Irregular cutting depth
	R — Rough Machining			Interrupted cut

Toolfinder

Tool system

EcoCut Mini

EcoCut Classic

Application

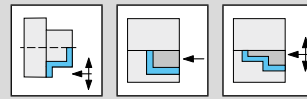
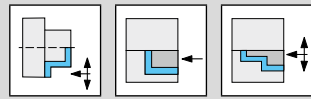

Machine interface

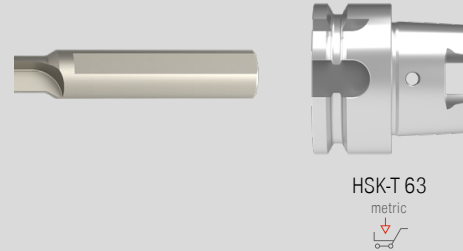

Lengths and diameters
Versions

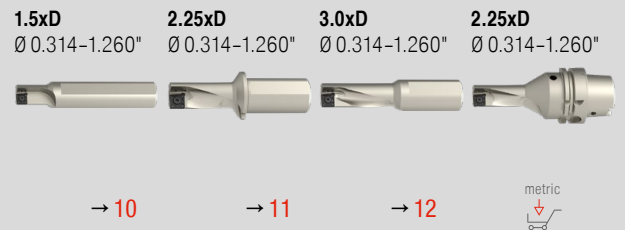
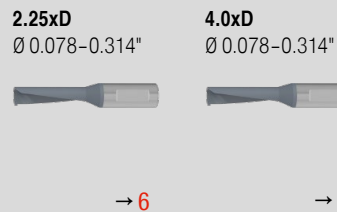

Grade description

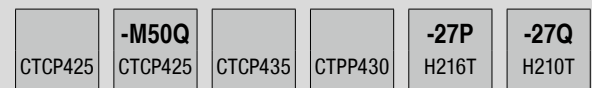
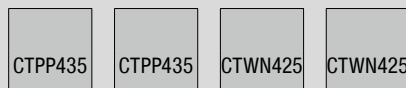

Cutting conditions

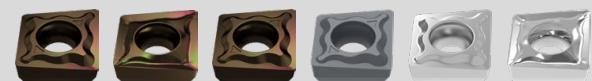
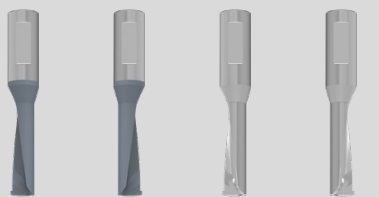

Solid carbide	Solid carbide	Solid carbide	Solid carbide
Left-hand	Right-hand	Left-hand	Right-hand

M	M	M	M	M	M
XCNT	XCNT	XCNT	XCNT	XCET	XCET

Application range

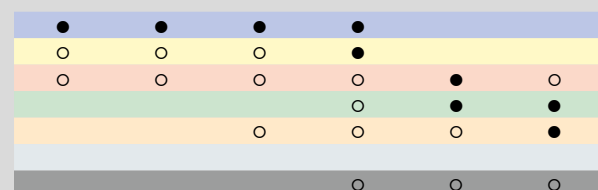
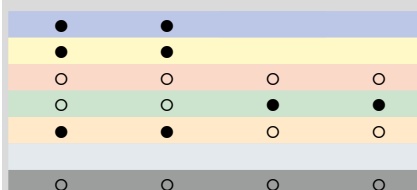

Page No.

→ 6 → 6 → 6 → 6
→ v_c Page 25

→ 9 → 9 → 9 → 9 → 9 → 9
→ v_c Page 25



EcoCut tools are suitable for off-center drilling. This allows for creating a larger diameter hole from the nominal diameter of the tool → **For details, see the technical information.**

EcoCut ProfileMaster

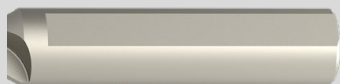
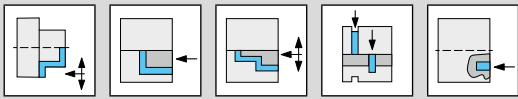

1.5xD
Ø 0.394-1.260"



→ 14

2.25xD
Ø 0.394-1.260"



→ 15

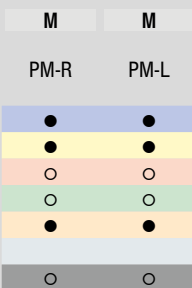

→ 13

→ 13

→ v. Page 25

FreeTurn

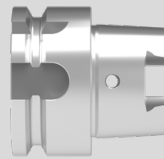

HSK-T 63

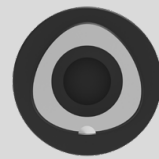

PSC 63

LPR = 3.937"
LPR = 4.921"



→ 19+22

LPR = 3.937"
LPR = 4.921"



→ 20+23

-28P H216T	CTCP125	CTPM125	CTCP125	CTPM125	CTCP125	CTPM125
DRAGONSKIN	DRAGONSKIN	DRAGONSKIN	DRAGONSKIN	DRAGONSKIN	DRAGONSKIN	DRAGONSKIN
F F F FT15 . 353535...	F F F FT15 . 555555...	M M F FT15 . 808055...	M M F FT15 . 808055...	M M M FT17 . 808080...	M M M FT17 . 808080...	M M M FT17 . 808080...
→ 16	→ 17	→ 17	→ 18	→ 18	→ 21	→ 21

→ v. Page 26

EcoCut – Mini

▲ Drilling and turning tool for small diameters

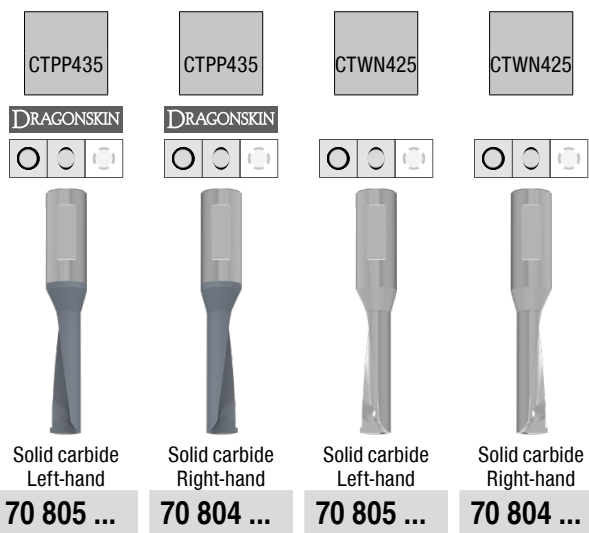
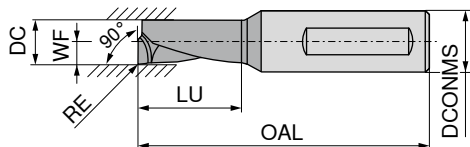
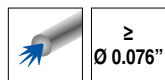

Designation	DC inch	DCONMS inch	OAL inch	LU inch	WF inch	RE inch	70 805 ...		70 804 ...		70 805 ...		70 804 ...	
							Left-hand	Right-hand	Left-hand	Right-hand	Left-hand	Right-hand	Left-hand	Right-hand
ECM 02 R/L 2,25D	0.079	0.157	1.102	0.177	0.039	0.004	320	320						
ECM 02 R/L 2,25D AL	0.079	0.157	1.102	0.177	0.039	0.004					420	420		
ECM 02 R/L 4,00D	0.079	0.157	1.220	0.315	0.039	0.004	321	321						
ECM 02 R/L 4,00D AL	0.079	0.157	1.220	0.315	0.039	0.004					421	421		
ECM 02,5 R/L 2,25D	0.098	0.157	1.142	0.222	0.049	0.004	325	325						
ECM 02,5 R/L 2,25D AL	0.098	0.157	1.142	0.222	0.049	0.004					425	425		
ECM 02,5 R/L 4,00D	0.098	0.157	1.299	0.394	0.049	0.004	326	326						
ECM 02,5 R/L 4,00D AL	0.098	0.157	1.299	0.394	0.049	0.004					426	426		
ECM 03 R/L 2,25D	0.118	0.157	1.220	0.266	0.059	0.004	330	330						
ECM 03 R/L 2,25D AL	0.118	0.157	1.220	0.266	0.059	0.004					430	430		
ECM 03 R/L 4,00D	0.118	0.157	1.378	0.472	0.059	0.004	331	331						
ECM 03 R/L 4,00D AL	0.118	0.157	1.378	0.472	0.059	0.004					431	431		
ECM 03,5 R/L 2,25D	0.138	0.157	1.260	0.310	0.069	0.004	335	335						
ECM 03,5 R/L 2,25D AL	0.138	0.157	1.260	0.310	0.069	0.004					435	435		
ECM 03,5 R/L 4,00D	0.138	0.157	1.457	0.551	0.069	0.004	336	336						
ECM 03,5 R/L 4,00D AL	0.138	0.157	1.457	0.551	0.069	0.004					436	436		
ECM 04 R/L 2,25D	0.157	0.236	1.378	0.354	0.079	0.008	300	300						
ECM 04 R/L 2,25D AL	0.157	0.236	1.378	0.354	0.079	0.008					450	450		
ECM 04 R/L 4,00D	0.157	0.236	1.614	0.630	0.079	0.008	301	301						
ECM 04 R/L 4,00D AL	0.157	0.236	1.614	0.630	0.079	0.008					451	451		
ECM 05 R/L 2,25D	0.197	0.236	1.457	0.443	0.098	0.008	302	302						
ECM 05 R/L 2,25D AL	0.197	0.236	1.457	0.443	0.098	0.008					452	452		
ECM 05 R/L 4,00D	0.197	0.236	1.772	0.787	0.098	0.008	303	303						
ECM 05 R/L 4,00D AL	0.197	0.236	1.772	0.787	0.098	0.008					453	453		
ECM 06 R/L 2,25D	0.236	0.315	1.496	0.531	0.118	0.008	306	306						
ECM 06 R/L 2,25D AL	0.236	0.315	1.496	0.531	0.118	0.008					456	456		
ECM 06 R/L 4,00D	0.236	0.315	1.929	0.945	0.118	0.008	312	312						
ECM 06 R/L 4,00D AL	0.236	0.315	1.929	0.945	0.118	0.008					462	462		
ECM 07 R/L 2,25D	0.276	0.315	1.654	0.620	0.138	0.008	308	308						
ECM 07 R/L 2,25D AL	0.276	0.315	1.654	0.620	0.138	0.008					458	458		
ECM 07 R/L 4,00D	0.276	0.315	2.087	1.102	0.138	0.008	314	314						
ECM 07 R/L 4,00D AL	0.276	0.315	2.087	1.102	0.138	0.008					464	464		
ECM 08 R/L 2,25D	0.315	0.315	1.772	0.709	0.157	0.008	310	310						
ECM 08 R/L 2,25D AL	0.315	0.315	1.772	0.709	0.157	0.008					460	460		
ECM 08 R/L 4,00D	0.315	0.315	2.244	1.260	0.157	0.008	316	316						
ECM 08 R/L 4,00D AL	0.315	0.315	2.244	1.260	0.157	0.008					466	466		

P	●	●				
M	●	●				
K	○	○	○	○	○	○
N	○	○	●	●		
S	●	●	○	○		
H						
O	○	○	○	○		

EcoCut – Adapter Mini

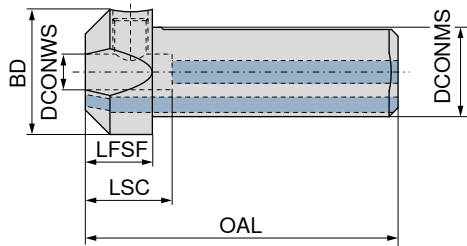

Designation	DCONWS inch	DCONMS inch	BD inch	OAL inch	LFSF inch	LSC inch	70 800 ...
EC-ADX12-04-E	0.157	0.750	0.984	2.500	0.551	0.708	719
EC-ADX12-06-E	0.236	0.750	0.984	2.500	0.551	0.708	986
EC-ADX12-08-E	0.314	0.750	0.984	2.500	0.551	0.708	988



**Spare parts
for Article no.**

Article no.	Part description	Quantity
70 800 719	M5x10 ISO 4026	867
70 800 986	M8x1x8 - SW4	123
70 800 988	M8x1x8 - SW4	123



Metric Adaptors can be found in our Online-Shop or in the Metric Catalog 2021



EcoCut – Mini adapter with coolant connection thread

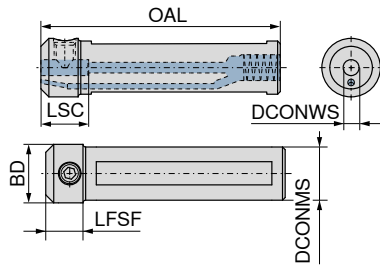

70 801 ...

Designation	DCONWS inch	DCONMS inch	BD inch	OAL inch	LFSF inch	LSC inch	
ECA 0750-04	0.157	0.750	0.787	3.937	0.551	0.708	719
ECA 1000-04	0.157	1.000	0.984	4.330	0.551	0.708	726
ECA 0750-06	0.236	0.750	0.866	3.937	0.551	0.708	819
ECA 1000-06	0.236	1.000	0.984	4.330	0.551	0.708	826
ECA 0750-08	0.314	0.750	0.866	3.937	0.551	0.708	919
ECA 1000-08	0.314	1.000	0.984	4.330	0.551	0.708	926



Metric Adaptors can be found in our Online-Shop or in the Metric Catalog 2021



70 950 ...

Spare parts for Article no.		
70 801 726	M5x10 ISO 4026	867
70 801 819	M8x1x8 - SW4	123
70 801 826	M8x1x8 - SW4	123
70 801 919	M8x1x8 - SW4	123
70 801 926	M8x1x8 - SW4	123

XCNT / XCET

Designation	S inch	D1 inch	IC inch
XC.T 0401..	0.070	0.082	0.177
XC.T 0502..	0.082	0.088	0.228
XC.T 0602..	0.093	0.098	0.255
XC.T 0703..	0.125	0.110	0.299
XC.T 0803..	0.125	0.133	0.334
XC.T 09T3..	0.156	0.133	0.377
XC.T 10T3..	0.156	0.173	0.417
XC.T 1304..	0.187	0.208	0.531
XC.T 1705..	0.218	0.208	0.688

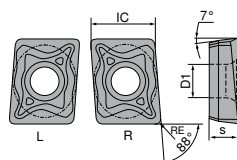

XC.T 04..

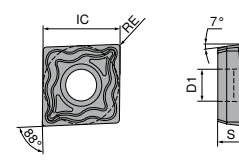

XC.T 05../06../07../08../09../10../13../17..

XCNT / XCET

CTCP425	-M50Q CTCP425	CTCP435	CTPP430	-27P H216T	-27Q H210T
DRAGONSKIN	DRAGONSKIN	DRAGONSKIN	DRAGONSKIN		
M XCNT	M XCNT	M XCNT	M XCNT	M XCET	M XCET
70 386 ...	70 386 ...	70 386 ...	70 386 ...	70 286 ...	70 286 ...

ISO	RE inch	70 386 ...	70 386 ...	70 386 ...	70 386 ...	70 286 ...	70 286 ...
040102EL	0.008	720		820	920		
040102ER	0.008	722		822	922		
040102FL	0.008					620	120
040102FR	0.008					622	122
040104EL	0.016	700	750	800	900		
040104ER	0.016	702	752	802	902		
040104FL	0.016					600	100
040104FR	0.016					602	102
050202EN	0.008	723		823	923		
050202FN	0.008					623	123
050204EN	0.016	703	753	803	903		
050204FN	0.016					603	103
060202EN	0.008	724		824	924		
060202FN	0.008					624	124
060204EN	0.016	704	754	804	904		
060204FN	0.016					604	104
070304EN	0.016	705	755	805	905		
070304FN	0.016					605	105
080304EN	0.016	706	756	806	906		
080304FN	0.016					606	106
09T304EN	0.016	707	757	807	907		
09T304FN	0.016					607	107
10T304EN	0.016	708	758	808	908		
10T304FN	0.016					608	108
10T308EN	0.031	738	788	838	938		
10T308FN	0.031					628	128
130404EN	0.016	710	760	810	910		
130404FN	0.016					610	110
130408EN	0.031	740	790	840	940		
130408FN	0.031					611	111
170508EN	0.031	712	762	812	912		
170508FN	0.031					612	112

P	●	●	●	●			
M	○	○	○	○	●		
K	○	○	○	○	●	●	○
N					○	●	●
S			○	○	○		●
H							
O					○	○	○

→ v_c Page 25

EcoCut – Classic 1.5xD

▲ Drilling and turning tool

Scope of supply:

Toolholder with one clamping screw, two spare screws and a screwdriver

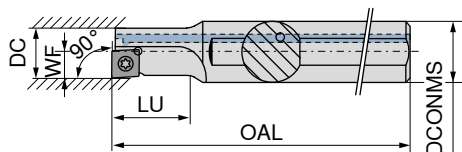
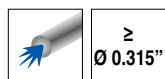

Left-hand

Right-hand

78 805 ...

78 804 ...

Designation	DC inch	DCONMS inch	OAL inch	LU inch	WF inch	torque moment Nm	Insert		
ECC 08 L 1,5D 04-E	0.315	0.500	3.100	0.470	0.157	0,4	XC.T 0401..EL		00800 ²⁾
ECC 08 R 1,5D 04-E	0.315	0.500	3.100	0.470	0.157	0,4	XC.T 0401..ER		00800 ¹⁾
ECC 10 R/L 1,5D 05-E	0.394	0.500	3.500	0.590	0.197	0,7	XC.T 0502..	01000	01000
ECC 12 R/L 1,5D 06-E	0.472	0.625	3.900	0.710	0.236	1,0	XC.T 0602..	01200	01200
ECC 14 R/L 1,5D 07-E	0.551	0.625	4.300	0.830	0.276	1,2	XC.T 0703..	01400	01400
ECC 16 R/L 1,5D 08-E	0.630	0.750	4.900	0.940	0.315	2,2	XC.T 0803..	01600	01600
ECC 18 R/L 1,5D 09-E	0.709	1.000	5.300	1.060	0.354	2,2	XC.T 09T3..	01800	01800
ECC 20 R/L 1,5D 10-E	0.787	1.000	5.900	1.180	0.394	3,2	XC.T 10T3..	02000	02000
ECC 25 R/L 1,5D 13-E	0.984	1.250	7.000	1.480	0.492	5,0	XC.T 1304..	02500	02500
ECC 32 R/L 1,5D 17-E	1.260	1.500	7.800	1.890	0.630	5,0	XC.T 1705..	03200	03200

1) Note! Right-hand insert on right-hand tool → Page 39

2) Note! Left-hand insert on left-hand tool → Page 39

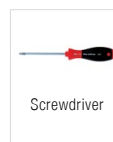

Screwdriver



Clamping screw

80 950 ...

70 950 ...

Spare parts for Article no.

78 805 00800	T06 - IP	123	M1,8x3,6 - IP	862
78 804 00800	T06 - IP	123	M1,8x3,6 - IP	862
78 804 01000 / 78 805 01000	T06 - IP	123	M2x4,3 - IP	863
78 804 01200 / 78 805 01200	T07 - IP	124	M2,2x5 - IP	856
78 804 01400 / 78 805 01400	T08 - IP	125	M2,5x6 - IP	857
78 804 01600 / 78 805 01600	T09 - IP	126	M3x7 - IP	819
78 804 01800 / 78 805 01800	T09 - IP	126	M3x7 - IP	819
78 804 02000 / 78 805 02000	T15 - IP	128	M3,5x8,6 - IP	859
78 804 02500 / 78 805 02500	T20 - IP	129	M4,5x10,5 - IP	864
78 804 03200 / 78 805 03200	T20 - IP	129	M4,5x10,5 - IP	864



Metric Adaptors can be found in our Online-Shop or in the Metric Catalog 2021



EcoCut – Classic 2.25xD

▲ Drilling and turning tool

Scope of supply:

Toolholder with one clamping screw, two spare screws and a screwdriver

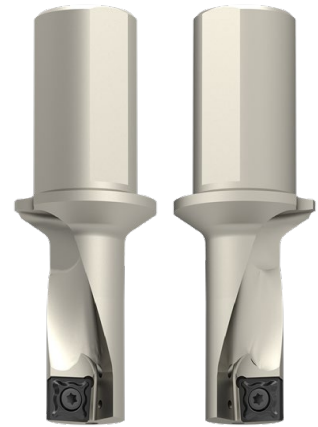
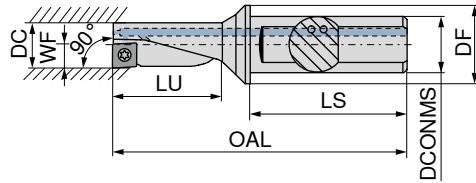
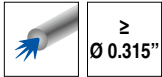

Left-hand **78 805 ...**
Right-hand **78 804 ...**

Designation	DC inch	DCONMS inch	DF inch	OAL inch	LU inch	LS inch	WF inch	torque moment Nm	Insert		
ECC 08 L 2,25D 04-E	0.315	0.375	0.472	2.300	0.710	1.430	0.157	0,4	XC.T 0401..EL		10800
ECC 08 R 2,25D 04-E	0.315	0.375	0.472	2.300	0.710	1.430	0.157	0,4	XC.T 0401..ER		10800 ¹⁾
ECC 10 R/L 2,25D 05-E	0.394	0.500	0.630	2.700	0.890	1.615	0.197	0,7	XC.T 0502..		11000
ECC 12 R/L 2,25D 06-E	0.472	0.625	0.787	3.000	1.060	1.700	0.236	1,0	XC.T 0602..		11200
ECC 14 R/L 2,25D 07-E	0.551	0.625	0.787	3.200	1.240	1.700	0.276	1,2	XC.T 0703..		11400
ECC 16 R/L 2,25D 08-E	0.630	0.750	0.984	3.700	1.420	1.970	0.315	2,2	XC.T 0803..		11600
ECC 18 R/L 2,25D 09-E	0.709	1.000	1.260	4.300	1.590	2.190	0.354	2,2	XC.T 09T3..		11800
ECC 20 R/L 2,25D 10-E	0.787	1.000	1.260	4.400	1.770	2.230	0.394	3,2	XC.T 10T3..		12000
ECC 25 R/L 2,25D 13-E	0.984	1.250	1.575	5.000	2.220	2.285	0.492	5,0	XC.T 1304..		12500
ECC 32 R/L 2,25D 17-E	1.260	1.500	1.969	6.200	2.830	2.740	0.630	5,0	XC.T 1705..		13200

1) Note! Right-hand insert on right-hand tool → Page 39



80 950 ...

70 950 ...

Spare parts for Article no.

78 805 10800	T06 - IP	123	M1,8x3,6 - IP	862
78 804 10800	T06 - IP	123	M1,8x3,6 - IP	862
78 804 11000 / 78 805 11000	T06 - IP	123	M2x4,3 - IP	863
78 804 11200 / 78 805 11200	T07 - IP	124	M2,2x5 - IP	856
78 804 11400 / 78 805 11400	T08 - IP	125	M2,5x6 - IP	857
78 804 11600 / 78 805 11600	T09 - IP	126	M3x7 - IP	819
78 804 11800 / 78 805 11800	T09 - IP	126	M3x7 - IP	819
78 804 12000 / 78 805 12000	T15 - IP	128	M3,5x8,6 - IP	859
78 804 12500 / 78 805 12500	T20 - IP	129	M4,5x10,5 - IP	864
78 804 13200 / 78 805 13200	T20 - IP	129	M4,5x10,5 - IP	864



Metric Adaptors can be found in our Online-Shop or in the Metric Catalog 2021



EcoCut – Classic 3xD – Heavy metal

- ▲ Drilling and turning tool
- ▲ vibration-damped

Scope of supply:

Toolholder with one clamping screw, two spare screws and a screwdriver

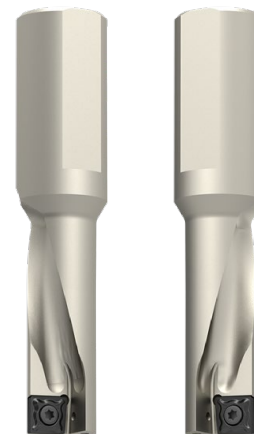
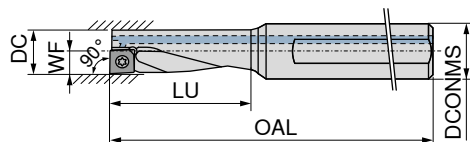
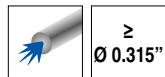

Left-hand **78 805 ...** Right-hand **78 804 ...**

Designation	DC inch	DCONMS inch	OAL inch	LU inch	WF inch	torque moment Nm	Insert	78 805 ...	78 804 ...
ECC 08 L 3,00D 04 H-E	0.315	0.500	3.100	0.940	0.157	0,4	XC.T 0401..EL	60800 ²⁾	
ECC 08 R 3,00D 04 H-E	0.315	0.500	3.100	0.940	0.157	0,4	XC.T 0401..ER		60800 ¹⁾
ECC 10 R/L 3,00D 05 H-E	0.394	0.500	3.300	1.180	0.197	0,7	XC.T 0502..	61000	61000
ECC 12 R/L 3,00D 06 H-E	0.472	0.625	3.700	1.420	0.236	1,0	XC.T 0602..	61200	61200
ECC 14 R/L 3,00D 07 H-E	0.551	0.625	3.900	1.650	0.276	1,2	XC.T 0703..	61400	61400
ECC 16 R/L 3,00D 08 H-E	0.630	0.750	4.300	1.860	0.315	2,2	XC.T 0803..	61600	61600
ECC 18 R/L 3,00D 09 H-E	0.709	1.000	5.000	2.120	0.354	2,2	XC.T 09T3..	61800	61800
ECC 20 R/L 3,00D 10 H-E	0.787	1.000	5.100	2.360	0.394	3,2	XC.T 10T3..	62000	62000
ECC 25 R/L 3,00D 13 H-E	0.984	1.250	5.900	2.950	0.492	5,0	XC.T 1304..	62500	62500
ECC 32 R/L 3,00D 17 H-E	1.260	1.500	7.200	3.780	0.630	5,0	XC.T 1705..	63200	63200

- 1) Note! Right-hand insert on right-hand tool → Page 39
 2) Note! Left-hand insert on left-hand tool → Page 39

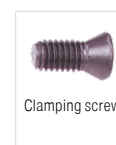
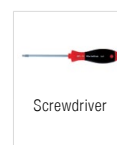

80 950 ...

70 950 ...

Spare parts for Article no.

78 805 60800	T06 - IP	123	M1,8x3,6 - IP	862
78 804 60800	T06 - IP	123	M1,8x3,6 - IP	862
78 804 61000 / 78 805 61000	T06 - IP	123	M2x4,3 - IP	863
78 804 61200 / 78 805 61200	T07 - IP	124	M2,2x5 - IP	856
78 804 61400 / 78 805 61400	T08 - IP	125	M2,5x6 - IP	857
78 804 61600 / 78 805 61600	T09 - IP	126	M3x7 - IP	819
78 804 61800 / 78 805 61800	T09 - IP	126	M3x7 - IP	819
78 804 62000 / 78 805 62000	T15 - IP	128	M3,5x8,6 - IP	859
78 804 62500 / 78 805 62500	T20 - IP	129	M4,5x10,5 - IP	864
78 804 63200 / 78 805 63200	T20 - IP	129	M4,5x10,5 - IP	864



Metric Adaptors can be found in our Online-Shop or in the Metric Catalog 2021



PM-L / PM-R

Designation	CW inch	PDPT inch	L inch	S inch	D1 inch
PM 10 G 201504	0.078	0.059	0.196	0.082	0.082
PM 12 G 201804	0.078	0.070	0.236	0.090	0.098
PM 16 G 252004	0.098	0.078	0.314	0.110	0.133
PM 20 G 302504	0.118	0.098	0.393	0.145	0.157
PM 25 G 353004	0.137	0.118	0.492	0.177	0.173
PM 32 G 404004	0.157	0.157	0.629	0.220	0.236

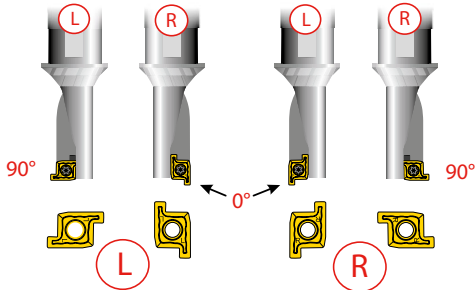
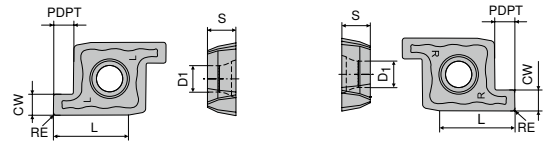

PM-L / PM-R

Designation	RE inch
PM 10 R/L G 201504	0.016
PM 12 R/L G 201804	0.016
PM 16 R/L G 252004	0.016
PM 20 R/L G 302504	0.016
PM 25 R/L G 353004	0.016
PM 32 R/L G 404004	0.016

-M20 CTPP430	-M20 CTPP430
DRAGONSKIN	DRAGONSKIN
M PM-L	M PM-R
70 289 ...	70 289 ...
510	511
515	516
520	521
525	526
530	531
535	536

P	●	●
M	●	●
K	○	○
N	○	○
S	●	●
H		
O	○	○

→ V_c Page 25

EcoCut – ProfileMaster 1.5xD

▲ Drilling, turning and grooving tool

Scope of supply:

Toolholder with one clamping screw and one screwdriver

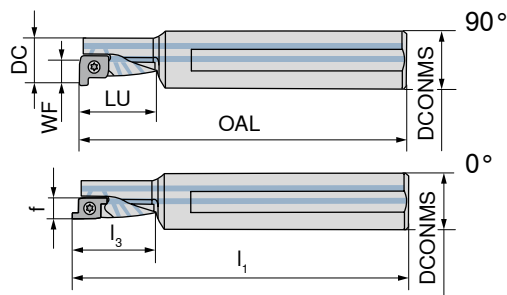
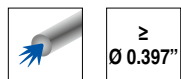

Designation	DC inch	DCONMS inch	OAL inch	LU inch	WF inch	I ₁ inch	I ₃ inch	f inch	torque moment Nm	Insert	Left-hand	Right-hand
											78 811 ...	78 810 ...
PMC 10 R/L 1,5D-E	0.394	0.500	3.100	0.590	0.197				0,4	PM 10R/L	01000 ¹⁾	01000 ¹⁾
PMC 12 R/L 1,5D-E	0.472	0.625	3.500	0.709	0.236				1,0	PM 12R/L	01200 ¹⁾	01200 ¹⁾
PMC 16 R/L 1,5D-E	0.630	0.750	4.900	1.004	0.315	4.991	1.094	0.224	2,2	PM 16R/L	01600	01600
PMC 20 R/L 1,5D-E	0.787	1.000	5.900	1.181	0.394	6.010	1.291	0.283	2,2	PM 20R/L	02000	02000
PMC 25 R/L 1,5D-E	0.984	1.250	7.000	1.476	0.492	7.130	1.606	0.362	3,2	PM 25R/L	02500	02500
PMC 32 R/L 1,5D-E	1.260	1.500	7.800	1.890	0.630	7.969	2.059	0.461	5,0	PM 32R/L	03200	03200

1) only usable as 90° version

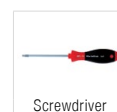

Spare parts

for Article no.

Article no.	Part no.	Quantity	Description	Quantity
78 810 01000 / 78 811 01000	T06	100	M1,8x3,8	57300
78 810 01200 / 78 811 01200	T07	101	M2,2x4	360
78 810 01600 / 78 811 01600	T08	102	M3x5,7	365
78 810 02000 / 78 811 02000	T15	105	M3,5x7,2	110
78 810 02500 / 78 811 02500	T15	105	M3,5x8,6	304
78 810 03200 / 78 811 03200	T20 - IP	129	M5x10,8 - IP	010



Metric Adaptors can be found in our Online-Shop or in the Metric Catalog 2021



EcoCut – ProfileMaster 2.25xD

▲ Drilling, turning and grooving tool

Scope of supply:

Toolholder with one clamping screw and one screwdriver

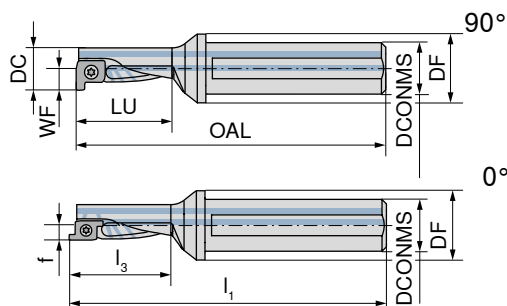
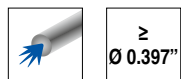

Designation	DC inch	DCONMS inch	DF inch	OAL inch	LU inch	WF inch	I ₁ inch	I ₃ inch	f inch	torque moment Nm	Insert	Left-hand	Right-hand
												78 811 ...	78 810 ...
PMC 10 R/L 2,25D-E	0.394	0.500	0.630	2.800	0.886	0.197				0,4	PM 10R/L	11000 ¹⁾	11000 ¹⁾
PMC 12 R/L 2,25D-E	0.472	0.625	0.787	3.000	1.063	0.236				1,0	PM 12R/L	11200 ¹⁾	11200 ¹⁾
PMC 16 R/L 2,25D-E	0.630	0.750	0.984	3.800	1.417	0.315	3.891	1.508	0.224	2,2	PM 16R/L	11600	11600
PMC 20 R/L 2,25D-E	0.787	1.000	1.260	4.400	1.772	0.394	4.510	1.882	0.283	2,2	PM 20R/L	12000	12000
PMC 25 R/L 2,25D-E	0.984	1.250	1.575	5.200	2.217	0.492	5.330	2.347	0.362	3,2	PM 25R/L	12500	12500
PMC 32 R/L 2,25D-E	1.260	1.500	1.969	6.200	2.835	0.630	6.369	3.004	0.461	5,0	PM 32R/L	13200	13200

1) only usable as 90° version



Spare parts

for Article no.

Article no.	Part no.	Quantity	Description	Quantity
78 810 11000 / 78 811 11000	T06	100	M1,8x3,8	57300
78 810 11200 / 78 811 11200	T07	101	M2,2x4	360
78 810 11600 / 78 811 11600	T08	102	M3x5,7	365
78 810 12000 / 78 811 12000	T15	105	M3,5x7,2	110
78 810 12500 / 78 811 12500	T15	105	M3,5x8,6	304
78 810 13200 / 78 811 13200	T20 - IP	129	M5x10,8 - IP	010

Metric Adaptors can be found in our Online-Shop or in the Metric Catalog 2021



FT15 . 353535...

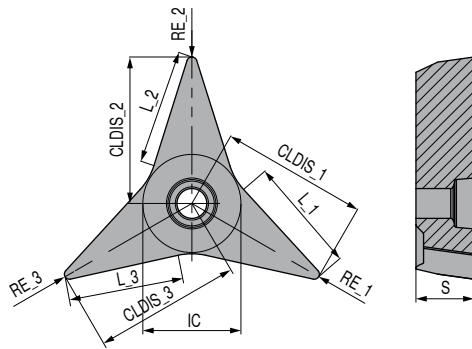

Designation	IC inch	CLDIS_1 inch	L_1 inch	CLDIS_2 inch	L_2 inch	CLDIS_3 inch	L_3 inch	S inch
FT15 G 353535R04-28P	0.590	0.945	0.633	0.945	0.633	0.945	0.633	0.359
FT15 G 353535R08-28P	0.590	0.908	0.598	0.908	0.598	0.908	0.598	0.359

NEW

-28P
H216T

DRAGONSKIN



F F F

FT15 . 353535...

74 001 ...

ISO	RE_1 inch	RE_2 inch	RE_3 inch	
FT15 G 353535R04-28P	0.016	0.016	0.016	20200
FT15 G 353535R08-28P	0.031	0.031	0.031	20400

P	
M	
K	○
N	●
S	
H	
O	○

→ v_c Page 26

FT15 . 555555...

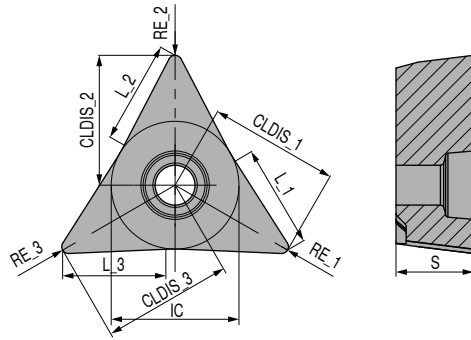

Designation	IC inch	CLDIS_1 inch	L_1 inch	CLDIS_2 inch	L_2 inch	CLDIS_3 inch	L_3 inch	S inch
FT15 M 555555R04-FFF	0.590	0.621	0.496	0.621	0.496	0.621	0.496	0.359
FT15 M 555555R08-FFF	0.590	0.602	0.484	0.602	0.484	0.602	0.484	0.359

NEW

CTCP125

DRAGONSKIN

FFF

FT15 . 555555...

74 002 ...

00200

NEW

CTPM125

DRAGONSKIN

FFF

FT15 . 555555...

74 002 ...

10400

ISO	RE_1 inch	RE_2 inch	RE_3 inch
FT15 M 555555R04-FFF	0.016	0.016	0.016
FT15 M 555555R08-FFF	0.031	0.031	0.031

P	●	○
M	○	●
K	○	●
N	○	●
S	○	●
H	○	●
O	○	●

FT15 . 808055...

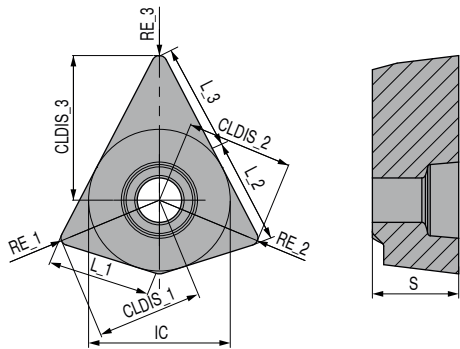

Designation	IC inch	CLDIS_1 inch	L_1 inch	CLDIS_2 inch	L_2 inch	CLDIS_3 inch	L_3 inch	S inch
FT15 M 808055R080804-MMF	0.590	0.441	0.425	0.441	0.448	0.621	0.448	0.359
FT15 M 808055R08-MMF	0.590	0.441	0.425	0.441	0.440	0.602	0.440	0.359
FT15 M 808055R121208-MMF	0.590	0.433	0.421	0.433	0.440	0.602	0.440	0.359

ISO	RE_1 inch	RE_2 inch	RE_3 inch
FT15 M 808055R080804-MMF	0.031	0.031	0.016
FT15 M 808055R08-MMF	0.031	0.031	0.031
FT15 M 808055R121208-MMF	0.047	0.047	0.031

P		●	○
M			●
K		○	
N			
S			
H			
O			

NEW

CTCP125

DRAGONSKIN

M M F

FT15 . 808055...

74 003 ...

00400

00200

00600

NEW

CTPM125

DRAGONSKIN

M M F

FT15 . 808055...

74 003 ...

10200

FreeTurn – HSK-T tool holder FT15

- ▲ Tool holder for FreeTurn indexable insert
- ▲ DirectCooling coolant supply

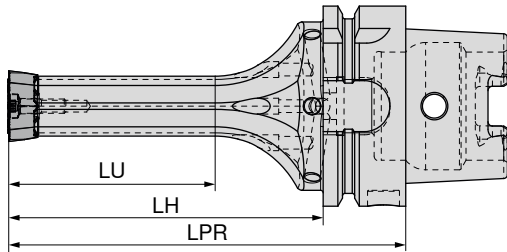



Figures show version FT15 . 808055...

NEW
DirectCooling
74 700 ...

Designation	Adapter	LPR inch	LH inch	LU inch	Insert	
HSK-T63-100-FT15 353535	HSK-T 63	3.937	2.913	1.575	FT15 . 353535...	00137
HSK-T63-100-FT15 808055	HSK-T 63	3.937	2.913	1.575	FT15 . 808055...	00537
HSK-T63-100-FT15 555555	HSK-T 63	3.937	2.913	1.575	FT15 . 555555...	00337
HSK-T63-125-FT15 353535	HSK-T 63	4.921	3.898	2.559	FT15 . 353535...	00237
HSK-T63-125-FT15 808055	HSK-T 63	4.921	3.898	2.559	FT15 . 808055...	00637
HSK-T63-125-FT15 555555	HSK-T 63	4.921	3.898	2.559	FT15 . 555555...	00437

Spare parts
Adapter
HSK-T 63

		
	80 950 ...	70 950 ...
T20 - IP	121	M4,5x18 - IP
		25900

FreeTurn – PSC tool holder FT15

- ▲ Tool holder for FreeTurn indexable insert
- ▲ DirectCooling coolant supply

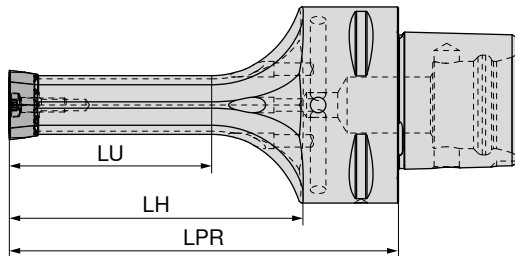



Figures show version FT15 . 808055...

NEW
DirectCooling
74 700 ...

Designation	Adapter	LPR inch	LH inch	LU inch	Insert	
PSC-63-100-FT15 353535	PSC 63	3.937	2.732	1.575	FT15 . 353535...	00193
PSC-63-100-FT15 808055	PSC 63	3.937	2.728	1.575	FT15 . 808055...	00593
PSC-63-100-FT15 555555	PSC 63	3.937	2.740	1.575	FT15 . 555555...	00393
PSC-63-125-FT15 353535	PSC 63	4.921	3.717	2.559	FT15 . 353535...	00293
PSC-63-125-FT15 808055	PSC 63	4.921	3.713	2.559	FT15 . 808055...	00693
PSC-63-125-FT15 555555	PSC 63	4.921	3.724	2.559	FT15 . 555555...	00493

Spare parts
Adapter
PSC 63

	 Screwdriver	 Clamping screw
	80 950 ...	70 950 ...
T20 - IP	121	M4,5x18 - IP
		25900

FT17 . 808080...

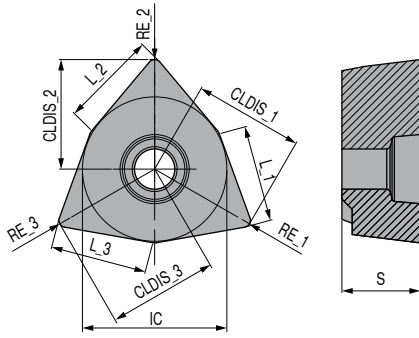

Designation	IC inch	CLDIS_1 inch	L_1 inch	CLDIS_2 inch	L_2 inch	CLDIS_3 inch	L_3 inch	S inch
FT17 M 808080R04-MMM	0.669	0.511	0.444	0.511	0.444	0.511	0.444	0.359
FT17 M 808080R08-MMM	0.669	0.503	0.444	0.503	0.444	0.503	0.444	0.359
FT17 M 808080R12-MMM	0.669	0.494	0.440	0.494	0.440	0.494	0.440	0.359

ISO	RE_1 inch	RE_2 inch	RE_3 inch
FT17 M 808080R04-MMM	0.016	0.016	0.016
FT17 M 808080R08-MMM	0.031	0.031	0.031
FT17 M 808080R12-MMM	0.047	0.047	0.047

P		●	○
M			●
K		○	
N			
S			
H			
O			

NEW

CTCP125

DRAGONSKIN

M M M

FT17 . 808080...

74 000 ...

00200

00400

00600

NEW

CTPM125

DRAGONSKIN

M M M

FT17 . 808080...

74 000 ...

10400

→ v_c Page 26

FreeTurn – HSK-T tool holder FT17

- ▲ Tool holder for FreeTurn indexable insert
- ▲ DirectCooling coolant supply

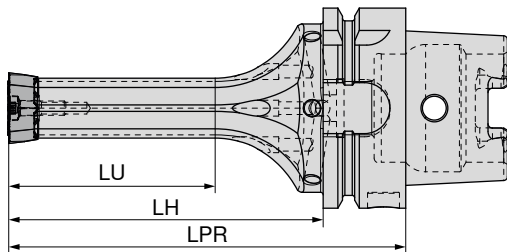

NEW
DirectCooling
74 701 ...

Designation	Adapter	LPR inch	LH inch	LU inch	Insert	
HSK-T63-100-FT17 808080	HSK-T 63	3.937	2.913	1.575	FT17 . 808080...	00737
HSK-T63-125-FT17 808080	HSK-T 63	4.921	3.898	2.559	FT17 . 808080...	00837

Spare parts
Adapter
HSK-T 63

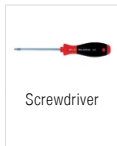
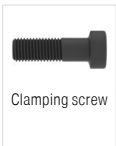
	 Screwdriver	 Clamping screw
	80 950 ...	70 950 ...
T20 - IP	121	M4,5x18 - IP
		25900

FreeTurn – PSC tool holder FT17

- ▲ Tool holder for FreeTurn indexable insert
- ▲ DirectCooling coolant supply

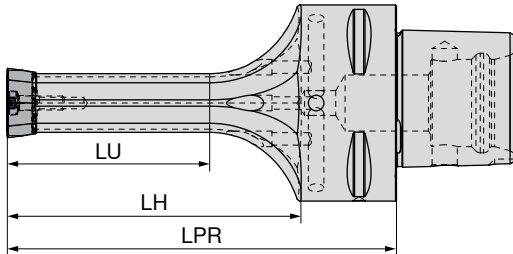

NEW
DirectCooling
74 701 ...

Designation	Adapter	LPR inch	LH inch	LU inch	Insert	
PSC-63-100-FT17 808080	PSC 63	3.937	2.728	1.575	FT17 . 808080...	00793
PSC-63-125-FT17 808080	PSC 63	4.921	3.713	2.559	FT17 . 808080...	00893

Spare parts
Adapter
PSC 63

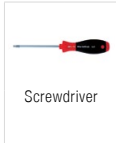
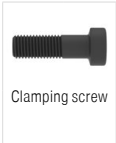
	 Screwdriver	 Clamping screw
	80 950 ...	70 950 ...
T20 - IP	121	M4,5x18 - IP
		25900

Material examples for cutting data tables

	Material sub-group	Index	Composition / Structure / Heat treatment	Tensile strength lbf/in ² / HB / HRC	Material number	Material designation	Material number	Material designation
P	Unalloyed steel	P.1.1	< 0.15 % C Annealed	60900 lbf/in ² / 125 HB	1.0401	1015	1.0301	1010
		P.1.2	< 0.45 % C Annealed	92800 lbf/in ² / 190 HB	1.1191	1045	1.0737	12L14
		P.1.3	< 0.45 % C Tempered	121800 lbf/in ² / 250 HB	1.1191	1045	1.0503	1043
		P.1.4	< 0.75 % C Annealed	132000 lbf/in ² / 270 HB	1.1223	1060	1.0535	1055
		P.1.5	< 0.75 % C Tempered	146500 lbf/in ² / 300 HB	1.1223	1060	1.1274	1095
	Low-alloy steel	P.2.1	Annealed	88500 lbf/in ² / 180 HB	1.7131	5115	1.6523	8620
		P.2.2	Tempered	134900 lbf/in ² / 275 HB	1.7131	5115	1.6582	4340
		P.2.3	Tempered	146500 lbf/in ² / 300 HB	1.7225	4142	1.7131	5115
		P.2.4	Tempered	174000 lbf/in ² / 375 HB	1.7225	4142	1.7223	4140
	High-alloy steel and high-alloy tool steel	P.3.1	Annealed	98600 lbf/in ² / 200 HB	1.4021	420	1.2379	D2
		P.3.2	Hardened and tempered	159500 lbf/in ² / 300 HB	1.2343	H11	1.3343	M2
		P.3.3	Hardened and tempered	188500 lbf/in ² / 400 HB	1.2343	H11	1.2363	A2
	Stainless steel	P.4.1	Ferritic / martensitic Annealed	98600 lbf/in ² / 200 HB	1.4016	430	1.4125	440C
		P.4.2	Martensitic Tempered	117500 lbf/in ² / 250 HB	1.4112	S44003	1.4021	420
M	Stainless steel	M.1.1	Austenitic / austenitic-ferritic Quenched	88500 lbf/in ² / 200 HB	1.4301	304	1.4401	316
		M.2.1	Austenitic Tempered	300 HB	1.4841	314	1.4568	17-7 PH
		M.3.1	Austenitic / ferritic (Duplex)	113100 lbf/in ² / 230 HB	1.4462	S32205	1.4410	S32750
K	Grey cast iron	K.1.1	Pearlitic / ferritic	88500 lbf/in ² / 180 HB	0.6010	A48-20B	0.6025	A48-40 B
		K.1.2	Pearlitic (martensitic)	127600 lbf/in ² / 260 HB	0.6030	A48-45B	0.6040	A48-60 B
	Spherulitic graphite cast iron	K.2.1	Ferritic	78300 lbf/in ² / 160 HB	0.7040	60-40-18	0.7050	65-45-12
		K.2.2	Pearlitic	122600 lbf/in ² / 250 HB	0.7070	100-70-03	0.7660	A439 Type D2
	Malleable iron	K.3.1	Ferritic	63800 lbf/in ² / 130 HB	0.8035	GTW-35-04		
		K.3.2	Pearlitic	113100 lbf/in ² / 230 HB	0.8170	70003		
N	Aluminium wrought alloy	N.1.1	Non-hardenable	60 HB	3.0255	A91060	3.0255	A91060
		N.1.2	Hardenable	49300 lbf/in ² / 100 HB	3.1355	2024	3.1355	2024
	Cast aluminium alloy	N.2.1	≤ 12 % Si, non-hardenable	36300 lbf/in ² / 75 HB	3.2581	A04130 / A413-0	3.2581	A04130 / A413-0
		N.2.2	≤ 12 % Si, hardenable	43500 lbf/in ² / 90 HB	3.2134	G-AISI5Cu1Mg		
		N.2.3	> 12 % Si, non-hardenable	63800 lbf/in ² / 130 HB		G-AISI17Cu4Mg		
	Copper and copper alloys (bronze/brass)	N.3.1	Free-machining alloys, PB > 1 %	54400 lbf/in ² / 110 HB	2.0380	CuZn39Pb2 (Ms58)	2.0380	C37700
		N.3.2	CuZn, CuSnZn	43500 lbf/in ² / 90 HB	2.0331	CuZn15	2.0331	C34000
		N.3.3	CuSn, lead-free copper and electrolytic copper	49300 lbf/in ² / 100 HB	2.0060	E-Cu57		
	Magnesium alloys	N.4.1	Magnesium and magnesium alloys	70 HB	3.5612	MgAl6Zn		
	S	Heat-resistant alloys	S.1.1	Fe - basis Annealed	98600 lbf/in ² / 200 HB	1.4864	X12NiCrSi 36-16	1.4864
S.1.2			Fe - basis	137800 lbf/in ² / 280 HB	1.4980	X6NiCrTiMoVB25-15-2	1.4980	S66286
S.2.1			Ni or Co basis Annealed	121800 lbf/in ² / 250 HB	2.4856	Inconel 625	2.4812	Hastelloy C
S.2.2			Ni or Co basis	171100 lbf/in ² / 350 HB	2.4952	Nimonic 80A	2.4668	Inconel 718
S.2.3			Cast	156600 lbf/in ² / 320 HB	2.4674	Nimocast PK24	2.4670	Nimocast 713
Titanium alloys		S.3.1	Pure titanium	5800 lbf/in ²	3.7025	Ti99,8		
		S.3.2	Alpha + beta alloys	152300 lbf/in ²	3.7165	TiAl6V4		
		S.3.3	Beta alloys	203100 lbf/in ² / 410 HB	Ti555.3	Ti-5Al-5V-5Mo-3Cr		
H	Hardened steel	H.1.1	Hardened and tempered	46-55 HRC				
		H.1.2	Hardened and tempered	56-60 HRC				
		H.1.3	Hardened and tempered	61-65 HRC				
		H.1.4	Hardened and tempered	66-70 HRC				
	Chilled iron	H.2.1	Cast	400 HB				
	Hardened cast iron	H.3.1	Hardened and tempered	55 HRC				
O	Non-metal materials	O.1.1	Plastics, duroplastic	≤ 21800 lbf/in ²				
		O.1.2	Plastics, thermoplastic	≤ 14500 lbf/in ²				
		O.2.1	Aramid fibre-reinforced	≤ 145000 lbf/in ²				
		O.2.2	Glass/carbon-fibre reinforced	≤ 145000 lbf/in ²				
		O.3.1	Graphite					

* Tensile Strength at Rupture (Rm)

Cutting data standard values for EcoCut

	DRAGONSKIN		DRAGONSKIN		DRAGONSKIN		DRAGONSKIN	
	EcoCut Mini CTWN425	EcoCut Mini CTPP435	EcoCut Classic CTCP425	EcoCut Classic CTCP435	EcoCut Classic CTPP430	EcoCut Classic H210T	EcoCut Classic H216T	EcoCut ProfileMaster CTPP430
Index	v _c in ft/min							
P.1.1		480	750	690	600			550
P.1.2		410	650	590	510			470
P.1.3		350	560	500	440			380
P.1.4		330	530	470	410			350
P.1.5		300	480	420	370			310
P.2.1		420	670	600	530			480
P.2.2		320	520	460	400			340
P.2.3		300	480	420	370			310
P.2.4		220	370	310	270			200
P.3.1		340	510	470	380			370
P.3.2		220	370	320	280			250
P.3.3		100	230	170	190			130
P.4.1		340	510	470	380			370
P.4.2		280	440	400	330			310
M.1.1		340	510	470	380			370
M.2.1		220			280			250
M.3.1		310			350			340
K.1.1	460	460	680	610	530	360	560	590
K.1.2	380	400	680	610	460	300	430	860
K.2.1	500	460	660	590	530	400	590	530
K.2.2	360	400	660	590	460	280	430	830
K.3.1	560	500	640	580	410	460	630	430
K.3.2	460	410	640	580	360	360	530	760
N.1.1	990	130			130	130	200	990
N.1.2	170	960			960	960	1020	660
N.2.1	990	960			960	960	200	990
N.2.2	990	630			630	630	1520	660
N.2.3	1490	1120			1120	1120	200	500
N.3.1	1160	790			790	790	1520	990
N.3.2	1160	790			790	790	1520	990
N.3.3	830	630			630	630	1190	660
N.4.1	660	460			460	460	860	660
S.1.1	120	120		120	180	110	140	120
S.1.2	90	100		100	180	80	110	100
S.2.1	90	60		60	180	80	110	70
S.2.2	80	50		50	180	70	80	50
S.2.3	70	50		50	180	70	70	50
S.3.1	300	280		280	230	210	360	280
S.3.2	180	130		130	200	140	230	130
S.3.3	130	100		100	130	100	170	100
H.1.1								
H.1.2								
H.1.3								
H.1.4								
H.2.1								
H.3.1								
O.1.1	430	360			360	360	510	430
O.1.2								
O.2.1	350	310			310	310	460	350
O.2.2								
O.3.1								

 The cutting data is strongly influenced by external conditions, such as the stability of the tool and workpiece clamping, material and type of machine. The specified values represent guideline cutting data that can be adjusted by approx. ±20% according to the usage conditions.

Cutting data standard values for FreeTurn

Index	F		M		-28P
	DRAGONSKIN	DRAGONSKIN	DRAGONSKIN	DRAGONSKIN	H216T
	CTCP125	CTPM125	CTCP125	CTPM125	
	v _c in ft/min		v _c in ft/min		v _c in ft/min
P.1.1	980	670	980	670	
P.1.2	830	560	830	560	
P.1.3	700	470	700	470	
P.1.4	660	440	660	440	
P.1.5	590	390	590	390	
P.2.1	850	580	850	580	
P.2.2	650	430	650	430	
P.2.3	590	390	590	390	
P.2.4	430	270	430	270	
P.3.1	560	470	560	470	
P.3.2	350	320	350	320	
P.3.3	140	170	140	170	
P.4.1	560	470	560	470	
P.4.2	450	390	450	390	
M.1.1		470		470	
M.2.1		320		320	
M.3.1		420		420	
K.1.1	560		560		560
K.1.2	530		530		430
K.2.1	590		590		590
K.2.2	530		530		430
K.3.1	660		660		630
K.3.2	530		530		530
N.1.1					5450
N.1.2					4460
N.2.1					3960
N.2.2					3630
N.2.3					1980
N.3.1					1730
N.3.2					1650
N.3.3					1240
N.4.1					910
S.1.1					
S.1.2					
S.2.1					
S.2.2					
S.2.3					
S.3.1					
S.3.2					
S.3.3					
H.1.1					
H.1.2					
H.1.3					
H.1.4					
H.2.1					
H.3.1					
O.1.1					530
O.1.2					
O.2.1					460
O.2.2					
O.3.1					



The cutting data is strongly influenced by external conditions, such as the stability of the tool and workpiece clamping, material and type of machine. The specified values represent guideline cutting data that can be adjusted by approx. ±20% according to the usage conditions.

Depth of Cut and Feedrate for EcoCut Mini

Turning

2.25xD

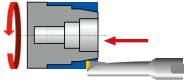

EcoCut Mini Size	Depth of Cut a_p in inch										
	0.010	0.020	0.030	0.040	0.060	0.080	0.100	0.120	0.140	0.160	
Feed rate f in inch/rev.											
ECM 02..	.0008-.0028	.0008-.0028									
ECM 02.5..	.0008-.0028	.0008-.0028	.0008-.0020								
ECM 03..	.0008-.0028	.0008-.0028	.0008-.0020	.0008-.0020							
ECM 03.5..	.0008-.0028	.0008-.0028	.0008-.0020	.0008-.0020	.0008-.0020						
ECM 04..	.0016-.0040	.0016-.0040	.0016-.0040	.0016-.0040	.0012-.0028	.0004-.0020					
ECM 05..	.0016-.0040	.0016-.0040	.0016-.0040	.0016-.0040	.0012-.0032	.0008-.0024	.0004-.0016				
ECM 06..	.0016-.0040	.0016-.0040	.0016-.0040	.0016-.0040	.0016-.0040	.0012-.0032	.0008-.0024	.0004-.0016			
ECM 07..	.0016-.0040	.0016-.0040	.0016-.0040	.0016-.0040	.0016-.0040	.0016-.0040	.0012-.0032	.0008-.0024	.0004-.0016		
ECM 08..	.0016-.0040	.0016-.0040	.0016-.0040	.0016-.0040	.0016-.0040	.0016-.0040	.0016-.0040	.0012-.0032	.0008-.0024	.0004-.0016	

4xD

EcoCut Mini Size	Depth of Cut a_p in inch										
	0.010	0.020	0.030	0.040	0.060	0.080	0.100	0.120	0.140	0.160	
Feed rate f in inch/rev.											
ECM 02..	.0008-.0020	.0004-.0020									
ECM 02.5..	.0008-.0020	.0004-.0020									
ECM 03..	.0008-.0020	.0008-.0020	.0004-.0020								
ECM 03.5..	.0008-.0020	.0008-.0020	.0008-.0020	.0004-.0020							
ECM 04..	.0016-.0040	.0016-.0040	.0016-.0040	.0012-.0032	.0004-.0020						
ECM 05..	.0016-.0040	.0016-.0040	.0016-.0040	.0012-.00325	.0008-.0024	.0004-.0016					
ECM 06..	.0016-.0040	.0016-.0040	.0016-.0040	.0012-.00325	.0008-.0024	.0004-.0016					
ECM 07..	.0016-.0040	.0016-.0040	.0016-.0040	.0016-.0040	.0012-.0032	.0008-.0024	.0004-.0016				
ECM 08..	.0016-.0040	.0016-.0040	.0016-.0040	.0016-.0040	.0016-.00365	.0012-.0032	.0008-.0024	.0004-.0016			

6

Face turning

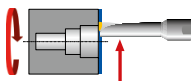

EcoCut Mini Size	2.25xD		4xD	
	$a_{p \max}$ in inch	f in inch/rev.	$a_{p \max}$ in inch	f in inch/rev.
ECM 02..	0.012	.0004-.0020	0.012	.0004-.0012
ECM 02.5..	0.012	.0004-.0020	0.012	.0004-.0012
ECM 03..	0.020	.0004-.0024	0.020	.0004-.0016
ECM 03.5..	0.020	.0004-.0024	0.020	.0004-.0016
ECM 04..	0.028	.0012-.0028	0.028	.0008-.0020
ECM 05..	0.028	.0012-.0028	0.028	.0008-.0020
ECM 06..	0.028	.0012-.0028	0.028	.0008-.0020
ECM 07..	0.039	.0016-.0032	0.039	.0012-.0024
ECM 08..	0.039	.0016-.0032	0.039	.0012-.0024

Depth of Cut and Feedrate for EcoCut Mini

Drilling
Feed rate

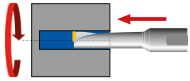

EcoCut Mini Size	2.25xD	4xD
	f in inch/rev.	f in inch/rev.
ECM 02..	.0001-.0003	.0001-.0002
ECM 02.5..	.0001-.0004	.0001-.0002
ECM 03..	.0001-.0005	.0001-.0004
ECM 03.5..	.0001-.0006	.0001-.0004
ECM 04..	.0002-.0012	.0002-.0005
ECM 05..	.0002-.0012	.0002-.0006
ECM 06..	.0002-.0012	.0002-.0008
ECM 07..	.0002-.0014	.0002-.0010
ECM 08..	.0002-.0016	.0002-.0012

max. bore depth

EcoCut Mini Size	2.25xD	4xD
	Max. hole depth in inch	Max. hole depth in inch
ECM 02..	0.177	0.315
ECM 02.5..	0.222	0.394
ECM 03..	0.266	0.472
ECM 03.5..	0.310	0.551
ECM 04..	0.354	0.630
ECM 05..	0.443	0.787
ECM 06..	0.531	0.945
ECM 07..	0.620	1.102
ECM 08..	0.709	1.260

Depth of Cut and Feedrate for EcoCut Classic

Turning

1.5xD

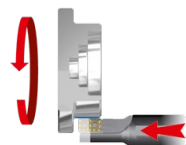

EcoCut Classic Size	Depth of Cut a_p in inch											
	0.039	0.079	0.118	0.157	0.197	0.236	0.276	0.315	0.354	0.394	0.472	0.551
	Feed rate f in inch/rev.											
ECC 08	.0024-.0048	.0024-.0048	.0016-.0040	.0008-.0032								
ECC 10	.0028-.0060	.0028-.0060	.0020-.0052	.0016-.0043	.0008-.0036							
ECC 12	.0032-.0064	.0032-.0064	.0032-.0064	.0024-.0056	.0016-.0048	.0008-.0040						
ECC 14	.0036-.0072	.0036-.0072	.0036-.0072	.0036-.0072	.0028-.0064	.0020-.0056	.0008-.0043					
ECC 16	.0040-.0080	.0040-.0080	.0040-.0080	.0040-.0080	.0032-.0072	.0024-.0064	.0016-.0056	.0008-.0048				
ECC 18	.0043-.0088	.0043-.0088	.0043-.0088	.0043-.0088	.0043-.0088	.0036-.0080	.0028-.0072	.0020-.0064	.0012-.0052			
ECC 20	.0048-.0096	.0048-.0096	.0048-.0096	.0048-.0096	.0048-.0096	.0043-.0092	.0036-.0084	.0028-.0076	.0020-.0066	.0012-.0060		
ECC 25	.0052-.0102	.0052-.0102	.0052-.0102	.0052-.0102	.0052-.0102	.0052-.0102	.0052-.0102	.0043-.0096	.0036-.0088	.0028-.0080	.0012-.0064	
ECC 32	.0060-.0120	.0060-.0120	.0060-.0120	.0060-.0120	.0060-.0120	.0056-.0120	.0060-.0120	.0060-.0120	.0052-.0110	.0043-.0102	.0028-.0088	.0012-.0072

Feed f may be increased by 50-75 % when using -M50Q and -27Q.

2.25xD

EcoCut Classic Size	Depth of Cut a_p in inch										
	0.039	0.079	0.098	0.118	0.138	0.157	0.177	0.197	0.217	0.236	0.276
	Feed rate f in inch/rev.										
ECC 08	.0024-.0048	.0016-.0040	.0008-.0032								
ECC 10	.0028-.0060	.0020-.0052	.0012-.0043	.0008-.0036							
ECC 12	.0032-.0064	.0032-.0064	.0024-.0056	.0016-.0048	.0008-.0040						
ECC 14	.0036-.0072	.0036-.0072	.0028-.0064	.0020-.0056	.0016-.0052	.0008-.0043					
ECC 16	.0040-.0080	.0040-.0080	.0036-.0076	.0028-.0066	.0020-.0060	.0012-.0052					
ECC 18	.0043-.0088	.0043-.0088	.0043-.0088	.0036-.0080	.0028-.0072	.0020-.0064	.0012-.0056				
ECC 20	.0048-.0096	.0048-.0096	.0048-.0096	.0048-.0096	.0040-.0088	.0032-.0080	.0024-.0072	.0016-.0064			
ECC 25	.0052-.0102	.0052-.0102	.0052-.0102	.0052-.0102	.0052-.0102	.0048-.0100	.0040-.0092	.0032-.0084	.0024-.0076	.0016-.0066	
ECC 32	.0060-.0120	.0060-.0120	.0060-.0120	.0060-.0120	.0060-.0120	.0060-.0120	.0056-.0114	.0048-.0106	.0040-.0100	.0032-.0092	.0020-.0080

Feed f may be increased by 50-75 % when using -M50Q and -27Q.

3xD

EcoCut Classic Size	Depth of Cut a_p in inch								
	0.039	0.079	0.098	0.118	0.138	0.157	0.197	0.236	0.276
	Feed rate f in inch/rev.								
ECC 08	.0020-.0040	.0008-.0024							
ECC 10	.0024-.0043	.0012-.0028							
ECC 12	.0024-.0048	.0016-.0040	.0008-.0032						
ECC 14	.0028-.0052	.0020-.0043	.0008-.0036						
ECC 16	.0028-.0060	.0024-.0056	.0016-.0048	.0008-.0036					
ECC 18	.0032-.0064	.0032-.0064	.0024-.0056	.0016-.0048					
ECC 20	.0036-.0072	.0036-.0072	.0036-.0072	.0028-.0064	.0020-.0056	.0012-.0048			
ECC 25	.0040-.0076	.0040-.0076	.0040-.0076	.0032-.0066	.0024-.0060	.0012-.0052			
ECC 32	.0043-.0088	.0043-.0088	.0043-.0088	.0043-.0088	.0036-.0080	.0028-.0072	.0012-.0056		

Depth of Cut and Feedrate for EcoCut Classic

Face turning

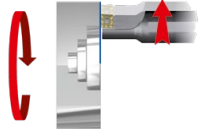

EcoCut Classic Size	1.5xD		2.25xD		3xD	
	a _p inch	f in inch/rev.	a _p inch	f in inch/rev.	a _p inch	f in inch/rev.
ECC 08	0.079	.0020-.0040	0.075	.0016-.0036	0.043	.0016-.0028
ECC 10	0.098	.0024-.0048	0.087	.0020-.0040	0.047	.0016-.0036
ECC 12	0.118	.0028-.0056	0.102	.0024-.0048	0.055	.0020-.0044
ECC 14	0.138	.0032-.0064	0.118	.0028-.0056	0.063	.0024-.0048
ECC 16	0.157	.0036-.0072	0.134	.0032-.0064	0.075	.0024-.0052
ECC 18	0.177	.0040-.0080	0.150	.0036-.0072	0.079	.0028-.0056
ECC 20	0.197	.0044-.0088	0.165	.0040-.0080	0.087	.0032-.0060
ECC 25	0.236	.0048-.0094	0.197	.0044-.0088	0.102	.0036-.0072
ECC 32	0.315	.0052-.0106	0.236	.0048-.0100	0.118	.0040-.0080

Drilling

Feed rate

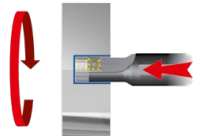

EcoCut Classic Size	1.5xD	2.25xD	3xD
	f in inch/rev.	f in inch/rev.	f in inch/rev.
ECC 08	.0004-.0016	.0004-.0016	.0004-.0008
ECC 10	.0004-.0020	.0004-.0020	.0004-.0012
ECC 12	.0004-.0020	.0004-.0020	.0004-.0016
ECC 14	.0004-.0028	.0004-.0028	.0004-.0020
ECC 16	.0008-.0032	.0008-.0032	.0008-.0024
ECC 18	.0012-.0036	.0012-.0036	.0012-.0028
ECC 20	.0012-.0040	.0012-.0040	.0012-.0032
ECC 25	.0012-.0048	.0012-.0048	.0016-.0036
ECC 32	.0020-.0060	.0020-.0060	.0020-.0044

max. bore depth

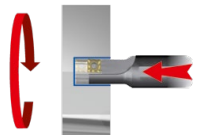

EcoCut Classic Size	1.5xD	2.25xD	3xD
	Max. hole depth in inch	Max. hole depth in inch	Max. hole depth in inch
ECC 08	0.472	0.709	0.945
ECC 10	0.591	0.886	1.181
ECC 12	0.709	1.063	1.417
ECC 14	0.827	1.240	1.654
ECC 16	0.945	1.417	1.890
ECC 18	1.063	1.594	2.126
ECC 20	1.181	1.772	2.362
ECC 25	1.476	2.224	2.953
ECC 32	1.890	2.835	3.780

Depth of Cut and Feedrate for EcoCut ProfileMaster 90°

Turning

1.5xD

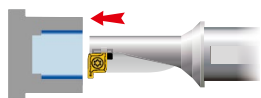

EcoCut ProfileMaster Size	Depth of Cut a_p in inch							
	0.039	0.079	0.118	0.157	0.197	0.236	0.276	0.315
	Feed rate f in inch/rev.							
EC PM 10	.0028-.0080	.0020-.0068	.0008-.0048					
EC PM 12	.0028-.0080	.0020-.0068	.0008-.0048					
EC PM 16	.0040-.0100	.0028-.0092	.0020-.0084	.0008-.0068				
EC PM 20	.0048-.0108	.0040-.0104	.0027-.0096	.0020-.0080	.0008-.0056			
EC PM 25	.0060-.0118	.0060-.0118	.0052-.0110	.0040-.0104	.0020-.0088	.0008-.0072		
EC PM 32	.0060-.0118	.0060-.0118	.0060-.0118	.0060-.0118	.0040-.0108	.0028-.0096	.0020-.0084	.0008-.0060

2.25xD

EcoCut ProfileMaster Size	Depth of Cut a_p in inch							
	0.039	0.079	0.118	0.157	0.197	0.236	0.276	0.315
	Feed rate f in inch/rev.							
EC PM 10	.0028-.0076	.0008-.0052						
EC PM 12	.0028-.0076	.0008-.0052						
EC PM 16	.0040-.0100	.0028-.0084	.0008-.0052					
EC PM 20	.0048-.0108	.0028-.0096	.0020-.0076					
EC PM 25	.0060-.0118	.0040-.0108	.0028-.0092	.0008-.0060				
EC PM 32	.0060-.0118	.0060-.0118	.0040-.0108	.0028-.0092	.0008-.0060			

Face turning

1.5xD and 2.25xD

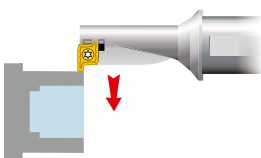

EcoCut ProfileMaster Size	Depth of Cut a_p in inch					
	0.039	0.059	0.079	0.098	0.118	0.138
	Feed rate f in inch/rev.					
EC PM 10	.0008-.0060	.0008-.0060				
EC PM 12	.0008-.0060	.0008-.0060				
EC PM 16	.0020-.0080	.0020-.0080	.0020-.0080			
EC PM 20	.0032-.0088	.0032-.0088	.0032-.0088	.0032-.0088		
EC PM 25	.0040-.0100	.0040-.0100	.0040-.0100	.0040-.0100	.0040-.0100	
EC PM 32	.0040-.0100	.0040-.0100	.0040-.0100	.0040-.0100	.0040-.0100	.0040-.0100

Internal + external – radial grooving

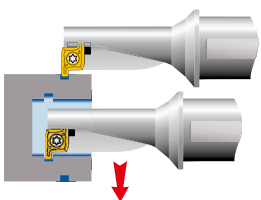

EcoCut ProfileMaster Size	1.5xD	EcoCut ProfileMaster Size	2.25xD
	f in inch/rev.		f in inch/rev.
EC PM 10	.0004-.0032	EC PM 10	.0004-.0032
EC PM 12	.0008-.0040	EC PM 12	.0008-.0040
EC PM 16	.0016-.0060	EC PM 16	.0016-.0060
EC PM 20	.0016-.0064	EC PM 20	.0016-.0064
EC PM 25	.0028-.0080	EC PM 25	.0028-.0080
EC PM 32	.0032-.0088	EC PM 32	.0032-.0088

Drilling

Feed and max. hole depth

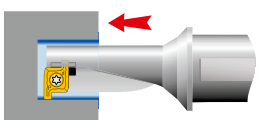

EcoCut ProfileMaster Size	1.5xD		EcoCut ProfileMaster Size	2.25xD	
	f in inch/rev.	Max. hole depth in inch		f in inch/rev.	Max. hole depth in inch
EC PM 10	.0004-.0020	0.59	EC PM 10	.0004-.0020	0.89
EC PM 12	.0004-.0024	0.71	EC PM 12	.0004-.0024	1.06
EC PM 16	.0008-.0036	0.94	EC PM 16	.0008-.0036	1.42
EC PM 20	.0012-.0040	1.18	EC PM 20	.0012-.0040	1.77
EC PM 25	.0016-.0048	1.48	EC PM 25	.0016-.0048	2.22
EC PM 32	.0016-.0056	1.89	EC PM 32	.0016-.0056	2.83

Depth of Cut and Feedrate for EcoCut ProfileMaster 0°

 EcoCut ProfileMaster Sizes 10 and 12 can not be used as 0° version.

Turning

1.5xD

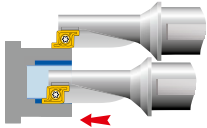

EcoCut ProfileMaster Size	Depth of cut a_p in inch					
	0.039	0.059	0.079	0.098	0.118	0.138
Feed rate f in inch/rev.						
EC PM 16	.0016-.0080	.0016-.0080	.0016-.0080			
EC PM 20	.0024-.0088	.0024-.0088	.0024-.0088	.0024-.0088		
EC PM 25	.0032-.0100	.0032-.0100	.0032-.0100	.0032-.0100	.0032-.0100	
EC PM 32	.0040-.0112	.0040-.0112	.0040-.0112	.0040-.0112	.0040-.0112	.0040-.0112

2.25xD

EcoCut ProfileMaster Size	Depth of cut a_p in inch					
	0.039	0.059	0.079	0.098	0.118	0.138
Feed rate f in inch/rev.						
EC PM 16	.0016-.0080	.0016-.0080	.0016-.0080			
EC PM 20	.0024-.0088	.0024-.0088	.0024-.0088	.0024-.0088		
EC PM 25	.0032-.0100	.0032-.0100	.0032-.0100	.0032-.0100	.0032-.0100	
EC PM 32	.0040-.0112	.0040-.0112	.0040-.0112	.0040-.0112	.0040-.0112	.0040-.0112

Face turning

1.5xD

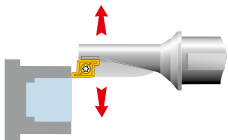

EcoCut ProfileMaster Size	Depth of cut a_p in inch						0.157
	0.039	0.059	0.079	0.098	0.118	0.138	
Feed rate f in inch/rev.							
EC PM 16	.0020-.0080	.0020-.0080	.0020-.0080				
EC PM 20	.0020-.0080	.0020-.0080	.0020-.0080	.0020-.0080			
EC PM 25	.0040-.0100	.0040-.0100	.0040-.0100	.0040-.0100	.0040-.0100		
EC PM 32	.0040-.0100	.0040-.0100	.0040-.0100	.0040-.0100	.0040-.0100	.0040-.0100	.0040-.0100

2.25xD

EcoCut ProfileMaster Size	Depth of cut a_p in inch						0.157
	0.039	0.059	0.079	0.098	0.118	0.138	
Feed rate f in inch/rev.							
EC PM 16	.0020-.0080	.0020-.0080	.0020-.0080				
EC PM 20	.0020-.0080	.0020-.0080	.0020-.0080	.0020-.0080			
EC PM 25	.0040-.0100	.0040-.0100	.0040-.0100	.0040-.0100	.0040-.0100		
EC PM 32	.0040-.0100	.0040-.0100	.0040-.0100	.0040-.0100	.0040-.0100	.0040-.0100	.0040-.0100

Axial grooving external + internal

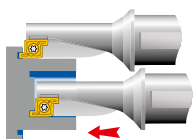

EcoCut ProfileMaster Size	1.5xD
	Feed rate f in inch/rev.
EC PM 16	.0008-.0048
EC PM 20	.0016-.0056
EC PM 25	.0024-.0072
EC PM 32	.0032-.0080

EcoCut ProfileMaster Size	2.25xD
	Feed rate f in inch/rev.
EC PM 16	.0008-.0048
EC PM 20	.0016-.0056
EC PM 25	.0024-.0072
EC PM 32	.0032-.0080

Initial curves for FreeTurn

	Material				Inserts		v_c in ft/min	Cooling
Steel	1.7225	42CrMo4	1010 N/mm ²	P.2.3	FT1x M 80xxxxR08-M	CTCP125	660	Emulsion
Stainless steel	1.4301	X5CrNi18-10	610 N/mm ²	M.1.1	FT1x M 80xxxxR08-M	CTPM125	600	Emulsion
Non-ferrous metals	3.2341	G-AISI 5 Mg	200 N/mm ²	N.2.2	FT1x G 35xxxxR08-28P	H210T	1320	Emulsion

Steel

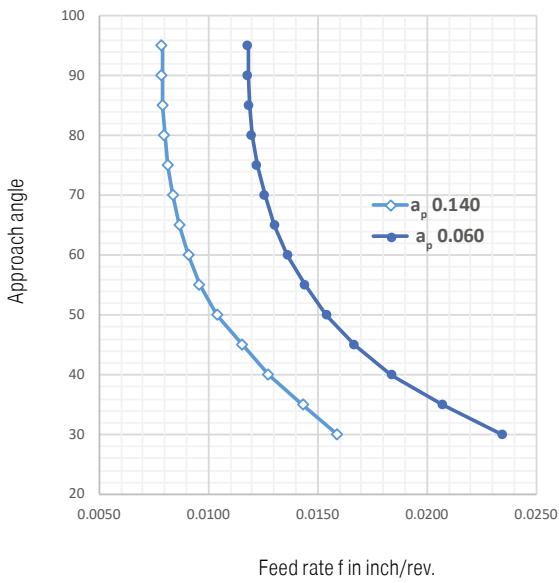

Stainless steel

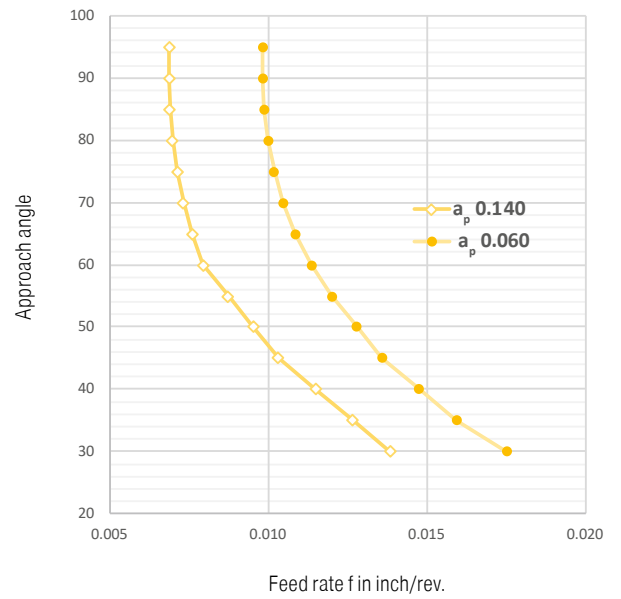

Non-ferrous metals

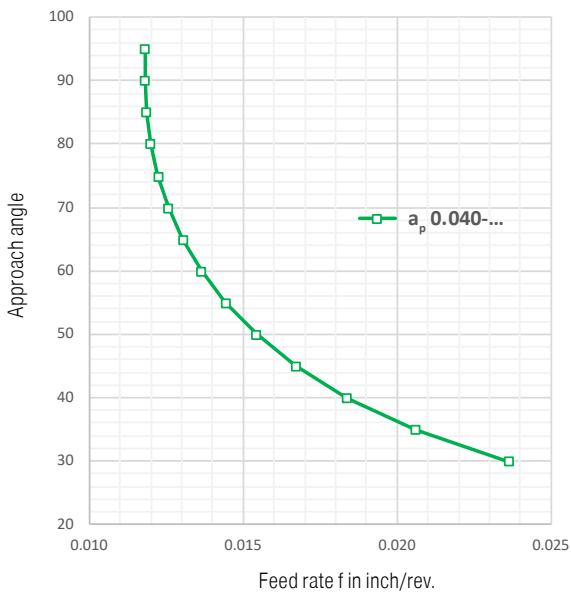

Chip Breakers Overview

EcoCut Classic

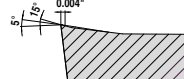
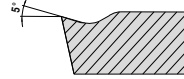
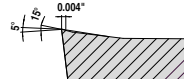
	Model	Smooth cut	Irregular cutting depth	Interrupted cut	Sectional illustration
					f inch
-EN ▲ Universal geometry ▲ Excellent chip breakage ▲ Positive cutting edge ▲ Low to medium feeds		CTCP425	CTCP435 / CTPP430	CTPP430 / CTCP435	
		CTCP425 / CTPP430	CTPP430	CTPP430	
		CTCP425	CTCP435 / CTPP430	CTCP435	
		CTPP430	CTPP430	CTPP430	
		CTCP435 / CTPP430	CTCP435 / CTPP430	CTCP435	
		CTCP435 / CTPP430	CTCP435 / CTPP430	CTCP435	
					0.002" - 0.011"
-M50Q ▲ With wiper geometry ▲ Excellent surface qualities ▲ Good chip formation ▲ Medium to high feeds		CTCP425	CTCP425		
		CTCP425			
		CTCP425	CTCP425		
					0.008" - 0.017"
-27P ▲ Positive cutting edge ▲ Periphery ground ▲ Polished rake face ▲ First choice for non-ferrous metals					
		H216T	H216T	H216T	
		H216T	H216T	H216T	
		H216T	H216T		
		H216T	H216T		
					0.004" - 0.016"
-27Q ▲ With wiper geometry ▲ Extremely positive geometry ▲ Periphery ground ▲ Low adhesion					
		H210T	H210T		
		H210T	H210T		
		H210T	H210T		
		H210T	H210T		
					0.008" - 0.020"

EcoCut ProfileMaster

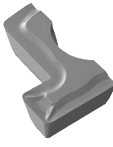
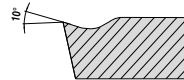
-M20 ▲ Positive geometry ▲ Universal application ▲ Low to medium feeds		CTPP430	CTPP430	CTPP430	
		CTPP430	CTPP430	CTPP430	
		CTPP430	CTPP430	CTPP430	
		CTPP430	CTPP430		
		CTPP430	CTPP430	CTPP430	
					0.002" - 0.010"

Application area of -EN and -M50Q chip breakers

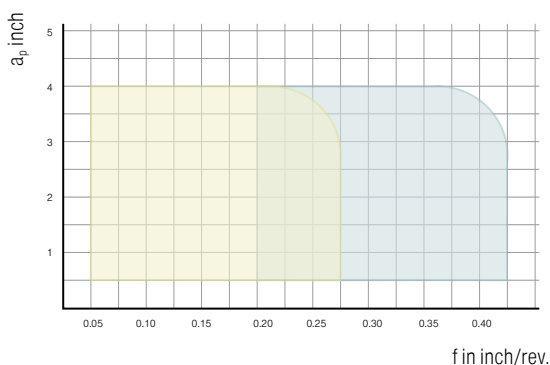





EcoCut Classic 2.25xD – ECC16 – XCNT 080304

- = -M50Q
- = Standard

Chip Breakers Overview

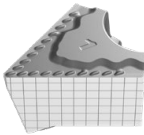
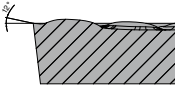
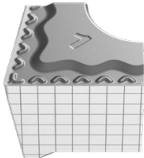
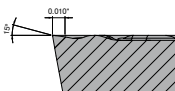
FreeTurn

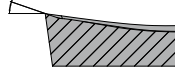
	Model	Smooth cut	Irregular cutting depth	Interrupted cut	Sectional illustration
					f inch
<p>-F</p> <ul style="list-style-type: none"> ▲ Traditional finishing geometry ▲ High surface quality ▲ First choice for finishing steel 		CTCP125	CTCP125		
		CTCP125	CTCP125		0 - 0.236"
<p>-M</p> <ul style="list-style-type: none"> ▲ Average to rough machining ▲ Aggressive chip breaker 		CTPM125	CTPM125		
		CTPM125	CTPM125		0 - 0.236"
<p>-28P</p> <ul style="list-style-type: none"> ▲ Traditional finishing geometry ▲ Sharp cutting edge ▲ First choice for aluminium 		H216T	H216T	H216T	
		H216T	H216T	H216T	0 - 0.070"
		H216T	H216T		

EcoCut Classic – Application as the most stable boring tool

EcoCut can not only be used as a multifunction tool, but it can be used strictly as a traditional boring tool.

Example: machining bores, 0.629" diameter by 1.420" depth

Differences in the tool

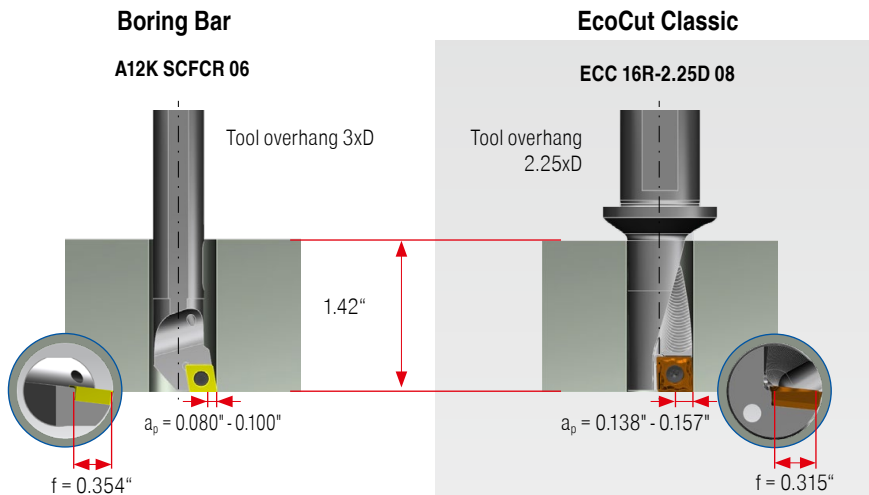

Your Advantages

Large, stable toolholder

- ▲ Absorption of high cutting forces
- ▲ Low vibration
- ▲ Chip Booster for perfect cooling and chip evacuation

Benefits

- ▲ High surface quality
- ▲ Perfect chip control
- ▲ Max. process security

Differences in the insert

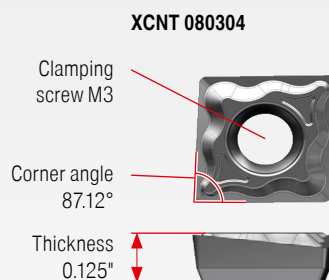
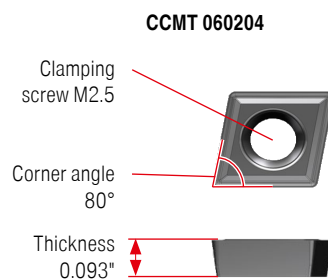

Large and stable insert

- ▲ Increased process security
- ▲ Enables large depths of cut
- ▲ Higher cutting data
- ▲ Higher tool life

Benefits

- ▲ Reduction in machining time
- ▲ Increased productivity
- ▲ Reduced tooling costs

Stability Comparison

Calculation using FEM

A load of 1000 N on the insert seat corresponds to an approx. a_p of 0.080" and f 0.008"

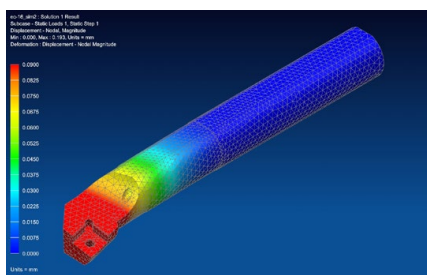

Deflection 0.007"

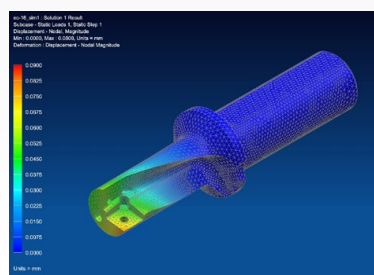

Deflection 0.003"

Practical experience shows:

- ▲ Reduced machining time by up to **75 %**
- ▲ Increase in tool life by **400 %** possible

Innovative chip removal – Chip-Booster

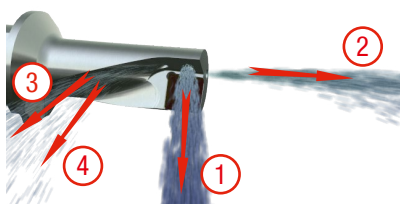

EcoCut tools are equipped with a unique coolant and chip removal system.

- ① Cooling of the indexable insert
- ② General coolant stream

- ③ Chip booster for improved chip transport
- ④ Chip booster prevents chips from getting stuck between tool and workpiece

① For maximum chip transport efficiency when drilling, coolant pressure must be 3–6 bar minimum (optimal 7–10 bar).

Application Tips

Drilling off-center

Due to the special construction of the EcoCut tool and insert, off-center drilling is possible.

Deviations from the tool nominal \varnothing , can be achieved (see adjacent table).

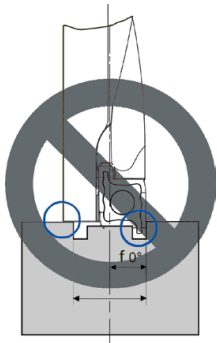
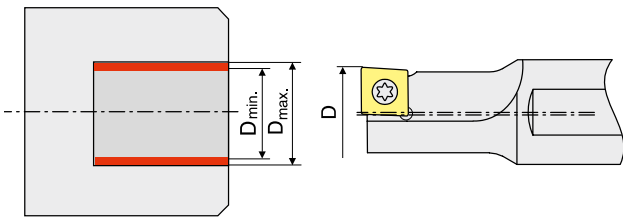

ProfileMaster 0°
Not suitable for drilling!

EcoCut Mini	Tool nominal- \varnothing	Work piece bore \varnothing	
	D in inch	D _{min.} in inch	D _{max.} in inch
ECM 02 L/R - ...D	0.079	0.077	0.083
ECM 02.5 L/R - ...D	0.098	0.096	0.102
ECM 03 L/R - ...D	0.118	0.116	0.124
ECM 03.5 L/R - ...D	0.138	0.136	0.144
ECM 04 R/L - ...D	0.157	0.154	0.165
ECM 05 R/L - ...D	0.197	0.193	0.205
ECM 06 R/L - ...D	0.236	0.232	0.244
ECM 07 R/L - ...D	0.276	0.272	0.283
ECM 08 R/L - ...D	0.315	0.311	0.323

EcoCut Classic	Tool nominal- \varnothing	Work piece bore \varnothing	
	D in inch	D _{min.} in inch	D _{max.} in inch
ECC 08 R/L - ... 04	0.315	0.309	0.327
ECC 10 R/L - ... 05	0.394	0.388	0.413
ECC 12 R/L - ... 06	0.472	0.467	0.492
ECC 14 R/L - ... 07	0.551	0.545	0.571
ECC 16 R/L - ... 08	0.630	0.624	0.650
ECC 18 R/L - ... 09	0.709	0.703	0.728
ECC 20 R/L - ... 10	0.787	0.780	0.807
ECC 25 R/L - ... 13	0.984	0.976	1.016
ECC 32 R/L - ... 17	1.260	1.252	1.299

EcoCut ProfileMaster	Tool nominal- \varnothing	Work piece bore \varnothing	
	D in inch	D _{min.} in inch	D _{max.} in inch
PM 10R/L ...	0.394	0.388	0.472
PM 12R/L ...	0.472	0.467	0.591
PM 16R/L ...	0.630	0.624	0.748
PM 20R/L ...	0.787	0.780	0.945
PM 25R/L ...	0.984	0.976	1.142
PM 32R/L ...	1.260	1.252	1.496

Machining over center

Problem

In case of insufficient movement of the machine across the center line, the external diameter can not be machined with the same tool.

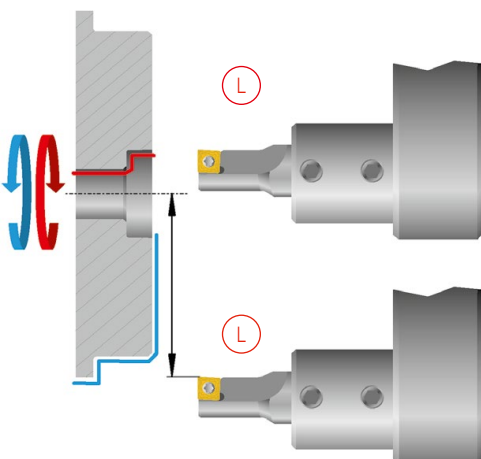

Solution

Use a right hand EcoCut tool.

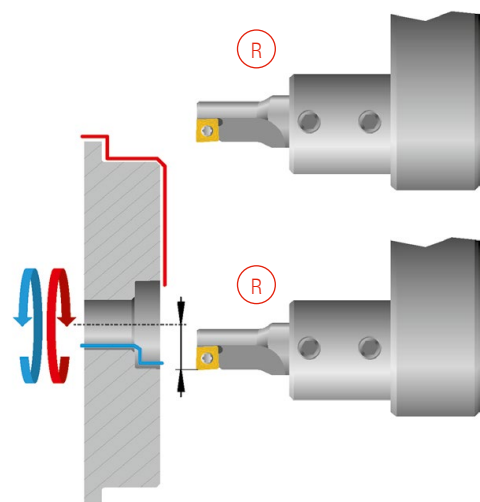

Application Tips

With axial displacement there is the danger of collision!

Problems

Displacement in x-direction:

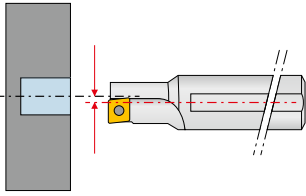

Angular error:

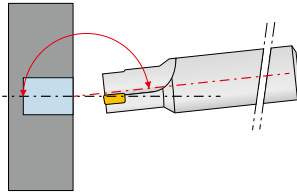

Turret position error:

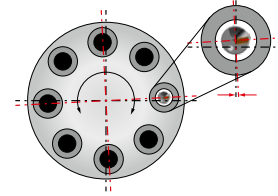

Remedy

When pre-setting the tool:

- ▲ Definition as an internal turning tool for programming

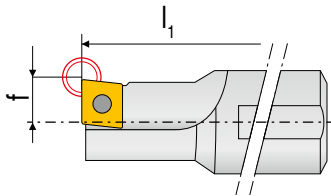

- ▲ Enter the tool nominal \varnothing as bore target \varnothing

At the machine:

- ▲ Make measuring cut, approx. 0.120" deep
- ▲ Measure drilled diameter produced

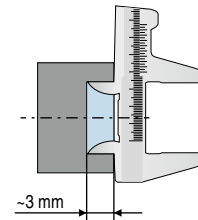

- ▲ If necessary correct drilling \varnothing
- ▲ Start machining

EcoCut Mini adapter – Design

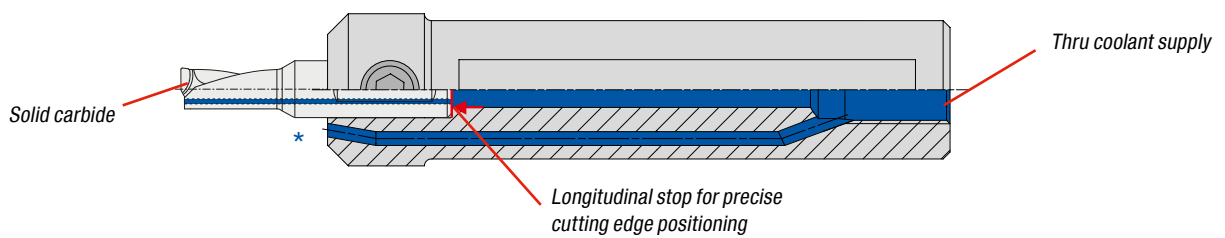

* Cross-section rotated by 90° for clarity

Mounting of the insert for EcoCut Classic

For tools up to \varnothing 0.315" right and left handed inserts are required.
From \varnothing 0.394"-1.260" neutral inserts are used.

Note!
Ensure correct installation position.

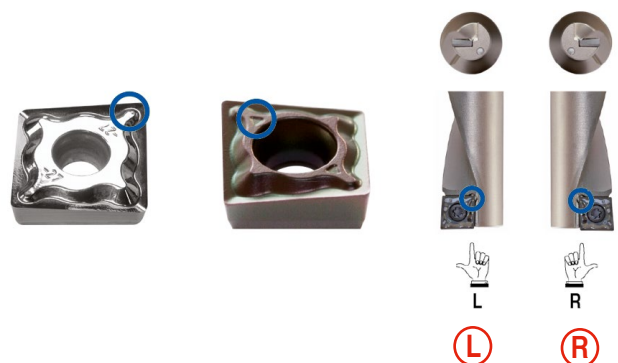

EcoCut ProfileMaster – the highlight with regard to efficiency

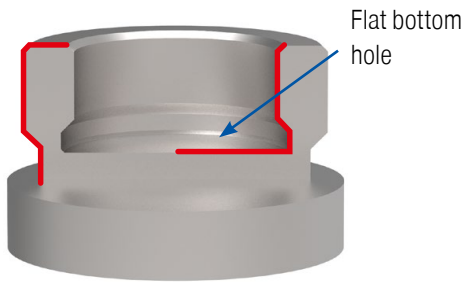

Right hand tool



right hand insert

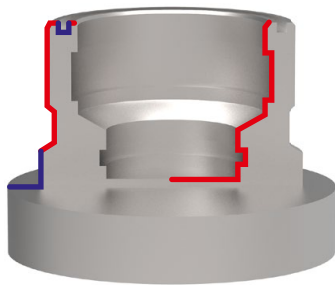

Right hand tool



left hand insert



right hand insert

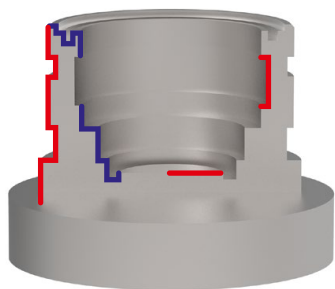

Left hand tool



Right hand tool



right hand insert

Version 90°

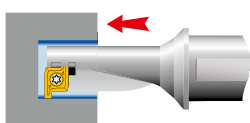

Drilling into solid material
with flat bottom hole

Boring

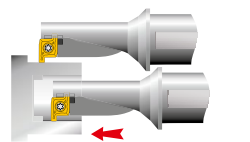

Turning External Diameters

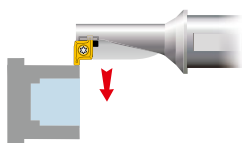

Turning Internal
Diameters

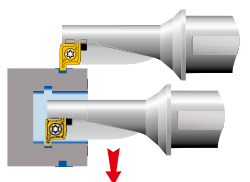

Turning Profiles



External radial grooving



Internal radial grooving

Version 0°

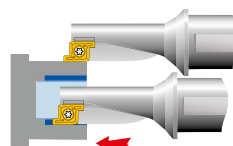

Turning External Diameters

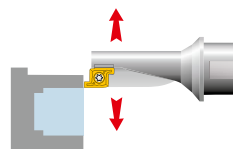

Turning Internal
Diameters

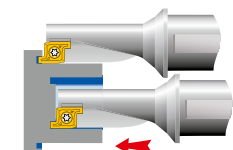

Turning Profiles

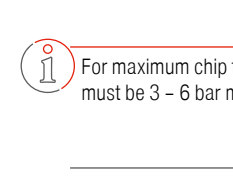

Axial grooving external



Axial grooving internal



For maximum chip transport efficiency when drilling, coolant pressure must be 3 – 6 bar minimum (optimal 7 – 10 bar).

EcoCut ProfileMaster – Axial Grooving

0° (from Ø .629“)

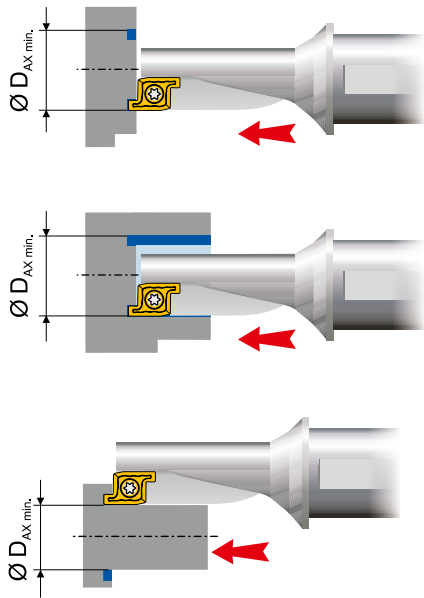

90°

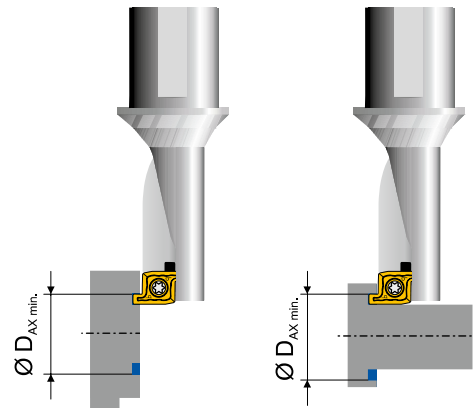

EcoCut ProfileMaster	ØD _{noml.} inch	ØD _{AX min.} inch	ØD _{AX max.} inch
PM 10R/L 1.5D	0.394	0.394	> 0.394
PM 10R/L 2.25D	0.394	0.394	> 0.394
PM 12R/L 1.5D	0.472	0.472	> 0.472
PM 12R/L 2.25D	0.472	0.472	> 0.472
PM 16R/L 1.5D	0.630	0.630	> 0.630
PM 16R/L 2.25D	0.630	0.630	> 0.630
PM 20R/L 1.5D	0.787	0.787	> 0.787
PM 20R/L 2.25D	0.787	0.787	> 0.787
PM 25R/L 1.5D	0.984	0.984	> 0.984
PM 25R/L 2.25D	0.984	0.984	> 0.984
PM 32R/L 1.5D	1.260	1.260	> 1.260
PM 32R/L 2.25D	1.260	1.260	> 1.260

$\text{ØD}_{AX \text{ min.}} = \text{ØD}_{noml.}$

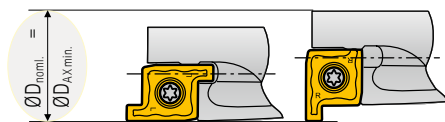

- ØD_{noml.} = Nominal tool diameter
- ØD_{AX min.} = smallest diameter for axial grooving
- ØD_{AX max.} = largest diameter for axial grooving

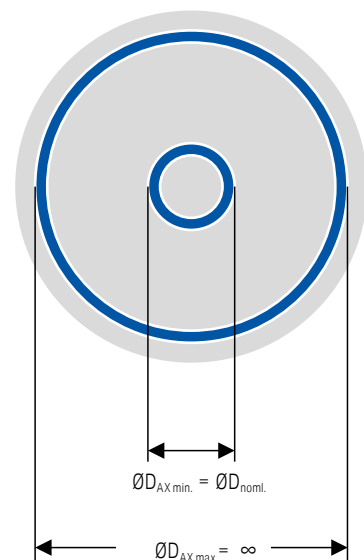

Application Tips

Recommendation for Optimum Results

Type of problem									Remedy measures
Type of wear				Work piece problems		Swarf control			
Edge breakage	Built-up edge	Wear on clearance face	Plastic deformation	Vibration	Surface quality	Chip too long (snarl chip)	Chip too short (fragmented chip)		
	▲	▼	▼	▼	▲	▼		Cutting data	Cutting speed
▼		⤿	▼	▲	▼	▲	▼		Feed rate
▲		▲	▲	▼	▲			Insert selection	Corner radius ▲ larger ▼ smaller
▼		▲	▲						Tool Material ▲ Wear resistance ▼ toughness
⤿				⤿	⤿			General criteria	Tool clamping
⤿				⤿	⤿				Work piece clamping
⤿				⤿	▼				Overhang
⤿		⤿		⤿	⤿				Tip height
	●	●	●		●	●			Cooling lubricant

▲ raise, increase large influence

↑ raise, increase small influence

▼ avoid, reduce large influence

↓ avoid, reduce small influence

⤿ control, optimize

● use

Factors influencing the selection of the correct cutting angle

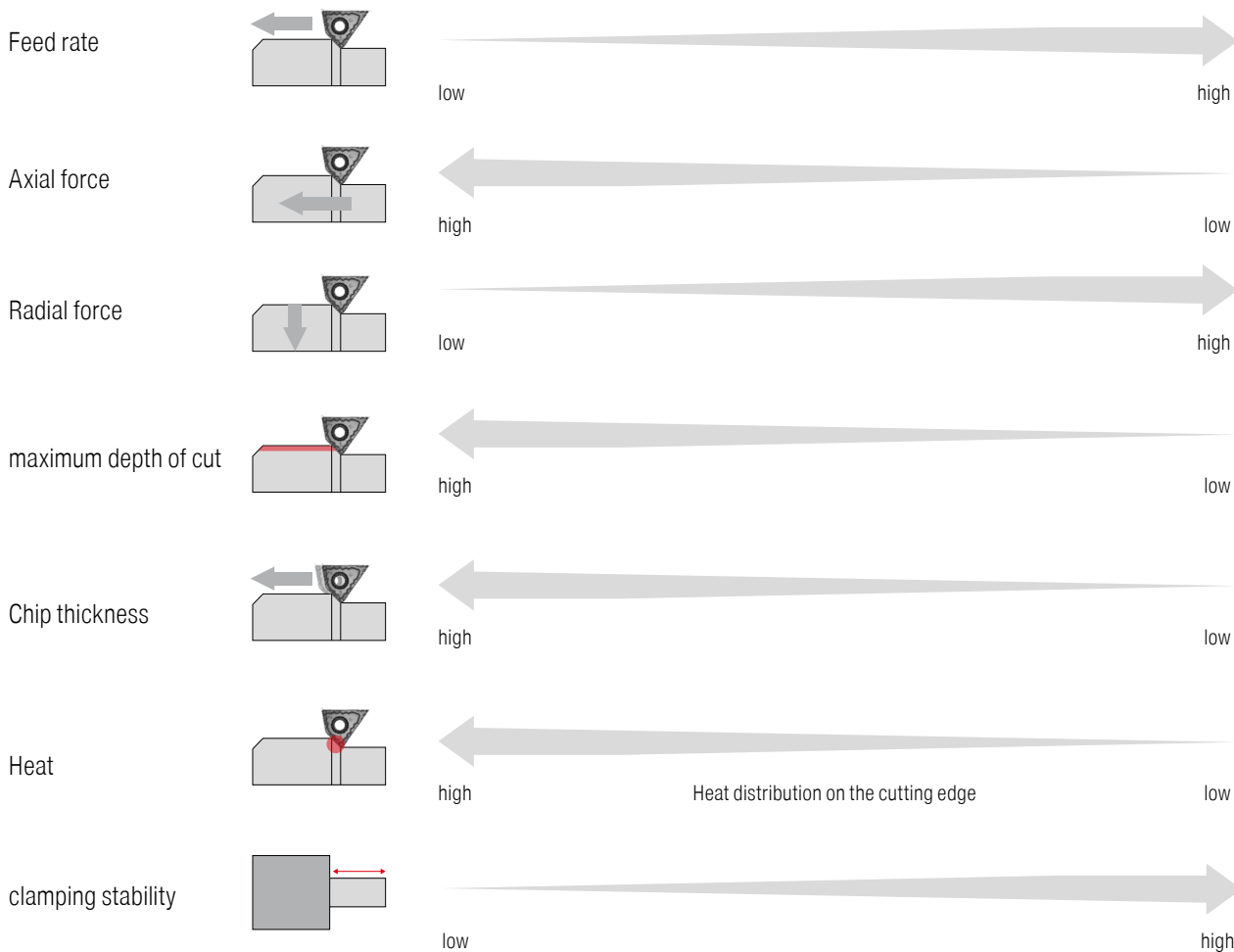
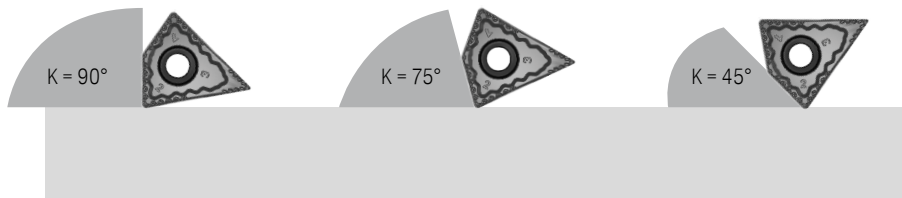
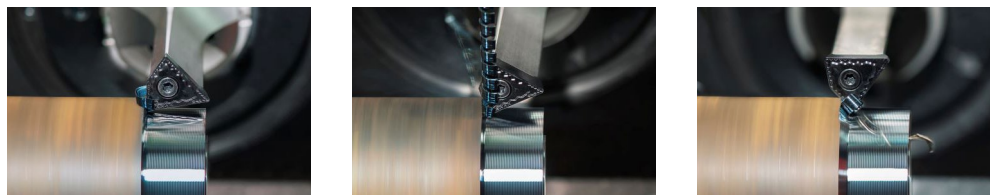

Approach angle

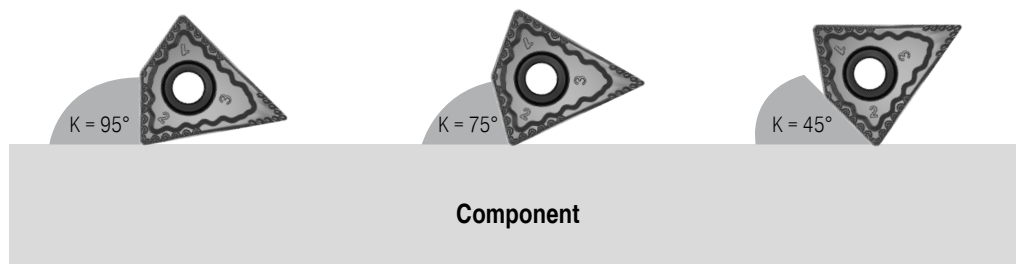

The approach angle always works from the edge of the component to the main cutting edge (tool).

Tool / workpiece length ratio

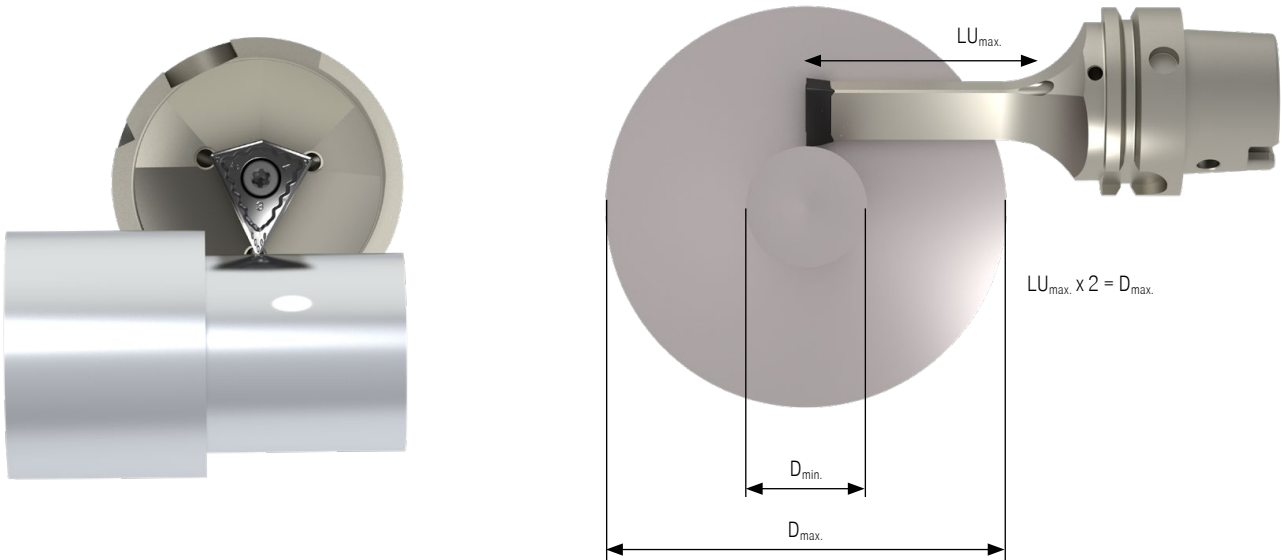

This table shows the diameter ranges you can work in with the different tool lengths.

Tool	D _{max.} in inch	7.87	7.48	7.09	6.69	6.30	5.91	5.51	5.12	4.72	4.33	3.94	3.54	3.15
PSC-63-100-FT 808055	D _{min.} in inch					5.00	4.53	4.02	3.46	2.87	2.20	1.34	0.00	0.00
PSC-63-125-FT 808055	D _{min.} in inch	5.43	4.92	4.33	3.54	2.76	1.65	0.00	0.00	0.00	0.00	0.00	0.00	0.00

Force data from the process

FreeTurn

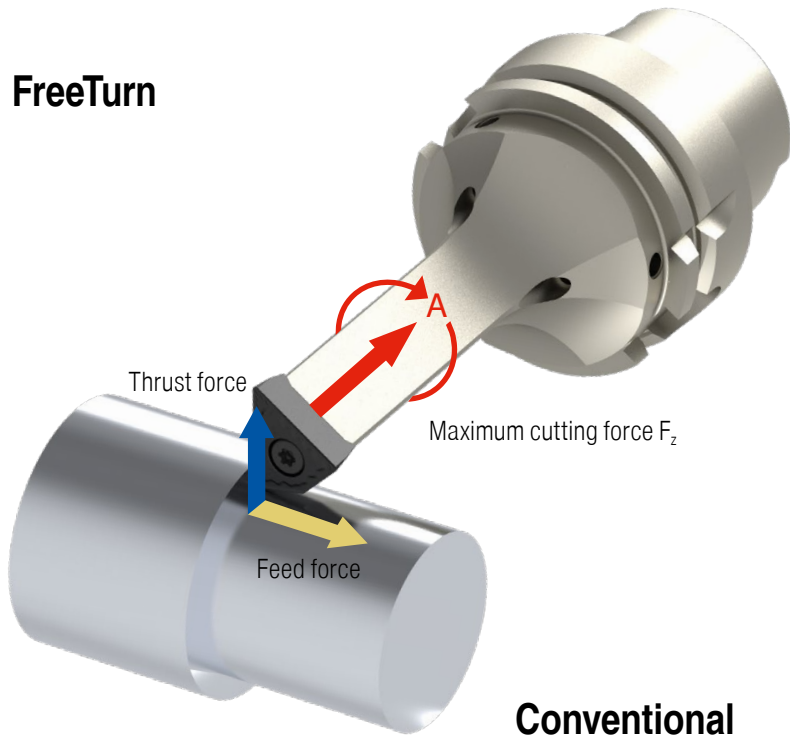

Conventional

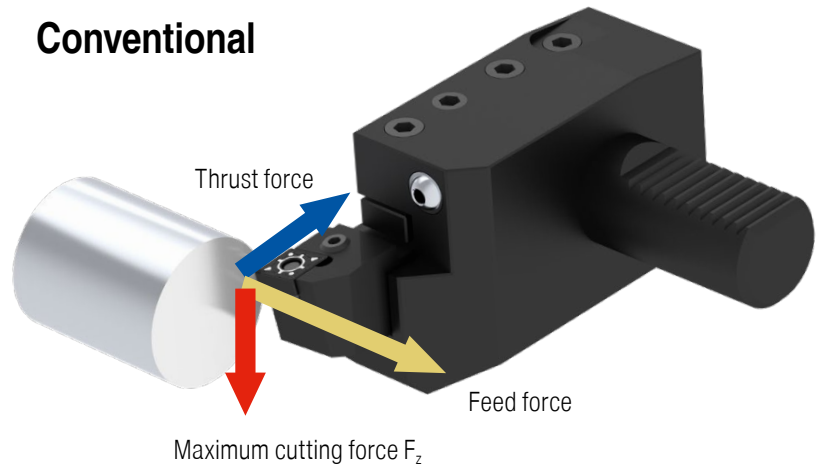

Practical test

Steel machining
shaft Ø 2.36"
4140 material
R_m 850 Nm

Cutting data:
v_c = 575 ft./min.
f = 0.012"/rev.
a_p = 0.120"
K = 95°

FreeTurn		Conventional
2136 N	XYZ	2206 N
920 N	FXY (feed force)	2143 N
1928 N	Maximum cutting force F _z	526 N

Grades Overview

EcoCut Classic

CTCP425 Carbide, Ti+Al₂O₃-coated
ISO | **P25** | K30 | M20
The wear-resistant choice for steel and cast iron materials under stable conditions and at high cutting speeds

CTCP435 Carbide, Ti+Al₂O₃-coated
ISO | **P35** | M30 | K40
The reliable choice for steel and cast iron materials under unstable conditions

CTPP430 Carbide, TiAlN-coated
ISO | **P30** | **M25** | K30 | N25 | S25 | O25
The universal high-performance grade for steel, austenitic steel and heat-resistant alloys

H210T Carbide, uncoated
ISO | K10 | **N10** | **S10** | O10
The wear-resistant carbide grade for machining aluminium and other non-ferrous metals

H216T Carbide, uncoated
ISO | **K15** | **N15** | S15 | O15
The uncoated carbide grade for machining aluminium and other non-ferrous metals. Also highly suitable for HSC machining.

FreeTurn

CTCP125 Carbide, TiCN-Al₂O₃-coated
ISO | **P25** | K25
The first choice for universal machining of steels

CTPM125 ISO | P35 | **M25**
The universal carbide grade with maximum toughness, without affecting the necessary hot hardness and wear resistance for stainless machining

H216T Carbide, uncoated
ISO | K15 | **N15** | S15 | O15
The uncoated carbide grade for machining aluminium and other non-ferrous metals. Also highly suitable for HSC machining.

EcoCut Mini

CTPP435 Carbide, TiAlN-coated
ISO | **P35** | **M30** | K30 | N30 | **S30** | O30
The universal high-performance grade for steel, austenitic steel and heat-resistant alloys

CTWN425 Carbide, uncoated
ISO | K20 | **N25** | S25 | O25
The uncoated carbide grade for machining aluminium and other non-ferrous metals

EcoCut ProfileMaster

CTPP430 Carbide, TiAlN-coated
ISO | **P30** | **M25** | K30 | N25 | **S25** | O25
The universal high-performance grade for steel, austenitic steel and heat-resistant alloys

Application

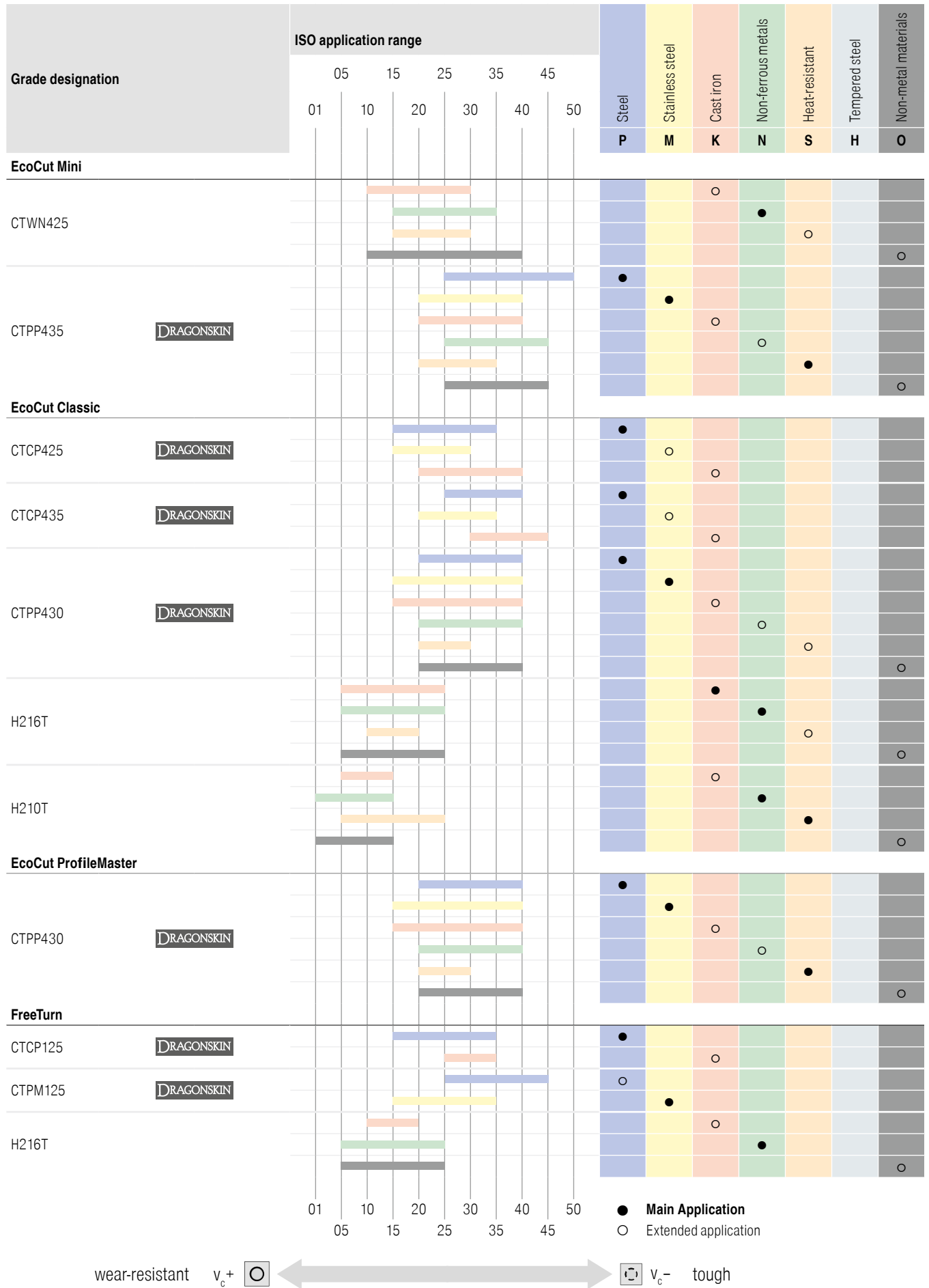

Designation System

FreeTurn – indexable insert designation

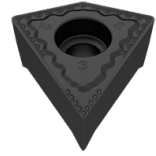

FT15 M/G 808055R080804 Q MMF CTCP125

1 2 3 4 5 6 7 8 9 10 11 12

- | | |
|---|---|
| 1 FreeTurn | 7 Corner radius 1 in mm |
| 2 Nominal diameter in mm | 8 Corner radius 2 in mm |
| 3 ISO tolerance (M = sintered, G = polished) | 9 Corner radius 3 in mm |
| 4 Cutter angle 1 in degrees | 10 Masterfinish – wiper geometry |
| 5 Cutter angle 2 in degrees | 11 Chip breaker (M = medium, F = fine) |
| 6 Cutter angle 3 in degrees | 12 Carbide Grade |

FreeTurn – holder designation

HSK - T63 - 100 - FT15 808055

1 2 3 4 5 6 7 8

- | | |
|--------------------------|------------------------------------|
| 1 System | 5 Nominal diameter in mm |
| 2 Size | 6 Cutter angle 1 in degrees |
| 3 Overhang length | 7 Cutter angle 2 in degrees |
| 4 FreeTurn | 8 Cutter angle 3 in degrees |



6

Designation System

EcoCut – indexable insert designation

X C E T 17 05 08 F N - 27P

1 2 3 4 5 6 7 8 9 10

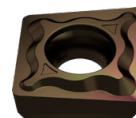

- 1 Insert shape
- 2 Clearance angle
- 3 Tolerances
- 4 Characteristics
- 5 Cutting length
- 6 Insert thickness
- 7 Corner radius
- 8 Cutting edge
- 9 Direction of cut
- 10 Chip groove

EcoCut – holder designation

ECC 32 R - 3.0D 17 H - E

1 2 3 4 5 6 7



- 1 System
- 2 Nominal diameter in mm
- 3 Direction of cut
- 4 maximum hole depth
- 5 insert size
- 6 Tool holder version in Densimet
- 7 Inch size shank

EcoCut ProfileMaster – indexable insert designation

PM 25 R G 35 30 04 - M20

1 2 3 4 5 6 7 8

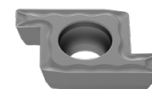

- 1 ProfileMaster
- 2 Nominal diameter in mm
- 3 Direction of cut
- 4 Version
- 5 Groove width in mm/10
- 6 Groove depth in mm/10
- 7 Corner radius
- 8 Chip groove

EcoCut ProfileMaster – holder designation

PMC 25 R - 2.25D - E

1 2 3 4 5

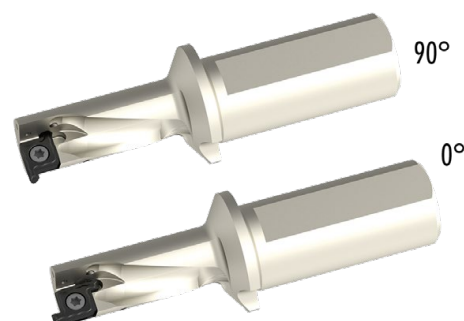

- 1 ProfileMaster
- 2 Nominal diameter in mm
- 3 Direction of cut
- 4 maximum hole depth
- 5 Inch size shank

New products for machining technicians

NEW

MaxiMill 271-12

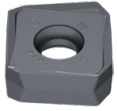

23+24

New system size for more economy

NEW

MaxiMill 211-20

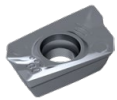

56-58

Indexable insert product extension

NEW

CTCM245

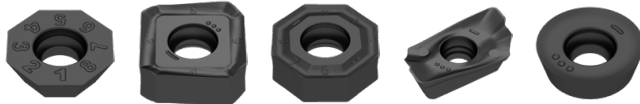

New high-performance grade for machining high-alloy steels

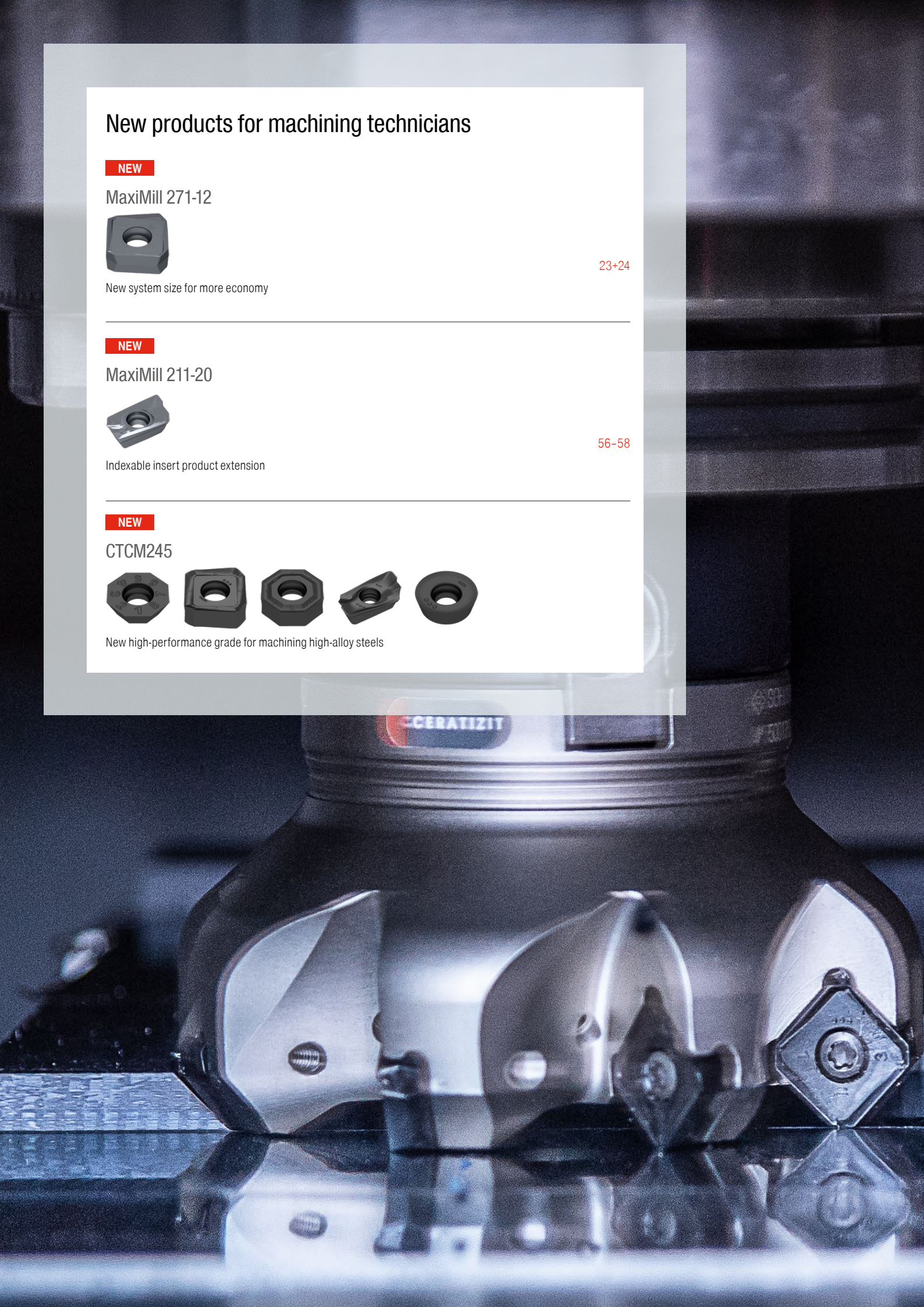



1 Indexable Drilling

Holemaking

2 Indexable Boring

3 Reaming

4 Indexable Turning

Turning

5 Parting and Grooving

6 Multifunction

7 Indexable Milling

7

Milling

8 Solid Milling

9 Material examples and
article no. index

Table of contents

Symbol explanation	2
Toolfinder	3-11
Product program	12-96
Technical Information	
Cutting data standard values	97-100
Application parameters – Face milling	101-109
Application parameters – End milling	110-124
Application parameters – Form milling	125-130
Application parameters – Other milling systems	131
Abbreviations & dimensions	132
Engagement conditions	133
ISO Designation System	134+135
Cutting Edge Wear Conditions	136
Chip Breakers Overview	137
Chip groove description	138+139
Grades Overview	140
Grade description	141+142

CERATIZIT \ Performance

Premium quality tools for high performance.

The premium quality tools from the **CERATIZIT Performance** product line have been designed for specific applications and are distinguished by their outstanding performance. If you make high demands on the performance of your production and want to achieve the very best results, we recommend the Premium tools in this product line.

Symbol explanation

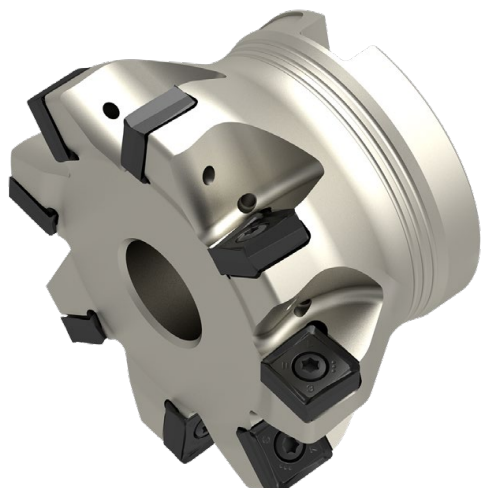
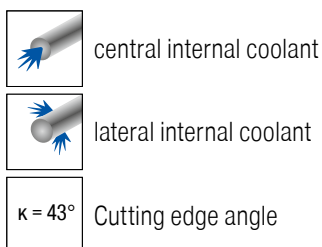

Application symbols

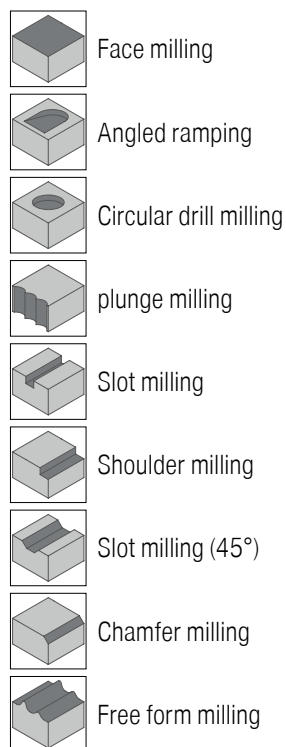

- ZNF = Number of flutes
- = **Main Application**
- = Extended application

metric  Additional metric items are available in our Online-Shop at cuttingtools.ceratizit.com and in the metric main catalog.

Toolfinder – Application Selection Guide

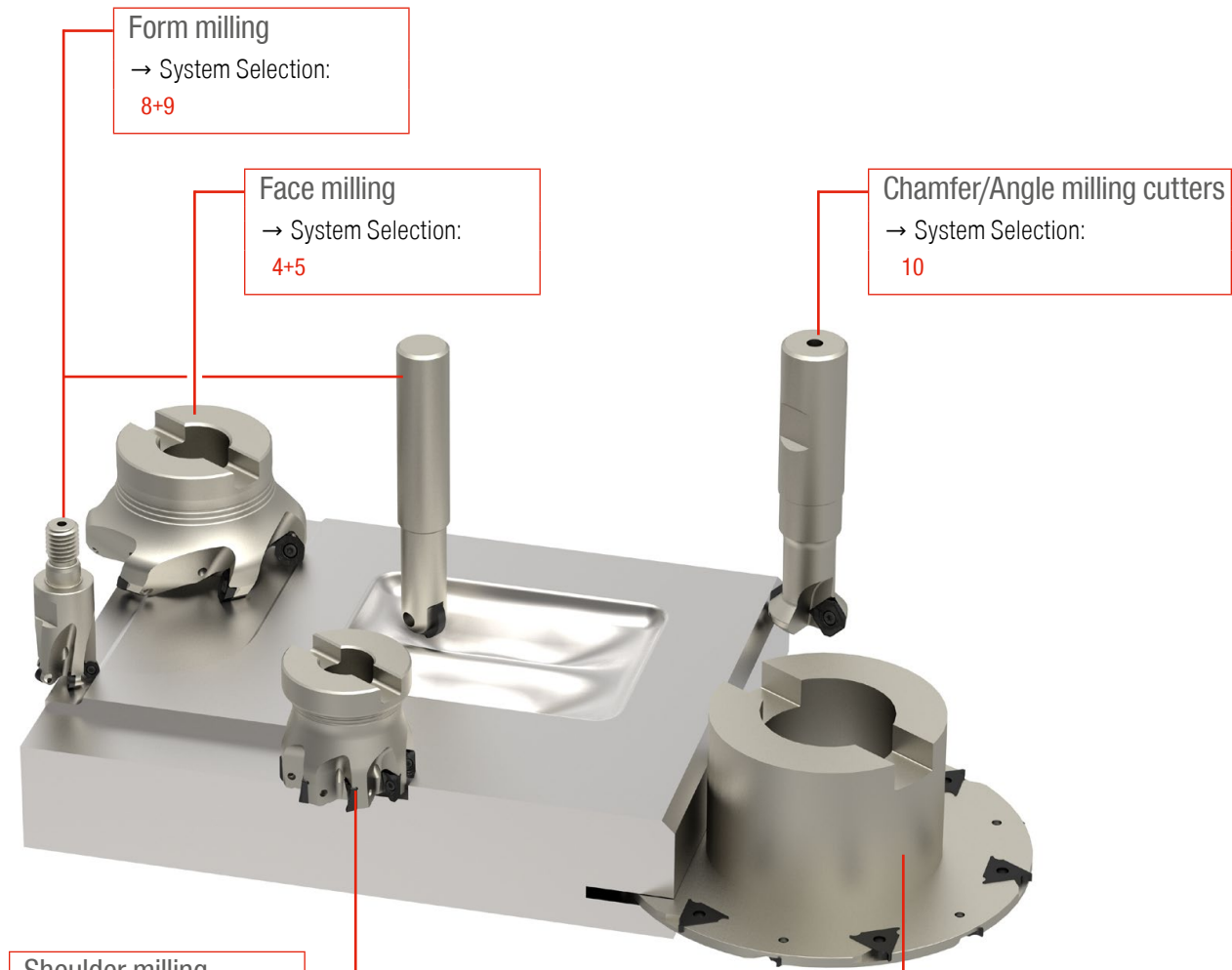

Form milling
→ System Selection:
8+9

Face milling
→ System Selection:
4+5

Chamfer/Angle milling cutters
→ System Selection:
10

Shoulder milling
→ System Selection:
6+7

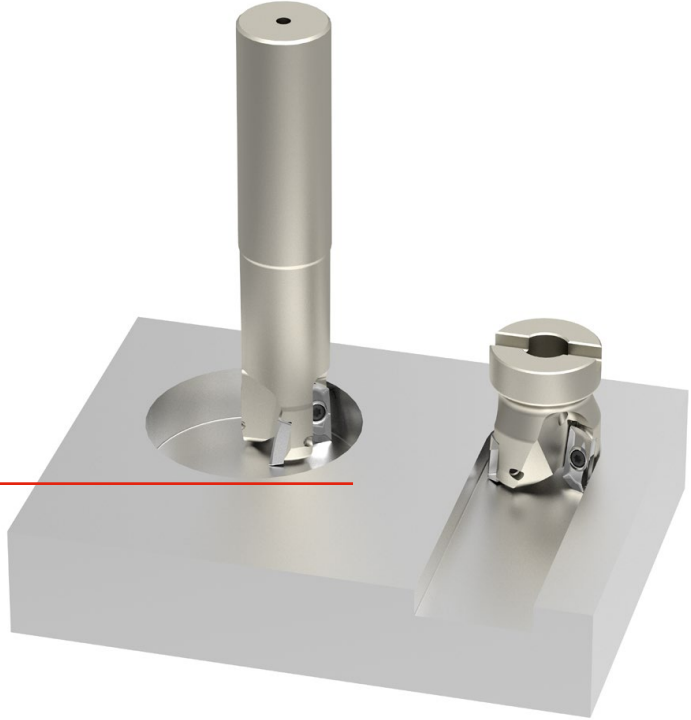

High Speed Cutting (HSC) /
High Performance Cutting (HPC)
→ System Selection:
6+7

Toolfinder – Face Milling Cutters

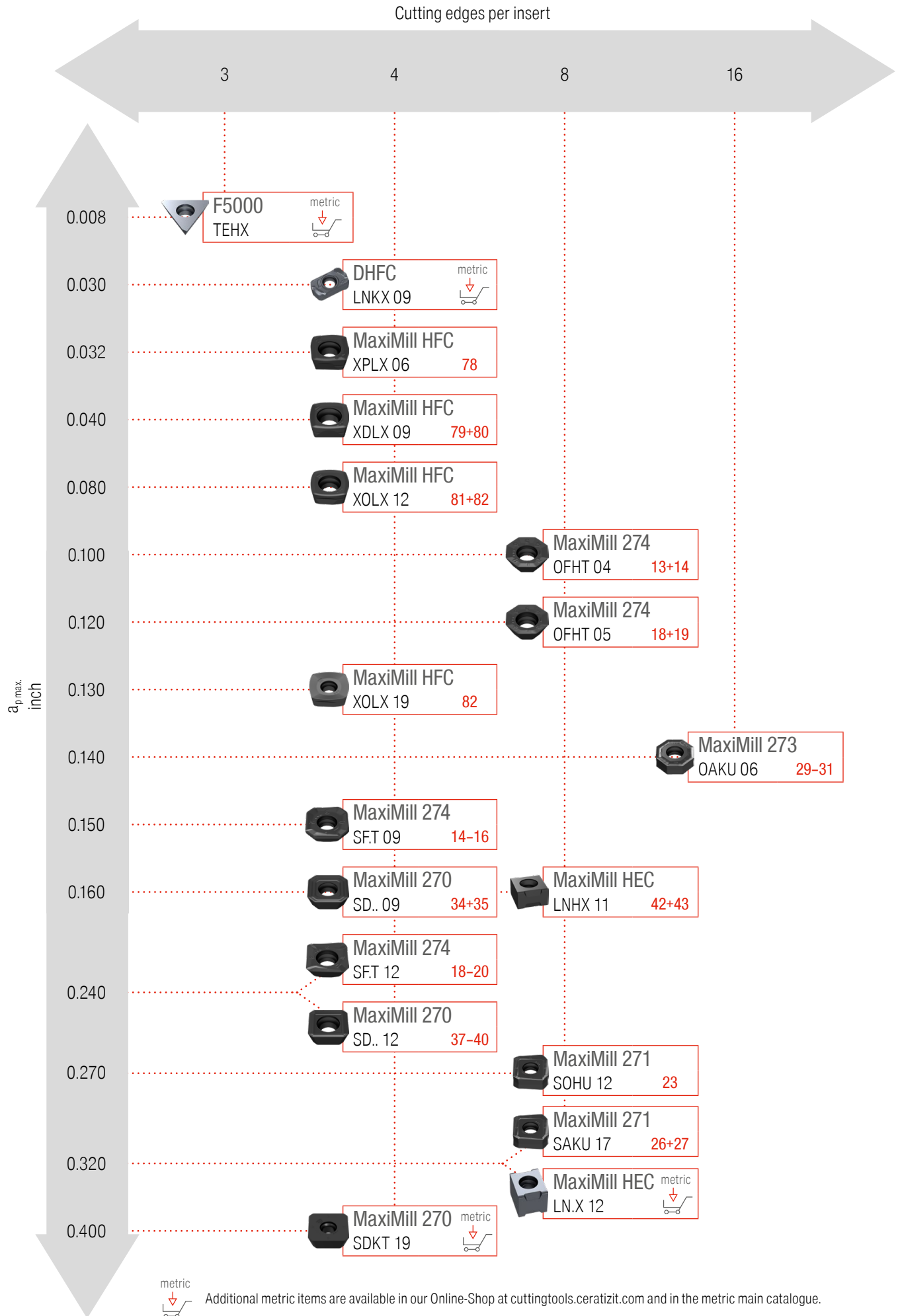

Overview – Face Milling Cutters

System	Inserts	Cutting edges per insert	a_p max. inch	Ø-range inch			Material Legend	Page No.
MaxiMill 274	OFH. 04.. / 05.. SF.T 09.. / 12..	8 4	0.100 – 0.240"				12-20	
MaxiMill 271	SOHU 1204.. SAKU 1706..	8	0.270 – 0.330"				21-27	
MaxiMill 273	OAKU 0605..	16	0.137"				28-31	
MaxiMill 270	SD.. 0903.. / 1204.. / 19..	4	0.160 – 0.400"				32-40	
MaxiMill HEC	LNHX 1106..	8	0.160 – 0.320"				41-43	
MaxiMill HFC	X..X 06.. / 09.. / 12.. / 19..	4	0.032 – 0.129"					76-82

Additional diameters are available upon request.



Additional metric items are available in our Online-Shop at cuttingtools.ceratizit.com and in the metric main catalog.



F 5000





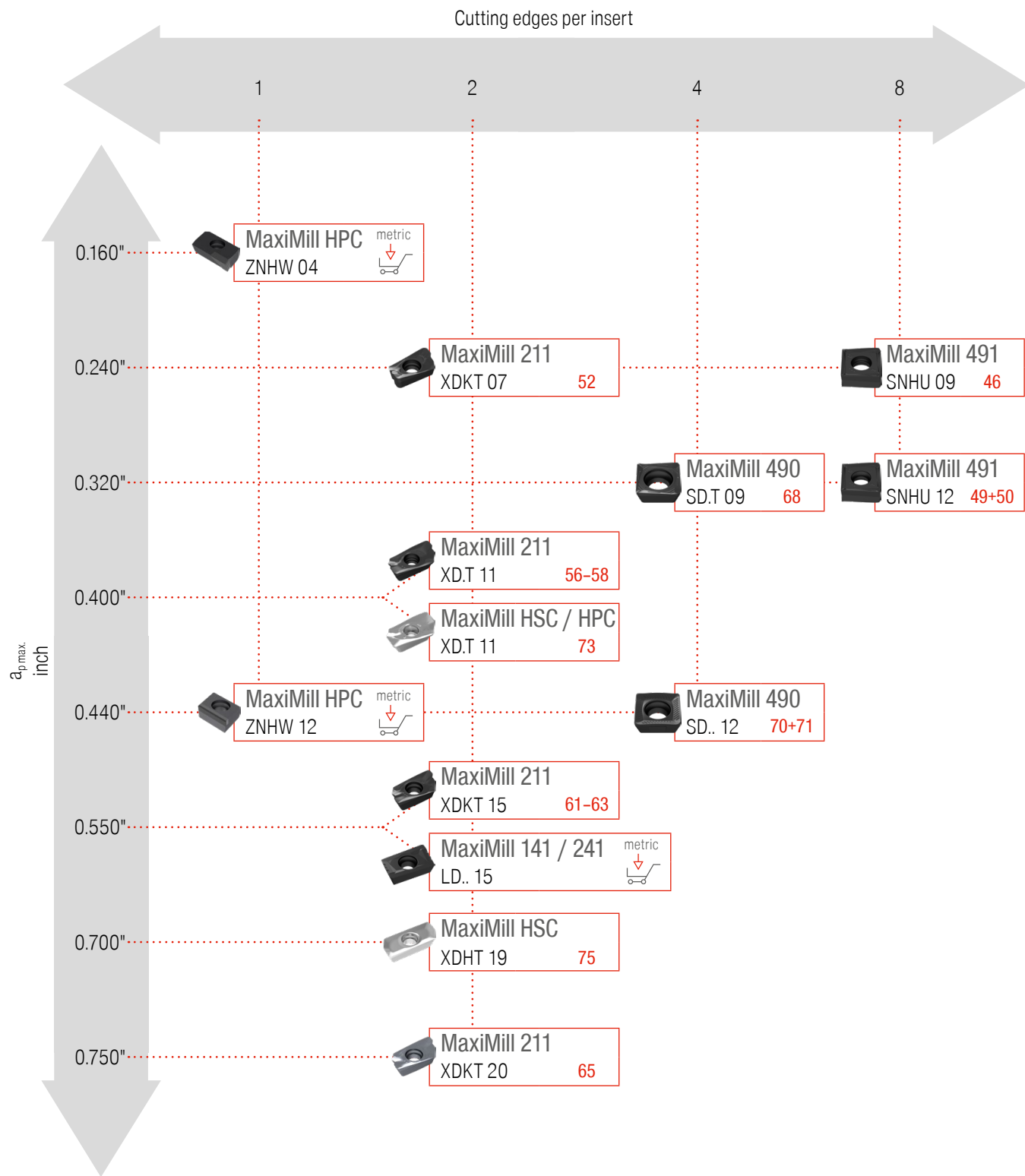









DHFC

Toolfinder – shoulder milling



Additional metric items are available in our Online-Shop at cuttingtools.ceratizit.com and in the metric main catalogue.

Overview – Shoulder Milling Cutters

System	Inserts	Cutting edges per insert	a_p max. inch	Ø-range inch		Material Compatibility	Page No.
MaxiMill 491	SNHU 09T3.. / 1204..	8	0.240 – 0.320"				44-50
MaxiMill 211	XD.T 0703.. / 11T3.. / 1505.. / 2007..	2	0.240 – 0.750"				51-65
MaxiMill 211KN	XD.T 11T3.. / 1505.. / 2007..	2	1.00 – 3.00"				55+60
MaxiMill 490	SD.. 09T3.. / 1205..	4	0.320 – 0.430"				66-71
MaxiMill HSC	XD.. 11T3.. / 1904..	2	0.400 – 0.700"				72-75

 Additional diameters are available upon request.



Additional metric items are available in our Online-Shop at cuttingtools.ceratizit.com and in the metric main catalog.

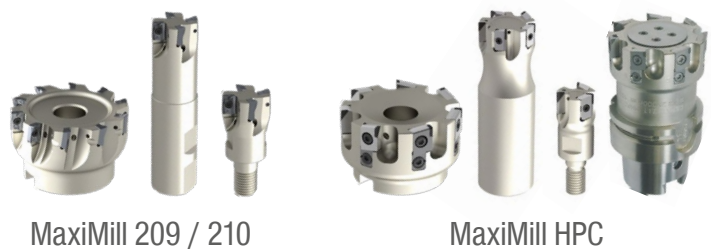

MaxiMill 209 / 210

MaxiMill HPC

Toolfinder – form milling

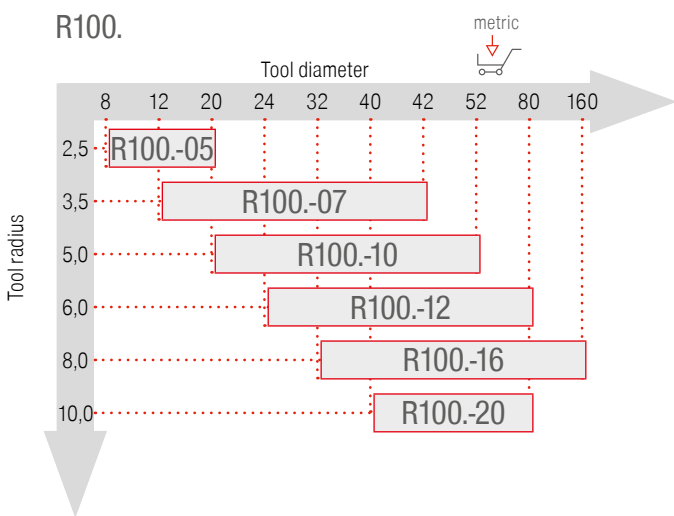
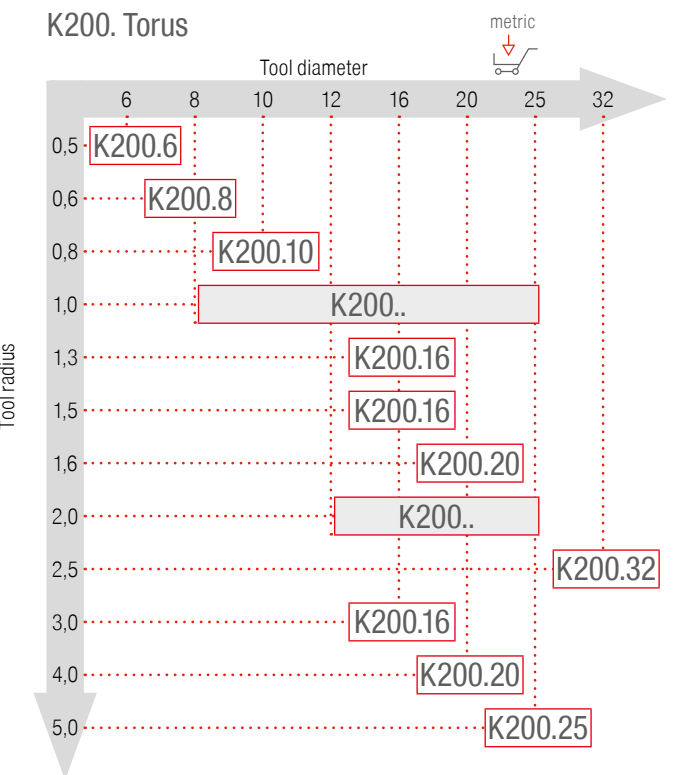
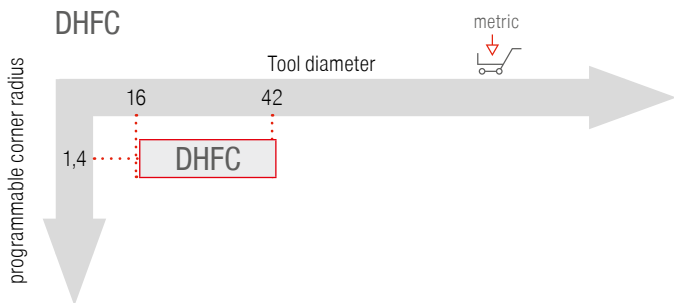
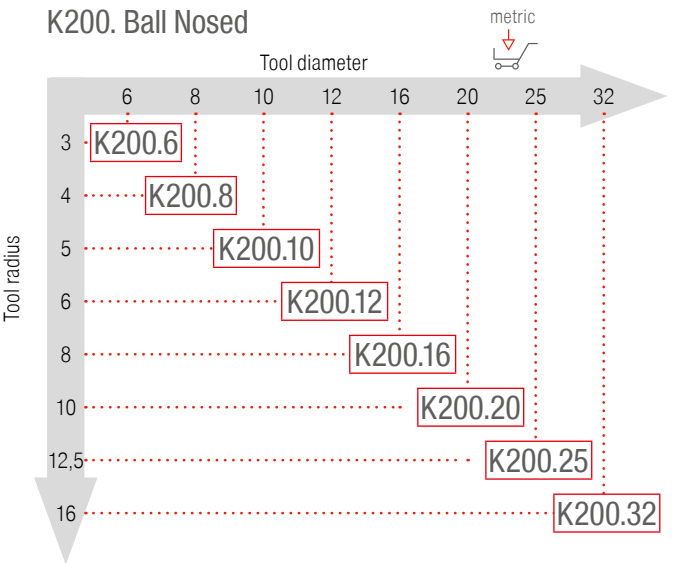
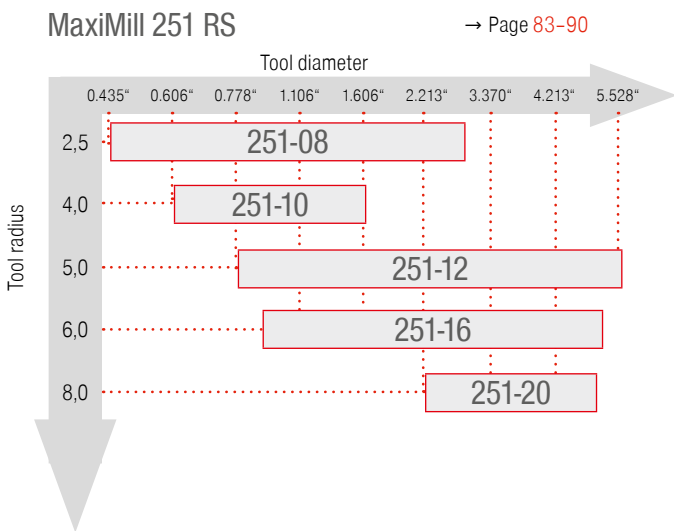
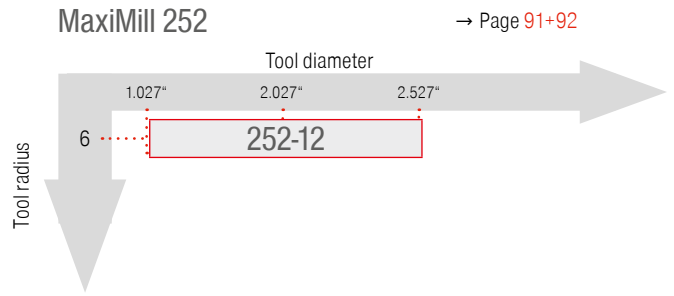
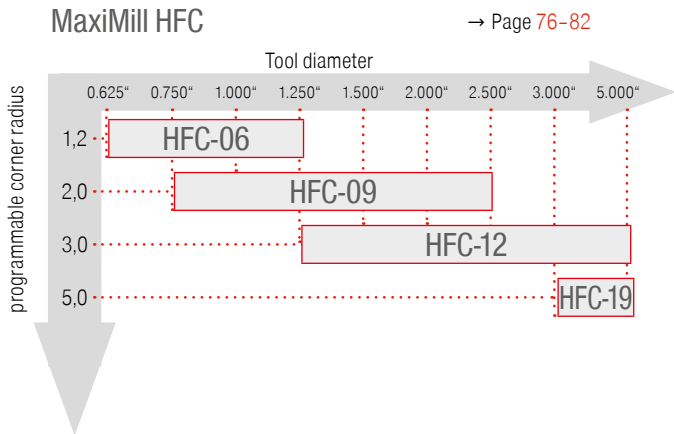

Application range
 Tool diameter

Additional metric items are available in our Online-Shop at cuttingtools.ceratizit.com and in the metric main catalog.

Overview – form milling

System	Inserts	Cutting edges per insert	a_p max. inch	Ø-range inch			Material Compatibility	Page No.
MaxiMill HFC	X.LX 06.. / 09.. / 12.. / 19..	4	0.032–0.130"	Ø 0.625–1.250"	Ø 0.625–1.500"	Ø 1.500–5.000"		76–82
MaxiMill 251 RS	R..X 05.. / 08.. / 10.. / 12.. / 16.. / 20..	8	0.100–0.400"	Ø 0.606–1.106"	Ø 0.435–1.106"	Ø 1.185–5.213"		83–90
MaxiMill 252	RNHU 10.. / 12..	8	0.120"			Ø 1.027–2.527"		91+92

Additional diameters are available upon request.



R100.



DHFC



K200. Ball Nosed







Additional metric items are available in our Online-Shop at cuttingtools.ceratizit.com and in the metric main catalog.

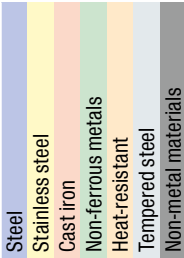

K200. Torus

Overview – Chamfer / Angle Milling Cutters

System	Inserts	Cutting edges per insert	a_p max. inch	\emptyset -range inch		Page No.
MaxiMill 272	SD..0903..	4	0.160"	 \emptyset 0.500"		33-35
Insert countersink 90°	TOHX 090204 / 140305	2		 \emptyset 0.748-1.457"		95+96

 Additional diameters are available upon request.



MaxiMill 242

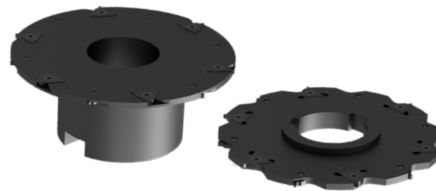

TX



Additional metric items are available in our Online-Shop at cuttingtools.ceratizit.com and in the metric main catalogue.



Overview – Combi Milling Cutters

System	Cutting edges per insert	a_p max. mm	\emptyset -range inch	Material Legend	Page No.
MaxiMill 260	2-16	0.032 - 1.30"	\emptyset 3.000-10.000		93
	Cartridge no. 041 031 029 032 058 057				94
	Cartridge no. 018				94
	Cartridge no. 042 039 051 025				94
	Cartridge no. 055 054 056				94
	Cartridge no. 052 053				94

MaxiMill – End milling cutter C 274-04/-09

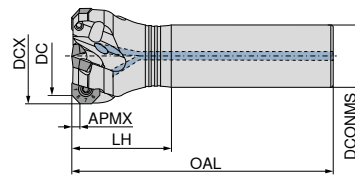
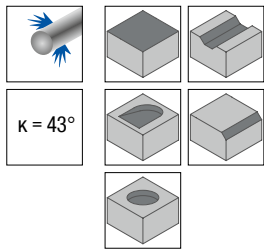

Designation	DC inch	DCX inch	ZNF	OAL inch	LH inch	DCONMS inch	torque moment Nm	Insert
C274.100.R.04-09-A075-125-EF	1.000	1.228	4	3.350	1.250	0.750	1,2	OF.. 0403 / SF.. 0903
C274.100.R.04-09-B075-125-EF	1.000	1.228	4	3.350	1.250	0.750	1,2	OF.. 0403 / SF.. 0903
C274.125.R.05-09-A100-150-EF	1.250	1.479	5	3.900	1.500	1.000	1,2	OF.. 0403 / SF.. 0903
C274.125.R.05-09-B100-150-EF	1.250	1.479	5	3.900	1.500	1.000	1,2	OF.. 0403 / SF.. 0903

B	A
58 743 ...	58 743 ...
	10004
30004	
	12505
32505	

MaxiMill – Shell mill A 274-04/-09

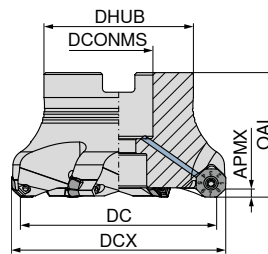
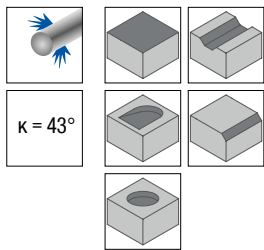

Designation	DC inch	DCX inch	ZNF	APMX inch	OAL inch	DHUB inch	DCONMS _{H6} inch	torque moment Nm	Insert
A274.150.R.05-09-A050-175-EF	1.500	1.740	5	0.098	1.420	1.420	0.500	1,2	OF.. 0403 / SF.. 0903
A274.200.R.07-09-A075-175-EF	2.000	2.230	7	0.098	1.750	1.750	0.750	1,2	OF.. 0403 / SF.. 0903
A274.300.R.09-09-A100-200-EF	3.000	3.230	9	0.098	2.250	2.250	1.000	1,2	OF.. 0403 / SF.. 0903
A274.400.R.11-09-B125-200-EF	4.000	4.230	11	0.098	2.750	2.750	1.250	1,2	OF.. 0403 / SF.. 0903

58 744 ...

Spare parts

DC	80 950 ...	70 950 ...	70 950 ...
1.500	039	303	133
2.000	039	303	133
3.000	039	303	133
4.000	039	303	133

Screwdriver	Molykote	Clamping screw
80 950 ...	70 950 ...	70 950 ...

Two insert types – ONE Cutter

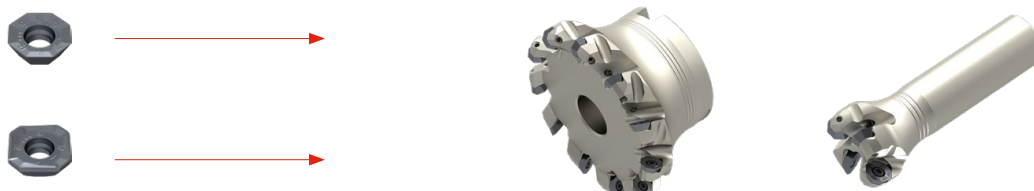

OFHT / OFHW / SFHT / SFKT

Designation	IC inch	D1 inch	L inch	BS inch	S inch	AN °
OFH. 0403..	0.375	0.132	0.155	-	0.125	25
SF.T 0903..	0.386	0.132	0.354	0.089	0.138	25

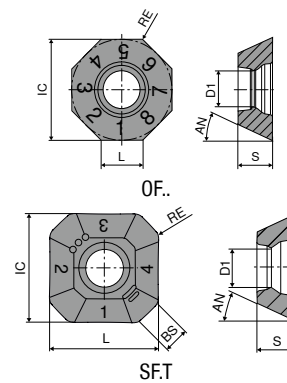

OFHT

ISO	RE inch	-F50 CTCP220	-F50 CTPP225	-F50 CTCP230	-M50 CTCP230	-F50 CTPP235	-M50 CTPP235
		DRAGONSKIN	DRAGONSKIN	DRAGONSKIN	DRAGONSKIN	DRAGONSKIN	DRAGONSKIN
		OFHT	OFHT	OFHT	OFHT	OFHT	OFHT
		51 002 ...	51 002 ...	51 002 ...	51 003 ...	51 002 ...	51 003 ...
040305SN	0.020	255	055	005	005	105	105
P		●	●	●	●	●	●
M						○	○
K				○	○	○	○
N							
S							
H							
O							

OFHT / OFHW

ISO	RE inch	-F50 CTPM225	-F50 CTCM235	-F50 CTPM240	-M50 CTPM240	-F50 CTPM245	CTPM245
		DRAGONSKIN	DRAGONSKIN	DRAGONSKIN	DRAGONSKIN	DRAGONSKIN	DRAGONSKIN
		OFHT	OFHT	OFHT	OFHT	OFHT	OFHW
		51 002 ...	51 002 ...	51 002 ...	51 003 ...	51 002 ...	51 105 ...
040302EN	0.008						452
040305SN	0.020	205	305	405	405	455	
P		●	●	○	○	●	●
M		●	●	●	●	●	●
K							
N							
S							
H							
O							

OFHT / OFHW

ISO	RE inch	51 002 ...	51 105 ...	51 003 ...	50 459 ...	51 002 ...	50 457 ...	51 002 ...
040302EN	0.008		90201		505		504	
040305FN	0.020	90501		505		15500		555
040305SN	0.020							
P		•	•					
M		•	•					
K				•	○			
N					•			
S		○	○			•	•	•
H								
O					○			

ISO	RE inch	51 012 ...	51 013 ...	51 012 ...	51 013 ...
0903AFSR	0.039	270	270	070	070
P		•	•	•	•
M					
K					
N					
S					
H					
O					

SFHT / SFKT

ISO	RE inch	51 012 ...	51 013 ...	51 012 ...	51 013 ...
0903AFSR	0.039	270	270	070	070
P		•	•	•	•
M					
K					
N					
S					
H					
O					

SFHT / SFKT

ISO	RE inch	-F50 CTCP230 DRAGONSKIN SFHT 51 012 ...	-M50 CTCP230 DRAGONSKIN SFKT 51 013 ...	-F50 CTPP235 DRAGONSKIN SFHT 51 012 ...	-M50 CTPP235 DRAGONSKIN SFKT 51 013 ...
0903AFSR	0.039	020	020	120	120
P		●	●	●	●
M				○	○
K		○	○	○	○
N					
S					
H					
O					

SFHT / SFKT

ISO	RE inch	-F50 CTPM225 DRAGONSKIN SFHT 51 012 ...	-M50 CTPM225 DRAGONSKIN SFKT 51 013 ...	-F50 CTCM235 DRAGONSKIN SFHT 51 012 ...	-F50 CTPM240 DRAGONSKIN SFHT 51 012 ...	-M50 CTPM240 DRAGONSKIN SFKT 51 013 ...	-F50 CTPM245 DRAGONSKIN SFHT 51 012 ...	NEW -F50 CTCM245 DRAGONSKIN SFHT 51 012 ...
0903AFSR	0.039	220	220	320	420	42000	470	92001
P		●	●	●	○	○	●	●
M		●	●	●	●	●	●	●
K								
N								
S								○
H								
O								

SFKT / SFHT

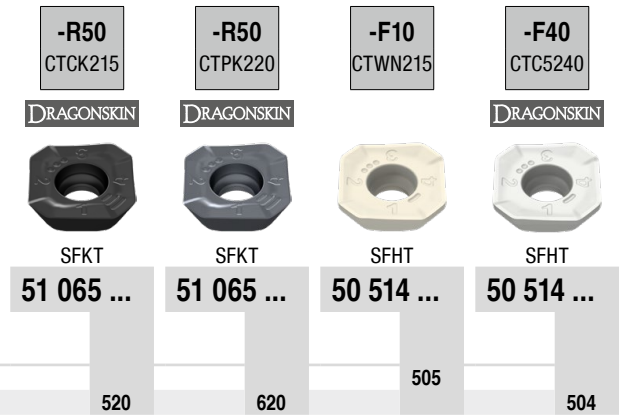

ISO	RE inch	51 065 ...	51 065 ...	50 514 ...	50 514 ...
0903AFFR	0.039			505	
0903AFSR	0.039	520	620		504
P					
M					
K		●	●	○	
N				●	
S					●
H					
O				○	

Milling guide

Cutting data standard values	→ 97-100	Machining strategy	→ 101
Starting Parameter	→ 102	Technical Information	→ 132-136
Chip groove description and overview	→ 137-139	Grade description and overview	→ 140-142

MaxiMill – Shell mill A 274-05/-12

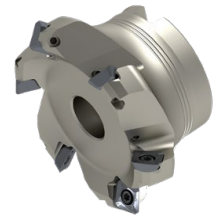
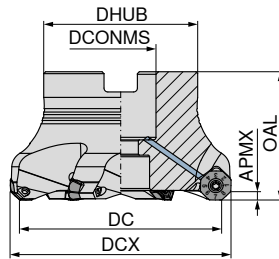
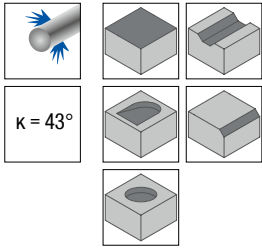

58 772 ...

Designation	DC inch	DCX inch	ZNF	APMX inch	OAL inch	DHUB inch	DCONMS _{H6} inch	torque moment Nm	Insert	
A274.200.R.04-12-A075-175-EF	2.000	2.320	4	0.126	1.750	1.750	0.750	3,2	OFHT 0504 / SFKT 1204	20004
A274.250.R.05-12-A100-200-EF	2.500	2.820	5	0.126	2.190	2.190	1.000	3,2	OFHT 0504 / SFKT 1204	25005
A274.300.R.06-12-A100-200-EF	3.000	3.320	6	0.126	2.190	2.190	1.000	3,2	OFHT 0504 / SFKT 1204	30006
A274.400.R.07-12-A125-200-EF	4.000	4.320	7	0.126	2.750	2.750	1.250	3,2	OFHT 0504 / SFKT 1204	40007
A274.500.R.08-12-B150-200-EF	5.000	5.320	8	0.126	3.810	3.810	1.500	3,2	OFHT 0504 / SFKT 1204	50008
A274.600.R.10-12-B200-200-EF	6.000	6.320	10	0.126	4.880	4.880	2.000	3,2	OFHT 0504 / SFKT 1204	60010

Screwdriver	Molykote	Clamping screw
80 950 ...	70 950 ...	70 950 ...
120	303	340

Spare parts
DC
2.000 - 6.000

Two insert types – ONE Cutter

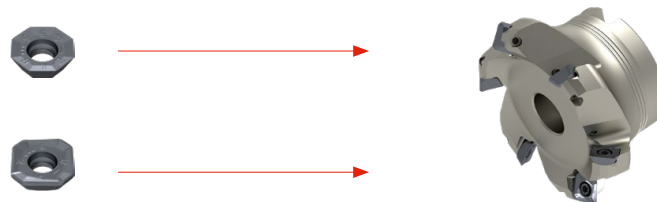

OFHT / SFHT / SFKT

Designation	IC inch	D1 inch	L inch	BS inch	S inch	AN °
OFHT 0504..	0.500	0.189	0.177	-	0.187	25
SF.T 1204..	0.500	0.189	0.500	0.056	0.187	25

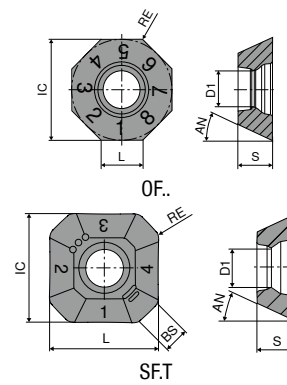

OFHT

	-F50 CTCP230	-M50 CTCP230	-F50 CTPP235	-M50 CTPP235
	DRAGONSKIN	DRAGONSKIN	DRAGONSKIN	DRAGONSKIN
	OFHT 51 002 ...	OFHT 51 003 ...	OFHT 51 002 ...	OFHT 51 003 ...
	010	01000	110	11000

ISO	RE inch
050410SN	0.039

P	●	●	●	●
M	○	○	○	○
K	○	○	○	○
N				
S				
H				
O				



OFHT

	-F50 CTPM225	-M50 CTPM225	-F50 CTCM235	-F50 CTPM240	-M50 CTPM240	-F50 CTPM245
	DRAGONSKIN	DRAGONSKIN	DRAGONSKIN	DRAGONSKIN	DRAGONSKIN	DRAGONSKIN
	OFHT 51 002 ...	OFHT 51 003 ...	OFHT 51 002 ...	OFHT 51 002 ...	OFHT 51 003 ...	OFHT 51 002 ...
	210	210	310	410	41000	460

ISO	RE inch
050410SN	0.039

P	●	●	●	○	○	●
M	●	●	●	●	●	●
K						
N						
S						
H						
O						

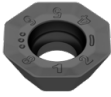
OFHT

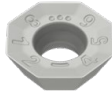
NEW		
-F50 CTCM245	-F10 CTWN215	-F50 CTC5240
DRAGONSKIN		DRAGONSKIN
		
OFHT	OFHT	OFHT
51 002 ...	51 122 ...	51 002 ...
91001	36000	16000

ISO	RE inch
050410FN	0.039
050410SN	0.039

P	•
M	•
K	○
N	•
S	○
H	
O	○

SFHT / SFKT

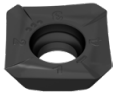
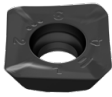
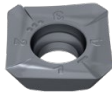
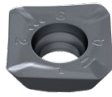
-F50 CTCP230	-M50 CTCP230	-F50 CTPP235	-M50 CTPP235
DRAGONSKIN	DRAGONSKIN	DRAGONSKIN	DRAGONSKIN
			
SFHT	SFKT	SFHT	SFKT
51 012 ...	51 013 ...	51 012 ...	51 013 ...
02500	025	12500	125

ISO	RE inch
1204AFSR	0.039

P	•	•	•	•
M			○	○
K	○	○	○	○
N				
S				
H				
O				

SFHT / SFKT

ISO	RE inch					
1204AFSR	0.039					
P		•	•	•	•	○
M		•	•	•	•	•
K						
N						
S						
H						
O						

Grade	ISO	RE inch	Material	Tool Type	Part Number	RE inch
-F50	CTPM225		DRAGONSKIN	SFHT	51 012 ...	225
-M50	CTPM225		DRAGONSKIN	SFKT	51 013 ...	225
-F50	CTCM235		DRAGONSKIN	SFHT	51 012 ...	325
-M50	CTCM235		DRAGONSKIN	SFKT	51 013 ...	325
-F50	CTPM240		DRAGONSKIN	SFHT	51 012 ...	42500
-M50	CTPM240		DRAGONSKIN	SFKT	51 013 ...	425

SFHT

ISO	RE inch				
1204AFER	0.039				
1204AFFR	0.039				
1204AFSR	0.039				
P			•	•	
M			•	•	
K					○
N					•
S				○	•
H					
O					○

Grade	ISO	RE inch	Material	Tool Type	Part Number	RE inch
-F50	CTPM245		DRAGONSKIN	SFHT	51 012 ...	47500
NEW -F50	CTCM245		DRAGONSKIN	SFHT	51 012 ...	92501
-F10	CTWN215			SFHT	51 123 ...	37000
-F40	CTC5240		DRAGONSKIN	SFHT	50 514 ...	50900

Milling guide

Cutting data standard values	→ 97-100	Machining strategy	→ 103
Starting Parameter	→ 104	Technical Information	→ 132-136
Chip groove description and overview	→ 137-139	Grade description and overview	→ 140-142

MaxiMill – End milling cutter C 271-12

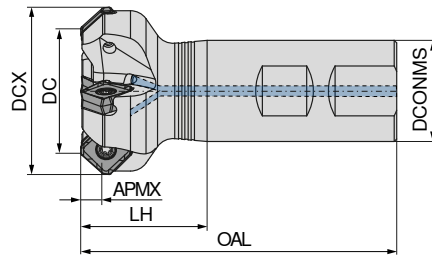
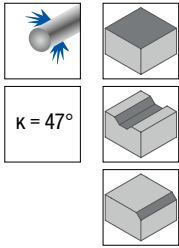

NEW
B

58 786 ...

Designation	DC inch	DCX inch	ZNF	APMX inch	OAL inch	LH inch	DCONMS _{h6} inch	Insert	
C271.0125.R.03-12-B-150-EF	1.250	1.763	3	0.267	4.000	1.500	1.250	SOHU 1204.. / XOHU 1204..	01203
C271.0150.R.04-12-B125-150-EF	1.500	2.013	4	0.267	4.000	1.500	1.250	SOHU 1204.. / XOHU 1204..	01504

Spare parts
DC
1.250 - 1.500

Screwdriver	Molykote	Clamping screw
80 950 ...	70 950 ...	70 950 ...
128	303	859

MaxiMill – A 271-12 Face mill

▲ 8 cutting edges per insert

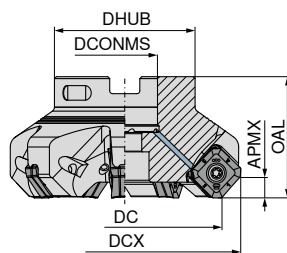
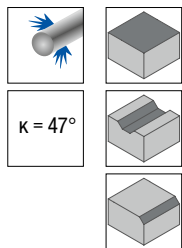

NEW

NEW

Designation	DC inch	DCX inch	ZNF	APMX inch	OAL inch	DHUB inch	DCONMS inch	RPMX 1/min.	torque moment Nm	Insert	58 787 ...	58 787 ...
											15004	15004
A271.150.R.04-12-A050-175-EF	1.500	2.013	4	0.267	1.750	1.421	0.500	18500	3,2	SOHU 1204.. / XOHU 1204..		15004
A271.200.R.05-12-A075-175-EF	2.000	2.512	5	0.267	1.750	1.750	0.750	15100	3,2	SOHU 1204.. / XOHU 1204..		20005
A271.250.R.07-12-A100-200-EF	2.500	3.011	7	0.267	2.000	2.250	1.000	13000	3,2	SOHU 1204.. / XOHU 1204..		25007
A271.300.R.06-12-A100-200-EF	3.000	3.511	6	0.267	2.000	2.250	1.000	11600	3,2	SOHU 1204.. / XOHU 1204..	30006	30008
A271.300.R.08-12-A100-200-EF	3.000	3.511	8	0.267	2.000	2.250	1.000	9800	3,2	SOHU 1204.. / XOHU 1204..		30008
A271.400.R.07-12-A125-200-EF	4.000	4.510	7	0.267	2.000	2.750	1.250	9800	3,2	SOHU 1204.. / XOHU 1204..	40007	40010
A271.400.R.10-12-A125-200-EF	4.000	4.510	10	0.267	2.000	2.750	1.250	9800	3,2	SOHU 1204.. / XOHU 1204..		40010
A271.500.R.08-12-B150-200-EF	5.000	5.509	8	0.267	2.000	3.750	1.500	8700	3,2	SOHU 1204.. / XOHU 1204..	50008	50012
A271.500.R.12-12-B150-200-EF	5.000	5.509	12	0.267	2.000	3.750	1.500	8700	3,2	SOHU 1204.. / XOHU 1204..		50012
A271.600.R.09-12-B150-200-EF	6.000	6.509	9	0.267	2.000	3.750	1.500	7800	3,2	SOHU 1204.. / XOHU 1204..	60009	60014
A271.600.R.14-12-B150-200-EF	6.000	6.509	14	0.267	2.000	3.750	1.500	7800	3,2	SOHU 1204.. / XOHU 1204..		60014
A271.800.R.11-12-C250-250-EF	8.000	8.509	11	0.267	2.500	5.200	2.500	6700	3,2	SOHU 1204.. / XOHU 1204..	80011	80017
A271.800.R.11-12-C250-250-EF	8.000	8.509	17	0.267	2.500	5.200	2.500	6700	3,2	SOHU 1204.. / XOHU 1204..		80017
A271.1000.R.13-12-C250-250-EF	10.000	10.509	13	0.267	2.500	5.200	2.500	6000	3,2	SOHU 1204.. / XOHU 1204..	10013	10021
A271.1000.R.21-12-C250-250-EF	10.000	10.509	21	0.267	2.500	5.200	2.500	6000	3,2	SOHU 1204.. / XOHU 1204..		10021

MaxiMill – A 271-12 HFC Face mill

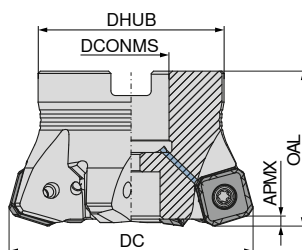
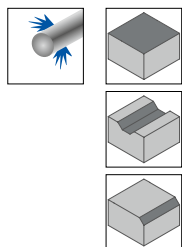

NEW

Designation	DC inch	DCX inch	ZNF	APMX inch	OAL inch	DHUB inch	DCONMS inch	RPMX 1/min.	torque moment Nm	Insert	58 787 ...
											20004
A271.200.R.04-12-A075-175-HFC-EF	2.000	2.513	4	0.102	1.750	1.750	0.750	15100	3,2	SOHU 1204..	20004
A271.250.R.06-12-A100-200-HFC-EF	2.500	3.013	6	0.102	2.000	2.250	1.000	13000	3,2	SOHU 1204..	25006
A271.300.R.07-12-A100-200-HFC-EF	3.000	3.513	7	0.102	2.000	2.250	1.000	11600	3,2	SOHU 1204..	30007

Spare parts
DC
1.500 - 10.000

Screwdriver	Molykote	Clamping screw
80 950 ...	70 950 ...	70 950 ...
128	303	859

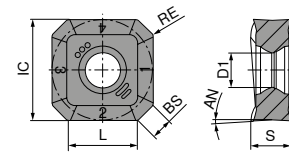

SOHU

Designation	IC inch	D1 inch	L inch	BS inch	S inch	AN °
SOHU 1204..	0.526	0.173	0.346	0.067	0.197	7.4





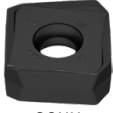
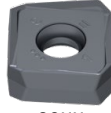

SOHU

SOHU

	NEW	NEW	NEW	NEW	NEW	NEW
	-M50 CTCP230	-M50 CTPP235	-M50 CTCM235	-M50 CTPM240	-F50 CTPM245	-F50 CTCM245
	DRAGONSKIN	DRAGONSKIN	DRAGONSKIN	DRAGONSKIN	DRAGONSKIN	DRAGONSKIN
						
	SOHU	SOHU	SOHU	SOHU	SOHU	SOHU
	51 138 ...	51 138 ...	51 138 ...	51 138 ...	51 140 ...	51 140 ...

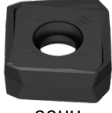
ISO	RE inch						
1204ABSR	0.031						
		02000	12000	32000	42000	47000	92001
P		●	●	●	○	●	●
M			○	●	●	●	●
K		○	○				
N							
S							○
H							
O							

SOHU

	NEW	NEW	NEW	NEW
	-R50 CTCK215	-R50 CTPK220	-F40 CTC5240	-F50 CTC5240
	DRAGONSKIN	DRAGONSKIN	DRAGONSKIN	DRAGONSKIN
				
	SOHU	SOHU	SOHU	SOHU
	51 139 ...	51 139 ...	51 148 ...	51 140 ...

ISO	RE inch				
1204ABSR	0.031				
		52000	62000	12001	17000
P					
M					
K			●	●	
N					
S				●	●
H					
O					

XOHU

Designation	IC inch	D1 inch	L inch	BS inch	S inch
XOHU 1204..	0.526	0.173	0.346	0.072	0.197

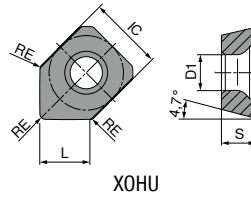

XOHU

NEW

-M50
CTPP235

DRAGONSKIN

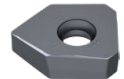

XOHU

51 141 ...

ISO	RE inch	
1204ABSR	0.031	12000
P		●
M		○
K		○
N		
S		
H		
O		

Milling guide

Cutting data standard values	→ 97-100	Starting Parameter	→ 105
Technical Information	→ 132-136	Chip groove description and overview	→ 137-139
Grade description and overview	→ 140-142		

MaxiMill – A 271-17 Face mill

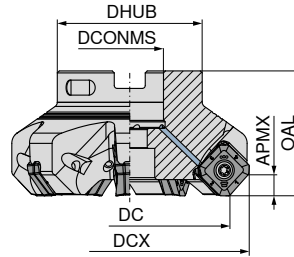
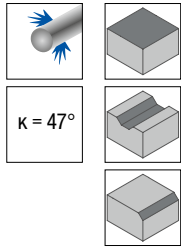

▲ 8 cutting edges per insert



58 767 ...

Designation	DC inch	DCX inch	ZNF	APMX inch	OAL inch	DCONMS inch	DHUB inch	torque moment Nm	Insert	
A271.200.R.04-17-A075-175-EF	2.000	2.660	4	0.330	1.750	0.750	1.750	5	SAKU 1706	20004
A271.250.R.06-17-A100-200-EF	2.500	3.160	6	0.330	2.250	1.000	2.250	5	SAKU 1706	25006
A271.300.R.07-17-A100-200-EF	3.000	3.660	7	0.330	2.250	1.000	2.250	5	SAKU 1706	30007
A271.400.R.08-17-B125-200-EF	4.000	4.660	8	0.330	2.750	1.250	2.750	5	SAKU 1706	40008
A271.500.R.10-17-B150-200-EF	5.000	5.660	10	0.330	3.750	1.500	3.750	5	SAKU 1706	50010
A271.600.R.11-17-B200-250-EF	5.000	6.660	11	0.334	2.500	2.000	3.750	5	SAKU 1706	60011
A271.650.R.12-17-C250-250-EF	6.500	7.160	12	0.330	5.120	2.500	5.120	5	SAKU 1706	65012

Spare parts
DC
2.000 - 6.500

 Screwdriver	 Molykote	 Clamping screw
80 950 ...	70 950 ...	70 950 ...
106	303	302

SAKU

Designation	IC inch	D1 inch	L inch	BS inch	S inch	AN °
SAKU 1706..	0.669	0.228	0.467	0.146	0.250	3

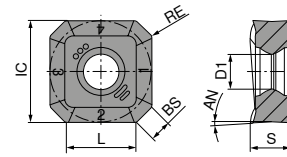

SAKU

SAKU

ISO	RE inch	-F50 CTCP220	-M50 CTCP220	-F50 CTPP225	-M50 CTPP225
1706ABSR	0.031				
		270	270	070	070



ISO	RE inch
1706ABSR	0.031

P	•	•	•	•
M				
K				
N				
S				
H				
O				

SAKU

ISO	RE inch	-F50 CTCP230	-M50 CTCP230	-F50 CTPP235	-M50 CTPP235
1706ABSR	0.031				
		020	020	120	120



ISO	RE inch
1706ABSR	0.031

P	•	•	•	•
M			○	○
K	○	○	○	○
N				
S				
H				
O				

SAKU

ISO		RE								
1706ABSR		inch								
		0.031		220	220	320	320	420	420	470
P			•	•	•	•	•	○	○	•
M			•	•	•	•	•	•	•	•
K										
N										
S										
H										
O										

SAKU

ISO		RE								
1706ABSR		inch								
		0.031		92001	520	520	620	620	520	570
Steel			•	○	○	○	○	○		
Stainless steel			•							
Cast iron				•	•	•	•	•		
Non ferrous metals										
Heat resistant alloys			•						•	•
Hardened materials										

Milling guide

Cutting data standard values	→ 97-100	Starting Parameter	→ 105
Technical Information	→ 132-136	Chip groove description and overview	→ 137-139
Grade description and overview	→ 140-142		

MaxiMill – End milling cutter C 273

▲ 16 cutting edges per insert

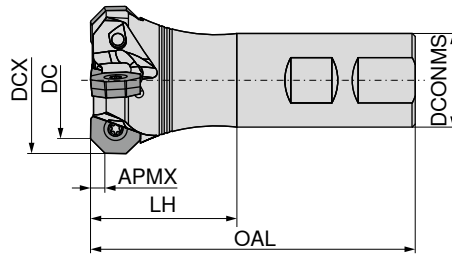
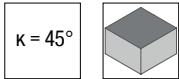

58 762 ...

Designation	DC inch	DCX inch	ZNF	APMX inch	DCONMS _{H6} inch	LH inch	OAL inch	torque moment Nm	Insert	
C273.150.R.04-06-B125-125-EF	1.500	1.911	4	0.138	1.250	1.250	3.600	5	OAKU / XAHT 0605	15004
C273.200.R.05-06-B150-125-EF	2.000	2.421	5	0.138	1.500	1.250	4.500	5	OAKU / XAHT 0605	20005

MaxiMill – Shell mill A 273



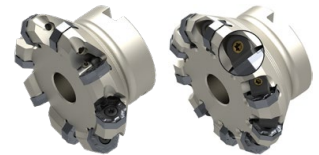
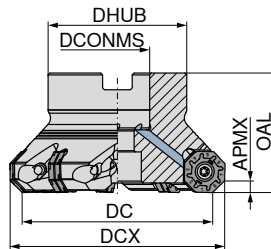
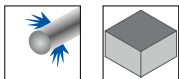

▲ 16 cutting edges per insert



58 741 ...

58 741 ...

Designation	DC inch	ZNF	APMX inch	OAL inch	DCONMS _{H6} inch	DHUB inch	torque moment Nm	Insert		
A273.200.R.05-06-A075-175-EF	2.000	5	0.138	1.750	0.750	1.750	5	OAKU / XAHT 0605	20005	
A273.250.R.07-06-A100-200-EF	2.500	7	0.138	2.250	1.000	2.250	5	OAKU / XAHT 0605	25007	
A273.300.R.08-06-A100-200-EF	3.000	8	0.138	2.250	1.000	2.250	5	OAKU / XAHT 0605	30008	
A273.400.R.10-06-B125-200-EF-IC	4.000	10	0.138	2.750	1.250	2.750	5	OAKU / XAHT 0605	40010	
A273.500.R.12-06-B150-200-EF	5.000	12	0.138	3.750	1.500	3.750	5	OAKU / XAHT 0605	50012	
A273.600.R.13-06-B150-250-EF	6.000	13	0.138	3.750	1.500	3.750	5	OAKU / XAHT 0605	60013	
A273.800.R.25-06-C250-250-EF	8.000	25	0.138	6.500	2.500	6.500	5	OAKU / XAHT 0605		80025
A273.1000.R.31-06-C250-250-EF	10.000	31	0.138	6.500	2.500	6.500	5	OAKU / XAHT 0605		10031

 Clamping wedge screw	 Clamping wedge Face mill	 Screwdriver	 Molykote	 Clamping screw
70 950 ...	70 950 ...	80 950 ...	70 950 ...	70 950 ...
		106 105	303 303	302

Spare parts

DC
1.500 - 6.000
8.000 - 10.000

OAKU / XAHT

Designation	IC inch	D1 inch	L inch	BS inch	S inch	AN °
OAKU 0605..	0.673	0.228	0.236	0.079	0.223	3
XAHT 0605..	0.672	0.236	-	0.470	0.219	3

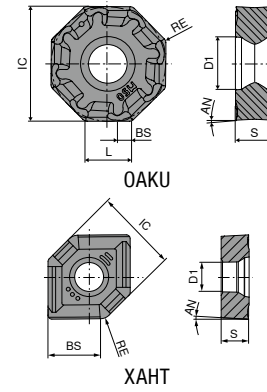

OAKU

-F50 CTCP220	-M50 CTCP220	-F50 CTPP225	-M50 CTPP225
DRAGONSKIN	DRAGONSKIN	DRAGONSKIN	DRAGONSKIN
OAKU	OAKU	OAKU	OAKU
51 000 ...	51 001 ...	51 000 ...	51 001 ...
258	258	058	058

ISO	RE inch
060508SR	0.031

P	•	•	•	•
M				
K				
N				
S				
H				
O				

OAKU

-F50 CTCP230	-M50 CTCP230	-F50 CTPP235	-M50 CTPP235
DRAGONSKIN	DRAGONSKIN	DRAGONSKIN	DRAGONSKIN
OAKU	OAKU	OAKU	OAKU
51 000 ...	51 001 ...	51 000 ...	51 001 ...
008	008	108	10900 108

ISO	RE inch
060508SL	0.031
060508SR	0.031

P	•	•	•	•
M			○	○
K	○	○	○	○
N				
S				
H				
O				

OAKU

		-F50 CTPM225	-M50 CTPM225	-F50 CTCM235	-M50 CTCM235	-F50 CTPM240	-M50 CTPM240	-F40 CTPM245
		DRAGONSKIN						
		OAKU						
		51 000 ...	51 001 ...	51 000 ...	51 001 ...	51 000 ...	51 001 ...	51 104 ...
ISO	RE inch							
060508ER	0.031							458
060508SR	0.031	208	208	308	308	408	408	
P		•	•	•	•	○	○	•
M		•	•	•	•	•	•	•
K								
N								
S								
H								
O								

OAKU

		NEW -F40 CTCM245	-M50 CTCK215	-R50 CTCK215	-M50 CTPK220	-R50 CTPK220	-F40 CTC5240	-F40 CTCS245
		DRAGONSKIN						
		OAKU						
		51 104 ...	51 001 ...	51 027 ...	51 001 ...	51 027 ...	50 446 ...	51 104 ...
ISO	RE inch							
060508ER	0.031	90801					550	50801
060508SL	0.031		50900			60900		
060508SR	0.031		508	508	608	608		
P		•						
M		•						
K			•	•	•	•		
N								
S		○					•	•
H								
O								

XAHT

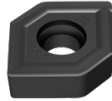
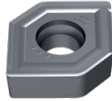
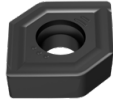
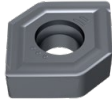
		-M50 CTCP220	-M50 CTPP225	-M50 CTCP230	-M50 CTPP235
		DRAGONSKIN	DRAGONSKIN	DRAGONSKIN	DRAGONSKIN
					
		XAHT	XAHT	XAHT	XAHT
		51 014 ...	51 014 ...	51 014 ...	51 014 ...
		275	075	025	125
ISO	RE				
	inch				
060525SR	0.098				
P		•	•	•	•
M					○
K				○	○
N					
S					
H					
O					

XAHT

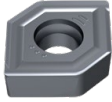
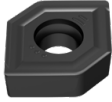
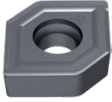
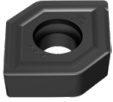
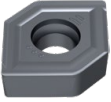
		-M50 CTPM225	-M50 CTCM235	-M50 CTPM240	-M50 CTCK215	-M50 CTPK220
		DRAGONSKIN	DRAGONSKIN	DRAGONSKIN	DRAGONSKIN	DRAGONSKIN
						
		XAHT	XAHT	XAHT	XAHT	XAHT
		51 014 ...	51 014 ...	51 014 ...	51 014 ...	51 014 ...
		225	325	425	52600 525	625
ISO	RE					
	inch					
060525SL	0.098					
060525SR	0.098					
P		•	•	○		
M		•	•	•		
K					•	•
N						
S						
H						
O						

Milling guide

Cutting data standard values	→ 97-100	Starting Parameter	→ 106
Technical Information	→ 132-136	Chip groove description and overview	→ 137-139
Grade description and overview	→ 140-142		

MaxiMill – End milling cutter 45° C 270-09

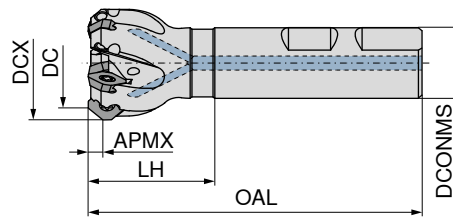
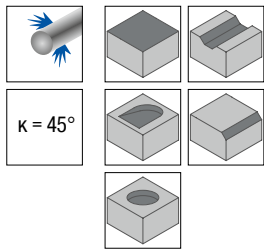

B

58 666 ...

Designation	DC inch	DCX inch	ZNF	APMX inch	OAL inch	LH inch	DCONMS inch	torque moment Nm	Insert	
C270.0500.R.01-09-B0625-125-EF	0.500	0.830	1	0.157	3.250	1.250	0.625	1,2	SD.. 0903..	05001
C270.0500.R.01-09-B075-125-EF	0.500	0.830	1	0.157	3.250	1.250	0.750	1,2	SD.. 0903..	05101
C270.0750.R.03-09-B075-150-EF	0.750	1.080	3	0.157	3.500	1.500	0.750	1,8	SD.. 0903..	07503
C270.0750.R.03-09-B100-150-EF	0.750	1.080	3	0.157	3.500	1.500	1.000	1,8	SD.. 0903..	07603
C270.100.R.04-09-B075-150-EF	1.000	1.330	4	0.157	3.500	1.500	0.750	1,8	SD.. 0903..	10004
C270.100.R.04-09-B100-150-EF	1.000	1.330	4	0.157	3.500	1.500	1.000	1,8	SD.. 0903..	10104
C270.125.R.05-09-B075-175-EF	1.250	1.580	5	0.157	3.750	1.750	0.750	1,8	SD.. 0903..	12505
C270.125.R.05-09-B100-175-EF	1.250	1.580	5	0.157	3.750	1.750	1.000	1,8	SD.. 0903..	12605
C270.150.R.05-09-B075-200-EF	1.500	1.830	5	0.157	4.000	2.000	0.750	1,8	SD.. 0903..	15005
C270.150.R.05-09-B100-200-EF	1.500	1.830	5	0.157	4.000	2.000	1.000	1,8	SD.. 0903..	15105

MaxiMill – Shell mill 45° A 270-09

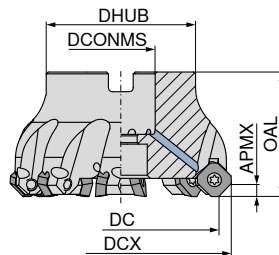
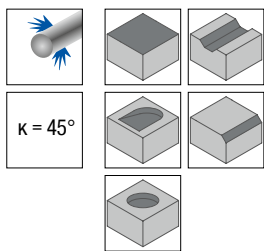

right

58 705 ...

Designation	DC inch	DCX inch	ZNF	APMX inch	OAL inch	DHUB inch	DCONMS _{H6} inch	torque moment Nm	Insert	
A270.200.R.06-09-A075-175-EF	2.000	2.330	6	0.157	1.750	1.750	0.750	1,8	SD.. 0903..	20006
A270.250.R.08-09-A100-200-EF	2.500	2.830	8	0.157	2.250	2.250	1.000	1,8	SD.. 0903..	25008
A270.300.R.10-09-A100-200-EF	3.000	3.330	10	0.157	2.250	2.250	1.000	1,8	SD.. 0903..	30010

MaxiMill – Chamfer milling cutter C 272-09

▲ Usable on front and rear cutting edges

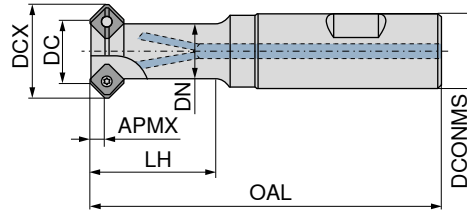
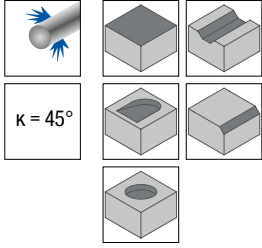

58 669 ...

Designation	DC inch	DCX inch	ZNF	APMX inch	OAL inch	LH inch	DCONMS inch	torque moment Nm	Insert
C272.0500.R.01-09-B-100-EF	0.500	0.830	1	0.157	3.250	1.000	0.625	1,2	SD.. 0903..

05001

Screwdriver	Molykote	Clamping screw
80 950 ...	70 950 ...	70 950 ...
102	303	365

Spare parts
DC
0.500

SDHW / SDNT / SDHT / XDHW

Designation	IC inch	D1 inch	L inch	BS inch	S inch
SD.. 0903..	0.375	0.134	0.375	0.066	0.125
XDHW 0903..	0.375	0.134	0.217	0.066	0.125

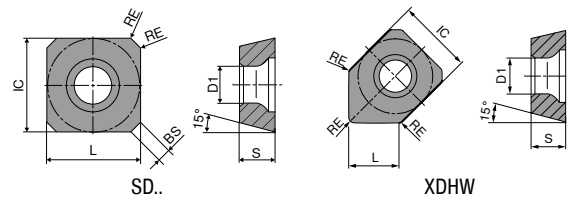

SDHW / SDNT / SDHT

ISO	RE inch	TCM10	-29 CTCP230	-29 CTPP235	-33 CTPM240	-33P CTPM240	-F50 CTPM245	-F50 CTCM245
			DRAGONSKIN	DRAGONSKIN	DRAGONSKIN	DRAGONSKIN	DRAGONSKIN	DRAGONSKIN
		CERMET SDHW	SDNT	SDNT	SDHT	SDHT	SDHT	SDHT
		50 428 ...	51 011 ...	51 011 ...	51 028 ...	51 086 ...	51 109 ...	51 109 ...
0903AESN	0.039	898	020	120	420	420	470	92001
P		●	●	●	○	○	●	●
M				○	●	●	●	●
K		○	○	○				
N								
S								○
H								
O								

SDNT / SDHT

ISO	RE inch	-31 CTCK215	-27P H216T	-27P AMZ	-M31 CTC5240	-F50 CTCS245
		DRAGONSKIN			DRAGONSKIN	DRAGONSKIN
		SDNT	SDHT	SDHT	SDHT	SDHT
		51 029 ...	50 426 ...	50 426 ...	50 421 ...	51 109 ...
0903AEFN	0.039		548	848		
0903AESN	0.039	520			509	57100
P						
M						
K			●	○	○	
N			●	●		
S					●	●
H						
O				○	○	

XDHW

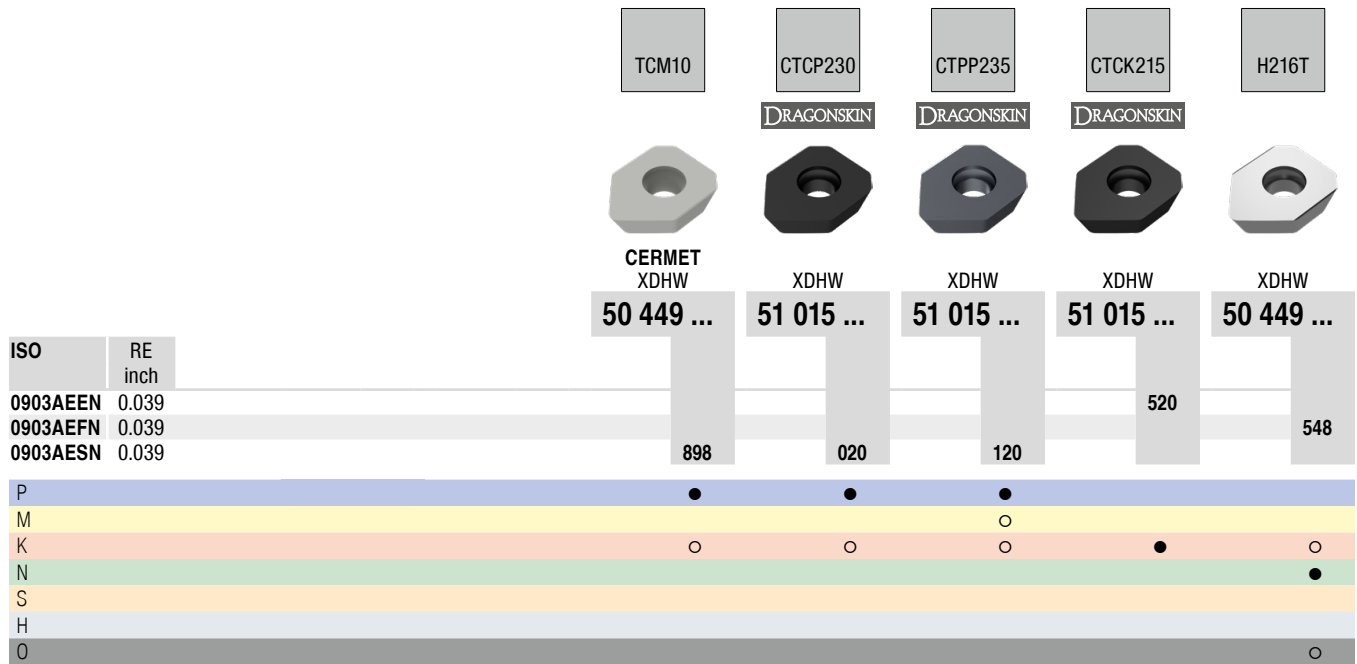

Milling guide

Cutting data standard values	→ 97-100	Machining strategy	→ 107
Technical Information	→ 132-136	Chip groove description and overview	→ 137-139
Grade description and overview	→ 140-142		

MaxiMill – Shell mill 45° A 270-12

- ▲ 50 705 ... Normal pitch for a broad spectrum of use on aluminum alloys, non-ferrous metals, up to soft steel materials
- ▲ 50 706 ... Predominantly fine pitch for highest feed rates, use on steel and cast materials

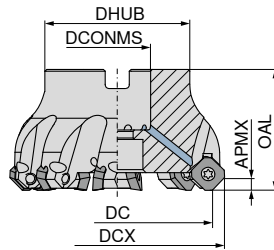
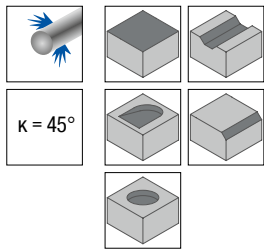

58 705 ...

Designation	DC inch	DCX inch	ZNF	APMX inch	DCONMS _{H6} inch	OAL inch	DHUB inch	torque moment Nm	Insert	
A270.200.R.04-12-A075-175-EF	2.000	2.550	4	0.236	0.750	1.750	1.750	5	SD.. 1204..	20104
A270.250.R.05-12-A100-200-EF	2.500	3.050	5	0.236	1.000	2.250	2.250	5	SD.. 1204..	25105
A270.300.R.06-12-A100-200-EF	3.000	3.550	6	0.236	1.000	2.250	2.250	5	SD.. 1204..	30106
A270.400.R.06-12-B125-200-EF	4.000	4.550	6	0.236	1.250	2.750	2.750	5	SD.. 1204..	40106
A270.500.R.07-12-B150-200-EF	5.000	5.550	7	0.236	1.500	3.750	3.750	5	SD.. 1204..	50107
A270.600.R.08-12-B150-200-EF	6.000	6.660	8	0.236	1.500	3.750	3.750	5	SD.. 1204..	60108

Spare parts
DC
2.000 - 6.000

Screwdriver	Molykote	Clamping screw
80 950 ...	70 950 ...	70 950 ...
106	303	01200

SDHT / SDHW / SDMT / XDHW

Designation	IC inch	D1 inch	L inch	BS inch	S inch
SD.. 1204..	0.500	0.217	0.500	0.069	0.187
XDHW 1204..	0.500	0.217	0.295	0.069	0.187

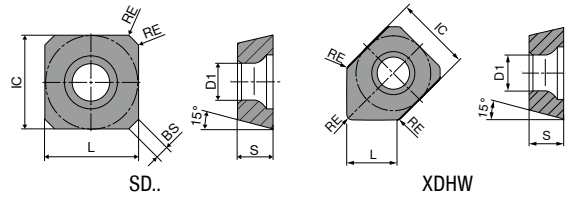

SDHT / SDHW / SDMT

ISO	RE inch	TCM10	-R TCM10	-29R CTCP230	-R CTCP230	CTCP230
				DRAGONSKIN	DRAGONSKIN	DRAGONSKIN
		CERMET SDHT	CERMET SDHW	SDMT	SDHT	SDHW
		50 426 ...	50 428 ...	51 010 ...	51 006 ...	51 008 ...
1204AESN	0.008	900	899	020	020	020
1204AESN	0.039					
P		●	●	●	●	●
M						
K		○	○	○	○	○
N						
S						
H						
O						

SDMT / SDHT / SDHW

ISO	RE inch	-29R CTPP235	-R CTPP235	-R CTPP235	-33 CTPM240	-F50 CTPM245	NEW -F50 CTCM245
		DRAGONSKIN	DRAGONSKIN	DRAGONSKIN	DRAGONSKIN	DRAGONSKIN	DRAGONSKIN
		SDMT	SDHT	SDHW	SDHT	SDHT	SDHT
		51 010 ...	51 006 ...	51 008 ...	51 028 ...	51 109 ...	51 109 ...
1204AESN	0.039	120	120	120	425	475	92501
P		●	●	●	○	●	●
M		○	○	○	●	●	●
K		○	○	○			
N							
S							○
H							
O							

SDMT / SDHW / SDHT

ISO	RE inch					
1204AEEN	0.039					
1204AEFN	0.008		520	520		
1204AEFN	0.039				504	
1204AESN	0.008					554
						600

P
M
K
N
S
H
O

SDHT

ISO	RE inch		
1204AESN	0.039		

P
M
K
N
S
H
O

XDHW

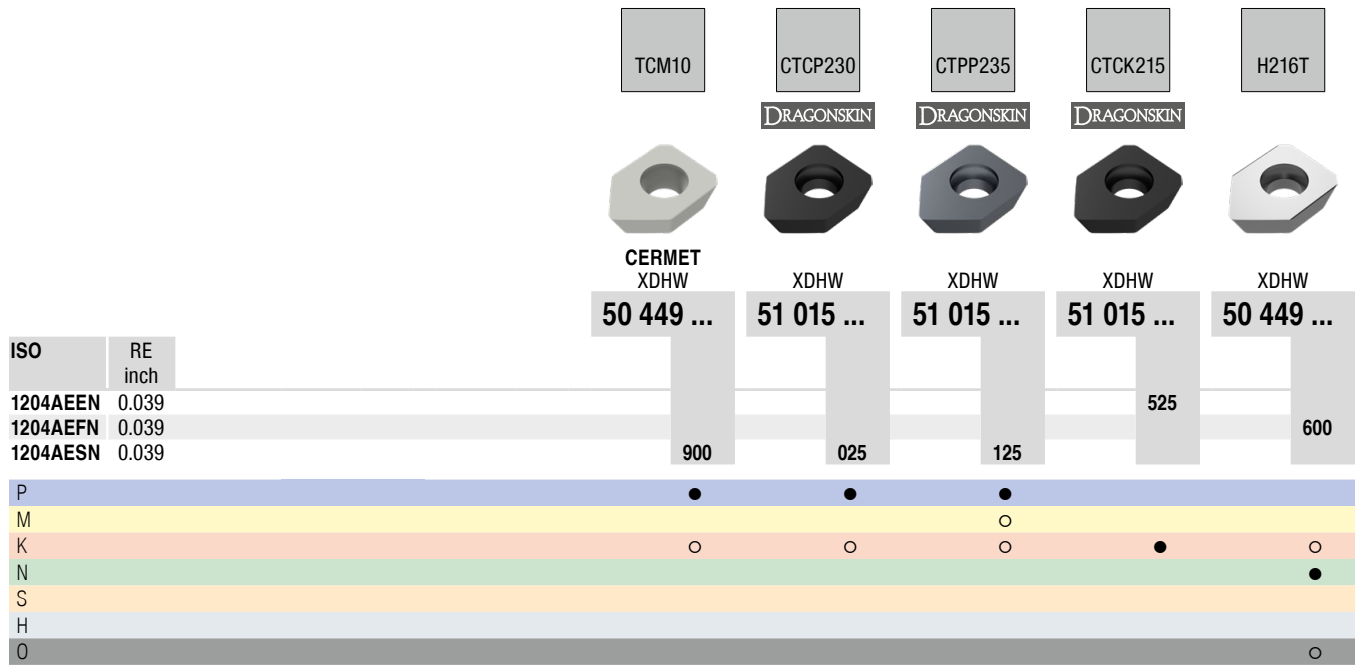

SDHW

Designation	IC inch	D1 inch	L inch	S inch
SDHW 1204..	0.500	0.217	0.500	0.187

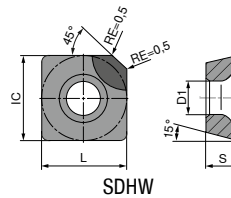

SDHW

ISO
1204AEFN-2
1204AEFN-3
1204AETN-2

ISO	DIAMOND SDHW 51 900 ...	CBN SDHW 51 900 ...
P		
M		
K		
N	●	●
S	●	
H		○
O		

- 1) $a_{p,max.} = 2.0 \text{ mm}$
- 2) $a_{p,max.} = 3,5 \text{ mm}$

Milling guide

Cutting data standard values	→ 97-100	Machining strategy	→ 107
Technical Information	→ 132-136	Chip groove description and overview	→ 137-139
Grade description and overview	→ 140-142		

MaxiMill – Shell mill HEC 11

▲ not adjustable

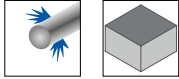

$\kappa = 88^\circ$

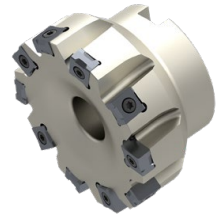
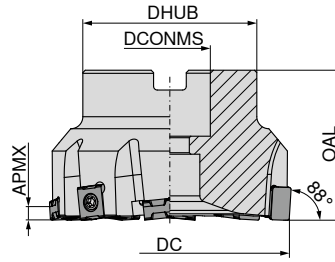

58 725 ...

Designation	DC inch	ZNF	APMX inch	OAL inch	DHUB inch	DCONMS _{H6} inch	RPMX 1/min.	torque moment Nm	
AHEC.200.R.06-11-A075-175-EF	2.000	6	0.157	1.750	1.750	0.750	12700	3,2	20006
AHEC.250.R.08-11-A100-175-EF	2.500	8	0.157	2.250	2.250	1.000	10100	3,2	25008
AHEC.300.R.10-11-A100-200-EF	3.000	10	0.157	2.250	2.250	1.000	8000	3,2	30010
AHEC.400.R.12-11-B150-200-EF	4.000	12	0.157	3.750	3.750	1.500	6400	3,2	40012
AHEC.500.R.16-11-B150-225-EF	5.000	16	0.157	3.750	3.750	1.500	5100	3,2	50016
AHEC.600.R.14-11-B150-250-EF	6.000	14	0.157	3.750	3.750	1.500	4000	3,2	60014
AHEC.600.R.20-11-A200-250-EF	6.000	20	0.157	2.500	4.882	2.000	4000	3,2	60020
AHEC.800.R.20-11-A250-250-EF	8.000	20	0.157	6.890	6.890	2.500	2600	3,2	80020

Spare parts
DC
2.000 - 8.000

 TORX® blade	 Molykote	 Clamping screw	 Wedge	 Torque screwdriver
80 950 ...	70 950 ...	70 950 ...	70 950 ...	80 950 ...
036	303	113	199	193

LNHX

Designation	IC inch	D1 inch	L inch	S inch
LNHX 1106..	0.394	0.168	0.433	0.250

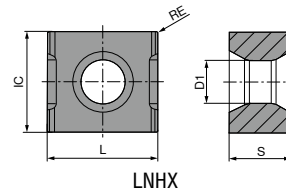

LNHX

ISO	RE inch	CTEP210 DRAGONSKIN CERMET LNHX 51 046 ... 820	CTCK215 DRAGONSKIN LNHX 51 046 ... 51600	-R50 CTCK215 DRAGONSKIN LNHX 51 024 ... 520	-Q CTCK215 DRAGONSKIN LNHX 51 045 ... 520 ¹⁾
1106PNER	0.020				
1106ZZER	0.020				
1106PNER	0.031				
110616EN	0.063				
P		•			
M					
K		•	•	•	•
N					
S					
H					
O					

1) -Q = Wiper insert

LNHX

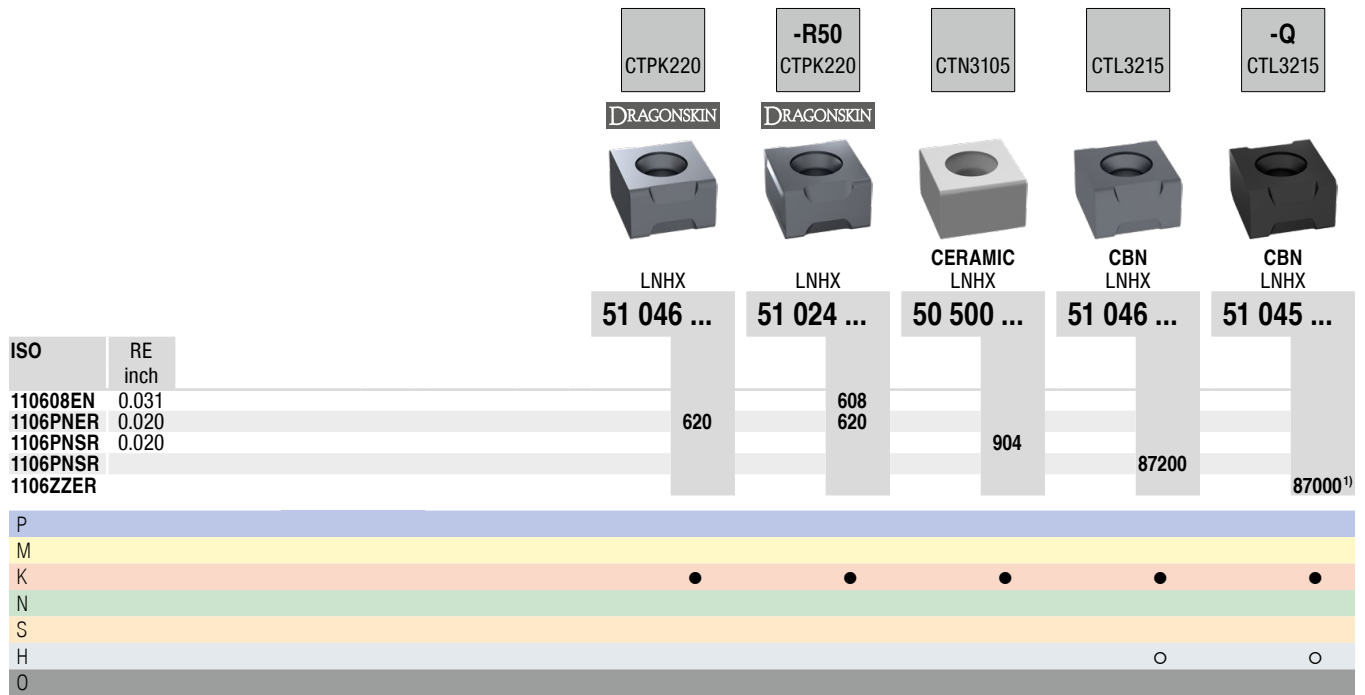

1) -Q = Wiper insert

Milling guide

Cutting data standard values	→ 97-100	Assembly instructions	→ 108
Technical Information	→ 132-136	Chip groove description and overview	→ 137-139
Grade description and overview	→ 140-142		

MaxiMill – End milling cutter C 491-09

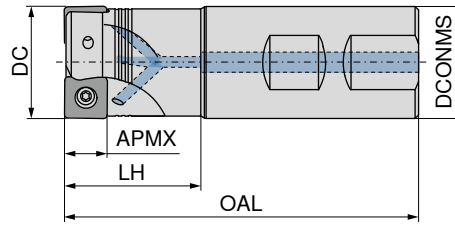
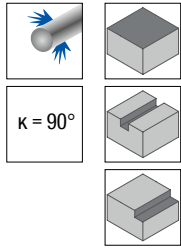

Designation	DC inch	ZNF	APMX inch	OAL inch	LH inch	DCONMS _{h6} inch	RPMX 1/min.	torque moment Nm	Insert
C491.100.R.03-09-B-125-EF	1.000	3	0.236	3.600	1.250	1.000	17125	2	SNHU 09T3
C491.100.R.03-09-A-200-EF-800	1.000	3	0.236	8.000	2.000	1.000	17125	2	SNHU 09T3
C491.125.R.03-09-B-150-EF	1.250	3	0.236	4.000	1.500	1.250	13700	2	SNHU 09T3
C491.125.R.04-09-B-150-EF	1.250	4	0.236	4.000	1.500	1.250	13700	2	SNHU 09T3
C491.125.R.03-09-A-250-EF-1000	1.250	3	0.236	10.000	2.500	1.250	13700	2	SNHU 09T3
C491.125.R.04-09-A-250-EF-1000	1.250	4	0.236	10.000	2.500	1.250	13700	2	SNHU 09T3

A	B
58 774 ...	58 774 ...
10003	30003
12503	32503
12504	32504

**Spare parts
for Article no.**

58 774 30003	127	303	710
58 774 10003	127	303	710
58 774 32503	127	303	710
58 774 32504	127	303	710
58 774 12503	127	303	710
58 774 12504	127	303	710

Screwdriver	Molykote	Clamping screw
80 950 ...	70 950 ...	70 950 ...

MaxiMill – Shell mill A 491-09

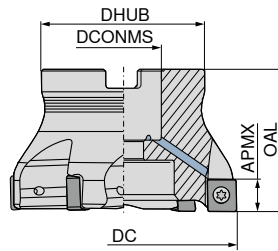
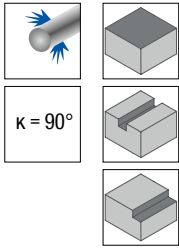

Designation	DC inch	ZNF	APMX inch	OAL inch	DHUB inch	DCONMS _{H6} inch	RPMX 1/min.	torque moment Nm	Insert	58 776 ...		58 775 ...	
										15003			15005
A491.150.R.03-09-A050-175-EF	1.500	3	0.236	1.750	1.421	0.500	11900	2	SNHU 09T3	15003			
A491.150.R.05-09-A050-175-EF	1.500	5	0.236	1.750	1.421	0.500	11900	2	SNHU 09T3				15005
A491.200.R.04-09-A075-175-EF	2.000	4	0.236	1.750	1.750	0.750	9700	2	SNHU 09T3	20004			
A491.200.R.06-09-A075-175-EF	2.000	6	0.236	1.750	1.750	0.750	9700	2	SNHU 09T3				20006
A491.250.R.05-09-A100-200-EF	2.500	5	0.236	2.000	2.250	1.000	8500	2	SNHU 09T3	25005			
A491.250.R.08-09-A100-200-EF	2.500	8	0.236	2.000	2.250	1.000	8500	2	SNHU 09T3				25008
A491.300.R.06-09-A100-200-EF	3.000	6	0.236	2.000	2.250	1.000	7600	2	SNHU 09T3	30006			
A491.300.R.10-09-A100-200-EF	3.000	10	0.236	2.000	2.250	1.000	7600	2	SNHU 09T3				30010
A491.400.R.07-09-A125-200-EF	4.000	7	0.236	2.000	2.750	1.250	6400	2	SNHU 09T3	40007			
A491.400.R.12-09-A125-200-EF	4.000	12	0.236	2.000	2.750	1.250	6400	2	SNHU 09T3				40012
A491.500.R.08-09-B150-200-EF	5.000	8	0.236	2.000	3.750	1.500	5700	2	SNHU 09T3	50008			
A491.500.R.15-09-B150-200-EF	5.000	15	0.236	2.000	3.750	1.500	5700	2	SNHU 09T3				50015

Spare parts
DC
1.500 - 5.000

Screwdriver	Molykote	Clamping screw
80 950 ...	70 950 ...	70 950 ...
119	303	710

SNHU

Designation	IC inch	L inch	S inch	D1 inch
SNHU 09T3..	0.360	0.360	0.146	0.152

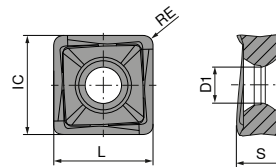

SNHU

ISO	RE inch	-M50 CTCP230	-M50 CTPP235	-F50 CTPM240	-M50 CTPM240	-F40 CTPM245	NEW -F40 CTCM245
09T308ER	0.031						
09T308SR	0.031						
09T312SR	0.047						
09T316SR	0.063						
		008	108	408	408	45800	90801
		01200	11200	41200	41200		
		01600	11600	41600	41600		
P		●	●	○	○	●	●
M			○	●	●	●	●
K		○	○				
N							
S							○
H							
O							

SNHU

ISO	RE inch	-R50 CTCK215	NEW -R50 CTPK220	-F10 CTWN215	-F40 CTC5240	-F40 CTCS245
09T308ER	0.031					
09T308FR	0.031					
09T308SR	0.031					
09T312FR	0.047					
09T312SR	0.047					
09T316FR	0.063					
09T316SR	0.063					
		508	60800	358	15800	55800
		51200		36200		
		51600		36600		
P						
M						
K		●	●	○		
N				●		
S					●	●
H						
O				○		

Milling guide

Cutting data standard values	→ 97-100	Starting Parameter	→ 110
Technical Information	→ 132-136	Chip groove description and overview	→ 137-139
Grade description and overview	→ 140-142		

MaxiMill – End milling cutter C 491-12

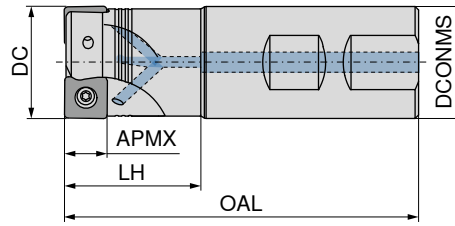
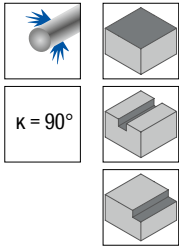

Designation	DC inch	ZNF	APMX inch	OAL inch	LH inch	DCONMS _{h6} inch	RPMX 1/min.	torque moment Nm	Insert
C491.125.R.02-12-B-150-EF	1.250	2	0.315	4.000	1.500	1.250	13700	3,2	SNHU 1204
C491.125.R.02-12-A-250-EF-1000	1.250	2	0.315	10.000	2.500	1.250	13700	3,2	SNHU 1204

Designation	DC inch	ZNF	APMX inch	OAL inch	LH inch	DCONMS _{h6} inch	RPMX 1/min.	torque moment Nm	Insert
C491.125.R.02-12-B-150-EF	1.250	2	0.315	4.000	1.500	1.250	13700	3,2	SNHU 1204
C491.125.R.02-12-A-250-EF-1000	1.250	2	0.315	10.000	2.500	1.250	13700	3,2	SNHU 1204

Spare parts for Article no.	A	B
58 774 52502	58 774 ...	58 774 ...
58 774 42502	42502	52502

Spare parts for Article no.	Screwdriver	Molykote	Clamping screw
80 950 ...	80 950 ...	70 950 ...	70 950 ...
58 774 52502	128	303	859
58 774 42502	128	303	859

Spare parts
for Article no.
58 774 52502
58 774 42502

MaxiMill – Shell mill A 491-12

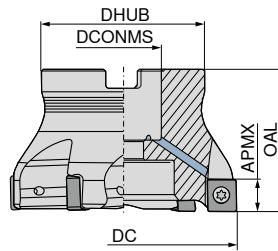
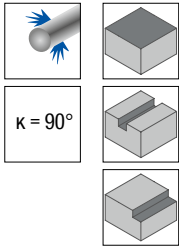

Designation	DC inch	ZNF	APMX inch	OAL inch	DHUB inch	DCONMS _{H6} inch	RPMX 1/min.	torque moment Nm	Insert
A491.150.R.03-12-A050-175-EF	1.500	3	0.315	1.420	1.420	0.500	11900	3,2	SNHU 1204
A491.200.R.04-12-A075-175-EF	2.000	4	0.315	1.750	1.750	0.750	9700	3,2	SNHU 1204
A491.200.R.05-12-A075-175-EF	2.000	5	0.315	1.750	1.750	0.750	9700	3,2	SNHU 1204
A491.250.R.05-12-A100-200-EF	2.500	5	0.315	2.250	2.250	1.000	8500	3,2	SNHU 1204
A491.250.R.06-12-A100-200-EF	2.500	6	0.315	2.250	2.250	1.000	8500	3,2	SNHU 1204
A491.300.R.06-12-A100-200-EF	3.000	6	0.315	2.250	2.250	1.000	7600	3,2	SNHU 1204
A491.300.R.08-12-A100-200-EF	3.000	8	0.315	2.250	2.250	1.000	7600	3,2	SNHU 1204
A491.400.R.07-12-A125-200-EF	4.000	7	0.315	2.750	2.750	1.250	6400	3,2	SNHU 1204
A491.400.R.10-12-A125-200-EF	4.000	10	0.315	2.750	2.750	1.250	6400	3,2	SNHU 1204
A491.500.R.08-12-B150-200-EF	5.000	8	0.315	3.750	3.750	1.500	5700	3,2	SNHU 1204
A491.500.R.12-12-B150-200-EF	5.000	12	0.315	3.750	3.750	1.500	5700	3,2	SNHU 1204
A491.600.R.09-12-B150-200-EF	6.000	9	0.315	3.750	3.750	1.500	5100	3,2	SNHU 1204
A491.600.R.13-12-B150-200-EF	6.000	13	0.315	3.750	3.750	1.500	5100	3,2	SNHU 1204

58 776 ...	58 775 ...
15103	
20104	
	20105
25105	
	25106
30106	
	30108
40107	
	40110
50108	
	50112
60109	
	60113

Spare parts
DC

1.500 - 6.000

Screwdriver	Molykote	Clamping screw
80 950 ...	70 950 ...	70 950 ...
128	303	859

SNHU

Designation	IC inch	L inch	S inch	D1 inch
SNHU 1204..	0.480	0.480	0.197	0.173

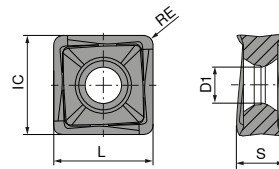

SNHU

ISO	RE inch	-M50 CTCP230	-M50 CTPP235	-F50 CTPM240	-M50 CTPM240	-F40 CTPM245	NEW -F40 CTCM245
		DRAGONSKIN	DRAGONSKIN	DRAGONSKIN	DRAGONSKIN	DRAGONSKIN	DRAGONSKIN
		SNHU	SNHU	SNHU	SNHU	SNHU	SNHU
		51 100 ...	51 100 ...	51 102 ...	51 100 ...	51 128 ...	51 128 ...
120408ER	0.031					45800	90801
120408SR	0.031	008	108	408	408		
120412SR	0.047		112	412			
120416SR	0.063		116	416			
120420SR	0.079		120	420			
P		●	●	○	○	●	●
M			○	●	●	●	●
K		○	○				
N							
S							○
H							
O							

SNHU

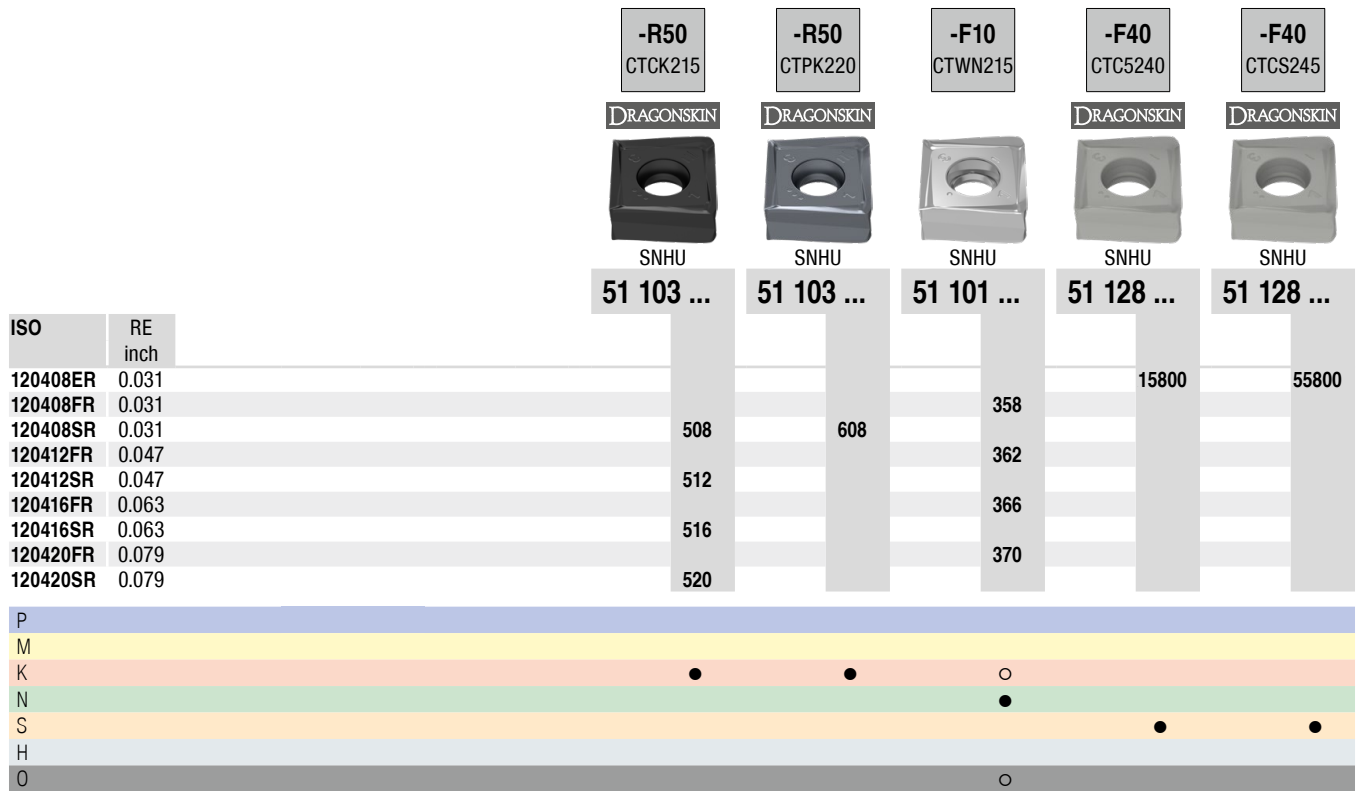

Milling guide

Cutting data standard values	→ 97-100	Starting Parameter	→ 110
Technical Information	→ 132-136	Chip groove description and overview	→ 137-139
Grade description and overview	→ 140-142		

MaxiMill – End milling cutter C 211-07

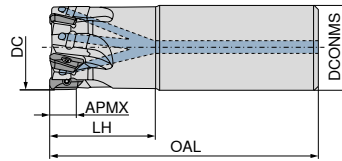
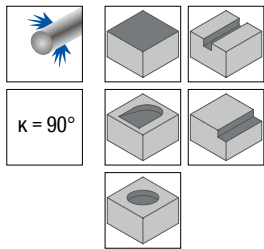

A 
58 752 ...

Designation	DC inch	ZNF	APMX inch	OAL inch	LH inch	DCONMS inch	RPMX 1/min.	torque moment Nm	Insert	
C211.0375.R.01-07-A-0750-EF	0.375	1	0.236	3.000	0.750	0.375	68000	1	XD.T 0703	03701
C211.0500.R.02-07-A-0750-EF	0.500	2	0.236	3.000	0.750	0.500	66600	1	XD.T 0703	05002
C211.0625.R.03-07-A-125-EF-650	0.625	3	0.236	6.500	1.250	0.625	17760	1	XD.T 0703	06203
C211.0750.R.04-07-A-150-EF-800	0.750	4	0.236	8.000	1.500	0.750	12600	1	XD.T 0703	07504
C211.100.R.06-07-A0875-125-EF	1.000	6	0.236	3.500	1.250	0.875	39840	1	XD.T 0703	10006
C211.125.R.08-07-A100-150-EF	1.250	8	0.236	3.500	1.500	1.000	36240	1	XD.T 0703	12508

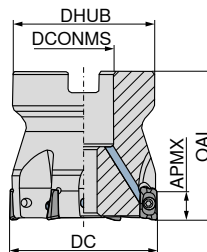
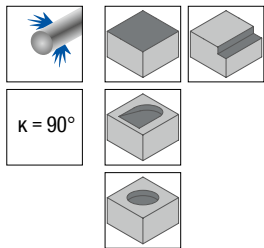

MaxiMill – Shell mill A 211-07



58 753 ...

Designation	DC inch	ZNF	APMX inch	OAL inch	DCONMS _{H6} inch	DHUB inch	RPMX 1/min.	Insert	
A211.150.R.08-07-A050-175-EF	1.500	8	0.236	1.420	0.500	1.420	33240	XD.T 0703	15008
A211.200.R.10-07-A075-175-EF	2.000	10	0.236	1.750	0.750	1.750	30480	XD.T 0703	20010

Spare parts
DC
0.375 - 2.000

 Screwdriver	 Molykote	 Clamping screw
80 950 ...	70 950 ...	70 950 ...
117	303	137

XDKT

Designation	IC inch	D1 inch	L inch	BS inch	S inch
XDKT 0703..	0.193	0.098	0.307	0.047	0.125

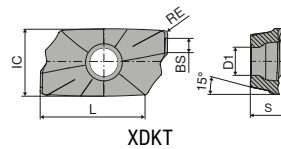

XDKT

ISO	RE inch	-F50 CTCP230 DRAGONSKIN	-M50 CTCP230 DRAGONSKIN	-F50 CTPP235 DRAGONSKIN	-M50 CTPP235 DRAGONSKIN
070304SR	0.016	51 033 ...	51 036 ...	51 033 ...	51 036 ...
070308SR	0.031	004 008	004 008	104 108	104 108

P	●	●	●	●
M	○	○	○	○
K	○	○	○	○
N				
S				
H				
O				

XDKT

ISO	RE inch	-F50 CTPM240 DRAGONSKIN	-M50 CTPM240 DRAGONSKIN	-F40 CTPM245 DRAGONSKIN	NEW -F40 CTCM245 DRAGONSKIN	-F20 CTWN215	-F40 CTC5240 DRAGONSKIN	-F40 CTCS245 DRAGONSKIN
070304ER	0.016	51 033 ...	51 036 ...	51 112 ...	51 112 ...	50 507 ...	50 498 ...	51 112 ...
070304FR	0.016			454	90401		544	
070304SR	0.016	404	404			504		
070308ER	0.031			458	90801		548	558
070308FR	0.031					508		
070308SR	0.031	408	408					

P	○	○	●	●				
M	●	●	●	●				
K						○		
N						●		
S					○		●	●
H								
O						○		

Milling guide

Cutting data standard values	→ 97-100	Machining strategy	→ 111
Starting Parameter	→ 111	Technical Information	→ 132-136
Chip groove description and overview	→ 137-139	Grade description and overview	→ 140-142

MaxiMill – Screw in cutter G 211-11

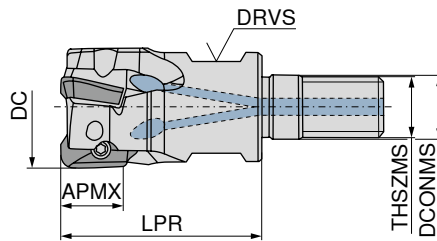
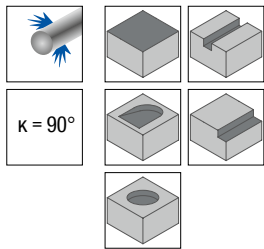

58 736 ...

Designation	DC inch	ZNF	APMX inch	LPR inch	DCONMS inch	THSZMS inch	RPMX 1/min.	torque moment Nm	Insert	
G211.0625.R.02-11-125-F	0.625	2	0.394	1.250	0.335	M8	42000	1,6	XD.T 11T3	06202
G211.0750.R.03-11-118-F	0.750	3	0.394	1.118	0.492	M12	36900	1,6	XD.T 11T3	07503
G211.100.R.04-11-150-F	1.000	4	0.394	1.500	0.492	M12	33200	1,6	XD.T 11T3	10004
G211.125.R.05-11-150-F	1.250	5	0.394	1.500	0.669	M16	30200	1,6	XD.T 11T3	12505

MaxiMill – End milling cutter C 211-11

▲ Insert radius > 0.063": Modify cutter body

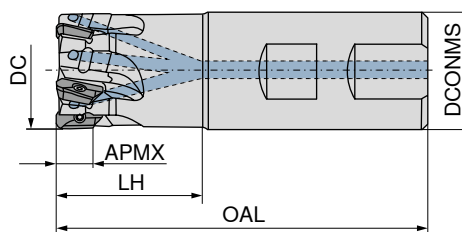
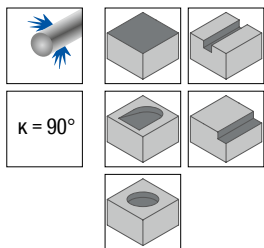

A B

Designation	DC inch	ZNF	APMX inch	OAL inch	LH inch	DCONMS _{h6} inch	RPMX 1/min.	torque moment Nm	Insert	58 737 ...	58 737 ...
C211.0625.R.02-11-B-100-EF	0.625	2	0.394	3.250	1.000	0.625	42000	1,6	XD.T 11T3		26202
C211.0625.R.02-11-A-125-EF-650	0.625	2	0.394	6.500	1.250	0.625	14800	1,6	XD.T 11T3	06202	
C211.0750.R.03-11-B-100-EF	0.750	3	0.394	3.500	1.000	0.750	36900	1,6	XD.T 11T3		27503
C211.0750.R.03-11-A-125-EF-650	0.750	3	0.394	6.500	1.250	0.750	15800	1,6	XD.T 11T3	07503	
C211.100.R.04-11-B-125-EF	1.000	4	0.394	3.500	1.250	1.000	33200	1,6	XD.T 11T3		30004
C211.100.R.04-11-A-150-EF-650	1.000	4	0.394	6.500	1.500	1.000	19900	1,6	XD.T 11T3	10004	
C211.125.R.05-11-B100-150-EF	1.250	5	0.394	3.750	1.500	1.000	30200	1,6	XD.T 11T3		32505
C211.125.R.05-11-A100-200-EF-650	1.250	5	0.394	6.500	2.000	1.000	20900	1,6	XD.T 11T3	12505	
C211.150.R.06-11-B-200-EF	1.500	6	0.394	4.000	2.000	1.250	27700	1,6	XD.T 11T3		35006

Spare parts

DC	80 950 ...	70 950 ...	70 950 ...
0.625 - 1.250	039	303	128
1.500	039	303	131

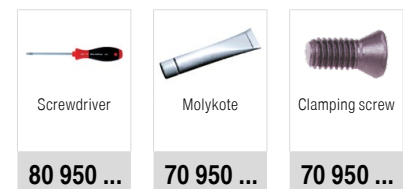

MaxiMill – Shell mill A 211-11

▲ Insert radius > 0.063": Modify cutter body

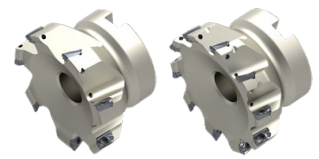
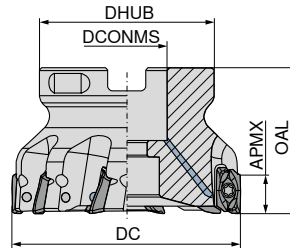
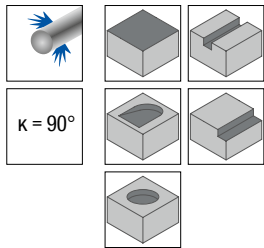

Designation	DC inch	ZNF	APMX inch	OAL inch	DCONMS _{H6} inch	DHUB inch	RPMX 1/min.	torque moment Nm	Insert	58 738 ...		58 739 ...	
A211.150.R.04-11-A050-175-EF	1.500	4	0.394	1.420	0.500	1.420	27700	1,6	XD.T 11T3	15004			
A211.150.R.06-11-A050-175-EF	1.500	6	0.394	1.420	0.500	1.420	27700	1,6	XD.T 11T3				15006
A211.200.R.05-11-A075-175-EF	2.000	5	0.394	1.750	0.750	1.750	25400	1,6	XD.T 11T3	20005			
A211.200.R.08-11-A075-175-EF	2.000	8	0.394	1.750	0.750	1.750	25400	1,6	XD.T 11T3				20008
A211.250.R.06-11-A100-200-EF	2.500	6	0.394	2.250	1.000	2.250	23300	1,6	XD.T 11T3	25006			
A211.250.R.10-11-A100-200-EF	2.500	10	0.394	2.250	1.000	2.250	23300	1,6	XD.T 11T3				25010
A211.300.R.07-11-A100-200-EF	3.000	7	0.394	2.250	1.000	2.250	21300	1,6	XD.T 11T3	30007			
A211.300.R.12-11-A100-200-EF	3.000	12	0.394	2.250	1.000	2.250	21300	1,6	XD.T 11T3				30012
A211.400.R.08-11-B125-200-EF	4.000	8	0.394	2.750	1.250	2.750	19600	1,6	XD.T 11T3	40008			
A211.400.R.14-11-B125-200-EF	4.000	14	0.394	2.750	1.250	2.750	19600	1,6	XD.T 11T3				40014
A211.500.R.10-11-B150-200-EF	5.000	10	0.394	3.750	1.500	3.750	17900	1,6	XD.T 11T3	50010			
A211.600.R.12-11-B150-200-EF	6.000	12	0.394	3.750	1.500	3.750	16500	1,6	XD.T 11T3	60012			

Screwdriver	Molykote	Clamping screw
80 950 ...	70 950 ...	70 950 ...
039 039	303 303	128 131

Spare parts

DC
0.625 - 1.250
1.500 - 6.000

MaxiMill – Extended flute cutter C 211-11K

- ▲ ZEFP = Number of inserts
- ▲ ZNP = Number of teeth

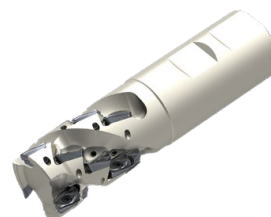
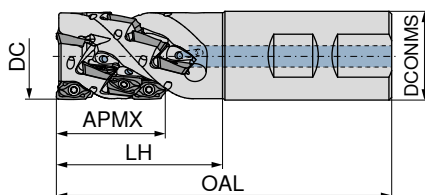

58 758 ...

Designation	DC inch	ZNF	APMX inch	OAL inch	LH inch	DCONMS inch	ZEFP	ZNP	torque moment Nm	
C211.100.R.02K3-11-B-150-EF	1.000	2	1.060	3.750	1.500	1.000	6	3	1,6	10002
C211.125.R.02K4-11-B-200-EF	1.250	2	1.430	4.500	2.000	1.250	8	4	1,6	12502
C211.150.R.03K4-11-A-225-EF	1.500	3	1.420	5.100	2.250	1.500	12	4	1,6	15003 ¹⁾

1) DIN 1835 A Shank

MaxiMill – Extended flute cutter A 211-11K

- ▲ ZEFP = Number of inserts
- ▲ ZNP = Number of teeth

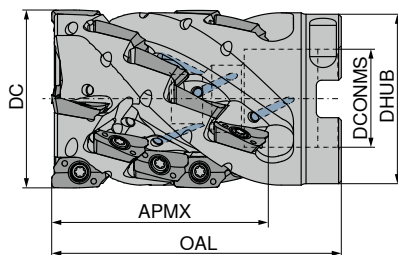





58 757 ...

Designation	DC inch	ZNF	APMX inch	ZEFP	ZNP	OAL inch	DCONMS _{H6} inch	DHUB inch	torque moment Nm	Insert	
A211.200.R.04K5-11-A075-EF	2.000	4	1.800	20	5	1.750	0.750	1.750	1,6	XD.T 11T3	20004
A211.250.R.05K7-11-A100-EF	2.500	5	2.500	35	7	2.250	1.000	2.250	1,6	XD.T 11T3	25005
A211.300.R.06K9-11-A125-EF	3.000	6	3.200	54	9	2.750	1.250	2.750	1,6	XD.T 11T3	30006

Spare parts for Article no.

58 757 20004
58 757 25005
58 757 30006
58 758 10002 / 58 758 12502
58 758 15003

 Cylindrical screw	 Screwdriver	 Molykote	 Clamping screw
70 950 ...	80 950 ...	70 950 ...	70 950 ...
002	039	303	131
003	039	303	131
004	039	303	131
	039	303	131
	039	303	131

XDKT / XDHT

Designation	IC inch	D1 inch	L inch	BS inch	S inch
XD.T 11T302..	0.268	0.110	0.417	0.079	0.150
XD.T 11T304..	0.268	0.110	0.417	0.071	0.150
XD.T 11T308..	0.268	0.110	0.417	0.055	0.150
XD.T 11T312..	0.268	0.110	0.417	0.055	0.150
XD.T 11T316..	0.268	0.110	0.417	0.055	0.150
XD.T 11T320..	0.268	0.110	0.417	0.055	0.150
XD.T 11T325..	0.268	0.110	0.417	0.055	0.150
XD.T 11T332..	0.268	0.110	0.417	0.031	0.150
XD.T 11T340..	0.268	0.110	0.417	-	0.150
XDHT 11T350..	0.268	0.110	0.417	-	0.150
XDKT 11T332..	0.268	0.110	0.417	0.055	0.150
XDKT 11T332..	0.268	0.110	0.417	-	0.150

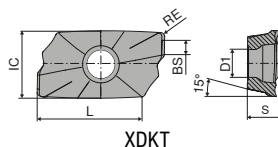

XDKT

-F50 CTCP220	-M50 CTCP220	-F50 CTPP225	-M50 CTPP225
DRAGONSKIN	DRAGONSKIN	DRAGONSKIN	DRAGONSKIN
XDKT	XDKT	XDKT	XDKT
51 034 ...	51 037 ...	51 034 ...	51 037 ...
258	258	058	058

ISO	RE inch
11T308SR	0.031

P	•	•	•	•
M				
K				
N				
S				
H				
O				

XDKT

-F50 CTCP230	-M50 CTCP230	-R50 CTCP230	-F50 CTPP235	-M50 CTPP235	-R50 CTPP235
DRAGONSKIN	DRAGONSKIN	DRAGONSKIN	DRAGONSKIN	DRAGONSKIN	DRAGONSKIN
XDKT	XDKT	XDKT	XDKT	XDKT	XDKT
51 034 ...	51 037 ...	51 039 ...	51 034 ...	51 037 ...	51 039 ...

ISO	RE inch
11T304SR	0.016
11T308SR	0.031
11T312SR	0.047
11T320SR	0.079
11T325SR	0.098
11T332SR	0.126
11T340SR	0.157

P	•	•	•	•	•
M				○	○
K	○	○	○	○	○
N					
S					
H					
O					

1) Insert radius > 0.063": Modify cutter body

XDKT

ISO		RE	-F50 CTPM225		-M50 CTPM225		-R50 CTPM225		-F50 CTCM235		-M50 CTCM235		-R50 CTCM235	
		inch	DRAGONSKIN		DRAGONSKIN		DRAGONSKIN		DRAGONSKIN		DRAGONSKIN		DRAGONSKIN	
			XDKT		XDKT		XDKT		XDKT		XDKT		XDKT	
			51 034 ...		51 037 ...		51 039 ...		51 034 ...		51 037 ...		51 039 ...	
11T308SR		0.031	208		208		208		308		308		308	
P			•		•		•		•		•		•	
M			•		•		•		•		•		•	
K														
N														
S														
H														
O														

XDKT

ISO		RE	-F50 CTPM240		-M50 CTPM240		-R50 CTPM240		-F40 CTPM245		-F50 CTPM245		-F40 CTCM245		-F50 CTCM245	
		inch	DRAGONSKIN		DRAGONSKIN		DRAGONSKIN		DRAGONSKIN		DRAGONSKIN		DRAGONSKIN		DRAGONSKIN	
			XDKT		XDKT		XDKT		XDKT		XDKT		XDKT		XDKT	
			51 034 ...		51 037 ...		51 039 ...		51 113 ...		51 034 ...		51 113 ...		51 034 ...	
11T304ER	0.016								454					90401		
11T304SR	0.016				404									90801		
11T308ER	0.031							458						91201		90801
11T308SR	0.031		408		408		408			458						
11T312ER	0.047							462						91601		
11T312SR	0.047		412		412		412							92001 ¹⁾		
11T316ER	0.063							466						92501 ¹⁾		
11T320ER	0.079							470 ¹⁾						93201 ¹⁾		
11T320SR	0.079		420 ¹⁾		420 ¹⁾		420 ¹⁾									
11T325ER	0.098							475 ¹⁾						94001 ¹⁾		
11T332ER	0.126							482 ¹⁾								
11T332SR	0.126		432 ¹⁾		432 ¹⁾		432 ¹⁾									
11T340ER	0.157							490 ¹⁾								
P			○		○		○	•		•			•		•	
M			•		•		•	•		•			•		•	
K																
N																
S													○		○	
H																
O																

1) Insert radius > 0.063": Modify cutter body

XDKT / XDHT

ISO	RE inch	-M50 CTCK215 DRAGONSKIN XDKT 51 037 ...	-R50 CTCK215 DRAGONSKIN XDKT 51 039 ...	-M50 CTPK220 DRAGONSKIN XDKT 51 037 ...	-F20 CTWN215 XDKT 50 478 ...	-27P H216T XDHT 50 477 ...
11T302FR	0.008				502	502
11T304FR	0.016				504	504
11T304SR	0.016	504				
11T308FR	0.031				508	508
11T308SR	0.031	508	508	608		
11T312FR	0.047					512
11T316FR	0.063					516
11T320FR	0.079				520 ¹⁾	520 ¹⁾
11T325FR	0.098				525 ¹⁾	525 ¹⁾
11T332FR	0.126					532 ¹⁾
11T340FR	0.157					540 ¹⁾
11T350FR	0.197					550 ¹⁾

P						
M						
K		•	•	•	○	○
N					•	•
S						
H						
O					○	○

1) Insert radius > 0.063": Modify cutter body

XDKT

ISO	RE inch	-F40 CTC5240 DRAGONSKIN XDKT 50 463 ...	-F40 CTCS245 DRAGONSKIN XDKT 51 113 ...	-R60 CTP6215 XDKT 50 464 ...
11T304ER	0.016	504		
11T308ER	0.031	500		
11T308SR	0.031		558	300
11T312ER	0.047	512	562	
11T316ER	0.063	516	566	
11T320ER	0.079	520 ¹⁾	570	
11T325ER	0.098	525 ¹⁾	57500 ¹⁾	
11T332ER	0.126	532 ¹⁾	582	
11T340ER	0.157	540 ¹⁾	59000 ¹⁾	

P				
M				
K				•
N				
S		•	•	
H				
O				•

1) Insert radius > 0.063": Modify cutter body

Milling guide

Cutting data standard values	→ 97-100	Machining strategy	→ 112
Starting Parameter	→ 112	Technical Information	→ 132-136
Chip groove description and overview	→ 137-139	Grade description and overview	→ 140-142

MaxiMill – End milling cutter C 211-15

▲ Insert radius > 0.098": Modify cutter body

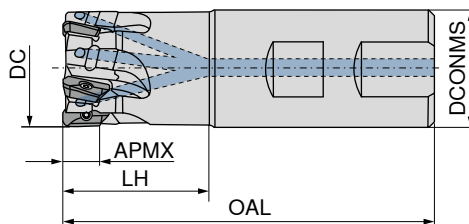
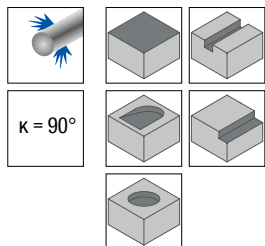

Designation	DC inch	ZNF	APMX inch	OAL inch	LH inch	DCONMS inch	RPMX 1/min.	torque moment Nm	Insert	58 747 ...	
										A	B
C211.100.R.02-15-A-200-EF-800	1.000	2	0.551	8.000	2.000	1.000	7520	3,2	XD.T 1505	10002	
C211.125.R.03-15-B-150-EF-400	1.250	3	0.551	4.000	1.500	1.250	24160	3,2	XD.T 1505		32503
C211.125.R.03-15-A-250-EF-1000	1.250	3	0.551	10.000	2.500	1.250	6800	3,2	XD.T 1505	12503	
C211.150.R.03-15-B125-200-EF-450	1.500	3	0.551	4.500	2.000	1.250	22160	3,2	XD.T 1505		35003
C211.150.R.04-15-B125-200-EF-450	1.500	4	0.551	4.500	2.000	1.250	22160	3,2	XD.T 1505		35004
C211.150.R.03-15-A125-300-EF-1000	1.500	3	0.551	10.000	3.000	1.250	6120	3,2	XD.T 1505	15003	

MaxiMill – Shell mill A 211-15

▲ Insert radius > 0.098": Modify cutter body

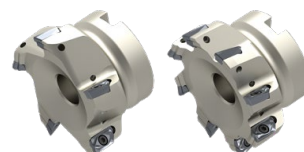
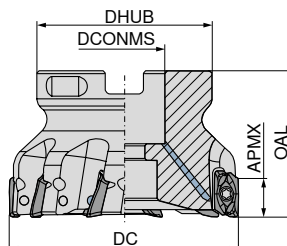
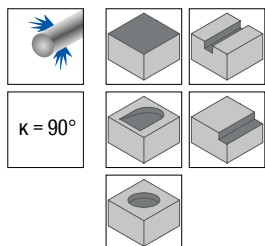

Designation	DC inch	ZNF	APMX inch	OAL inch	DCONMS _{H6} inch	DHUB inch	RPMX 1/min.	torque moment Nm	Insert	58 748 ...		58 749 ...	
										A	B	A	B
A211.150.R.03-15-A050-175-EF	1.500	3	0.551	1.420	0.500	1.420	22160	3,2	XD.T 1505	15003			
A211.200.R.05-15-A075-175-EF	2.000	5	0.551	1.750	0.750	1.750	20320	3,2	XD.T 1505	20005			
A211.250.R.06-15-A100-200-EF	2.500	6	0.551	2.250	1.000	2.250	18640	3,2	XD.T 1505	25006			
A211.300.R.05-15-A100-200-EF	3.000	5	0.551	2.250	1.000	2.250	17040	3,2	XD.T 1505	30005			
A211.300.R.08-15-A100-200-EF	3.000	8	0.551	2.250	1.000	2.250	17040	3,2	XD.T 1505			30008	
A211.400.R.06-15-A125-200-EF	4.000	6	0.551	2.750	1.250	2.750	16000	3,2	XD.T 1505	40006			
A211.400.R.09-15-A125-200-EF	4.000	9	0.551	2.750	1.250	2.750	16000	3,2	XD.T 1505			40009	
A211.500.R.10-15-B150-250-EF	5.000	10	0.551	3.750	1.500	3.750	14320	3,2	XD.T 1505	50010			
A211.600.R.08-15-B150-250-EF	6.000	8	0.551	2.500	1.500	3.750	13200	3,2	XD.T 1505	60008			
A211.600.R.10-15-B150-250-EF	6.000	10	0.551	3.750	1.500	3.750	13200	3,2	XD.T 1505			60010	

Spare parts DC

1.000 - 6.000

80 950 ...	70 950 ...	70 950 ...
Screwdriver	Molykote	Clamping screw
120	303	839

MaxiMill – Extended flute cutter A 211-15K

▲ ZEFP = Number of Inserts

▲ ZNP = Number of rows

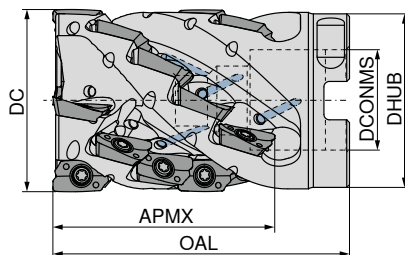





58 759 ...

Designation	DC inch	ZNF	APMX inch	ZEFP	ZNP	OAL inch	DCONMS _{H6} inch	DHUB inch	torque moment Nm	Insert	
A211.200.R.03K4-15-A075-EF	2.000	3	2.000	12	4	1.750	0.750	1.750	3,2	XD.T 1505	20003
A211.250.R.04K5-15-A100-EF	2.500	4	2.500	20	5	2.250	1.000	2.250	3,2	XD.T 1505	25004
A211.300.R.04K6-15-A100-EF	3.000	4	3.000	24	6	2.250	1.000	2.250	3,2	XD.T 1505	30004
A211.300.R.04K6-15-A125-EF	3.000	4	3.000	24	6	2.750	1.250	2.750	3,2	XD.T 1505	30104

Spare parts

DC				
2.000	002	120	303	839
2.500 - 3.000	003	120	303	839

 Cylindrical screw 70 950 ...	 Screwdriver 80 950 ...	 Molykote 70 950 ...	 Clamping screw 70 950 ...
---	--	---	---

MaxiMill – Extended flute cutter A 211-15K

▲ ZEFP = Number of Inserts



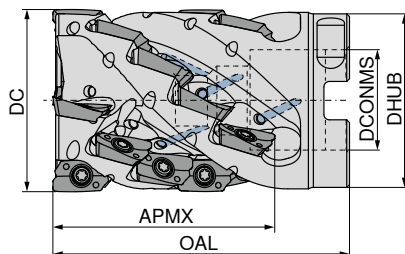

▲ ZNP = Number of rows



58 759 ...

Designation	DC inch	ZNF	APMX inch	ZEFP	ZNP	OAL inch	DCONMS _{H6} inch	DHUB inch	torque moment Nm	Insert	
A211.400.R.05KN6-15-A150-EF	4.000	5	3.090	30	6	4.250	1.500	3.750	3,2	XD.T 1505	40005

Spare parts
for Article no.
58 759 40005

 Cylindrical screw 70 950 ...	 Screwdriver 80 950 ...	 Molykote 70 950 ...	 Clamping screw 70 950 ...
---	--	---	---

XDKT

Designation	IC inch	D1 inch	L inch	BS inch	S inch
XDKT 150508..	0.366	0.173	0.583	0.063	0.219
XDKT 150512..	0.366	0.173	0.583	0.063	0.219
XDKT 150516..	0.366	0.173	0.583	0.063	0.219
XDKT 150520..	0.366	0.173	0.583	0.063	0.219
XDKT 150525..	0.366	0.173	0.583	0.063	0.219
XDKT 150530..	0.366	0.173	0.583	0.063	0.219
XDKT 150532..	0.366	0.173	0.583	0.075	0.219
XDKT 150540..	0.366	0.173	0.583	0.047	0.219
XDKT 150560..	0.366	0.173	0.583	-	0.219

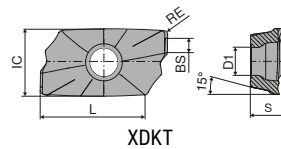

XDKT

-F50 CTCP220	-M50 CTCP220	-F50 CTPP225	-M50 CTPP225
DRAGONSKIN	DRAGONSKIN	DRAGONSKIN	DRAGONSKIN
XDKT 51 035 ...	XDKT 51 038 ...	XDKT 51 035 ...	XDKT 51 038 ...
258	258	058	058

ISO	RE inch
150508SR	0.031

P	•	•	•	•
M				
K				
N				
S				
H				
O				

XDKT

-F50 CTCP230	-M50 CTCP230	-R50 CTCP230	-F50 CTPP235	-M50 CTPP235	-R50 CTPP235
DRAGONSKIN	DRAGONSKIN	DRAGONSKIN	DRAGONSKIN	DRAGONSKIN	DRAGONSKIN
XDKT 51 035 ...	XDKT 51 038 ...	XDKT 51 040 ...	XDKT 51 035 ...	XDKT 51 038 ...	XDKT 51 040 ...
008	008 012 016	008 020	108	108 112 116 120 130 140	108

ISO	RE inch
150508SR	0.031
150512SR	0.047
150516SR	0.063
150520SR	0.079
150530SR	0.118
150540SR	0.157

P	•	•	•	•	•
M			○	○	○
K	○	○	○	○	○
N					
S					
H					
O					

XDKT

ISO	RE inch	-F50 CTPM225 DRAGONSKIN	-M50 CTPM225 DRAGONSKIN	-F50 CTCM235 DRAGONSKIN	-M50 CTCM235 DRAGONSKIN
150508SR	0.031	XDKT 51 035 ... 208	XDKT 51 038 ... 208	XDKT 51 035 ... 308	XDKT 51 038 ... 308
P		•	•	•	•
M		•	•	•	•
K					
N					
S					
H					
O					

XDKT

ISO	RE inch	-F50 CTPM240 DRAGONSKIN	-M50 CTPM240 DRAGONSKIN	-R50 CTPM240 DRAGONSKIN	-F40 CTPM245 DRAGONSKIN	NEW -F40 CTCM245 DRAGONSKIN
150508ER	0.031	XDKT 51 035 ... 408	XDKT 51 038 ... 408	XDKT 51 040 ... 408	XDKT 51 114 ... 458	XDKT 51 114 ... 90801
150508SR	0.031					
150512ER	0.047					
150512SR	0.047					
150516ER	0.063					
150516SR	0.063					
150520ER	0.079					
150525ER	0.098					
150530SR	0.118					
150532ER	0.126					
150540ER	0.157					
150540SR	0.157					
150560ER	0.236					
P		○	○	○	•	•
M		•	•	•	•	•
K						
N						
S						○
H						
O						

1) Insert radius > 0.098": Modify cutter body
2) Insert radius > 0.063": Modify cutter body

XDKT

ISO	RE inch					
150508FR	0.031					
150508SR	0.031		508	508	608	608
P						
M						
K			•	•	•	•
N						•
S						
H						
O						•

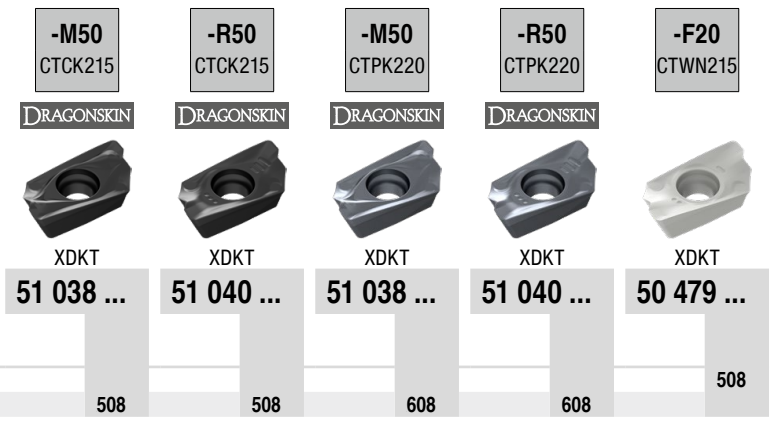

XDKT

ISO	RE inch				
150508ER	0.031				
150508SR	0.031		508	558	300
150532ER	0.126		532 ¹⁾		
150540ER	0.157		540 ¹⁾	59000 ¹⁾	
P					
M					
K					•
N					
S			•	•	
H					•
O					

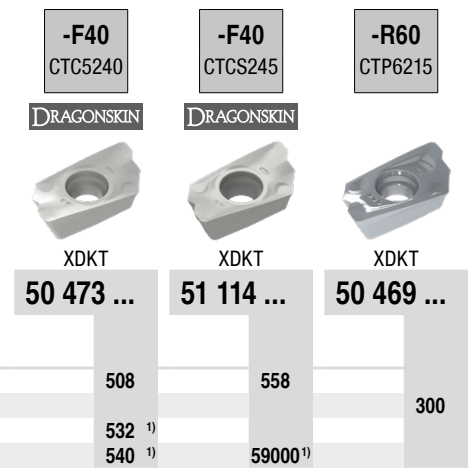

1) Insert radius > 0.098": Modify cutter body

Milling guide

Cutting data standard values	→ 97-100	Machining strategy	→ 113
Starting Parameter	→ 113	Technical Information	→ 132-136
Chip groove description and overview	→ 137-139	Grade description and overview	→ 140-142

MaxiMill – End milling cutter C 211-20K

- ▲ ZEFP = Number of Inserts
- ▲ ZNP = Number of rows

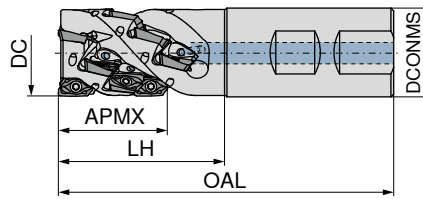
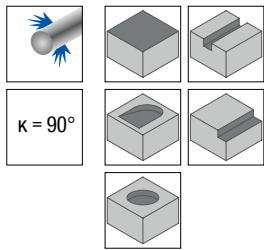

58 779 ...

Designation	DC inch	ZNF	APMX inch	ZNP	ZEFP	OAL inch	LH inch	DCONMS inch	torque moment Nm	Insert	
C211.200.R.03K10-20-B200-EF	2.000	3	6.500	10	30	11.000	6.690	2.000	5	XD.. 2007..	20003

Spare parts
for Article no.
58 779 20003

Screwdriver	Molykote	Clamping screw
80 950 ...	70 950 ...	70 950 ...
106	303	01200

MaxiMill – Extended flute cutter A 211-20K

- ▲ ZEFP = Number of Inserts
- ▲ ZNP = Number of rows

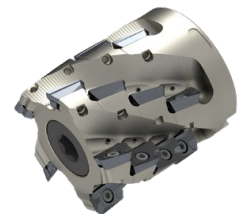
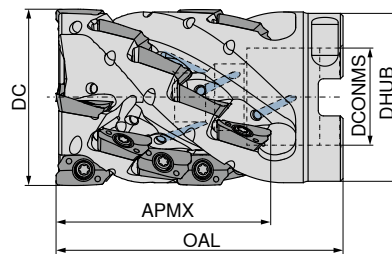
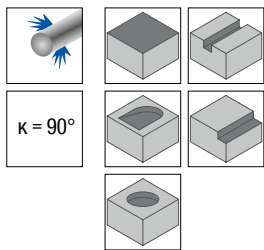

NEW

58 780 ...

Designation	DC inch	ZNF	APMX inch	ZNP	ZEFP	OAL inch	DCONMS _{H6} inch	DHUB inch	Insert	
A211.250.R.04K4-20-A100-EF	2.500	4	2.650	4	16	2.250	1.000	2.250	XD.. 2007..	25004
A211.300.R.05K5-20-A125-EF	3.000	5	3.250	5	20	2.750	1.250	2.750	XD.. 2007..	30005
A211.400.R.05K5-20-A150-EF	4.000	5	3.340	5	20	4.250	1.500	3.750	XD.. 2007..	40005

Spare parts
for Article no.
58 780 25004
58 780 30005
58 780 40005

Cylindrical screw	Screwdriver	Molykote	Clamping screw
70 950 ...	80 950 ...	70 950 ...	70 950 ...
003	106	303	01200
004	106	303	01200
004	106	303	01200

XDKT

Designation	IC inch	D1 inch	L inch	S inch
XDKT 200708..	0.492	0.217	0.740	0.273
XDKT 200716..	0.492	0.217	0.740	0.271
XDKT 200732..	0.492	0.217	0.740	0.269
XDKT 200740..	0.492	0.217	0.740	0.268
XDKT 200760..	0.492	0.217	0.740	0.268

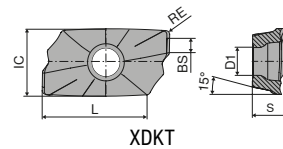

XDKT

ISO	RE inch	CTPP235	CTCP230	CTPM245	CTCM245	CTPK220	CTC5240	CTCS245
200708ER	0.031	10800	00800	45800	90801	60800	15800	55800
200716ER	0.063	11600	01600	46600	91601	61600	16600	56600
200732ER	0.126			48200	93201		18200	58200
200740ER	0.157				94001		19000	
200760ER	0.236				96001		19200	

	P	M	K	N	S	H	O
CTPP235	●	○	○				
CTCP230	●	○	○				
CTPM245	●	○	○				
CTCM245	●	○	○		○		
CTPK220	●	○	○				
CTC5240	●	○	○			●	
CTCS245	●	○	○			●	●

Milling guide

Cutting data standard values	→ 97-100	Machining strategy	→ 114
Starting Parameter	→ 114	Technical Information	→ 132-136
Chip groove description and overview	→ 137-139	Grade description and overview	→ 140-142

MaxiMill – Screw in cutter G 490-09

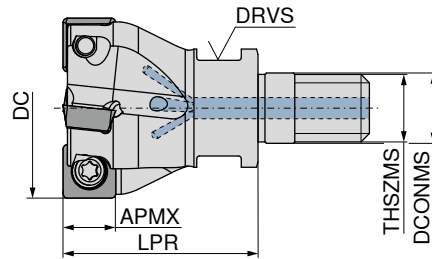
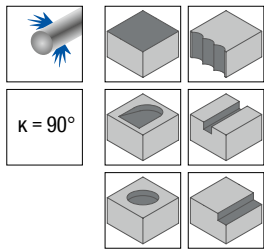

58 726 ...

Designation	DC inch	ZNF	APMX inch	LPR inch	THSZMS inch	DCONMS inch	torque moment Nm	Insert	
G490.100.R.03-09-125-F	1.000	3	0.315	1.250	M12	0.492	3,2	SD.. 09T3..	10003
G490.125.R.04-09-150-F	1.250	4	0.315	1.500	M16	0.669	3,2	SD.. 09T3..	12504

MaxiMill – End milling cutter C 490-09

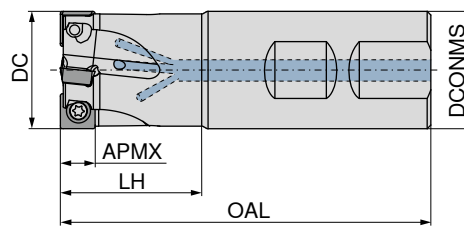
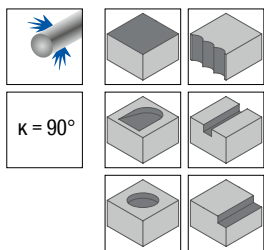

A 58 727 ...

B 58 727 ...

Designation	DC inch	ZNF	APMX inch	DCONMS inch	OAL inch	LH inch	torque moment Nm	Insert	
C490.100.R.03-09-B-125-EF	1.000	3	0.315	1.000	3.500	1.250	3,2	SD.. 09T3..	30003
C490.100.R.02-09-A-150-EF-800	1.000	2	0.315	1.000	8.000	1.500	3,2	SD.. 09T3..	10002
C490.125.R.04-09-B-150-EF	1.250	4	0.315	1.250	3.750	1.500	3,2	SD.. 09T3..	32504
C490.125.R.03-09-A-200-EF-1000	1.250	3	0.315	1.250	10.000	2.000	3,2	SD.. 09T3..	12503

Spare parts

DC
1.000 - 1.250

Screwdriver	Molykote	Clamping screw
80 950 ...	70 950 ...	70 950 ...
105	303	110

MaxiMill – Shell mill A 490-09

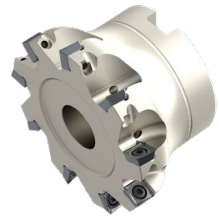
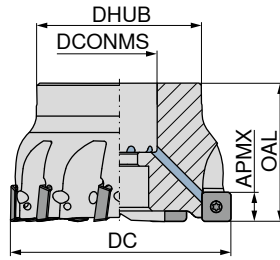
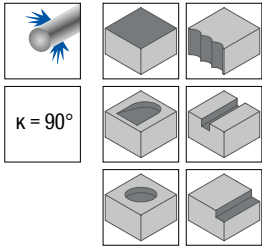

58 728 ...

Designation	DC inch	ZNF	APMX inch	DHUB inch	DCONMS _{H6} inch	OAL inch	torque moment Nm	Insert	
A490.150.R.05-09-A050-175-EF	1.500	5	0.315	1.250	0.500	1.250	3,2	SD.. 09T3..	15005
A490.200.R.06-09-A075-175-EF	2.000	6	0.315	1.650	0.750	1.650	3,2	SD.. 09T3..	20006
A490.250.R.07-09-A100-200-EF	2.500	7	0.315	1.970	1.000	1.970	3,2	SD.. 09T3..	25007
A490.300.R.09-09-A100-200-EF	3.000	9	0.315	2.130	1.000	2.130	3,2	SD.. 09T3..	30009
A490.400.R.10-09-B125-200-EF	4.000	10	0.315	2.870	1.250	2.870	3,2	SD.. 09T3..	40010
A490.500.R.11-09-B200-200-EF	5.000	11	0.315	3.750	2.000	2.000	3,2	SD.. 09T3..	50011
A490.600.R.12-09-B200-200-EF	6.000	12	0.315	3.750	2.000	2.000	3,2	SD.. 09T3..	60012

Screwdriver	Molykote	Clamping screw
80 950 ...	70 950 ...	70 950 ...
105	303	110

Spare Parts
DC
1.500 - 6.000

SDHT / SDNT

Designation	IC inch	D1 inch	L inch	BS inch	S inch
SD.T 09T3..	0.375	0.173	0.375	0.098	0.156

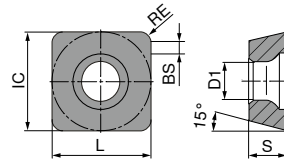

SDHT / SDNT

ISO	RE inch	TCM10	-29 CTCP230 DRAGONSKIN	CTPP235 DRAGONSKIN	-29 CTPP235 DRAGONSKIN	-33 CTPM240 DRAGONSKIN	-F50 CTPM245 DRAGONSKIN	NEW -F50 CTCM245 DRAGONSKIN
09T308ER	0.031	50 424 ...	51 011 ...	51 082 ...	51 011 ...	51 030 ...	51 111 ...	51 111 ...
09T308SR	0.031	900	008	108	108	408	458	90801
P		●	●	●	●	○	●	●
M				○	○	●	●	●
K		○	○	○	○			
N								
S								○
H								
O								

SDNT / SDHT

ISO	RE inch	-31 CTCK215 DRAGONSKIN	-27P H216T	-27P AMZ	-27 CTC5240 DRAGONSKIN	-M31 CTC5240 DRAGONSKIN	-F10 CTCS245 DRAGONSKIN
09T308ER	0.031	51 029 ...	50 424 ...	50 424 ...	50 496 ...	50 425 ...	51 125 ...
09T308FR	0.031	508	550	650	508	508	55800
09T308SR	0.031						
P							
M							
K			●	○	○		
N			●	●	●		
S						●	●
H							●
O			○	○			

Milling guide

Cutting data standard values	→ 97-100	Starting Parameter	→ 115
Technical Information	→ 132-136	Chip groove description and overview	→ 137-139
Grade description and overview	→ 140-142		

MaxiMill – Shell mill A 490-12

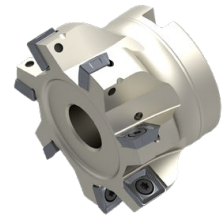
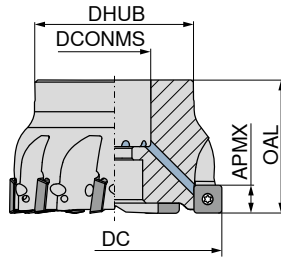
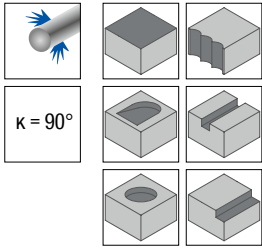

58 703 ...

Designation	DC inch	ZNF	APMX inch	DHUB inch	DCONMS inch	OAL inch	torque moment Nm	Insert
A490.200.R.05-12-A075-175-EF	2.000	5	0.393	1.750	0.750	1.750	5	SD.. 1205..

20005

Spare Parts
for Article no.
58 703 20005

Screwdriver	Molykote	Clamping screw
80 950 ...	70 950 ...	70 950 ...
106	303	01200

SDHW / SDMT / SDHT

Designation	IC inch	D1 inch	L inch	BS inch	S inch
SDH. 120508..	0.500	0.217	0.500	0.087	0.197
SDHT 120512..	0.500	0.217	0.500	0.071	0.197
SDHT 120520..	0.500	0.217	0.500	0.039	0.197
SDHT 120525..	0.500	0.217	0.500	0.059	0.197
SDMT 120508..	0.500	0.217	0.500	0.118	0.197
SDMT 1205ZZ..	0.500	0.217	0.500	0.035	0.197

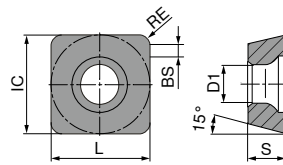

SDHW / SDMT / SDHT

ISO	RE inch	TCM10	-29 CTCP230	-29 CTPP235	-29 CTPM240	-33 CTPM240	-F50 CTPM245	NEW -F50 CTCM245
			DRAGONSKIN	DRAGONSKIN	DRAGONSKIN	DRAGONSKIN	DRAGONSKIN	DRAGONSKIN
		CERMET SDHW	SDMT	SDMT	SDMT	SDHT	SDMT	SDMT
		50 428 ...	51 081 ...	51 081 ...	51 081 ...	51 028 ...	51 110 ...	51 110 ...
120508ER	0.031	901	020	120	420	412 421	458	90801
120508SR	0.031							
120512SR	0.047							
120520SR	0.079							
1205ZZSN	0.031							
P		●	●	●	○	○	●	●
M				○	●	●	●	●
K		○	○	○				
N								
S								○
H								
O								

SDMT / SDHT

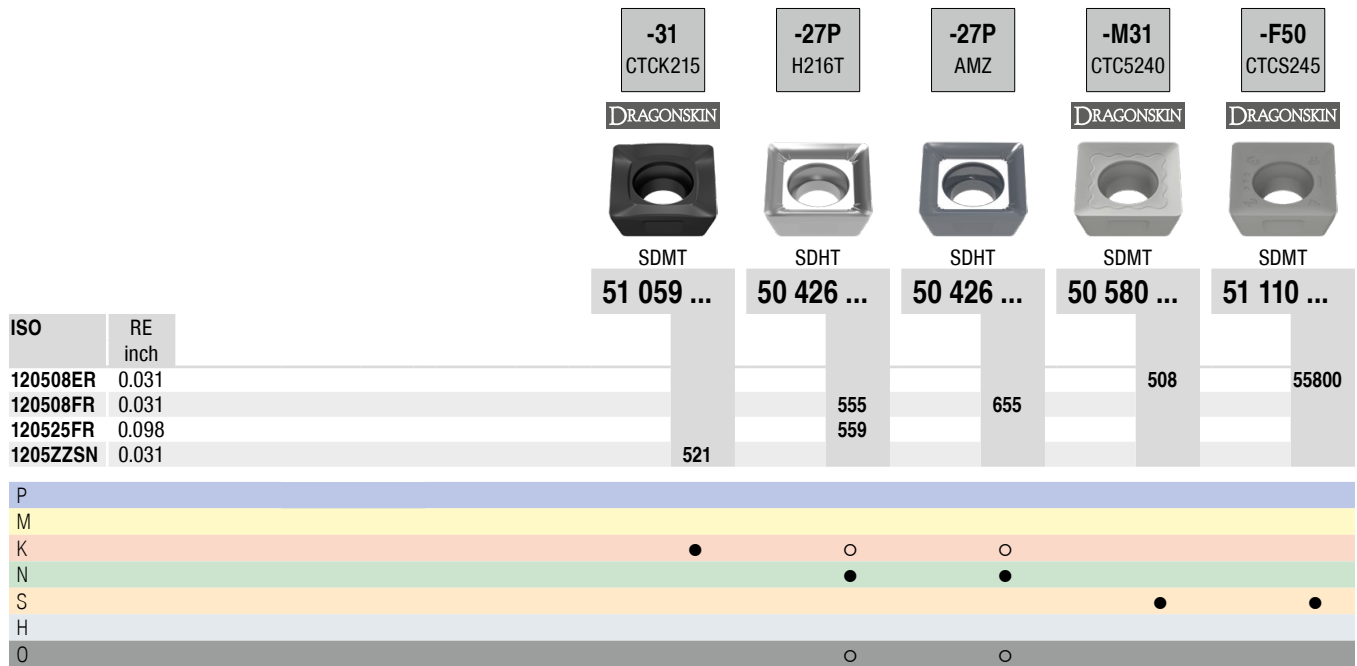

Milling guide

Cutting data standard values	→ 97-100	Starting Parameter	→ 116
Technical Information	→ 132-136	Chip groove description and overview	→ 137-139
Grade description and overview	→ 140-142		

MaxiMill – End milling cutter 90° C HSC-11

- ▲ Insert radius > 0.125": Modify cutter body
- ▲ High Speed Cutter (HSC)

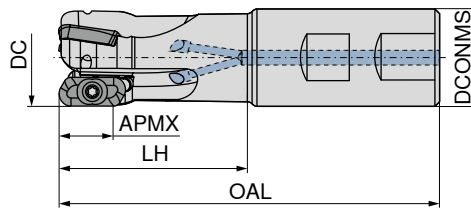
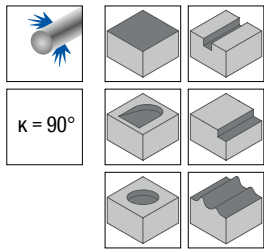

A **58 675 ...**

Designation	DC inch	ZNF	APMX inch	DCONMS _{H6} inch	OAL inch	LH inch	torque moment Nm	Insert	
CHSC.0625.R.02-11-A-100-EF	0.625	2	0.393	0.625	3.000	1.000	1,8	XDHT 11T3..	06202
CHSC.0625.R.02-11-A-125-EF	0.625	2	0.393	0.625	3.250	1.250	1,8	XDHT 11T3..	06302
CHSC.0750.R.02-11-A-150-EF	0.750	2	0.393	0.750	3.600	1.500	1,8	XDHT 11T3..	07502
CHSC.100.R.03-11-A-200-EF	1.000	3	0.393	1.000	4.350	2.000	1,8	XDHT 11T3..	10003

MaxiMill – Shell mill 90° A HSC-11

- ▲ Insert radius > 0.125": Modify cutter body
- ▲ High Speed Cutter (HSC)

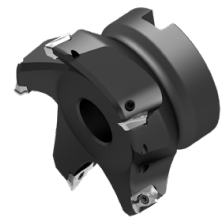
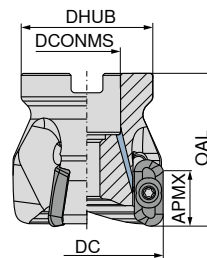
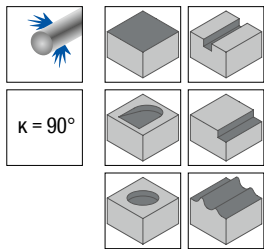

58 718 ...

Designation	DC inch	ZNF	APMX inch	DCONMS _{H6} inch	DHUB inch	OAL inch	torque moment Nm	Insert	
AHSC.150.R.04-11-A050-175-EF	1.500	4	0.393	0.500	1.421	1.750	1,8	XDHT 11T3..	15004
AHSC.200.R.04-11-A075-175-EF	2.000	4	0.393	0.750	1.750	1.750	1,8	XDHT 11T3..	20004
AHSC.250.R.05-11-A100-200-EF	2.500	5	0.393	1.000	2.250	2.000	1,8	XDHT 11T3..	25005
AHSC.300.R.05-11-A100-200-EF	3.000	5	0.393	1.000	2.250	2.000	1,8	XDHT 11T3..	30005

Spare parts

DC	80 950 ...	70 950 ...	70 950 ...
0.625 - 1.000	039	303	128
1.500 - 3.000	039	303	131

Screwdriver	Molykote	Clamping screw
80 950 ...	70 950 ...	70 950 ...

XDKT / XDHT

Designation	IC inch	D1 inch	L inch	BS inch	S inch
XD.T 11T302FR	0.268	0.110	0.417	0.079	0.150
XD.T 11T304FR	0.268	0.110	0.417	0.071	0.150
XD.T 11T308FR	0.268	0.110	0.417	0.055	0.150
XD.T 11T320FR	0.268	0.110	0.417	0.055	0.150
XD.T 11T325FR	0.268	0.110	0.417	0.055	0.150
XDHT 11T312FR	0.268	0.110	0.417	0.055	0.150
XDHT 11T316FR	0.268	0.110	0.417	0.055	0.150
XDHT 11T332FR	0.268	0.110	0.417	0.031	0.150
XDHT 11T340FR	0.268	0.110	0.417	-	0.150
XDHT 11T350FR	0.268	0.110	0.417	-	0.150

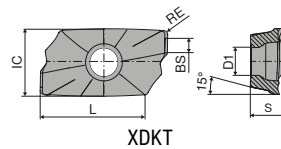

XDKT / XDHT

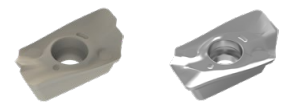
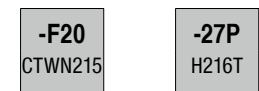

	XDKT 50 478 ...	XDHT 50 477 ...
	502	502
	504	504
	508	508
		512
		516
	520 ¹⁾	520 ¹⁾
	525 ¹⁾	525 ¹⁾
		532 ¹⁾
		540 ¹⁾
		550 ¹⁾

ISO	RE inch
11T302FR	0.008
11T304FR	0.016
11T308FR	0.031
11T312FR	0.047
11T316FR	0.063
11T320FR	0.079
11T325FR	0.098
11T332FR	0.126
11T340FR	0.157
11T350FR	0.197

P		
M		
K		○
N		●
S		
H		
O		○

1) Insert radius > 0.063": Modify cutter body

Milling guide

Safety advice	→ 117	Cutting data standard values	→ 118
Machining strategy	→ 119+120	Technical Information	→ 132-136
Chip groove description and overview	→ 137-139	Grade description and overview	→ 140-142

MaxiMill – End milling cutter 90° C HSC-19

- ▲ Insert radius > 0.157": Modify cutter body
- ▲ High Speed Cutter (HSC)

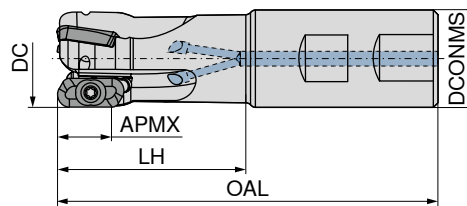
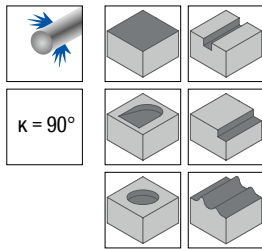

A

58 679 ...

Designation	DC inch	ZNF	APMX inch	DCONMS ^{H5} inch	OAL inch	LH inch	RPMX 1/min.	torque moment Nm	Insert	
CHSC.100.R.02-19-A-200-EF	1.000	2	0.709	1.000	4.500	2.000	35000	5	XDHT 1904..	10002
CHSC.100.R.02-19-A-250-EF	1.000	2	0.709	1.000	6.500	2.500	32800	5	XDHT 1904..	10102
CHSC.125.R.02-19-A-250-EF	1.250	2	0.709	1.250	5.000	2.500	29100	5	XDHT 1904..	12502
CHSC.125.R.02-19-A-325-EF	1.250	2	0.709	1.250	6.500	3.250	27200	5	XDHT 1904..	12602
CHSC.150.R.03-19-A125-325-EF	1.500	3	0.709	1.250	5.750	3.250	23800	5	XDHT 1904..	15003
CHSC.150.R.03-19-A125-400-EF	1.500	3	0.709	1.250	6.500	4.000	21900	5	XDHT 1904..	15103

MaxiMill – Shell mill 90° A HSC-19

- ▲ Insert radius > 0.157": Modify cutter body
- ▲ High Speed Cutter (HSC)

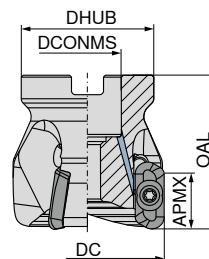
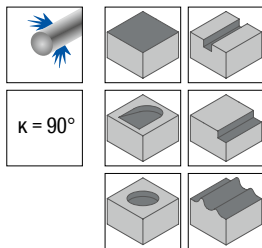

58 716 ...

Designation	DC inch	ZNF	APMX inch	DCONMS ^{H6} inch	DHUB inch	OAL inch	RPMX 1/min.	torque moment Nm	Insert	
AHSC.200.R.03-19-A075-175-EF	2.000	3	0.709	0.750	1.750	1.750	21600	5	XDHT 1904..	20003
AHSC.250.R.03-19-A100-200-EF	2.500	3	0.709	1.000	2.250	2.250	18800	5	XDHT 1904..	25003
AHSC.250.R.04-19-A100-200-EF	2.500	4	0.709	1.000	2.250	2.250	18800	5	XDHT 1904..	25004
AHSC.300.R.03-19-A100-200-EF	3.000	3	0.709	1.000	2.250	2.250	16400	5	XDHT 1904..	30003
AHSC.300.R.04-19-A100-200-EF	3.000	4	0.709	1.000	2.250	2.250	16400	5	XDHT 1904..	30004
AHSC.400.R.04-19-B125-200-EF	4.000	4	0.709	1.250	2.750	2.750	14500	5	XDHT 1904..	40004
AHSC.500.R.05-19-B150-200-EF	5.000	5	0.709	1.500	3.750	3.750	12800	5	XDHT 1904..	50005
AHSC.600.R.05-19-B150-200-EF	6.000	5	0.709	1.500	3.750	3.750	11500	5	XDHT 1904..	60005

Screwdriver	Molykote	Clamping screw
80 950 ...	70 950 ...	70 950 ...

Spare parts for Article no.

58 679 10002 / 58 679 10102	105	303	172
58 679 12502	039	303	128
58 679 12602 / 58 679 15003	105	303	173
58 679 15103	105	303	173
58 716 40004 / 58 716 50005	105	303	174
58 716 60005 / 58 716 20003	105	303	174
58 716 25003 / 58 716 25004	105	303	174
58 716 30004 / 58 716 30003	105	303	174

XDHT

Designation	IC inch	D1 inch	L inch	BS inch	S inch
XDHT 190402..	0.375	0.183	0.748	0.079	0.187
XDHT 190404..	0.375	0.183	0.748	0.079	0.187
XDHT 190408..	0.375	0.183	0.748	0.079	0.187
XDHT 190412..	0.375	0.183	0.748	0.079	0.187
XDHT 190416..	0.375	0.183	0.748	0.079	0.187
XDHT 190420..	0.375	0.183	0.748	0.079	0.187
XDHT 190425..	0.375	0.183	0.748	0.055	0.187
XDHT 190432..	0.375	0.183	0.748	0.039	0.187
XDHT 190440..	0.375	0.183	0.748	0.039	0.187
XDHT 190450..	0.375	0.183	0.748	-	0.187

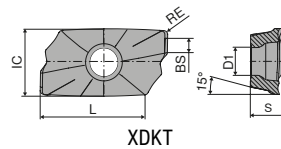

XDHT

-27P
H216T

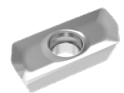

XDHT
50 487 ...
552
554
556
557
558
560
562
564
566
568 ¹⁾

ISO	RE inch	
190402FR	0.008	552
190404FR	0.016	554
190408FR	0.031	556
190412FR	0.047	557
190416FR	0.063	558
190420FR	0.079	560
190425FR	0.098	562
190432FR	0.126	564
190440FR	0.157	566
190450FR	0.197	568 ¹⁾
P		
M		
K		○
N		●
S		
H		
O		○

1) Insert radius > 0.157": Modify cutter body

Milling guide

Cutting data standard values	→ 97-100	Safety advice	→ 117
Machining strategy	→ 121-123	Technical Information	→ 132-136
Chip groove description and overview	→ 137-139	Grade description and overview	→ 140-142

MaxiMill – Screw in cutter G HFC

▲ High Feed Cutter (HFC)

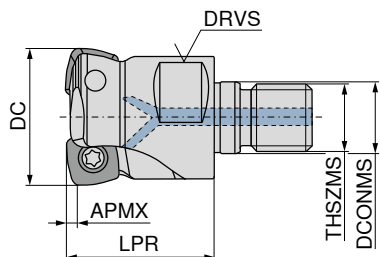
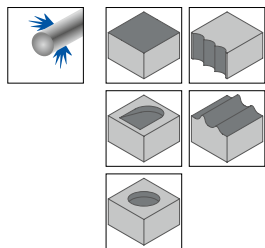

58 682 ...

Designation	DC inch	ZNF	APMX inch	LPR inch	DCONMS inch	THSZMS inch	RPMX 1/min.	torque moment Nm	Insert	
GHFC.0625.R.02-06-125-F	0.625	2	0.031	1.250	0.335	M8	17800	1,2	XPLX 0603..	06202
GHFC.0750.R.03-06-125-F	0.750	3	0.031	1.250	0.413	M10	21400	1,2	XPLX 0603..	07503
GHFC.100.R.04-06-150-F	1.000	4	0.031	1.500	0.492	M12	17000	1,2	XPLX 0603..	10004
GHFC.125.R.05-06-150-F	1.250	5	0.031	1.500	0.669	M16	20300	1,2	XPLX 0603..	12505

MaxiMill – End milling cutter C HFC

▲ High Feed Cutter (HFC)

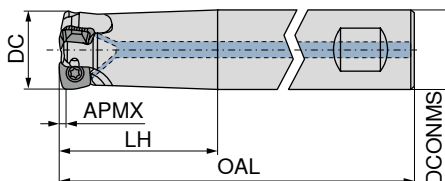
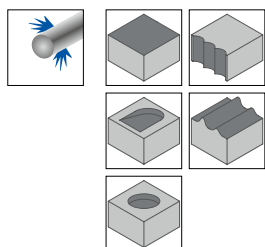

A

B

58 681 ...

58 681 ...

Designation	DC inch	ZNF	APMX inch	OAL inch	LH inch	DCONMS _{hg} inch	RPMX 1/min.	torque moment Nm	Insert		
CHFC.0625.R.02-06-B-150-EF	0.625	2	0.031	3.500	1.500	0.625	18100	1,2	XPLX 0603..		26202
CHFC.0625.R.02-06-A-150-EF-800	0.625	2	0.031	8.000	1.500	0.625	18100	1,2	XPLX 0603..	06202	
CHFC.0750.R.03-06-B-200-EF	0.750	3	0.031	4.200	2.000	0.750	14100	1,2	XPLX 0603..		27503
CHFC.0750.R.03-06-A-200-EF-900	0.750	3	0.031	9.000	2.000	0.750	14100	1,2	XPLX 0603..	07503	
CHFC.100.R.04-06-B-200-EF	1.000	4	0.031	4.400	2.000	1.000	15400	1,2	XPLX 0603..		30004
CHFC.100.R.04-06-A-200-EF-900	1.000	4	0.031	9.000	2.000	1.000	15400	1,2	XPLX 0603..	10004	
CHFC.125.R.05-06-B100-250-EF	1.250	5	0.031	4.900	2.500	1.000	10700	1,2	XPLX 0603..		32505
CHFC.125.R.05-06-A100-250-EF-900	1.250	5	0.031	9.000	2.500	1.000	10700	1,2	XPLX 0603..	12505	
CHFC.100.R.03-09-B-200-EF	1.000	3	0.039	4.300	2.000	1.000	15400	3,2	XDLX 09T3..		60003
CHFC.100.R.03-09-A-200-EF-800	1.000	3	0.039	8.000	2.000	1.000	9000	3,2	XDLX 09T3..	50003	
CHFC.125.R.04-09-B100-250-EF	1.250	4	0.039	4.800	2.500	1.000	10700	3,2	XDLX 09T3..		62504
CHFC.125.R.03-09-A-250-EF-1000	1.250	3	0.039	10.000	2.500	1.250	8100	3,2	XDLX 09T3..	52503	
CHFC.125.R.02-12-A-250-EF-1000	1.250	2	0.079	10.000	2.500	1.250	6480	5	XOLX 1204..	82502	
CHFC.150.R.03-12-A125-250-EF-1000	1.500	3	0.079	10.000	2.500	1.250	6100	5	XOLX 1204..	85003	

MaxiMill – Shell mill A HFC

▲ High Feed Cutter (HFC)

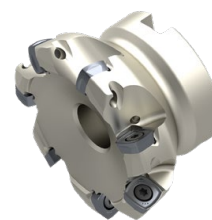
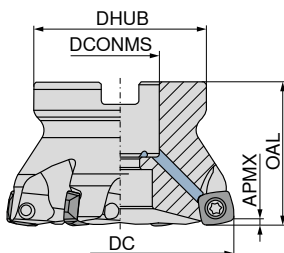
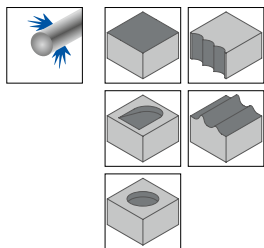

58 683 ...

Designation	DC inch	ZNF	APMX inch	OAL inch	DCONMS _{H6} inch	DHUB inch	RPMX 1/min.	torque moment Nm	Insert	
AHFC.150.R.04-09-A050-175-EF	1.500	4	0.039	1.420	0.500	1.420	26400	3,2	XDLX 09T3..	15004
AHFC.200.R.05-09-A075-175-EF	2.000	5	0.039	1.750	0.750	1.750	23500	3,2	XDLX 09T3..	20005
AHFC.250.R.06-09-A075-200-EF	2.500	6	0.039	1.750	0.750	1.750	20500	3,2	XDLX 09T3..	25006
AHFC.200.R.04-12-A075-175-EF	2.000	4	0.079	1.750	0.750	1.750	18800	5	XOLX 1204..	20104
AHFC.250.R.05-12-A100-200-EF	2.500	5	0.079	2.250	1.000	2.250	16400	5	XOLX 1204..	25105
AHFC.300.R.07-12-A100-200-EF	3.000	7	0.079	2.250	1.000	2.250	14000	5	XOLX 1204..	30107
AHFC.400.R.08-12-A125-200-EF	4.000	8	0.079	2.750	1.250	2.750	12000	5	XOLX 1204..	40108
AHFC.500.R.10-12-B150-250-EF	5.000	10	0.079	3.750	1.500	3.750	9800	5	XOLX 1204..	50110
AHFC.300.R.06-19-A100-200-EF	3.000	6	0.130	2.250	1.000	2.250	4900	5	XOLX 1906..	30206
AHFC.400.R.08-19-A125-200-EF	4.000	8	0.130	2.750	1.250	2.750	4000	5	XOLX 1906..	40208
AHFC.500.R.10-19-B150-250-EF	5.000	10	0.130	3.750	1.500	3.750	3500	5	XOLX 1906..	50210



80 950 ...



70 950 ...

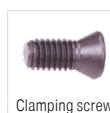

70 950 ...

Spare parts for Article no.

58 681 06202 / 58 681 07503	102	303	116
58 681 10004 / 58 681 12505	102	303	116
58 681 82502 / 58 681 85003	106	303	01200
58 681 52503 / 58 681 62504	105	303	304
58 681 50003 / 58 681 60003	105	303	110
58 681 26202 / 58 681 27503	102	303	116
58 681 30004 / 58 681 32505	102	303	116
58 682 06202 / 58 682 07503	102	303	116
58 682 10004 / 58 682 12505	102	303	116
58 683 25006 / 58 683 15004	105	303	304
58 683 40108 / 58 683 50110	106	303	01200
58 683 50210 / 58 683 40208	106	303	302
58 683 30206	106	303	302
58 683 20005	105	303	304
58 683 20104 / 58 683 25105	106	303	01200
58 683 30107	106	303	01200

XPLX / XDLX / XOLX / XOHX

Designation	IC inch	D1 inch	L inch	BS inch	S inch	AN °
XPLX 0603..	0.250	0.110	0.236	0.039	0.108	11.000
XDLX 09T3..	0.375	0.173	0.354	0.075	0.156	15.000
XO.X 1204..	0.500	0.217	0.472	0.051	0.187	10.000
XOLX 1906..	0.754	0.236	0.748	-	0.250	10.000

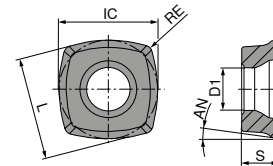

XPLX

ISO	RE inch	CTCP220	CTPP225	CTPP235	CTPM225	CTPM240	CTPM245	CTCM245
060305ER	0.020	255	055	105	205	405	455	90501
060305SR	0.020							
P		•	•	•	•	•	•	•
M				○	•	•	•	•
K				○				
N								
S								○
H								
O								

XPLX

ISO	RE inch	CTCK215	CTC5240	CTCS245
060305ER	0.020	505	558	55500
060305SR	0.020			
P				
M				
K			•	
N				
S				•
H				•
O				

XDLX

ISO	RE inch				
09T308SR	0.031		51 016 ...	51 016 ...	51 016 ...
			258	058	008
P			●	●	●
M					○
K					○
N					
S					
H					
O					

-M50
CTCP220

DRAGONSKIN



XDLX

51 016 ...

258

-M50
CTPP225

DRAGONSKIN



XDLX

51 016 ...

058

-M50
CTCP230

DRAGONSKIN



XDLX

51 016 ...

008

-M50
CTPP235

DRAGONSKIN



XDLX

51 016 ...

108

XDLX

ISO	RE inch						
09T308ER	0.031		51 016 ...	51 016 ...	51 016 ...	51 115 ...	51 016 ...
09T308SR	0.031		208	308	408	458	458
P			●	●	○	●	●
M			●	●	●	●	●
K							
N							
S							○
H							
O							

-M50
CTPM225

DRAGONSKIN



XDLX

51 016 ...

208

-M50
CTCM235

DRAGONSKIN



XDLX

51 016 ...

308

-M50
CTPM240

DRAGONSKIN



XDLX

51 016 ...

408

-F40
CTPM245

DRAGONSKIN



XDLX

51 115 ...

458

-M50
CTPM245

DRAGONSKIN



XDLX

51 016 ...

458

NEW
-M50
CTCM245

DRAGONSKIN



XDLX

51 016 ...

90801

XDLX / XOLX

ISO	RE inch	51 016 ...	51 017 ...	50 503 ...	51 115 ...
09T308ER	0.031				
09T308SR	0.031	508		558	558
190615SR	0.059		61500		

P					
M					
K		•	•		
N					
S				•	•
H					
O					

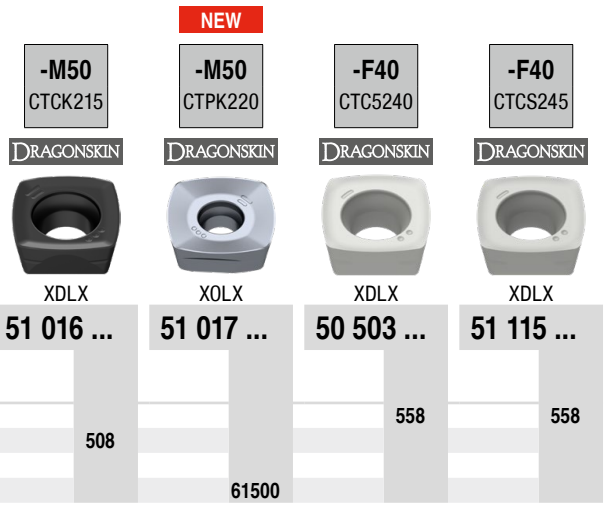

XOLX

ISO	RE inch	51 017 ...	51 017 ...	51 017 ...	51 017 ...	51 018 ...
120410SR	0.039	260	060	010	110	110

P		•	•	•	•	•
M					○	○
K				○	○	○
N						
S						
H						
O						



XOLX

		-M50 CTPM225	-M50 CTCM235	-M50 CTPM240	-F40 CTPM245	-M50 CTPM245	NEW -F40 CTCM245	NEW -M50 CTCM245
		DRAGONSKIN	DRAGONSKIN	DRAGONSKIN	DRAGONSKIN	DRAGONSKIN	DRAGONSKIN	DRAGONSKIN
		XOLX	XOLX	XOLX	XOLX	XOLX	XOLX	XOLX
		51 017 ...	51 017 ...	51 017 ...	51 022 ...	51 017 ...	51 022 ...	51 017 ...
ISO	RE							
	inch							
120410ER	0.039				460		91001	
120410SR	0.039	210	310	410		460		91001
P		•	•	○	•	•	•	•
M		•	•	•	•	•	•	•
K								
N								
S							○	○
H								
O								

XOLX / XOHX

		-M50 CTCK215	-F40 CTC5240	-F50 CTC5240	-F40 CTCS245	-F50 CTCS245
		DRAGONSKIN	DRAGONSKIN	DRAGONSKIN	DRAGONSKIN	DRAGONSKIN
		XOLX	XOLX	XOHX	XOLX	XOHX
		51 017 ...	50 504 ...	51 124 ...	51 022 ...	51 124 ...
ISO	RE					
	inch					
120410ER	0.039				560	
120410SR	0.039		510	558		56000
P						
M						
K			•			
N						
S				•	•	•
H						
O						

XOLX

ISO	RE inch				
190615ER	0.059				
190615SR	0.059				

		-M50 CTCP230	-M50 CTPP235	-M50 CTPM240	-F40 CTPM245
		DRAGONSKIN	DRAGONSKIN	DRAGONSKIN	DRAGONSKIN
		XOLX	XOLX	XOLX	XOLX
		51 017 ...	51 017 ...	51 017 ...	51 022 ...
		015	115	415	465
P		●	●	○	●
M			○	●	●
K		○	○		
N					
S					
H					
O					

XOLX

ISO	RE inch					
190615ER	0.059					
190615SR	0.059					

		NEW -F40 CTCM245	-M50 CTCK215	NEW -M50 CTPK220	-F40 CTC5240	-F40 CTCS245
		DRAGONSKIN	DRAGONSKIN	DRAGONSKIN	DRAGONSKIN	DRAGONSKIN
		XOLX	XOLX	XOLX	XOLX	XOLX
		51 022 ...	51 017 ...	51 017 ...	50 504 ...	51 022 ...
		91501	515	61500	515	56500
P		●				
M		●				
K			●	●		
N						
S		○			●	●
H						
O						

Milling guide

Cutting data standard values	→ 97-100	Machining strategy	→ 125-128
Starting Parameter	→ 125-128	Technical Information	→ 132-136
Chip groove description and overview	→ 137-139	Grade description and overview	→ 140-142

MaxiMill – Screw in cutter G 251 RS

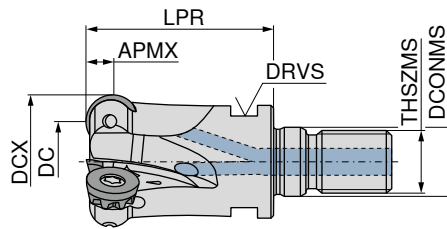
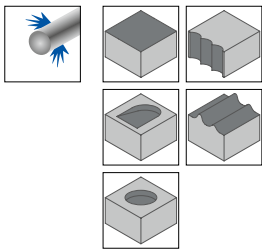

58 684 ...

Designation	DC inch	DCX inch	ZNF	APMX inch	DCONMS inch	LPR inch	THSZMS inch	RPMX 1/min.	torque moment Nm	Insert	
G251.100.R.03-10-125-RS-F	0.606	1.000	3	0.197	0.492	1.250	M12	25450	2	RP.X 10T3..	10103
G251.125.R.04-10-125-RS-F	0.856	1.250	4	0.196	0.669	1.500	M16	25450	2	RP.X 10T3..	12604
G251.150.R.05-10-175-RS-F	1.106	1.500	5	0.197	0.669	1.750	M16	15150	2	RP.X 10T3..	15105
G251.125.R.03-12-125-RS-F	0.777	1.250	3	0.236	0.492	1.575	M12	25450	3,2	RP.X 1204..	22503

MaxiMill – End milling cutter C 251 RS

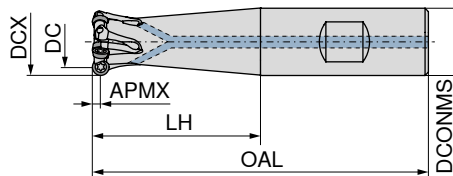
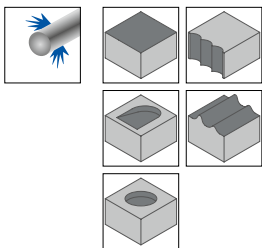

A 58 685 ... B 58 685 ...

Designation	DC inch	DCX inch	ZNF	APMX inch	OAL inch	LH inch	DCONMS inch	RPMX 1/min.	Insert	58 685 ...	58 685 ...
C251.0750.R.03-08-B-125-RS-EF	0.435	0.750	3	0.157	3.500	1.250	0.750	31800	RDHX 0802..		27503
C251.0750.R.03-08-A-200-RS-EF-800	0.435	0.750	3	0.157	8.000	2.000	0.750	22260	RDHX 0802..	07503	
C251.100.R.04-08-B-225-RS-EF	0.685	1.000	4	0.157	4.500	2.250	1.000	25450	RDHX 0802..		30004
C251.100.R.04-08-A-300-RS-EF-800	0.685	1.000	4	0.157	8.000	3.000	1.000	18000	RDHX 0802..	10004	
C251.125.R.05-08-B-275-RS-EF	0.935	1.250	5	0.157	5.250	2.750	1.250	19850	RDHX 0802..		32505
C251.125.R.05-08-A-325-RS-EF-1000	0.935	1.250	5	0.157	10.000	3.250	1.250	18000	RDHX 0802..	12505	
C251.100.R.03-10-B-225-RS-EF	0.606	1.000	3	0.197	4.500	2.250	1.000	25450	RP.X 10T3..		50003
C251.100.R.03-10-A-300-RS-EF-800	0.606	1.000	3	0.197	8.000	3.000	1.000	20000	RP.X 10T3..	40003	
C251.125.R.04-10-B-275-RS-EF	0.857	1.250	4	0.197	5.250	2.750	1.250	19850	RP.X 10T3..		52504
C251.125.R.04-10-A-325-RS-EF-1000	0.857	1.250	4	0.197	10.000	3.250	1.250	18000	RP.X 10T3..	42504	
C251.150.R.05-10-B125-325-RS-EF	1.106	1.500	5	0.197	6.000	3.250	1.250	15100	RP.X 10T3..		55005
C251.150.R.05-10-A125-375-RS-EF-1000	1.106	1.500	5	0.197	10.000	3.750	1.250	10700	RP.X 10T3..	45005	
C251.125.R.02-12-A-325-RS-EF-1000	0.778	1.250	2	0.236	10.000	3.250	1.250	8500	RP.X 1204..	62502	
C251.150.R.03-12-A125-375-RS-EF-1000	1.028	1.500	3	0.236	10.000	3.750	1.250	12500	RP.X 1204..	65003	
C251.150.R.02-16-A125-375-RS-EF-1000	0.870	1.500	2	0.315	10.000	3.750	1.250	10500	RP.X 1605..	75002	

Spare parts

Insert

RDHX 0802..	102	303	116
RP.X 10T3..	104	303	840
RP.X 10T3..		303	
RP.X 1204..	105	303	304
RP.X 1605..	106	303	01200

Screwdriver	Molykote	Clamping screw
80 950 ...	70 950 ...	70 950 ...

MaxiMill – Shell mill A 251 RS

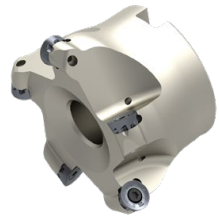
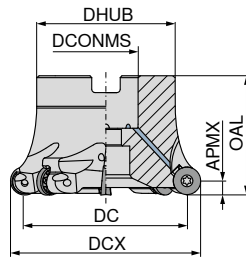
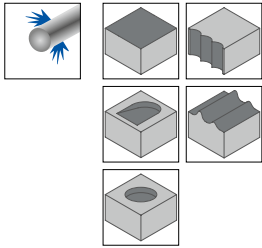



58 686 ...

Designation	DC inch	DCX inch	ZNF	APMX inch	OAL inch	DHUB inch	DCONMS _{H6} inch	RPMX 1/min.	torque moment Nm	Insert	
A251.150.R.06-08-A050-175-RS-EF	1.185	1.500	6	0.157	1.420	1.420	0.500	15150	1,2	RDHX 0802..	15006
A251.300.R.12-08-A100-200-RS-IN-EF	2.685	3.000	12	0.157	2.250	2.250	1.000	7950	1,2	RDHX 0802..	30012
A251.150.R.05-10-A050-175-RS-EF	1.106	1.500	5	0.197	1.420	1.420	0.500	15900	2	RP.X 10T3..	15105
A251.200.R.06-10-A075-175-RS-EF	1.606	2.000	6	0.197	1.750	1.750	0.750	12700	2	RP.X 10T3..	20106
A251.200.R.05-12-A075-175-RS-EF	1.528	2.000	5	0.236	1.750	1.750	0.750	12700	3,2	RP.X 1204..	20205
A251.200.R.06-12-A075-175-RS-EF	1.528	2.000	6	0.236	1.750	1.750	0.750	12700	3,2	RP.X 1204..	20206
A251.250.R.06-12-A100-200-RS-EF	2.028	2.500	6	0.236	2.250	2.250	1.000	10100	3,2	RP.X 1204..	25206
A251.300.R.07-12-RS-A100-200-EF	2.528	3.000	7	0.236	2.250	2.250	1.000	7950	3,2	RP.X 1204..	30207
A251.400.R.10-12-B125-200-RS-EF	3.528	4.000	10	0.236	2.750	2.750	1.250	6350	3,2	RP.X 1204..	40210
A251.600.R.12-12-B150-200-RS-EF	5.528	6.000	12	0.236	3.750	3.750	1.500	8300	3,2	RP.X 1204..	60212
A251.200.R.03-16-A075-175-RS-EF	1.370	2.000	3	0.315	1.750	1.750	0.750	12700	5	RP.X 1605..	20303
A251.250.R.05-16-A100-200-RS-EF	1.870	2.500	5	0.315	2.250	2.250	1.000	10100	5	RP.X 1605..	25305
A251.300.R.06-16-A100-200-RS-EF	2.370	3.000	6	0.315	2.250	2.250	1.000	7950	5	RP.X 1605..	30306
A251.400.R.07-16-B125-200-RS-EF	3.370	4.000	7	0.315	2.750	2.750	1.250	6350	5	RP.X 1605..	40307
A251.500.R.08-16-B150-200-RS-EF	4.370	5.000	8	0.315	3.750	3.750	1.500	5400	5	RP.X 1605..	50308
A251.600.R.10-16-B150-200-RS-EF	5.370	6.000	10	0.315	3.750	3.750	1.500	7200	5	RP.X 1605..	60310
A251.300.R.05-20-A100-200-RS-EF	2.213	3.000	5	0.394	2.250	2.250	1.000	8600	5	RP.X 2006..	30405
A251.400.R.06-20-A125-200-RS-EF	3.213	4.000	6	0.394	2.750	2.750	1.250	6350	5	RP.X 2006..	40406
A251.500.R.07-20-B150-200-RS-EF	4.213	5.000	7	0.394	3.750	3.750	1.500	5400	5	RP.X 2006..	50407
A251.600.R.08-20-B150-200-RS-EF	5.213	6.000	8	0.394	3.750	3.750	1.500	6500	1,2	RP.X 2006..	60408

Spare Parts Insert

RDHX 0802..	102	303	116
RP.X 10T3..	104	303	840
RP.X 1204..	105	303	304
RP.X 1605..	106	303	01200
RP.X 2006..	106	303	302

 Screwdriver	 Molykote	 Clamping screw
80 950 ...	70 950 ...	70 950 ...

RDHX / RPHX / RPNX

Designation	IC inch	D1 inch	S inch
RDHX 0501..	0.197	0.098	0.063
RDHX 0802..	0.315	0.110	0.094
RP.X 10T3..	0.394	0.134	0.156
RP.X 1204..	0.472	0.173	0.187
RP.X 1605..	0.630	0.217	0.219
RP.X 2006..	0.787	0.236	0.250

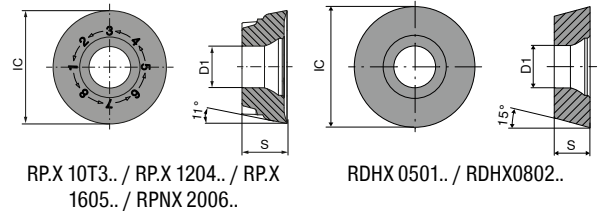

RDHX

	-SN CTCP230 DRAGONSKIN	-SN CTPP235 DRAGONSKIN	-F50 CTPM240 DRAGONSKIN	-F50 CTPM245 DRAGONSKIN	NEW -F50 CTCM245 DRAGONSKIN
	RDHX 51 048 ...	RDHX 51 048 ...	RDHX 51 083 ...	RDHX 51 083 ...	RDHX 51 083 ...
ISO					
0501M0SN	020	120		465	
0802M0SN	025	125	420	470	92001
0802M4SN				471	92101
P	•	•	○	•	•
M		○	•	•	•
K	○	○			
N					
S					○
H					
O					

RDHX

	-EN CTCK215 DRAGONSKIN	-FN H216T	-M31 CTC5240 DRAGONSKIN	-F50 CTCS245 DRAGONSKIN
	RDHX 51 048 ...	RDHX 50 481 ...	RDHX 50 481 ...	RDHX 51 083 ...
ISO				
0501M0FN		600		
0802M0EN			500	
0802M0FN		602		
0802M0SN				570
0802M4EN	520		50100	
P				
M				
K		•	○	
N			•	
S				•
H				•
O			○	

RPHX / RPNX

	-SN TCM10	-F50 CTCP230 DRAGONSKIN	-M50 CTCP230 DRAGONSKIN	-SN CTCP230 DRAGONSKIN	-SN CTCP230 DRAGONSKIN
	CERMET RPHX	RPNX	RPNX	RPHX	RPNX
	50 483 ...	51 055 ...	51 054 ...	51 052 ...	51 057 ...
ISO					
10T3M0SN	900				
10T3M8SN		020	020	020	
1204M0SN	902				
1204M8SN		025	025	025	025
1605M8SN			030	030	030
2006M8SN					035
P	●	●	●	●	●
M					
K	○	○	○	○	○
N					
S					
H					
O					

RPHX / RPNX

	-F50 CTPP235 DRAGONSKIN	-F50 CTPP235 DRAGONSKIN	-M30 CTPP235 DRAGONSKIN	-M30 CTPP235 DRAGONSKIN
	RPHX	RPNX	RPHX	RPNX
	51 051 ...	51 055 ...	51 049 ...	51 053 ...
ISO				
10T3M8EN			120	
10T3M8SN		12000	120	
1204M8SN		125	125	
1605M0SN			130	
2006M8EN				120
P	●	●	●	●
M				
K	○	○	○	○
N				
S				
H				
O				

RPNX / RPHX

	-M50 CTPP235 DRAGONSKIN RPNX 51 054 ...	-M50 CTPP235 DRAGONSKIN RPHX 51 050 ...	-SN CTPP235 DRAGONSKIN RPHX 51 052 ...	-SN CTPP235 DRAGONSKIN RPNX 51 057 ...
ISO				
10T3M8SN	12000	12000	120	
1204M8SN	125		125	125
1605M8SN	130		130	130
2006M8SN				135
P	●	●	●	●
M	○	○	○	○
K	○	○	○	○
N				
S				
H				
O				

RPHX

	-F50 CTPM225 DRAGONSKIN RPHX 51 051 ...	-M30 CTPM225 DRAGONSKIN RPHX 51 049 ...	-SN CTPM225 DRAGONSKIN RPHX 51 052 ...	-F50 CTCM235 DRAGONSKIN RPHX 51 051 ...	-M30 CTCM235 DRAGONSKIN RPHX 51 049 ...
ISO					
1204M8EN		225			325
1204M8SN	225		225	325	
P	●	●	●	●	●
M	●	●	●	●	●
K					
N					
S					
H					
O					

RPHX / RPNX

	-F50 CTPM240 DRAGONSKIN RPHX 51 051 ...	-F50 CTPM240 DRAGONSKIN RPNX 51 055 ...	-M30 CTPM240 DRAGONSKIN RPHX 51 049 ...	-M30 CTPM240 DRAGONSKIN RPNX 51 053 ...	-M50 CTPM240 DRAGONSKIN RPHX 51 050 ...
ISO					
10T3M8EN			420		420
10T3M8SN	420				
1204M8EN			425		425
1204M8SN	425				
1605M8EN			430		
1605M8SN	430				
2006M8EN				420	
2006M8SN		435			
P	○	○	○	○	○
M	●	●	●	●	●
K					
N					
S					
H					
O					

RPHX / RPNX

	CTPM245 DRAGONSKIN RPHX 51 052 ...	-F50 CTPM245 DRAGONSKIN RPHX 51 051 ...	-F50 CTPM245 DRAGONSKIN RPNX 51 055 ...	-M32 CTPM245 DRAGONSKIN RPHX 51 108 ...	-M50 CTPM245 DRAGONSKIN RPHX 51 050 ...
ISO					
10T3M4SN		470 ¹⁾	470 ¹⁾		470 ¹⁾
10T3M8SN		471	471		471
1204M4EN	475 ¹⁾			475 ¹⁾	
1204M4SN		475 ¹⁾	475 ¹⁾		475 ¹⁾
1204M6SN		476			476
1204M8SN		477	476		477
1605M8SN		480			
2006M4SN		485 ¹⁾			
2006M8SN			485		
P	●	●	●	●	●
M	●	●	●	●	●
K					
N					
S					
H					
O					

1) Insert with 4 indexes

RPNX / RPHX

	NEW -F50 CTCM245 DRAGONSKIN RPNX 51 055 ...	NEW -M50 CTCM245 DRAGONSKIN RPNX 51 054 ...	NEW -F50 CTCM245 DRAGONSKIN RPHX 51 051 ...	NEW -M50 CTCM245 DRAGONSKIN RPHX 51 050 ...
ISO				
10T3M4SN	92001 ¹⁾		92001 ¹⁾	92001 ¹⁾
10T3M8SN	92101		92101	
1204M4SN	92501 ¹⁾		92501 ¹⁾	92501 ¹⁾
1204M6SN		92601	92601	92601
1204M8SN	92601			92701
1605M8SN	93001		93001	
2006M8SN	93501	93501		
P	•	•	•	•
M	•	•	•	•
K				
N				
S	○	○	○	○
H				
O				

1) Insert with 4 indexes

RPNX / RPHX

	-R30 CTCK215 DRAGONSKIN RPNX 51 056 ...	-SN CTCK215 DRAGONSKIN RPHX 51 052 ...	-SN CTCK215 DRAGONSKIN RPNX 51 057 ...	-SN CTPK220 DRAGONSKIN RPNX 51 057 ...	-27P H216T RPHX 50 483 ...
ISO					
10T3M8EN	520				600
10T3M8FN		520		620	
10T3M8SN					
1204M8EN	525				602
1204M8FN		525	525	625	
1204M8SN					
1605M8FN		530	530	630	604
1605M8SN					
2006M8SN			535	635	
P					
M					
K	•	•	•	•	○
N					•
S					
H					
O					○

7

RPNX / RPHX

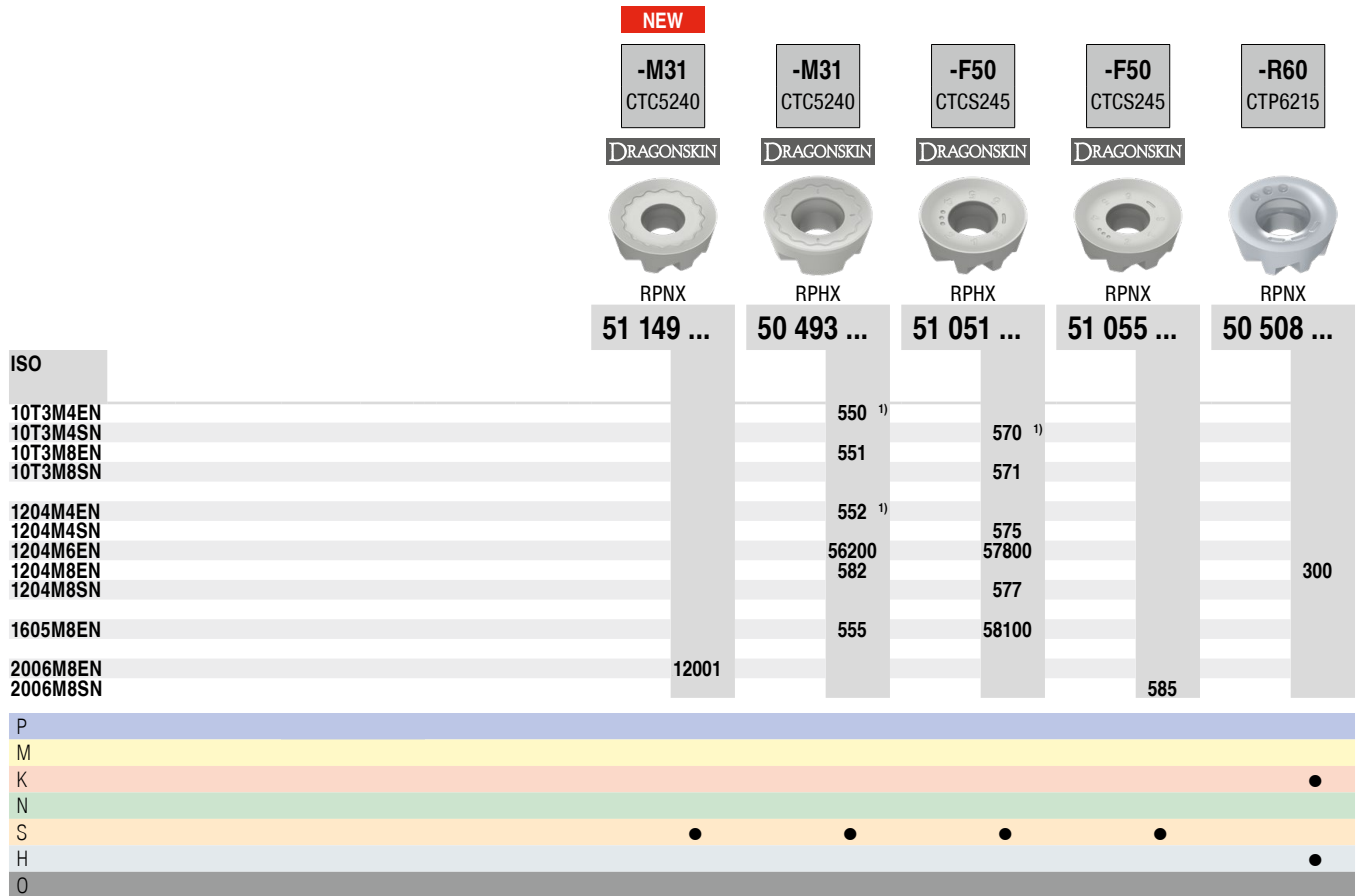

1) Insert with 4 indexes

Milling guide

Cutting data standard values	→ 97-100	Machining strategy	→ 129
Technical Information	→ 132-136	Chip groove description and overview	→ 137-139
Grade description and overview	→ 140-142		

MaxiMill – Shell mill A 252

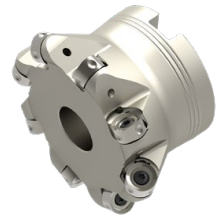
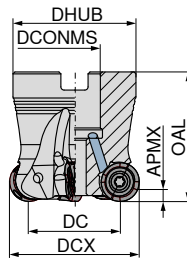
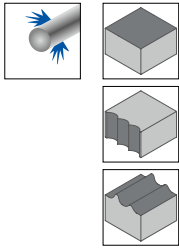

58 689 ...

Designation	DC inch	DCX inch	ZNF	APMX inch	OAL inch	DHUB inch	DCONMS inch	torque moment Nm	Insert	
A252.150.R.04-12-A050-175-EF	1.027	1.500	4	0.118	1.500	1.500	0.500	3,2	RNHU 1205..	15004
A252.200.R.05-12-A075-175-EF	1.527	2.000	5	0.118	1.750	1.750	0.750	3,2	RNHU 1205..	20005
A252.250.R.06-12-A100-200-EF	2.027	2.500	6	0.118	2.250	2.250	1.000	3,2	RNHU 1205..	25006
A252.300.R.07-12-A100-200-EF	2.527	3.000	7	0.118	2.250	2.250	1.000	3,2	RNHU 1205..	30007



80 950 ...

128



70 950 ...

303



70 950 ...

859

Spare Parts
DC
1.027 - 2.527

RNHU

Designation	IC inch	D1 inch	S inch
RNHU 1004..	0.394	0.134	0.181
RNHU 1205..	0.472	0.173	0.209

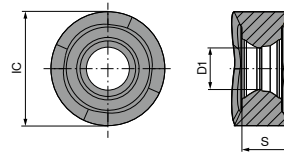

RNHU

	-M50 CTPP235	-F50 CTPM240	-M31 CTPM245	-M32 CTPM245	-M31 CTC5240	-M31 CTC5240
	DRAGONSKIN	DRAGONSKIN	DRAGONSKIN	DRAGONSKIN	DRAGONSKIN	DRAGONSKIN
	RNHU	RNHU	RNHU	RNHU	RNHU	RNHU
	51 130 ...	51 129 ...	51 106 ...	51 107 ...	50 520 ...	50 521 ...
ISO						
1004M4ER	12000	42000	470	470	550	
1205M4ER		42500	475	475		552
1205M4SR	12500					
P	●	○	●	●		
M	○	●	●	●		
K	○					
N						
S					●	●
H						
O						

Milling guide

Cutting data standard values	→ 97-100	Machining strategy	→ 130
Technical Information	→ 132+136	Chip groove description and overview	→ 137-139
Grade description and overview	→ 140-142		

MaxiMill – Combi Mill Base Holder 260

▲ Basic body with clamping wedges, without cartridges

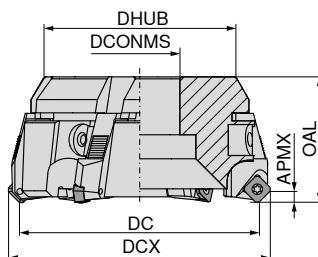
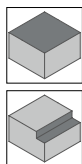

58 715 ...

DC inch	ZNF	DCONMS inch	DHUB inch	OAL inch	
3.000	5	1.000	2.449	2.449	30005
4.000	6	1.250	3.386	3.386	40006
5.000	7	1.500	3.780	3.780	50007
6.000	10	1.500	4.882	4.882	60010
8.000	12	2.500	6.772	6.772	80012
10.000	14	2.500	8.898	8.898	10014

For information on axial runout setting, see → [page 131](#)

70 950 ...	70 950 ...	70 950 ...	70 950 ...	70 950 ...
297	296	317	303	298

Spare parts
DC
3.000 - 10.000

Insert related diameter

Inserts	Nominal Ø in inches															
	3,00		4,00		5,00		6,00		8,00		10,00		12,00		16,00	
	DC inch	DCX inch	DC inch	DCX inch	DC inch	DCX inch	DC inch	DCX inch	DC inch	DCX inch	DC inch	DCX inch	DC inch	DCX inch	DC inch	DCX inch
SD.. 0903..	3,15	3,48	3,94	4,27	4,84	5,17	6,22	6,55	7,80	8,13	9,76	10,09	12,32	12,65	15,67	16,00
SD.. 1204..	3,15	3,72	3,94	4,51	4,84	5,41	6,22	6,79	7,80	8,37	9,76	10,33	12,32	12,89	15,67	16,24
SE.. 1204..	3,15	3,66	3,94	4,45	4,84	5,35	6,22	6,73	7,80	8,31	9,76	10,28	12,32	12,83	15,67	16,18
SD.. 1504..	2,95	3,70	3,74	4,49	4,65	5,39	6,02	6,77	7,60	8,35	9,57	10,31	12,13	12,87	15,47	16,22
SP.. 1204..	3,23	3,46	4,02	4,25	4,92	5,16	6,30	6,54	7,87	8,11	9,84	10,08	12,40	12,64	15,75	15,98
OA.. 0605..	3,15	3,37	3,94	4,16	4,84	5,06	6,22	6,44	7,80	8,02	9,76	9,98	12,32	12,54	15,67	15,89
RPX 1204..	3,15	3,62	3,94	4,41	4,84	5,31	6,22	6,69	7,80	8,27	9,76	10,24	12,32	12,80	15,67	16,14
RPX 16..	2,99	3,62	3,78	4,41	4,69	5,31	6,06	6,69	7,64	8,27	9,61	10,24	12,17	12,80	15,51	16,14
SD.. 1205..	3,50		4,29		5,20		6,57		8,15		10,12		12,68		16,02	
SD.. 09T3	3,50		4,29		5,20		6,57		8,15		10,12		12,68		16,02	
LD.. 1504..	3,50		4,29		5,20		6,57		8,15		10,12		12,68		16,02	
XD.T 11T3	3,50		4,29		5,20		6,57		8,15		10,12		12,68		16,02	
XD.KT 1505	3,50		4,29		5,20		6,57		8,15		10,12		12,68		16,02	
AP.. 1003..	3,50		4,29		5,20		6,57		8,15		10,12		12,68		16,02	
TPKW 2204..	3,50		4,29		5,20		6,57		8,15		10,12		12,68		16,02	

7

MaxiMill 260/combi cutter system

Cassette for inserts

Face milling			SD.. 0903..		SD.. 1204.. XD.. 1204..		SE.. 1204..		SD.. 1504..		SA.. 1706..		OA.. 0605..		
	Cartridge no.	041	031	029	032	058	057								
Article no.	70 950 ...	329	411	306	412	30800	338								
Shoulder milling			SP.. 1204..												
	Cartridge no.	018													
Article no.	70 950 ...	310													
Face/Copy milling			AP.. 1003..		LD.. 1504..		XD.T 11T3..		XD.KT 1505..		SD.. 1205..		SD.. 09T3..		TPKW 2204..
	Cartridge no.	042	051	054	056	039	055	025							
Article no.	70 950 ...	307	300	336	339	311	337	313							
Face/Copy milling		RPX 1204..		RPX 16...											
	Cartridge no.	052	053												
Article no.	70 950 ...	333	707												

Insert	APMX inch	Cassette 70 950 ...
AP.. 1003..	0.315	307
LD.. 1504..	0.551	300
OA.. 0605..	0.138	338
RPX 1204..	0.236	333
RPX 16..	0.315	707
SAKU 1706	0.331	30800
SD.. 0903..	0.157	329
SD.. 09T3..	0.315	337
SD.. 1204..	0.236	411
SD.. 1205..	0.236	311
SD.. 1504..	0.354	412
SE.. 1204..	0.236	306
SP.. 1204..	0.354	310
TPKW 2204..	0.709	313
XD.T 11T3	0.394	336
XD.KT 1505..	0.551	339



Spare parts Insert

Insert	80 950 ...	80 950 ...	70 950 ...	70 950 ...	80 950 ...
AP.. 1003..	033	110	303	112	191
OA.. 0605..	037	114	303	302	193
RPX 1204.. / LD.. 1504..	036	113	303	304	192
SD.. 0903..	033	110	303	115	191
SD.. 09T3..	036	113	303	110	192
SD.. 1204.. / SE.. 1204.. / SP.. 1204.. / SD.. 1205.. / SD.. 1504.. / RPX 16.. / TPKW 2204..	037	114	303	280	193
XD.T.. 11T3..	043	125	303	131	191
XD.KT 1505..	054	128	303	839	192

Insert countersink 90°

Supply details:

Indexable insert countersink including clamping screws

WPS

NEW

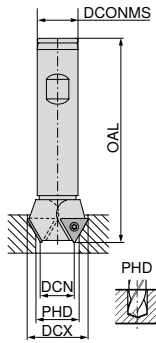

58 196 ...

DCX inch	DCN inch	PHD inch	ZEFP	ZNF	DCONMS inch	OAL inch	Insert	
0.748	0.276	0.374	2	2	0.625	3.940	TOHX 090204	19000
0.906	0.433	0.472	2	2	0.625	3.940	TOHX 090204	23000
1.024	0.433	0.472	1	2	0.625	3.940	TOHX 090204	26000
1.181	0.472	0.472	2	2	0.750	3.940	TOHX 140305	30000
1.339	0.630	0.669	2	2	0.750	3.940	TOHX 140305	34000
1.457	0.748	0.787	2	2	0.750	3.940	TOHX 140305	37000

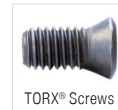

TORX® Screws

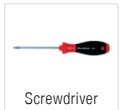

Screwdriver

62 950 ...

80 950 ...

Spare parts

DCX

0.748 - 1.024	09900	125
1.181 - 1.457	12600	127

TOHX

Designation	L inch	S inch	D1 inch	IC inch
140305EN	0.536	0.118	0.150	0.323

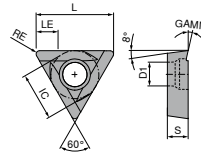

TOHX

	NEW	NEW	NEW
	-G06 BK8425	-U877 BK8425	-G12 BK8425
	F TOHX	F TOHX	F TOHX
	62 602 ...	62 604 ...	62 603 ...
	33000	31400	31400

ISO	RE inch
090204EN	0.016
140305EN	0.020

P	•	•	•
M	•	•	•
K	•	•	•
N	•	•	•
S	•	•	•
H	○	○	○
O			

TOHX

	NEW	NEW
	-U877 K10	-G12 K10
	F TOHX	F TOHX
	62 604 ...	62 603 ...
	51400	51600 52800

ISO	RE inch
090204EN	0.016
090204FN	0.016
140305FN	0.020

P			
M			
K			
N		•	•
S		•	•
H			
O		•	•

Material examples for cutting data tables

	Material sub-group	Index	Composition / Structure / Heat treatment	Tensile strength lbf/in ² / HB / HRC	Material number	Material designation	Material number	Material designation
P	Unalloyed steel	P.1.1	< 0.15 % C Annealed	60900 lbf/in ² / 125 HB	1.0401	1015	1.0301	1010
		P.1.2	< 0.45 % C Annealed	92800 lbf/in ² / 190 HB	1.1191	1045	1.0737	12L14
		P.1.3	< 0.45 % C Tempered	121800 lbf/in ² / 250 HB	1.1191	1045	1.0503	1043
		P.1.4	< 0.75 % C Annealed	132000 lbf/in ² / 270 HB	1.1223	1060	1.0535	1055
		P.1.5	< 0.75 % C Tempered	146500 lbf/in ² / 300 HB	1.1223	1060	1.1274	1095
	Low-alloy steel	P.2.1	Annealed	88500 lbf/in ² / 180 HB	1.7131	5115	1.6523	8620
		P.2.2	Tempered	134900 lbf/in ² / 275 HB	1.7131	5115	1.6582	4340
		P.2.3	Tempered	146500 lbf/in ² / 300 HB	1.7225	4142	1.7131	5115
		P.2.4	Tempered	174000 lbf/in ² / 375 HB	1.7225	4142	1.7223	4140
	High-alloy steel and high-alloy tool steel	P.3.1	Annealed	98600 lbf/in ² / 200 HB	1.4021	420	1.2379	D2
		P.3.2	Hardened and tempered	159500 lbf/in ² / 300 HB	1.2343	H11	1.3343	M2
		P.3.3	Hardened and tempered	188500 lbf/in ² / 400 HB	1.2343	H11	1.2363	A2
	Stainless steel	P.4.1	Ferritic / martensitic Annealed	98600 lbf/in ² / 200 HB	1.4016	430	1.4125	440C
		P.4.2	Martensitic Tempered	117500 lbf/in ² / 250 HB	1.4112	S44003	1.4021	420
M	Stainless steel	M.1.1	Austenitic / austenitic-ferritic Quenched	88500 lbf/in ² / 200 HB	1.4301	304	1.4401	316
		M.2.1	Austenitic Tempered	300 HB	1.4841	314	1.4568	17-7 PH
		M.3.1	Austenitic / ferritic (Duplex)	113100 lbf/in ² / 230 HB	1.4462	S32205	1.4410	S32750
K	Grey cast iron	K.1.1	Pearlitic / ferritic	88500 lbf/in ² / 180 HB	0.6010	A48-20B	0.6025	A48-40 B
		K.1.2	Pearlitic (martensitic)	127600 lbf/in ² / 260 HB	0.6030	A48-45B	0.6040	A48-60 B
	Spherulitic graphite cast iron	K.2.1	Ferritic	78300 lbf/in ² / 160 HB	0.7040	60-40-18	0.7050	65-45-12
		K.2.2	Pearlitic	122600 lbf/in ² / 250 HB	0.7070	100-70-03	0.7660	A439 Type D2
	Malleable iron	K.3.1	Ferritic	63800 lbf/in ² / 130 HB	0.8035	GTW-35-04		
		K.3.2	Pearlitic	113100 lbf/in ² / 230 HB	0.8170	70003		
N	Aluminium wrought alloy	N.1.1	Non-hardenable	60 HB	3.0255	A91060	3.0255	A91060
		N.1.2	Hardenable	49300 lbf/in ² / 100 HB	3.1355	2024	3.1355	2024
	Cast aluminium alloy	N.2.1	≤ 12 % Si, non-hardenable	36300 lbf/in ² / 75 HB	3.2581	A04130 / A413-0	3.2581	A04130 / A413-0
		N.2.2	≤ 12 % Si, hardenable	43500 lbf/in ² / 90 HB	3.2134	G-AISI5Cu1Mg		
		N.2.3	> 12 % Si, non-hardenable	63800 lbf/in ² / 130 HB		G-AISI17Cu4Mg		
	Copper and copper alloys (bronze/brass)	N.3.1	Free-machining alloys, PB > 1 %	54400 lbf/in ² / 110 HB	2.0380	CuZn39Pb2 (Ms58)	2.0380	C37700
		N.3.2	CuZn, CuSnZn	43500 lbf/in ² / 90 HB	2.0331	CuZn15	2.0331	C34000
		N.3.3	CuSn, lead-free copper and electrolytic copper	49300 lbf/in ² / 100 HB	2.0060	E-Cu57		
	Magnesium alloys	N.4.1	Magnesium and magnesium alloys	70 HB	3.5612	MgAl6Zn		
	S	Heat-resistant alloys	S.1.1	Fe - basis Annealed	98600 lbf/in ² / 200 HB	1.4864	X12NiCrSi 36-16	1.4864
S.1.2			Fe - basis	137800 lbf/in ² / 280 HB	1.4980	X6NiCrTiMoVB25-15-2	1.4980	S66286
S.2.1			Ni or Co basis Annealed	121800 lbf/in ² / 250 HB	2.4856	Inconel 625	2.4812	Hastelloy C
S.2.2			Ni or Co basis	171100 lbf/in ² / 350 HB	2.4952	Nimonic 80A	2.4668	Inconel 718
S.2.3			Ni or Co basis Cast	156600 lbf/in ² / 320 HB	2.4674	Nimocast PK24	2.4670	Nimocast 713
Titanium alloys		S.3.1	Pure titanium	5800 lbf/in ²	3.7025	Ti99,8		
		S.3.2	Alpha + beta alloys	152300 lbf/in ²	3.7165	TiAl6V4		
		S.3.3	Beta alloys	203100 lbf/in ² / 410 HB	Ti555.3	Ti-5Al-5V-5Mo-3Cr		
H	Hardened steel	H.1.1	Hardened and tempered	46-55 HRC				
		H.1.2	Hardened and tempered	56-60 HRC				
		H.1.3	Hardened and tempered	61-65 HRC				
		H.1.4	Hardened and tempered	66-70 HRC				
	Chilled iron	H.2.1	Cast	400 HB				
	Hardened cast iron	H.3.1	Hardened and tempered	55 HRC				
O	Non-metal materials	O.1.1	Plastics, duroplastic	≤ 21800 lbf/in ²				
		O.1.2	Plastics, thermoplastic	≤ 14500 lbf/in ²				
		O.2.1	Aramid fibre-reinforced	≤ 145000 lbf/in ²				
		O.2.2	Glass/carbon-fibre reinforced	≤ 145000 lbf/in ²				
		O.3.1	Graphite					

* Tensile Strength at Rupture (Rm)

Cutting data standard values

Cutting Material hard (v _c ↑) → tough (v _c ↓)																
Index	DRAGONSKIN		DRAGONSKIN		DRAGONSKIN		DRAGONSKIN		DRAGONSKIN		DRAGONSKIN		DRAGONSKIN		DRAGONSKIN	
	CERMET		CERMET		CTCP220		CTPP225		CTCP230		CTPP231		CTPP235		CTPP236	
	CTEP210	CTEP210	TCM10	TCM10	CTCP220	CTCP220	CTPP225	CTPP225	CTCP230	CTCP230	CTPP231	CTPP231	CTPP235	CTPP235	CTPP236	CTPP236
P.1.1	1130		960		1120	560	870	520	940	500	660	330	810	450	990	590
P.1.2	1000		850		1020	510	770	470	800	440	560	300	690	400	890	530
P.1.3	870		740		920	460	680	430	670	390	460	260	570	350	740	430
P.1.4	820		710		890	450	650	410	620	370	560	300	530	330	890	530
P.1.5	760		650		840	420	610	390	560	350	530	300	470	310	790	460
P.2.1	1020		870		1030	520	790	480	820	450	560	300	700	410	890	530
P.2.2	810		700		880	440	650	410	610	370	430	230	520	330	660	400
P.2.3	760		650		840	420	610	390	560	350	560	300	470	310	890	530
P.2.4	600		520		730	360	500	340	390	280	400	200	320	250	590	360
P.3.1					460	230	430	210	460	290	560	300	400	320	890	530
P.3.2					310	170	330	170	300	180	460	260	360	270	590	460
P.3.3					170	100	230	120	130	70	400	230	320	230	500	400
P.4.1					460	230	430	210	460	290	460	260	400	320	590	460
P.4.2					390	200	380	190	380	230	430	230	380	300	560	430
M.1.1											560	300	400	320	890	530
M.2.1													360	270		
M.3.1													390	310		
K.1.1									1020	630	1190	300			500	360
K.1.2	990		790						530	330	1190	300			500	360
K.2.1	1160		920						660	400	760	560			500	360
K.2.2	990		790						430	260	530	360			500	360
K.3.1	990		790						630	380	690	530				
K.3.2									530	330	690	530				
N.1.1																
N.1.2																
N.2.1													500	360		
N.2.2													500	360		
N.2.3													500	360		
N.3.1													500	360		
N.3.2																
N.3.3																
N.4.1																
S.1.1																
S.1.2																
S.2.1																
S.2.2																
S.2.3																
S.3.1																
S.3.2																
S.3.3																
H.1.1																
H.1.2																
H.1.3																
H.1.4																
H.2.1																
H.3.1																
O.1.1																
O.1.2																
O.2.1																
O.2.2																
O.3.1																

The cutting data is strongly influenced by external conditions, such as the stability of the tool and workpiece clamping, material and type of machine. The specified values represent guideline cutting data that can be adjusted by approx. ±20% according to the usage conditions.

Cutting data standard values

Cutting Material hard (v _c ↑) → tough (v _c ↓)																
Index	DRAGONSKIN		DRAGONSKIN		DRAGONSKIN		DRAGONSKIN		DRAGONSKIN		DRAGONSKIN		CERAMIC		CBN	
	CTPM225		CTCM235		CTPM240		CTPM241		CTPM245		CTCM245		CTN3105		CTL3215	
P.1.1	900	630	830	610	750	470	660	330	800	460	920	440				
P.1.2	760	540	690	500	620	420	560	300	680	410	800	390				
P.1.3	640	450	570	410	500	370	460	230	570	360	680	340				
P.1.4	600	430	530	370	460	350	560	300	530	340	650	330				
P.1.5	530	380	470	330	400	330	500	260	480	320	590	300				
P.2.1	780	550	710	520	640	420	560	300	700	420	820	400				
P.2.2	580	420	520	370	450	350	400	200	520	340	640	320				
P.2.3	530	380	470	330	400	330	560	300	480	320	590	300				
P.2.4	380	280	310	210	260	270	360	200	330	260	450	240				
P.3.1	490	400	450	380	410	350	690	330	510	350	580	400				
P.3.2	400	330	420	360	370	310	590	330	470	310	540	360				
P.3.3	310	270	400	350	320	280	530	300	430	260	500	310				
P.4.1	490	400	450	380	410	350	460	300	510	350	580	400				
P.4.2	440	370	440	370	390	330	430	260	490	330	560	380				
M.1.1	490	400	450	380	410	350	690	330	510	350	580	400				
M.2.1	400	330	420	360	370	310	590	300	470	310	540	360				
M.3.1	460	380	440	380	400	340	690	330	500	340	570	390				
K.1.1													2640		2640	
K.1.2													1980		1980	
K.2.1																
K.2.2															1490	
K.3.1																
K.3.2																
N.1.1																
N.1.2																
N.2.1																
N.2.2																
N.2.3																
N.3.1																
N.3.2																
N.3.3																
N.4.1																
S.1.1								200				260				
S.1.2								200				230				
S.2.1								200				120				
S.2.2								200				80				
S.2.3								200				100				
S.3.1								200								
S.3.2								200								
S.3.3								200								
H.1.1																
H.1.2															500	
H.1.3																
H.1.4																
H.2.1															920	
H.3.1																
O.1.1																
O.1.2																
O.2.1																
O.2.2																
O.3.1																

The cutting data is strongly influenced by external conditions, such as the stability of the tool and workpiece clamping, material and type of machine. The specified values represent guideline cutting data that can be adjusted by approx. ±20% according to the usage conditions.

Cutting data standard values

Cutting Material hard (v _c ↑) → tough (v _c ↓)																		
Index	DRAGONSKIN		DRAGONSKIN		DRAGONSKIN		AMZ		H216T		CTWN215		CTC5240		CTCS245		CTP6215	
	CTCK215		CTPK220		CTPK221													
P.1.1					630	400												
P.1.2					590	330												
P.1.3					500	260												
P.1.4					590	330												
P.1.5					560	300												
P.2.1					590	330												
P.2.2					460	260												
P.2.3					590	330												
P.2.4					430	260												
P.3.1					690	400												
P.3.2					530	300												
P.3.3					430	260												
P.4.1					690	400												
P.4.2					630	330												
M.1.1																		
M.2.1																		
M.3.1																		
K.1.1	1190	690	1060	630	890	660	660		430	430	430	430					920	830
K.1.2	730	430	560	330	890	660	530		360	360	360	360					630	530
K.2.1	760	460	690	430	830	590	610		430	430	430	430					590	500
K.2.2	530	330	460	300	590	400	500		400	400	400	400					590	500
K.3.1	830	500	660	400	730	560	660		430	430	430	430					830	730
K.3.2	690	430	560	330	730	560	580		360	360	360	400					630	530
N.1.1								4950	4950	4950								
N.1.2								3300	3300	3300								
N.2.1								3960	3630	3630								
N.2.2								3960	3300	3300								
N.2.3								990	920	920								
N.3.1								1160	1160	1160								
N.3.2								1160	1160	1160								
N.3.3								1060	1060	1060								
N.4.1								1060	1060	1060								
S.1.1													260		210			
S.1.2													230		180			
S.2.1													120		90			
S.2.2													80		70			
S.2.3													100		80			
S.3.1													260		210			
S.3.2													170		130			
S.3.3													130		110			
H.1.1																	170	
H.1.2																	130	
H.1.3																		
H.1.4																		
H.2.1																		
H.3.1																		
O.1.1								530	530	530	530	530						
O.1.2																		
O.2.1								590	790	790	790	790						
O.2.2																		
O.3.1																		

The cutting data is strongly influenced by external conditions, such as the stability of the tool and workpiece clamping, material and type of machine. The specified values represent guideline cutting data that can be adjusted by approx. ±20% according to the usage conditions.

System MaxiMill 274-04/-09

Machining strategy

Helical plunge milling

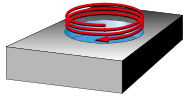

D_{max} in inch = largest diameter for flat bottom hole
 D_{min} in inch = smallest hole diameter for flat bottom surface
 D_M = $D_{max} - DCX$ and $D_{min} - DCX$

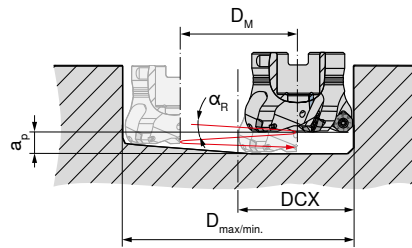

OF..04

DCX inch	D_{max} inch	D_{min} inch	α_{Rmax} °
1.01	1.77	1.54	2.3
1.21	2.17	1.93	1.9
1.48	2.72	2.48	1.4
1.80	3.35	3.11	1.2
2.19	4.13	3.90	0.9
2.70	5.16	4.92	0.7
3.37	6.50	6.26	0.6
4.16	8.07	7.83	0.5
5.15	10.04	9.80	0.4

SF..09

DCX inch	D_{max} inch	D_{min} inch	α_{Rmax} °
1.08	1.77	1.65	1.9
1.28	2.17	2.05	1.5
1.54	2.72	2.60	1.1
1.87	3.35	3.23	0.9
2.27	4.13	4.02	0.7
2.78	5.16	5.04	0.5
3.44	6.50	6.38	0.4
4.23	8.07	7.95	0.3
5.22	10.04	9.92	0.3

Axial plunging

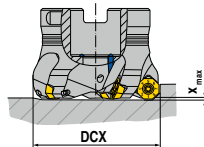
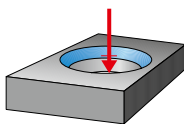

OF..04

DCX inch	X_{max} inch
1.01	0.10
1.21	0.10
1.48	0.10
1.80	0.10
2.19	0.10
2.70	0.10
3.37	0.10
4.16	0.10
5.15	0.10

SF..09

DCX inch	X_{max} inch
1.08	0.15
1.28	0.14
1.54	0.13
1.87	0.12
2.27	0.12
2.78	0.12
3.44	0.11
4.23	0.11
5.22	0.11

Angled ramping

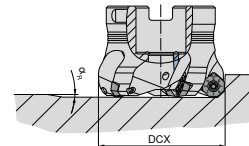
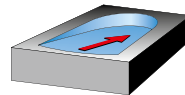

OF..04

DCX inch	α_{Rmax} °
1.01	14.2
1.21	9.5
1.48	6.5
1.80	4.7
2.19	3.5
2.70	2.7
3.37	2.0
4.16	1.6
5.15	1.2

SF..09

DCX inch	α_{Rmax} °
1.08	20.4
1.28	13.0
1.54	8.0
1.87	5.8
2.27	4.3
2.78	3.2
3.44	2.3
4.23	1.7
5.22	1.3

System MaxiMill 274-04

Starting Parameter

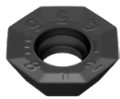

OF.. 04

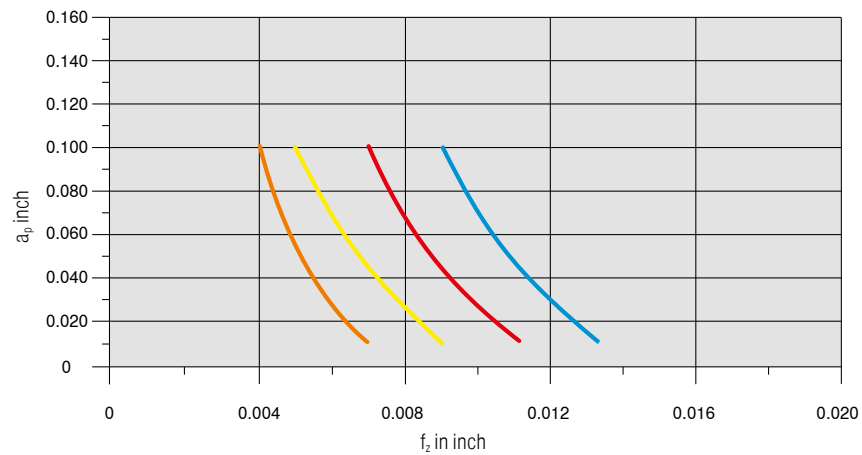

Material			Inserts		v_c in ft/min	Cooling
Steel	P.4.1	P20	OFHT040305SN-M50	CTPP235	660	Dry
Stainless steel	M.1.1	316Ti	OFHT040305SN-F50	CTPM240	600	Dry
Cast iron	K.1.1	GG25 Cast Iron	OFHT040305SN-M50	CTCK215	825	Dry
Heat-resistant	S.2.2	Inconel 718	OFHT040305SN-F50	CTC5240	115	Emulsion

System MaxiMill 274-09

Starting Parameter

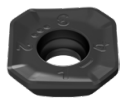

SF.. 09

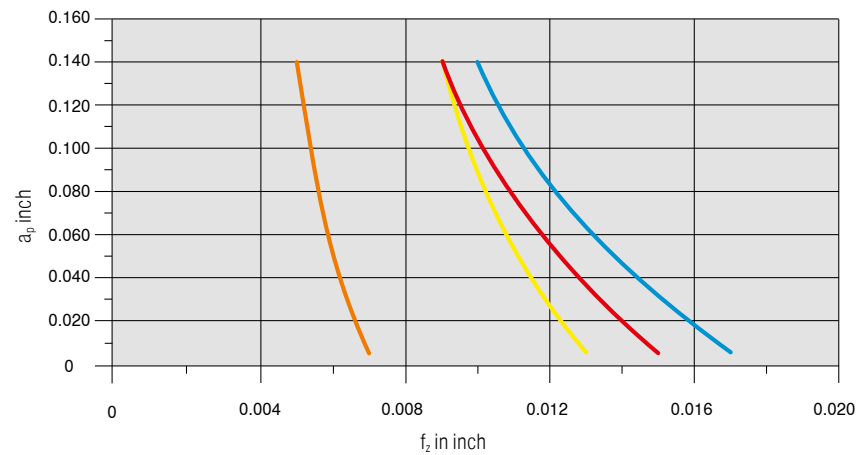

Material			Inserts		v_c in ft/min	Cooling
Steel	P.4.1	P20	SFKT0903AFSR-M50	CTPP235	660	Dry
Stainless steel	M.1.1	316Ti	SFHT0903AFSR-F50	CTPM240	600	Dry
Cast iron	K.1.1	GG25 Cast Iron	SFKT0903AFSR-R50	CTCK215	825	Dry
Heat-resistant	S.2.2	Inconel 718	SFHT0903AFSR-F50	CTC5240	115	Emulsion

Detailed information on cutting speed for each grade can be found on → page 98–100
From $v_c > 1300$ SFM, the tool must be balanced!

System MaxiMill 274-05/-12

Machining strategy

Helical plunge milling

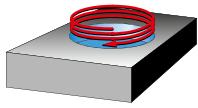

D_{max} in inch = largest diameter for flat bottom hole
 D_{min} in inch = smallest hole diameter for flat bottom surface
 D_M = $D_{max} - DCX$ and $D_{min} - DCX$

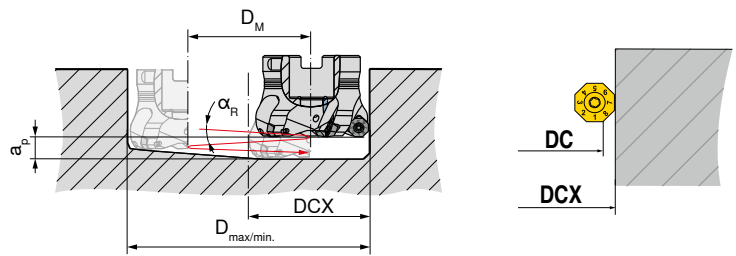

OF..05

DC inch	DCX inch	D_{max} inch	D_{min} inch	$\alpha_{R,max}$ °
1.97	2.28	4.21	3.90	1.1
2.48	2.80	5.24	4.92	0.9
3.15	3.46	6.57	6.26	0.7
3.94	4.25	8.15	7.83	0.5
4.92	5.23	10.12	9.80	0.4

SF..12

DC inch	DCX inch	D_{max} inch	D_{min} inch	$\alpha_{R,max}$ °
1.85	2.40	4.21	4.13	0.5
2.36	2.91	5.24	5.16	0.4
3.03	3.58	6.57	6.50	0.3
3.81	4.37	8.15	8.07	0.25
4.80	5.35	10.12	10.04	0.2

Axial plunging

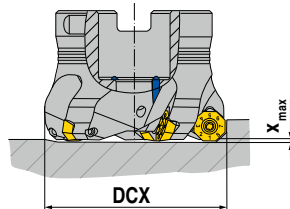
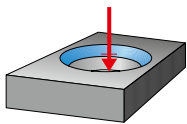

OF..05

DC inch	DCX inch	X_{max} inch
1.97	2.28	0.09
2.48	2.80	0.07
3.15	3.46	0.07
3.94	4.25	0.04
4.92	5.23	0.06

SF..12

DC inch	DCX inch	X_{max} inch
1.85	2.40	0.13
2.36	2.91	0.13
3.03	3.58	0.12
3.81	4.37	0.10
4.80	5.35	0.10

Angled ramping

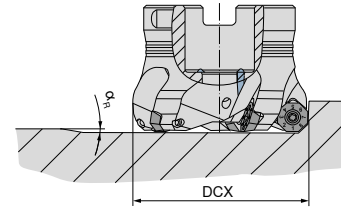
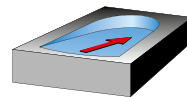

OF..05

DC inch	DCX inch	$\alpha_{R,max}$ °
1.97	2.28	3.2
2.48	2.80	2.0
3.15	3.46	1.5
3.94	4.25	0.7
4.92	5.23	0.7

SF..12

DC inch	DCX inch	$\alpha_{R,max}$ °
1.85	2.40	4.9
2.36	2.91	3.4
3.03	3.58	2.4
3.81	4.37	1.6
4.80	5.35	1.3

System MaxiMill 274-05

Starting Parameter



OF.. 05

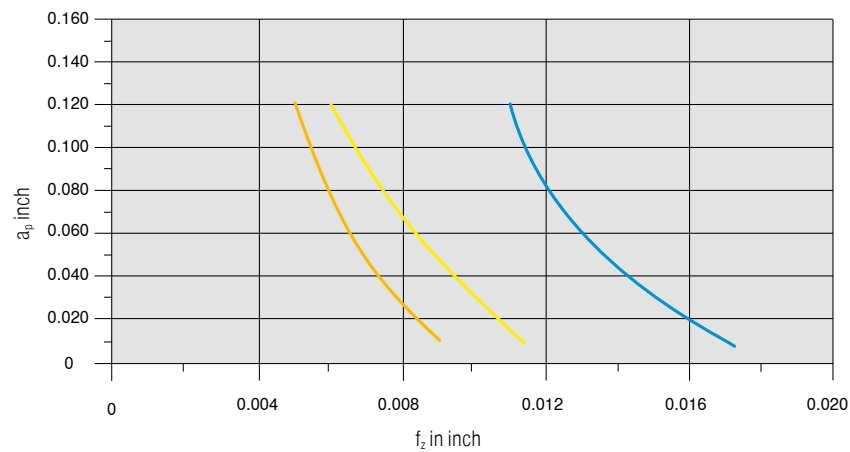

Material			Inserts		v_c in ft/min	Cooling
Steel	P.4.1	P20	OFHT050410SN-M50	CTCP230	660	Dry
Stainless steel	M.1.1	316Ti	OFHT050410SN-F50	CTPM240	600	Dry
Heat-resistant	S.2.2	Inconel 718	OFHT050410SN-F50	CTC5240	115	Emulsion

System MaxiMill 274-12

Starting Parameter

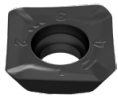

SF.. 12

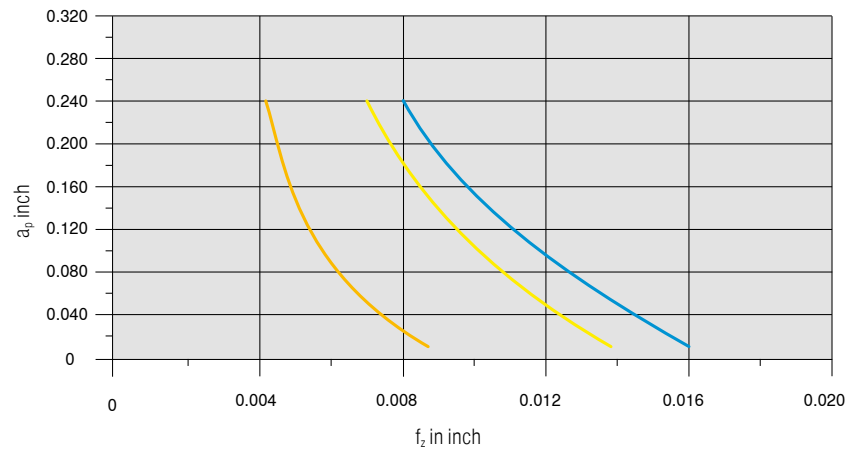

Material			Inserts		v_c in ft/min	Cooling
Steel	P.4.1	P20	SFKT1204AFSR-M50	CTPP235	660	Dry
Stainless steel	M.1.1	316Ti	SFKT1204AFSR-M50	CTPM240	600	Dry
Heat-resistant	S.2.2	Inconel 718	SFHT1204AFER-F40	CTC5240	115	Emulsion



Detailed information on cutting speed for each grade can be found on → page **98-100**

From $v_c > 1300$ SFM, the tool must be balanced!

MaxiMill 271-12 system

Starting Parameter

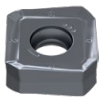

SOHU 12

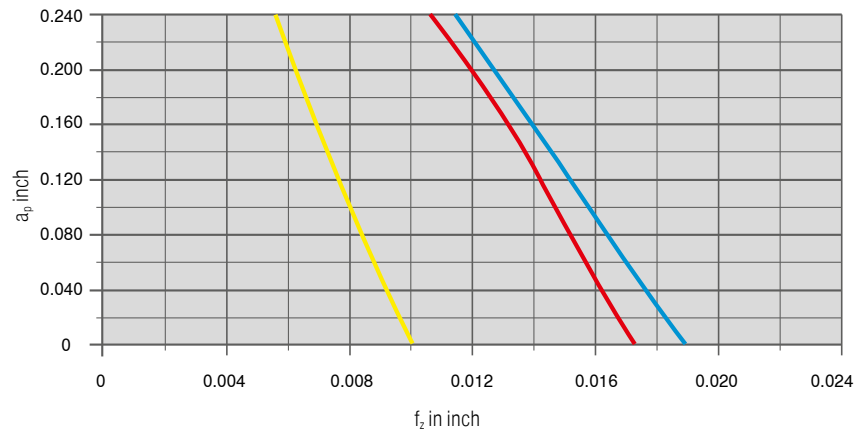

Material			Inserts		v_c in ft/min	Cooling
Steel	P.4.1	P20	SOHU 1204ABSR-M50	CTPP230	660	Dry
Stainless steel	M.1.1	316Ti	SOHU 1204ABSR	CTPM240	600	Dry
Cast iron	K.1.1	GG25 Cast Iron	SOHU 1204ABSR-R50	CTCK215	990	Dry
Heat-resistant	S.2.2	Inconel 718	SOHU 1204ABSR-F50	CTC5240	115	Emulsion

System MaxiMill 271-17

Starting Parameter

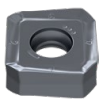

SAKU 17

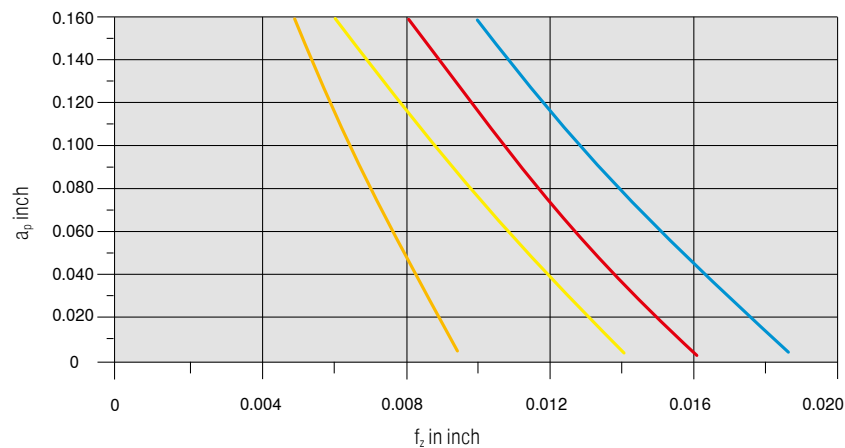

Material			Inserts		v_c in ft/min	Cooling
Steel	P.4.1	P20	SAKU 1706ABSR-M50	CTPP235	660	Dry
Stainless steel	M.1.1	316Ti	SAKU 1706ABSR-F50	CTPM240	600	Dry
Cast iron	K.1.1	GG25 Cast Iron	SAKU 1706ABSR-R50	CTCK215	990	Dry
Heat-resistant	S.2.2	Inconel 718	SAKU 1706ABSR-F50	CTC5240	115	Emulsion

7

Detailed information on cutting speed for each grade can be found on → page 98–100
From $v_c > 1300$ SFM, the tool must be balanced!

MaxiMill 273 system

Starting Parameter



OAKU

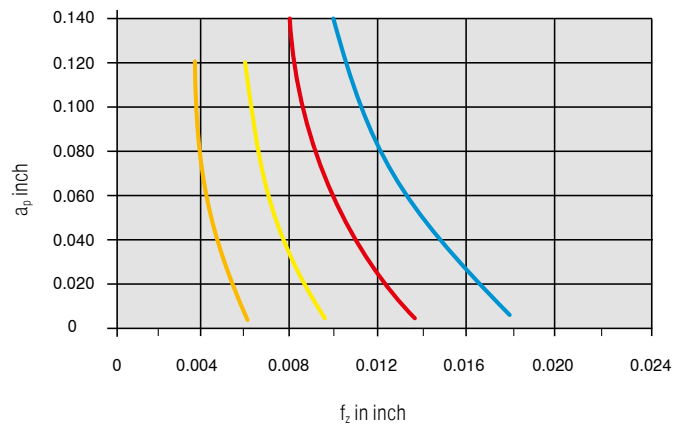

Material		Inserts		v_c in ft/min	Cooling
Steel	P.4.1 P20	OAKU 060508SR-M50	CTPP235	660	Dry
Stainless steel	M.1.1 316Ti	OAKU 060508SR-F50	CTPM240	600	Dry
Cast iron	K.1.1 GG25 Cast Iron	OAKU 060508SR-R50	CTCK215	990	Dry
Heat-resistant	S.2.2 Inconel 718	OAKU 060508ER-F40	CTC5240	115	Emulsion

i Detailed information on cutting speed for each grade can be found on → page **98-100**

From $v_c > 1300$ SFM, the tool must be balanced!

MaxiMill 270 system

Machining strategy

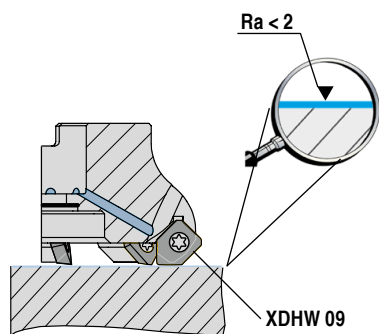

Finish milling with wiper inserts

Two wiper inserts are mounted in each 5.000" head



Steel	SDNT 0903AESN-29	CTPP235	+	XDHW 0903AESN	CTPP235
	SDNT 0903AESN-29	CTCP230	+	XDHW 0903AESN	CTCP230
	SDHT 0903AESN-33	CTCP230	+	XDHW 0903AESN	CTCP230
	SDHW 0903AESN	TCM10	+	XDHW 0903AESN	TCM10
Cast iron	SDNT 0903AESN-31	CTCK215	+	XDHW 0903AEEN	CTCK215
Non-ferrous metals	SDHT 0903AEFN-ALP	-27P H216T	+	XDHW 0903AEFN	-27P H216T

Helical plunge milling (without start hole)

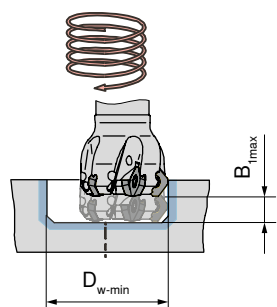

C 270-09

DC inch	D _{w-min} inch	B _{1-max} inch	D _{w-max} inch	B _{2-max} inch
0.25	0.57	0.06	0.75	0.06
0.50	1.12	0.06	1.22	0.06
0.63	1.44	0.06	1.54	0.06
0.75	1.75	0.06	1.85	0.06
1.00	2.15	0.06	2.24	0.06
1.25	2.70	0.06	2.80	0.06

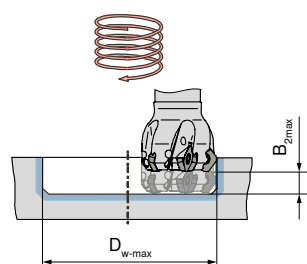

A 270-09

DC inch	D _{w-min} inch	B _{1-max} inch	D _{w-max} inch	B _{2-max} inch
1.25	2.70	0.06	2.80	0.06
1.50	3.33	0.06	3.43	0.06
2.00	4.11	0.06	4.21	0.06
2.50	5.14	0.06	5.24	0.06
3.00	6.48	0.06	6.57	0.06
4.00	8.05	0.06	8.15	0.06
5.00	10.02	0.06	10.12	0.06
6.00	12.78	0.06	12.87	0.06

System MaxiMill 270-12

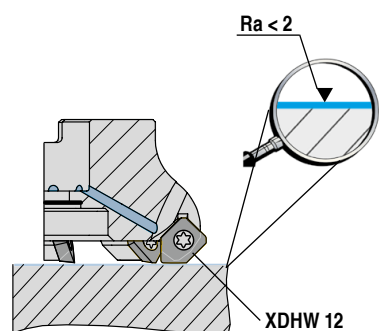

Finish milling with wiper inserts

Two wiper inserts are mounted in each 5.000" head



Steel	SDMT 1204AESN-29R	CTPP235	+	XDHW 1204AESN	CTPP235
	SDMT 1204AESN-29R	CTCP230	+	XDHW 1204AESN	CTCP230
	SDHW 1204AESN-R	TCM10	+	XDHW 1204AESN	TCM10
Cast iron	SDMT 1204AEEN-31	CTCK215	+	XDHW 1204AEEN	CTCK215
	SDHW 1204AESN-R	CTCK215	+	XDHW 1204AEEN	CTCK215
Non-ferrous metals	SDHT 1204AEFN-ALP	-27P H216T	+	XDHW 1204AEFN	-27P H216T

Helical plunge milling (without start hole)

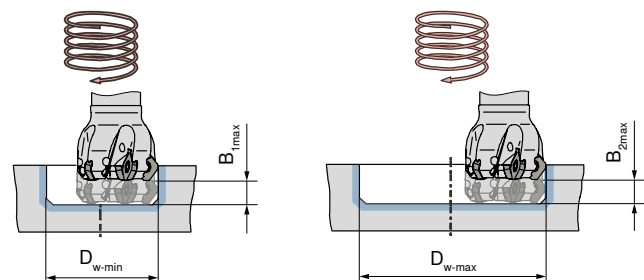

DC inch	D _{w-min} inch	B _{1-max} inch	D _{w-max} inch	B _{2-max} inch
1.25	2.93	0.06	3.07	0.06
1.50	3.56	0.06	3.70	0.06
2.00	4.35	0.06	4.49	0.06
2.50	5.37	0.06	5.51	0.06
3.00	6.71	0.06	6.85	0.06
4.00	8.29	0.06	8.43	0.06
5.00	10.26	0.06	10.39	0.06
6.00	13.01	0.06	13.15	0.06

From v_c > 1300 SFM, the tool must be balanced!

MaxiMill HEC 11 / HEC 12 system

4 cutting edges per installation position

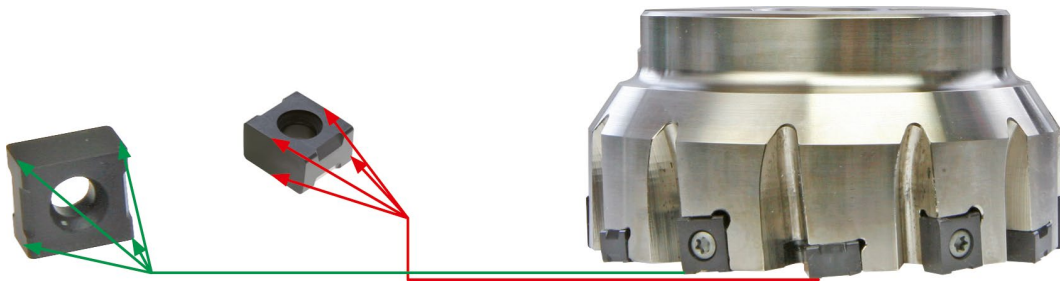

Correct assembly of standard and wiper inserts

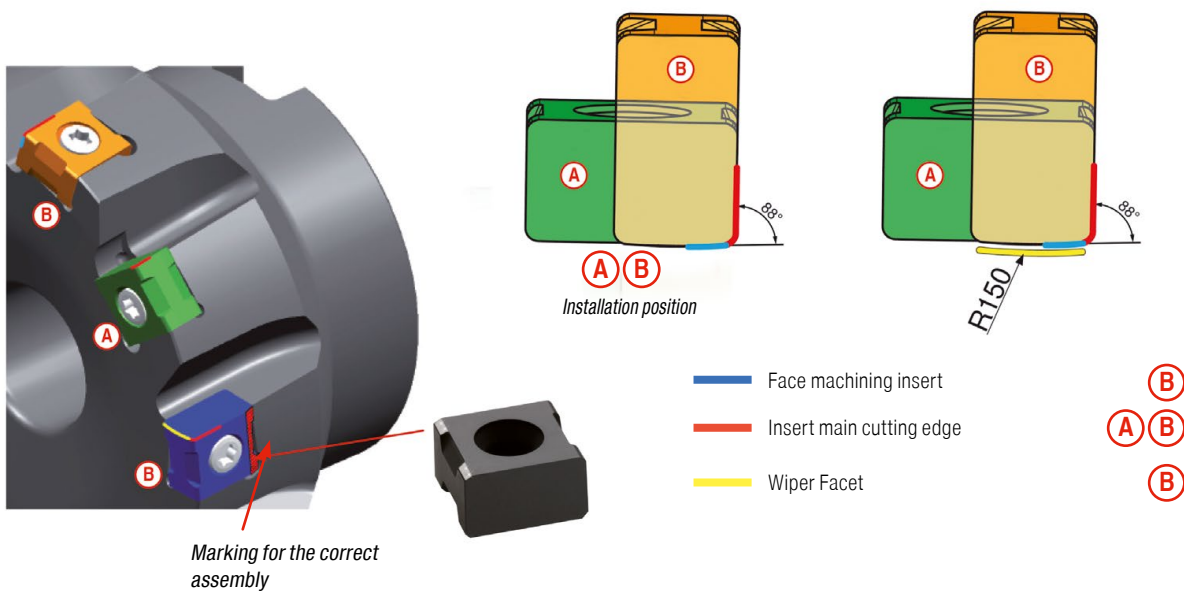

Adjust the tools in axial direction

- ▲ Install the wedge into the cutter body and lightly clamp the clamping screw so as not to clamp.
- ▲ Install the inserts as shown and tighten to 1,0 Nm torque.
- ▲ Using pre-setting equipment, mark the highest cutting edge.
- ▲ With small adjustments of the setting screw set all cutting edges to the same height by 0.0002" or better.
- ▲ Clamp insert with 3,2 Nm torque.

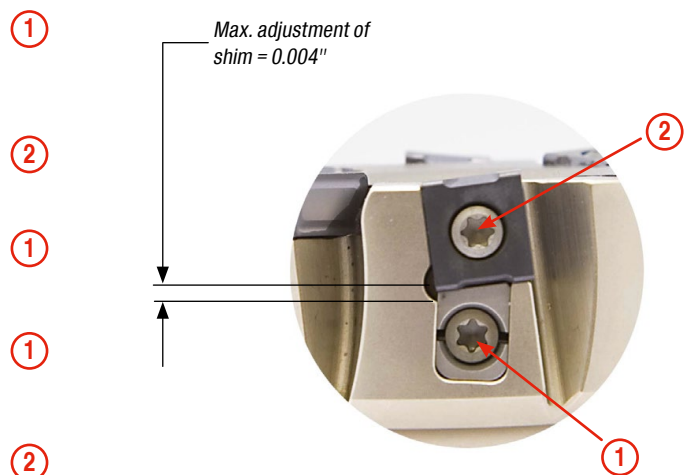

Average chip thickness [h_m] – the approach

Face milling

1 Select appropriate average chip thickness [h_m] for the steel from the table.

Material	Tensile strength N/mm ²	h _m inch
for steel	...-800	0.008
for steel	800-1000	0.007
for steel	1000-1200	0.006
for steel	1200-...	0.006
for stainless steel	... -750	0.008
for stainless steel	750-900	0.007
for stainless steel	900-1150	0.007
for stainless steel	1150- ...	0.006

2 Select the corrected feed rate value from the table based on the appropriate chip thickness [h_m] and depth of cut [a_e].

h _m inch	Corrected feed value f _z for h _m			
	0.012 x DC	0.016 x DC	0.030 x DC	0.040 x DC
0.008	0.016 **	0.016 **	0.013	0.011
0.007	0.016 **	0.016 **	0.011	0.010
0.006	0.016 **	0.014	0.010	0.009
0.006	0.014	0.012	0.009	0.008
0.008	0.016 **	0.016 **	0.013	0.012
0.007	0.016 **	0.016 **	0.012	0.011
0.007	0.016 **	0.015	0.011	0.009
0.006	0.015	0.013	0.009	0.008
a _e =	0.012 x DC	0.016 x DC	0.030 x DC	0.040 x DC

** f_z > 0,016": Danger of an open space contact

MaxiMill 491-09 system

Starting Parameter



SNHU 09

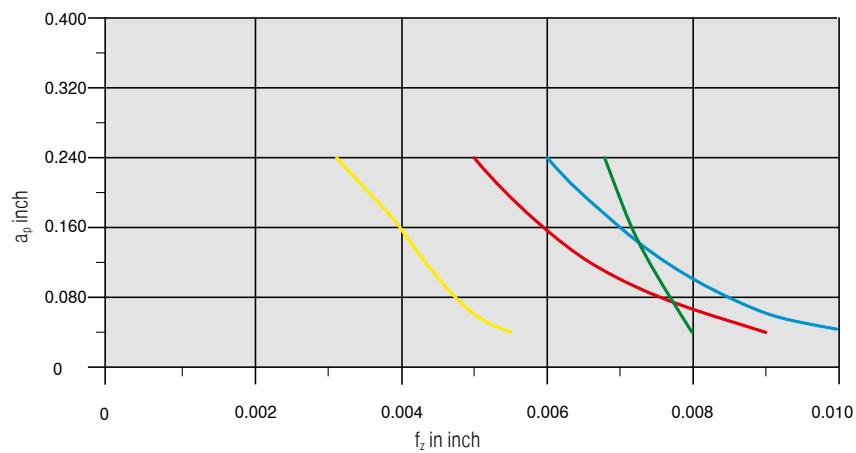

Material			Inserts		v_c in ft/min	Cooling
Steel	P.4.1	P20	SNHU09T308SR-M50	CTPP235	660	Dry
Stainless steel	M.1.1	316Ti	SNHU09T308SR-F50	CTPM240	600	Dry
Cast iron	K.1.1	GG25 Cast Iron	SNHU09T308SR-R50	CTCK215	825	Dry
Non-ferrous metals	N.1.2	Aluminum	SNHU09T308FR-F10	CTWN215	1650	Emulsion

MaxiMill 491-12 system

Starting Parameter



SNHU 12

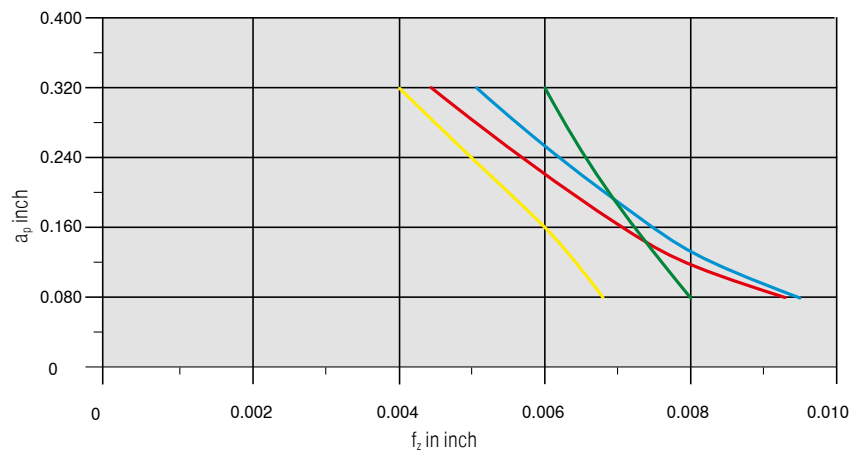

Material			Inserts		v_c in ft/min	Cooling
Steel	P.4.1	P20	SNHU120408SR-M50	CTPP235	660	Dry
Stainless steel	M.1.1	316Ti	SNHU120408SR-F50	CTPM240	600	Dry
Cast iron	K.1.1	GG25 Cast Iron	SNHU120408SR-R50	CTCK215	825	Dry
Non-ferrous metals	N.1.2	Aluminum	SNHU120408FR-F10	CTC5240	1650	Emulsion

Detailed information on cutting speed for each grade can be found on → page 98–100
From $v_c > 1300$ SFM, the tool must be balanced!

System MaxiMill 211-07

Machining strategy

Helical plunge milling

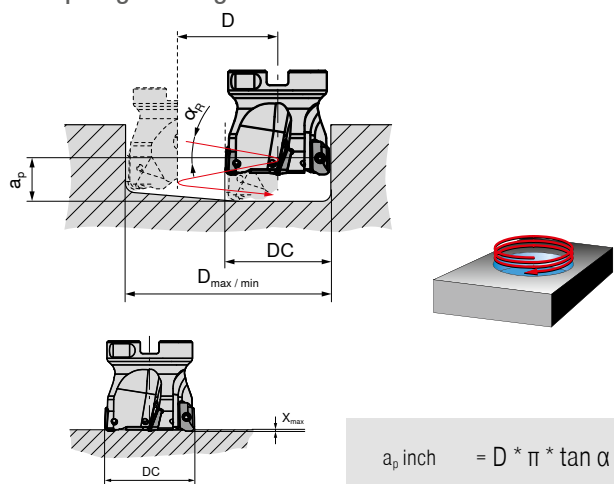

DC inch	D _{max} / RE 0.4 inch	D _{min} inch	α _{R max} °
0.39	0.75	0.51	5.5
0.50	0.91	0.67	6.0
0.63	1.22	0.98	3.0
0.75	1.54	1.30	2.0
1.00	1.93	1.69	1.5
1.25	2.48	2.24	1.2
1.50	3.11	2.87	0.8
2.00	3.90	3.66	0.7

DC inch	D inch	α _{R max 360°} °
0.39	0.51	5.5
0.50	0.67	6.0
0.63	0.98	3.0
0.75	1.30	2.0
1.00	1.69	1.5
1.25	2.24	1.2
1.50	2.87	0.8
2.00	3.66	0.7

$$a_p \text{ inch} = D * \pi * \tan \alpha_R$$

Axial plunging

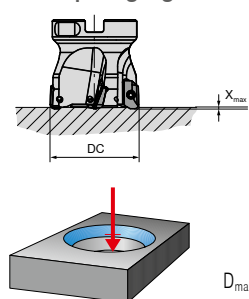

DC inch	X _{max} inch
0.39	0.03
0.50	0.03
0.63	0.03
0.75	0.03
1.00	0.03
1.25	0.03
1.50	0.03
2.00	0.03

D_{max} in inch = largest diameter for flat bottom hole
D_{min} in inch = smallest hole diameter for flat bottom surface

Angled ramping

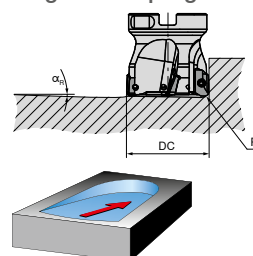

DC inch	α °
0.39	11.0
0.50	7.9
0.63	4.3
0.75	3.0
1.00	2.5
1.25	1.6
1.50	1.2
2.00	1.0

$$D = D_{max} - DC / D_{min} - DC$$

Starting Parameter

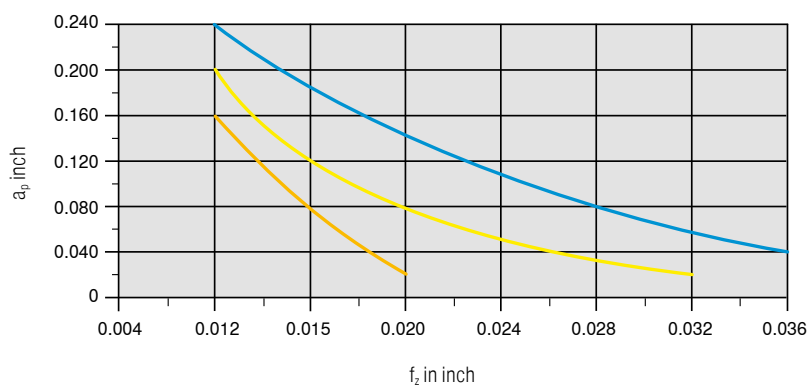
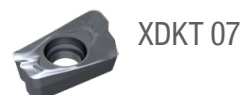

Material		Inserts		v _c in ft/min	Cooling
Steel	P.4.1 P20	XDKT070308SR-M50	CTCP230	660	Dry
Stainless steel	M.1.1 316Ti	XDKT070308SR-F50	CTPM240	600	Dry
Heat-resistant	S.2.2 Inconel 718	XDKT070308ER-F50	CTC5240	115	Emulsion

Detailed information on cutting speed for each grade can be found on → page 98-100
From v_c > 1300 SFM, the tool must be balanced!

System MaxiMill 211-11

Machining strategy

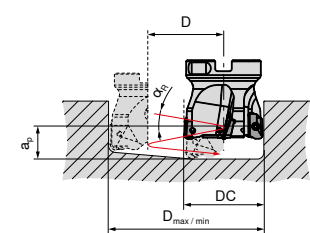

① Helical plunge milling

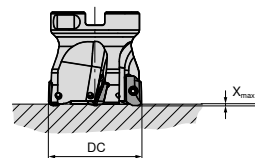
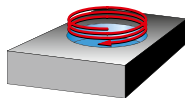

② Axial plunging

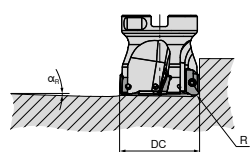
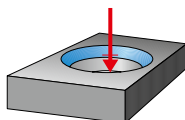

③ Angled ramping

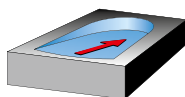

① ② ③

DC inch	Helical plunge milling		Axial plunging	Angled ramping
	RE = 0.032"		X _{max}	α _R
0.50	α _R	16 °	0.056"	18 °
	D _{max.}	0.83"		
	D _{min.}	0.55"		
0.63	α _R	9.5 °	0.060"	10.8 °
	D _{max.}	1.14"		
	D _{min.}	0.83"		
0.75	α _R	7 °	0.080"	9.8 °
	D _{max.}	1.45"		
	D _{min.}	1.18"		
1.00	α _R	4.5 °	0.080"	7.5 °
	D _{max.}	1.85"		
	D _{min.}	1.57"		
1.25	α _R	3.2 °	0.040"	4.8 °
	D _{max.}	2.40"		
	D _{min.}	2.08"		
1.50	α _R	2.2 °	0.064"	2.9 °
	D _{max.}	3.03"		
	D _{min.}	2.83"		
2.00	α _R	1.7 °	0.064"	2.2 °
	D _{max.}	3.85"		
	D _{min.}	3.66"		
2.50	α _R	1.5 °	0.064"	1.8 °
	D _{max.}	4.84"		
	D _{min.}	4.57"		
3.00	α _R	1.0 °	0.064"	1.4 °
	D _{max.}	6.18"		
	D _{min.}	6.03"		
4.00	α _R	0.8 °	0.064"	1.1 °
	D _{max.}	4.21"		
	D _{min.}	3.97"		

DC inch	Maximum speed related to projection length				
	n _{max} in min ⁻¹				
	l _a = 1-2 x Ø inch	l _a = 2.5 x Ø inch	l _a = 3 x Ø inch	l _a = 4 x Ø inch	l _a = 5 x Ø inch
0.50	55000	51500	47000	42000	37000
0.63	42000	38500	34100	28900	24200
0.75	36900	33000	28500	23900	19500
1.00	33200	29000	24400	19900	15400
1.25	30200	26000	20900	16600	11900
1.50	27700	23000	18000	13500	9000
2.00	25400	20400	15400	10800	6100
2.50	23300	18300	12900	8300	3700
3.00	21300	16100	10600	5800	
4.00	19600	14100	8400		

D_{max.} in inch = largest diameter for flat bottom hole

D_{min.} in inch = Smallest diameter for flat bottom surface

a_p inch = D x π x tan(α_n) = Pitch

l_a in mm = Overhang length

Starting Parameter

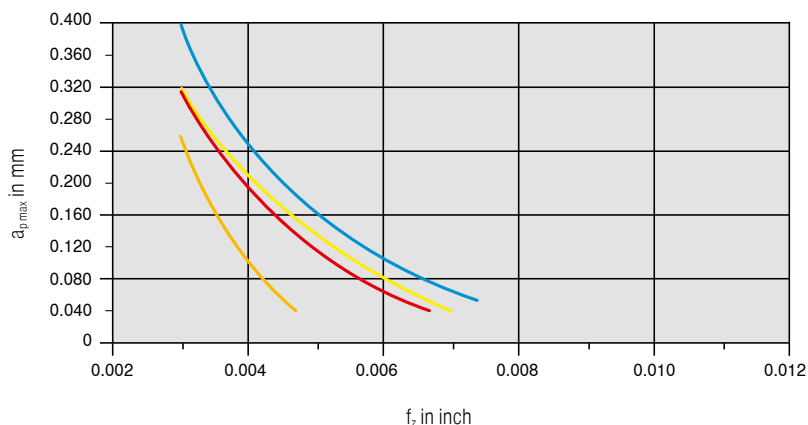

Material	Inserts		v _c in ft/min	Cooling		
Steel	P.4.1	P20	XDKT11T308SR-M50	CTCP230	660	Dry
Stainless steel	M.1.1	316Ti	XDKT11T308SR-F50	CTPM240	600	Dry
Cast iron	K.1.1	GG25 Cast Iron	XDKT11T308SR-R50	CTCK215	825	Dry
Heat-resistant	S.2.2	Inconel 718	XDKT11T308ER-F50	CTC5240	115	Emulsion

① Detailed information on cutting speed for each grade can be found on → page 98-100

From v_c > 1300 SFM, the tool must be balanced!

System MaxiMill 211-15

Machining strategy

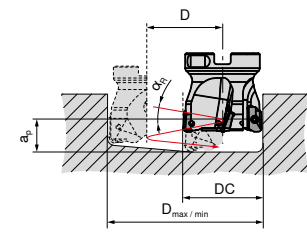

① Helical plunge milling

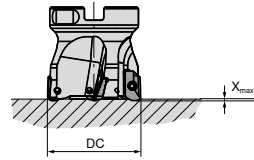
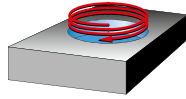

② Axial plunging

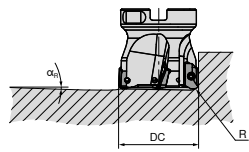
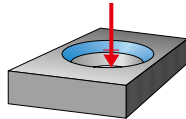

③ Angled ramping

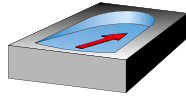

① ② ③

DC inch	Helical plunge milling		Axial plunging	Angled ramping
	RE = 0.032"		X _{max}	α _R
1.00	α _R	7.5 °	0.108"	9.5 °
	D _{max.}	1.89"		
	D _{min.}	1.45"		
1.25	α _R	5 °	0.060"	6.8 °
	D _{max.}	2.44"		
	D _{min.}	1.85"		
1.50	α _R	3.2 °	0.060"	5.1 °
	D _{max.}	3.07"		
	D _{min.}	2.48"		
2.00	α _R	2.5 °	0.060"	2.5 °
	D _{max.}	3.86"		
	D _{min.}	3.38"		
2.50	α _R	1.5 °	0.060"	2.5 °
	D _{max.}	4.88"		
	D _{min.}	4.37"		
3.00	α _R	1.3 °	0.060"	2.0 °
	D _{max.}	6.22"		
	D _{min.}	5.78"		
4.00	α _R	1.1 °	0.060"	1.5 °
	D _{max.}	7.80"		
	D _{min.}	7.48"		
5.00	α _R	0.9 °	0.060"	0.9 °
	D _{max.}	9.76"		
	D _{min.}	9.45"		
6.00	α _R	0.6 °	0.060"	0.7 °
	D _{max.}	12.52"		
	D _{min.}	12.20"		
8.00	α _R	0.8 °	0.064"	1.1 °
	D _{max.}	4.21"		
	D _{min.}	3.97"		

DC inch	n _{max} in min ⁻¹		
	l _a = 2 x Ø inch	l _a = 3 x Ø inch	l _a = 5 x Ø inch
1.00	26560	19520	13320
1.25	24160	16720	9520
1.50	22160	14400	7200
2.00	20320	12320	4880
2.50	18640	10320	2960
3.00	17040	8480	
4.00	15680	6720	
5.00	14320		
6.00	13200		

D_{max.} in inch = largest diameter for flat bottom hole
 D_{min.} in inch = Smallest diameter for flat bottom surface
 a_p inch = D x π x tan(α_R) = Pitch
 l_a in mm = Overhang length

Starting Parameter

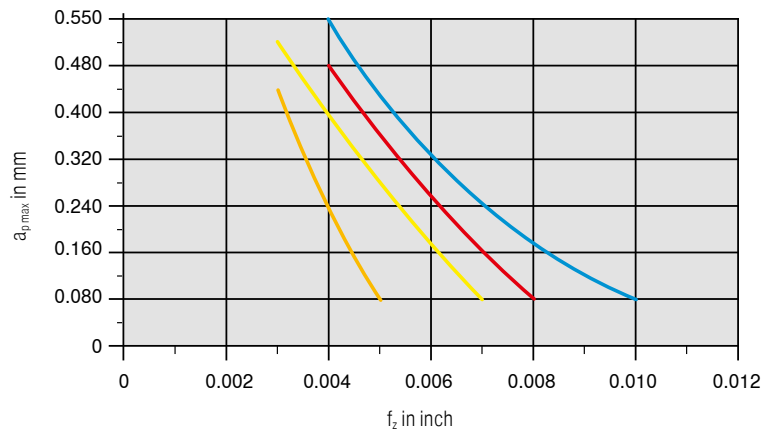

Material	Inserts		v _c in ft/min	Cooling
Steel	P.4.1 P20	XDKT150508SR-M50 CTCP230	660	Dry
Stainless steel	M.1.1 316Ti	XDKT150508SR-F50 CTPM240	600	Dry
Cast iron	K.1.1 GG25 Cast Iron	XDKT150508SR-R50 CTCK215	825	Dry
Heat-resistant	S.2.2 Inconel 718	XDKT150508ER-F40 CTC5240	115	Emulsion

① Detailed information on cutting speed for each grade can be found on → page 98-100
 From v_c > 1300 SFM, the tool must be balanced!

System MaxiMill 211-20

Machining strategy

Helical plunge milling

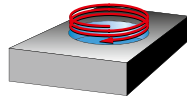
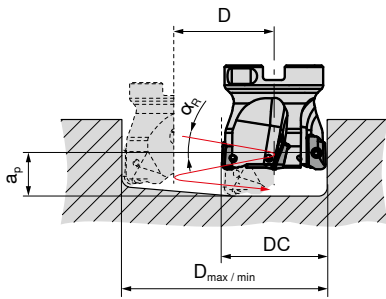

DC inch	D _{max} / RE 0.016 inch	D _{min} inch	α _{R max} °
2.50	4.882	4.213	2.2
3.00	6.220	5.630	1.7
4.00	7.795	7.205	1.3

$$a_p \text{ inch} = D * \pi * \tan \alpha_R$$

Axial plunging

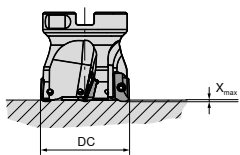

DC inch	X _{max} inch
2.50	0.100
3.00	0.100
4.00	0.100

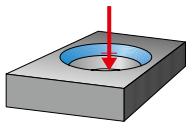

Angled ramping

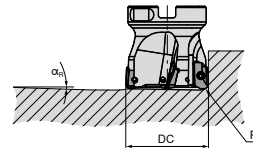

DC inch	α °
2.50	2.2
3.00	1.7
4.00	1.3

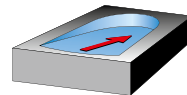

$$D = D_{max} - DC / D_{min} - DC$$

D_{max} in inch = largest diameter for flat bottom hole

D_{min} in inch = smallest hole diameter for flat bottom surface

Starting Parameter

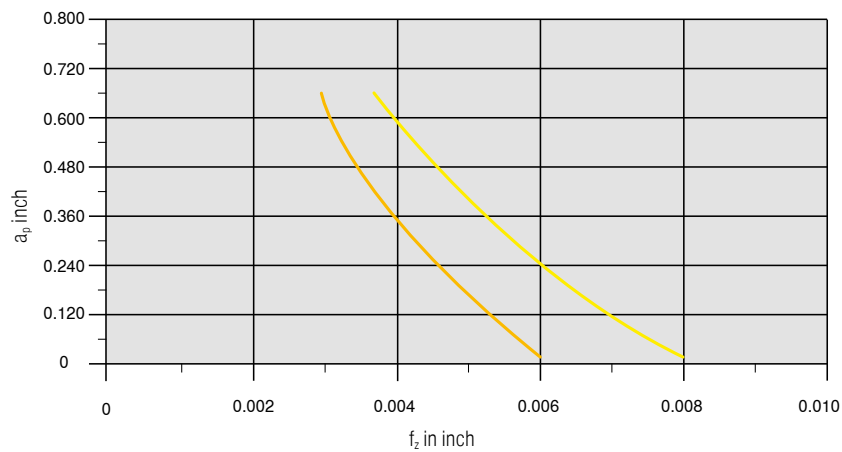
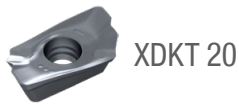

Material			Inserts		v _c in ft/min	Cooling
Stainless steel	M.1.1	316Ti	XDKT200708ER-F40	CTPM240	600	Dry
Heat-resistant	S.2.2	Inconel 718	XDKT200708ER-F40	CTC5240	115	Emulsion



Detailed information on cutting speed for each grade can be found on → page 98–100

From v_c > 1300 SFM, the tool must be balanced!

System MaxiMill 490-09

Machining strategy

 System MaxiMill 490-09 is not suitable for plunging!

Starting Parameter



SDNT 09

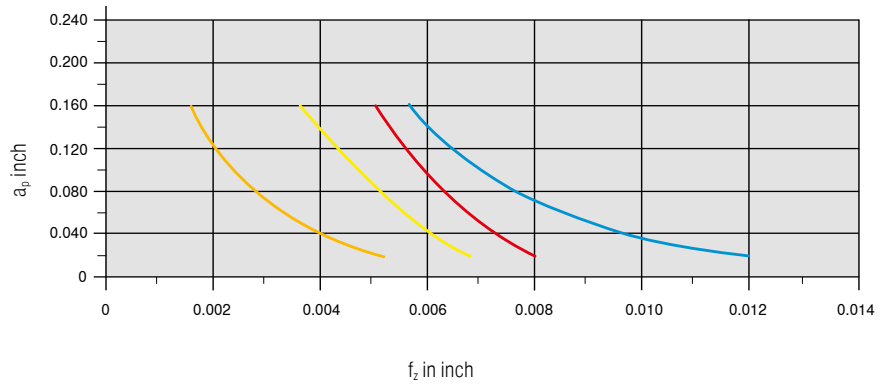

Material			Inserts		v _c in ft/min	Cooling
Steel	P.4.1	P20	SDNT09T308SR-29	CTCP230	660	Dry
Stainless steel	M.1.1	316Ti	SDNT09T308SR-33	CTPM240	600	Dry
Cast iron	K.1.1	GG25 Cast Iron	SDNT09T308SR-31	CTCK215	825	Dry
Heat-resistant	S.2.2	Inconel 718	SDNT09T308ER-M31	CTC5240	115	Emulsion

 Detailed information on cutting speed for each grade can be found on → page **98-100**

System MaxiMill 490-12

Machining strategy

Helical plunge milling (without start hole)

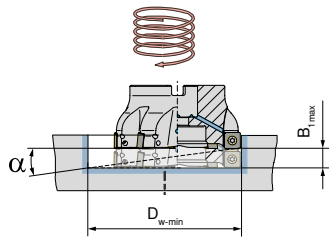

$$B = (D_w - DC) \times \pi \times \tan \alpha$$

D_w = Diameter of the hole to be produced
 DC = Nominal diameter of the milling tool
 B = Axial feed to 360° circular movement

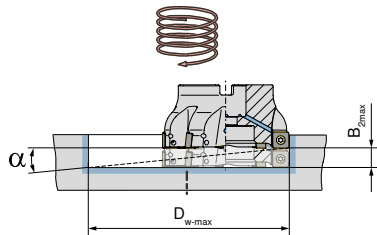

DC inch	D_{w-min} inch	B_{1max} inch	D_{w-max} inch	B_{2max} inch	α °
2.00	3.031	0.098	3.858	0.189	2,0
2.50	4.055	0.071	4.882	0.118	1,0
3.00	5.394	0.083	6.220	0.118	0,8
4.00	6.969	0.083	7.795	0.114	0,6
5.00	8.937	0.071	9.764	0.094	0,4

Starting Parameter



SDMT 12

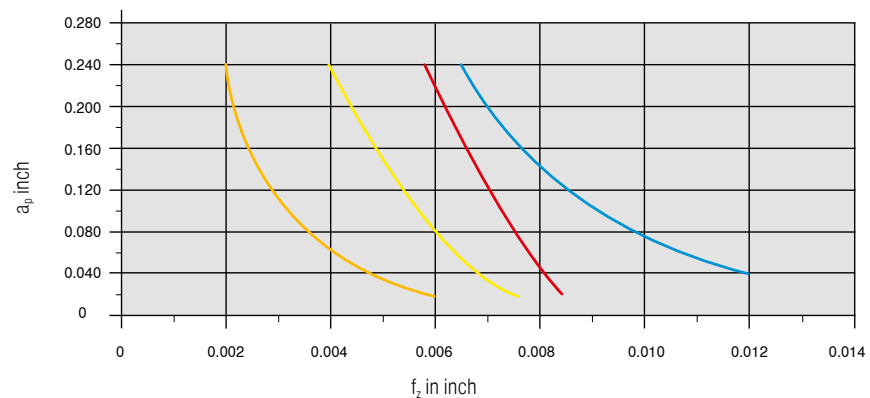

Material			Inserts		v_c in ft/min	Cooling
Steel	P.4.1	P20	SDMT1205ZZSN-29	CTCP230	660	Dry
Stainless steel	M.1.1	316Ti	SDMT120512SR-33	CTPM240	600	Dry
Cast iron	K.1.1	GG25 Cast Iron	SDMT1205ZZSN-31	CTCK215	825	Dry
Heat-resistant	S.2.2	Inconel 718	SDMT120508ER-M31	CTC5240	115	Emulsion

1 Detailed information on cutting speed for each grade can be found on → page **98-100**

HSC machining

Safety advice

Suitability of the tool for HSC machining

HSC tools from CERATIZIT have been specially developed for this machining strategy and guarantee maximum operational reliability.

Observation of safety precautions of the machine manufacturer

Make sure that all safety precautions of the machine-manufacturer are observed (e.g.: closed machine guards).

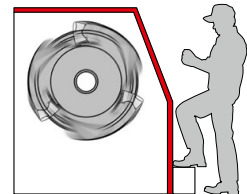

Suitability of the adapters for HSC machining

According to the milling situation, choose the optimum tool/clamping device combination. For high speed milling applications it is necessary to dynamically balance tool and tool adapter together (see ISO 1940 directives).

Mounting the indexable insert with centrifugal force protection

Insert clamping: EURO-patent EP 1083017A1

Make sure that the insert pocket is cleaned and the threading bore for the clamping screw is in good condition.

Check the axial and radial contact points of the insert in the pocket.

The clamping screws for positive insert clamping must be tightened with a torque of (XDHT11 = 1,8 Nm; XDH.19 = 6,0 Nm).

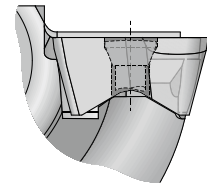

Maximum admissible number of revolutions

Please note the maximum number of revolutions stated on the tool. This number is exclusively valid for the specific tool and must be adapted according to the selected tool adapter, total overhang length and the respective machining situation.

Optimum application range of the tool (a_e , a_p , f_z , n)

In order to guarantee productive milling, please observe the recommendations regarding the cutting parameters.





7





Failure to comply with these safety regulations automatically excludes CERATIZIT from any liability

System MaxiMill HSC-11

Cutting data standard values

Workpiece material	Treatment / alloy	VDI 3323 Group	Hardness HB	H216T (CWK26)	
				 v_c in ft/min	 v_c in ft/min
N Aluminum alloys, Cast aluminum alloy	non hardenable	21	60		660-9840
	hardenable	22	100		660-6560
	non hardenable < 12% Si	23	80		660-6560
		hardenable < 12% Si	24	90	
	non hardenable > 12% Si	25	130		660-3280
	Free-cutting steel alloy (1% Pb)	26			660-1970
O Copper and copper alloys (Bronze, Brass)	brass, red bronze	27	90	820-3280	820-3280
	bronze	28	100		490-1310
	lead-free copper and electrolytic copper	29	100		980-2620
O Non metal materials	Duroplastics	29		260-3280	260-3280
	Fibre-reinforced plastics	29		230-1640	230-1640
	hard rubber	30		260-100	260-100

 = full lubricant

 = Minimum quantity lubrication

 = dry machining

System MaxiMill HSC-11

Machining strategy

Axial ramping

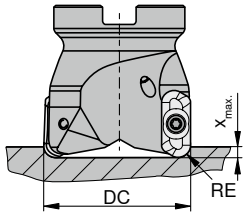

DC inch	X_{max} inch
0.63	0.07
0.75	0.09
1.00	0.10
1.25	0.09
1.50	0.09
2.00	0.09
2.50	0.08
3.00	0.07
4.00	0.07

Linear ramping

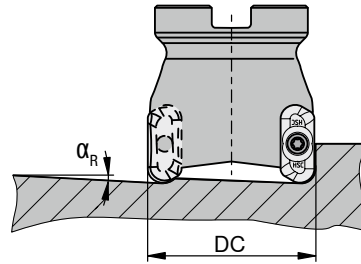

DC inch	α_R °
0.63	18.8
0.75	15.3
1.00	10.3
1.25	6.8
1.50	4.8
2.00	3.5
2.50	2.5
3.00	1.8
4.00	1.3

Milling strategy for roughing and finishing

With maximum chip volume

Indexable Insert	RE inch	1	2,3,4
		a_p inch	$a_{p max}$ inch
XDHT 11T302FR-ALP	0.008	0.39	0.39
XDHT 11T304FR-ALP	0.016	0.39	0.38
XDHT 11T308FR-ALP	0.031	0.39	0.36
XDHT 11T312FR-ALP	0.047	0.39	0.35
XDHT 11T316FR-ALP	0.063	0.39	0.33
XDHT 11T320FR-ALP	0.079	0.39	0.31
XDHT 11T325FR-ALP	0.098	0.39	0.30
XDHT 11T332FR-ALP	0.126	0.39	0.27
XDHT 11T340FR-ALP	0.157	0.39	0.24
XDHT 11T350FR-ALP	0.197	0.39	0.20

With maximum side wall quality

Indexable Insert	RE inch	2,3,4
		$a_{p max}$ inch
XDHT 11T302FR-ALP	0.008	0.31
XDHT 11T304FR-ALP	0.016	0.30
XDHT 11T308FR-ALP	0.031	0.28
XDHT 11T312FR-ALP	0.047	0.26
XDHT 11T316FR-ALP	0.063	0.27
XDHT 11T320FR-ALP	0.079	0.25
XDHT 11T325FR-ALP	0.098	0.22
XDHT 11T332FR-ALP	0.126	0.19
XDHT 11T340FR-ALP	0.157	0.16
XDHT 11T350FR-ALP	0.197	0.12

Shoulder milling

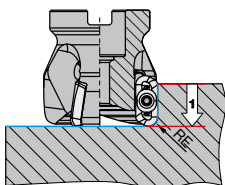

Modification to front profile

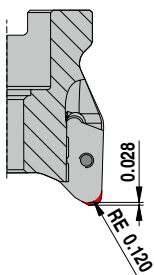

Pocket milling

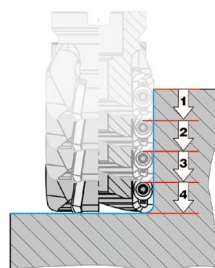

Pocket milling with thin walled components

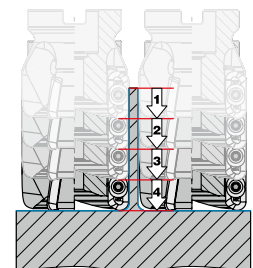

For inserts with a corner radius larger than 0.125" the basic body of the tool must be modified according to the drawing above.

System MaxiMill HSC-11

Machining strategy

Helical plunging

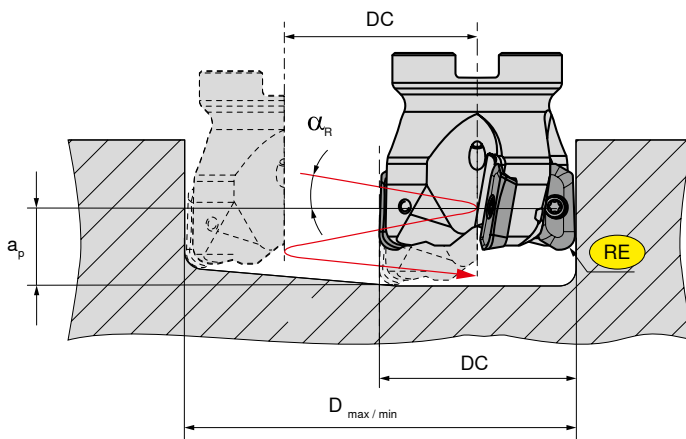

RE = Insert radius
 α_R inch = Maximum ramping angle (related to centre of tool)

a_p inch = $\text{pitch} \rightarrow D \times \pi \times \tan(\alpha_R)$

D in inch = $\rightarrow D_{max} - DC$ and/or $D_{min} - DC$

For flat bottom hole

D_{max} in inch = largest drilling diameter
 D_{min} in inch = smallest drilling diameter
 DN_{max} in inch = Maximum hole diameter for non flat bottom

DC inch (DN_{max})	XDHT-11 (HSC-11)									
		RE = 0.008	RE = 0.016	RE = 0.032	RE = 0.048	RE = 0.064	RE = 0.080	RE = 0.100	RE = 0.125	RE = 0.160
1.25 (0.75)	α_R	9.7°	10.0°	9.9°	9.4°	8.9°	8.4°	7.9°	7.0°	6.1°
	$D_{max..}$	1.18	1.18	1.14	1.10	1.06	1.06	1.02	0.94	0.91
	$D_{min..}$	0.71	0.71	0.71	0.71	0.71	0.71	0.71	0.71	0.71
1.37 (0.87)	α_R	9.4°	9.1°	8.7°	8.3°	7.9°	7.5°	6.9°	6.2°	5.3°
	$D_{max..}$	1.34	1.34	1.30	1.26	1.22	1.22	1.18	1.10	1.06
	$D_{min..}$	0.71	0.71	0.71	0.71	0.71	0.71	0.71	0.71	0.71
1.50 (1.00)	α_R	8.8°	8.6°	8.3°	7.9°	7.5°	7.5°	6.5°	5.9°	5.1°
	$D_{max..}$	1.42	1.42	1.38	1.34	1.30	1.30	1.26	1.18	1.14
	$D_{min..}$	0.87	0.87	0.87	0.87	0.87	0.87	0.87	0.87	0.87
1.50 (1.00)	α_R	8.4°	8.2°	7.8°	7.4°	7.7°	6.7°	6.2°	5.5°	4.8°
	$D_{max..}$	1.50	1.50	1.46	1.42	1.38	1.38	1.34	1.26	1.22
	$D_{min..}$	0.94	0.94	0.94	0.94	0.94	0.94	0.94	0.94	0.94
1.75 (1.00)	α_R	7.6°	7.4°	7.8°	6.7°	6.4°	6.5°	5.6°	5.2°	4.3°
	$D_{max..}$	1.65	1.65	1.61	1.57	1.53	1.53	1.49	1.41	1.37
	$D_{min..}$	1.18	1.18	1.18	1.18	1.18	1.18	1.18	1.18	1.18
2.00 (1.50)	α_R	6.7°	6.5°	6.2°	5.9°	5.6°	5.3°	4.9°	4.4°	3.8°
	$D_{max..}$	1.89	1.89	1.85	1.81	1.77	1.77	1.73	1.65	1.61
	$D_{min..}$	1.02	1.02	1.02	1.02	1.02	1.02	1.02	1.02	1.02
2.50 (2.00)	α_R	4.7°	4.7°	4.8°	4.6°	4.3°	4.1°	3.8°	3.4°	2.9°
	$D_{max..}$	2.44	2.44	2.40	2.36	2.32	2.32	2.28	2.20	2.17
	$D_{min..}$	1.42	1.42	1.42	1.42	1.42	1.42	1.42	1.42	1.42
3.00 (2.50)	α_R	3.3°	3.3°	3.4°	3.4°	3.5°	3.3°	3.0°	2.7°	2.3°
	$D_{max..}$	3.07	3.07	3.03	2.99	2.95	2.95	2.91	2.83	2.80
	$D_{min..}$	1.97	1.97	1.97	1.97	1.97	1.97	1.97	1.97	1.97
4.00 (3.50)	α_R	2.4°	2.5°	2.5°	2.5°	2.6°	2.6°	2.4°	2.2°	1.9°
	$D_{max..}$	3.86	3.86	3.82	3.78	3.74	3.74	3.70	3.62	3.58
	$D_{min..}$	2.60	2.60	2.60	2.60	2.60	2.60	2.60	2.60	2.60
5.00 (4.50)	α_R	1.7°	1.7°	1.7°	1.8°	1.8°	1.8°	1.8°	1.7°	1.5°
	$D_{max..}$	4.88	4.88	4.84	4.80	4.76	4.76	4.72	4.65	4.61
	$D_{min..}$	3.39	3.39	3.39	3.39	3.39	3.39	3.39	3.39	3.39
6.25 (5.75)	α_R	1.1°	1.1°	1.1°	1.1°	1.1°	1.1°	1.1°	1.2°	1.2°
	$D_{max..}$	6.22	6.22	6.18	6.14	6.10	6.10	6.06	5.98	5.94
	$D_{min..}$	4.41	4.41	4.41	4.41	4.41	4.41	4.41	4.41	4.41
7.75 (7.25)	α_R	0.8°	0.8°	0.9°	0.9°	0.9°	0.9°	0.9°	0.9°	0.9°
	$D_{max..}$	5.75	5.75	5.75	5.75	5.75	5.75	5.75	5.75	5.75
	$D_{min..}$	7.80	7.80	7.76	7.72	7.68	7.68	7.64	7.56	7.52

System MaxiMill HSC-19

Machining strategy

Helical plunging

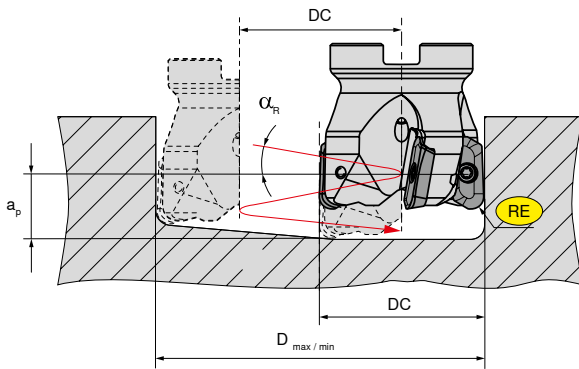

RE = Insert radius
 α_R in inch = Maximum ramping angle (related to centre of tool)

a_p in inch = $\text{pitch} \rightarrow D \times \pi \times \tan(\alpha_R)$

D in inch = $\rightarrow D_{max} - DC$ and/or $D_{min} - DC$

For flat bottom hole

D_{max} in inch = largest drilling diameter
 D_{min} in inch = smallest drilling diameter
 DN_{max} in inch = Maximum hole diameter for non flat bottom

	DC inch	DN_{max} inch	α_R °	D_{max} inch	D_{min} inch
RE = 0.008"	1.00	1.93	7°02'	1.89	1.26
	1.25	2.48	4°34'	2.44	1.81
	1.50	3.11	3°47'	3.07	2.44
	2.00	3.90	3°01'	3.82	3.19
	2.50	4.92	2°17'	4.88	4.21
	3.00	6.26		6.22	5.55
	4.00	7.83		7.80	7.13

	DC inch	DN_{max} inch	α_R °	D_{max} inch	D_{min} inch
RE = 0.016"	1.00	0.98	7°08'	1.93	1.89
	1.25	1.26	4°37'	2.48	2.44
	1.50	1.57	3°49'	3.11	3.07
	2.00	1.97	3°02'	3.90	3.86
	2.50	2.48	2°18'	4.92	4.88
	3.00	3.15		6.26	6.22
	4.00	3.94		7.83	7.80

	DC inch	DN_{max} inch	α_R °	D_{max} inch	D_{min} inch
RE = 0.032"	1.00	1.93	7°21'	1.85	1.26
	1.25	2.48	4°44'	2.40	1.81
	1.50	3.11	3°53'	3.03	2.44
	2.00	3.90	3°05'	3.82	3.19
	2.50	4.92	2°20'	4.84	4.21
	3.00	6.26		6.18	5.55
	4.00	7.83		7.76	7.13

	DC inch	DN_{max} inch	α_R °	D_{max} inch	D_{min} inch
RE = 0.078"	1.00	0.98	8°40'	1.93	1.77
	1.25	1.26	5°04'	2.48	2.32
	1.50	1.57	4°06'	3.11	2.95
	2.00	1.97	3°13'	3.90	3.74
	2.50	2.48	2°25'	4.92	4.76
	3.00	3.15		6.26	6.10
	4.00	3.94		7.83	7.68

	DC inch	DN_{max} inch	α_R °	D_{max} inch	D_{min} inch
RE = 0.098"	1.00	1.93	8°24'	1.73	1.26
	1.25	2.48	5°13'	2.28	1.81
	1.50	3.11	4°12'	2.91	2.44
	2.00	3.90	3°17'	3.70	3.19
	2.50	4.92	2°27'	4.72	4.21
	3.00	6.26		6.06	5.55
	4.00	7.83		7.64	7.13

	DC inch	DN_{max} inch	α_R °	D_{max} inch	D_{min} inch
RE = 0.128"	1.00	0.98	8°54'	1.93	1.65
	1.25	1.26	5°26'	2.48	2.20
	1.50	1.57	4°20'	3.11	2.83
	2.00	1.97	3°21'	3.90	3.62
	2.50	2.48	2°30'	4.92	4.65
	3.00	3.15		6.26	5.98
	4.00	3.94		7.83	7.56

	DC inch	DN_{max} inch	α_R °	D_{max} inch	D_{min} inch
RE = 0.157"	1.00	1.93	9°32'	1.61	1.26
	1.25	2.48	5°42'	2.17	1.81
	1.50	3.11	4°30'	2.80	2.44
	2.00	3.90	3°28'	3.58	3.19
	2.50	4.92	2°33'	4.61	4.21
	3.00	6.26		5.94	5.55
	4.00	7.83		7.52	7.13



	DC inch	DN_{max} inch	α_R °	D_{max} inch	D_{min} inch
RE = 0.196"	1.00	0.98	6°49'	1.93	1.54
	1.25	1.26	3°59'	2.48	2.09
	1.50	1.57	3°20'	3.11	2.72
	2.00	1.97	2°13'	3.90	3.50
	2.50	2.48	1°52'	4.92	4.53
	3.00	3.15		6.26	5.87
	4.00	3.94		7.83	7.44

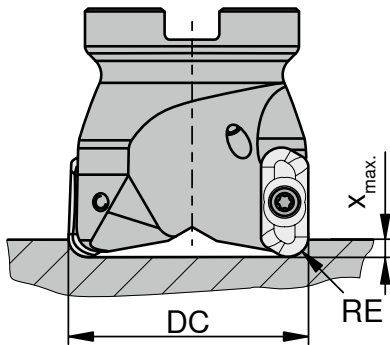

System MaxiMill HSC-19

Machining strategy

Axial ramping





HSC 19	DC mm	 19 RE 0.008-0.157	 19 RE 0.196
		X_{max} mm	X_{max} mm
CHSC 19 / GHSC 19 / MHSC 19	1.00	0.196	0.157
CHSC 19 / GHSC 19 / MHSC 19	1.25-1.50	0.157	0.118
AHSC 19	1.50-4.00	0.157	0.118

HPC 19	DC mm	 19 RE 0.008-0.157	 19 RE 0.196
		X_{max} mm	X_{max} mm
CHPC 19 / MHPC 19	1.00	0.196	0.157
CHPC 19 / MHPC 19	1.25-1.50	0.236	0.196
AHPC 19	1.50-4.00	0.236	0.196

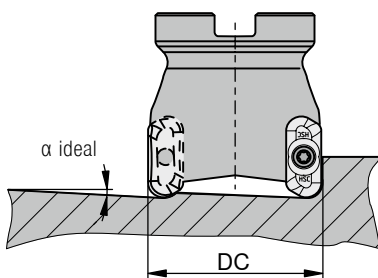
Linear ramping



DC mm	α ideal	
	HSC 19 	HPC 19 
1.00	11°	11°
1.25	7°	7°
1.50	5°	5°
2.00	4°	4°
2.50	3°	3°
3.00	2°	
4.00	2°	

Modification to basic body

HSC 19

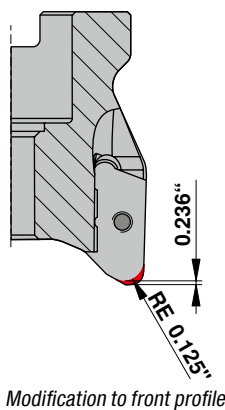
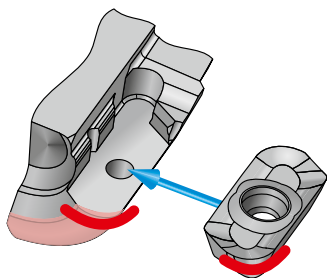

HPC 19

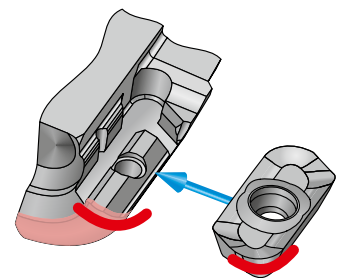

Modification to front profile

 For inserts with a corner radius larger than 4.0 mm the basic body of the tool must be modified according to the drawing above.



System MaxiMill HSC-19

Machining strategy

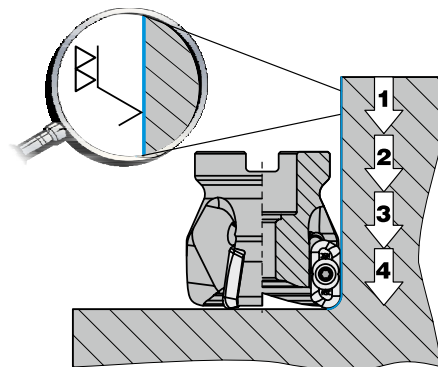
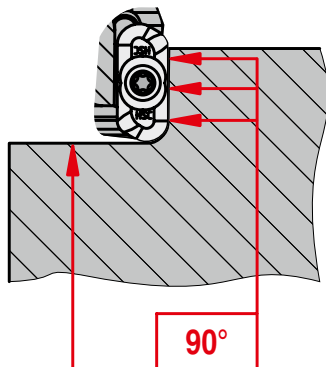

 Excellent side wall quality after roughing operation.
Additional finishing operations minimized or no longer required.



With maximum chip volume

			
Indexable Insert	RE inch	a_p inch	$a_{p \text{ max.}}$ inch
XDH. 190402FR-ALP	0.008	0.71	0.70
XDH. 190404FR-ALP	0.016	0.71	0.69
XDH. 190408FR-ALP	0.032	0.71	0.68
XDH. 190420FR-ALP	0.078	0.71	0.63
XDH. 190425FR-ALP	0.098	0.71	0.59
XDH. 190432FR-ALP	0.128	0.71	0.58
XDH. 190440FR-ALP	0.157	0.71	0.55
XDH. 190450FR-ALP	0.196	0.67	0.51

With maximum side wall quality

		
Indexable Insert	RE inch	$a_{p \text{ max.}}$ inch
XDH. 190402FR-ALP	0.008	0.46
XDH. 190404FR-ALP	0.016	0.46
XDH. 190408FR-ALP	0.032	0.44
XDH. 190420FR-ALP	0.078	0.39
XDH. 190425FR-ALP	0.098	0.37
XDH. 190432FR-ALP	0.128	0.35
XDH. 190440FR-ALP	0.157	0.31
XDH. 190450FR-ALP	0.196	0.28

Shoulder milling

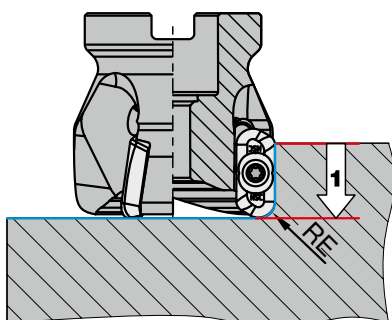

Pocket milling

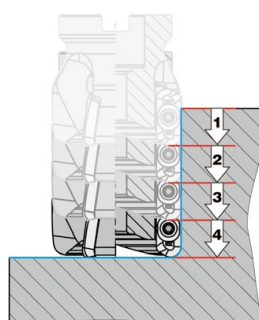

Pocket milling with thin walled components

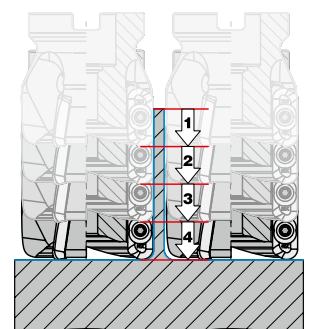

Average chip thickness [h_m] – the approach

Shoulder milling

1 Select appropriate average chip thickness [h_m] for the steel from the table.

Material	Tensile strength	h _m mm
	N/mm ²	
for steel	...-800	0.0063
for steel	800-1000	0.0055
for steel	1000-1200	0.0048
for steel	1200-...	0.0039
for stainless steel	...-750	0.0059
for stainless steel	750-900	0.0051
for stainless steel	900-1150	0.0043
for stainless steel	1150-...	0.0035*

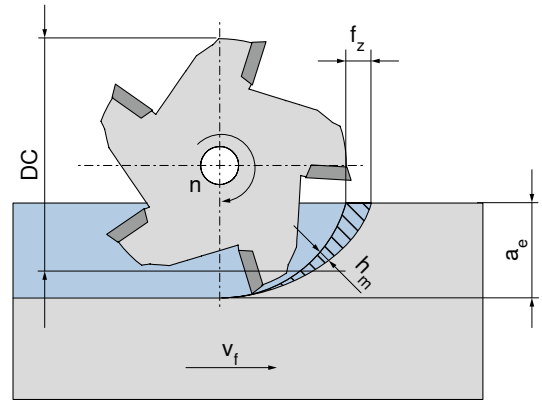

2 Select the corrected feed rate value from the table based on the appropriate chip thickness [h_m] and depth of cut [a_e].

h _m mm	Corrected feed value f _z for h _m				
	0.2 x DC	0.3 x DC	0.4 x DC	0.75 x DC	1 x DC
0.0063	0.0142	0.0114	0.0098	0.0071	0.0063
0.0055	0.0122	0.0102	0.0087	0.0060	0.0055
0.0048	0.0106	0.0087	0.0075	0.0055	0.0047
0.0039	0.0087	0.0071	0.0063	0.0047	0.0039
0.0059	0.0134	0.0106	0.0094	0.0067	0.0059
0.0051	0.0114	0.0094	0.0083	0.0059	0.0051
0.0043	0.0098	0.0079	0.0067	0.0051	0.0043
0.0035*	0.0079	0.0063	0.0055	0.0039	0.0035
a _e =	0.2 x DC	0.3 x DC	0.4 x DC	0.75 x DC	1 x DC

* f_z < 0.032": Danger, as tool is not working and cutting

Start values f_z in inch from starting parameter diagram

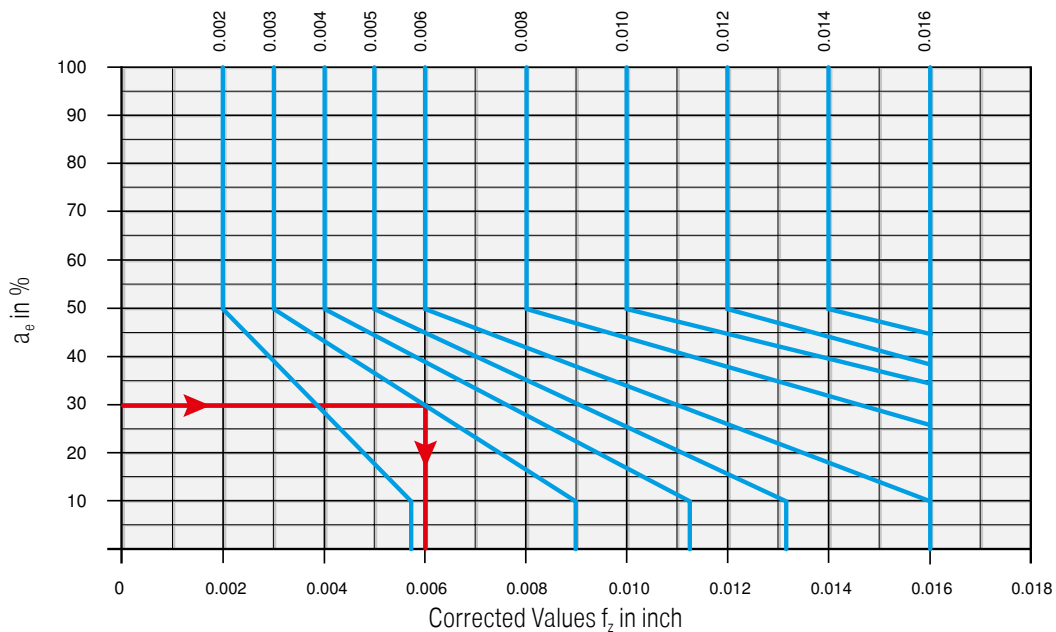

➔ **Example:**
Start value (f_z) = 0.003"
a_e = 30 %
corrected value (f_z) = 0.006"

System MaxiMill HFC-06

Machining strategy

Programmed radius R = 0.047"

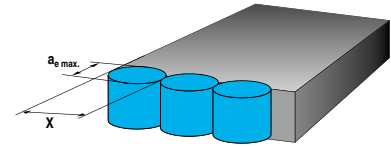
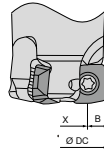
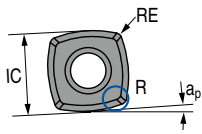

Cutting depth and remaining material			Cutting width for flat surfaces			Cutting depth when plunging				
IC in inch	RE in inch	$a_{p\max}$ in inch	DC in inch	X in inch	B in inch	$a_{e\max}$ in inch	f_z in inch			X
							initial	min.	max.	
0.25	0.020	0.032	0.625-1.25	DC-(2 x B)	0.169	0.209	0.004	0.003	0.016	<0.7 x DC

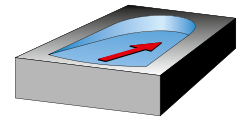
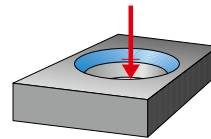
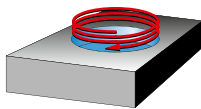

DC inch	circular Helical plunging (helical plunging into solid material)		
	D_{\min} inch	D_{\max} inch	$\alpha_{R\max}$ °
0.625	1.22	0.866	4.5°
0.750	1.53	1.18	2.3°
1.00	1.93	1.57	1.3°
1.25	2.48	2.12	0.9°

DC inch	axial	Angled
	Plunging	
	X_{\max} inch	$\alpha_{R\max}$ °
0.625		5.9°
0.750	0.020	3.2°
1.00		2.0°
1.25		1.3°

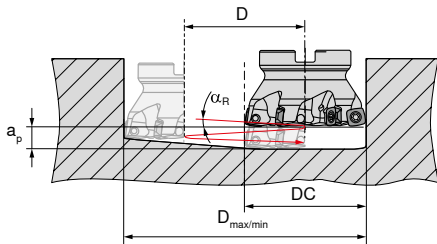

Starting Parameter



XPLX 06

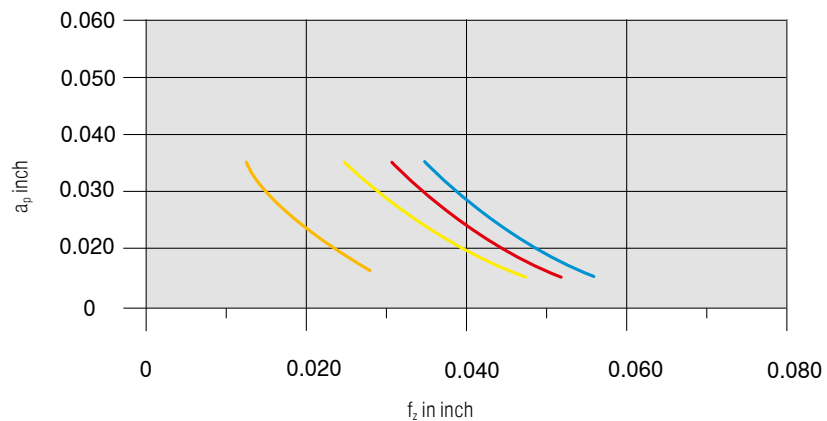

Material		Inserts		v_c in ft/min	Cooling
Steel	P.4.1 P20	XPLX 060305SR-M50	CTPP235	660	Dry
Stainless steel	M.1.1 316Ti	XPLX 060305ER-M40	CTPM240	600	Dry
Cast iron	K.1.1 GG25 Cast Iron	XPLX 060305ER-M50	CTCK215	825	Dry
Heat-resistant	S.2.2 Inconel 718	XPLX 060305SR-F40	CTC5240	115	Emulsion

Detailed information on cutting speed for each grade can be found on → page 98-100
From $v_c > 1300$ SFM, the tool must be balanced!

System MaxiMill HFC-09

Machining strategy

Programmed radius R = 0.078"

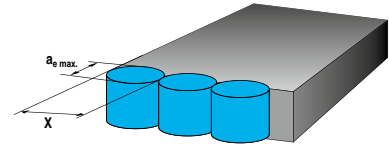
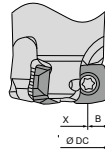
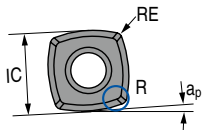

Cutting depth and remaining material			Cutting width for flat surfaces			Cutting depth when plunging				
IC in inch	RE in inch	ap max. in inch	DC in inch	X in inch	B in inch	ae max. in inch	f2 in inch		X	
							initial	min.	max.	
0.354	0.032	0.040	1.00-2.50	DC-(2 x B)	0.142	0.295	0.004	0.003	0.016	<0.7 x DC

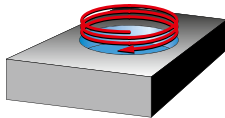

DC inch	circular Helical plunging (helical plunging into solid material)		
	Dmin. inch	Dmax. inch	αR max. °
1.00	1.89	1.37	3.1°
1.25	2.44	1.93	1.7°
1.37	2.67	2.16	1.4°
1.50	3.07	2.56	1.0°
1.62	4.01	2.71	0.9°
2.00	3.85	3.34	0.8°
2.12	4.01	3.50	0.7°
2.50	4.88	4.37	0.7°
2.62	5.11	4.60	0.6°

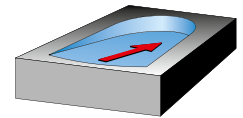
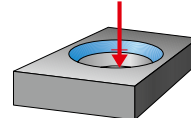

DC inch	Plunging	
	axial	Angled
	Xmax. inch	αR max. °
1.00		3.6°
1.25		2.0°
1.37		1.6°
1.50		1.2°
1.62	0.030	1.1°
2.00		0.9°
2.12		0.8°
2.50		0.8°
2.62		0.7°

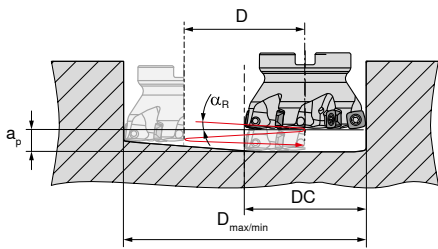

Starting Parameter



XDLX 09

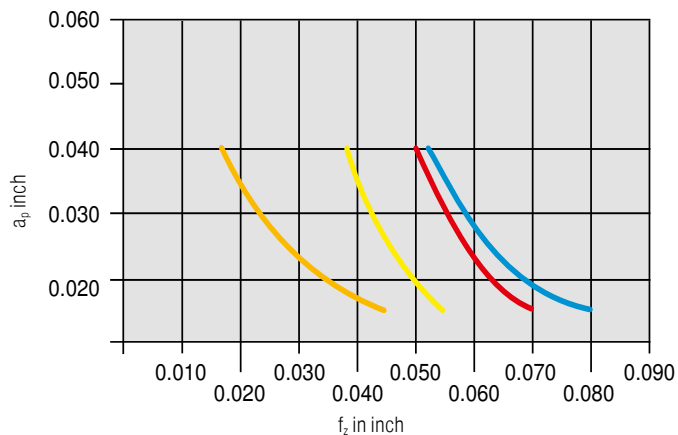

Material	Inserts		vc in ft/min	Cooling		
Steel	P.4.1	P20	XDLX09T308SR-M50	CTPP235	660	Dry
Stainless steel	M.1.1	316Ti	XDLX09T308SR-M50	CTPM240	600	Dry
Cast iron	K.1.1	GG25 Cast Iron	XDLX09T308SR-M50	CTCK215	825	Dry
Heat-resistant	S.2.2	Inconel 718	XDLX09T308ER-F40	CTC5240	115	Emulsion

Detailed information on cutting speed for each grade can be found on → page 98-100

From vc > 1300 SFM, the tool must be balanced!

System MaxiMill HFC-12

Machining strategy

Programmed radius R = 0.118"

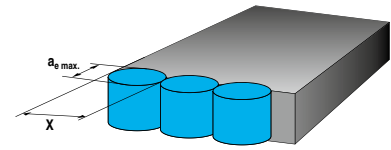
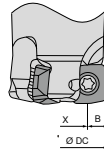
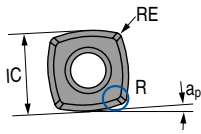

Cutting depth and remaining material			Cutting width for flat surfaces			Cutting depth when plunging				
IC in inch	RE in inch	ap max. in inch	DC in inch	X in inch	B in inch	ae max. in inch	f2 in inch		X	
							initial	min.	max.	
0.472	0.040	0.080	1.25-4.00	DC-(2 x B)	0.326	0.393	0.006	0.004	0.008	<0.7 x DC

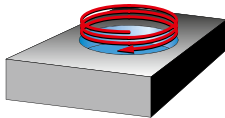

DC inch	circular Helical plunging (helical plunging into solid material)		
	Dmin. inch	Dmax. inch	α R max. °
1.00	2.45	1.73	6.1°
1.25	2.67	1.97	3.7°
1.50	3.07	2.56	2.5°
1.62	3.22	2.52	2.3°
2.00	3.86	3.15	1.3°
2.12	4.01	3.30	1.3°
2.50	4.88	4.17	0.9°
2.62	5.12	4.41	0.9°
3.00	6.22	5.51	1.1°
4.00	7.79	7.09	0.6°

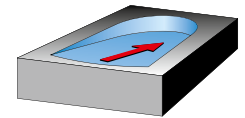
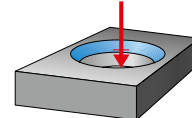

DC inch	Plunging	
	Xmax. inch	α R max. °
1.25	0.045	7.2°
1.37		4.4°
1.50		2.9°
1.62		2.7°
2.00 + 2.12		1.5°
2.50 + 2.62		1.1°
3.00		1.3°
4.00		0.7°

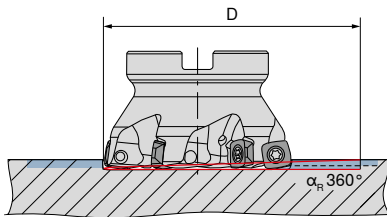

Starting Parameter



XOLX 12

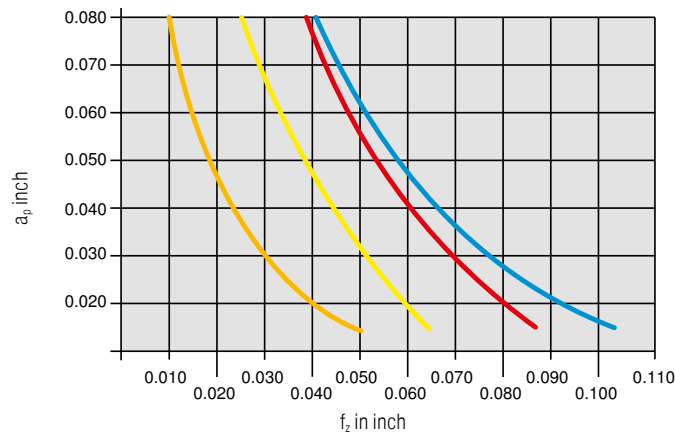

Material	Inserts		vc in ft/min	Cooling
Steel	P.4.1 P20	XOLX120410SR-M50 CTPP235	660	Dry
Stainless steel	M.1.1 316Ti	XOLX120410ER-M50 CTPM240	600	Dry
Cast iron	K.1.1 GG25 Cast Iron	XOLX120410ER-M50 CTCK215	825	Dry
Heat-resistant	S.2.2 Inconel 718	XOLX120410ER-F40 CTC5240	115	Emulsion

Detailed information on cutting speed for each grade can be found on → page 98-100
From vc > 1300 SFM, the tool must be balanced!

System MaxiMill HFC-19

Machining strategy

Programmed radius R = 0.196"

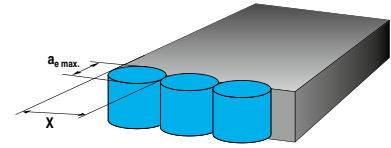
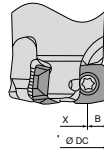
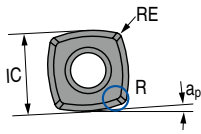

Cutting depth and remaining material			Cutting width for flat surfaces			Cutting depth when plunging				
IC in inch	RE in inch	$a_{p \max}$ in inch	DC in inch	X in inch	B in inch	$a_{e \max}$ in inch	f_z in inch		X	
							initial	min.	max.	
0.753	0.060	0.129	2.50-4.00	DC-(2 x B)	0.516	0.472	0.008	0.004	0.010	<0.65 x DC

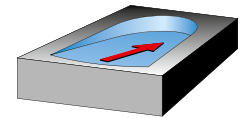
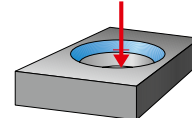
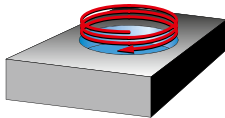

DC inch	circular Helical plunging (helical plunging into solid material)		
	D_{\min} inch	D_{\max} inch	$\alpha_{R \max}$ °
2.50	3.82	4.84	2.5
3.00	5.15	6.18	1.4
4.00	6.73	7.75	1.0
5.00	8.70	9.72	0.7
6.00	11.45	12.48	0.5

DC inch	axial	Angled	
	X_{\max} inch	$\alpha_{R \max}$ °	$a_{p \max}$ inch
2.50		2.9	
3.00		1.8	
4.00	0.067	1.3	0.129
5.00		1.0	
6.00		0.7	

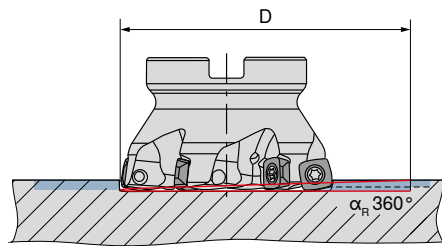

Starting Parameter



XOLX 19

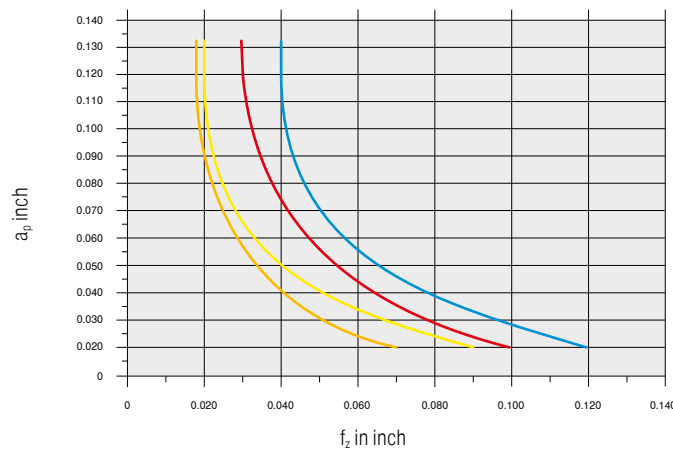

Material			Inserts		v_c in ft/min	Cooling
Steel	P.4.1	P20	XOLX190615SR-M50	CTPP235	660	Dry
Stainless steel	M.1.1	316Ti	XOLX190615SR-M50	CTPM240	600	Dry
Cast iron	K.1.1	GG25 Cast Iron	XOLX190615SR-M50	CTCK215	825	Dry
Heat-resistant	S.2.2	Inconel 718	XOLX190615ER-F40	CTC5240	115	Emulsion

Detailed information on cutting speed for each grade can be found on → page 98-100
From $v_c > 1300$ SFM, the tool must be balanced!

MaxiMill 251 RS system

Technical data

Recommended cutting depth

∅ inch	4-position		8-face
	$a_{p\ max}$ inch	$a_{p\ max}$ theoretical inch	$a_{p\ max}$ inch
0.196	0.040	0.080	0.028
0.314	0.060	0.140	0.043
0.393	0.100	0.180	0.055
0.472	0.120	0.220	0.067
0.629	0.160	0.300	0.090
0.787	0.160	0.380	0.114

Average depth for the 4/8 index use of the insert

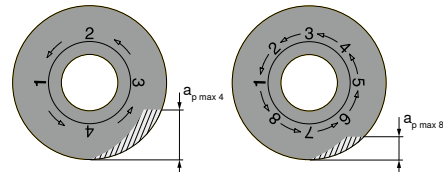

Detailed information on cutting speed for each grade can be found on → page 98-100

Linear ramping

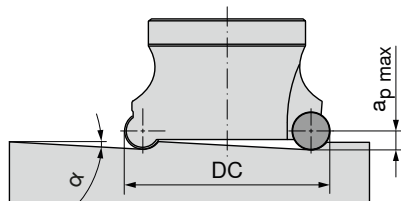

∅ DC inch	05	08	10	12	16	20
	α °	α °	α °	α °	α °	α °
0.37	3.4					
0.50	16.0					
0.62	8.0	5.0				
0.75	5.5	20.0	1.3			
1.00	4.0	13.0	2.0	6.0		
1.25	3.0	8.0	3.0	4.0		
1.50			3.3	2.8		
1.62			3.1			
2.00			2.4	2.6	4.0	
2.12			2.2	2.3		
2.50				1.9	2.8	
2.62				1.6		
3.00				1.3	2.0	3.2
4.00				1.0	1.5	2.3
5.00						1.7

Axial ramping

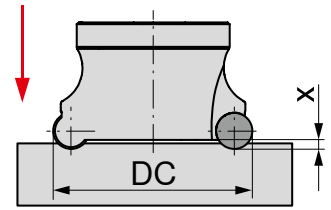

∅ DC inch	05	08	10	12	16	20
	$X_{\ max}$ inch	$X_{\ max}$ inch	$X_{\ max}$ inch	$X_{\ max}$ inch	$X_{\ max}$ inch	$X_{\ max}$ inch
0.37	0.020					
0.50	0.050					
0.62	0.050	0.020				
0.75	0.050	0.106	0.008			
1.00	0.050	0.106	0.016	0.040		
1.25	0.050	0.106	0.030	0.043		
1.50			0.060	0.047		
1.62			0.060	0.060		
2.00			0.060	0.060	0.080	
2.12			0.060	0.060	0.080	
2.50				0.060	0.080	
2.62				0.060	0.080	
3.00				0.060	0.080	0.120
4.00				0.060	0.080	0.120
5.00						0.120

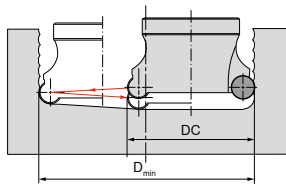

$D_{\ min}$ = smallest drilling diameter depending on the tool diameter

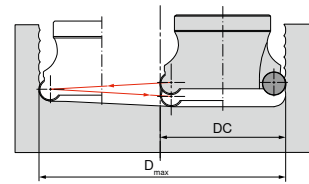

$D_{\ max}$ = Maximum hole diameter Depending on the tool diameter

maximum possible hole diameter = 2 x DC - 0.040"

∅ DC inch	05			08			10			12			16			20		
	$D_{\ min}$ inch	$D_{\ max}$ inch	α_R °	$D_{\ min}$ inch	$D_{\ max}$ inch	α_R °	$D_{\ min}$ inch	$D_{\ max}$ inch	α_R °	$D_{\ min}$ inch	$D_{\ max}$ inch	α_R °	$D_{\ min}$ inch	$D_{\ max}$ inch	α_R °	$D_{\ min}$ inch	$D_{\ max}$ inch	α_R °
0.37	0.47	0.59	2.5															
0.50	0.63	0.75	2.1															
0.62	0.94	1.06	1.5	0.83	0.94	2.4												
0.75	1.26	1.38	1.2	1.06	1.26	1.9	1.02	1.18	1.3									
1.00	1.65	1.77	1.0	1.46	1.65	1.5	1.46	1.57	1.8	1.22	1.50	2.2						
1.25	2.20	2.32	0.7	2.01	2.20	1.2	1.97	2.13	1.5	1.81	2.05	1.7						
1.50							2.52	2.76	1.1	2.44	2.68	1.4						
1.62							2.68	2.91	1.1									
2.00							3.31	3.54	0.9	3.19	3.46	1.1	2.95	3.31	1.5			
2.12							3.46	3.70	0.9	3.39	3.62	1.0						
2.50										4.21	4.49	0.9	3.98	4.33	1.1			
2.62										4.45	4.72	0.8						
3.00										5.59	5.83	0.7	5.31	5.67	0.9	5.04	5.51	1.1
4.00										7.13	7.40	0.5	6.89	7.24	0.7	6.61	7.09	0.9
5.00																8.58	9.06	0.7

System MaxiMill 252

Machining strategy

Recommended cutting depth

Ø inch	4-position	
	$a_{p,max}$ inch	inch
	0.393	0.100
0.472	0.120	0.220

Starting Parameter



RNHU 10

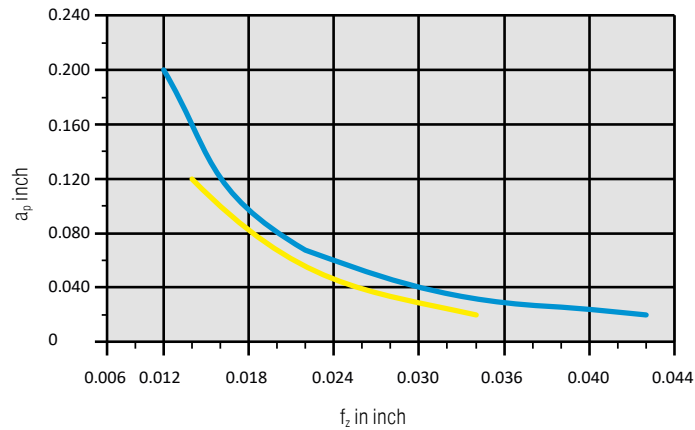

Material			Inserts		v_c in ft/min	Cooling
Steel	P.4.1	P20	XOLX120410SR-M50	CTPP235	600	Dry
Stainless steel	M.1.1	316Ti	XOLX120410ER-M50	CTPM240	600	Dry

Starting Parameter



RNHU 12

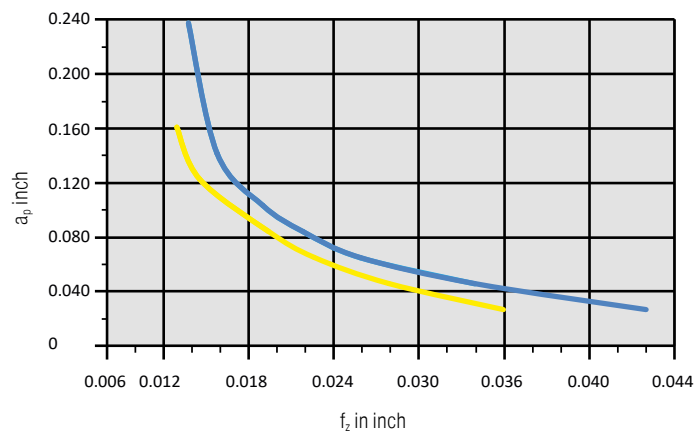

Material			Inserts		v_c in ft/min	Cooling
Steel	P.4.1	P20	XOLX120410SR-M50	CTPP235	600	Dry
Stainless steel	M.1.1	316Ti	XOLX120410ER-M50	CTPM240	600	Dry

Detailed information on cutting speed for each grade can be found on → page 98-100
From $v_c > 1300$ SFM, the tool must be balanced!

System MaxiMill 260

Setting of axial run-out for roughing

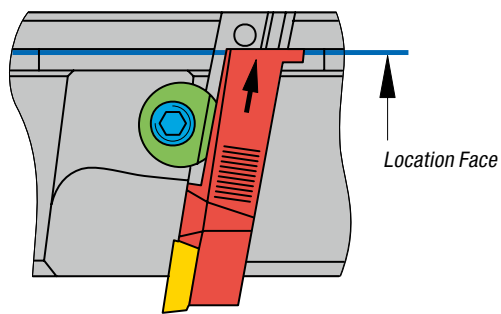

For assembly simply press cartridges onto the location face of the radial groove. The axial run-out amounts to 0.00072" measured on the master insert.

Setting of axial run-out with eccentric key and clock gauge or on optical presetting equipment

Exact setting of axial run-out up to 0.0008"

- ▲ Clean the milling tools
- ▲ Mount cutter on appropriate setting equipment.
- ▲ Loosen clamping wedge, push cassette to face and tighten wedge lightly.
- ▲ Insert eccentric key into hole and turn until cassette is in desired position.
- ▲ Keep eccentric key in contact with the cassette so that it remains in position.
Tighten wedge (torque moment 10 Nm).
- ▲ The tool is now ready for use.

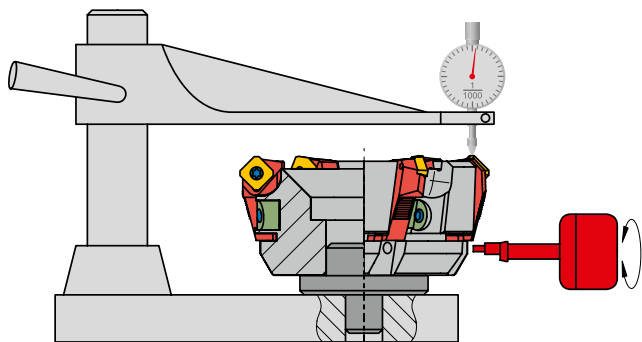

Abbreviations & dimensions

a_e	cutting width	inch
a_p	Cutting depth	inch
DC	Tool diameter	inch
D_w	Workpiece diameter	inch
f_z	Feed per tooth	inch
h_m	Average Chip Thickness	inch
k	Number of teeth	
k_c	Specific cutting force	N/inch ²
$k_{c1,1}$	Specific cutting force for 1 mm ² chip area	N/inch ²
BS	Length of wiper land	inch
m_c	Increase of specific cutting force	
n	rpm	rpm
Q	Chip volume	in ³ /min
v_c	Cutting speed	ft/min
v_f	Feed rate	in/min
ZNF	Number of Effective Teeth	
V_0	Effective cutting angle	degree
V_f	Side clearance angle	degree
V_p	Axial cutting angle	degree
κ	Cutting edge angle	degree
λ_s	Angle of inclination	degree
α	Clearance angle	degree
α_1	Side clearance angle	degree

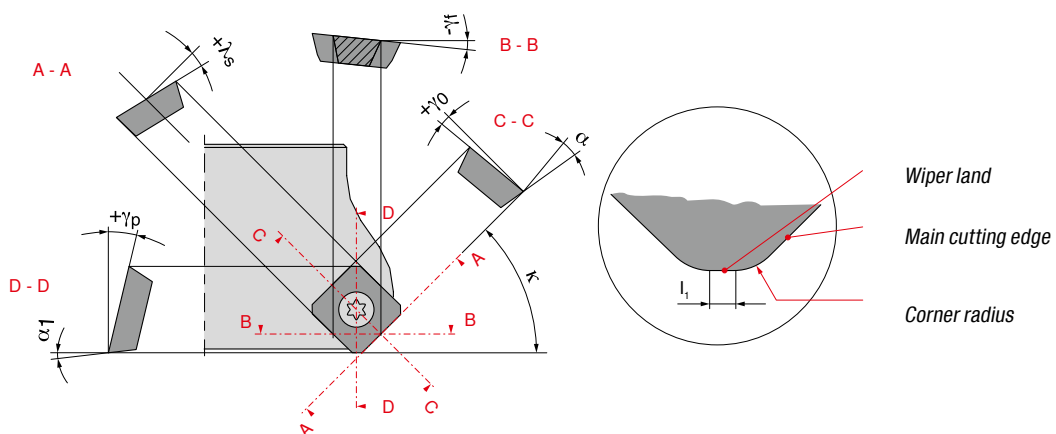
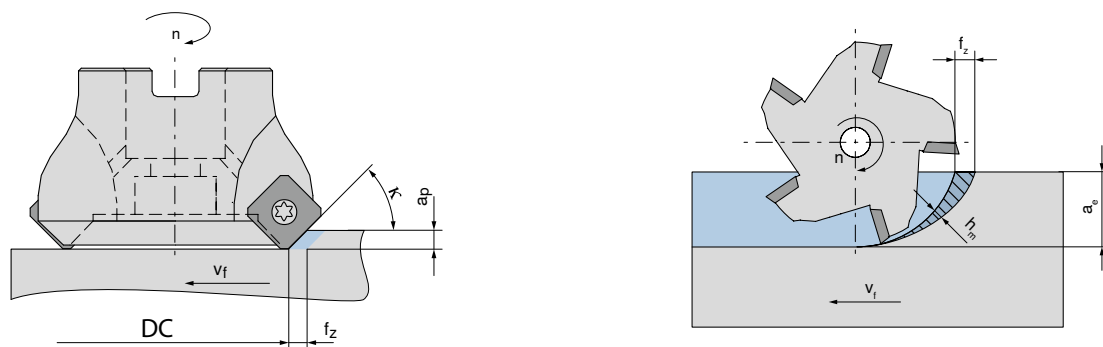

Engagement conditions

Recommended

Climb milling

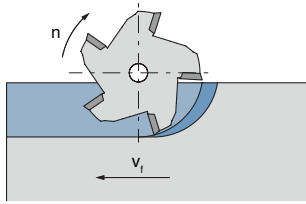

The feed direction of the workpiece is the same as the direction of rotation of the milling cutter in the cutting zone. The chips have maximum thickness at the beginning, chip thickness then decreases until it becomes zero at the end of the cut.

Unsuitable

Conventional milling

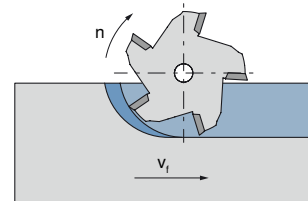

The feed direction of the workpiece is opposite to the direction of rotation of the milling cutter in the cutting zone. Chip thickness is zero at the beginning and increases until it reaches its maximum at the end of the cut.

Cutter positioning

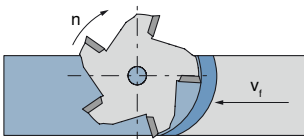

If possible the cutter should exit tangentially of the workpiece.

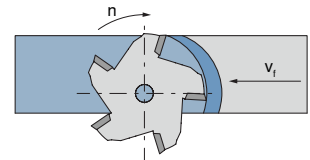

Workpiece situation

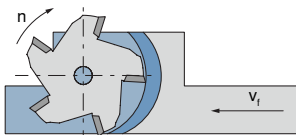

The workpiece should be clamped in such a way as to allow the cutter to emerge tangentially of the workpiece along the whole machining length.

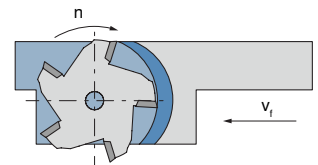

Overlapping

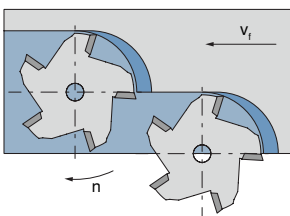

Either employ climb milling or ensure that the cutter comes out of the workpiece tangentially, as in the illustration on the left.

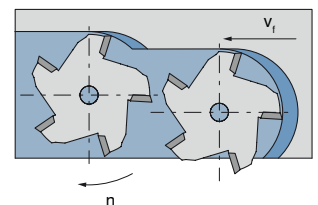

Cutter size

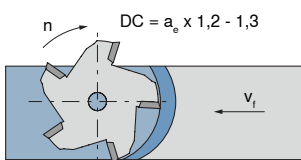

When face milling the diameter of the cutter should be 20–30 % larger than that of the workpiece.

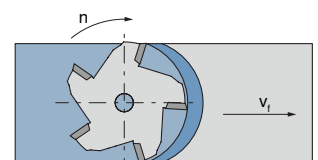

ISO designation indexable milling inserts

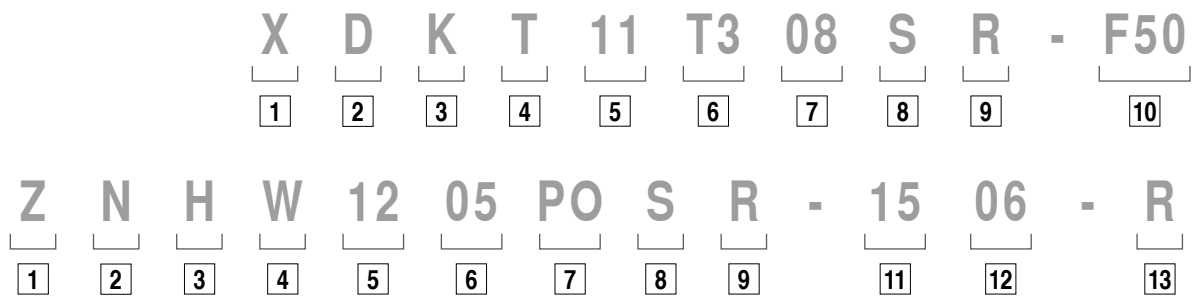

1

Insert shape

A	85°	
B	82°	
K	55°	
H	120°	
L	90°	
O	135°	
P	108°	
C	80°	
D	55°	
E	75°	
M	86°	
V	35°	
R		
S	90°	
T	60°	
W	80°	
X	Special version	
Z		

2

Clearance angle

	α
A	3°
B	5°
C	7°
D	15°
E	20°
F	25°
G	30°
N	0°
P	11°
O	Special version

3

Tolerances

	IC ±inch	BS ±inch	S ±inch	IC = 1/4 / 3/8	IC = 1/2	IC = 5/8 / 3/4
A	0.0010	0.0002	0.0001	●	●	●
C	0.0010	0.0005	0.0001	●	●	●
E	0.0010	0.0010	0.0001	●	●	●
F	0.0005	0.0002	0.0001	●	●	●
G	0.0010	0.0010	0.0005	●	●	●
H	0.0005	0.0005	0.0010	●	●	●
J	0.0020 / 0.0031 / 0.0039	0.0002 / 0.0002 / 0.0002	0.0010 / 0.0010 / 0.0010	●	●	●
K	0.0020 / 0.0031 / 0.0039	0.0005 / 0.0005 / 0.0005	0.0010 / 0.0008 / 0.0008	●	●	●
M	0.0020 / 0.0031 / 0.0039	0.0031 / 0.0051 / 0.0059	0.0051 / 0.0051 / 0.0051	●	●	●
N	0.0020 / 0.0031 / 0.0039	0.0031 / 0.0051 / 0.0059	0.0010 / 0.0010 / 0.0010	●	●	●
U	0.0020 / 0.0031 / 0.0039	0.0051 / 0.0079 / 0.0071	0.0051 / 0.0051 / 0.0051	●	●	●

7

Wiper land / corner radius

Radius	
	RE in inch
M0*	
02	0.008
04	0.016
08	0.031
12	0.047

* Only with insert type "R"

1. Designation		2. Designation	
	K_r		α'_n
A	45°	A	3°
D	60°	B	5°
E	75°	C	7°
F	85°	D	15°
P	90°	E	20°
Z	Alternative	F	25°
		G	30°
		N	0°
		P	11°
		Z	Alternative
		O	Alternative

8

Cutting edge

F	Sharp
E	rounded
S	Chamfered and honed
T	chamfered

9

Direction of cut

R	Right
L	Left
N	Normal

4

Characteristics

A	
F	
G	
M	
N	
Q	
R	
T	
U	
W	
X	Special version

5

Cutting length

IC inch											
0.193										07	
0.196						05					
0.219			05		08			03			
0.236											
1/4		11	06		10			04		06	
0.262	10										
0.267										11	
0.275											04
0.313			07								
0.315						08					
0.354					12						
0.366										15	
3/8	16	16	09		15			06	04		
0.376	15										
0.378										09	
0.394			10		11	10					12
0.472						12					
0.492										20	
1/2		12/22	12		20		22	08		12	
0.622			15		22			10			
0.630						16					
0.638				09							
0.659			16								
0.670			17								
0.676									06		
0.716									07		
3/4			19					13			
0.787						20					

6

Insert thickness



	S inch
01	0.063
T1	0.078
02	0.094
03	0.125
T3	0.156
04	0.187
05	0.219
06	0.250
07	0.312
09	0.375

10

Chip groove

Chip breaker designation
F.. = fine
M.. = medium
R.. = roughing

Additional characteristics:
R = transition radius main/
secondary cutting edge
Q = Masterfinish

11

Manufacturer specification

Length of the finishing cutting edge

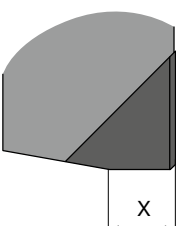

X

00 = 0,0 mm / 0.00 in
10 = 1,0 mm / 0.039 in
12 = 1,2 mm / 0.047 in
15 = 1,5 mm / 0.059 in
30 = 3,0 mm / 0.118 in
50 = 5,0 mm / 0.197 in

12

Manufacturer specification

$a_{p max}$

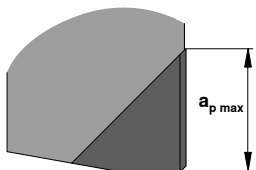

$a_{p max}$

02 = 2,0 mm / 0.078 in
03 = 3,0 mm / 0.118 in
04 = 4,0 mm / 0.157 in
06 = 6,0 mm / 0.236 in
07 = 7,0 mm / 0.275 in
11 = 11,0 mm / 0.433 in

13

Manufacturer specification

F = Fine
M = Medium
R = Rough

Cutting demands when milling

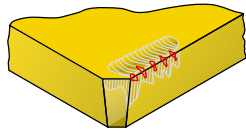
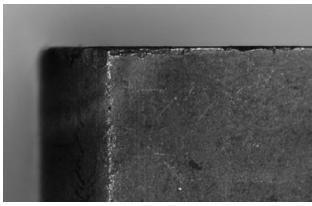

Edge chipping

Cutting speed
Feed per tooth
Toughness of grade
Cutting edge chamfer

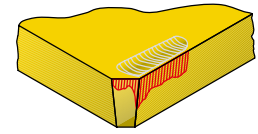

Wear on clearance face

Cutting speed
Feed per tooth
Abrasion resistant grade

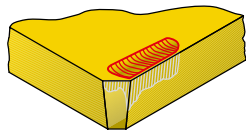
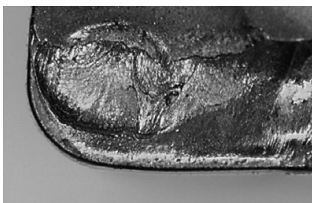

Cratering

Cutting speed
Feed per tooth
Abrasion resistant grade

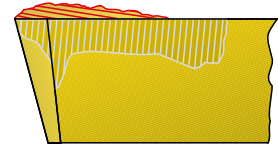
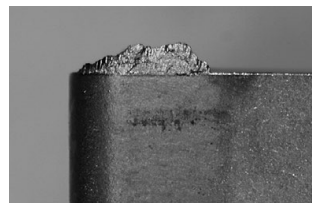

Built-up edge

Cutting speed
Feed per tooth
Wear resistance

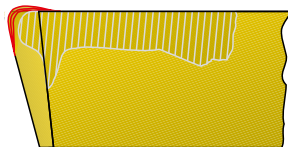
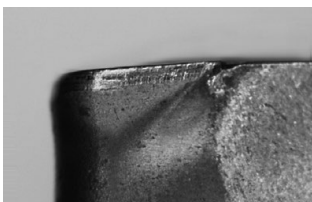

Cutting-edge deformation

Cutting speed
Feed per tooth
Abrasion resistant grade

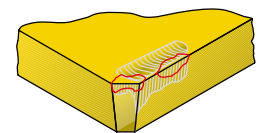
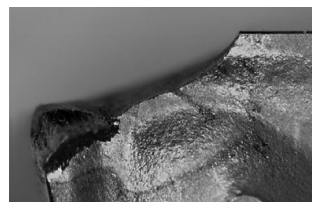

Cutting Edge Breakage

Cutting speed
Toughness of grade



Chip Breakers Overview

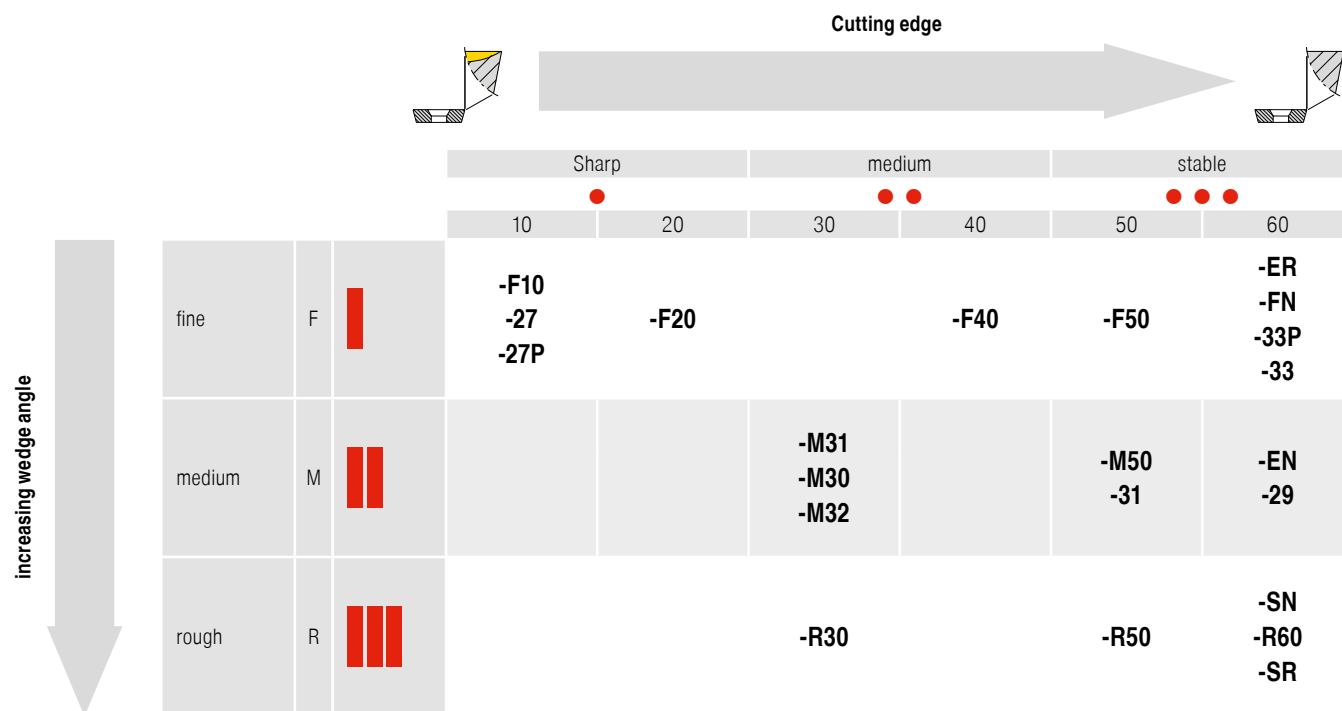

Chip breaker code

Application type		Cutting edge		
		Sharp 10-20	medium 30-40	stable 50-60
light	F	●	●●	●●●
universal	M	●	●●	●●●
difficult	R	●	●●	●●●

Example: Chip breaker -M50



Chip groove description

-27P

- ▲ Highly positive geometry
- ▲ Sharp cutting edges
- ▲ Reduced built up edge
- ▲ First choice for non-ferrous metals

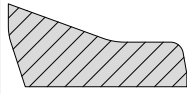

-M30

- ▲ Positive geometry
- ▲ Rounded cutting edge
- ▲ Medium rough machining
- ▲ First choice for martensitic stainless steels

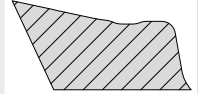

-F10

- ▲ Very positive geometry
- ▲ Sharp cutting edge
- ▲ Prevents sticking and edge build up
- ▲ First Choice for non-ferrous metal

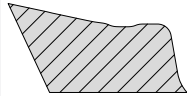

-M31

- ▲ Positive geometry
- ▲ Rounded cutting edge
- ▲ Finish and rough machining
- ▲ For unstable clamping situations
- ▲ For heat-resistant materials, titanium and super alloys

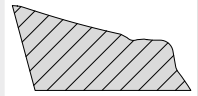

-27

- ▲ Highly positive geometry
- ▲ Sharp cutting edges
- ▲ First choice for non-ferrous metals

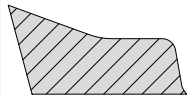

-M32

- ▲ Positive geometry
- ▲ Rounded cutting edge
- ▲ Low cutting force and good stability
- ▲ Medium rough machining
- ▲ First choice for martensitic stainless steels

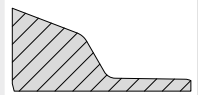

-F20

- ▲ Extremely positive geometry
- ▲ Lightly rounded cutting edge
- ▲ First choice for non-ferrous metals

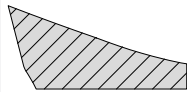

-M50

- ▲ Positive geometry with slightly negative protective chamfer
- ▲ Rounded cutting edge
- ▲ Low cutting force and good stability
- ▲ Light to medium rough machining
- ▲ First choice for general steels

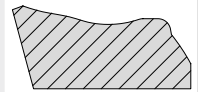

-F40

- ▲ Positive geometry
- ▲ Rounded cutting edge
- ▲ Finish and rough machining
- ▲ For unstable clamping situations
- ▲ For heat-resistant materials, titanium and super alloys

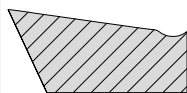

-31

- ▲ Positive geometry with neutral protective chamfer
- ▲ Rounded cutting edge
- ▲ Heavy rough machining
- ▲ Strongly interrupted cuts
- ▲ First choice for cast iron materials

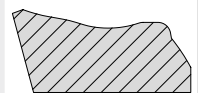

-F50

- ▲ Positive geometry with small positive protective chamfer
- ▲ Rounded cutting edge
- ▲ Low cutting force and good stability
- ▲ For unstable clamping situations
- ▲ Light rough machining
- ▲ First choice for stainless steels

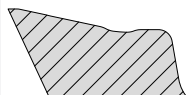

-29

- ▲ Positive geometry with slightly negative protective chamfer
- ▲ Rounded cutting edge
- ▲ Low cutting force and good stability
- ▲ Light to medium rough machining
- ▲ First choice for general steels

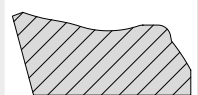

-33P

- ▲ Positive geometry with small neutral protective chamfer
- ▲ Low adhesion
- ▲ Rounded cutting edge
- ▲ Low cutting force and good stability
- ▲ For unstable clamping situations
- ▲ Light rough machining
- ▲ First choice for stainless steels

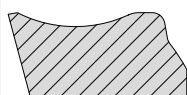

-33

- ▲ Positive geometry with small neutral protective chamfer
- ▲ Rounded cutting edge
- ▲ Low cutting force and good stability
- ▲ For unstable clamping situations
- ▲ Light rough machining
- ▲ First choice for stainless steels

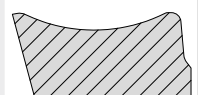

Chip groove description

-29R

- ▲ Positive geometry with slightly negative protective chamfer
- ▲ Heavily rounded cutting edge
- ▲ Low cutting force and good stability
- ▲ Light to medium rough machining
- ▲ First choice for general steels

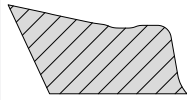

-ER

- ▲ Neutral Geometry
- ▲ Rounded cutting edge
- ▲ Universal application
- ▲ High surface quality due to face chamfer
- ▲ First choice for machining cast iron and non-ferrous metals

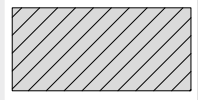

-R30

- ▲ Positive geometry with slightly negative protective chamfer
- ▲ Heavily rounded cutting edge
- ▲ Low cutting force and good stability
- ▲ Light to medium rough machining
- ▲ First choice for general steels

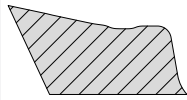

-EN

- ▲ Neutral geometry
- ▲ Rounded cutting edge
- ▲ High surface quality due to face chamfer (radial protective chamfer on indexable insert)
- ▲ First choice for machining cast iron and non-ferrous metals

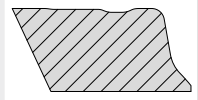

-R50

- ▲ Slightly positive geometry
- ▲ Rounded cutting edge
- ▲ Medium rough machining
- ▲ Strongly interrupted cuts
- ▲ First choice for cast iron materials

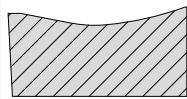

-SN

- ▲ Neutral geometry
- ▲ Rounded cutting edge
- ▲ High surface quality due to face chamfer (radial protective chamfer on indexable insert)
- ▲ Low cutting forces
- ▲ First choice for good flatness

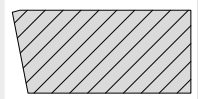

-R60

- ▲ Positive geometry with negative stable protective chamfer
- ▲ Heavily rounded cutting edge
- ▲ For stable machining conditions
- ▲ First choice for heavily interrupted cuts
- ▲ Heavy rough machining
- ▲ First choice for cast iron materials

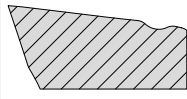

-SR

- ▲ Neutral geometry with negative protective chamfer
- ▲ Rounded cutting edge
- ▲ Robust indexable insert
- ▲ For poor machining conditions
- ▲ First choice for machining cast iron and steels

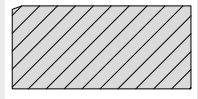

-FN

- ▲ Neutral and highly stable geometry
- ▲ Heavily rounded cutting edge
- ▲ For stable machining conditions
- ▲ First choice for hard machining up to approx. 50 HRC

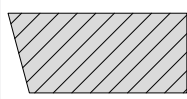

-FR

- ▲ Neutral Geometry
- ▲ Slightly rounded and stable cutting edge
- ▲ Associated with Ceramic and CBN cutting materials.
- ▲ For stable machining situations
- ▲ First choice for machining cast irons

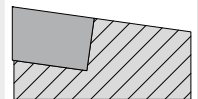

Grades Overview

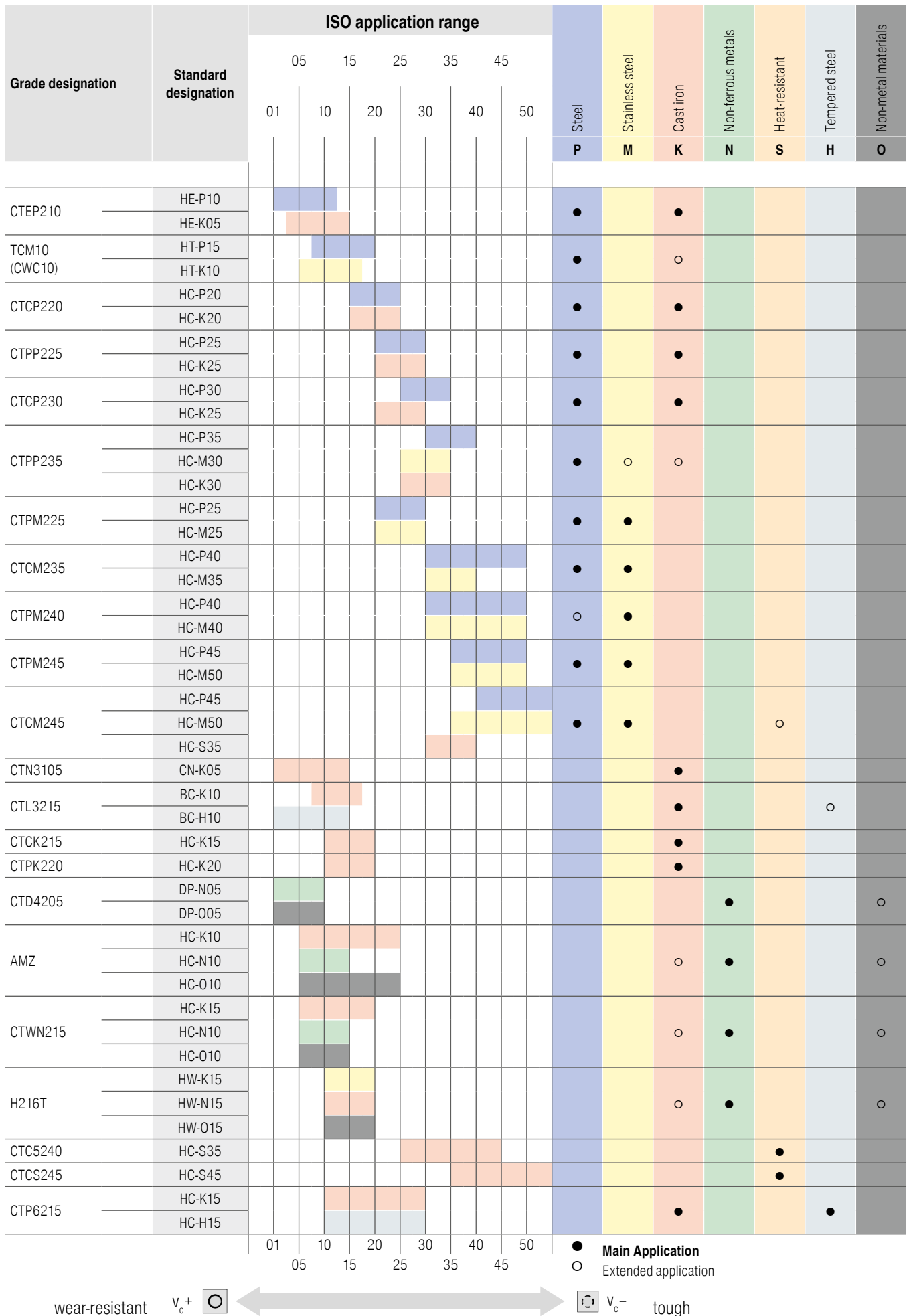

wear-resistant V_c^+ V_c^- tough

Grade description

AMZ

- ▲ Carbide, TiAlN-coated
- ▲ ISO | K10 | N10 | O10
- ▲ The coated carbide grade for aluminium machining

CTC5240

- ▲ Carbide, TiN-TiB₂-coated
- ▲ ISO | S35
- ▲ The special grade for machining titanium and titanium alloys

CTCK215

- ▲ Carbide, TiCN-Al₂O₃-coated
- ▲ ISO | K15
- ▲ The first choice for machining cast iron materials at high cutting speeds

CTCM235

- ▲ Carbide, TiCN-Al₂O₃-coated
- ▲ ISO | P40 | M35
- ▲ The tough alternative for general steel machining
- ▲ Well suited to martensitic steel materials

CTCM245

- ▲ Carbide, TiCN-Al₂O₃ coated
- ▲ ISO M45/P50; S35
- ▲ Special grade for machining high-alloy steel materials

CTCP220

- ▲ Carbide, TiCN-Al₂O₃-coated
- ▲ ISO | P20 | K20
- ▲ The wear-resistant grade for dry machining steels

CTCP225

- ▲ Carbide, TiAlTaN-coated
- ▲ ISO | P25 | K25
- ▲ The wear-resistant grade for wet machining of steels

CTCP230

- ▲ Carbide, TiCN-Al₂O₃-coated
- ▲ ISO | P30 | K25
- ▲ The first choice for dry machining steel at high cutting speeds

CTD4205

- ▲ Carbide, uncoated
- ▲ ISO | N05 | O05
- ▲ Polycrystalline diamond grade for machining non-ferrous metals and non-metallic materials

CTEP210

- ▲ Cermet, TiCN-Al₂O₃-coated
- ▲ ISO | P10 | K05
- ▲ The coated cermet grade with reserves of toughness for finish machining at high cutting speeds

CTP6215

- ▲ Carbide, TiAlN-coated
- ▲ ISO | K15 | H15
- ▲ The coated carbide grade for hard machining

CTPK220

- ▲ Carbide, TiAlTaN-coated
- ▲ ISO | K20
- ▲ Optimal for machining high-strength cast iron materials in the tougher application range

CTPM225

- ▲ Carbide, TiAlTaN-coated
- ▲ ISO | P25 | M25
- ▲ The wear-resistant choice for machining austenitic steels

CTPM240

- ▲ Carbide, TiAlTaN-coated
- ▲ ISO | P40 | M40
- ▲ The first choice for machining austenitic steels

CTPM245

- ▲ Carbide, TiAlTaN-coated
- ▲ ISO | M45 | P50
- ▲ The first choice for machining martensitic steels

Grade description

CTPP235

- ▲ Carbide, TiAlTaN-coated
- ▲ ISO | **P35** | M30 | K30
- ▲ The wear-resistant grade for wet machining of steels

TCM10

- ▲ Cermet, uncoated
- ▲ ISO | **P15** | **M10** | K10
- ▲ The uncoated cermet grade for finish machining stainless and hardened steel
- ▲ Particularly wear resistant thanks to high heat resistance

CTWN215

- ▲ Carbide, uncoated
- ▲ ISO | K15 | **N10** | O10
- ▲ Uncoated carbide grade for machining non-ferrous metals

CTCS245

- ▲ Carbide, CVD TiN-TiB2 coated
- ▲ ISO | **S45**
- ▲ The special grade for machining nickel-based alloys

H216T

- ▲ Carbide, uncoated
- ▲ ISO | K15 | **N15** | O15
- ▲ The uncoated carbide grade for machining aluminium and other non-ferrous metals
- ▲ Also highly suitable for HSC machining

Grade description

C T C P 2 2 0 (Example)

Main application – material

- 1|P Steel
- 2|M Stainless steel
- 3|K Cast iron
- 4|N Light and non ferrous metals
- 5|S Super alloys, titanium
- 6|H Hard materials
- 7|X Universal application

Application

- 1 Turning
- 2 Milling
- 3 Grooving
- 4 Drilling
- 5 Thread turning
- 6 Others
- 7 Several processes

Degree of hardness

- 05 ISO 05
- 10 ISO 10
- 15 ISO 15
- ...

Grade description – Indexable insert countersink

BK8425

- ▲ Carbide, TiAlN/TiN-coated
- ▲ ISO | **P25** | **M25** | **K25**
- ▲ Universal grade with greater wear resistance thanks to innovative PVD multi-layer coating

K10

- ▲ Carbide, uncoated
- ▲ ISO | **K10**
- ▲ Uncoated carbide grade for machining grey cast iron or non-ferrous metals, depending on the cutting edge geometry

Chip breakers

-SM

- ▲ Rake angle 15°
- ▲ For universal use with medium machining
- ▲ Stable cutting edge

-U877

- ▲ Rake angle 6°
- ▲ circumferentially ground
- ▲ Three-ground chip breaker with second clearance angle for clearance with small tool diameters

-G06

- ▲ Rake angle 6°
- ▲ Preferred application in P / M / K
- ▲ Characterized by a particularly stable wedge angle

-G12

- ▲ Rake angle 12°
- ▲ Preferred application in P / N / S
- ▲ is characterized by a particularly high cutting performance

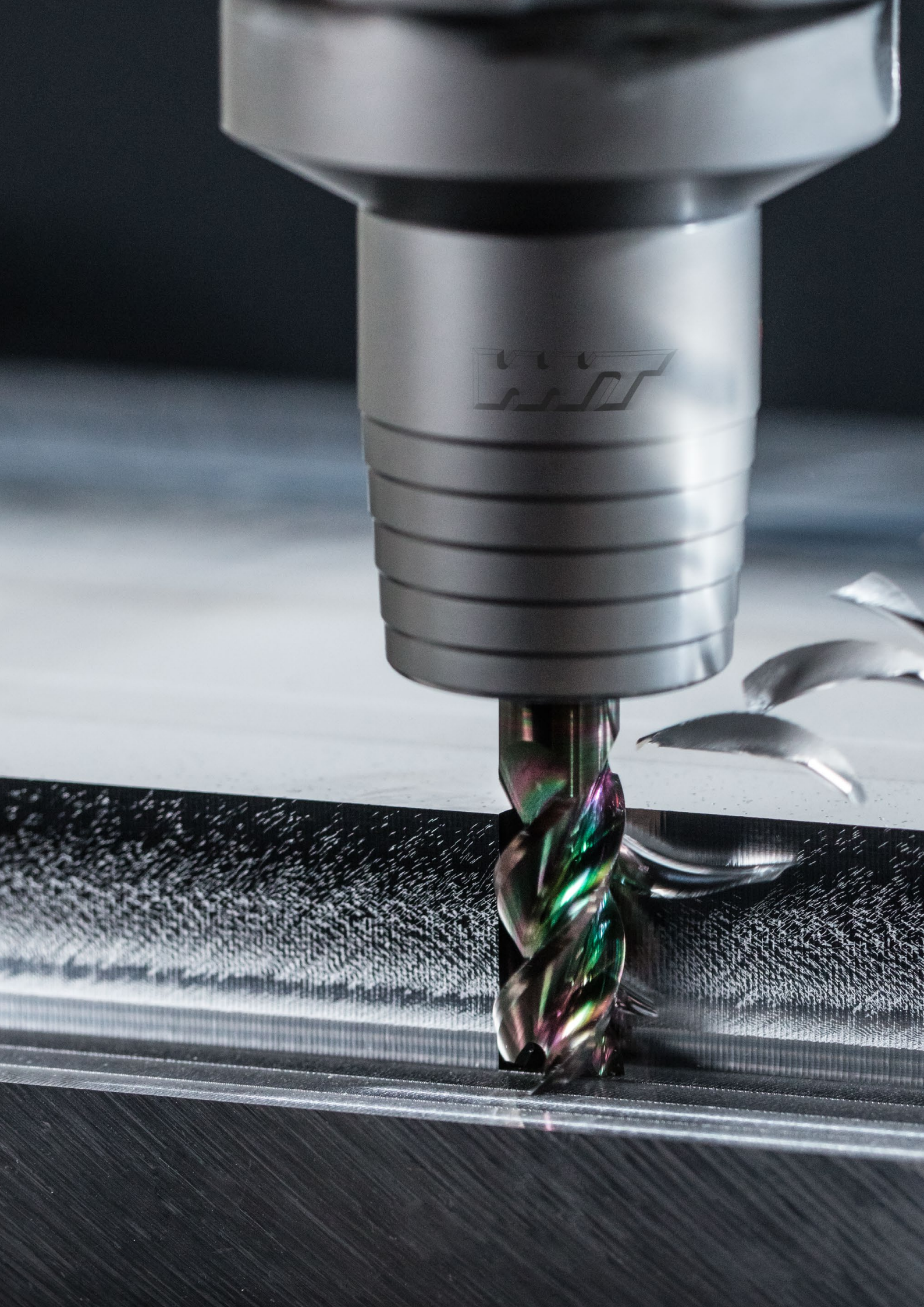

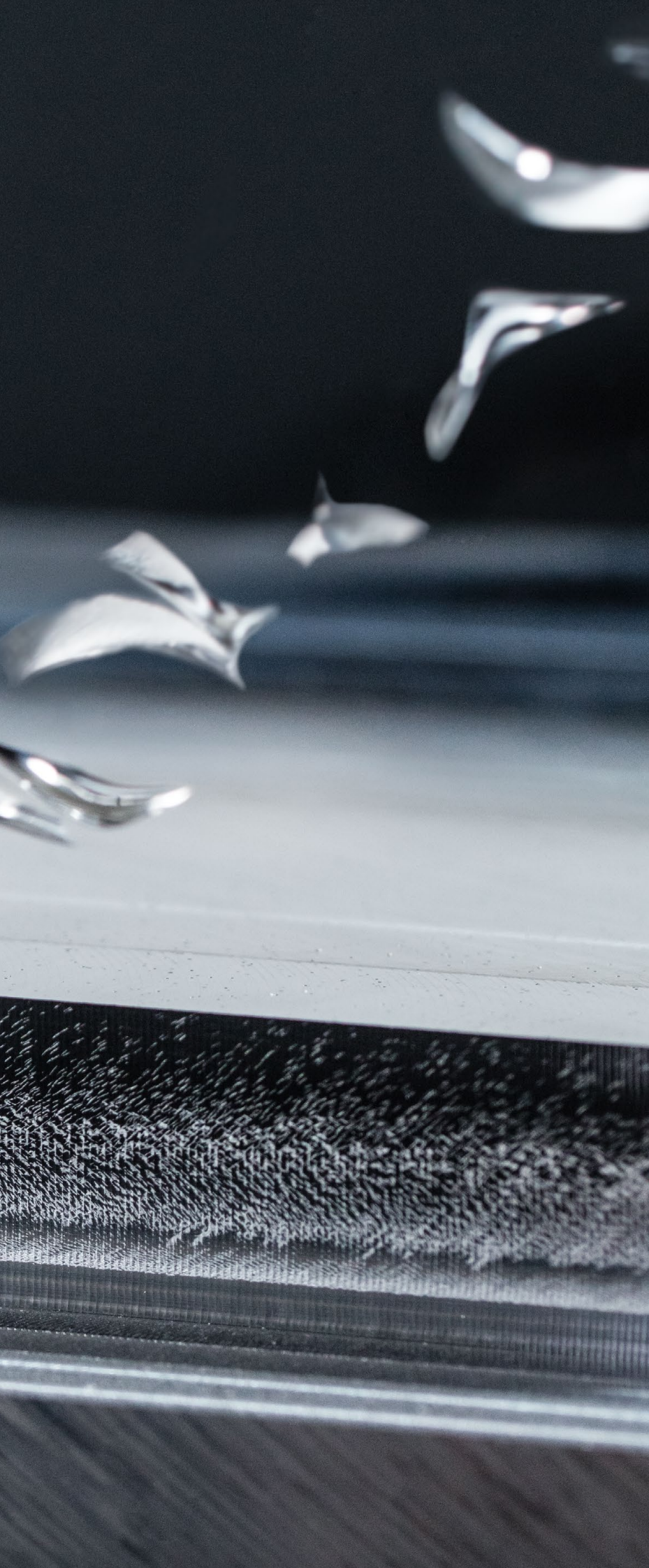

1 Indexable Drilling

Holemaking

2 Indexable Boring

3 Reaming

4 Indexable Turning

Turning

5 Parting and Grooving

6 Multifunction

Milling

7 Indexable Milling

8 Solid Milling

9 Material examples and
article no. index

Table of contents

Symbol explanation	2
Toolfinder	3
List of contents	4-6
Product program	7-101
Technical Information	
Cutting Data	102-137
Technical references	138-140
General references	141+142
Tool types / Coatings	143

CERATIZIT \ Performance

Premium quality tools for high performance.

The premium quality tools from the **CERATIZIT Performance** product line have been designed for specific applications and are distinguished by their outstanding performance. If you make high demands on the performance of your production and want to achieve the very best results, we recommend the Premium tools in this product line.

CERATIZIT \ Standard

Quality tools for standard applications.

The quality tools of the **CERATIZIT Standard** product line are high quality, powerful and reliable and enjoy the highest trust of our customers worldwide. Tools from this product line are the first choice for many standard applications and guarantee optimal results.

Symbol explanation

Shank

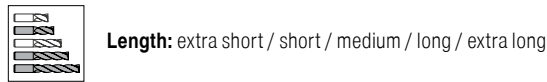
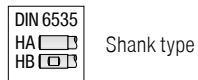

Application

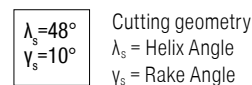
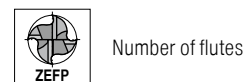
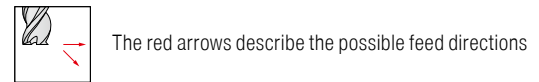
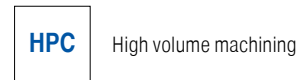

Cutting edge preparation



- = Main Application
- = Extended application

Toolfinder

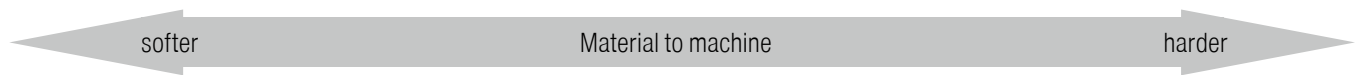

Finish milling

P		•		•	Steel
M		•			Stainless steel
K		•			Cast iron
N	•				Non-ferrous metals
S		•			Heat resistant alloys
H				•	Hardened steel
O					Non metal materials

7-16	17-48	36-46
69-93	82-93	94-95
94-95	96-101	96-101

Rough and finish machining

P		•		•	Steel
M		•			Stainless steel
K		•			Cast iron
N	•				Non-ferrous metals
S		•			Heat resistant alloys
H				•	Hardened steel
O					Non metal materials











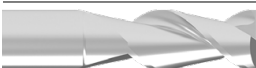

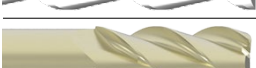





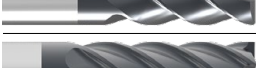

49+50	51-60	36-46
-------	-------	-------

Rough machining















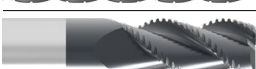

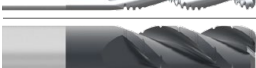

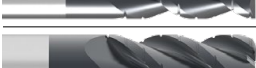

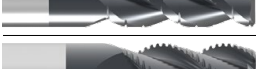







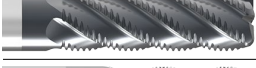







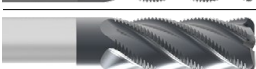

























P		•		•	Steel
M		•			Stainless steel
K		•			Cast iron
N	•				Non-ferrous metals
S		•			Heat resistant alloys
H				•	Hardened steel
O					Non metal materials

56+57	61-68
-------	-------













Overview High Performance Milling Cutters

Image	Series	Tool type	Number of flutes 	Diameter in inch Ø DC	Material compatibility						Geometry				Tool design	Coating		CERATIZIT Standard	CERATIZIT Performance
					Steel	Stainless steel	Cast iron	Non-ferrous metals	Heat-resistant	Tempered steel	Non-metal materials	Square end	Corner chamfer	Corner radius		Full Radius	Length		
	P220	AL	2	1/8"-3/4"	HA													7	
	S142	AL	2	1/8"-1"	HA													8+9	
	P109	AL	3	1/8"-1"	HA													10+11	
	P362	AL	3	3/16"-1"	HA									HPC				12	
	P362	AL	3	3/16"-1"	HA									HPC				13-15	
	P376	AL	6	1/4"-1"	HA													16	
	S642	UN	2	1/16"-1"	HA													17+18	
	S642	UN	2	1/8"-3/4"	HA													19+20	
	S643	UN	3	1/16"-1"	HA													21+22	
	S643	UN	3	1/8"-1"	HA													23	
	S644	UN	4	1/32"-1"	HA													25+26	
	S644	UN	4	1/8"-1"	HA													27-35	
	S645	UN	5	1/8"-1"	HA													36	
	P007	UN	4	1/8"-1"	HA									HPC				37	
	P007	UN	4	1/8"-1"	HA									HPC				38-41	
	P556	UN	5	1/4"-1"	HA									HPC				42	
	P556	UN	5	1/4"-1"	HA									HPC				43-46	
	P160	UN	7	1/4"-1"	HA									HPC				47	
	P161	UN	7	1/4"-1"	HA									HPC				48	
	P119	AL	3	1/8"-1"	HA													49+50	
	P117	UN	3	1/8"-3/4"	HA													51	
	P120	UN	4	3/8"-1"	HA									HPC				52-54	

Overview High Performance Milling Cutters

Image	Series	Tool type	Number of flutes 	Diameter in inch Ø DC	Material compatibility						Geometry				Tool design	Coating		CERATIZIT Standard	CERATIZIT Performance
					Steel	Stainless steel	Cast iron	Non-ferrous metals	Heat-resistant	Tempered steel	Non-metal materials	Square end	Corner chamfer	Corner radius		Full Radius	Length		
	P121	UN	5	3/4"-1"	●	●	●	●	●	●						HPC	<input checked="" type="checkbox"/>	<input type="checkbox"/>	55
	P102	AL	3	3/16"-1"	●	●	●	●	●	●							<input checked="" type="checkbox"/>	<input type="checkbox"/>	56-58
	P190	UN	4	3/16"-1"	●	●	●	●	●	●	<input checked="" type="checkbox"/>					HPC	<input checked="" type="checkbox"/>	<input type="checkbox"/>	59
	P191	UN	4	3/16"-1"	●	●	●	●	●	●						HPC	<input checked="" type="checkbox"/>	<input type="checkbox"/>	60
	P100	UN	3	3/16"	●	●	●	●	●	●							<input checked="" type="checkbox"/>	<input type="checkbox"/>	61
	P100	UN	4	1/4"-3/4"	●	●	●	●	●	●							<input checked="" type="checkbox"/>	<input type="checkbox"/>	62+63
	P100	UN	5	1"	●	●	●	●	●	●							<input checked="" type="checkbox"/>	<input type="checkbox"/>	64
	P101	Ti	3	3/16"	●	●	●	●	●	●						HPC	<input checked="" type="checkbox"/>	<input type="checkbox"/>	65
	P101	Ti	4	1/4"-3/4"	●	●	●	●	●	●						HPC	<input checked="" type="checkbox"/>	<input type="checkbox"/>	66+67
	P101	Ti	5	1"	●	●	●	●	●	●							<input checked="" type="checkbox"/>	<input type="checkbox"/>	68
	S662	UN	2	1/16"-1"	●	●	●	●	●	●							<input checked="" type="checkbox"/>	<input type="checkbox"/>	69+70
	S663	UN	3	1/8"-1"	●	●	●	●	●	●							<input checked="" type="checkbox"/>	<input type="checkbox"/>	71-73
	P157	UN	4	1/8"-1"	●	●	●	●	●	●						HPC	<input checked="" type="checkbox"/>	<input type="checkbox"/>	74
	S664	UN	4	1/32"-1"	●	●	●	●	●	●							<input checked="" type="checkbox"/>	<input type="checkbox"/>	75+76
	P250	ST	2	1/8"-1/2"	●	●	●	●	●	●							<input checked="" type="checkbox"/>	<input type="checkbox"/>	77
	P251	UN	2	0.031"-0.187"	●	●	●	●	●	●							<input checked="" type="checkbox"/>	<input type="checkbox"/>	78
	P252	UN	2	0.031"-0.187"	●	●	●	●	●	●							<input checked="" type="checkbox"/>	<input type="checkbox"/>	79
	P253	UN	2	0.031"-0.187"	●	●	●	●	●	●							<input checked="" type="checkbox"/>	<input type="checkbox"/>	80
	P254	UN	2	0.031"-0.187"	●	●	●	●	●	●							<input checked="" type="checkbox"/>	<input type="checkbox"/>	81
	P501	UN	4	0.005"-0.120"	●	●	●	●	●	●	<input checked="" type="checkbox"/>						<input checked="" type="checkbox"/>	<input type="checkbox"/>	82-84
	P504	UN	4	0.005"-0.120"	●	●	●	●	●	●	<input checked="" type="checkbox"/>						<input checked="" type="checkbox"/>	<input type="checkbox"/>	85-87
	P503	UN	4	0.005"-0.120"	●	●	●	●	●	●							<input checked="" type="checkbox"/>	<input type="checkbox"/>	88-90

Overview High Performance Milling Cutters

Image	Series	Tool type	Number of flutes 	Diameter in inch Ø DC	Material compatibility						Geometry				Tool design	Coating		CERATIZIT \ Standard	CERATIZIT \ Performance
					Steel	Stainless steel	Cast iron	Non-ferrous metals	Heat-resistant	Tempered steel	Non-metal materials	Square end	Corner chamfer	Corner radius		Full Radius	Length		
	P506	UN	4	0.005-0.120	●	●	●	●	●	●							<input checked="" type="checkbox"/>	<input type="checkbox"/>	91-93
	P137	UN	2	0.010-0.155	●	●	●	●	●	●							<input checked="" type="checkbox"/>	<input type="checkbox"/>	94
	P139	UN	4	0.010-0.155	●	●	●	●	●	●							<input checked="" type="checkbox"/>	<input type="checkbox"/>	95
	P132	UN	2	1/8-1/2	●	●	●	●	●	●							<input checked="" type="checkbox"/>	<input type="checkbox"/>	96
	P133	UN	4	1/4-1/2	●	●	●	●	●	●							<input checked="" type="checkbox"/>	<input type="checkbox"/>	97
	P134	UN	2	1/8-1/2	●	●	●	●	●	●							<input checked="" type="checkbox"/>	<input type="checkbox"/>	98
	P135	UN	4	1/4-1/2	●	●	●	●	●	●							<input checked="" type="checkbox"/>	<input type="checkbox"/>	99
	P130	UN	2	1/4-1/2	●	●	●	●	●	●							<input checked="" type="checkbox"/>	<input type="checkbox"/>	100
	P131	UN	4	1/4-1/2	●	●	●	●	●	●							<input checked="" type="checkbox"/>	<input type="checkbox"/>	101

End milling cutter

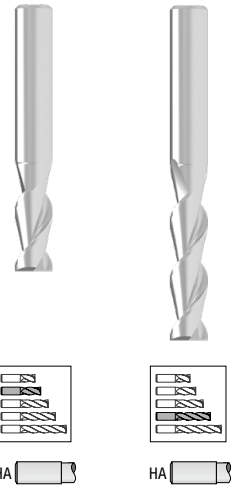
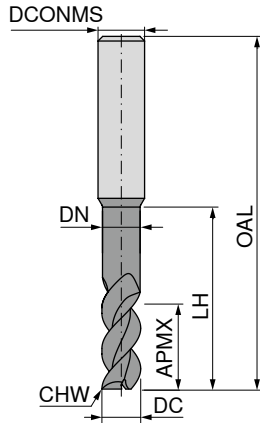
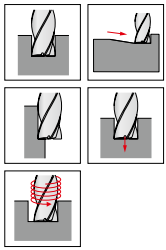
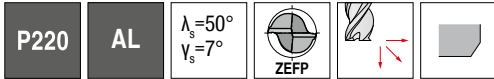

DC <small>+0.000/-0.002</small>	APMX	DN	LH	OAL	DCONMS <small>-0.0001/-0.0004</small>	CHW	ZEFP
inch	inch	inch	inch	inch	inch	inch	
1/8	3/8	0.120	3/4	2	1/8	0.006	2
3/16	7/16	0.180	3/4	2	3/16	0.006	2
1/4	1/2	0.240	13/16	2 1/2	1/4	0.006	2
5/16	3/4	0.300	1	3	5/16	0.006	2
3/8	7/8	0.360	1 1/8	3	3/8	0.006	2
1/2	1	0.480	1 3/8	3	1/2	0.006	2
1/2	1 1/4	0.480	1 5/8	3 1/2	1/2	0.006	2
5/8	1 1/4	0.600	1 7/8	4	5/8	0.006	2
3/4	1 1/2	0.720	2 1/4	5	3/4	0.006	2

59 003 ...	59 003 ...
12530	
18824	
	25020
	31324
	37523
50020	
	50025
	62520
	75020

P
M
K
N
S
H
O

→ v_c/f_z Page 103

End milling cutter

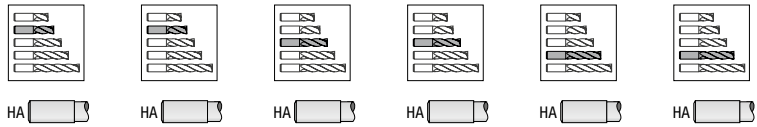
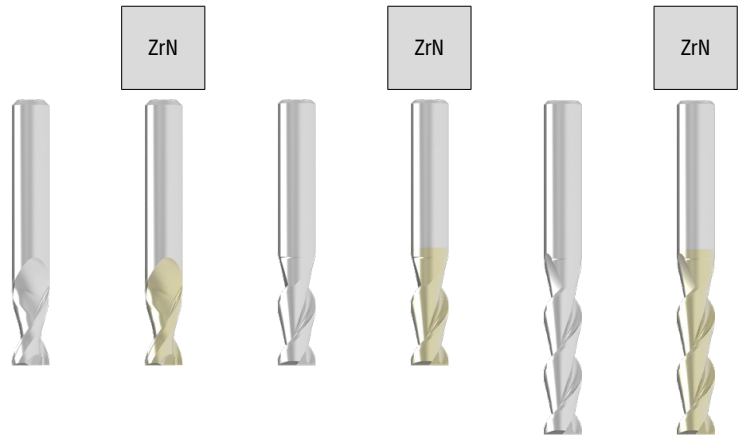
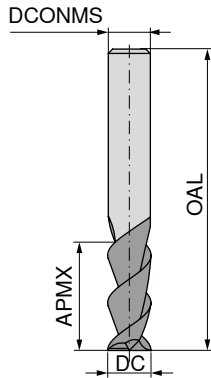
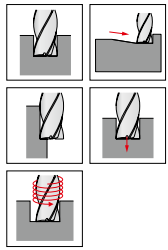
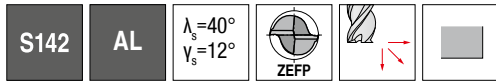

DC +0.0001/-0.002 inch	APMX inch	OAL inch	DCONMS -0.0001/-0.0004 inch	ZEFP	59 053 ...	59 054 ...	59 053 ...	59 054 ...	59 053 ...	59 054 ...
1/8	1/4	1 1/2	1/8	2	12520	12520				
1/8	3/8	1 1/2	1/8	2					12530	12530
5/32	5/16	2	3/16	2	15620	15620			15636	15636
5/32	9/16	2	3/16	2					18830	18830
3/16	5/16	2	3/16	2	18817	18817				
3/16	9/16	2	3/16	2					21917	21917
7/32	3/8	2	1/4	2	21917	21917			25015	25015
1/4	3/8	2	1/4	2	25015	25015				
1/4	3/4	2 1/2	1/4	2					25030	25030
5/16	13/16	2 1/2	5/16	2	31326	31326				
5/16	1 1/4	4	5/16	2					31340	31340
11/32	1	2 1/2	3/8	2	34429	34429				
3/8	1/2	2 1/2	3/8	2	37513	37513				
3/8	1	2 1/2	3/8	2			37527	37527		
3/8	1 1/2	4	3/8	2					37540	37540
1/2	5/8	2 1/2	1/2	2	50013	50013				
1/2	1 1/4	3	1/2	2					50025	50025
1/2	2	4	1/2	2			50040	50025		50040
5/8	15/8	3 1/2	5/8	2					62526	62526
3/4	1	4	3/4	2	75013	75013				
3/4	15/8	4	3/4	2			75022	75022		
3/4	3	6	3/4	2					75040	75040
1	2	5	1	2					99920	99920

P										
M										
K										
N					•	•	•	•	•	•
S										
H										
O										

End milling cutter

S142
AL
 $\lambda_s=40^\circ$
 $\nu_s=12^\circ$
ZEPF

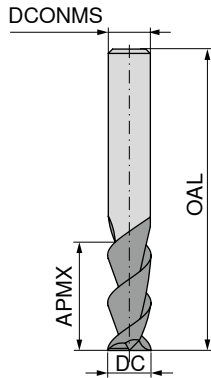
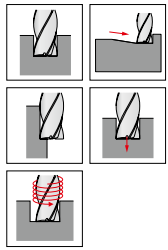

ZrN



HA



HA

DC <small>+0.000/-0.002</small> inch	APMX inch	OAL inch	DCONMS <small>-0.0001/-0.0004</small> inch	ZEPF
1/4	1 1/4	3 1/2	1/4	2
5/16	2 1/8	4	5/16	2
3/8	2 1/2	6	3/8	2
1/2	3	6	1/2	2
3/4	4	7	3/4	2
1	3	6	1	2

59 053 ...	59 054 ...
25050	25050
31368	31368
37567	37567
50060	50060
75053	75053
99930	99930

P	
M	
K	
N	•
S	•
H	
O	

→ v_c/f_z Page 104

End milling cutter

P109 **AL** $\lambda_s=40^\circ$
 $\nu_s=15^\circ$

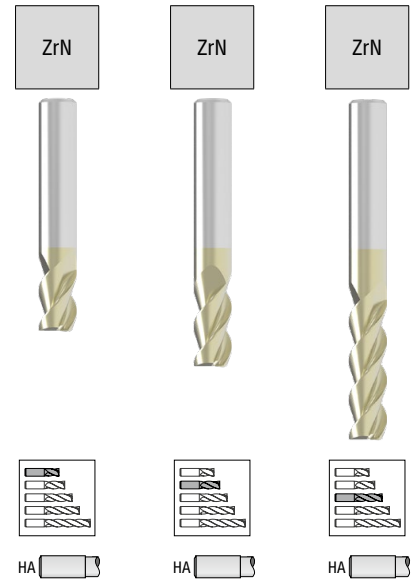
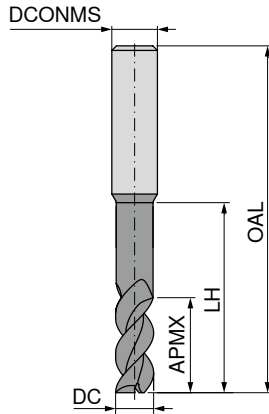
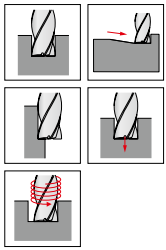

DC $+0.000/-0.002$ inch	APMX inch	OAL inch	DCONMS $-0.0001/-0.0004$ inch	ZEFP
1/8	1/4	1 1/2	1/8	3
5/32	3/8	2	3/16	3
3/16	3/8	2	3/16	3
7/32	3/8	2	1/4	3
1/4	3/8	2	1/4	3
1/4	3/4	2 1/2	1/4	3
1/4	1 1/4	3	1/4	3
9/32	1/2	2 1/2	5/16	3
5/16	1/2	2 1/2	5/16	3
3/8	5/8	2	3/8	3
3/8	7/8	2 1/2	3/8	3
3/8	1 1/2	3 1/2	3/8	3
7/16	1	2 3/4	7/16	3
1/2	5/8	2 1/2	1/2	3
1/2	1 1/2	3 1/2	1/2	3
5/8	7/8	3	5/8	3
5/8	1 3/4	4	5/8	3
3/4	1	3	3/4	3
3/4	2 1/2	5	3/4	3
1	2 3/4	5	1	3

59 027 ...	59 027 ...	59 027 ...
	12520	
	15624	
	18820	
	21917	
25015	25030	25050
	28118	
	31316	
37517	37523	37540
	43823	
	50013	50030
	62514	62528
	75013	75033
		99928

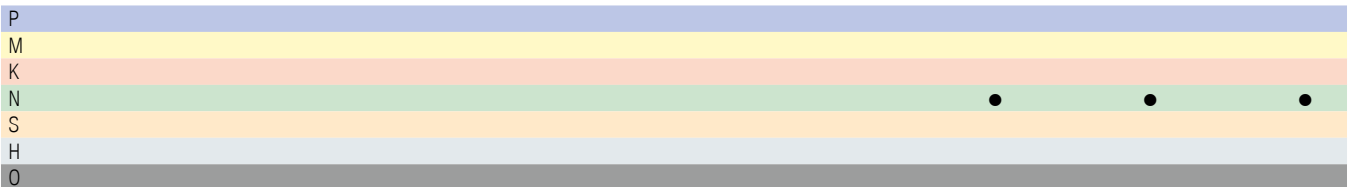

→ v_c/f_z Page 105

End milling cutter

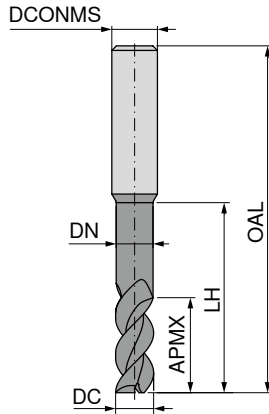
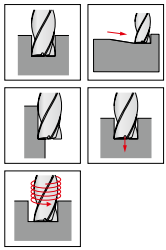
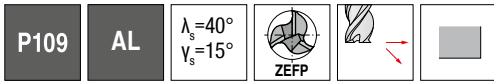

DC	APMX	DN	LH	OAL	DCONMS	ZEFP
<small>+0.000/-0.002</small>					<small>-0.0001/-0.0004</small>	
inch	inch	inch	inch	inch	inch	
1/8	1/2			1 1/2	1/8	3
5/32	1/2			2	3/16	3
3/16	5/8			2	3/16	3
7/32	3/4			2 1/2	1/4	3
1/4	3/4	0.240	2 1/8	4	1/4	3
1/4	1 1/2			3 1/2	1/4	3
9/32	3/4			2 1/2	5/16	3
5/16	3/4			2 1/2	5/16	3
3/8	1	0.360	2 3/8	6	3/8	3
3/8	2			4	3/8	3
1/2	1 1/4			3	1/2	3
1/2	2			4	1/2	3
9/16	1 1/4			3 1/2	9/16	3
5/8	1 1/4			3 1/2	5/8	3
5/8	2 1/2			5	5/8	3
3/4	1 5/8			4	3/4	3
3/4	3 1/4			6	3/4	3
1	1 3/4			4	1	3
1	3 3/8			6	1	3

59 027 ...	59 027 ...
12540	
15632	
18833	
21934	
25130	
	25060
28127	
31324	
37527	
	37553
50025	
	50040
56322	
62520	
	62540
75022	
	75043
99918	
	99934

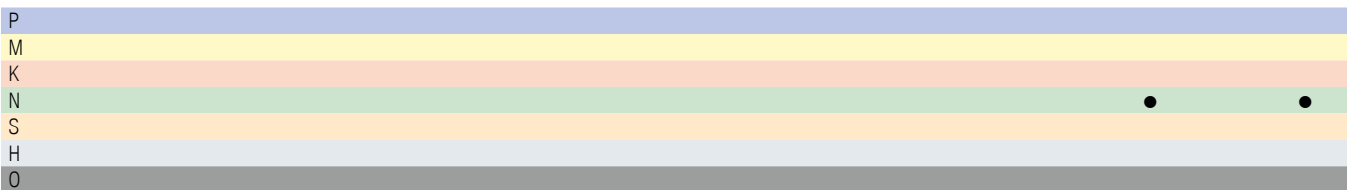

→ v_c/f_z Page 105

End milling cutter

P362
AL
 $\lambda_s=43^\circ$
 45°
 48°
 $\gamma_s=13^\circ$
ZEFP
HPC

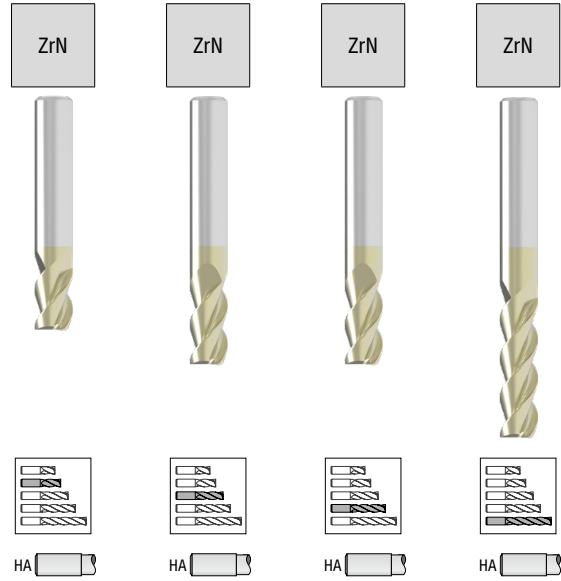
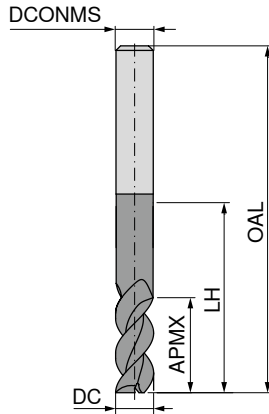
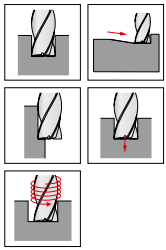

DC $+0.000/-0.002$	APMX	OAL	DCONMS $-0.0001/-0.0004$	ZEFP
inch	inch	inch	inch	
3/16	3/8	2	3/16	3
3/16	3/4	2 1/2	3/16	3
3/16	1	3	3/16	3
1/4	3/8	2	1/4	3
1/4	3/4	2 1/2	1/4	3
1/4	1	3	1/4	3
3/8	1/2	2	3/8	3
3/8	1	2 1/2	3/8	3
3/8	1 1/2	3 1/2	3/8	3
1/2	5/8	2 1/2	1/2	3
1/2	1	3	1/2	3
1/2	1 1/4	3	1/2	3
1/2	1 5/8	4	1/2	3
1/2	2	4	1/2	3
5/8	3/4	3	5/8	3
5/8	1 1/4	3 1/2	5/8	3
5/8	1 5/8	4	5/8	3
3/4	1	3	3/4	3
3/4	1 5/8	4	3/4	3
3/4	2 1/4	5	3/4	3
1	1 1/4	4	1	3
1	2	5	1	3
1	3 1/4	6	1	3

59 004 ...	59 004 ...	59 004 ...	59 004 ...
18820		18840	18853
25015		25030	25040
37513		37527	37540
50013	50020	50025	50033
			50040
62512	62520	62526	
75013		75022	75030
99913		99920	99933

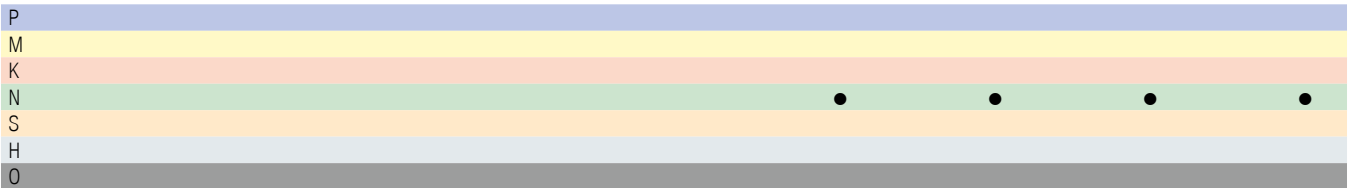

End milling cutter with corner radius

▲ Radius accuracy: +/- 0.001 for $\varnothing \leq 0.060$
+/- 0.0015 for $\varnothing > 0.060$

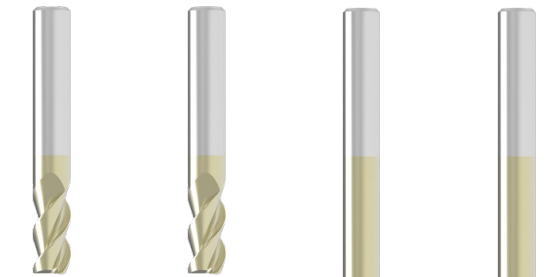
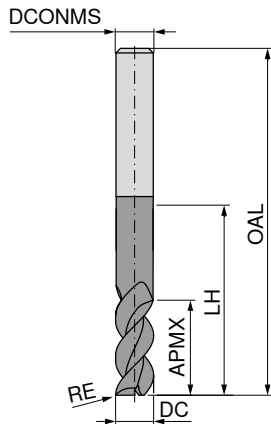
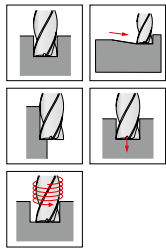
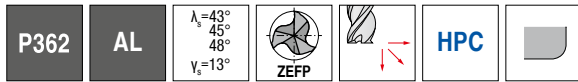

DC +0.000/-0.002 inch	RE inch	APMX inch	OAL inch	DCONMS -0.0001/-0.0004 inch	ZEFP
3/16	0.015	3/8	2	3/16	3
3/16	0.030	3/8	2	3/16	3
3/16	0.015	3/4	2 1/2	3/16	3
3/16	0.030	3/4	2 1/2	3/16	3
3/16	0.015	1	3	3/16	3
3/16	0.030	1	3	3/16	3
1/4	0.015	3/8	2	1/4	3
1/4	0.030	3/8	2	1/4	3
1/4	0.060	3/8	2	1/4	3
1/4	0.015	3/4	2 1/2	1/4	3
1/4	0.030	3/4	2 1/2	1/4	3
1/4	0.060	3/4	2 1/2	1/4	3
1/4	0.015	1	3	1/4	3
1/4	0.030	1	3	1/4	3
1/4	0.060	1	3	1/4	3
3/8	0.015	1/2	2	3/8	3
3/8	0.030	1/2	2	3/8	3
3/8	0.060	1/2	2	3/8	3
3/8	0.090	1/2	2	3/8	3
3/8	0.015	1	2 1/2	3/8	3
3/8	0.030	1	2 1/2	3/8	3
3/8	0.060	1	2 1/2	3/8	3
3/8	0.090	1	2 1/2	3/8	3
3/8	0.015	1 1/2	3 1/2	3/8	3
3/8	0.030	1 1/2	3 1/2	3/8	3
3/8	0.060	1 1/2	3 1/2	3/8	3
3/8	0.090	1 1/2	3 1/2	3/8	3
1/2	0.015	5/8	2 1/2	1/2	3
1/2	0.030	5/8	2 1/2	1/2	3
1/2	0.060	5/8	2 1/2	1/2	3
1/2	0.090	5/8	2 1/2	1/2	3
1/2	0.125	5/8	2 1/2	1/2	3
1/2	0.015	1	3	1/2	3
1/2	0.030	1	3	1/2	3
1/2	0.060	1	3	1/2	3
1/2	0.090	1	3	1/2	3
1/2	0.125	1	3	1/2	3
1/2	0.015	1 1/4	3	1/2	3
1/2	0.030	1 1/4	3	1/2	3

59 004 ...	59 004 ...	59 004 ...	59 004 ...
90020			
90120			
		90040	
		90140	
			90053
			90153
90015			
90115			
90215			
		90030	
		90130	
		90230	
			90240
			90340
			90440
90013			
90113			
90213			
90313			
90027			
90127			
90227			
90327			
			90540
			90640
			90740
			90840
90413			
90513			
90613			
90713			
90813			
	90220		
	90320		
	90420		
	90520		
	90620		
		90025	
		90125	

P				
M				
K				
N				
S				
H				
O				

End milling cutter with corner radius

▲ Radius accuracy: +/- 0.001 for $\varnothing \leq 0.060$
+/- 0.0015 for $\varnothing > 0.060$

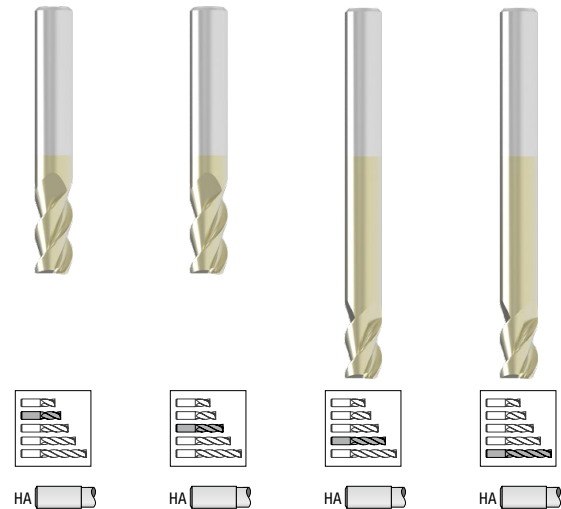
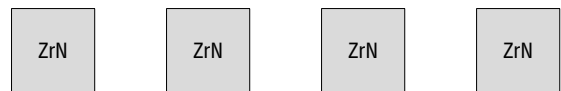
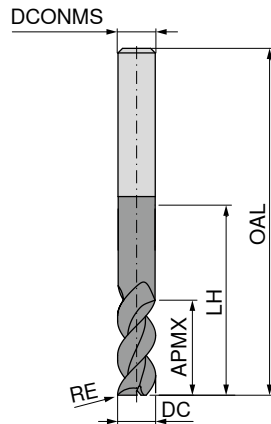
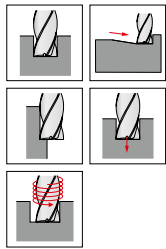
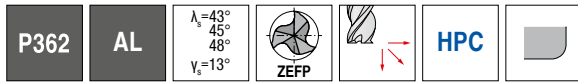

DC	RE	APMX	OAL	DCONMS	ZEFP	59 004 ...	59 004 ...	59 004 ...	59 004 ...
1/2	0.060	1 1/4	3	1/2	3			90225	
1/2	0.090	1 1/4	3	1/2	3			90325	
1/2	0.125	1 1/4	3	1/2	3			90425	
1/2	0.015	1 5/8	4	1/2	3				90033
1/2	0.030	1 5/8	4	1/2	3				90133
1/2	0.060	1 5/8	4	1/2	3				90233
1/2	0.090	1 5/8	4	1/2	3				90333
1/2	0.125	1 5/8	4	1/2	3				90433
1/2	0.015	2	4	1/2	3				90940
1/2	0.030	2	4	1/2	3				91040
1/2	0.060	2	4	1/2	3				91140
1/2	0.090	2	4	1/2	3				91240
1/2	0.125	2	4	1/2	3				91340
5/8	0.030	3/4	3	5/8	3	90012			
5/8	0.060	3/4	3	5/8	3	90112			
5/8	0.090	3/4	3	5/8	3	90212			
5/8	0.125	3/4	3	5/8	3	90312			
5/8	0.030	1 1/4	3 1/2	5/8	3		90720		
5/8	0.060	1 1/4	3 1/2	5/8	3		90820		
5/8	0.090	1 1/4	3 1/2	5/8	3		90920		
5/8	0.125	1 1/4	3 1/2	5/8	3		91020		
5/8	0.030	1 5/8	4	5/8	3			90026	
5/8	0.060	1 5/8	4	5/8	3			90126	
5/8	0.090	1 5/8	4	5/8	3			90226	
5/8	0.125	1 5/8	4	5/8	3			90326	
3/4	0.030	1	3	3/4	3	90913			
3/4	0.060	1	3	3/4	3	91013			
3/4	0.090	1	3	3/4	3	91113			
3/4	0.125	1	3	3/4	3	91213			
3/4	0.190	1	3	3/4	3	91313			
3/4	0.250	1	3	3/4	3	91413			
3/4	0.030	1 5/8	4	3/4	3			90022	
3/4	0.060	1 5/8	4	3/4	3			90122	
3/4	0.090	1 5/8	4	3/4	3			90222	
3/4	0.125	1 5/8	4	3/4	3			90322	
3/4	0.190	1 5/8	4	3/4	3			90422	
3/4	0.250	1 5/8	4	3/4	3			90522	
3/4	0.030	2 1/4	5	3/4	3				90330
3/4	0.060	2 1/4	5	3/4	3				90430

P					
M					
K					
N					
S					
H					
O					

End milling cutter with corner radius

▲ Radius accuracy: +/- 0.001 for $\varnothing \leq 0.060$
+/- 0.0015 for $\varnothing > 0.060$

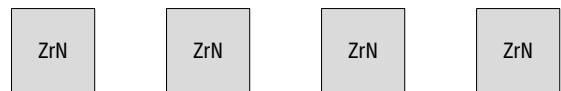
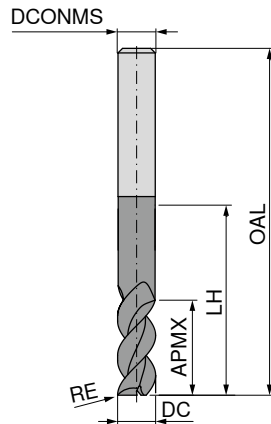
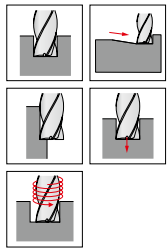
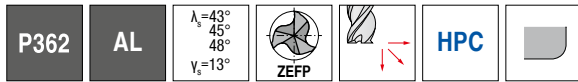

59 004 ...	59 004 ...	59 004 ...	59 004 ...
			90530
			90630
			90730
			90830
91513			
91613			
91713			
91813			
91913			
92013			
	91120		
	91220		
	91320		
	91420		
	91520		
	91620		
			90533
			90633
			90733
			90833
			90933
			91033

DC +0.000/-0.002 inch	RE inch	APMX inch	OAL inch	DCONMS -0.0001 / -0.0004 inch	ZEFP
3/4	0.090	2 1/4	5	3/4	3
3/4	0.125	2 1/4	5	3/4	3
3/4	0.190	2 1/4	5	3/4	3
3/4	0.250	2 1/4	5	3/4	3
1	0.030	1 1/4	4	1	3
1	0.060	1 1/4	4	1	3
1	0.090	1 1/4	4	1	3
1	0.125	1 1/4	4	1	3
1	0.190	1 1/4	4	1	3
1	0.250	1 1/4	4	1	3
1	0.030	2	5	1	3
1	0.060	2	5	1	3
1	0.090	2	5	1	3
1	0.125	2	5	1	3
1	0.190	2	5	1	3
1	0.250	2	5	1	3
1	0.030	3 1/4	6	1	3
1	0.060	3 1/4	6	1	3
1	0.090	3 1/4	6	1	3
1	0.125	3 1/4	6	1	3
1	0.190	3 1/4	6	1	3
1	0.250	3 1/4	6	1	3

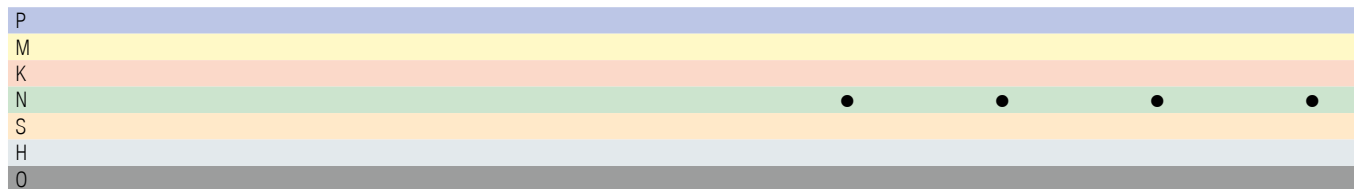

→ v_c/f_z Page 106

End milling cutter

P376
AL
 $\lambda_s=44^\circ$
 $\gamma_s=47^\circ$
 $\nu_s=21^\circ$
ZEFP

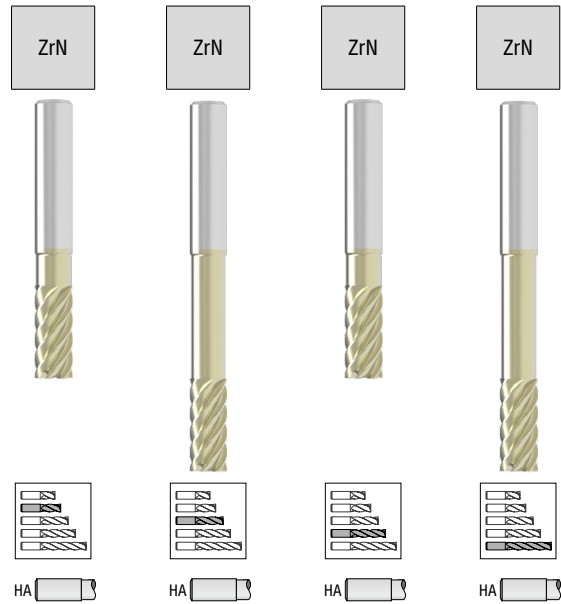
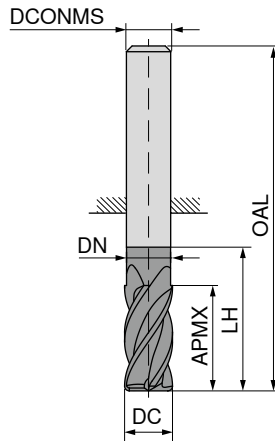
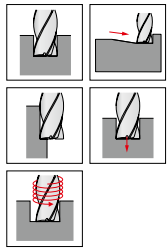

DC	APMX	DN	LH	OAL	DCONMS	ZEFP
<small>+0.000/-0.002</small>					<small>-0.0001/-0.0004</small>	
inch	inch	inch	inch	inch	inch	
1/4	5/8	0.240	7/8	2 1/2	1/4	6
1/4	5/8	0.240	1 5/8	3	1/4	6
5/16	3/4	0.300	1	2 1/2	5/16	6
5/16	3/4	0.300	2 3/8	4	5/16	6
3/8	1	0.360	1 1/4	3	3/8	6
3/8	1	0.360	2 1/4	4	3/8	6
1/2	1	0.480	1 1/4	3	1/2	6
1/2	1 1/4	0.480	1 1/2	3 1/2	1/2	6
1/2	1 1/4	0.480	3	5	1/2	6
1/2	1 7/8			5	1/2	6
5/8	1 1/4	0.600	1 1/2	3 1/2	5/8	6
5/8	1 1/4	0.600	3 5/8	6	5/8	6
5/8	2 1/2			6	5/8	6
3/4	1 5/8	0.720	2	4	3/4	6
3/4	1 5/8	0.720	3 5/8	6	3/4	6
1	2	0.960	3 7/8	6	1	6

59 005 ...	59 005 ...	59 005 ...	59 005 ...
		25025	25125
		31324	31424
		37527	37627
50020			
	50125	50025	50038
	62620	62520	
		75022	62540
			75122
			99920

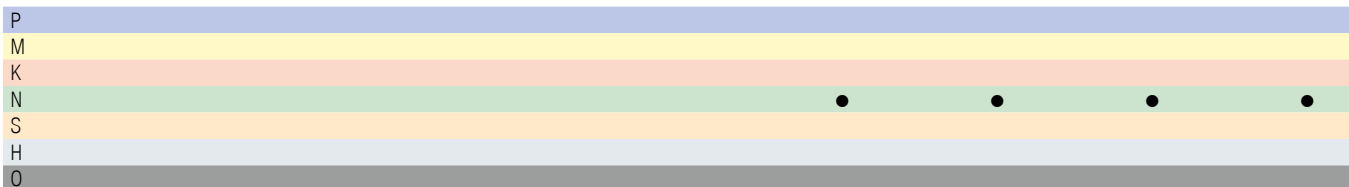

End milling cutter

▲ DC tolerance:
 ≤ Ø 7/64 inch: +/- 0.0005
 ≥ Ø 1/8 inch: 0 / -0.002

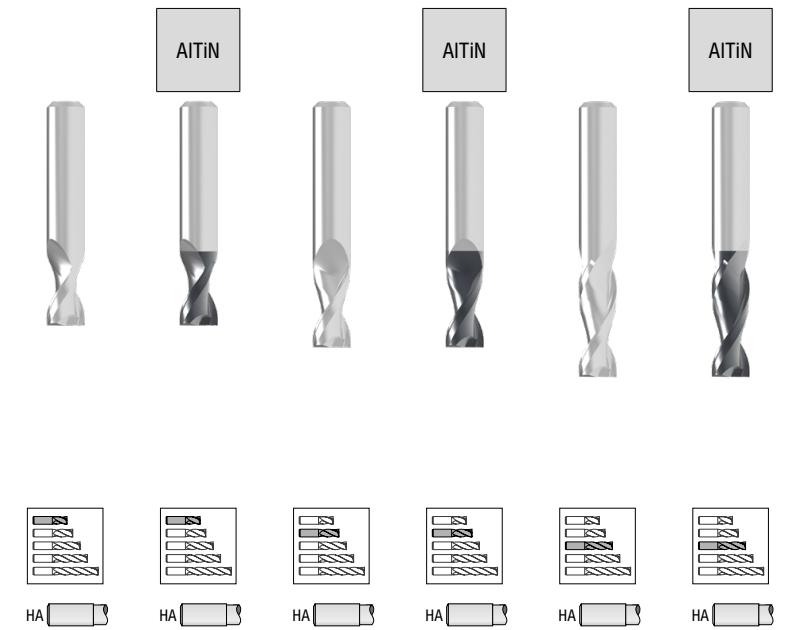
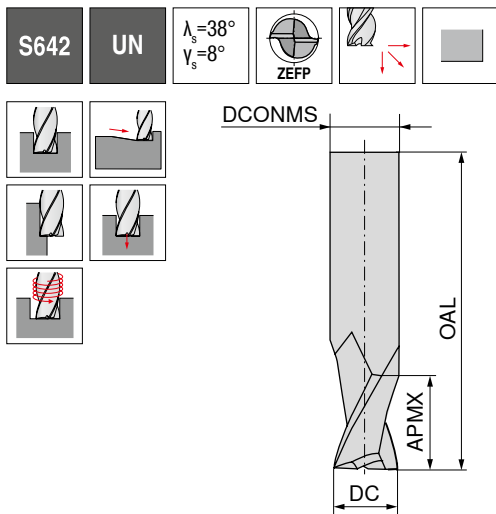

DC inch	APMX inch	OAL inch	DCONMS -0.0001 / -0.0004 inch	ZEFP	59 068 ...	59 069 ...	59 068 ...	59 069 ...	59 068 ...	59 069 ...
1/16	1/8	1 1/2	1/8	2			06320	06320		
3/32	3/16	1 1/2	1/8	2			09420	09420		
1/8	1/4	1 1/2	1/8	2	12520	12520	12540	12540		
1/8	1/2	1 1/2	1/8	2					12660	12660
1/8	3/4	3	1/8	2						
5/32	3/8	2	3/16	2			15624	15624	12660	12660
3/16	3/8	2	3/16	2	18820	18820				
3/16	5/8	2	3/16	2			18833	18833		
3/16	1	2 1/2	3/16	2					18853	18853
7/32	3/8	2	1/4	2			21917	21917		
1/4	3/8	2	1/4	2			25015	25015		
1/4	1 1/8	3	1/4	2					25045	25045
1/4	1	4	1/4	2					25040	25040
9/32	1/2	2	5/16	2			28118	28118		
5/16	1/2	2	5/16	2	31316	31316				
5/16	3/4	2 1/2	5/16	2			31324	31324		
5/16	1 3/8	3	5/16	2					31344	31344
5/16	1	4	5/16	2					31332	31332
3/8	5/8	2	3/8	2	37517	37517				
3/8	7/8	2 1/2	3/8	2			37523	37523		
3/8	1 3/8	3	3/8	2					37537	37537
3/8	1	4	3/8	2					37527	37527
1/2	5/8	2 1/2	1/2	2	50013	50013				
1/2	1	3	1/2	2			50020	50020		
1/2	1	4	1/2	2					50120	50120
5/8	7/8	3	5/8	2	62514	62514				
5/8	1 1/4	3 1/2	5/8	2			62520	62520		
5/8	2	6	5/8	2					62532	62532
3/4	1	3	3/4	2	75013	75013				
3/4	1 1/2	4	3/4	2			75020	75020		
3/4	2	6	3/4	2					75027	75027
1	1 3/4	4	1	2			99918	99918		
1	2	6	1	2					99920	99920
P					•	•	•	•	•	•
M					•	•	•	•	•	•
K					•	•	•	•	•	•
N					•	•	•	•	•	•
S					•	•	•	•	•	•
H										
O										

→ v_c/f_z Page 108

End milling cutter

▲ DC tolerance:
 ≤ Ø 7/64 inch: +/- 0.0005
 ≥ Ø 1/8 inch: 0 / -0.002

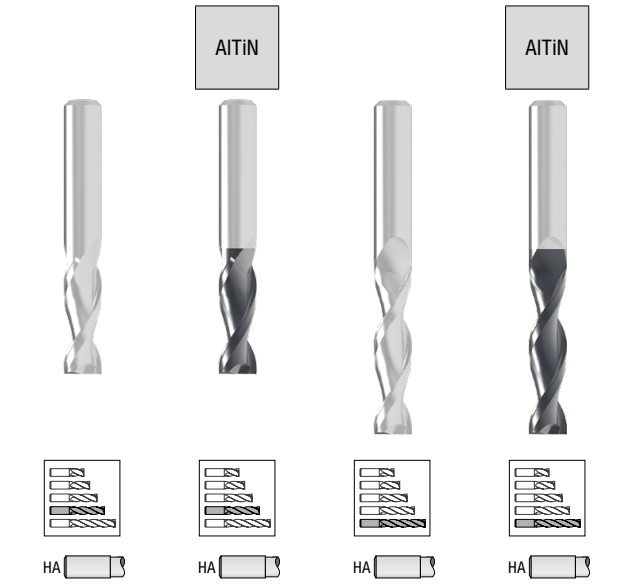
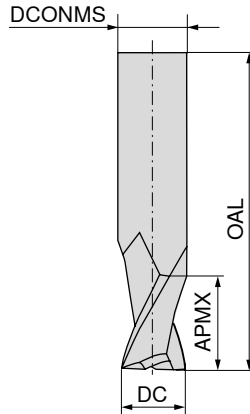
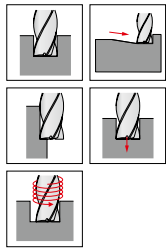
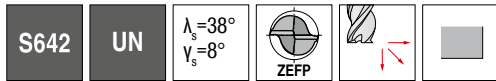

DC inch	APMX inch	OAL inch	DCONMS inch	ZEFP	59 068 ...	59 069 ...	59 068 ...	59 069 ...
1/16	3/16	1 1/2	1/8	2	06330	06330		
3/32	9/32	1 1/2	1/8	2	09430	09430		
1/8	3/4	2 1/2	1/8	2	12560	12560		
1/8	1	3	1/8	2			12580	12580
5/32	1/2	2	3/16	2	15632	15632		
5/32	3/4	2 1/2	3/16	2			15648	15648
3/16	3/4	2 1/2	3/16	2	18840	18840		
3/16	1 1/8	3	3/16	2			18860	18860
3/16	1	4	3/16	2			18953	18953
7/32	5/8	2 1/2	1/4	2	21929	21929		
7/32	1	3	1/4	2			21946	21946
1/4	3/4	2 1/2	1/4	2	25030	25030		
1/4	1 1/4	3	1/4	2			25050	25050
1/4	1 1/2	4	1/4	2			25060	25060
1/4	1 1/2	6	1/4	2			25160	25160
9/32	3/4	2 1/2	5/16	2	28127	28127		
9/32	1 1/4	3	5/16	2			28144	28144
5/16	1 1/8	3	5/16	2	31336	31336		
5/16	1 5/8	4	5/16	2			31352	31352
5/16	1 1/2	6	5/16	2			31348	31348
3/8	1 1/8	3	3/8	2	37530	37530		
3/8	1 3/4	4	3/8	2			37547	37547
3/8	1 1/2	6	3/8	2			37540	37540
3/8	3	6	3/8	2			37580	37580
1/2	1 1/2	3 1/2	1/2	2	50030	50030		
1/2	2	4	1/2	2			50040	50040
1/2	1 1/2	6	1/2	2			50130	50130
1/2	3	6	1/2	2			50060	50060
5/8	2 1/8	4 5/8	5/8	2	62534	62534		
5/8	3	6	5/8	2			62548	62548
3/4	2 1/4	5	3/4	2	75030	75030		
3/4	3	6	3/4	2			75040	75040
1	2 1/4	5	1	2	99923	99923		
1	3	6	1	2			99930	99930
P					●	●	●	●
M					●	●	●	●
K					●	●	●	●
N					●	●	●	●
S					●	●	●	●
H								
O								

End milling cutter with corner radius

▲ Radius accuracy: +/- 0.001

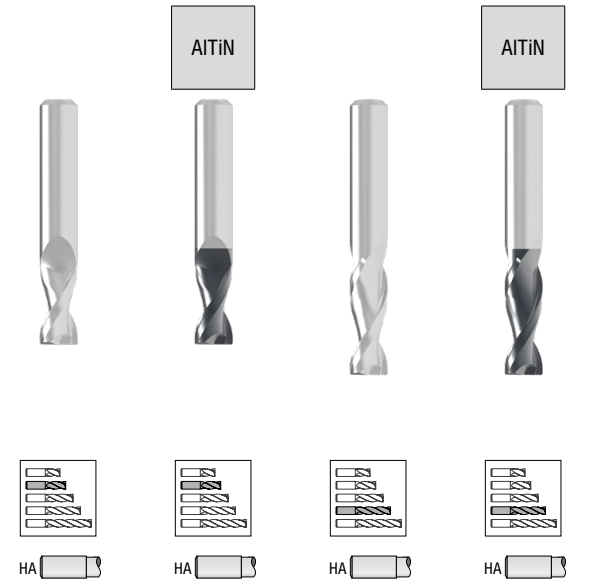
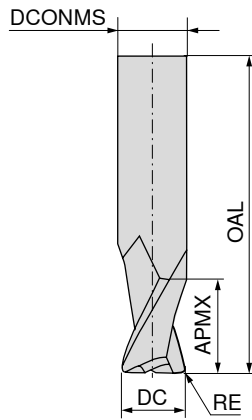
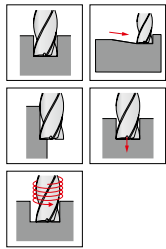
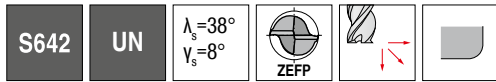

DC +0.000/-0.002 inch	RE inch	APMX inch	OAL inch	DCONMS -0.0001 / -0.0004 inch	ZEPF
1/8	0.010	1/2	1 1/2	1/8	2
1/8	0.015	1/2	1 1/2	1/8	2
1/8	0.020	1/2	1 1/2	1/8	2
1/8	0.030	1/2	1 1/2	1/8	2
1/8	0.045	1/2	1 1/2	1/8	2
3/16	0.010	5/8	2	3/16	2
3/16	0.015	5/8	2	3/16	2
3/16	0.020	5/8	2	3/16	2
3/16	0.030	5/8	2	3/16	2
3/16	0.045	5/8	2	3/16	2
3/16	0.060	5/8	2	3/16	2
1/4	0.010	3/4	2 1/2	1/4	2
1/4	0.015	3/4	2 1/2	1/4	2
1/4	0.020	3/4	2 1/2	1/4	2
1/4	0.030	3/4	2 1/2	1/4	2
1/4	0.045	3/4	2 1/2	1/4	2
1/4	0.060	3/4	2 1/2	1/4	2
1/4	0.090	3/4	2 1/2	1/4	2
5/16	0.010	3/4	2 1/2	5/16	2
5/16	0.015	3/4	2 1/2	5/16	2
5/16	0.020	3/4	2 1/2	5/16	2
5/16	0.030	3/4	2 1/2	5/16	2
5/16	0.045	3/4	2 1/2	5/16	2
5/16	0.060	3/4	2 1/2	5/16	2
5/16	0.090	3/4	2 1/2	5/16	2
3/8	0.010	7/8	2 1/2	3/8	2
3/8	0.015	7/8	2 1/2	3/8	2
3/8	0.020	7/8	2 1/2	3/8	2
3/8	0.030	7/8	2 1/2	3/8	2
3/8	0.045	7/8	2 1/2	3/8	2
3/8	0.060	7/8	2 1/2	3/8	2
3/8	0.090	7/8	2 1/2	3/8	2
3/8	0.125	7/8	2 1/2	3/8	2

59 068 ...	59 069 ...	59 068 ...	59 069 ...
90040	90040		
90140	90140		
90240	90240		
90340	90340		
90440	90440		
90033	90033		
90133	90133		
90233	90233		
90333	90333		
90433	90433		
90533	90533		
		90030	90030
		90130	90130
		90230	90230
		90330	90330
		90430	90430
		90530	90530
		90630	90630
90024	90024		
90124	90124		
90224	90224		
90324	90324		
90424	90424		
90524	90524		
90624	90624		
90023	90023		
90223	90223		
90323	90323		
90423	90423		
90523	90523		
90623	90623		
90723	90723		
90123	90123		

P	•	•	•	•
M	•	•	•	•
K	•	•	•	•
N	•	•	•	•
S	•	•	•	•
H				
O				

→ v_c/f_z Page 108

End milling cutter with corner radius

▲ Radius accuracy: +/- 0.001

S642
UN
 $\lambda_s=38^\circ$
 $\nu_s=8^\circ$
ZEPF

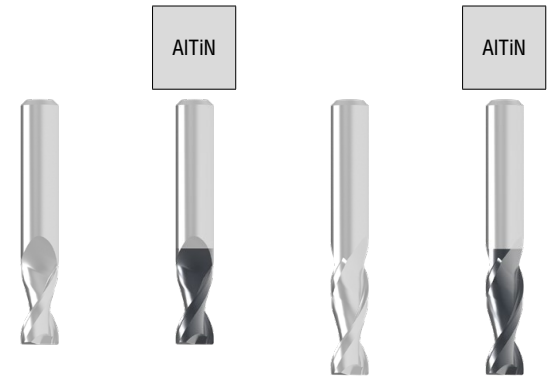
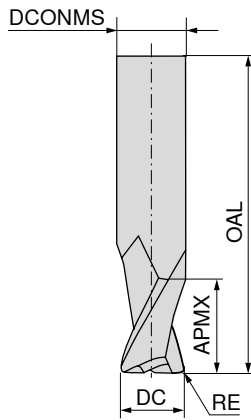
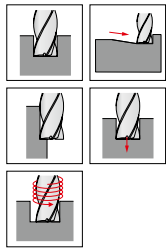

HA



HA



HA



HA

DC <small>+0.000/-0.002</small> inch	RE inch	APMX inch	OAL inch	DCONMS <small>-0.0001 / -0.0004</small> inch	ZEPF
1/2	0.010	1	3	1/2	2
1/2	0.015	1	3	1/2	2
1/2	0.020	1	3	1/2	2
1/2	0.030	1	3	1/2	2
1/2	0.045	1	3	1/2	2
1/2	0.060	1	3	1/2	2
1/2	0.090	1	3	1/2	2
1/2	0.125	1	3	1/2	2
5/8	0.030	1 1/4	3 1/2	5/8	2
5/8	0.045	1 1/4	3 1/2	5/8	2
5/8	0.060	1 1/4	3 1/2	5/8	2
5/8	0.090	1 1/4	3 1/2	5/8	2
5/8	0.125	1 1/4	3 1/2	5/8	2
3/4	0.030	1 1/2	4	3/4	2
3/4	0.045	1 1/2	4	3/4	2
3/4	0.060	1 1/2	4	3/4	2
3/4	0.090	1 1/2	4	3/4	2
3/4	0.125	1 1/2	4	3/4	2

59 068 ...	59 069 ...	59 068 ...	59 069 ...
90020	90020		
90220	90220		
90320	90320		
90420	90420		
90520	90520		
90620	90620		
90720	90720		
90120	90120		
		90920	90920
		91020	91020
		91120	91120
		91220	91220
		90820	90820
		91420	91420
		91520	91520
		91620	91620
		91720	91720
		91320	91320

P	●	●	●	●
M	●	●	●	●
K	●	●	●	●
N	●	●	●	●
S	●	●	●	●
H				
O				

→ v_c/f_z Page 108

End milling cutter

▲ DC tolerance:
 ≤ Ø 7/64 inch: +/- 0.0005
 ≥ Ø 1/8 inch: 0 / - 0.002

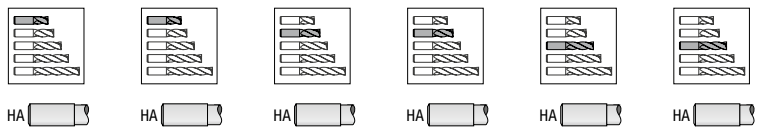
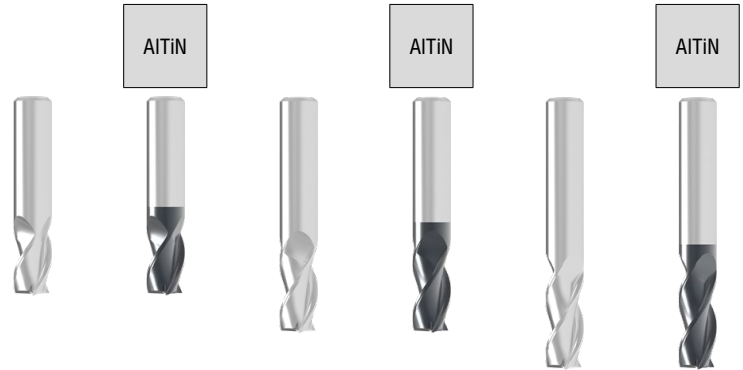
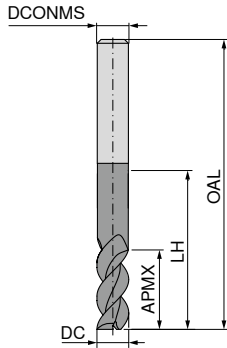
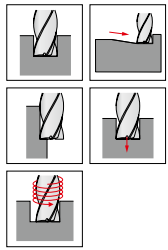
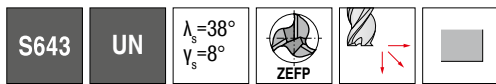

DC inch	APMX inch	OAL inch	DCONMS -0.0001 / -0.0004 inch	ZEFP	59 070 ...	59 071 ...	59 070 ...	59 071 ...	59 070 ...	59 071 ...
1/16	1/8	1 1/2	1/8	3				06320	06320	
5/64	1/4	1 1/2	1/8	3				07832	07832	
3/32	3/16	1 1/2	1/8	3				09420	09420	
1/8	1/4	1 1/2	1/8	3	12520	12520				
1/8	1/2	1 1/2	1/8	3			12540	12540		
1/8	3/4	3	1/8	3					12660	12660
5/32	3/8	2	3/16	3			15624	15624		
3/16	3/8	2	3/16	3	18820	18820				
3/16	5/8	2	3/16	3			18833	18833		
3/16	1	2 1/2	3/16	3					18853	18853
7/32	3/8	2	1/4	3			21917	21917		
1/4	3/8	2	1/4	3	25015	25015				
1/4	3/4	2 1/2	1/4	3			25030	25030		
1/4	1 1/8	3	1/4	3					25045	25045
9/32	1/2	2	5/16	3			28118	28118		
5/16	1/2	2	5/16	3	31316	31316				
5/16	3/4	2 1/2	5/16	3			31324	31324		
5/16	1 1/8	3	5/16	3					31336	31336
3/8	5/8	2	3/8	3	37517	37517				
3/8	7/8	2 1/2	3/8	3			37523	37523		
3/8	1 1/8	3	3/8	3					37530	37530
3/8	1 1/2	6	3/8	3					37540	37540
1/2	5/8	2 1/2	1/2	3	50013	50013				
1/2	1	3	1/2	3			50020	50020		
1/2	1 1/2	6	1/2	3					50030	50030
5/8	7/8	3	5/8	3	62514	62514				
5/8	1 1/4	3 1/2	5/8	3			62520	62520		
5/8	2 1/8	4 5/8	5/8	3					62534	62534
3/4	1	3	3/4	3	75013	75013				
3/4	1 1/2	4	3/4	3			75020	75020		
3/4	2 1/4	5	3/4	3					75030	75030
1	1 3/4	4	1	3			99918	99918		
1	2 1/4	5	1	3					99923	99923
P					•	•	•	•	•	•
M					•	•	•	•	•	•
K					•	•	•	•	•	•
N					•	•	•	•	•	•
S					•	•	•	•	•	•
H										
O										

→ v_c/f_z Page 109

End milling cutter

▲ DC tolerance:
 ≤ Ø 7/64 inch: +/- 0.0005
 ≥ Ø 1/8 inch: 0 /- 0.002

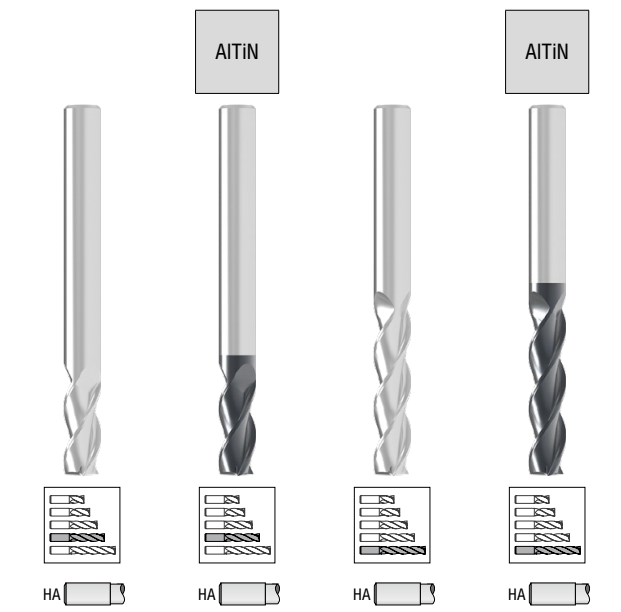
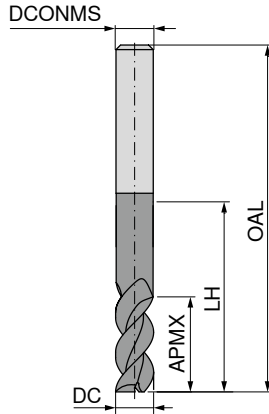
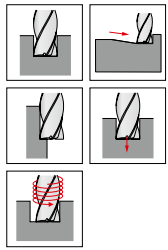
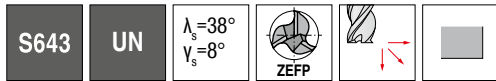

DC inch	APMX inch	OAL inch	DCONMS inch	ZFP
1/16	3/16	1 1/2	1/8	3
3/32	9/32	1 1/2	1/8	3
1/8	3/4	2 1/2	1/8	3
1/8	1	3	1/8	3
5/32	1/2	2	3/16	3
3/16	3/4	2 1/2	3/16	3
3/16	1	4	3/16	3
3/16	1 1/8	3	3/16	3
7/32	5/8	2 1/2	1/4	3
1/4	1	4	1/4	3
1/4	1 1/2	6	1/4	3
1/4	1 1/2	4	1/4	3
9/32	3/4	2 1/2	5/16	3
5/16	1	4	5/16	3
5/16	1 1/2	6	5/16	3
5/16	1 5/8	4	5/16	3
3/8	1	4	3/8	3
3/8	1 3/4	4	3/8	3
3/8	3	6	3/8	3
1/2	1	4	1/2	3
1/2	2	4	1/2	3
1/2	3	6	1/2	3
5/8	2	6	5/8	3
5/8	3	6	5/8	3
3/4	2	6	3/4	3
3/4	3	6	3/4	3
1	2	6	1	3
1	3	6	1	3

59 070 ...	59 071 ...	59 070 ...	59 071 ...
06330	06330		
09430	09430		
12560	12560		
		12580	12580
15632	15632		
18840	18840		
		18953	18953
		18860	18860
21929	21929		
25040	25040		
		25160	25160
		25060	25060
28127	28127		
31332	31332		
		31348	31348
		31352	31352
37527	37527		
		37547	37547
		37580	37580
50120	50120		
		50040	50040
		50060	50060
62532	62532		
		62548	62548
75027	75027		
		75040	75040
99920	99920		
		99930	99930

P	●	●	●	●
M	●	●	●	●
K	●	●	●	●
N	●	●	●	●
S	●	●	●	●
H				
O				

End milling cutter with corner radius

▲ Radius accuracy: +/- 0.001

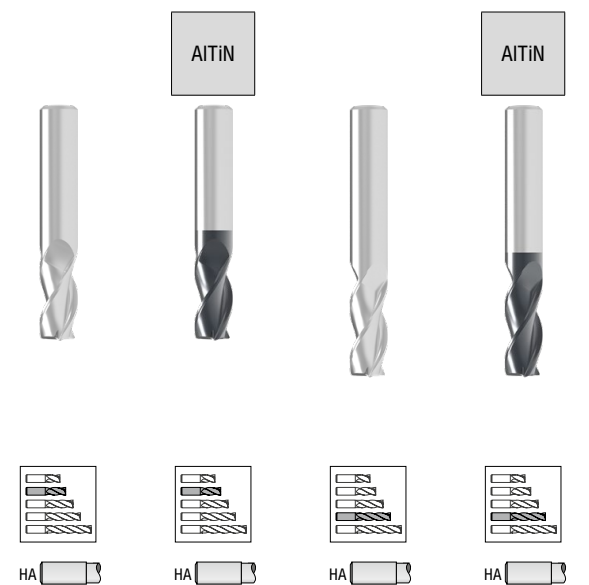
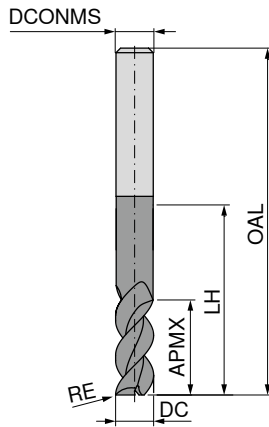
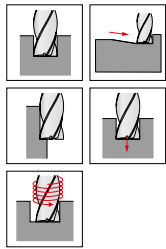
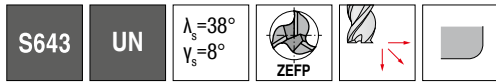

DC	RE	APMX	OAL	DCONMS	ZEFP	59 070 ...	59 071 ...	59 070 ...	59 071 ...
<small>+0.000/-0.002</small>	<small>+0.000/-0.002</small>			<small>-0.0001 / -0.0004</small>					
inch	inch	inch	inch	inch					
1/8	0.010	1/2	1 1/2	1/8	3	90040	90040		
1/8	0.015	1/2	1 1/2	1/8	3	90140	90140		
1/8	0.020	1/2	1 1/2	1/8	3	90240	90240		
1/8	0.030	1/2	1 1/2	1/8	3	90340	90340		
1/8	0.045	1/2	1 1/2	1/8	3	90440	90440		
3/16	0.010	5/8	2	3/16	3	90033	90033		
3/16	0.015	5/8	2	3/16	3	90133	90133		
3/16	0.020	5/8	2	3/16	3	90233	90233		
3/16	0.030	5/8	2	3/16	3	90333	90333		
3/16	0.045	5/8	2	3/16	3	90433	90433		
3/16	0.060	5/8	2	3/16	3	90533	90533		
1/4	0.010	3/4	2 1/2	1/4	3			90030	90030
1/4	0.015	3/4	2 1/2	1/4	3			90130	90130
1/4	0.020	3/4	2 1/2	1/4	3			90230	90230
1/4	0.030	3/4	2 1/2	1/4	3			90330	90330
1/4	0.045	3/4	2 1/2	1/4	3			90430	90430
1/4	0.060	3/4	2 1/2	1/4	3			90530	90530
1/4	0.090	3/4	2 1/2	1/4	3			90630	90630
5/16	0.010	3/4	2 1/2	5/16	3	90024	90024		
5/16	0.015	3/4	2 1/2	5/16	3	90124	90124		
5/16	0.020	3/4	2 1/2	5/16	3	90224	90224		
5/16	0.030	3/4	2 1/2	5/16	3	90324	90324		
5/16	0.045	3/4	2 1/2	5/16	3	90424	90424		
5/16	0.060	3/4	2 1/2	5/16	3	90524	90524		
5/16	0.090	3/4	2 1/2	5/16	3	90624	90624		
3/8	0.010	7/8	2 1/2	3/8	3	90023	90023		
3/8	0.015	7/8	2 1/2	3/8	3	90223	90223		
3/8	0.020	7/8	2 1/2	3/8	3	90323	90323		
3/8	0.030	7/8	2 1/2	3/8	3	90423	90423		
3/8	0.045	7/8	2 1/2	3/8	3	90523	90523		
3/8	0.060	7/8	2 1/2	3/8	3	90623	90623		
3/8	0.090	7/8	2 1/2	3/8	3	90723	90723		
3/8	0.125	7/8	2 1/2	3/8	3	90123	90123		
P						•	•	•	•
M						•	•	•	•
K						•	•	•	•
N						•	•	•	•
S						•	•	•	•
H									
O									

→ v_c/f_z Page 109

End milling cutter with corner radius

▲ Radius accuracy: +/- 0.001

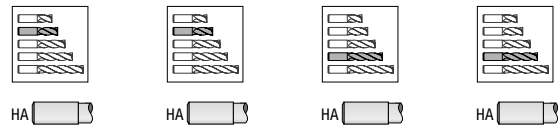
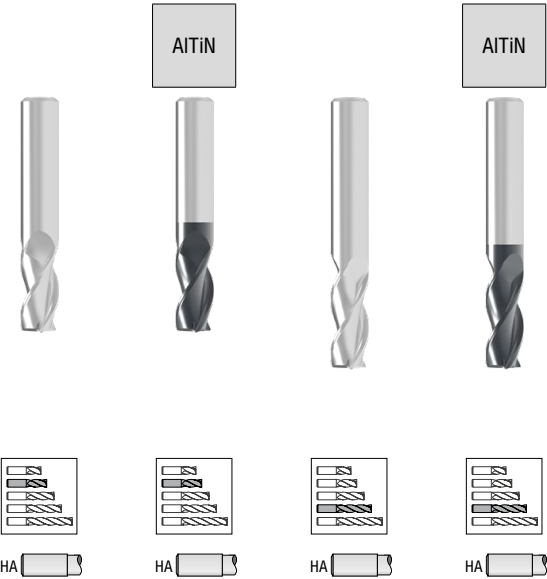
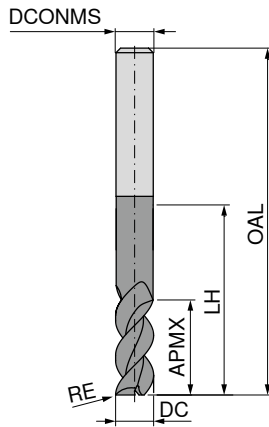
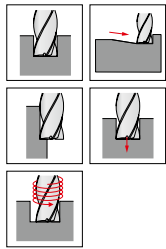
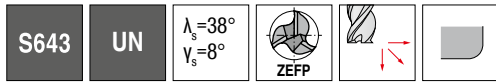

DC +0.000/-0.002 inch	RE inch	APMX inch	OAL inch	DCONMS -0.0001 / -0.0004 inch	ZEPF	59 070 ...	59 071 ...	59 070 ...	59 071 ...
1/2	0.010	1	3	1/2	3	90020	90020		
1/2	0.015	1	3	1/2	3	90220	90220		
1/2	0.020	1	3	1/2	3	90320	90320		
1/2	0.030	1	3	1/2	3	90420	90420		
1/2	0.045	1	3	1/2	3	90520	90520		
1/2	0.060	1	3	1/2	3	90620	90620		
1/2	0.090	1	3	1/2	3	90720	90720		
1/2	0.125	1	3	1/2	3	90120	90120		
5/8	0.015	1 1/4	3 1/2	5/8	3			90920	90920
5/8	0.020	1 1/4	3 1/2	5/8	3			91020	91020
5/8	0.030	1 1/4	3 1/2	5/8	3			91120	91120
5/8	0.045	1 1/4	3 1/2	5/8	3			91220	91220
5/8	0.060	1 1/4	3 1/2	5/8	3			91320	91320
5/8	0.090	1 1/4	3 1/2	5/8	3			91420	91420
5/8	0.125	1 1/4	3 1/2	5/8	3			90820	90820
3/4	0.020	1 1/2	4	3/4	3			91620	91620
3/4	0.030	1 1/2	4	3/4	3			91720	91720
3/4	0.045	1 1/2	4	3/4	3			91820	91820
3/4	0.060	1 1/2	4	3/4	3			91920	91920
3/4	0.090	1 1/2	4	3/4	3			92020	92020
3/4	0.125	1 1/2	4	3/4	3			91520	91520
1	0.030	1 3/4	4	1	3	90118	90118		
1	0.045	1 3/4	4	1	3	90218	90218		
1	0.060	1 3/4	4	1	3	90318	90318		
1	0.090	1 3/4	4	1	3	90418	90418		
1	0.125	1 3/4	4	1	3	90018	90018		
P						●	●	●	●
M						●	●	●	●
K						●	●	●	●
N						●	●	●	●
S						●	●	●	●
H									
O									

→ v_c/f_z Page 109

End milling cutter

▲ DC tolerance:
 ≤ Ø 7/64 inch: +/- 0.0005
 ≥ Ø 1/8 inch: 0 /- 0.002

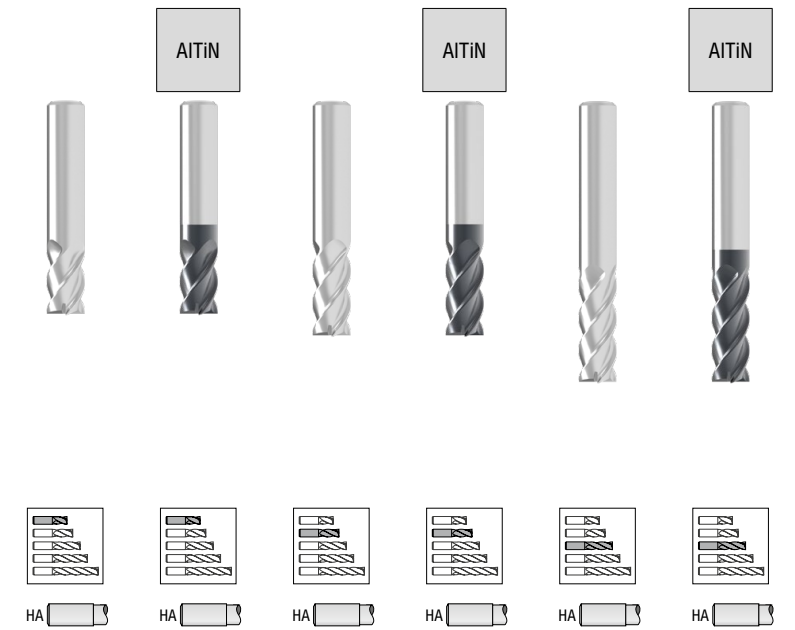
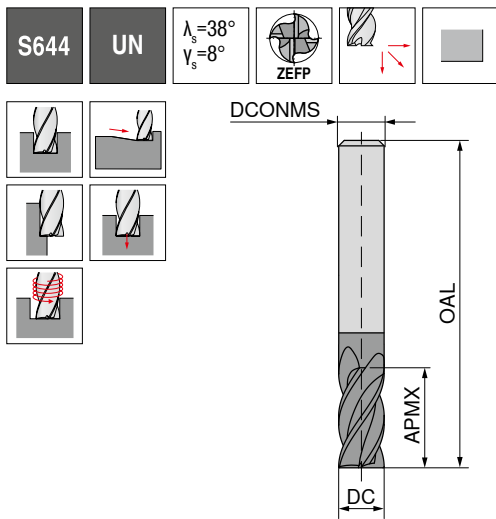

DC inch	APMX inch	OAL inch	DCONMS -0.0001 / -0.0004 inch	ZEFP	59 072 ...	59 073 ...	59 072 ...	59 073 ...	59 072 ...	59 073 ...
1/32	1/16	1 1/2	1/8	4			03120	03120		
3/64	3/32	1 1/2	1/8	4			04720	04720		
1/16	1/8	1 1/2	1/8	4			06320	06320		
5/64	1/4	1 1/2	1/8	4			07832	07832		
3/32	3/16	1 1/2	1/8	4			09420	09420		
7/64	3/16	1 1/2	1/8	4			10917	10917		
1/8	1/4	1 1/2	1/8	4	12520	12520				
1/8	1/2	1 1/2	1/8	4			12540	12540		
1/8	3/4	3	1/8	4					12660	12660
5/32	3/8	2	3/16	4			15624	15624		
3/16	3/8	2	3/16	4	18820	18820	18833	18833		
3/16	5/8	2	3/16	4					18853	18853
3/16	1	2 1/2	3/16	4						
7/32	3/8	2	1/4	4			21917	21917		
1/4	3/8	2	1/4	4	25015	25015				
1/4	3/4	2 1/2	1/4	4			25030	25030		
1/4	1 1/4	3	1/4	4					25050	25050
1/4	1	4	1/4	4					25040	25040
9/32	1/2	2	5/16	4			28118	28118		
5/16	1/2	2	5/16	4	31316	31316				
5/16	3/4	2 1/2	5/16	4			31324	31324		
5/16	1 3/8	3	5/16	4					31344	31344
5/16	1	4	5/16	4					31332	31332
3/8	5/8	2	3/8	4	37517	37517				
3/8	7/8	2 1/2	3/8	4			37523	37523		
3/8	1 1/8	3	3/8	4					37530	37530
3/8	1 3/8	3	3/8	4					37537	37537
1/2	5/8	2 1/2	1/2	4	50013	50013				
1/2	1	3	1/2	4			50020	50020		
1/2	1 1/2	3 1/2	1/2	4					50030	50030
1/2	1 1/2	6	1/2	4					50130	50130
5/8	7/8	3	5/8	4	62514	62514				
5/8	1 1/4	3 1/2	5/8	4			62520	62520		
5/8	2 1/8	4 5/8	5/8	4					62534	62534
3/4	1	3	3/4	4	75013	75013				
3/4	1 1/2	4	3/4	4			75020	75020		
3/4	2 1/4	5	3/4	4					75030	75030
1	1 3/4	4	1	4			99918	99918		
1	2 1/4	5	1	4					99923	99923
P					•	•	•	•	•	•
M					•	•	•	•	•	•
K					•	•	•	•	•	•
N					•	•	•	•	•	•
S					•	•	•	•	•	•
H										
O										

End milling cutter

▲ DC tolerance:
 ≤ Ø 7/64 inch: +/- 0.0005
 ≥ Ø 1/8 inch: 0 / -0.002

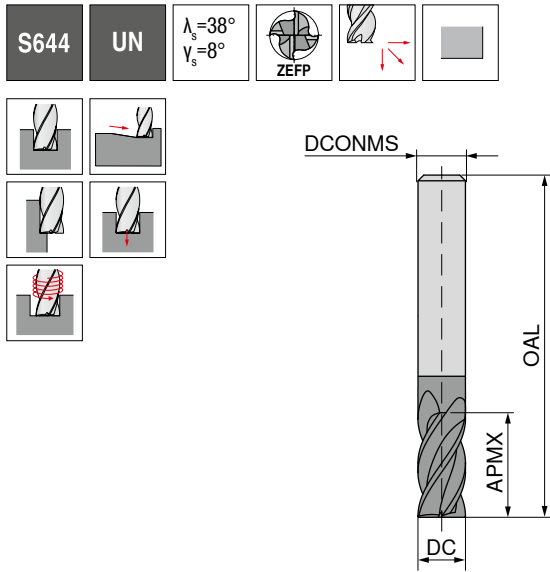

	AITiN	AITiN		
59 072 ...	59 073 ...	59 072 ...	59 073 ...	
03130	03130			
04730	04730			
06330	06330			
09430	09430			
10934	10934			
12560	12560			
		12580		12580
15632	15632			
		15648		15648
18840	18840			
		18860		18860
		18953		18953
21929	21929			
		21946		21946
25045	25045			
		25060		25060
		25160		25160
28127	28127			
		28144		28144
31336	31336			
		31352		31352
		31348		31348
37527	37527			
		37547		37547
		37540		37540
		37580		37580
50120	50120			
		50040		50040
		50060		50060
62532	62532			
		62548		62548
75027	75027			
		75040		75040
99920	99920			
		99930		99930

DC inch	APMX inch	OAL inch	DCONMS inch	ZFP
1/32	3/32	1 1/2	1/8	4
3/64	9/64	1 1/2	1/8	4
1/16	3/16	1 1/2	1/8	4
3/32	9/32	1 1/2	1/8	4
7/64	3/8	1 1/2	1/8	4
1/8	3/4	2 1/2	1/8	4
1/8	1	3	1/8	4
5/32	1/2	2	3/16	4
5/32	3/4	2 1/2	3/16	4
3/16	3/4	2 1/2	3/16	4
3/16	1 1/8	3	3/16	4
3/16	1	4	3/16	4
7/32	5/8	2 1/2	1/4	4
7/32	1	3	1/4	4
1/4	1 1/8	3	1/4	4
1/4	1 1/2	4	1/4	4
1/4	1 1/2	6	1/4	4
9/32	3/4	2 1/2	5/16	4
9/32	1 1/4	3	5/16	4
5/16	1 1/8	3	5/16	4
5/16	1 5/8	4	5/16	4
5/16	1 1/2	6	5/16	4
3/8	1	4	3/8	4
3/8	1 3/4	4	3/8	4
3/8	1 1/2	6	3/8	4
3/8	3	6	3/8	4
1/2	1	4	1/2	4
1/2	2	4	1/2	4
1/2	3	6	1/2	4
5/8	2	6	5/8	4
5/8	3	6	5/8	4
3/4	2	6	3/4	4
3/4	3	6	3/4	4
1	2	6	1	4
1	3	6	1	4

P	●	●	●	●
M	●	●	●	●
K	●	●	●	●
N	●	●	●	●
S	●	●	●	●
H				
O				

End milling cutter with corner radius

▲ Radius accuracy: +/- 0.001

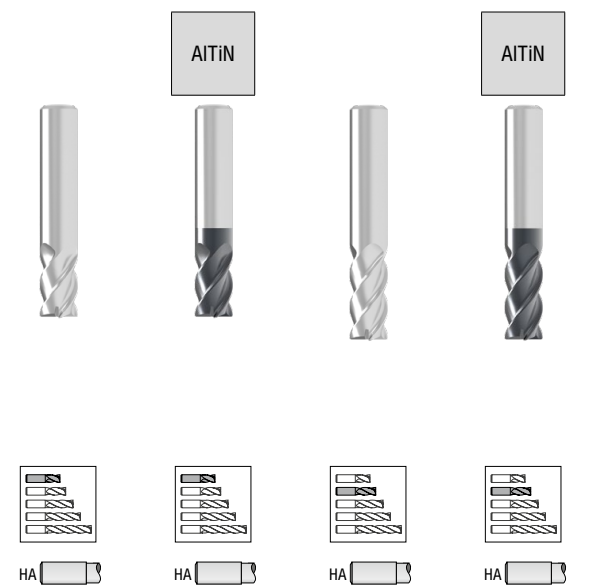
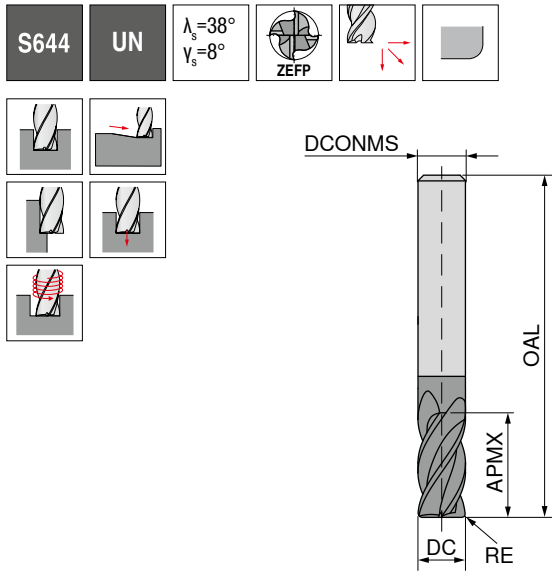

DC	RE	APMX	OAL	DCONMS	ZEFP	59 072 ...	59 073 ...	59 072 ...	59 073 ...
inch	inch	inch	inch	inch					
1/8	0.010	1/4	1 1/2	1/8	4			92120	92120
1/8	0.015	1/4	1 1/2	1/8	4			92220	92220
1/8	0.020	1/4	1 1/2	1/8	4			92320	92320
1/8	0.030	1/4	1 1/2	1/8	4			92420	92420
1/8	0.045	1/4	1 1/2	1/8	4			92520	92520
3/16	0.010	3/8	2	3/16	4			92620	92620
3/16	0.015	3/8	2	3/16	4			92720	92720
3/16	0.020	3/8	2	3/16	4			92820	92820
3/16	0.030	3/8	2	3/16	4			92920	92920
3/16	0.045	3/8	2	3/16	4			93020	93020
3/16	0.060	3/8	2	3/16	4			93120	93120
1/4	0.010	3/8	2	1/4	4	90015	90015		
1/4	0.015	3/8	2	1/4	4	90115	90115		
1/4	0.020	3/8	2	1/4	4	90215	90215		
1/4	0.030	3/8	2	1/4	4	90315	90315		
1/4	0.045	3/8	2	1/4	4	90415	90415		
1/4	0.060	3/8	2	1/4	4	90515	90515		
1/4	0.090	3/8	2	1/4	4	90615	90615		
1/4	0.010	3/4	2 1/2	1/4	4			90030	90030
1/4	0.015	3/4	2 1/2	1/4	4			90130	90130
1/4	0.020	3/4	2 1/2	1/4	4			90230	90230
1/4	0.030	3/4	2 1/2	1/4	4			90330	90330
1/4	0.045	3/4	2 1/2	1/4	4			90430	90430
1/4	0.060	3/4	2 1/2	1/4	4			90530	90530
1/4	0.090	3/4	2 1/2	1/4	4			90630	90630
5/16	0.010	1/2	2	5/16	4	90016	90016		
5/16	0.015	1/2	2	5/16	4	90216	90216		
5/16	0.020	1/2	2	5/16	4	90316	90316		
5/16	0.030	1/2	2	5/16	4	90416	90416		
5/16	0.045	1/2	2	5/16	4	90516	90516		
5/16	0.060	1/2	2	5/16	4	90616	90616		
5/16	0.090	1/2	2	5/16	4	90716	90716		
5/16	0.125	1/2	2	5/16	4	90116	90116		
5/16	0.010	3/4	2 1/2	5/16	4			90024	90024
5/16	0.015	3/4	2 1/2	5/16	4			90224	90124
5/16	0.020	3/4	2 1/2	5/16	4			90324	90224
5/16	0.030	3/4	2 1/2	5/16	4			90424	90324
5/16	0.045	3/4	2 1/2	5/16	4			90524	90424
5/16	0.060	3/4	2 1/2	5/16	4			90624	90524
5/16	0.090	3/4	2 1/2	5/16	4			90724	90624

P	●	●	●	●
M	●	●	●	●
K	●	●	●	●
N	●	●	●	●
S	●	●	●	●
H				
O				

End milling cutter with corner radius

▲ Radius accuracy: +/- 0.001

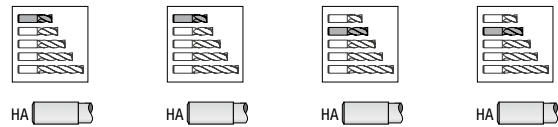
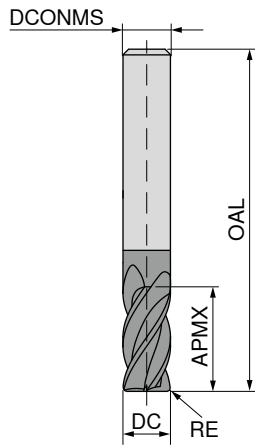
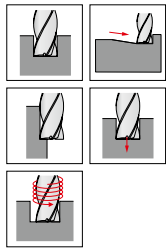
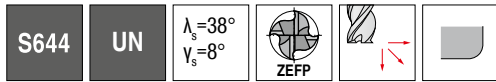

59 072 ... 59 073 ... 59 072 ... 59 073 ...

DC inch	RE inch	APMX inch	OAL inch	DCONMS inch	ZEFP	59 072 ...	59 073 ...	59 072 ...	59 073 ...
5/16	0.125	3/4	2 1/2	5/16	4			90124	
3/8	0.010	5/8	2	3/8	4	90017	90017		
3/8	0.015	5/8	2	3/8	4	90217	90217		
3/8	0.020	5/8	2	3/8	4	90317	90317		
3/8	0.030	5/8	2	3/8	4	90417	90417		
3/8	0.045	5/8	2	3/8	4	90517	90517		
3/8	0.060	5/8	2	3/8	4	90617	90617		
3/8	0.090	5/8	2	3/8	4	90717	90717		
3/8	0.125	5/8	2	3/8	4	90117	90117		
3/8	0.010	7/8	2 1/2	3/8	4			90023	90023
3/8	0.015	7/8	2 1/2	3/8	4			90223	90223
3/8	0.020	7/8	2 1/2	3/8	4			90323	90323
3/8	0.030	7/8	2 1/2	3/8	4			90423	90423
3/8	0.045	7/8	2 1/2	3/8	4			90523	90523
3/8	0.060	7/8	2 1/2	3/8	4			90623	90623
3/8	0.090	7/8	2 1/2	3/8	4			90723	90723
3/8	0.125	7/8	2 1/2	3/8	4			90123	90123
1/2	0.010	5/8	2 1/2	1/2	4	90013	90013		
1/2	0.015	5/8	2 1/2	1/2	4	90213	90213		
1/2	0.020	5/8	2 1/2	1/2	4	90313	90313		
1/2	0.030	5/8	2 1/2	1/2	4	90413	90413		
1/2	0.045	5/8	2 1/2	1/2	4	90513	90513		
1/2	0.060	5/8	2 1/2	1/2	4	90613	90613		
1/2	0.090	5/8	2 1/2	1/2	4	90713	90713		
1/2	0.125	5/8	2 1/2	1/2	4	90113	90113		
1/2	0.010	1	3	1/2	4			90020	90020
1/2	0.015	1	3	1/2	4			90220	90220
1/2	0.020	1	3	1/2	4			90320	90320
1/2	0.030	1	3	1/2	4			90420	90420
1/2	0.045	1	3	1/2	4			90520	90520
1/2	0.060	1	3	1/2	4			90620	90620
1/2	0.090	1	3	1/2	4			90720	90720
1/2	0.125	1	3	1/2	4			90120	90120
1/2	0.010	1	4	1/2	4			93720	93720
1/2	0.015	1	4	1/2	4			93920	93920
1/2	0.020	1	4	1/2	4			94020	94020
1/2	0.030	1	4	1/2	4			94120	94120
1/2	0.045	1	4	1/2	4			94220	94220
1/2	0.060	1	4	1/2	4			94320	94320
1/2	0.090	1	4	1/2	4			94420	94420

P	●	●	●	●
M	●	●	●	●
K	●	●	●	●
N	●	●	●	●
S	●	●	●	●
H				
O				

End milling cutter with corner radius

▲ Radius accuracy: +/- 0.001

S644 **UN** $\lambda_s=38^\circ$
 $\nu_s=8^\circ$

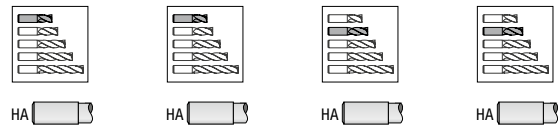
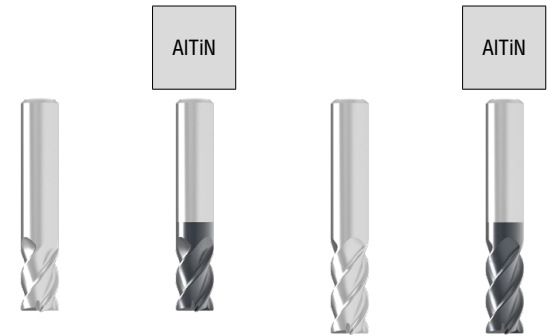
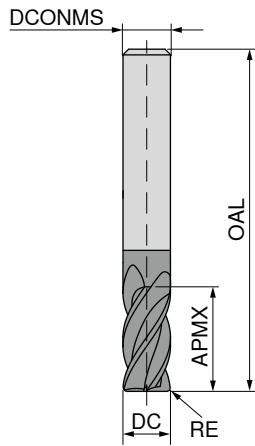
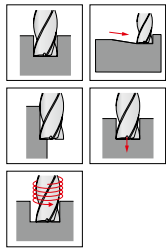

59 072 ...	59 073 ...	59 072 ...	59 073 ...
		93820	93820
		90920	90920
		91020	91020
		91120	91120
		91220	91220
		91320	91320
		91420	91420
		90820	90820
		91620	91620
		91720	91720
		91820	91820
		91920	91920
		92020	92020
		91520	91520
		90118	90118
		90218	90218
		90318	90318
		90418	90418
		90018	90018

DC $+0.000/-0.002$ inch	RE inch	APMX inch	OAL inch	DCONMS $-0.0001 / -0.0004$ inch	ZEFP
1/2	0.125	1	4	1/2	4
5/8	0.015	1 1/4	3 1/2	5/8	4
5/8	0.020	1 1/4	3 1/2	5/8	4
5/8	0.030	1 1/4	3 1/2	5/8	4
5/8	0.045	1 1/4	3 1/2	5/8	4
5/8	0.060	1 1/4	3 1/2	5/8	4
5/8	0.090	1 1/4	3 1/2	5/8	4
5/8	0.125	1 1/4	3 1/2	5/8	4
3/4	0.020	1 1/2	4	3/4	4
3/4	0.030	1 1/2	4	3/4	4
3/4	0.045	1 1/2	4	3/4	4
3/4	0.060	1 1/2	4	3/4	4
3/4	0.090	1 1/2	4	3/4	4
3/4	0.125	1 1/2	4	3/4	4
1	0.030	1 3/4	4	1	4
1	0.045	1 3/4	4	1	4
1	0.060	1 3/4	4	1	4
1	0.090	1 3/4	4	1	4
1	0.125	1 3/4	4	1	4

P	•	•	•	•
M	•	•	•	•
K	•	•	•	•
N	•	•	•	•
S	•	•	•	•
H				
O				

→ v_c/f_z Page 110

End milling cutter with corner radius

▲ Radius accuracy: +/- 0.001

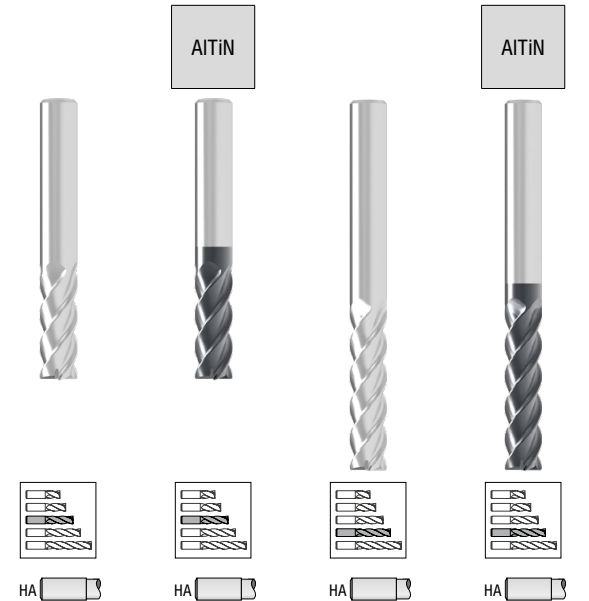
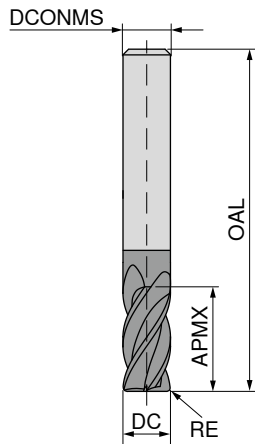
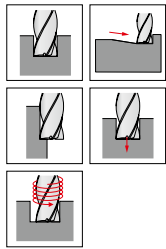
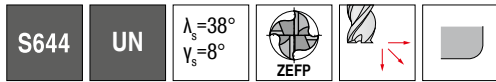

59 072 ... 59 073 ... 59 072 ... 59 073 ...

DC	RE	APMX	OAL	DCONMS	ZEFP				
+0.000/-0.002				-0.0001 / -0.0004					
inch	inch	inch	inch	inch					
1/8	0.010	1/2	1 1/2	1/8	4				
1/8	0.015	1/2	1 1/2	1/8	4			90040	90040
1/8	0.020	1/2	1 1/2	1/8	4			90140	90140
1/8	0.030	1/2	1 1/2	1/8	4			90240	90240
3/16	0.010	5/8	2	3/16	4			90340	90340
3/16	0.015	5/8	2	3/16	4	90033	90033		
3/16	0.020	5/8	2	3/16	4	90133	90133		
3/16	0.030	5/8	2	3/16	4	90233	90233		
3/16	0.045	5/8	2	3/16	4	90333	90333		
3/16	0.060	5/8	2	3/16	4	90433	90433		
3/16	0.010	1	4	3/16	4	90533	90533		
3/16	0.015	1	4	3/16	4			90053	90153
3/16	0.020	1	4	3/16	4			90153	90253
3/16	0.030	1	4	3/16	4			90253	90353
3/16	0.045	1	4	3/16	4			90353	90453
3/16	0.060	1	4	3/16	4			90453	90553
1/4	0.010	1	4	1/4	4			90553	90653
1/4	0.015	1	4	1/4	4	91840	91840		
1/4	0.020	1	4	1/4	4	91940	91940		
1/4	0.030	1	4	1/4	4	92040	92040		
1/4	0.045	1	4	1/4	4	92140	92140		
1/4	0.060	1	4	1/4	4	92240	92240		
1/4	0.090	1	4	1/4	4	92340	92340		
1/4	0.010	1 1/8	3	1/4	4	92440	92440		
1/4	0.015	1 1/8	3	1/4	4			90045	90045
1/4	0.020	1 1/8	3	1/4	4			90145	90145
1/4	0.030	1 1/8	3	1/4	4			90245	90245
1/4	0.045	1 1/8	3	1/4	4			90345	90345
1/4	0.060	1 1/8	3	1/4	4			90445	90445
1/4	0.090	1 1/8	3	1/4	4			90545	90545
5/16	0.010	1	4	5/16	4			90645	90645
5/16	0.015	1	4	5/16	4	90032	90032		
5/16	0.020	1	4	5/16	4	90232	90232		
5/16	0.030	1	4	5/16	4	90332	90332		
5/16	0.045	1	4	5/16	4	90432	90432		
5/16	0.060	1	4	5/16	4	90532	90532		
5/16	0.090	1	4	5/16	4	90632	90632		
5/16	0.125	1	4	5/16	4	90732	90732		
5/16	0.010	1 1/8	3	5/16	4	90132	90132		
5/16	0.015	1 1/8	3	5/16	4	90036	90036		
5/16	0.015	1 1/8	3	5/16	4	90236	90236		

P	●	●	●	●
M	●	●	●	●
K	●	●	●	●
N	●	●	●	●
S	●	●	●	●
H				
O				

End milling cutter with corner radius

▲ Radius accuracy: +/- 0.001

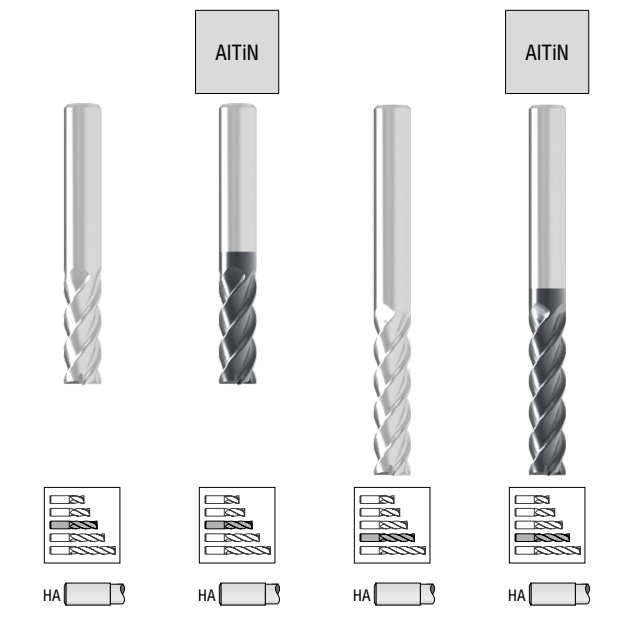
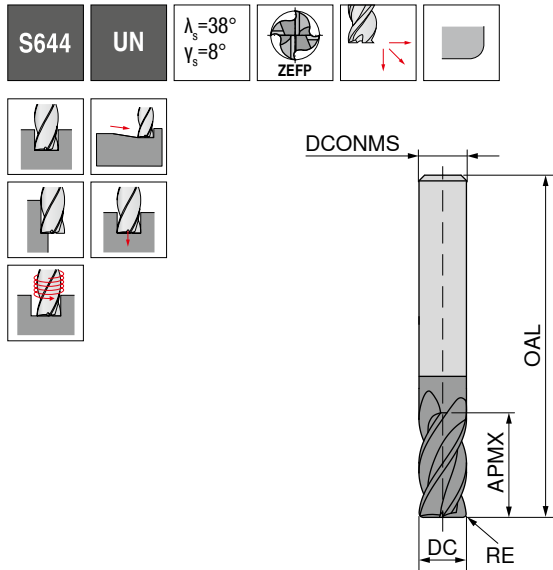

DC	RE	APMX	OAL	DCONMS	ZEFP	59 072 ...	59 073 ...	59 072 ...	59 073 ...
inch	inch	inch	inch	inch					
5/16	0.020	1 1/8	3	5/16	4	90336	90336		
5/16	0.030	1 1/8	3	5/16	4	90436	90436		
5/16	0.045	1 1/8	3	5/16	4	90536	90536		
5/16	0.060	1 1/8	3	5/16	4	90636	90636		
5/16	0.090	1 1/8	3	5/16	4	90736	90736		
5/16	0.125	1 1/8	3	5/16	4	90136	90136		
5/16	0.010	1 1/2	6	5/16	4			90748	90748
5/16	0.015	1 1/2	6	5/16	4			90948	90948
5/16	0.020	1 1/2	6	5/16	4			91048	91048
5/16	0.030	1 1/2	6	5/16	4			91148	91148
5/16	0.045	1 1/2	6	5/16	4			91248	91248
5/16	0.060	1 1/2	6	5/16	4			91348	91348
5/16	0.090	1 1/2	6	5/16	4			91448	91448
5/16	0.125	1 1/2	6	5/16	4			90848	90848
3/8	0.010	1	4	3/8	4	90027	90027		
3/8	0.015	1	4	3/8	4	90227	90227		
3/8	0.020	1	4	3/8	4	90327	90327		
3/8	0.030	1	4	3/8	4	90427	90427		
3/8	0.045	1	4	3/8	4	90527	90527		
3/8	0.060	1	4	3/8	4	90627	90627		
3/8	0.090	1	4	3/8	4	90727	90727		
3/8	0.125	1	4	3/8	4	90127	90127		
3/8	0.010	1 1/8	3	3/8	4	90730	90730		
3/8	0.015	1 1/8	3	3/8	4	90930	90930		
3/8	0.020	1 1/8	3	3/8	4	91030	91030		
3/8	0.030	1 1/8	3	3/8	4	91130	91130		
3/8	0.045	1 1/8	3	3/8	4	91230	91230		
3/8	0.060	1 1/8	3	3/8	4	91330	91330		
3/8	0.090	1 1/8	3	3/8	4	91430	91430		
3/8	0.125	1 1/8	3	3/8	4	90830	90830		
3/8	0.010	1 1/2	6	3/8	4			92540	92540
3/8	0.015	1 1/2	6	3/8	4			92740	92740
3/8	0.020	1 1/2	6	3/8	4			92840	92840
3/8	0.030	1 1/2	6	3/8	4			92940	92940
3/8	0.045	1 1/2	6	3/8	4			93040	93040
3/8	0.060	1 1/2	6	3/8	4			93140	93140
3/8	0.090	1 1/2	6	3/8	4			93240	93240
3/8	0.125	1 1/2	6	3/8	4			92640	92640
3/8	0.010	1 3/4	4	3/8	4			90047	90047
3/8	0.015	1 3/4	4	3/8	4			90247	90247

P	●	●	●	●
M	●	●	●	●
K	●	●	●	●
N	●	●	●	●
S	●	●	●	●
H				
O				

End milling cutter with corner radius

▲ Radius accuracy: +/- 0.001

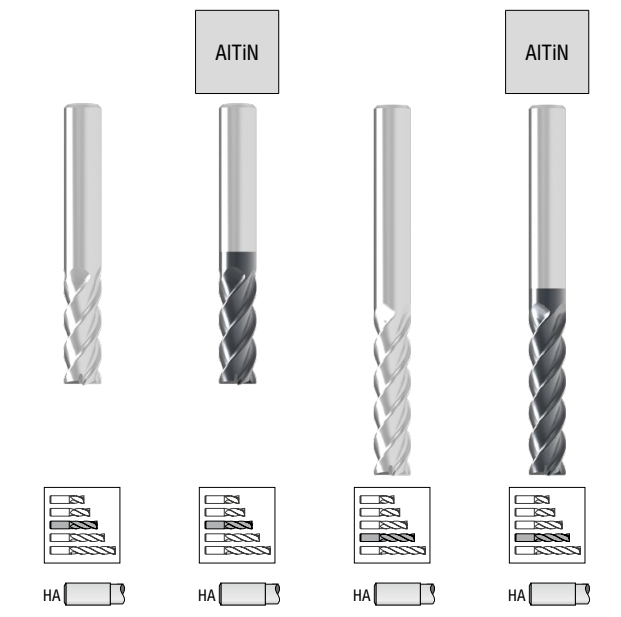
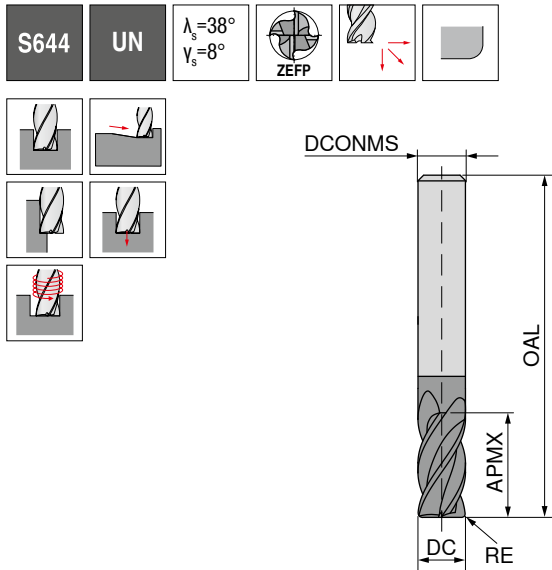

59 072 ... 59 073 ... 59 072 ... 59 073 ...

DC	RE	APMX	OAL	DCONMS	ZEFP				
inch	inch	inch	inch	inch					
3/8	0.020	1 3/4	4	3/8	4				
3/8	0.030	1 3/4	4	3/8	4				
3/8	0.045	1 3/4	4	3/8	4				
3/8	0.060	1 3/4	4	3/8	4				
3/8	0.090	1 3/4	4	3/8	4				
3/8	0.125	1 3/4	4	3/8	4				
1/2	0.010	1 1/2	6	1/2	4				
1/2	0.015	1 1/2	6	1/2	4				
1/2	0.020	1 1/2	6	1/2	4				
1/2	0.030	1 1/2	6	1/2	4				
1/2	0.045	1 1/2	6	1/2	4				
1/2	0.060	1 1/2	6	1/2	4				
1/2	0.090	1 1/2	6	1/2	4				
1/2	0.125	1 1/2	6	1/2	4				
1/2	0.010	2	4	1/2	4				
1/2	0.015	2	4	1/2	4				
1/2	0.020	2	4	1/2	4				
1/2	0.030	2	4	1/2	4				
1/2	0.045	2	4	1/2	4				
1/2	0.060	2	4	1/2	4				
1/2	0.090	2	4	1/2	4				
1/2	0.125	2	4	1/2	4				
5/8	0.015	2	6	5/8	4				
5/8	0.020	2	6	5/8	4				
5/8	0.030	2	6	5/8	4				
5/8	0.045	2	6	5/8	4				
5/8	0.060	2	6	5/8	4				
5/8	0.090	2	6	5/8	4				
5/8	0.125	2	6	5/8	4				
5/8	0.015	2 1/8	4 5/8	5/8	4				
5/8	0.020	2 1/8	4 5/8	5/8	4				
5/8	0.030	2 1/8	4 5/8	5/8	4				
5/8	0.045	2 1/8	4 5/8	5/8	4				
5/8	0.060	2 1/8	4 5/8	5/8	4				
5/8	0.090	2 1/8	4 5/8	5/8	4				
5/8	0.125	2 1/8	4 5/8	5/8	4				
3/4	0.020	2	6	3/4	4				
3/4	0.030	2	6	3/4	4				
3/4	0.045	2	6	3/4	4				
3/4	0.060	2	6	3/4	4				

P	•	•	•	•
M	•	•	•	•
K	•	•	•	•
N	•	•	•	•
S	•	•	•	•
H				
O				

End milling cutter with corner radius

▲ Radius accuracy: +/- 0.001

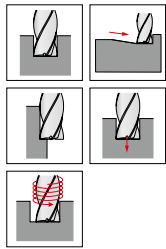
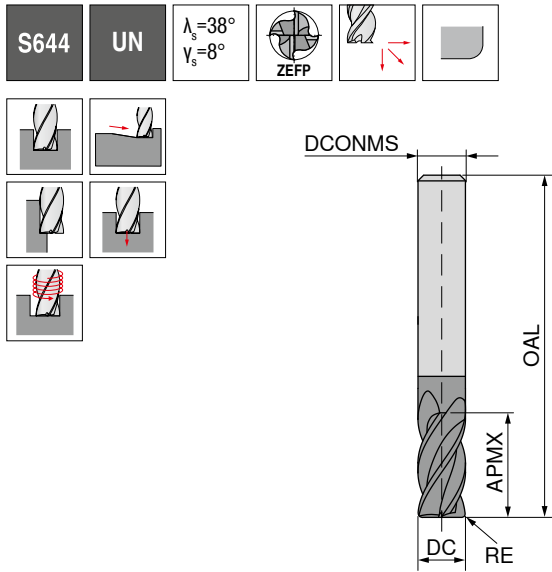

	AITiN		AITiN	
	59 072 ...	59 073 ...	59 072 ...	59 073 ...
91327	91327			
90827	90827			
			91630	91630
			91730	91730
			91830	91830
			91930	91930
			92030	92030
			91530	91530
93320	93320			
93420	93420			
93520	93520			
93620	93620			
93220	93220			
			90923	90923
			91023	91023
			91123	91123
			91223	91223
			90823	90823

DC	RE	APMX	OAL	DCONMS	ZEFP
inch	inch	inch	inch	inch	
3/4	0.090	2	6	3/4	4
3/4	0.125	2	6	3/4	4
3/4	0.020	2 1/4	5	3/4	4
3/4	0.030	2 1/4	5	3/4	4
3/4	0.045	2 1/4	5	3/4	4
3/4	0.060	2 1/4	5	3/4	4
3/4	0.090	2 1/4	5	3/4	4
3/4	0.125	2 1/4	5	3/4	4
1	0.030	2	6	1	4
1	0.045	2	6	1	4
1	0.060	2	6	1	4
1	0.090	2	6	1	4
1	0.125	2	6	1	4
1	0.030	2 1/4	5	1	4
1	0.045	2 1/4	5	1	4
1	0.060	2 1/4	5	1	4
1	0.090	2 1/4	5	1	4
1	0.125	2 1/4	5	1	4

P	•	•	•	•
M	•	•	•	•
K	•	•	•	•
N	•	•	•	•
S	•	•	•	•
H				
O				

→ v_c/f_z Page 110

End milling cutter with corner radius

▲ Radius accuracy: +/- 0.001

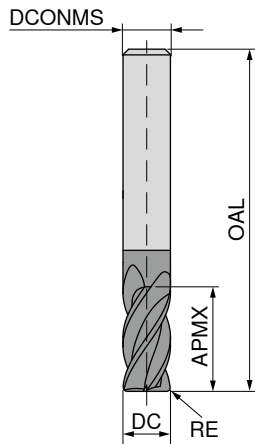
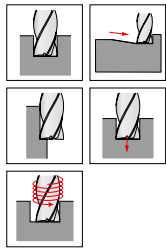
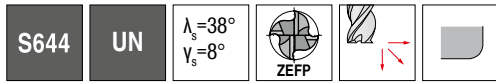

DC	RE	APMX	OAL	DCONMS	ZEPF	59 072 ...	59 073 ...
<small>+0.000/-0.002</small>				<small>-0.0001 / -0.0004</small>			
inch	inch	inch	inch	inch			
1/8	0.010	1	3	1/8	4	90080	90180
1/8	0.015	1	3	1/8	4	90180	90280
1/8	0.020	1	3	1/8	4	90280	90380
1/8	0.030	1	3	1/8	4	90380	90480
1/8	0.045	1	3	1/8	4	90480	90580
3/16	0.010	1 1/8	3	3/16	4	90060	90160
3/16	0.015	1 1/8	3	3/16	4	90160	90260
3/16	0.020	1 1/8	3	3/16	4	90260	90360
3/16	0.030	1 1/8	3	3/16	4	90360	90460
3/16	0.045	1 1/8	3	3/16	4	90460	90560
3/16	0.060	1 1/8	3	3/16	4	90560	90660
1/4	0.010	1 1/2	4	1/4	4	90660	90760
1/4	0.015	1 1/2	4	1/4	4	90760	90860
1/4	0.020	1 1/2	4	1/4	4	90860	90960
1/4	0.030	1 1/2	4	1/4	4	90960	91060
1/4	0.045	1 1/2	4	1/4	4	91060	91160
1/4	0.060	1 1/2	4	1/4	4	91160	91260
1/4	0.090	1 1/2	4	1/4	4	91260	91360
1/4	0.010	1 1/2	6	1/4	4	92160	92260
1/4	0.015	1 1/2	6	1/4	4	92260	92360
1/4	0.020	1 1/2	6	1/4	4	92360	92460
1/4	0.030	1 1/2	6	1/4	4	92460	92560
1/4	0.045	1 1/2	6	1/4	4	92560	92660
1/4	0.060	1 1/2	6	1/4	4	92660	92760
1/4	0.090	1 1/2	6	1/4	4	92760	92860
5/16	0.010	1 5/8	4	5/16	4	90052	90152
5/16	0.015	1 5/8	4	5/16	4	90252	90352
5/16	0.020	1 5/8	4	5/16	4	90352	90452
5/16	0.030	1 5/8	4	5/16	4	90452	90552
5/16	0.045	1 5/8	4	5/16	4	90552	90652
5/16	0.060	1 5/8	4	5/16	4	90652	90752
5/16	0.090	1 5/8	4	5/16	4	90752	90852
5/16	0.125	1 5/8	4	5/16	4	90152	90252
3/8	0.010	3	6	3/8	4	90580	90680
3/8	0.015	3	6	3/8	4	90780	90880
3/8	0.020	3	6	3/8	4	90880	90980
3/8	0.030	3	6	3/8	4	90980	91080
3/8	0.045	3	6	3/8	4	91080	91180
3/8	0.060	3	6	3/8	4	91180	91280
3/8	0.090	3	6	3/8	4	91280	91380

P	●	●
M	●	●
K	●	●
N	●	●
S	●	●
H		
O		

End milling cutter with corner radius

▲ Radius accuracy: +/- 0.001

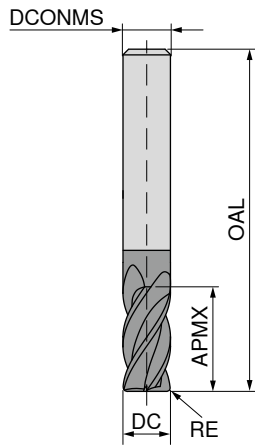
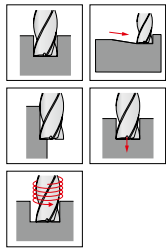
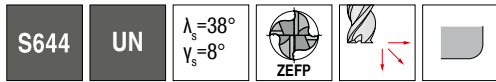

DC +0.000/-0.002 inch	RE inch	APMX inch	OAL inch	DCONMS -0.0001 / -0.0004 inch	ZEFP	59 072 ...	59 073 ...
3/8	0.125	3	6	3/8	4	90680	90780
1/2	0.010	3	6	1/2	4	91360	91460
1/2	0.015	3	6	1/2	4	91560	91660
1/2	0.020	3	6	1/2	4	91660	91760
1/2	0.030	3	6	1/2	4	91760	91860
1/2	0.045	3	6	1/2	4	91860	91960
1/2	0.060	3	6	1/2	4	91960	92060
1/2	0.090	3	6	1/2	4	92060	92160
1/2	0.125	3	6	1/2	4	91460	91560
5/8	0.015	3	6	5/8	4	90148	90148
5/8	0.020	3	6	5/8	4	90248	90248
5/8	0.030	3	6	5/8	4	90348	90348
5/8	0.045	3	6	5/8	4	90448	90448
5/8	0.060	3	6	5/8	4	90548	90548
5/8	0.090	3	6	5/8	4	90648	90648
5/8	0.125	3	6	5/8	4	90048	90048
3/4	0.020	3	6	3/4	4	91340	91340
3/4	0.030	3	6	3/4	4	91440	91440
3/4	0.045	3	6	3/4	4	91540	91540
3/4	0.060	3	6	3/4	4	91640	91640
3/4	0.090	3	6	3/4	4	91740	91740
3/4	0.125	3	6	3/4	4	91240	91240
1	0.030	3	6	1	4	92230	92230
1	0.045	3	6	1	4	92330	92330
1	0.060	3	6	1	4	92430	92430
1	0.090	3	6	1	4	92530	92530
1	0.125	3	6	1	4	92130	92130
P						•	•
M						•	•
K						•	•
N						•	•
S						•	•
H							
O							

→ v_c/f_z Page 110

End milling cutter

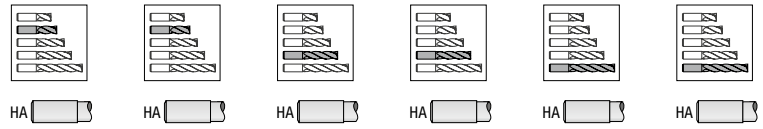
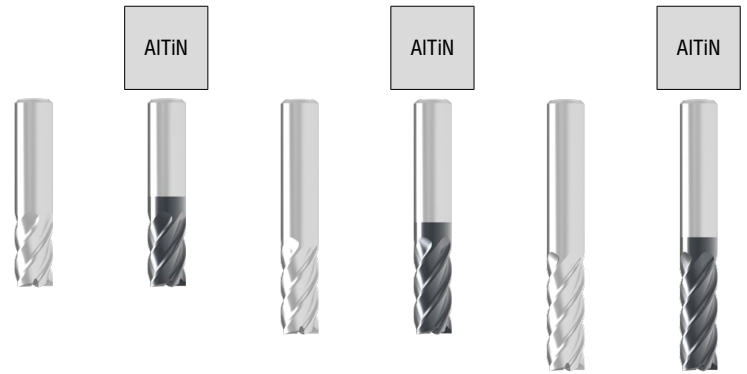
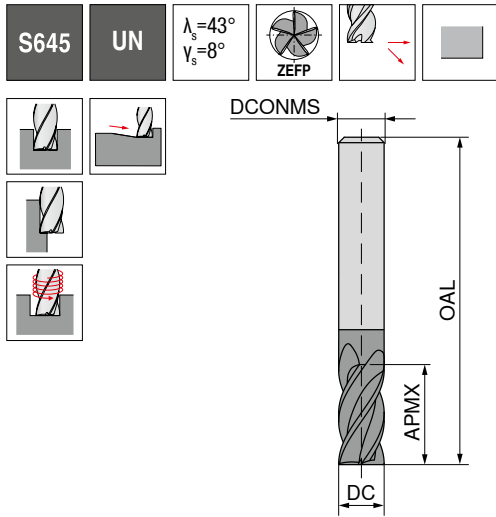

DC +0.0001/-0.002 inch	APMX inch	OAL inch	DCONMS -0.0001/-0.0004 inch	ZEFP	59 074 ...	59 075 ...	59 074 ...	59 075 ...	59 074 ...	59 075 ...
1/8	1/4	1 1/2	1/8	5	12520	12520				
1/8	1/2	1 1/2	1/8	5			12540	12540		
5/32	5/16	2	3/16	5	15620	15620				
5/32	9/16	2	3/16	5			15636	15636		
3/16	5/16	2	3/16	5	18817	18817				
3/16	9/16	2	3/16	5			18830	18830		
7/32	3/8	2	1/4	5	21917	21917				
7/32	3/4	2 1/2	1/4	5			21934	21934		
1/4	3/8	2	1/4	5	25015	25015				
1/4	3/4	2 1/2	1/4	5			25030	25030		
1/4	1 1/4	4	1/4	5					25050	25050
5/16	7/16	2	5/16	5	31314	31314				
5/16	13/16	2 1/2	5/16	5			31326	31326		
3/8	1/2	2	3/8	5	37513	37513				
3/8	1	2 1/2	3/8	5			37527	37527		
3/8	1 1/2	4	3/8	5					37540	37540
1/2	5/8	2 1/2	1/2	5	50013	50013				
1/2	1 1/4	3	1/2	5			50025	50025		
1/2	2	4	1/2	5					50040	50040
5/8	3/4	3	5/8	5	62512	62512				
5/8	1 5/8	3 1/2	5/8	5			62526	62526		
5/8	2 1/2	5	5/8	5					62540	62540
3/4	1	3	3/4	5	75013	75013				
3/4	1 5/8	4	3/4	5			75022	75022		
3/4	3 1/4	6	3/4	5					75043	75043
1	1 1/4	3	1	5	99913	99913				
1	2	4	1	5			99920	99920		
1	3 1/4	6	1	5					99933	99933

P	•	•	•	•	•	•
M	•	•	•	•	•	•
K	•	•	•	•	•	•
N						
S						
H						
O						

→ v_c/f_z Page 111

End milling cutter

P007
UN
 $\lambda_s = 35^\circ$
 $\nu_s = 38^\circ$
 $\nu_s = 9^\circ$
ZEFP
HPC

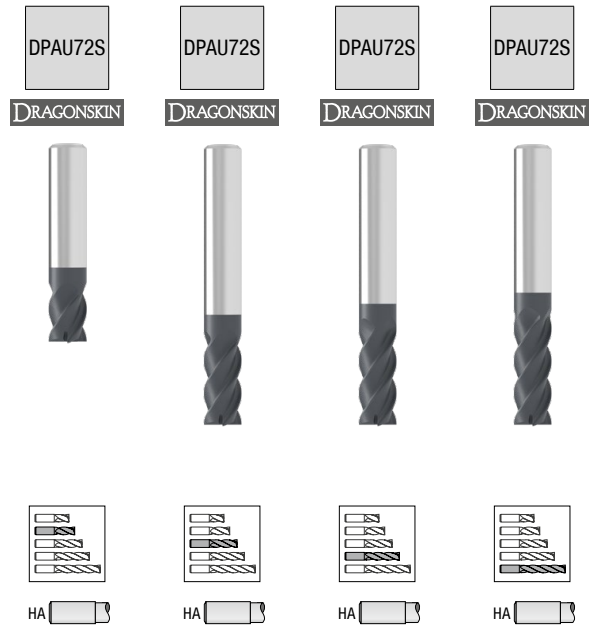
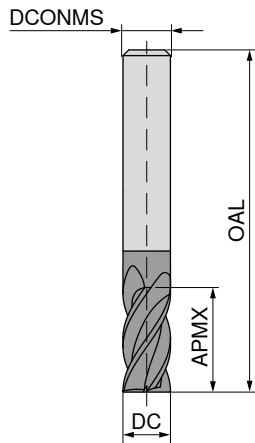
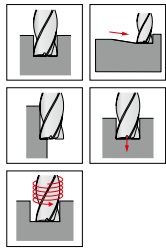

DC +0.0001/-0.002 inch	APMX inch	OAL inch	DCONMS -0.0001 / -0.0004 inch	ZEFP
1/8	1/4	1 1/2	1/8	4
1/8	1/2	2 1/2	1/8	4
3/16	5/16	2	3/16	4
3/16	5/8	2 1/2	3/16	4
1/4	3/8	2	1/4	4
1/4	1/2	2 1/2	1/4	4
1/4	3/4	2 1/2	1/4	4
1/4	1	3	1/4	4
5/16	1/2	2	5/16	4
5/16	3/4	2 1/2	5/16	4
5/16	1 1/4	3	5/16	4
3/8	1/2	2	3/8	4
3/8	7/8	3	3/8	4
3/8	1	3	3/8	4
3/8	1 1/4	3	3/8	4
1/2	5/8	2 1/2	1/2	4
1/2	1	3	1/2	4
1/2	1 1/4	3	1/2	4
1/2	1 5/8	4	1/2	4
5/8	3/4	3	5/8	4
5/8	1 1/4	3 1/2	5/8	4
5/8	1 5/8	3 1/2	5/8	4
5/8	2	4	5/8	4
5/8	3 1/4	6	5/8	4
3/4	7/8	3	3/8	4
3/4	1 1/4	4	3/4	4
3/4	1 5/8	4	3/4	4
3/4	2 1/4	5	3/4	4
3/4	3 1/4	6	3/4	4
1	1 1/2	4	1	4
1	2	4 1/2	1	4
1	2 5/8	5	1	4
1	3	6	1	4
1	4 1/4	7	1	4

59 002 ...	59 002 ...	59 002 ...	59 002 ...
12520			
18817			12640
25015			
	25020		
		25030	
			25040
31316			
	31324		
		31340	
37513			
	37523		
		37527	
			37533
50013			
	50020		
		50025	
			50033
62512			
	62520		
		62526	
			62532
			62552
75012			
	75017		
		75022	
			75030
			75043
99915			
	99920		
		99926	
			99930
			99943

P	•	•	•	•
M	•	•	•	•
K	•	•	•	•
N	•	•	•	•
S	•	•	•	•
H				
O				

→ v_c/f_z Page 112

End milling cutter with corner radius

▲ Radius accuracy: +/- 0.001 for $\varnothing \leq 0.060$
+/- 0.0015 for $\varnothing > 0.060$

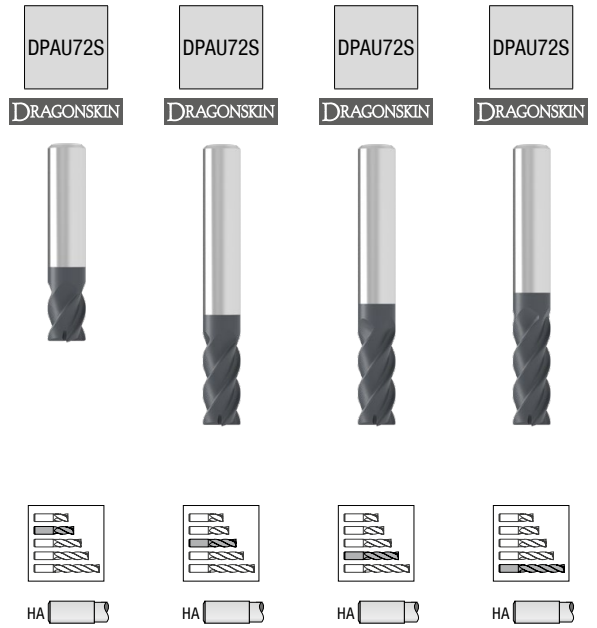
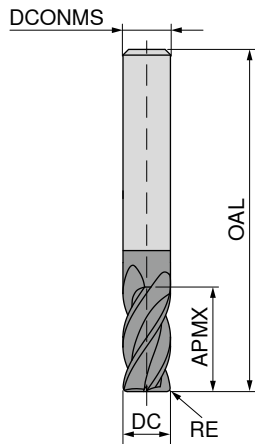
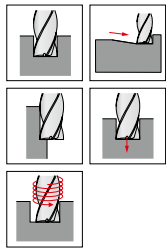
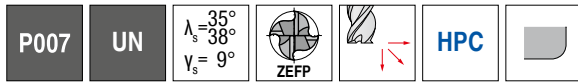

DC ±0.000/-0.002 inch	RE inch	APMX inch	OAL inch	DCONMS ±0.0001 / -0.0004 inch	ZEFP	59 002 ...	59 002 ...	59 002 ...	59 002 ...
1/8	0.010	1/4	1 1/2	1/8	4	90020			
1/8	0.030	1/4	1 1/2	1/8	4	90120			
1/8	0.010	1/2	2 1/2	1/8	4			90040	
1/8	0.030	1/2	2 1/2	1/8	4				90140
3/16	0.010	5/16	2	3/16	4	90017			
3/16	0.030	5/16	2	3/16	4	90117			
3/16	0.010	5/8	2 1/2	3/16	4			90033	
3/16	0.030	5/8	2 1/2	3/16	4			90133	
1/4	0.020	3/8	2	1/4	4	90015			
1/4	0.030	3/8	2	1/4	4	90115			
1/4	0.060	3/8	2	1/4	4	90215			
1/4	0.020	1/2	2 1/2	1/4	4		90220		
1/4	0.030	1/2	2 1/2	1/4	4		90320		
1/4	0.060	1/2	2 1/2	1/4	4		90420		
1/4	0.020	3/4	2 1/2	1/4	4			90030	
1/4	0.030	3/4	2 1/2	1/4	4			90130	
1/4	0.060	3/4	2 1/2	1/4	4			90230	
1/4	0.020	1	3	1/4	4				90240
1/4	0.030	1	3	1/4	4				90340
1/4	0.060	1	3	1/4	4				90440
5/16	0.020	1/2	2	5/16	4	90016			
5/16	0.030	1/2	2	5/16	4	90116			
5/16	0.060	1/2	2	5/16	4	90216			
5/16	0.020	3/4	2 1/2	5/16	4		90024		
5/16	0.030	3/4	2 1/2	5/16	4		90124		
5/16	0.060	3/4	2 1/2	5/16	4		90224		
5/16	0.020	1 1/4	3	5/16	4			90540	
5/16	0.030	1 1/4	3	5/16	4			90640	
5/16	0.060	1 1/4	3	5/16	4			90740	
3/8	0.020	1/2	2	3/8	4	90013			
3/8	0.030	1/2	2	3/8	4	90113			
3/8	0.060	1/2	2	3/8	4	90213			
3/8	0.090	1/2	2	3/8	4	90313			
3/8	0.020	7/8	3	3/8	4		90023		
3/8	0.030	7/8	3	3/8	4		90123		
3/8	0.060	7/8	3	3/8	4		90223		
3/8	0.090	7/8	3	3/8	4		90323		
3/8	0.020	1	3	3/8	4			90027	

P	•	•	•	•
M	•	•	•	•
K	•	•	•	•
N	•	•	•	•
S	•	•	•	•
H				
O				

End milling cutter with corner radius

▲ Radius accuracy: +/- 0.001 for $\varnothing \leq 0.060$
+/- 0.0015 for $\varnothing > 0.060$

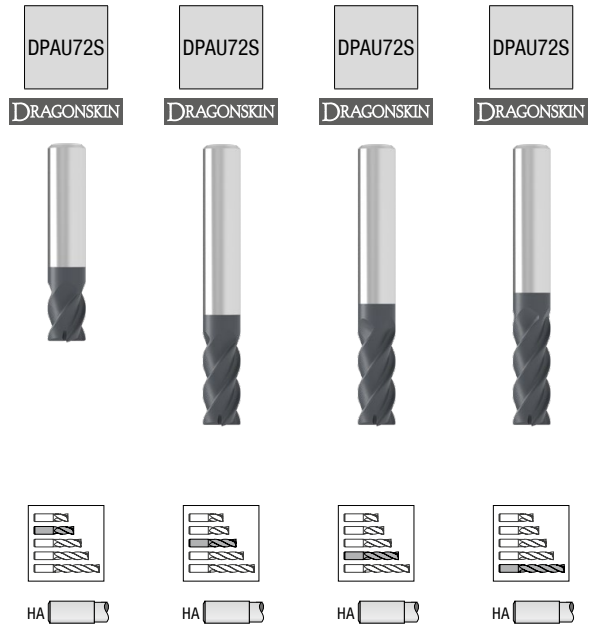
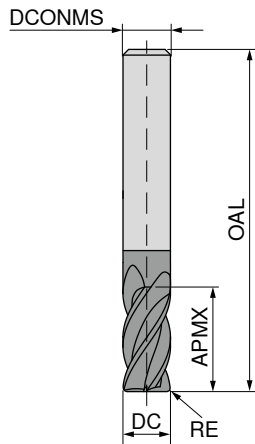
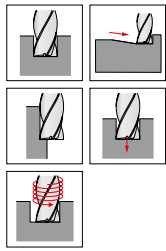
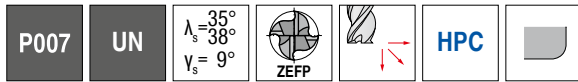

DC ±0.000/-0.002 inch	RE inch	APMX inch	OAL inch	DCONMS -0.0001/-0.0004 inch	ZFP
3/8	0.030	1	3	3/8	4
3/8	0.060	1	3	3/8	4
3/8	0.090	1	3	3/8	4
3/8	0.020	1 1/4	3	3/8	4
3/8	0.030	1 1/4	3	3/8	4
3/8	0.060	1 1/4	3	3/8	4
3/8	0.090	1 1/4	3	3/8	4
1/2	0.020	5/8	2 1/2	1/2	4
1/2	0.030	5/8	2 1/2	1/2	4
1/2	0.060	5/8	2 1/2	1/2	4
1/2	0.090	5/8	2 1/2	1/2	4
1/2	0.125	5/8	2 1/2	1/2	4
1/2	0.020	1	3	1/2	4
1/2	0.030	1	3	1/2	4
1/2	0.060	1	3	1/2	4
1/2	0.090	1	3	1/2	4
1/2	0.125	1	3	1/2	4
1/2	0.020	1 1/4	3	1/2	4
1/2	0.030	1 1/4	3	1/2	4
1/2	0.060	1 1/4	3	1/2	4
1/2	0.090	1 1/4	3	1/2	4
1/2	0.125	1 1/4	3	1/2	4
1/2	0.020	1 5/8	4	1/2	4
1/2	0.030	1 5/8	4	1/2	4
1/2	0.060	1 5/8	4	1/2	4
1/2	0.090	1 5/8	4	1/2	4
1/2	0.125	1 5/8	4	1/2	4
5/8	0.030	3/4	3	5/8	4
5/8	0.060	3/4	3	5/8	4
5/8	0.090	3/4	3	5/8	4
5/8	0.125	3/4	3	5/8	4
5/8	0.030	1 1/4	3 1/2	5/8	4
5/8	0.060	1 1/4	3 1/2	5/8	4
5/8	0.090	1 1/4	3 1/2	5/8	4
5/8	0.125	1 1/4	3 1/2	5/8	4
5/8	0.030	1 5/8	3 1/2	5/8	4
5/8	0.060	1 5/8	3 1/2	5/8	4
5/8	0.090	1 5/8	3 1/2	5/8	4

59 002 ...	59 002 ...	59 002 ...	59 002 ...
		90127	
		90227	
		90327	
			90233
			90333
			90433
			90533
90413			
90513			
90613			
90713			
90813			
	90520		
	90620		
	90720		
	90820		
	90920		
		90025	
		90125	
		90225	
		90325	
		90425	
			90633
			90733
			90833
			90933
			91033
90012			
90112			
90212			
90312			
	91020		
	91120		
	91220		
	91320		
		90026	
		90126	
		90226	

P	•	•	•	•
M	•	•	•	•
K	•	•	•	•
N	•	•	•	•
S	•	•	•	•
H				
O				

End milling cutter with corner radius

▲ Radius accuracy: +/- 0.001 for $\varnothing \leq 0.060$
+/- 0.0015 for $\varnothing > 0.060$

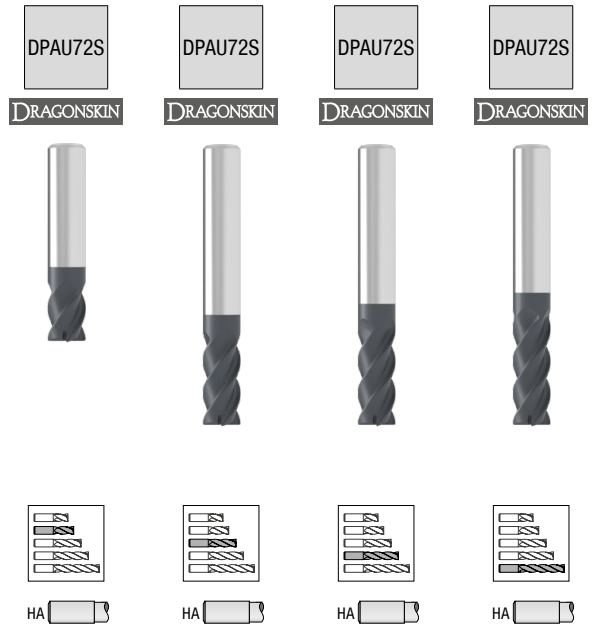
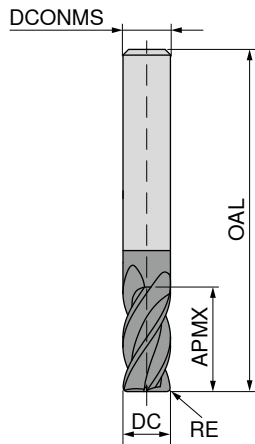
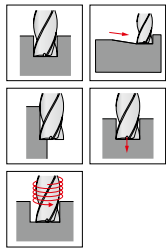
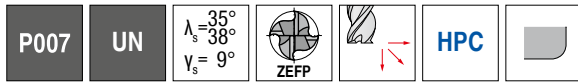

59 002 ... 59 002 ... 59 002 ... 59 002 ...

DC +0.000/-0.002 inch	RE inch	APMX inch	OAL inch	DCONMS -0.0001 / -0.0004 inch	ZEFP				
5/8	0.125	1 5/8	3 1/2	5/8	4				90326
5/8	0.030	2	4	5/8	4				90032
5/8	0.060	2	4	5/8	4				90132
5/8	0.090	2	4	5/8	4				90232
5/8	0.125	2	4	5/8	4				90332
5/8	0.030	3 1/4	6	5/8	4				90052
5/8	0.060	3 1/4	6	5/8	4				90152
5/8	0.090	3 1/4	6	5/8	4				90252
5/8	0.125	3 1/4	6	5/8	4				90352
3/4	0.030	7/8	3	3/8	4	90412			
3/4	0.060	7/8	3	3/8	4	90512			
3/4	0.090	7/8	3	3/8	4	90612			
3/4	0.125	7/8	3	3/8	4	90712			
3/4	0.190	7/8	3	3/8	4	90812			
3/4	0.250	7/8	3	3/8	4	90912			
3/4	0.030	1 1/4	4	3/4	4		90217		
3/4	0.060	1 1/4	4	3/4	4		90317		
3/4	0.090	1 1/4	4	3/4	4		90417		
3/4	0.125	1 1/4	4	3/4	4		90517		
3/4	0.190	1 1/4	4	3/4	4		90617		
3/4	0.250	1 1/4	4	3/4	4		90717		
3/4	0.030	1 5/8	4	3/4	4			90022	
3/4	0.060	1 5/8	4	3/4	4			90122	
3/4	0.090	1 5/8	4	3/4	4			90222	
3/4	0.125	1 5/8	4	3/4	4			90322	
3/4	0.190	1 5/8	4	3/4	4			90422	
3/4	0.250	1 5/8	4	3/4	4			90522	
3/4	0.030	2 1/4	5	3/4	4				90330
3/4	0.060	2 1/4	5	3/4	4				90430
3/4	0.090	2 1/4	5	3/4	4				90530
3/4	0.125	2 1/4	5	3/4	4				90630
3/4	0.190	2 1/4	5	3/4	4				90730
3/4	0.250	2 1/4	5	3/4	4				90830
3/4	0.030	3 1/4	6	3/4	4				90043
3/4	0.060	3 1/4	6	3/4	4				90143
3/4	0.090	3 1/4	6	3/4	4				90243
3/4	0.125	3 1/4	6	3/4	4				90343
3/4	0.190	3 1/4	6	3/4	4				90443

P	•	•	•	•
M	•	•	•	•
K	•	•	•	•
N	•	•	•	•
S	•	•	•	•
H				
O				

End milling cutter with corner radius

▲ Radius accuracy: +/- 0.001 for $\varnothing \leq 0.060$
+/- 0.0015 for $\varnothing > 0.060$

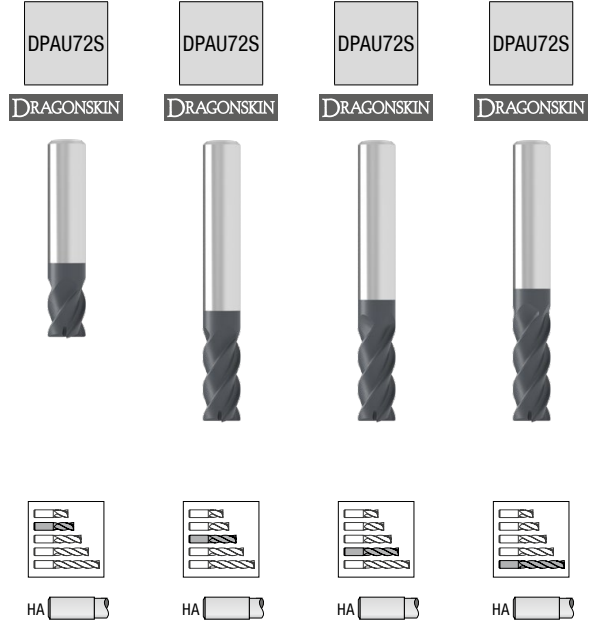
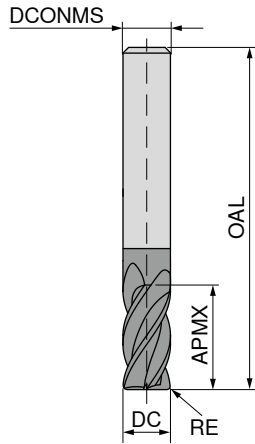
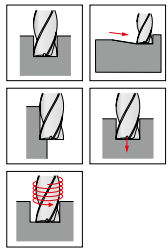
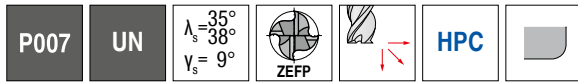

59 002 ... 59 002 ... 59 002 ... 59 002 ...

DC +0.000/-0.002 inch	RE inch	APMX inch	OAL inch	DCONMS -0.0001 / -0.0004 inch	ZEFP	59 002 ...	59 002 ...	59 002 ...	59 002 ...
3/4	0.250	3 1/4	6	3/4	4				90543
1	0.030	1 1/2	4	1	4	90315			
1	0.060	1 1/2	4	1	4	90415			
1	0.090	1 1/2	4	1	4	90515			
1	0.125	1 1/2	4	1	4	90615			
1	0.190	1 1/2	4	1	4	90715			
1	0.250	1 1/2	4	1	4	90815			
1	0.030	2	4 1/2	1	4		91420		
1	0.060	2	4 1/2	1	4		91520		
1	0.090	2	4 1/2	1	4		91620		
1	0.125	2	4 1/2	1	4		91720		
1	0.190	2	4 1/2	1	4		91820		
1	0.250	2	4 1/2	1	4		91920		
1	0.030	2 5/8	5	1	4			90426	
1	0.060	2 5/8	5	1	4			90526	
1	0.090	2 5/8	5	1	4			90626	
1	0.125	2 5/8	5	1	4			90726	
1	0.190	2 5/8	5	1	4			90826	
1	0.250	2 5/8	5	1	4			90926	
1	0.030	3	6	1	4				90930
1	0.060	3	6	1	4				91030
1	0.090	3	6	1	4				91130
1	0.125	3	6	1	4				91230
1	0.190	3	6	1	4				91330
1	0.250	3	6	1	4				91430
1	0.030	4 1/4	7	1	4				90643
1	0.060	4 1/4	7	1	4				90743
1	0.090	4 1/4	7	1	4				90843
1	0.125	4 1/4	7	1	4				90943
1	0.190	4 1/4	7	1	4				91043
1	0.250	4 1/4	7	1	4				91143

P	•	•	•	•
M	•	•	•	•
K	•	•	•	•
N	•	•	•	•
S	•	•	•	•
H				
O				

→ v_c/f_z Page 112

End milling cutter

▲ Cutting edges with irregular pitch

P556
UN
 $\lambda_s=38^\circ$
 $\nu_s=07^\circ$
ZEFP
HPC

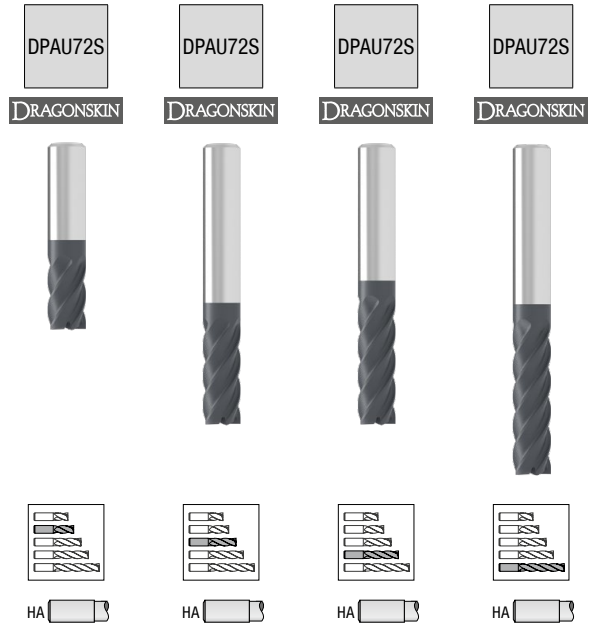
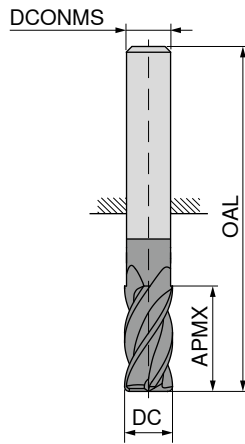
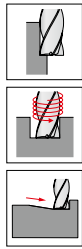

DC +0.0001/-0.002 inch	APMX inch	OAL inch	DCONMS -0.0001/-0.0004 inch	ZEFP
1/4	3/8	2	1/4	5
1/4	1/2	2 1/2	1/4	5
1/4	3/4	2 1/2	1/4	5
1/4	1	3	1/4	5
1/4	1 1/4	3	1/4	5
3/8	1/2	2	3/8	5
3/8	1	3	3/8	5
3/8	1 1/4	3	3/8	5
3/8	1 1/2	3 1/2	3/8	5
1/2	5/8	2 1/2	1/2	5
1/2	1	3	1/2	5
1/2	1 1/4	3	1/2	5
1/2	1 5/8	4	1/2	5
1/2	2	4	1/2	5
5/8	3/4	3	5/8	5
5/8	1 1/4	3 1/2	5/8	5
5/8	1 5/8	3 1/2	5/8	5
5/8	2 1/4	4	5/8	5
5/8	2 1/2	5	5/8	5
3/4	1	3	3/4	5
3/4	1 5/8	4	3/4	5
3/4	2 1/4	5	3/4	5
3/4	2 3/4	5	3/4	5
3/4	3 1/4	6	3/4	5
1	1 1/4	4	1	5
1	2	4 1/2	1	5
1	2 5/8	5	1	5
1	3 1/4	6	1	5
1	4 1/4	7	1	5

59 006 ...	59 006 ...	59 006 ...	59 006 ...
25015			
	25020		
		25030	
			25040
			25050
37513			
	37527		
		37533	
			37540
50013			
	50020		
		50025	
			50033
			50040
62512			
	62520		
		62526	
			62536
			62540
75013			
	75022		
		75030	
			75037
			75043
99913			
	99920		
		99926	
			99933
			99943

P	•	•	•	•
M	•	•	•	•
K	•	•	•	•
N	•	•	•	•
S	•	•	•	•
H				
O				

→ v_c/f_z Page 113

End milling cutter with corner radius

- ▲ Cutting edges with irregular pitch
- ▲ Radius accuracy: +/- 0.001 for $\varnothing \leq 0.060$
+/- 0.0015 for $\varnothing > 0.060$

P556
UN
 $\lambda_s=38^\circ$
 $\nu_s=07^\circ$
ZEP
HPC

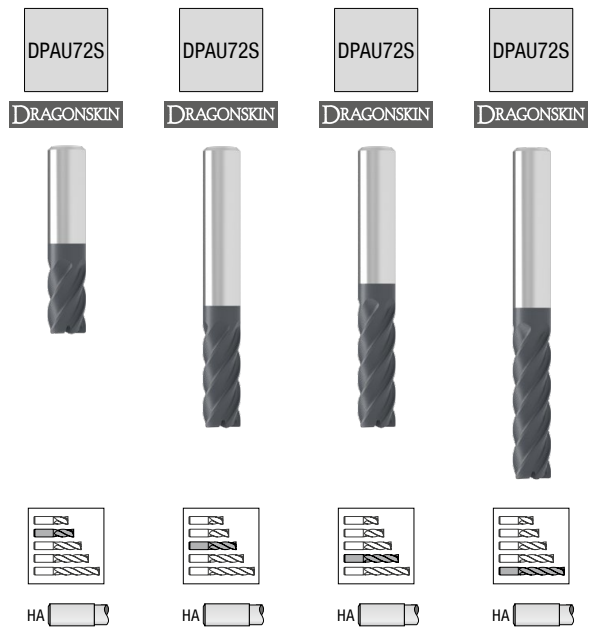
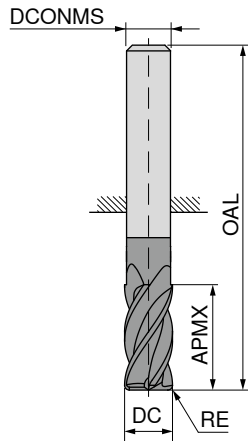
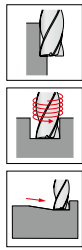

DC	RE	APMX	OAL	DCONMS	ZEP
$\pm 0.000/-0.002$				$-0.0001 / -0.0004$	
inch	inch	inch	inch	inch	
1/4	0.015	3/8	2	1/4	5
1/4	0.030	3/8	2	1/4	5
1/4	0.060	3/8	2	1/4	5
1/4	0.015	1/2	2 1/2	1/4	5
1/4	0.030	1/2	2 1/2	1/4	5
1/4	0.060	1/2	2 1/2	1/4	5
1/4	0.015	3/4	2 1/2	1/4	5
1/4	0.030	3/4	2 1/2	1/4	5
1/4	0.060	3/4	2 1/2	1/4	5
1/4	0.015	1	3	1/4	5
1/4	0.030	1	3	1/4	5
1/4	0.060	1	3	1/4	5
1/4	0.015	1 1/4	3	1/4	5
1/4	0.030	1 1/4	3	1/4	5
1/4	0.060	1 1/4	3	1/4	5
3/8	0.015	1/2	2	3/8	5
3/8	0.030	1/2	2	3/8	5
3/8	0.060	1/2	2	3/8	5
3/8	0.090	1/2	2	3/8	5
3/8	0.015	1	3	3/8	5
3/8	0.030	1	3	3/8	5
3/8	0.060	1	3	3/8	5
3/8	0.090	1	3	3/8	5
3/8	0.015	1 1/4	3	3/8	5
3/8	0.030	1 1/4	3	3/8	5
3/8	0.060	1 1/4	3	3/8	5
3/8	0.090	1 1/4	3	3/8	5
3/8	0.015	1 1/2	3 1/2	3/8	5
3/8	0.030	1 1/2	3 1/2	3/8	5
3/8	0.060	1 1/2	3 1/2	3/8	5
3/8	0.090	1 1/2	3 1/2	3/8	5
1/2	0.015	5/8	2 1/2	1/2	5
1/2	0.030	5/8	2 1/2	1/2	5
1/2	0.060	5/8	2 1/2	1/2	5
1/2	0.090	5/8	2 1/2	1/2	5
1/2	0.125	5/8	2 1/2	1/2	5
1/2	0.015	1	3	1/2	5

59 006 ...	59 006 ...	59 006 ...	59 006 ...
90015			
90115			
90215			
	90020		
	90120		
	90220		
		90030	
		90130	
		90230	
			90040
			90140
			90240
			90050
			90150
			90250
90013			
90113			
90213			
90313			
	90027		
	90127		
	90227		
	90327		
		90033	
		90133	
		90233	
		90333	
			90340
			90440
			90540
			90640
90413			
90513			
90613			
90713			
90813			
	90320		

P	•	•	•	•
M	•	•	•	•
K	•	•	•	•
N				
S	•	•	•	•
H				
O				

End milling cutter with corner radius

- ▲ Cutting edges with irregular pitch
- ▲ Radius accuracy: +/- 0.001 for $\varnothing \leq 0.060$
+/- 0.0015 for $\varnothing > 0.060$

P556
UN
 $\lambda_s=38^\circ$
 $\nu_s=07^\circ$
ZEP
HPC

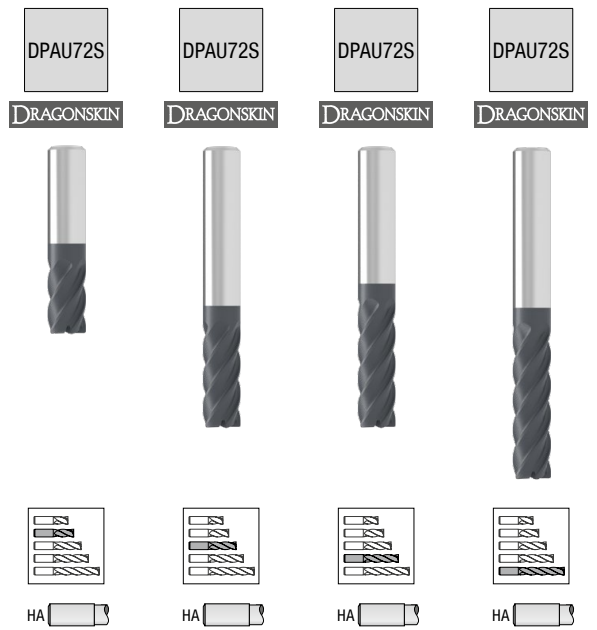
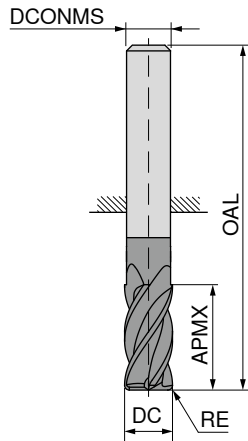
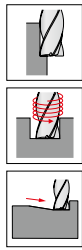

DC	RE	APMX	OAL	DCONMS	ZEP
<small>+0.000/-0.002</small>				<small>-0.0001 / -0.0004</small>	
inch	inch	inch	inch	inch	
1/2	0.030	1	3	1/2	5
1/2	0.060	1	3	1/2	5
1/2	0.090	1	3	1/2	5
1/2	0.125	1	3	1/2	5
1/2	0.015	1 1/4	3	1/2	5
1/2	0.030	1 1/4	3	1/2	5
1/2	0.060	1 1/4	3	1/2	5
1/2	0.090	1 1/4	3	1/2	5
1/2	0.125	1 1/4	3	1/2	5
1/2	0.015	1 5/8	4	1/2	5
1/2	0.030	1 5/8	4	1/2	5
1/2	0.060	1 5/8	4	1/2	5
1/2	0.090	1 5/8	4	1/2	5
1/2	0.125	1 5/8	4	1/2	5
1/2	0.015	2	4	1/2	5
1/2	0.030	2	4	1/2	5
1/2	0.060	2	4	1/2	5
1/2	0.090	2	4	1/2	5
1/2	0.125	2	4	1/2	5
5/8	0.030	3/4	3	5/8	5
5/8	0.060	3/4	3	5/8	5
5/8	0.090	3/4	3	5/8	5
5/8	0.125	3/4	3	5/8	5
5/8	0.030	1 1/4	3 1/2	5/8	5
5/8	0.060	1 1/4	3 1/2	5/8	5
5/8	0.090	1 1/4	3 1/2	5/8	5
5/8	0.125	1 1/4	3 1/2	5/8	5
5/8	0.030	1 5/8	3 1/2	5/8	5
5/8	0.060	1 5/8	3 1/2	5/8	5
5/8	0.090	1 5/8	3 1/2	5/8	5
5/8	0.125	1 5/8	3 1/2	5/8	5
5/8	0.030	2 1/4	4	5/8	5
5/8	0.060	2 1/4	4	5/8	5
5/8	0.090	2 1/4	4	5/8	5
5/8	0.125	2 1/4	4	5/8	5
5/8	0.030	2 1/2	5	5/8	5
5/8	0.060	2 1/2	5	5/8	5

59 006 ...	59 006 ...	59 006 ...	59 006 ...
	90420		
	90520		
	90620		
	90720		
		90025	
		90125	
		90225	
		90325	
		90425	
			90433
			90533
			90633
			90733
			90833
			90740
			90840
			90940
			91040
			91140
90012			
90112			
90212			
90312			
	90820		
	90920		
	91020		
	91120		
		90026	
		90126	
		90226	
		90326	
			90036
			90136
			90236
			90336
			91240
			91340

P	•	•	•	•
M	•	•	•	•
K	•	•	•	•
N				
S	•	•	•	•
H				
O				

End milling cutter with corner radius

- ▲ Cutting edges with irregular pitch
- ▲ Radius accuracy: +/- 0.001 for $\varnothing \leq 0.060$
+/- 0.0015 for $\varnothing > 0.060$

P556
UN
 $\lambda_s=38^\circ$
 $\nu_s=07^\circ$
ZEP
HPC

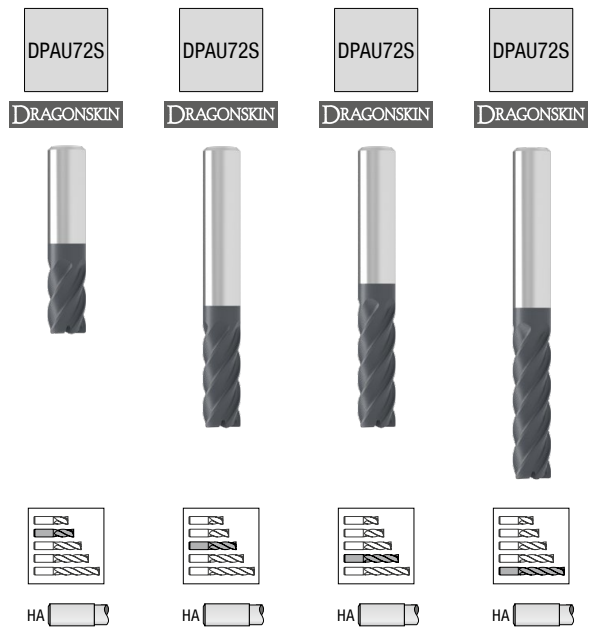
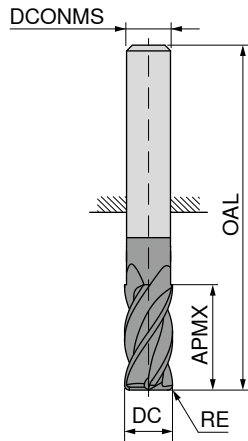
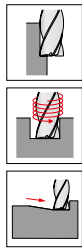

DC $+0.000/-0.002$	RE	APMX	OAL	DCONMS $-0.0001 / -0.0004$	ZEP
inch	inch	inch	inch	inch	
5/8	0.090	2 1/2	5	5/8	5
5/8	0.125	2 1/2	5	5/8	5
3/4	0.030	1	3	3/4	5
3/4	0.060	1	3	3/4	5
3/4	0.090	1	3	3/4	5
3/4	0.125	1	3	3/4	5
3/4	0.190	1	3	3/4	5
3/4	0.250	1	3	3/4	5
3/4	0.030	1 5/8	4	3/4	5
3/4	0.060	1 5/8	4	3/4	5
3/4	0.090	1 5/8	4	3/4	5
3/4	0.125	1 5/8	4	3/4	5
3/4	0.190	1 5/8	4	3/4	5
3/4	0.250	1 5/8	4	3/4	5
3/4	0.030	2 1/4	5	3/4	5
3/4	0.060	2 1/4	5	3/4	5
3/4	0.090	2 1/4	5	3/4	5
3/4	0.125	2 1/4	5	3/4	5
3/4	0.190	2 1/4	5	3/4	5
3/4	0.250	2 1/4	5	3/4	5
3/4	0.030	2 3/4	5	3/4	5
3/4	0.060	2 3/4	5	3/4	5
3/4	0.090	2 3/4	5	3/4	5
3/4	0.125	2 3/4	5	3/4	5
3/4	0.190	2 3/4	5	3/4	5
3/4	0.250	2 3/4	5	3/4	5
3/4	0.030	3 1/4	6	3/4	5
3/4	0.060	3 1/4	6	3/4	5
3/4	0.090	3 1/4	6	3/4	5
3/4	0.125	3 1/4	6	3/4	5
3/4	0.190	3 1/4	6	3/4	5
3/4	0.250	3 1/4	6	3/4	5
1	0.030	1 1/4	4	1	5
1	0.060	1 1/4	4	1	5
1	0.090	1 1/4	4	1	5
1	0.125	1 1/4	4	1	5
1	0.190	1 1/4	4	1	5

59 006 ...	59 006 ...	59 006 ...	59 006 ...
			91440
			91540
90913			
91013			
91113			
91213			
91313			
91413			
	90022		
	90122		
	90222		
	90322		
	90422		
	90522		
		90330	
		90430	
		90530	
		90630	
		90730	
		90830	
			90037
			90137
			90237
			90337
			90437
			90537
			90043
			90143
			90243
			90343
			90443
			90543
91513			
91613			
91713			
91813			
91913			

P	•	•	•	•
M	•	•	•	•
K	•	•	•	•
N				
S	•	•	•	•
H				
O				

End milling cutter with corner radius

- ▲ Cutting edges with irregular pitch
- ▲ Radius accuracy: +/- 0.001 for $\varnothing \leq 0.060$
+/- 0.0015 for $\varnothing > 0.060$

P556
UN
 $\lambda_s=38^\circ$
 $\nu_s=07^\circ$
ZFP
HPC

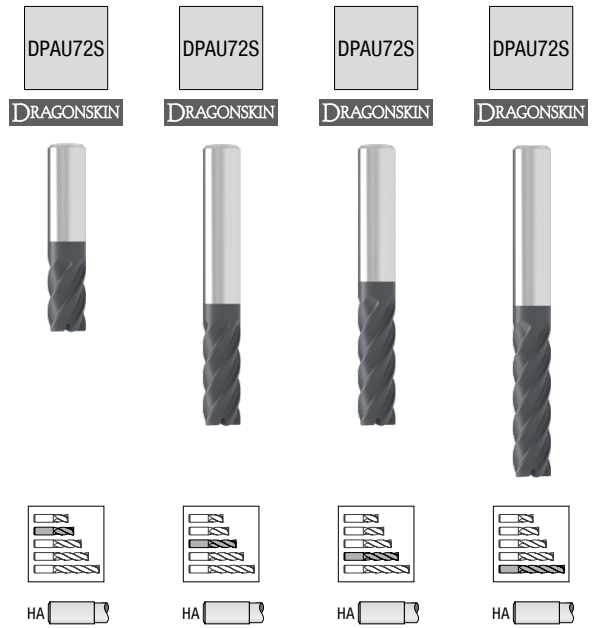
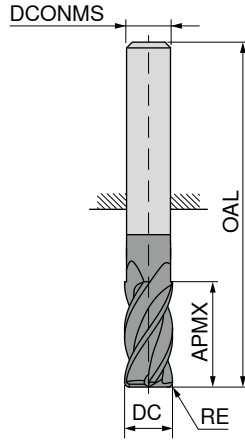

DC <small>+0.000/-0.002</small>	RE	APMX	OAL	DCONMS <small>-0.0001 / -0.0004</small>	ZFP	59 006 ...	59 006 ...	59 006 ...	59 006 ...
inch	inch	inch	inch	inch					
1	0.250	1 1/4	4	1	5	92013			
1	0.030	2	4 1/2	1	5		91220		
1	0.060	2	4 1/2	1	5		91320		
1	0.090	2	4 1/2	1	5		91420		
1	0.125	2	4 1/2	1	5		91520		
1	0.190	2	4 1/2	1	5		91620		
1	0.250	2	4 1/2	1	5		91720		
1	0.030	2 5/8	5	1	5			90426	
1	0.060	2 5/8	5	1	5			90526	
1	0.090	2 5/8	5	1	5			90626	
1	0.125	2 5/8	5	1	5			90726	
1	0.190	2 5/8	5	1	5			90826	
1	0.250	2 5/8	5	1	5			90926	
1	0.030	3 1/4	6	1	5				90933
1	0.060	3 1/4	6	1	5				91033
1	0.090	3 1/4	6	1	5				91133
1	0.125	3 1/4	6	1	5				91233
1	0.190	3 1/4	6	1	5				91333
1	0.250	3 1/4	6	1	5				91433
1	0.030	4 1/4	7	1	5				90643
1	0.060	4 1/4	7	1	5				90743
1	0.090	4 1/4	7	1	5				90843
1	0.125	4 1/4	7	1	5				90943
1	0.190	4 1/4	7	1	5				91043
1	0.250	4 1/4	7	1	5				91143

P	•	•	•	•
M	•	•	•	•
K	•	•	•	•
N				
S	•	•	•	•
H				
O				

→ v_c/f_z Page 113

End milling cutter

▲ Cutting edges with irregular pitch

P160
UN
 $\lambda_s=38^\circ$
 $\nu_s=10^\circ$
ZEFP
HPC

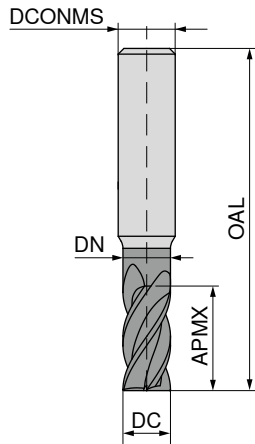
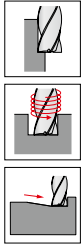

DC <small>+0.000/-0.002</small>	APMX	DN	LH	OAL	DCONMS <small>-0.0001 / -0.0004</small>	ZEFP
inch	inch	inch	inch	inch	inch	
1/4	3/4			2 1/2	1/4	7
3/8	7/8			2 1/2	3/8	7
3/8	1 1/4			3	3/8	7
3/8	1/2	0.360	3 1/8	6	3/8	7
1/2	1 1/4			3	1/2	7
1/2	1 5/8			4	1/2	7
1/2	5/8	0.480	3 1/8	6	1/2	7
5/8	1 5/8			3 1/2	5/8	7
5/8	2 1/8			4	5/8	7
5/8	3/4	0.600	3 1/8	6	5/8	7
3/4	1 5/8			4	3/4	7
3/4	2 1/4			5	3/4	7
3/4	1	0.720	3 1/8	6	3/4	7
1	2			4	1	7
1	2 5/8			5	1	7

59 057 ...	59 057 ...	59 057 ...
25030		
37523		
	37533	
		37513
50025		
	50033	
		50013
62526		
	62534	
		62512
75022		
	75030	
		75013
99920		
		99926

P	•	•	•
M	•	•	•
K	•	•	•
N	•	•	•
S	•	•	•
H			
O			

→ v_c/f_z Page 114

End milling cutter with corner radius

▲ Cutting edges with irregular pitch

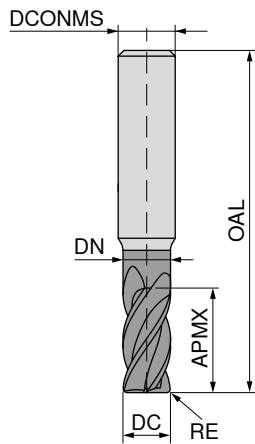
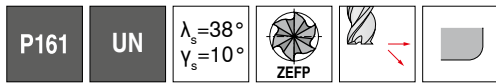

DC <small>+0.000/-0.002</small>	RE	APMX	DN	LH	OAL	DCONMS <small>-0.0001 / -0.0004</small>	ZEFP
inch	inch	inch	inch	inch	inch	inch	
1/4	0.020	3/4			2 1/2	1/4	7
1/4	0.030	3/4			2 1/2	1/4	7
1/4	0.020	1 1/8			3	1/4	7
1/4	0.030	3/8	0.240	2 1/2	4	1/4	7
1/4	0.020	3/8	0.240	2 1/2	4	1/4	7
3/8	0.020	7/8			2 1/2	3/8	7
3/8	0.030	7/8			2 1/2	3/8	7
3/8	0.030	1 1/4			3	3/8	7
3/8	0.020	1 1/4			3	3/8	7
3/8	0.020	1/2	0.360	3 1/8	6	3/8	7
1/2	0.020	1 1/4			3	1/2	7
1/2	0.030	1 1/4			3	1/2	7
1/2	0.030	1 5/8			4	1/2	7
1/2	0.020	1 5/8			4	1/2	7
1/2	0.030	5/8	0.480	3 1/8	6	1/2	7
1/2	0.020	5/8	0.480	3 1/8	6	1/2	7
5/8	0.030	1 5/8			3 1/2	5/8	7
5/8	0.030	2 1/8			4	5/8	7
5/8	0.030	3/4	0.600	3 1/8	6	5/8	7
3/4	0.030	1 5/8			4	3/4	7
3/4	0.030	2 1/4			5	3/4	7
3/4	0.030	1	0.720	3 1/8	6	3/4	7
1	0.030	2 5/8			5	1	7

59 058 ...	59 058 ...	59 058 ...
25030		
90030		
	25045	
		90015
		25015
37523		
90023		
	90033	
	37533	
		37513
50025		
90025		
	90133	
	50033	
		90013
		50013
62526		
	62534	
		62512
75022		
	75030	
		75013
	99926	

P	●	●	●
M	●	●	●
K	●	●	●
N	●	●	●
S	●	●	●
H			
O			

→ v_c/f_z Page 114

End milling cutter with corner radius

▲ with chip breaker

P119 **AL** $\lambda_s=40^\circ$ $\nu_s=15^\circ$ ZEFP

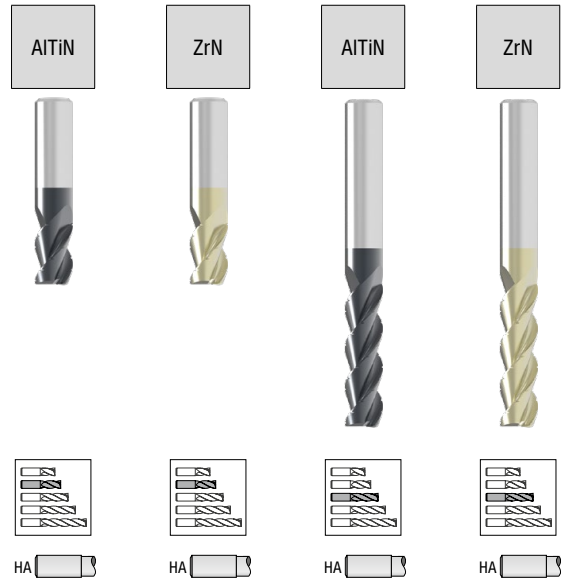
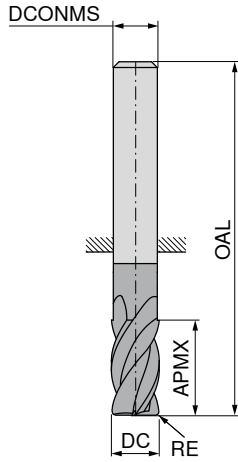
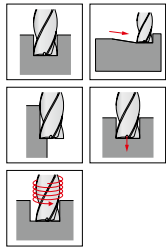

	59 029 ...	59 030 ...	59 029 ...	59 030 ...
12520	12520			
15624	15624			
18820	18820			
21917	21917			
25015	25015			
			25050	25050
28118	28118			
31316	31316			
34418	34418			
37517	37517			
			37540	37540
43823	43823			
50013	50013			
			50030	50030
62514	62514			
			62528	62528
75013	75013			
			75033	75033
			99928	99928

DC	RE	APMX	OAL	DCONMS	ZEFP
$+0.000/-0.002$	± 0.001			$-0.0001 / -0.0004$	
inch	inch	inch	inch	inch	
1/8	0.010	1/4	1 1/2	1/8	3
5/32	0.010	3/8	2	3/16	3
3/16	0.010	3/8	2	3/16	3
7/32	0.020	3/8	2	1/4	3
1/4	0.020	3/8	2	1/4	3
1/4	0.020	1 1/4	3	1/4	3
9/32	0.020	1/2	2 1/2	5/16	3
5/16	0.020	1/2	2 1/2	5/16	3
11/32	0.020	5/8	2	3/8	3
3/8	0.020	5/8	2	3/8	3
3/8	0.020	1 1/2	3 1/2	3/8	3
7/16	0.020	1	2 3/4	7/16	3
1/2	0.020	5/8	2 1/2	1/2	3
1/2	0.020	1 1/2	3 1/2	1/2	3
5/8	0.030	7/8	3	5/8	3
5/8	0.030	1 3/4	4	5/8	3
3/4	0.030	1	3	3/4	3
3/4	0.030	2 1/2	5	3/4	3
1	0.030	2 3/4	5	1	3

P	
M	
K	
N	•
S	•
H	
O	

→ v_c/f_z Page 115

End milling cutter with corner radius

▲ with chip breaker

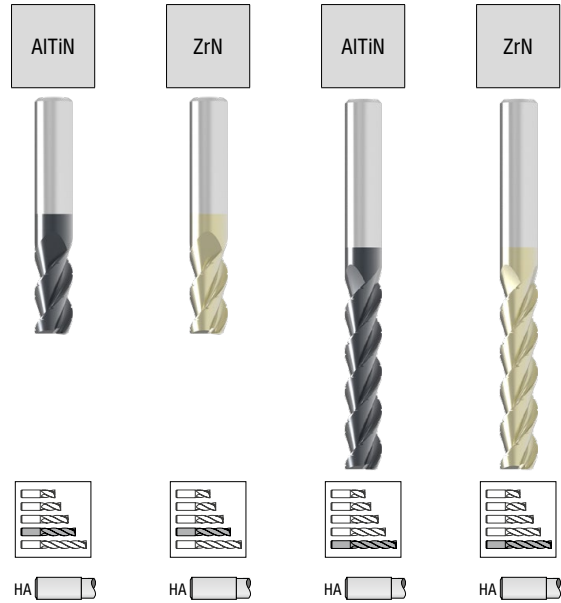
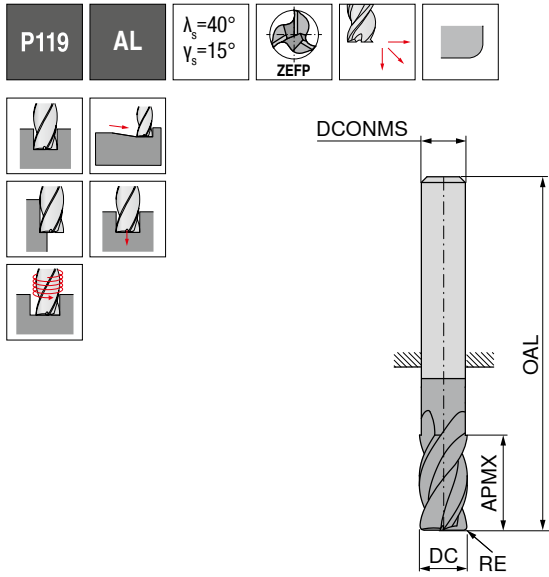

DC	RE	APMX	OAL	DCONMS	ZEFP	59 029 ...	59 030 ...	59 029 ...	59 030 ...
1/8	0.010	1/2	1 1/2	1/8	3	12540	12540		
5/32	0.010	1/2	2	3/16	3	15632	15632		
3/16	0.010	5/8	2	3/16	3	18833	18833		
7/32	0.020	3/4	2 1/2	1/4	3	21934	21934		
1/4	0.020	3/4	2 1/2	1/4	3	25030	25030		
1/4	0.020	1 1/2	3 1/2	1/4	3			25060	25060
9/32	0.020	3/4	2 1/2	5/16	3	28127	28127		
5/16	0.020	3/4	2 1/2	5/16	3	31324	31324		
11/32	0.020	7/8	2 1/2	3/8	3	34425	34425		
3/8	0.020	7/8	2 1/2	3/8	3	37523	37523		
3/8	0.020	2	4	3/8	3			37553	37553
1/2	0.020	1 1/4	3	1/2	3	50025	50025		
1/2	0.020	2	4	1/2	3			50040	50040
9/16	0.030	1 1/4	3 1/2	9/16	3	56322	56322		
5/8	0.030	1 1/4	3 1/2	5/8	3	62520	62520		
5/8	0.030	2 1/2	5	5/8	3			62540	62540
3/4	0.030	1 5/8	4	3/4	3	75022	75022		
3/4	0.030	3 1/4	6	3/4	3			75043	75043
1	0.030	1 3/4	4	1	3	99918	99918		
1	0.030	3 3/8	6	1	3			99934	99934

P	
M	
K	
N	•
S	
H	
O	

→ v_c/f_z Page 115

End milling cutter with corner radius

▲ with chip breaker

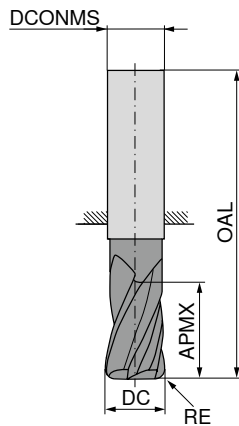
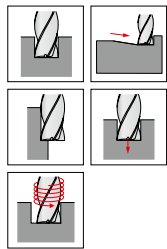
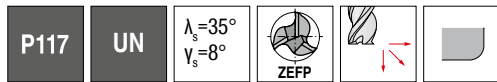

DC	RE	APMX	OAL	DCONMS	ZEFP
<small>+0.000/-0.002</small>	<small>±0.001</small>			<small>-0.0001 / -0.0004</small>	
inch	inch	inch	inch	inch	
1/8	0.010	1/2	1 1/2	1/8	3
3/16	0.010	5/16	2	3/16	3
3/16	0.010	5/8	2	3/16	3
1/4	0.020	3/8	2	1/4	3
1/4	0.020	3/4	2 1/2	1/4	3
5/16	0.020	13/16	2 1/2	5/16	3
3/8	0.020	1	2 1/2	3/8	3
7/16	0.020	5/8	2 3/4	7/16	3
7/16	0.020	1	2 3/4	7/16	3
1/2	0.020	5/8	2 1/2	1/2	3
1/2	0.020	1 1/4	3	1/2	3
5/8	0.030	1 1/4	3 1/2	5/8	3
3/4	0.030	1 5/8	4	3/4	3

59 028 ...	59 028 ...
12540	
18817	
	18833
25015	
	25030
31326	
37527	
43814	
	43823
50013	
	50025
	62520
	75022

P	●	●
M	●	●
K	●	●
N	●	●
S	●	●
H		
O		

→ v_c/f_z Page 116

End milling cutter with corner radius

▲ with chip breaker

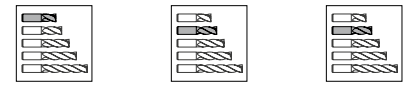
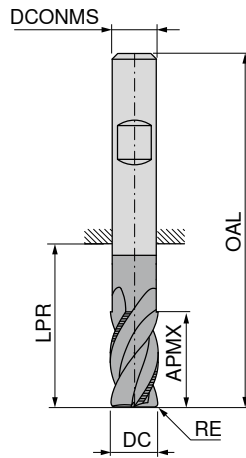
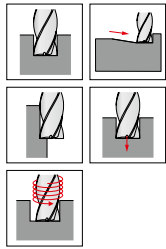
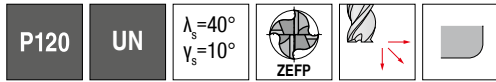

59 032 ...	59 031 ...	59 032 ...
	12520	
	15624	
	18820	
	21917	
	25015	
	28118	
	31316	
		34418
37517		37523
		43823
50013		50025
		62514
		75013

DC $_{+0.000/-0.002}$	RE $_{\pm 0.001}$	APMX	LPR	OAL	DCONMS $_{-0.0001/-0.0004}$	ZEFP
inch	inch	inch	inch	inch	inch	
1/8	0.010	1/4		1 1/2	1/8	4
5/32	0.010	3/8		2	3/16	4
3/16	0.010	3/8		2	3/16	4
7/32	0.020	3/8		2	1/4	4
1/4	0.020	3/8		2	1/4	4
9/32	0.020	1/2		2 1/2	5/16	4
5/16	0.020	1/2		2 1/2	5/16	4
11/32	0.020	5/8	0.825	2	3/8	4
3/8	0.020	5/8	0.825	2	3/8	4
3/8	0.020	7/8	0.960	2 1/2	3/8	4
7/16	0.020	1	1.165	2 3/4	7/16	4
1/2	0.020	5/8	0.735	2 1/2	1/2	4
1/2	0.020	1 1/4	1.235	3	1/2	4
5/8	0.030	7/8	1.113	3	5/8	4
3/4	0.030	1	1.228	3	3/4	4

P	•	•	•
M			
K	•	•	•
N			
S			
H			
O			

→ v_c/f_z Page 117

End milling cutter with corner radius

▲ with chip breaker

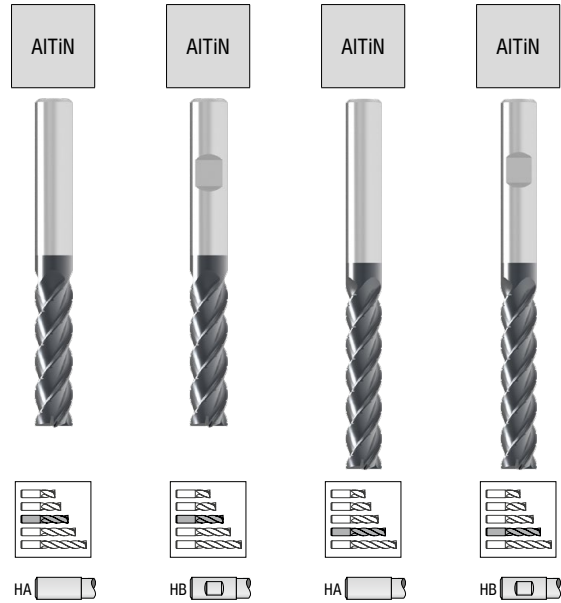
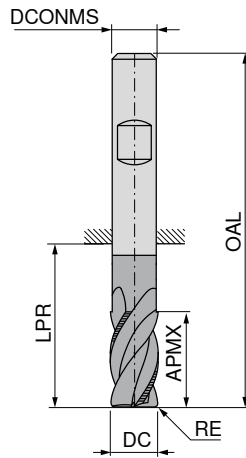
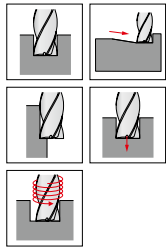
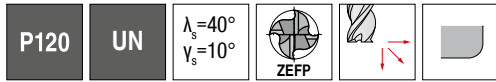

DC	RE	APMX	LPR	OAL	DCONMS	ZEFP	59 031 ...	59 032 ...	59 031 ...	59 032 ...
1/8	0.010	1/2		1 1/2	1/8	4			12540	
5/32	0.010	1/2		2	3/16	4			15632	
3/16	0.010	5/8		2	3/16	4			18833	
7/32	0.020	3/4		2 1/2	1/4	4			21934	
1/4	0.020	3/4		2 1/2	1/4	4				
1/4	0.020	1 1/4		3	1/4	4	25030		25050	
9/32	0.020	3/4		2 1/2	5/16	4			28127	
5/16	0.020	3/4		2 1/2	5/16	4			31324	
11/32	0.020	7/8	0.960	2 1/2	3/8	4				34425
3/8	0.020	1 1/2	1.960	3 1/2	3/8	4		37540		37553
3/8	0.020	2	2.460	4	3/8	4				
1/2	0.020	1 1/2	1.735	3 1/2	1/2	4				50040
1/2	0.020	2	2.235	4	1/2	4		50030		56322
9/16	0.030	1 1/4	1.675	3 1/2	9/16	4				
5/8	0.030	1 1/4	1.613	3 1/2	5/8	4		62520		62528
5/8	0.030	1 3/4	2.113	4	5/8	4				75022
3/4	0.030	1 5/8	1.978	4	3/4	4				

P	•	•	•	•
M	•	•	•	•
K	•	•	•	•
N	•	•	•	•
S	•	•	•	•
H	•	•	•	•
O	•	•	•	•

→ v_c/f_z Page 117

End milling cutter with corner radius

▲ with chip breaker

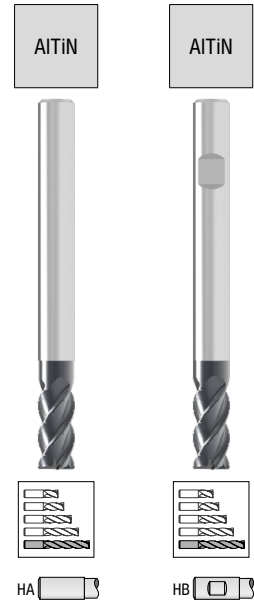
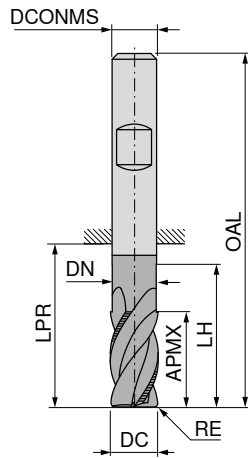
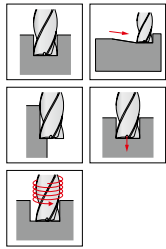
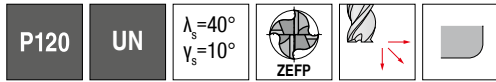

59 031 ...	59 032 ...
25130	
25060	
37523	
37623	
50020	
50120	
	62540
75022	
	99918



DC <small>+0.000/-0.002</small>	RE <small>±0.001</small>	APMX	DN	LH	LPR	OAL	DCONMS <small>-0.0001 / -0.0004</small>	ZEFP
inch	inch	inch	inch	inch	inch	inch	inch	
1/4	0.020	3/4	0.240	2 1/8		4	1/4	4
1/4	0.020	1 1/2				3 1/2	1/4	4
3/8	0.020	7/8	0.360	2 1/8		4	3/8	4
3/8	0.020	7/8	0.360	3 3/8		6	3/8	4
1/2	0.020	1	0.480	2 3/8		6	1/2	4
1/2	0.020	1	0.480	3 3/8		6	1/2	4
5/8	0.030	2 1/2			3.1	5	5/8	4
3/4	0.030	1 5/8	0.720	2 1/2		6	3/4	4
1	0.030	1 3/4			1.7	4	1	4

P	●	●
M		
K	●	●
N		
S		
H		
O		

→ v_c/f_z Page 117

End milling cutter with corner radius

▲ with chip breaker

P121
UN
 $\lambda_s=40^\circ$
 $\nu_s=10^\circ$
ZEPF

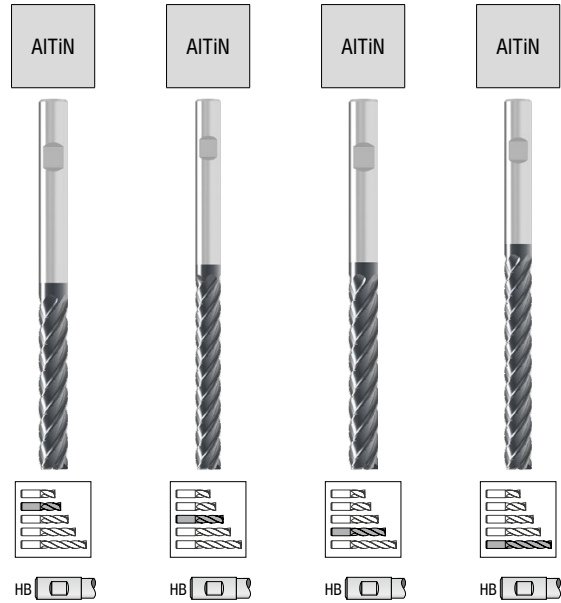
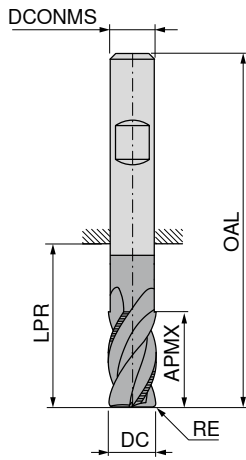
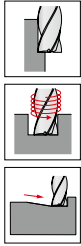



DC <small>+0.000/-0.002</small>	RE <small>±0.001</small>	APMX	LPR	OAL	DCONMS <small>-0.0001 / -0.0004</small>	ZEPF
inch	inch	inch	inch	inch	inch	
3/4	0.030	2 1/2	2.9	5	3/4	5
3/4	0.030	3 1/4	3.9	6	3/4	5
1	0.030	2 3/4	2.7	5	1	5
1	0.030	3 3/8	3.7	6	1	5

59 035 ...	59 035 ...	59 035 ...	59 035 ...
75033	75043	99928	99934

P	•	•	•	•
M	•	•	•	•
K	•	•	•	•
N	•	•	•	•
S	•	•	•	•
H				
O				

→ v_c/f_z Page 118

End milling cutter with corner radius

- ▲ with coarse pitch profile
- ▲ Radius accuracy: +/- 0.001

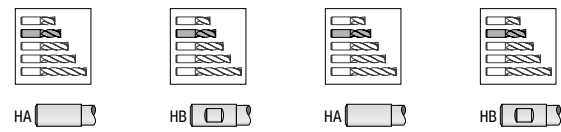
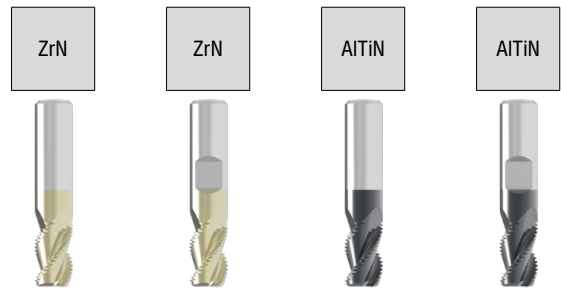
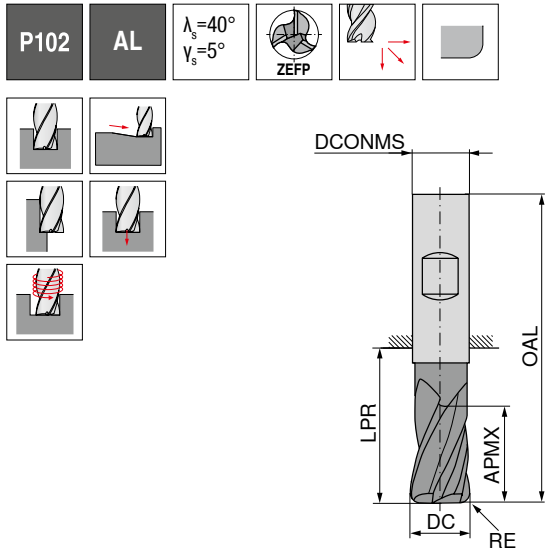

59 023 ...	59 024 ...	59 025 ...	59 026 ...
18820		18820	
25015		25015	
31316		31316	
	37517		37517
	43823		43823
	50013		50013

DC	RE	APMX	LPR	OAL	DCONMS	ZEPF
inch	inch	inch	inch	inch	inch	
3/16	0.030	3/8		2	3/16	3
1/4	0.045	3/8		2	1/4	3
5/16	0.045	1/2		2	5/16	3
3/8	0.060	5/8	0.825	2	3/8	3
7/16	0.060	1	1.165	2 3/4	7/16	3
1/2	0.060	5/8	0.735	2 1/2	1/2	3

P						
M						
K						
N						
S						
H						
O						

→ v_c/f_z Page 119

End milling cutter with corner radius

- ▲ with coarse pitch profile
- ▲ Radius accuracy: +/- 0.001

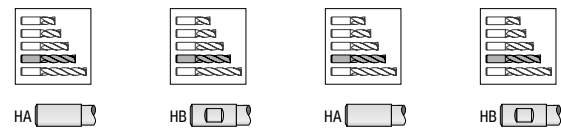
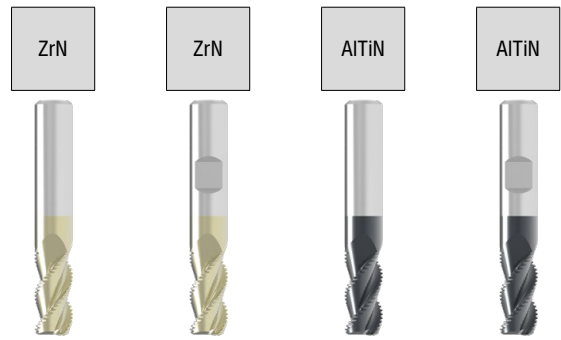
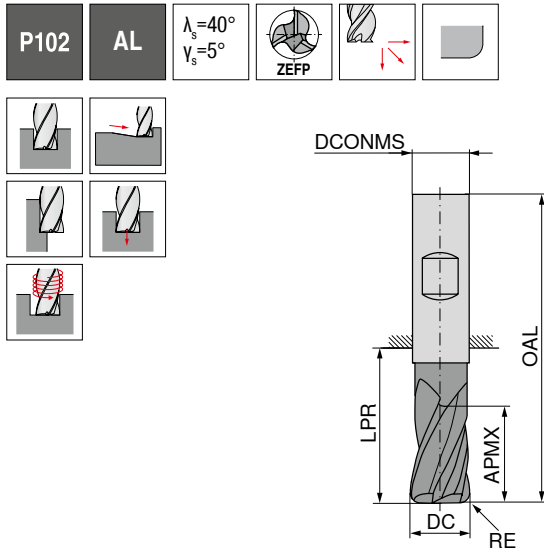

59 023 ...	59 024 ...	59 025 ...	59 026 ...
18833		18833	
25030		25030	
31324		31324	
	37523		37523
	50025		50025
	56322		56322
	62520		62520
	75022		75022
	99918		99918

DC	RE	APMX	LPR	OAL	DCONMS	ZEPF
inch	inch	inch	inch	inch	inch	
3/16	0.030	5/8		2	3/16	3
1/4	0.045	3/4		2 1/2	1/4	3
5/16	0.045	3/4		2 1/2	5/16	3
3/8	0.060	7/8	0.960	2 1/2	3/8	3
1/2	0.060	1 1/4	1.235	3	1/2	3
9/16	0.060	1 1/4	1.675	3 1/2	9/16	3
5/8	0.060	1 1/4	1.613	3 1/2	5/8	3
3/4	0.060	1 5/8	1.978	4	3/4	3
1	0.060	1 3/4	1.733	4	1	3

P				
M				
K				
N				
S				
H				
O				

→ v_c/f_z Page 119

End milling cutter with corner radius

- ▲ with coarse pitch profile
- ▲ Radius accuracy: +/- 0.001

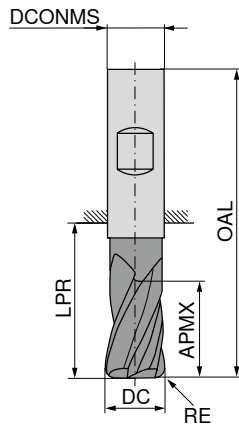
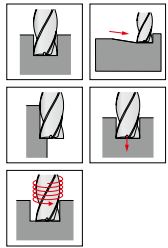
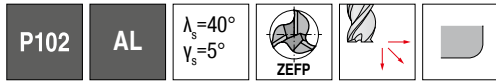

DC	RE	APMX	LPR	OAL	DCONMS	ZEFP
<small>+0.000/-0.002</small>	<small>-/+0.001</small>				<small>-0.0001 / -0.0004</small>	
inch	inch	inch	inch	inch	inch	
1/2	0.060	1 1/2	1.735	3 1/2	1/2	3
3/4	0.060	2 1/4	2.978	5	3/4	3
1	0.060	2 5/8	2.733	5	1	3



59 024 ...	59 026 ...
50030	50030
75030	75030
99926	99926

P	
M	
K	
N	●
S	●
H	
O	

→ v_c/f_z Page 119

End milling cutter

▲ with chip breaker

P190 **UN** $\lambda_s=40^\circ$ $\nu_s=10^\circ$   

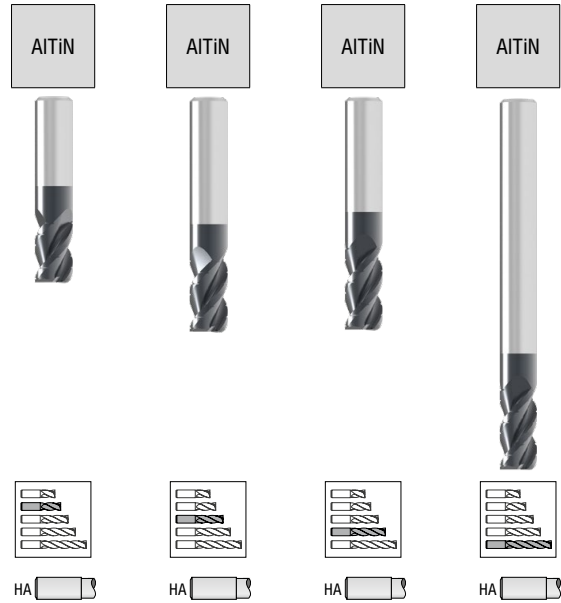
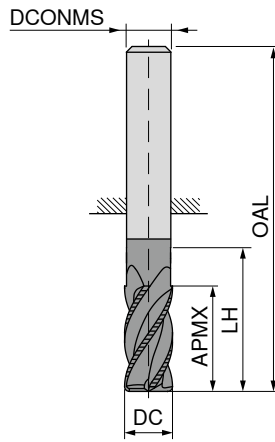
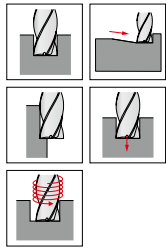

DC	APMX	LH	OAL	DCONMS	ZEFP	59 059 ...	59 059 ...	59 059 ...	59 059 ...
<small>+0.000/-0.002</small>	<small>inch</small>	<small>inch</small>	<small>inch</small>	<small>inch</small>	<small>-0.0001 / -0.0004</small>				
3/16	5/8		2	3/16	4	18833			
1/4	3/8		2	1/4	4	25015			
1/4	3/4		2 1/2	1/4	4			25030	
5/16	3/4		2 1/2	5/16	4	31324			
3/8	5/8		2	3/8	4	37517			
3/8	7/8		2 1/2	3/8	4			37523	
3/8	7/8	2.125	4	3/8	4				37623
1/2	5/8		2 1/2	1/2	4	50013			
1/2	1	2.375	6	1/2	4				50020
1/2	1 1/4		3	1/2	4			50025	
1/2	2		4	1/2	4		50040		
5/8	7/8		3	5/8	4	62514			
5/8	1 1/4		3 1/2	5/8	4			62520	
3/4	1		3	3/4	4	75013			
3/4	1 5/8		4	3/4	4			75022	
1	1 3/4		4	1	4			99918	

P	•	•	•	•
M				
K	•	•	•	•
N				
S				
H				
O				

→ v_c/f_z Page 120

End milling cutter with corner radius

▲ with chip breaker

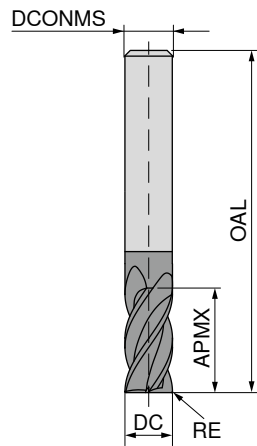
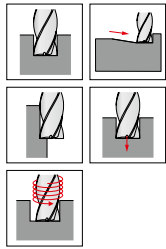
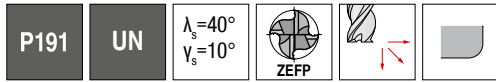

59 061 ...	59 061 ...	59 061 ...
18833		
25030		
31324		
37523		
90023		
90013		
50013		
	90025	
	50025	
		90040
		50040
	62520	
	75022	
	99918	



DC	RE	APMX	OAL	DCONMS	ZEFP
<small>+0.000/-0.002</small>	<small>-/-0.001</small>			<small>-0.0001 / -0.0004</small>	
inch	inch	inch	inch	inch	
3/16	0.010	5/8	2	3/16	4
1/4	0.020	3/4	2 1/2	1/4	4
5/16	0.020	3/4	2 1/2	5/16	4
3/8	0.020	7/8	2 1/2	3/8	4
3/8	0.030	7/8	2 1/2	3/8	4
1/2	0.030	5/8	2 1/2	1/2	4
1/2	0.020	5/8	2 1/2	1/2	4
1/2	0.030	1 1/4	3	1/2	4
1/2	0.020	1 1/4	3	1/2	4
1/2	0.030	2	4	1/2	4
1/2	0.020	2	4	1/2	4
5/8	0.030	1 1/4	3 1/2	5/8	4
3/4	0.030	1 5/8	4	3/4	4
1	0.030	1 3/4	4	1	4

P	•	•	•
M			
K	•	•	•
N			
S			
H			
O			

→ v_c/f_z Page 120

End milling cutter with corner radius

- ▲ with coarse pitch profile
- ▲ Radius accuracy: +/- 0.001

P100 **UN** $\lambda_s=30^\circ$ $\nu_s=5^\circ$   

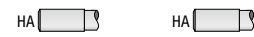
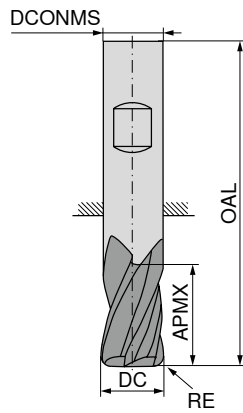
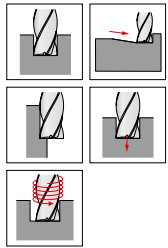

59 011 ...	59 011 ...
18820	18833

DC	RE	APMX	OAL	DCONMS	ZEFP
$+0.000/-0.002$	$+/-0.001/+/-0.001$	inch	inch	$-0.0001 / -0.0004$	
inch	inch	inch	inch	inch	
3/16	0.030	3/8	2	3/16	3
3/16	0.030	5/8	2	3/16	3

P	•	•
M		
K	•	•
N		
S		
H		
O		

→ v_c/f_z Page 121

End milling cutter with corner radius

- ▲ with coarse pitch profile
- ▲ Radius accuracy: +/- 0.001

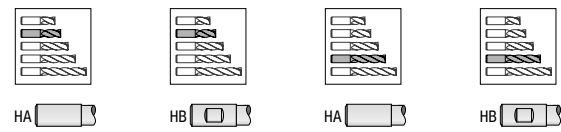
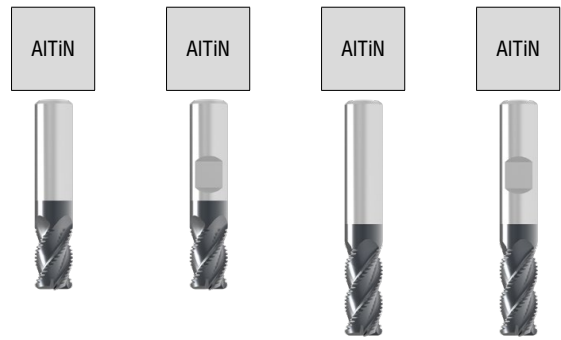
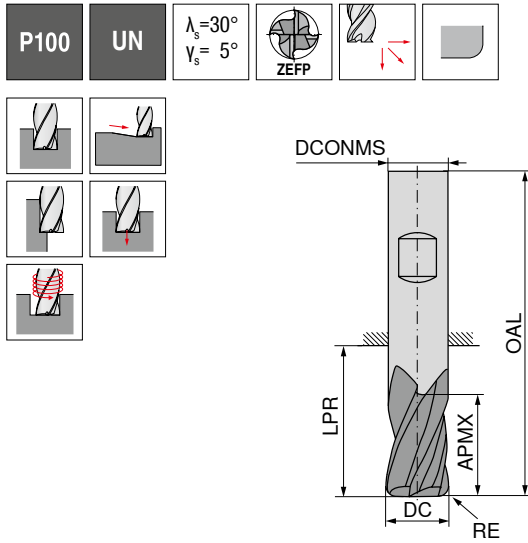

DC	RE	APMX	LPR	OAL	DCONMS	ZEFP
inch	inch	inch	inch	inch	inch	
1/4	0.045	3/8		2	1/4	4
1/4	0.045	3/4		2 1/2	1/4	4
5/16	0.045	1/2		2 1/2	5/16	4
5/16	0.045	3/4		2 1/2	5/16	4
3/8	0.060	5/8	0.8	2	3/8	4
3/8	0.060	7/8	0.9	2 1/2	3/8	4
7/16	0.060	1	1.1	2 3/4	7/16	4
1/2	0.060	5/8	0.7	2 1/2	1/2	4
1/2	0.060	1 1/4	1.2	3	1/2	4
9/16	0.060	1 1/4	1.6	3 1/2	9/16	4
5/8	0.060	7/8	1.1	3	5/8	4
5/8	0.060	1 1/4	1.6	3 1/2	5/8	4
3/4	0.060	1	1.2	3	3/4	4
3/4	0.060	1 5/8	1.9	4	3/4	4

59 012 ...	59 013 ...	59 012 ...	59 013 ...
25015		25030	
31316		31324	
	37517		37523
	43823		
	50013		50025
			56322
	62514		62520
	75013		75022

P	•	•	•	•
M				
K	•	•	•	•
N				
S				
H				
O				

→ v_c/f_z Page 121

End milling cutter with corner radius

- ▲ with coarse pitch profile
- ▲ Radius accuracy: +/- 0.001

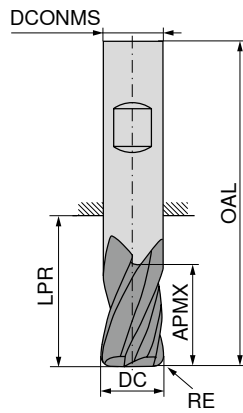
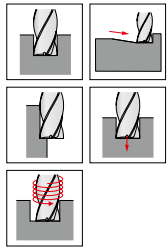
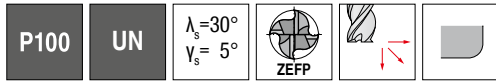

AITIN



HB

59 013 ...



DC +0.000/-0.002 inch	RE +/-0.001 inch	APMX inch	LPR inch	OAL inch	DCONMS -0.0001/-0.0004 inch	ZEFP	
1/2	0.060	1 1/2	1.735	3 1/2	1/2	4	50030
5/8	0.060	2	2.113	4	5/8	4	62532
3/4	0.060	2 1/4	2.978	5	3/4	4	75030

P	•
M	
K	•
N	
S	
H	
O	

→ v_c/f_z Page 121

End milling cutter with corner radius

- ▲ with coarse pitch profile
- ▲ Radius accuracy: +/- 0.001

P100 **UN** $\lambda_s=30^\circ$ $\nu_s=5^\circ$   

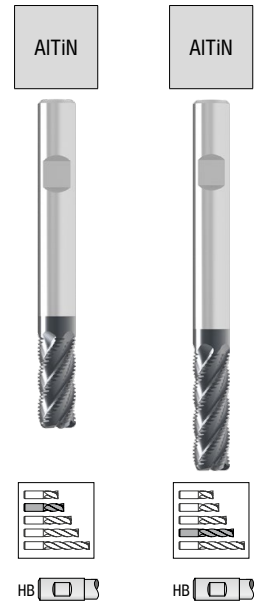
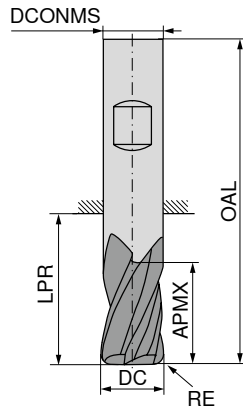
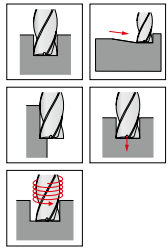

DC <small>+0.000/-0.002</small>	RE <small>+/-0.001</small>	APMX	LPR	OAL	DCONMS <small>-0.0001/-0.0004</small>	ZEFP
inch	inch	inch	inch	inch	inch	
1	0.060	1 3/4	1.733	4	1	5
1	0.060	2 5/8	2.733	5	1	5

	59 014 ...	59 014 ...
P	●	●
M		
K	●	●
N		
S		
H		
O		

DC	RE	APMX	LPR	OAL	DCONMS	ZEFP	59 014 ...	59 014 ...
1	0.060	1 3/4	1.733	4	1	5	99918	
1	0.060	2 5/8	2.733	5	1	5		99926

→ v_c/f_z Page 121

End milling cutter with corner radius

- ▲ with fine pitch profile
- ▲ Radius accuracy: +/- 0.001

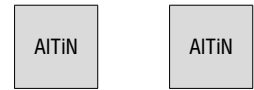
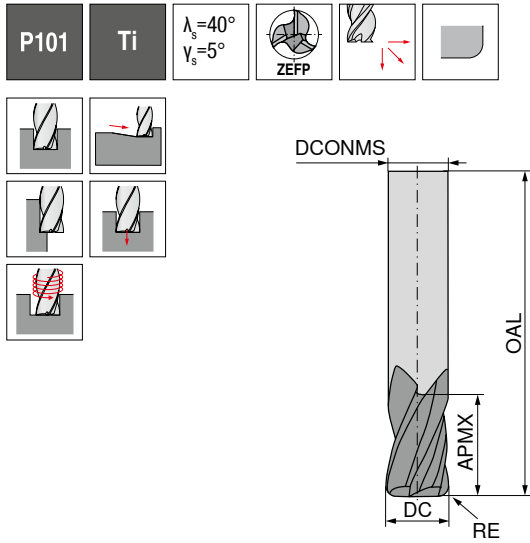

DC	RE	APMX	OAL	DCONMS	ZEFP
<small>+0.000/-0.002</small>	<small>+/-0.001</small>			<small>-0.0001 / -0.0004</small>	
inch	inch	inch	inch	inch	
3/16	0.030	3/8	2	3/16	3
3/16	0.030	5/8	2	3/16	3

	59 015 ...	59 015 ...
P	•	•
M		
K	•	•
N		
S		
H		
O		

DC	RE	APMX	OAL	DCONMS	ZEFP
<small>+0.000/-0.002</small>	<small>+/-0.001</small>			<small>-0.0001 / -0.0004</small>	
inch	inch	inch	inch	inch	
3/16	0.030	3/8	2	3/16	3
3/16	0.030	5/8	2	3/16	3

→ v_c/f_z Page 122

End milling cutter with corner radius

- ▲ with fine pitch profile
- ▲ Radius accuracy: +/- 0.001

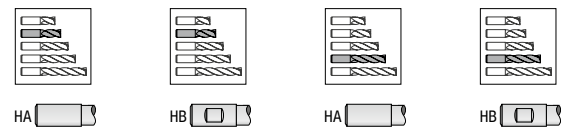
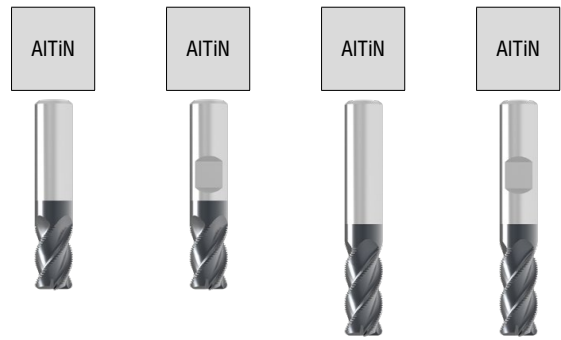
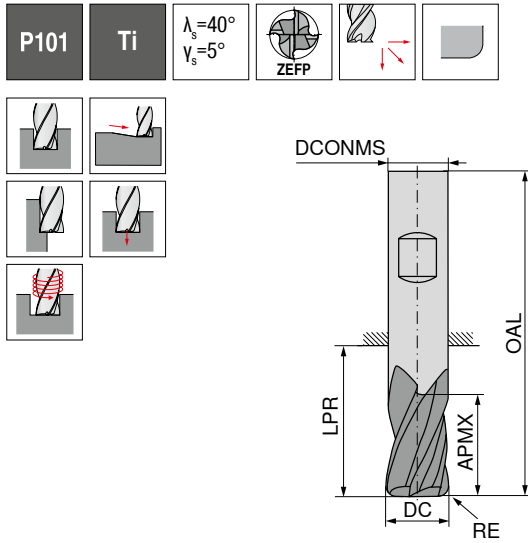

DC	RE	APMX	LPR	OAL	DCONMS	ZEFP
inch	inch	inch	inch	inch	inch	
1/4	0.045	3/8		2	1/4	4
1/4	0.045	3/4		2 1/2	1/4	4
5/16	0.045	1/2		2 1/2	5/16	4
5/16	0.045	3/4		2 1/2	5/16	4
3/8	0.060	5/8	0.825	2	3/8	4
3/8	0.060	7/8	0.960	2 1/2	3/8	4
7/16	0.060	1	1.165	2 3/4	7/16	4
1/2	0.060	5/8	0.735	2 1/2	1/2	4
1/2	0.060	1 1/4	1.235	3	1/2	4
9/16	0.060	1 1/4	1.675	3 1/2	9/16	4
5/8	0.060	7/8	1.113	3	5/8	4
5/8	0.060	1 1/4	1.613	3 1/2	5/8	4
3/4	0.060	1	1.228	3	3/4	4
3/4	0.060	1 5/8	1.978	4	3/4	4

59 016 ...	59 017 ...	59 016 ...	59 017 ...
25015			
31316		25030	
		31324	
	37517		37523
	43823		
	50013		50025
			56322
	62514		62520
	75013		75022

P	•	•	•	•
M				
K	•	•	•	•
N				
S				
H				
O				

→ v_c/f_z Page 122

End milling cutter with corner radius

- ▲ with fine pitch profile
- ▲ Radius accuracy: +/- 0.001

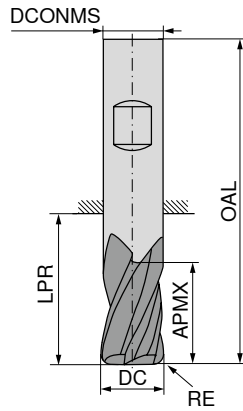
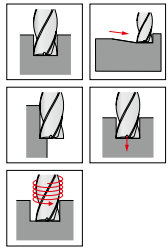
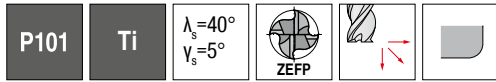

AITIN



HB

59 017 ...



DC <small>+0.000/-0.002</small>	RE <small>+/-0.001</small>	APMX	LPR	OAL	DCONMS <small>-0.0001/-0.0004</small>	ZEFP	
inch	inch	inch	inch	inch	inch		
1/2	0.060	1 1/2	1.735	3 1/2	1/2	4	50030
5/8	0.060	2	2.113	4	5/8	4	62532
3/4	0.060	2 1/4	2.978	5	3/4	4	75030

P	•
M	
K	•
N	
S	
H	
O	

→ v_c/f_z Page 122

End milling cutter with corner radius

- ▲ with fine pitch profile
- ▲ Radius accuracy: +/- 0.001

P101 **Ti** $\lambda_s=40^\circ$ $\gamma_s=5^\circ$   

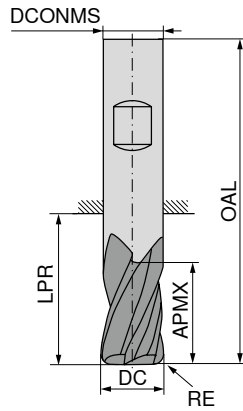
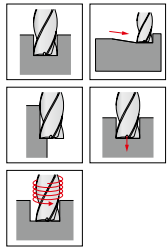

DC <small>+0.000/-0.002</small> inch	RE <small>+/-0.001</small> inch	APMX inch	LPR inch	OAL inch	DCONMS <small>-0.0001/-0.0004</small> inch	ZEFP
1	0.060	1 3/4	1.733	4	1	5
1	0.060	2 5/8	2.733	5	1	5

59 022 ...	59 022 ...
99918	99926

P	•	•
M		
K	•	•
N		
S		
H		
O		

→ v_c/f_z Page 122

Ball Nosed Cutter

- ▲ DC tolerance:
 ≤ Ø 7/64 inch: +/- 0.0005
 ≥ Ø 1/8 inch: 0 /- 0.002
- ▲ Radius accuracy: +/- 0.001

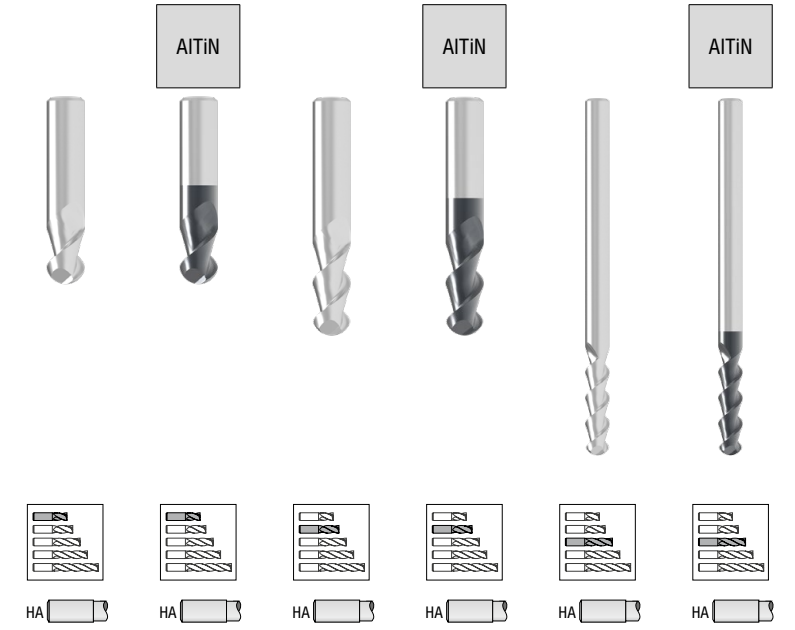
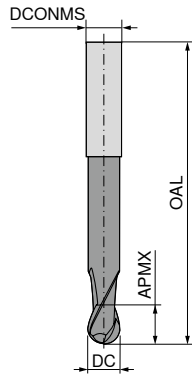
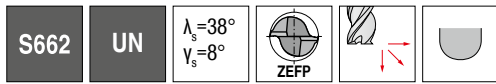







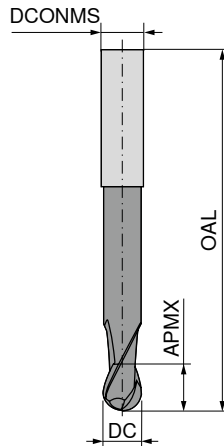
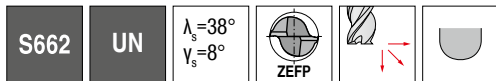

DC inch	APMX inch	OAL inch	DCONMS _{-0.0001/-0.0004} inch	ZEFP	59 076 ...	59 077 ...	59 076 ...	59 077 ...	59 076 ...	59 077 ...
1/16	1/8	1 1/2	1/8	2			06320	06320		
1/8	1/4	1 1/2	1/8	2	12520	12520				
1/8	1/2	1 1/2	1/8	2			12540	12540		
1/8	3/4	3	1/8	2					12660	12660
3/16	3/8	2	3/16	2	18820	18820	18833	18833	18853	18853
3/16	5/8	2	3/16	2						
3/16	1	4	3/16	2						
1/4	3/8	2	1/4	2	25015	25015	25030	25030	25045	25045
1/4	3/4	2 1/2	1/4	2						
1/4	1 1/8	3	1/4	2						
5/16	1/2	2	5/16	2	31316	31316			31336	31336
5/16	3/4	2 1/2	5/16	2			31324	31324		
5/16	1 1/8	3	5/16	2						
3/8	5/8	2	3/8	2	37517	37517	37523	37523	37540	37540
3/8	7/8	2 1/2	3/8	2						
3/8	1 1/2	6	3/8	2						
1/2	5/8	2 1/2	1/2	2	50013	50013	50020	50020	50030	50030
1/2	1	3	1/2	2						
1/2	1 1/2	6	1/2	2						
5/8	7/8	3	5/8	2	62514	62514			62534	62534
5/8	1 1/4	3 1/2	5/8	2			62520	62520		
5/8	2 1/8	4 5/8	5/8	2						
3/4	1	3	3/4	2	75013	75013				
3/4	1 1/2	4	3/4	2			75020	75020	75030	75030
3/4	2 1/4	5	3/4	2					99920	99920
1	2	6	1	2						
1	2 1/4	5	1	2			99923	99923		
P					•	•	•	•	•	•
M					•	•	•	•	•	•
K					•	•	•	•	•	•
N					•	•	•	•	•	•
S					•	•	•	•	•	•
H										
O										

→ v_c/f_z Page 123

Ball Nosed Cutter

- ▲ DC tolerance:
 ≤ ∅ 7/64 inch: +/- 0.0005
 ≥ ∅ 1/8 inch: 0 /- 0.002
- ▲ Radius accuracy: +/- 0.001





	AITiN		AITiN
			
			
59 076 ...	59 077 ...	59 076 ...	59 077 ...
06330	06330		
12560	12560		
		12580	12580
18840	18840		
		18860	18860
25040	25040		
		25060	25060
		25160	25160
31332	31332		
		31348	31348
		31352	31352
37527	37527		
37530	37530		
		37547	37547
		37580	37580
50120	50120		
		50040	50040
		50060	50060
62532	62532		
		62548	62548
75027	75027		
		75040	75040
99918	99918		
		99930	99930

DC inch	APMX inch	OAL inch	DCONMS inch	ZEFP
1/16	3/16	1 1/2	1/8	2
1/8	3/4	2 1/2	1/8	2
1/8	1	3	1/8	2
3/16	3/4	2 1/2	3/16	2
3/16	1 1/8	3	3/16	2
1/4	1	4	1/4	2
1/4	1 1/2	4	1/4	2
1/4	1 1/2	6	1/4	2
5/16	1	4	5/16	2
5/16	1 1/2	6	5/16	2
5/16	1 5/8	4	5/16	2
3/8	1	4	3/8	2
3/8	1 1/8	3	3/8	2
3/8	1 3/4	4	3/8	2
3/8	3	6	3/8	2
1/2	1	4	1/2	2
1/2	2	4	1/2	2
1/2	3	6	1/2	2
5/8	2	6	5/8	2
5/8	3	6	5/8	2
3/4	2	6	3/4	2
3/4	3	6	3/4	2
1	1 3/4	4	1	2
1	3	6	1	2

P	●	●	●	●
M	●	●	●	●
K	●	●	●	●
N	●	●	●	●
S	●	●	●	●
H				
O				

Ball Nosed Cutter

▲ Radius accuracy: +/- 0.001

S663 **UN** $\lambda_s=38^\circ$
 $\nu_s=8^\circ$   

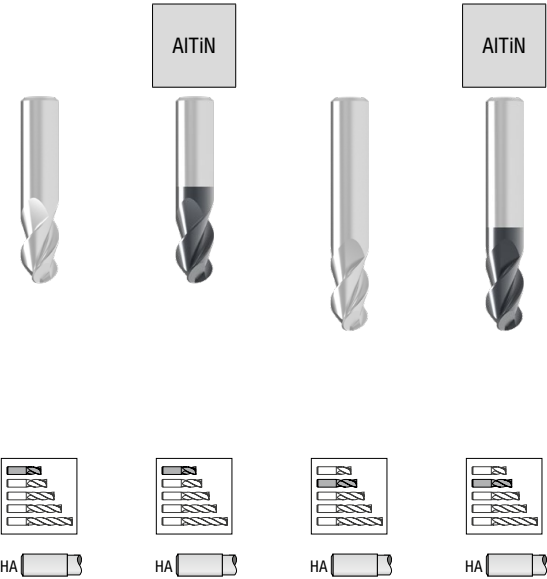
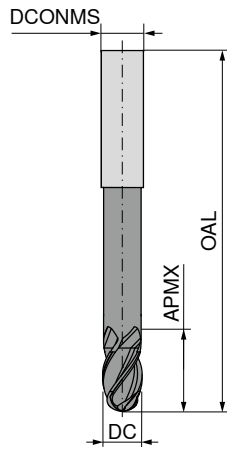

DC $+0.000/-0.002$ inch	APMX inch	OAL inch	DCONMS $-0.0001 / -0.0004$ inch	ZEFP
1/8	1/4	1 1/2	1/8	3
1/8	1/2	1 1/2	1/8	3
3/16	3/8	2	3/16	3
3/16	5/8	2	3/16	3
1/4	3/8	2	1/4	3
1/4	3/4	2 1/2	1/4	3
5/16	3/4	2 1/2	5/16	3
3/8	5/8	2	3/8	3
3/8	7/8	2 1/2	3/8	3
1/2	5/8	2 1/2	1/2	3
1/2	1	3	1/2	3
5/8	1 1/4	3 1/2	5/8	3
3/4	1 1/2	4	3/4	3
1	1 3/4	4	1	3

59 078 ...	59 079 ...	59 078 ...	59 079 ...
12520	12520	12540	12540
18820	18820	18833	18833
25015	25015	25030	25030
		31324	31324
37517	37517	37523	37523
50013	50013	50020	50020
		62520	62520
		75020	75020
		99918	99918



P	•	•	•	•
M	•	•	•	•
K	•	•	•	•
N	•	•	•	•
S	•	•	•	•
H				
O				

→ v_c/f_z Page 124

Ball Nosed Cutter

▲ Radius accuracy: +/- 0.001

S663 **UN** $\lambda_s=38^\circ$
 $\nu_s=8^\circ$

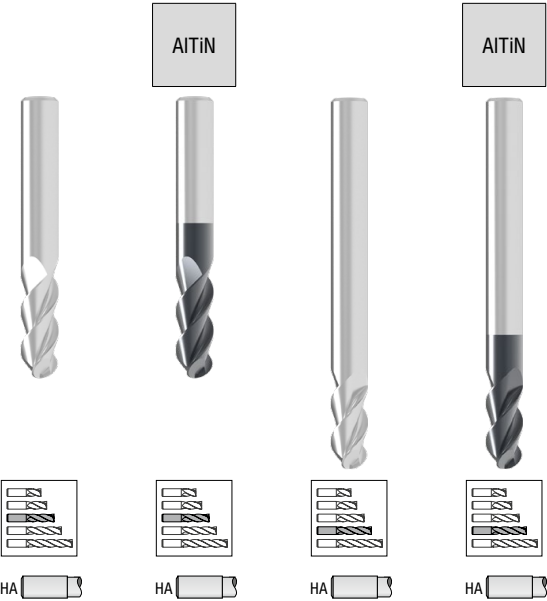
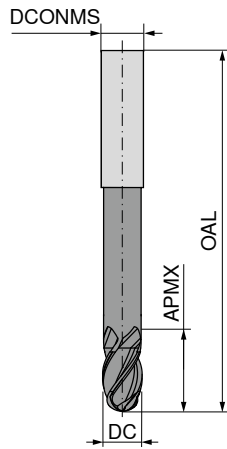
DC	APMX	OAL	DCONMS	ZEPF	59 078 ...	59 079 ...	59 078 ...	59 079 ...
<small>+0.000/-0.002</small>			<small>-0.0001 / -0.0004</small>					
inch	inch	inch	inch					
1/8	3/4	2 1/2	1/8	3			12560	12560
1/8	3/4	3	1/8	3	12660	12660		
3/16	1	2 1/2	3/16	3	18853	18853		
3/16	3/4	2 1/2	3/16	3			18840	18840
1/4	1 1/8	3	1/4	3			25045	25045
1/4	1	4	1/4	3	25040	25040		
5/16	1	4	5/16	3			31332	31332
3/8	1 1/8	3	3/8	3	37530	37530		
3/8	1	4	3/8	3			37527	37527
3/8	1 1/2	6	3/8	3	37540	37540		
1/2	1	4	1/2	3			50120	50120
1/2	1 1/2	6	1/2	3	50030	50030		
5/8	2 1/8	4 5/8	5/8	3	62534	62534		
5/8	2	6	5/8	3			62532	62532
3/4	2 1/4	5	3/4	3	75030	75030		
3/4	2	6	3/4	3			75027	75027
1	2 1/4	5	1	3	99923	99923		
1	2	6	1	3			99920	99920

P	●	●	●	●
M	●	●	●	●
K	●	●	●	●
N	●	●	●	●
S	●	●	●	●
H				
O				

→ v_c/f_z Page 124

Ball Nosed Cutter

▲ Radius accuracy: +/- 0.001

S663 **UN** $\Lambda_s=38^\circ$ $V_s=8^\circ$ ZEPF

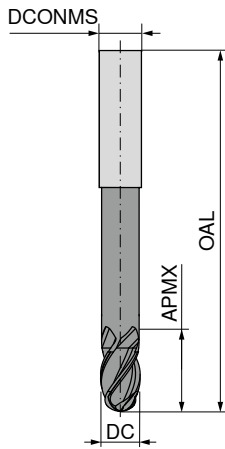

AITiN



HA

HA

DC <small>+0.000/-0.002</small>	APMX	OAL	DCONMS <small>-0.0001 / -0.0004</small>	ZEPF
inch	inch	inch	inch	
1/8	1	3	1/8	3
3/16	1 1/8	3	3/16	3
3/16	1	4	3/16	3
1/4	1 1/2	4	1/4	3
1/4	1 1/2	6	1/4	3
5/16	1 1/2	6	5/16	3
3/8	1 3/4	4	3/8	3
3/8	3	6	3/8	3
1/2	2	4	1/2	3
1/2	3	6	1/2	3
5/8	3	6	5/8	3
3/4	3	6	3/4	3
1	3	6	1	3

59 078 ...

59 079 ...

	12580	12580
	18860	18860
	18953	18953
	25060	25060
	25160	25160
	31348	31348
	37547	37547
	37580	37580
	50040	50040
	50060	50060
	62548	62548
	75040	75040
	99930	99930

P	●	●
M	●	●
K	●	●
N	●	●
S	●	●
H		
O		

→ v_c/f_z Page 124

Ball Nosed Cutter

- ▲ Cutting edges with irregular pitch
- ▲ Radius accuracy: +/- 0.001"

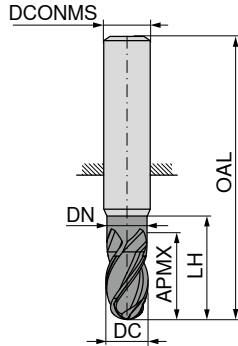
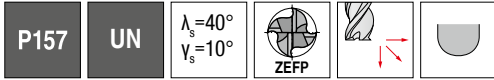

DC +0.000/-0.002 inch	APMX inch	DN inch	LH inch	OAL inch	DCONMS -0.0001 / -0.0004 inch	ZEFP
1/8	1/4			1 1/2	1/8	4
1/8	1/2			1 1/2	1/8	4
5/32	1/2			2	3/16	4
3/16	3/8			2	3/16	4
3/16	5/8			2	3/16	4
7/32	3/8			2	1/4	4
7/32	3/4			2 1/2	1/4	4
1/4	3/8			2	1/4	4
1/4	3/4			2 1/2	1/4	4
1/4	3/4	0.240	2 1/8	4	1/4	4
5/16	3/4			2 1/2	5/16	4
5/16	1/2			2 1/2	5/16	4
3/8	5/8			2	3/8	4
3/8	7/8			2 1/2	3/8	4
3/8	7/8	0.360	2 3/8	4	3/8	4
1/2	5/8			2 1/2	1/2	4
1/2	1			3	1/2	4
1/2	1	0.480	2 3/8	6	1/2	4
1/2	1	0.480	3 3/8	6	1/2	4
9/16	1 1/4			3 1/2	9/16	4
5/8	1 1/4			3 1/2	5/8	4
5/8	1 1/4	0.600	3 3/8	6	5/8	4
3/4	1 5/8			4	3/4	4
1	1 3/4			4	1	4
1	2 3/4			5	1	4
1	1 7/8	0.960	3 3/8	6	1	4

59 055 ...	59 055 ...	59 055 ...	59 055 ...
12520			
		12540	
15632			
18820			18833
		21934	
21917			
		25015	
			25030
			31324
31316			
37517			37523
			37623
50013			
		50020	
	50120		
			50220
		56322	
		62520	
			62620
		75022	
		99918	
	99928		
			99919

P	•	•	•	•
M	•	•	•	•
K	•	•	•	•
N	•	•	•	•
S				
H				
O				

→ v_c/f_z Page 128

Ball Nosed Cutter

- ▲ DC tolerance:
 ≤ Ø 7/64 inch: +/- 0.0005
 ≥ Ø 1/8 inch: 0 / - 0.002
- ▲ Radius accuracy: +/- 0.001

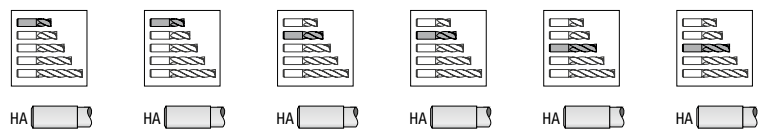
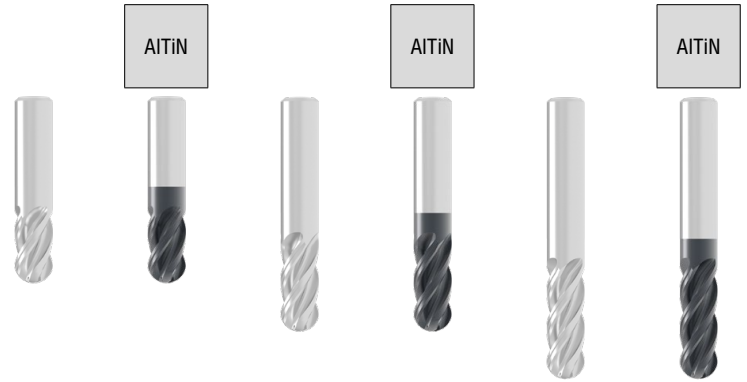
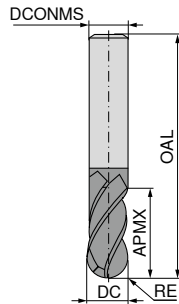
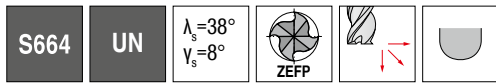

DC inch	APMX inch	OAL inch	DCONMS inch	ZEFP	59 080 ...	59 081 ...	59 080 ...	59 081 ...	59 080 ...	59 081 ...
1/32	3/32	1 1/2	1/8	4					03130	03130
3/64	9/64	1 1/2	1/8	4					04730	04730
1/16	1/8	1 1/2	1/8	4					06320	06320
3/32	3/16	1 1/2	1/8	4					09420	09420
1/8	1/4	1 1/2	1/8	4	12520	12520			12540	12540
1/8	1/2	1 1/2	1/8	4						
1/8	3/4	3	1/8	4					12660	12660
5/32	3/8	2	3/16	4					15624	15624
3/16	3/8	2	3/16	4	18820	18820			18833	18833
3/16	5/8	2	3/16	4						
3/16	1	4	3/16	4					18853	18853
1/4	3/8	2	1/4	4	25015	25015				
1/4	3/4	2 1/2	1/4	4					25030	25030
1/4	1 1/8	3	1/4	4						
5/16	1/2	2	5/16	4	31316	31316				
5/16	3/4	2 1/2	5/16	4					31324	31324
5/16	1 1/8	3	5/16	4						
3/8	5/8	2	3/8	4					31336	31336
3/8	7/8	2 1/2	3/8	4	37517	37517				
3/8	1 1/8	3	3/8	4					37523	37523
3/8	1 1/2	6	3/8	4						
1/2	5/8	2 1/2	1/2	4					37530	37530
1/2	1	3	1/2	4					37540	37540
1/2	1 1/2	6	1/2	4	50013	50013				
5/8	7/8	3	5/8	4					50020	50020
5/8	1 1/4	3 1/2	5/8	4						
5/8	2 1/8	4 5/8	5/8	4					50030	50030
3/4	1	3	3/4	4						
3/4	1 1/2	4	3/4	4	62514	62514				
3/4	2 1/4	5	3/4	4					62520	62520
1	1 3/4	4	1	4						
1	2 1/4	5	1	4					62534	62534
					75013	75013				
									75020	75020
									75030	75030
									99918	99918
									99923	99923
P					•	•	•	•	•	•
M					•	•	•	•	•	•
K					•	•	•	•	•	•
N					•	•	•	•	•	•
S										
H										
O										

→ v_c/f_z Page 126

Ball Nosed Cutter

- ▲ DC tolerance:
 - ≤ ∅ 7/64 inch: +/- 0.0005
 - ≥ ∅ 1/8 inch: 0 / - 0.002
- ▲ Radius accuracy: +/- 0.001

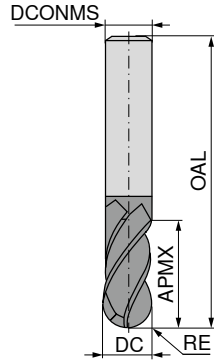
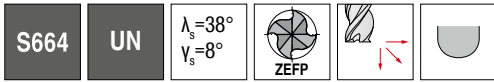

	AITiN	AITiN		
59 080 ...	59 081 ...	59 080 ...	59 081 ...	
06330	06330			
09430	09430			
12560	12560			
		12580	12580	
15632	15632			
18840	18840			
		18860	18860	
		25060	25060	
25040	25040			
		25160	25160	
31332	31332			
		31348	31348	
		37547	37547	
37527	37527			
		37580	37580	
		50040	50040	
50120	50120			
		50060	50060	
		62548	62548	
62532	62532			
		75040	75040	
75027	75027			
		99930	99930	
99920	99920			

DC inch	APMX inch	OAL inch	DCONMS inch	ZEPF
1/16	3/16	1 1/2	1/8	4
3/32	9/32	1 1/2	1/8	4
1/8	3/4	2 1/2	1/8	4
1/8	1	3	1/8	4
5/32	1/2	2	3/16	4
3/16	3/4	2 1/2	3/16	4
3/16	1 1/8	3	3/16	4
1/4	1 1/2	4	1/4	4
1/4	1	4	1/4	4
1/4	1 1/2	6	1/4	4
5/16	1 5/8	4	5/16	4
5/16	1	4	5/16	4
5/16	1 1/2	6	5/16	4
3/8	1 3/4	4	3/8	4
3/8	1	4	3/8	4
3/8	3	6	3/8	4
1/2	2	4	1/2	4
1/2	1	4	1/2	4
1/2	3	6	1/2	4
5/8	3	6	5/8	4
5/8	2	6	5/8	4
3/4	3	6	3/4	4
3/4	2	6	3/4	4
1	3	6	1	4
1	2	6	1	4

P	●	●	●	●
M	●	●	●	●
K	●	●	●	●
N	●	●	●	●
S	●	●	●	●
H				
O				

Ball Nosed Cutter

▲ Radius accuracy: + 0.000 / - 0.0004

P250
ST
 $\lambda_s = 30^\circ$
 $\nu_s = 8^\circ$
ZEPF

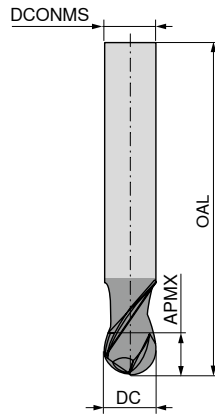

DC <small>+0.000/-0.002</small>	APMX	OAL	DCONMS <small>-0.0001 / -0.0004</small>	ZEPF	59 063 ...	59 063 ...
inch	inch	inch	inch			
1/8	1/8	3	1/8	2		12510
3/16	3/16	3	3/16	2		18810
1/4	1/4	4	1/4	2		25010
3/8	3/8	4	3/8	2	37510	37610
3/8	3/8	6	3/8	2		
1/2	1/2	4	1/2	2	50010	50110
1/2	1/2	6	1/2	2		

P	●	●
M	●	●
K	●	●
N	●	●
S	●	●
H		
O		

→ v_c/f_z Page 127

Ball Nosed Cutter

▲ Radius accuracy: + 0.000 / - 0.0004

P251
UN
 $\lambda_s = 30^\circ$
 $\nu_s = 8^\circ$
ZEP

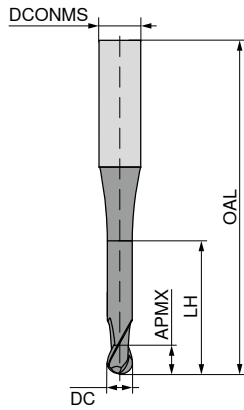

AITiN



HA

59 064 ...

DC ± 0.0005 inch	APMX inch	LH inch	OAL inch	DCONMS $-0.0001 / -0.0004$ inch	ZEP	
0.031	0.031	5/8	4	1/4	2	03110
0.060	0.060	1 1/4	4	1/4	2	06010
0.080	0.080	1 5/8	4	1/4	2	08010
0.094	0.094	1 7/8	4	1/4	2	09410
0.125	0.125	2 1/2	4	1/4	2	12510
0.188	0.188	2.265	4	1/4	2	18810

P	●
M	●
K	●
N	●
S	●
H	
O	

→ v_c/f_z Page 128

Ball Nosed Cutter

▲ Radius accuracy: + 0.000 / - 0.0004

P252
UN
 $\lambda_s = 30^\circ$
 $\nu_s = 8^\circ$
ZEPF

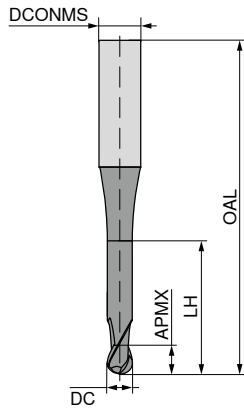

AITiN



HA

59 065 ...

DC ± 0.0005 inch	APMX inch	LH inch	OAL inch	DCONMS $-0.0001 / -0.0004$ inch	ZEPF	
0.031	0.031	2.125	4	1/4	2	03110
0.060	0.060	1.875	4	1/4	2	06010
0.080	0.080	1.704	4	1/4	2	08010
0.094	0.094	1.584	4	1/4	2	09410
0.125	0.125	1.324	4	1/4	2	12510
0.188	0.188	0.785	4	1/4	2	18810

P	•
M	•
K	•
N	•
S	•
H	
O	

→ v_c/f_z Page 128

Ball Nosed Cutter

▲ Radius accuracy: + 0.000 / - 0.0004

P253
UN
 $\lambda_s = 30^\circ$
 $\nu_s = 8^\circ$
ZEPF

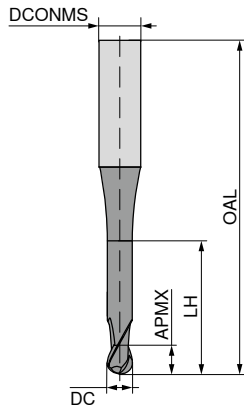

AITiN



HA

59 066 ...

DC ± 0.0005 inch	APMX inch	LH inch	OAL inch	DCONMS $-0.0001 / -0.0004$ inch	ZEPF	
0.031	0.031	1.282	4	1/4	2	03110
0.060	0.060	1.175	4	1/4	2	06010
0.080	0.080	1.084	4	1/4	2	08010
0.094	0.094	1.018	4	1/4	2	09410
0.125	0.125	0.897	4	1/4	2	12510
0.188	0.188	0.687	4	1/4	2	18810

P	●
M	●
K	●
N	●
S	●
H	
O	

→ v_c/f_z Page 128

Ball Nosed Cutter

▲ Radius accuracy: + 0.000 / - 0.0004

P254
UN
 $\lambda_s = 30^\circ$
 $\nu_s = 8^\circ$
ZEFP

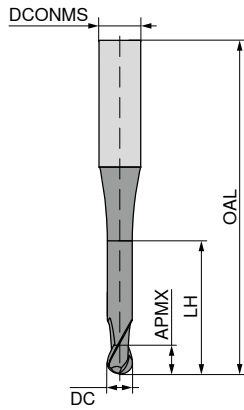

AITiN



HA

59 067 ...

DC ± 0.0005 inch	APMX inch	LH inch	OAL inch	DCONMS $-0.0001 / -0.0004$ inch	ZEFP	
0.031	0.031	0.773	4	1/4	2	03110
0.060	0.060	0.726	4	1/4	2	06010
0.080	0.080	0.690	4	1/4	2	08010
0.094	0.094	0.750	4	1/4	2	09410
0.125	0.125	0.636	4	1/4	2	12510
0.188	0.188	0.454	4	1/4	2	18810

P	•
M	•
K	•
N	•
S	•
H	
O	

→ v_c/f_z Page 128

Micro end milling cutter

P501
UN
 $\lambda_s=30^\circ$
 $\nu_s=13^\circ$
ZEFP

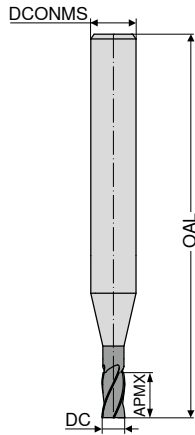
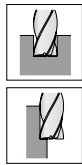

AITiN

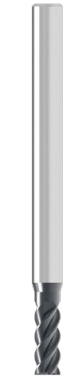

HA

59 007 ...

DC $_{\pm 0.0005}$ inch	APMX inch	OAL inch	DCONMS $_{-0.0001/-0.0004}$ inch	ZEFP	
0.005	0.015	1 1/2	1/8	4	00530
0.006	0.018	1 1/2	1/8	4	00630
0.007	0.021	1 1/2	1/8	4	00730
0.008	0.024	1 1/2	1/8	4	00830
0.009	0.027	1 1/2	1/8	4	00930
0.010	0.030	1 1/2	1/8	4	01030
0.011	0.033	1 1/2	1/8	4	01130
0.012	0.036	1 1/2	1/8	4	01230
0.013	0.039	1 1/2	1/8	4	01330
0.014	0.042	1 1/2	1/8	4	01430
0.015	0.045	1 1/2	1/8	4	01530
0.016	0.048	1 1/2	1/8	4	01630
0.017	0.051	1 1/2	1/8	4	01730
0.018	0.054	1 1/2	1/8	4	01830
0.019	0.057	1 1/2	1/8	4	01930
0.020	0.060	1 1/2	1/8	4	02030
0.021	0.063	1 1/2	1/8	4	02130
0.022	0.066	1 1/2	1/8	4	02230
0.023	0.069	1 1/2	1/8	4	02330
0.024	0.072	1 1/2	1/8	4	02430
0.025	0.075	1 1/2	1/8	4	02530
0.026	0.078	1 1/2	1/8	4	02630
0.027	0.081	1 1/2	1/8	4	02730
0.028	0.084	1 1/2	1/8	4	02830
0.029	0.087	1 1/2	1/8	4	02930
0.030	0.090	1 1/2	1/8	4	03030
0.031	0.093	1 1/2	1/8	4	03130
0.032	0.096	1 1/2	1/8	4	03230
0.033	0.099	1 1/2	1/8	4	03330
0.034	0.102	1 1/2	1/8	4	03430
0.035	0.105	1 1/2	1/8	4	03530
0.036	0.108	1 1/2	1/8	4	03630
0.037	0.111	1 1/2	1/8	4	03730
0.038	0.114	1 1/2	1/8	4	03830
0.039	0.117	1 1/2	1/8	4	03930
0.040	0.120	1 1/2	1/8	4	04030
0.041	0.123	1 1/2	1/8	4	04130
0.042	0.126	1 1/2	1/8	4	04230
0.043	0.129	1 1/2	1/8	4	04330
0.044	0.132	1 1/2	1/8	4	04430
0.045	0.135	1 1/2	1/8	4	04530

P	•
M	•
K	•
N	•
S	•
H	
O	

Micro end milling cutter

P501
UN
 $\lambda_s=30^\circ$
 $\nu_s=13^\circ$
ZEFP

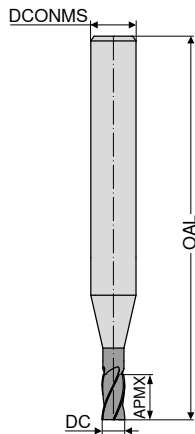
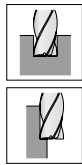

AITiN

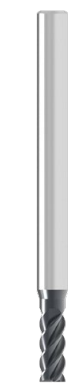

HA

59 007 ...

DC ± 0.0005 inch	APMX inch	OAL inch	DCONMS $-0.0001 / -0.0004$ inch	ZEFP	
0.046	0.138	1 1/2	1/8	4	04630
0.047	0.141	1 1/2	1/8	4	04730
0.048	0.144	1 1/2	1/8	4	04830
0.049	0.147	1 1/2	1/8	4	04930
0.050	0.150	1 1/2	1/8	4	05030
0.051	0.153	1 1/2	1/8	4	05130
0.052	0.156	1 1/2	1/8	4	05230
0.053	0.159	1 1/2	1/8	4	05330
0.054	0.162	1 1/2	1/8	4	05430
0.055	0.165	1 1/2	1/8	4	05530
0.056	0.168	1 1/2	1/8	4	05630
0.057	0.171	1 1/2	1/8	4	05730
0.058	0.174	1 1/2	1/8	4	05830
0.059	0.177	1 1/2	1/8	4	05930
0.060	0.180	1 1/2	1/8	4	06030
0.061	0.183	1 1/2	1/8	4	06130
0.062	0.186	1 1/2	1/8	4	06230
0.063	0.189	1 1/2	1/8	4	06330
0.064	0.192	1 1/2	1/8	4	06430
0.065	0.195	1 1/2	1/8	4	06530
0.066	0.198	1 1/2	1/8	4	06630
0.067	0.201	1 1/2	1/8	4	06730
0.068	0.204	1 1/2	1/8	4	06830
0.069	0.207	1 1/2	1/8	4	06930
0.070	0.210	1 1/2	1/8	4	07030
0.071	0.213	1 1/2	1/8	4	07130
0.072	0.216	1 1/2	1/8	4	07230
0.073	0.219	1 1/2	1/8	4	07330
0.074	0.222	1 1/2	1/8	4	07430
0.075	0.225	1 1/2	1/8	4	07530
0.076	0.228	1 1/2	1/8	4	07630
0.077	0.231	1 1/2	1/8	4	07730
0.078	0.234	1 1/2	1/8	4	07830
0.079	0.237	1 1/2	1/8	4	07930
0.080	0.240	1 1/2	1/8	4	08030
0.081	0.243	1 1/2	1/8	4	08130
0.082	0.246	1 1/2	1/8	4	08230
0.083	0.249	1 1/2	1/8	4	08330
0.084	0.252	1 1/2	1/8	4	08430
0.085	0.255	1 1/2	1/8	4	08530
0.086	0.258	1 1/2	1/8	4	08630

P	•
M	•
K	•
N	•
S	•
H	
O	

→ v_c/f_z Page 130

Micro end milling cutter

P501
UN
 $\lambda_s=30^\circ$
 $\nu_s=13^\circ$
ZEP

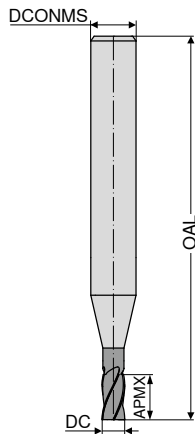
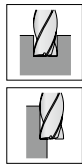

AlTiN

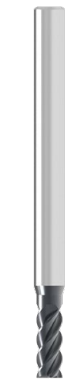

HA

59 007 ...

DC ± 0.0005 inch	APMX inch	OAL inch	DCONMS $-0.0001 / -0.0004$ inch	ZEP	
0.087	0.261	1 1/2	1/8	4	08730
0.088	0.264	1 1/2	1/8	4	08830
0.089	0.267	1 1/2	1/8	4	08930
0.090	0.270	1 1/2	1/8	4	09030
0.091	0.273	1 1/2	1/8	4	09130
0.092	0.276	1 1/2	1/8	4	09230
0.093	0.279	1 1/2	1/8	4	09330
0.094	0.282	1 1/2	1/8	4	09430
0.095	0.285	1 1/2	1/8	4	09530
0.096	0.288	1 1/2	1/8	4	09630
0.097	0.291	1 1/2	1/8	4	09730
0.098	0.294	1 1/2	1/8	4	09830
0.099	0.297	1 1/2	1/8	4	09930
0.100	0.300	1 1/2	1/8	4	10030
0.101	0.303	1 1/2	1/8	4	10130
0.102	0.306	1 1/2	1/8	4	10230
0.103	0.309	1 1/2	1/8	4	10330
0.104	0.312	1 1/2	1/8	4	10430
0.105	0.315	1 1/2	1/8	4	10530
0.106	0.318	1 1/2	1/8	4	10630
0.107	0.321	1 1/2	1/8	4	10730
0.108	0.324	1 1/2	1/8	4	10830
0.109	0.327	1 1/2	1/8	4	10930
0.110	0.330	1 1/2	1/8	4	11030
0.111	0.333	1 1/2	1/8	4	11130
0.112	0.336	1 1/2	1/8	4	11230
0.113	0.339	1 1/2	1/8	4	11330
0.114	0.341	1 1/2	1/8	4	11430
0.115	0.345	1 1/2	1/8	4	11530
0.116	0.348	1 1/2	1/8	4	11630
0.117	0.351	1 1/2	1/8	4	11730
0.118	0.354	1 1/2	1/8	4	11830
0.119	0.357	1 1/2	1/8	4	11930
0.120	0.360	1 1/2	1/8	4	12030

P	•
M	•
K	•
N	•
S	•
H	•
O	

Micro end milling cutter

P504
UN
 $\lambda_s=30^\circ$
 $\nu_s=13^\circ$
ZEFP

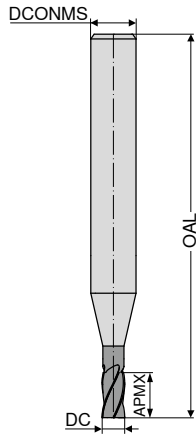
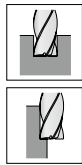

AITiN



HA

59 009 ...

DC ± 0.0005 inch	APMX inch	OAL inch	DCONMS $-0.0001 / -0.0004$ inch	ZEFP	
0.005	0.008	1 1/2	1/8	4	00516
0.006	0.009	1 1/2	1/8	4	00615
0.007	0.011	1 1/2	1/8	4	00716
0.008	0.012	1 1/2	1/8	4	00815
0.009	0.014	1 1/2	1/8	4	00916
0.010	0.015	1 1/2	1/8	4	01015
0.011	0.017	1 1/2	1/8	4	01115
0.012	0.018	1 1/2	1/8	4	01215
0.013	0.020	1 1/2	1/8	4	01315
0.014	0.021	1 1/2	1/8	4	01415
0.015	0.023	1 1/2	1/8	4	01515
0.016	0.024	1 1/2	1/8	4	01615
0.017	0.026	1 1/2	1/8	4	01715
0.018	0.027	1 1/2	1/8	4	01815
0.019	0.029	1 1/2	1/8	4	01915
0.020	0.030	1 1/2	1/8	4	02015
0.021	0.032	1 1/2	1/8	4	02115
0.022	0.033	1 1/2	1/8	4	02215
0.023	0.035	1 1/2	1/8	4	02315
0.024	0.036	1 1/2	1/8	4	02415
0.025	0.038	1 1/2	1/8	4	02515
0.026	0.039	1 1/2	1/8	4	02615
0.027	0.041	1 1/2	1/8	4	02715
0.028	0.042	1 1/2	1/8	4	02815
0.029	0.044	1 1/2	1/8	4	02915
0.030	0.045	1 1/2	1/8	4	03015
0.031	0.047	1 1/2	1/8	4	03115
0.032	0.048	1 1/2	1/8	4	03215
0.033	0.050	1 1/2	1/8	4	03315
0.034	0.051	1 1/2	1/8	4	03415
0.035	0.053	1 1/2	1/8	4	03515
0.036	0.054	1 1/2	1/8	4	03615
0.037	0.056	1 1/2	1/8	4	03715
0.038	0.057	1 1/2	1/8	4	03815
0.039	0.059	1 1/2	1/8	4	03915
0.040	0.060	1 1/2	1/8	4	04015
0.041	0.062	1 1/2	1/8	4	04115
0.042	0.063	1 1/2	1/8	4	04215
0.043	0.065	1 1/2	1/8	4	04315
0.044	0.066	1 1/2	1/8	4	04415
0.045	0.068	1 1/2	1/8	4	04515

P	•
M	•
K	•
N	•
S	•
H	
O	

→ v_c/f_z Page 129

Micro end milling cutter

P504
UN
 $\lambda_s=30^\circ$
 $\nu_s=13^\circ$
ZEFP

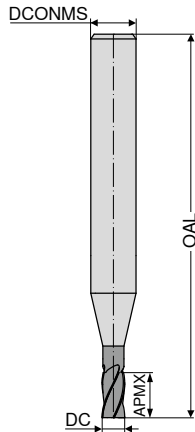
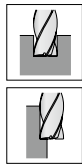

AITiN

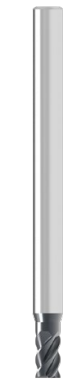

HA

59 009 ...

DC ± 0.0005 inch	APMX inch	OAL inch	DCONMS $-0.0001 / -0.0004$ inch	ZEFP	
0.046	0.069	1 1/2	1/8	4	04615
0.047	0.071	1 1/2	1/8	4	04715
0.048	0.072	1 1/2	1/8	4	04815
0.049	0.074	1 1/2	1/8	4	04915
0.050	0.075	1 1/2	1/8	4	05015
0.051	0.077	1 1/2	1/8	4	05115
0.052	0.078	1 1/2	1/8	4	05215
0.053	0.080	1 1/2	1/8	4	05315
0.054	0.081	1 1/2	1/8	4	05415
0.055	0.083	1 1/2	1/8	4	05515
0.056	0.084	1 1/2	1/8	4	05615
0.057	0.086	1 1/2	1/8	4	05715
0.058	0.087	1 1/2	1/8	4	05815
0.059	0.089	1 1/2	1/8	4	05915
0.060	0.090	1 1/2	1/8	4	06015
0.061	0.092	1 1/2	1/8	4	06115
0.062	0.093	1 1/2	1/8	4	06215
0.063	0.095	1 1/2	1/8	4	06315
0.064	0.096	1 1/2	1/8	4	06415
0.065	0.098	1 1/2	1/8	4	06515
0.066	0.099	1 1/2	1/8	4	06615
0.067	0.101	1 1/2	1/8	4	06715
0.068	0.102	1 1/2	1/8	4	06815
0.069	0.104	1 1/2	1/8	4	06915
0.070	0.105	1 1/2	1/8	4	07015
0.071	0.107	1 1/2	1/8	4	07115
0.072	0.108	1 1/2	1/8	4	07215
0.073	0.110	1 1/2	1/8	4	07315
0.074	0.111	1 1/2	1/8	4	07415
0.075	0.113	1 1/2	1/8	4	07515
0.076	0.114	1 1/2	1/8	4	07615
0.077	0.116	1 1/2	1/8	4	07715
0.078	0.117	1 1/2	1/8	4	07815
0.079	0.119	1 1/2	1/8	4	07915
0.080	0.120	1 1/2	1/8	4	08015
0.081	0.122	1 1/2	1/8	4	08115
0.082	0.123	1 1/2	1/8	4	08215
0.083	0.125	1 1/2	1/8	4	08315
0.084	0.126	1 1/2	1/8	4	08415
0.085	0.128	1 1/2	1/8	4	08515
0.086	0.129	1 1/2	1/8	4	08615

P	•
M	•
K	•
N	•
S	•
H	
O	

Micro end milling cutter

P504
UN
 $\lambda_s=30^\circ$
 $\gamma_s=13^\circ$
ZEPF

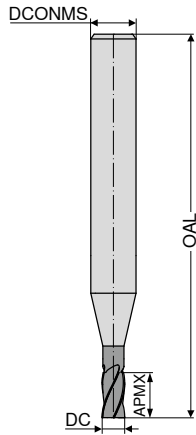
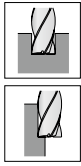

AITiN

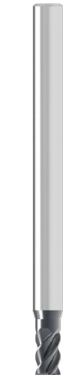

HA

59 009 ...

DC $_{\pm 0.0005}$ inch	APMX inch	OAL inch	DCONMS $_{-0.0001/-0.0004}$ inch	ZEPF	
0.087	0.131	1 1/2	1/8	4	08715
0.088	0.132	1 1/2	1/8	4	08815
0.089	0.134	1 1/2	1/8	4	08915
0.090	0.135	1 1/2	1/8	4	09015
0.091	0.137	1 1/2	1/8	4	09115
0.092	0.138	1 1/2	1/8	4	09215
0.093	0.140	1 1/2	1/8	4	09315
0.094	0.141	1 1/2	1/8	4	09415
0.095	0.143	1 1/2	1/8	4	09515
0.096	0.144	1 1/2	1/8	4	09615
0.097	0.146	1 1/2	1/8	4	09715
0.098	0.147	1 1/2	1/8	4	09815
0.099	0.149	1 1/2	1/8	4	09915
0.100	0.150	1 1/2	1/8	4	10015
0.101	0.152	1 1/2	1/8	4	10115
0.102	0.153	1 1/2	1/8	4	10215
0.103	0.155	1 1/2	1/8	4	10315
0.104	0.156	1 1/2	1/8	4	10415
0.105	0.158	1 1/2	1/8	4	10515
0.106	0.159	1 1/2	1/8	4	10615
0.107	0.161	1 1/2	1/8	4	10715
0.108	0.162	1 1/2	1/8	4	10815
0.109	0.164	1 1/2	1/8	4	10915
0.110	0.165	1 1/2	1/8	4	11015
0.111	0.167	1 1/2	1/8	4	11115
0.112	0.168	1 1/2	1/8	4	11215
0.113	0.170	1 1/2	1/8	4	11315
0.114	0.171	1 1/2	1/8	4	11415
0.115	0.173	1 1/2	1/8	4	11515
0.116	0.174	1 1/2	1/8	4	11615
0.117	0.176	1 1/2	1/8	4	11715
0.118	0.177	1 1/2	1/8	4	11815
0.119	0.179	1 1/2	1/8	4	11915
0.120	0.180	1 1/2	1/8	4	12015

P	•
M	•
K	•
N	•
S	•
H	
O	

→ v_c/f_z Page 129

Micro ball nosed cutter

P503
UN
 $\lambda_s=30^\circ$
 $\nu_s=13^\circ$
ZEFP

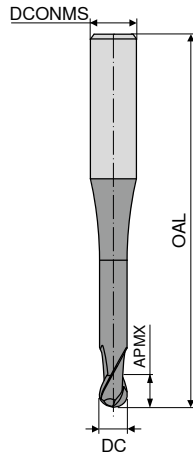

AITiN



HA

59 008 ...

DC ± 0.0005 inch	APMX inch	OAL inch	DCONMS $-0.0001 / -0.0004$ inch	ZEFP	
0.005	0.015	1 1/2	1/8	4	00530
0.006	0.018	1 1/2	1/8	4	00630
0.007	0.021	1 1/2	1/8	4	00730
0.008	0.024	1 1/2	1/8	4	00830
0.009	0.027	1 1/2	1/8	4	00930
0.010	0.030	1 1/2	1/8	4	01030
0.011	0.033	1 1/2	1/8	4	01130
0.012	0.036	1 1/2	1/8	4	01230
0.013	0.039	1 1/2	1/8	4	01330
0.014	0.042	1 1/2	1/8	4	01430
0.015	0.045	1 1/2	1/8	4	01530
0.016	0.048	1 1/2	1/8	4	01630
0.017	0.051	1 1/2	1/8	4	01730
0.018	0.054	1 1/2	1/8	4	01830
0.019	0.057	1 1/2	1/8	4	01930
0.020	0.060	1 1/2	1/8	4	02030
0.021	0.063	1 1/2	1/8	4	02130
0.022	0.066	1 1/2	1/8	4	02230
0.023	0.069	1 1/2	1/8	4	02330
0.024	0.072	1 1/2	1/8	4	02430
0.025	0.075	1 1/2	1/8	4	02530
0.026	0.078	1 1/2	1/8	4	02630
0.027	0.081	1 1/2	1/8	4	02730
0.028	0.084	1 1/2	1/8	4	02830
0.029	0.087	1 1/2	1/8	4	02930
0.030	0.090	1 1/2	1/8	4	03030
0.031	0.093	1 1/2	1/8	4	03130
0.032	0.096	1 1/2	1/8	4	03230
0.033	0.099	1 1/2	1/8	4	03330
0.034	0.102	1 1/2	1/8	4	03430
0.035	0.105	1 1/2	1/8	4	03530
0.036	0.108	1 1/2	1/8	4	03630
0.037	0.111	1 1/2	1/8	4	03730
0.038	0.114	1 1/2	1/8	4	03830
0.039	0.117	1 1/2	1/8	4	03930
0.040	0.120	1 1/2	1/8	4	04030
0.041	0.123	1 1/2	1/8	4	04130
0.042	0.126	1 1/2	1/8	4	04230
0.043	0.129	1 1/2	1/8	4	04330
0.044	0.132	1 1/2	1/8	4	04430
0.045	0.135	1 1/2	1/8	4	04530

P	•
M	•
K	•
N	•
S	•
H	
O	

Micro ball nosed cutter

P503
UN
 $\lambda_s=30^\circ$
 $\nu_s=13^\circ$
ZEFP

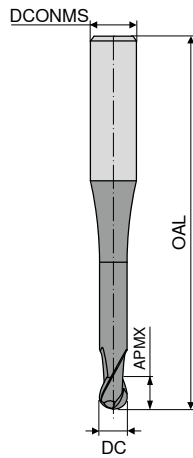

AITiN



HA

59 008 ...

DC ± 0.0005 inch	APMX inch	OAL inch	DCONMS $-0.0001 / -0.0004$ inch	ZEFP	
0.046	0.138	1 1/2	1/8	4	04630
0.047	0.141	1 1/2	1/8	4	04730
0.048	0.144	1 1/2	1/8	4	04830
0.049	0.147	1 1/2	1/8	4	04930
0.050	0.150	1 1/2	1/8	4	05030
0.051	0.153	1 1/2	1/8	4	05130
0.052	0.156	1 1/2	1/8	4	05230
0.053	0.159	1 1/2	1/8	4	05330
0.054	0.162	1 1/2	1/8	4	05430
0.055	0.165	1 1/2	1/8	4	05530
0.056	0.168	1 1/2	1/8	4	05630
0.057	0.171	1 1/2	1/8	4	05730
0.058	0.174	1 1/2	1/8	4	05830
0.059	0.177	1 1/2	1/8	4	05930
0.060	0.180	1 1/2	1/8	4	06030
0.061	0.183	1 1/2	1/8	4	06130
0.062	0.186	1 1/2	1/8	4	06230
0.063	0.189	1 1/2	1/8	4	06330
0.064	0.192	1 1/2	1/8	4	06430
0.065	0.195	1 1/2	1/8	4	06530
0.066	0.198	1 1/2	1/8	4	06630
0.067	0.201	1 1/2	1/8	4	06730
0.068	0.204	1 1/2	1/8	4	06830
0.069	0.207	1 1/2	1/8	4	06930
0.070	0.210	1 1/2	1/8	4	07030
0.071	0.213	1 1/2	1/8	4	07130
0.072	0.216	1 1/2	1/8	4	07230
0.073	0.219	1 1/2	1/8	4	07330
0.074	0.222	1 1/2	1/8	4	07430
0.075	0.225	1 1/2	1/8	4	07530
0.076	0.228	1 1/2	1/8	4	07630
0.077	0.231	1 1/2	1/8	4	07730
0.078	0.234	1 1/2	1/8	4	07830
0.079	0.237	1 1/2	1/8	4	07930
0.080	0.240	1 1/2	1/8	4	08030
0.081	0.243	1 1/2	1/8	4	08130
0.082	0.246	1 1/2	1/8	4	08230
0.083	0.249	1 1/2	1/8	4	08330
0.084	0.252	1 1/2	1/8	4	08430
0.085	0.255	1 1/2	1/8	4	08530
0.086	0.258	1 1/2	1/8	4	08630

P	•
M	•
K	•
N	•
S	•
H	
O	

Micro ball nosed cutter

P503
UN
 $\lambda_s=30^\circ$
 $\nu_s=13^\circ$
ZEPF

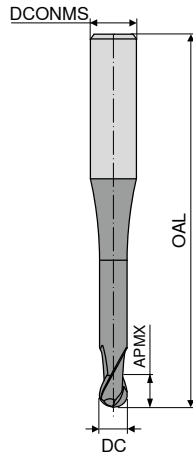

AITiN



HA

59 008 ...

DC ± 0.0005 inch	APMX inch	OAL inch	DCONMS $-0.0001 / -0.0004$ inch	ZEPF	
0.087	0.261	1 1/2	1/8	4	08730
0.088	0.264	1 1/2	1/8	4	08830
0.089	0.267	1 1/2	1/8	4	08930
0.090	0.270	1 1/2	1/8	4	09030
0.091	0.273	1 1/2	1/8	4	09130
0.092	0.276	1 1/2	1/8	4	09230
0.093	0.279	1 1/2	1/8	4	09330
0.094	0.282	1 1/2	1/8	4	09430
0.095	0.285	1 1/2	1/8	4	09530
0.096	0.288	1 1/2	1/8	4	09630
0.097	0.291	1 1/2	1/8	4	09730
0.098	0.294	1 1/2	1/8	4	09830
0.099	0.297	1 1/2	1/8	4	09930
0.100	0.300	1 1/2	1/8	4	10030
0.101	0.303	1 1/2	1/8	4	10130
0.102	0.306	1 1/2	1/8	4	10230
0.103	0.309	1 1/2	1/8	4	10330
0.104	0.312	1 1/2	1/8	4	10430
0.105	0.315	1 1/2	1/8	4	10530
0.106	0.318	1 1/2	1/8	4	10630
0.107	0.321	1 1/2	1/8	4	10730
0.108	0.324	1 1/2	1/8	4	10830
0.109	0.327	1 1/2	1/8	4	10930
0.110	0.330	1 1/2	1/8	4	11030
0.111	0.333	1 1/2	1/8	4	11130
0.112	0.336	1 1/2	1/8	4	11230
0.113	0.339	1 1/2	1/8	4	11330
0.114	0.341	1 1/2	1/8	4	11430
0.115	0.345	1 1/2	1/8	4	11530
0.116	0.348	1 1/2	1/8	4	11630
0.117	0.351	1 1/2	1/8	4	11730
0.118	0.354	1 1/2	1/8	4	11830
0.119	0.357	1 1/2	1/8	4	11930
0.120	0.360	1 1/2	1/8	4	12030

P	•
M	•
K	•
N	•
S	•
H	
O	

Micro ball nosed cutter

P506
UN
 $\lambda_s=30^\circ$
 $\nu_s=13^\circ$
ZEFP

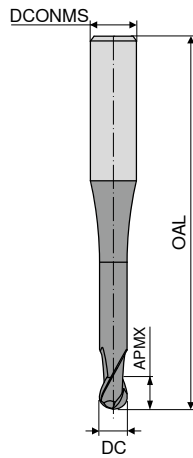

AITiN



HA

59 010 ...

DC ± 0.0005 inch	APMX inch	OAL inch	DCONMS $-0.0001 / -0.0004$ inch	ZEFP	
0.005	0.008	1 1/2	1/8	4	00516
0.006	0.009	1 1/2	1/8	4	00615
0.007	0.011	1 1/2	1/8	4	00716
0.008	0.012	1 1/2	1/8	4	00815
0.009	0.014	1 1/2	1/8	4	00916
0.010	0.015	1 1/2	1/8	4	01015
0.011	0.017	1 1/2	1/8	4	01115
0.012	0.018	1 1/2	1/8	4	01215
0.013	0.020	1 1/2	1/8	4	01315
0.014	0.021	1 1/2	1/8	4	01415
0.015	0.023	1 1/2	1/8	4	01515
0.016	0.024	1 1/2	1/8	4	01615
0.017	0.026	1 1/2	1/8	4	01715
0.018	0.027	1 1/2	1/8	4	01815
0.019	0.029	1 1/2	1/8	4	01915
0.020	0.030	1 1/2	1/8	4	02015
0.021	0.032	1 1/2	1/8	4	02115
0.022	0.033	1 1/2	1/8	4	02215
0.023	0.035	1 1/2	1/8	4	02315
0.024	0.036	1 1/2	1/8	4	02415
0.025	0.038	1 1/2	1/8	4	02515
0.026	0.039	1 1/2	1/8	4	02615
0.027	0.041	1 1/2	1/8	4	02715
0.028	0.042	1 1/2	1/8	4	02815
0.029	0.044	1 1/2	1/8	4	02915
0.030	0.045	1 1/2	1/8	4	03015
0.031	0.047	1 1/2	1/8	4	03115
0.032	0.048	1 1/2	1/8	4	03215
0.033	0.050	1 1/2	1/8	4	03315
0.034	0.051	1 1/2	1/8	4	03415
0.035	0.053	1 1/2	1/8	4	03515
0.036	0.054	1 1/2	1/8	4	03615
0.037	0.056	1 1/2	1/8	4	03715
0.038	0.057	1 1/2	1/8	4	03815
0.039	0.059	1 1/2	1/8	4	03915
0.040	0.060	1 1/2	1/8	4	04015
0.041	0.062	1 1/2	1/8	4	04115
0.042	0.063	1 1/2	1/8	4	04215
0.043	0.065	1 1/2	1/8	4	04315
0.044	0.066	1 1/2	1/8	4	04415
0.045	0.068	1 1/2	1/8	4	04515

P	•
M	•
K	•
N	•
S	•
H	
O	

Micro ball nosed cutter

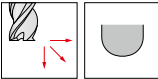
P506
UN
 $\lambda_s=30^\circ$
 $\nu_s=13^\circ$
ZEFP

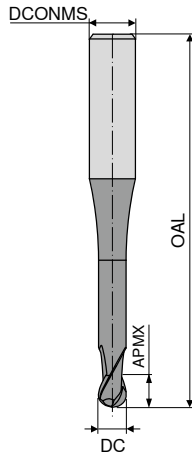

AITiN



HA

59 010 ...

DC $_{\pm 0.0005}$ inch	APMX inch	OAL inch	DCONMS $_{-0.0001 / -0.0004}$ inch	ZEFP	
0.046	0.069	1 1/2	1/8	4	04615
0.047	0.071	1 1/2	1/8	4	04715
0.048	0.072	1 1/2	1/8	4	04815
0.049	0.074	1 1/2	1/8	4	04915
0.050	0.075	1 1/2	1/8	4	05015
0.051	0.077	1 1/2	1/8	4	05115
0.052	0.078	1 1/2	1/8	4	05215
0.053	0.080	1 1/2	1/8	4	05315
0.054	0.081	1 1/2	1/8	4	05415
0.055	0.083	1 1/2	1/8	4	05515
0.056	0.084	1 1/2	1/8	4	05615
0.057	0.086	1 1/2	1/8	4	05715
0.058	0.087	1 1/2	1/8	4	05815
0.059	0.089	1 1/2	1/8	4	05915
0.060	0.090	1 1/2	1/8	4	06015
0.061	0.092	1 1/2	1/8	4	06115
0.062	0.093	1 1/2	1/8	4	06215
0.063	0.095	1 1/2	1/8	4	06315
0.064	0.096	1 1/2	1/8	4	06415
0.065	0.098	1 1/2	1/8	4	06515
0.066	0.099	1 1/2	1/8	4	06615
0.067	0.101	1 1/2	1/8	4	06715
0.068	0.102	1 1/2	1/8	4	06815
0.069	0.104	1 1/2	1/8	4	06915
0.070	0.105	1 1/2	1/8	4	07015
0.071	0.107	1 1/2	1/8	4	07115
0.072	0.108	1 1/2	1/8	4	07215
0.073	0.110	1 1/2	1/8	4	07315
0.074	0.111	1 1/2	1/8	4	07415
0.075	0.113	1 1/2	1/8	4	07515
0.076	0.114	1 1/2	1/8	4	07615
0.077	0.116	1 1/2	1/8	4	07715
0.078	0.117	1 1/2	1/8	4	07815
0.079	0.119	1 1/2	1/8	4	07915
0.080	0.120	1 1/2	1/8	4	08015
0.081	0.122	1 1/2	1/8	4	08115
0.082	0.123	1 1/2	1/8	4	08215
0.083	0.125	1 1/2	1/8	4	08315
0.084	0.126	1 1/2	1/8	4	08415
0.085	0.128	1 1/2	1/8	4	08515
0.086	0.129	1 1/2	1/8	4	08615

P	•
M	•
K	•
N	•
S	•
H	
O	

Micro ball nosed cutter

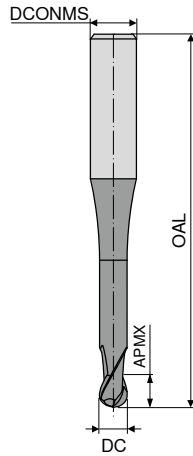
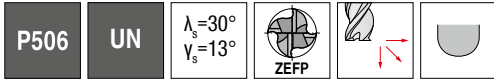

AITiN



HA

59 010 ...

DC ± 0.0005 inch	APMX inch	OAL inch	DCONMS $-0.0001 / -0.0004$ inch	ZEFP	
0.087	0.131	1 1/2	1/8	4	08715
0.088	0.132	1 1/2	1/8	4	08815
0.089	0.134	1 1/2	1/8	4	08915
0.090	0.135	1 1/2	1/8	4	09015
0.091	0.137	1 1/2	1/8	4	09115
0.092	0.138	1 1/2	1/8	4	09215
0.093	0.140	1 1/2	1/8	4	09315
0.094	0.141	1 1/2	1/8	4	09415
0.095	0.143	1 1/2	1/8	4	09515
0.096	0.144	1 1/2	1/8	4	09615
0.097	0.146	1 1/2	1/8	4	09715
0.098	0.147	1 1/2	1/8	4	09815
0.099	0.149	1 1/2	1/8	4	09915
0.100	0.150	1 1/2	1/8	4	10015
0.101	0.152	1 1/2	1/8	4	10115
0.102	0.153	1 1/2	1/8	4	10215
0.103	0.155	1 1/2	1/8	4	10315
0.104	0.156	1 1/2	1/8	4	10415
0.105	0.158	1 1/2	1/8	4	10515
0.106	0.159	1 1/2	1/8	4	10615
0.107	0.161	1 1/2	1/8	4	10715
0.108	0.162	1 1/2	1/8	4	10815
0.109	0.164	1 1/2	1/8	4	10915
0.110	0.165	1 1/2	1/8	4	11015
0.111	0.167	1 1/2	1/8	4	11115
0.112	0.168	1 1/2	1/8	4	11215
0.113	0.170	1 1/2	1/8	4	11315
0.114	0.171	1 1/2	1/8	4	11415
0.115	0.173	1 1/2	1/8	4	11515
0.116	0.174	1 1/2	1/8	4	11615
0.117	0.176	1 1/2	1/8	4	11715
0.118	0.177	1 1/2	1/8	4	11815
0.119	0.179	1 1/2	1/8	4	11915
0.120	0.180	1 1/2	1/8	4	12015

P	•
M	•
K	•
N	•
S	•
H	
O	

→ v_c/f_z Page 129

Profile end milling cutter

▲ PRFRAD ≤ 1.397 [Inch] Tol. = ± 0.01

▲ PRFRAD > 1.397 [Inch] Tol. = ± 0.015

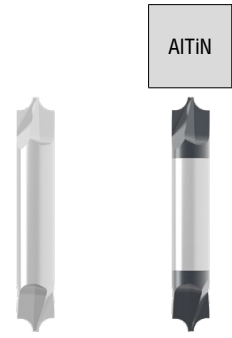
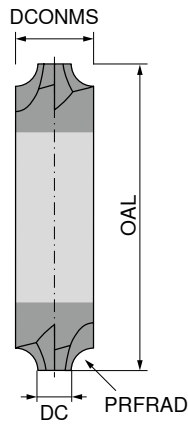
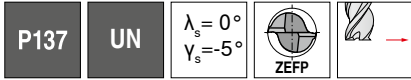

59 049 ... 59 050 ...

PRFRAD	DC	OAL	DCONMS	ZEFP	59 049 ...	59 050 ...
inch	^{+0.000/-0.002} inch	inch	^{-0.0001/-0.0004} inch			
0.010	0.125	1 1/2	1/8	2	12510	
0.010	0.125	1 1/2	1/8	2		12510
0.015	0.125	1 1/2	1/8	2	12515	
0.015	0.125	1 1/2	1/8	2		12515
0.020	0.125	1 1/2	1/8	2	12520	
0.020	0.125	1 1/2	1/8	2		12520
0.025	0.125	1 1/2	1/8	2	12525	
0.025	0.125	1 1/2	1/8	2		12525
0.031	0.125	1 1/2	1/8	2	12531	
0.031	0.125	1 1/2	1/8	2		12531
0.035	0.125	1 1/2	1/8	2	12535	
0.035	0.125	1 1/2	1/8	2		12535
0.040	0.125	1 1/2	1/8	2	12540	
0.040	0.125	1 1/2	1/8	2		12540
0.046	0.125	1 1/2	1/8	2	12546	
0.046	0.125	1 1/2	1/8	2		12546
0.050	0.188	2	3/16	2	18850	
0.050	0.188	2	3/16	2		18850
0.055	0.188	2	3/16	2	18855	
0.055	0.188	2	3/16	2		18855
0.062	0.188	2	3/16	2	18862	
0.062	0.188	2	3/16	2		18862
0.072	0.250	2 1/2	1/4	2	25072	
0.072	0.250	2 1/2	1/4	2		25072
0.078	0.250	2 1/2	1/4	2	25078	
0.078	0.250	2 1/2	1/4	2		25078
0.085	0.250	2 1/2	1/4	2	25085	
0.085	0.250	2 1/2	1/4	2		25085
0.094	0.250	2 1/2	1/4	2	25094	
0.094	0.250	2 1/2	1/4	2		25094
0.100	0.250	2 1/2	1/4	2	25000	
0.100	0.250	2 1/2	1/4	2		25000
0.109	0.250	2 1/2	1/4	2	25009	
0.109	0.250	2 1/2	1/4	2		25009
0.118	0.313	2 1/2	5/16	2	31318	
0.118	0.313	2 1/2	5/16	2		31318
0.125	0.313	2 1/2	5/16	2	31325	
0.125	0.313	2 1/2	5/16	2		31325
0.140	0.375	2 1/2	3/8	2	37540	
0.140	0.375	2 1/2	3/8	2		37540
0.156	0.375	2 1/2	3/8	2	37556	
0.156	0.375	2 1/2	3/8	2		37556

P	•	•
M		
K	•	•
N		
S		
H		
O		

Profile end milling cutter

- ▲ PRFRAD ≤ 1.397 [Inch] Tol. = ± 0.01
- ▲ PRFRAD > 1.397 [Inch] Tol. = ± 0.015

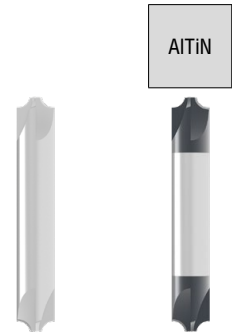
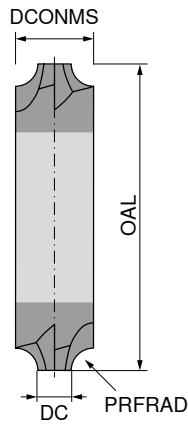
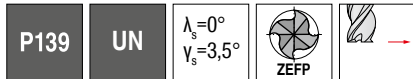

59 051 ...	59 052 ...
18810	18810
18910	18910
19010	19010
19110	19110
19210	19210
19310	19310
25010	25010
25110	25110
25210	25210
25410	25410
25310	25310
37510	37510
37610	37610
37710	37710
37810	37810
37910	37910
50010	50010

PRFRAD	DC	APMX	OAL	DCONMS	ZEFP
inch	inch	inch	inch	inch	
0.010	3/16	3/16	2	3/16	4
0.015	3/16	3/16	2	3/16	4
0.020	3/16	3/16	2	3/16	4
0.025	3/16	3/16	2	3/16	4
0.031	3/16	3/16	2	3/16	4
0.035	3/16	3/16	2	3/16	4
0.040	1/4	1/4	2 1/2	1/4	4
0.046	1/4	1/4	2 1/2	1/4	4
0.050	1/4	1/4	2 1/2	1/4	4
0.055	1/4	1/4	2 1/2	1/4	4
0.062	1/4	1/4	2 1/2	1/4	4
0.078	3/8	3/8	2 1/2	3/8	4
0.094	3/8	3/8	2 1/2	3/8	4
0.100	3/8	3/8	2 1/2	3/8	4
0.118	3/8	3/8	2 1/2	3/8	4
0.125	3/8	3/8	2 1/2	3/8	4
0.156	1/2	1/2	3	1/2	4

P	•	•
M		
K	•	•
N		
S		
H		
O		

→ v_c/f_z Page 133

Chamfer milling cutter 60°

P132
UN
 $\lambda_s=0^\circ$
 $\nu_s=0^\circ$
ZEFP

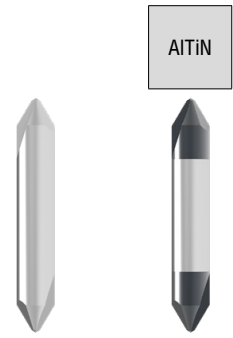
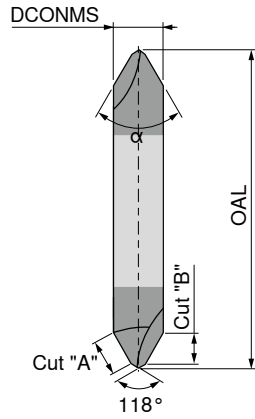

59 041 ...	59 042 ...
12506	12506
18806	18806
25006	25006
37506	37506
50006	50006

DC inch	Cut "A" inch	Cut "B" inch	OAL inch	DCONMS inch	ZEFP
1/8	0.098	0.085	1 1/2	1/8	2
3/16	0.147	0.127	2	3/16	2
1/4	0.200	0.173	2 1/2	1/4	2
3/8	0.313	0.271	2 1/2	3/8	2
1/2	0.430	0.372	3	1/2	2

P	•	•
M		
K	•	•
N		
S		
H		
O		

→ v_c/f_z Page 134-135

Chamfer milling cutter 60°

P133
UN
 $\lambda_s=0^\circ$
 $\nu_s=0^\circ$
ZEP

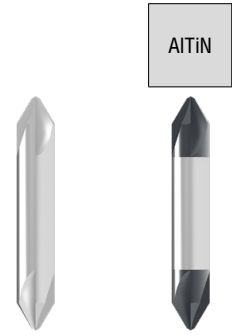
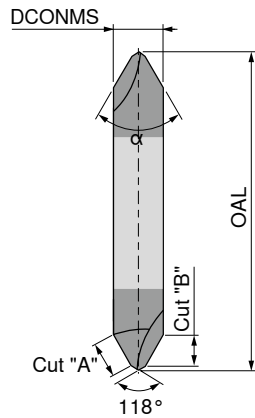

$\alpha = 60^\circ$ HA
 $\alpha = 60^\circ$ HA

59 043 ...	59 044 ...
25006	25006
37506	37506
50006	50006

DC inch	Cut "A" inch	Cut "B" inch	OAL inch	DCONMS inch	ZEFP
1/4	0.200	0.173	2 1/2	1/4	4
3/8	0.313	0.271	2 1/2	3/8	4
1/2	0.430	0.372	3	1/2	4

P	•	•
M		
K	•	•
N		
S		
H		
O		

→ v_c/f_z Page 136-137

Chamfer milling cutter 90°

P134
UN
 $\lambda_s=0^\circ$
 $\nu_s=0^\circ$
ZEFP

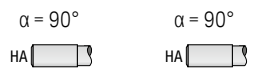
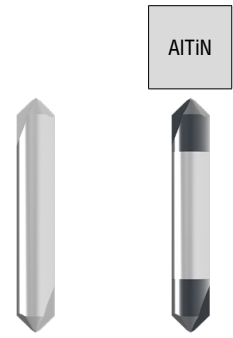
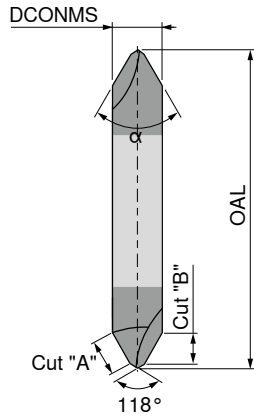

59 045 ...	59 046 ...
12509	12509
18809	18809
25009	25009
37509	37509
50009	50009

DC inch	Cut "A" inch	Cut "B" inch	OAL inch	DCONMS inch	ZEFP
1/8	0.071	0.050	1 1/2	1/8	2
3/16	0.107	0.076	2	3/16	2
1/4	0.141	0.100	2 1/2	1/4	2
3/8	0.221	0.157	2 1/2	3/8	2
1/2	0.304	0.215	3	1/2	2

P	•	•
M		
K	•	•
N		
S		
H		
O		

→ v_c/f_z Page 134-135

Chamfer milling cutter 90°

P135
UN
 $\lambda_s=0^\circ$
 $\nu_s=0^\circ$
ZEP

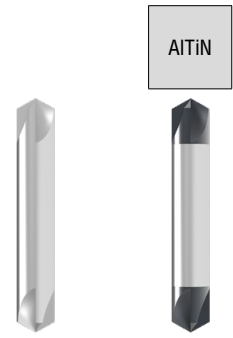
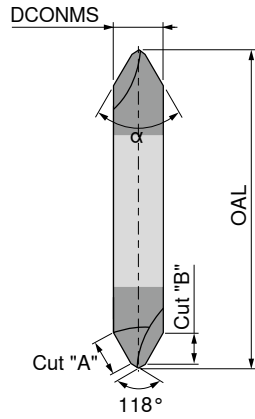

$\alpha = 90^\circ$ HA
 $\alpha = 90^\circ$ HA

59 047 ...	59 048 ...
25009	25009
37509	37509
50009	50009

DC inch	Cut "A" inch	Cut "B" inch	OAL inch	DCONMS inch	ZEFP
1/4	0.141	0.100	2 1/2	1/4	4
3/8	0.221	0.157	2 1/2	3/8	4
1/2	0.304	0.215	3	1/2	4

P	•	•
M		
K	•	•
N		
S		
H		
O		

→ v_c/f_z Page 136-137

Chamfer milling cutter 120°

P130
UN
 $\lambda_s=0^\circ$
 $\nu_s=0^\circ$
ZEFP

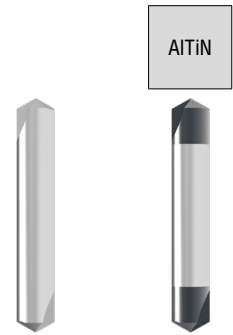
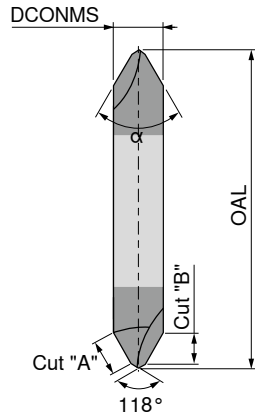

$\alpha = 120^\circ$ HA
 $\alpha = 120^\circ$ HA

59 037 ...	59 038 ...
25012	25012
37512	37512
50012	50012

DC inch	Cut "A" inch	Cut "B" inch	OAL inch	DCONMS inch	ZEFP
1/4	0.124	0.062	2 1/2	1/4	2
3/8	0.199	0.100	2 1/2	3/8	2
1/2	0.266	0.133	3	1/2	2

P	•	•
M		
K	•	•
N		
S		
H		
O		

→ v_c/f_z Page 134-135

Chamfer milling cutter 120°

P131
UN
 $\lambda_s=0^\circ$
 $\nu_s=0^\circ$
ZEFP

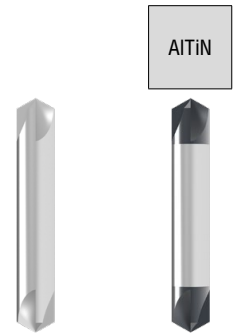
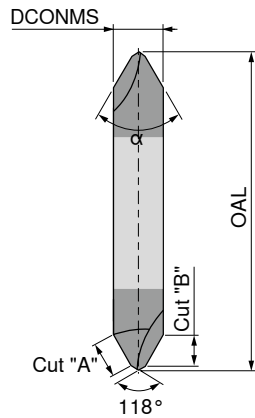

$\alpha = 120^\circ$ HA
 $\alpha = 120^\circ$ HA

DC inch	Cut "A" inch	Cut "B" inch	OAL inch	DCONMS inch	ZEFP
1/4	0.144	0.072	2 1/2	1/4	4
3/8	0.217	0.108	2 1/2	3/8	4
1/2	0.289	0.144	3	1/2	4

59 039 ...	59 040 ...
25012	25012
37512	37512
50012	50012

P	•	•
M		
K	•	•
N		
S		
H		
O		

→ v_c/f_z Page 136-137

Material examples for cutting data tables

	Material sub-group	Index	Composition / Structure / Heat treatment	Tensile strength lbf/in ² / HB / HRC	Material number	Material designation	Material number	Material designation
P	Unalloyed steel	P.1.1	< 0.15 % C Annealed	60900 lbf/in ² / 125 HB	1.0401	1015	1.0301	1010
		P.1.2	< 0.45 % C Annealed	92800 lbf/in ² / 190 HB	1.1191	1045	1.0737	12L14
		P.1.3	< 0.45 % C Tempered	121800 lbf/in ² / 250 HB	1.1191	1045	1.0503	1043
		P.1.4	< 0.75 % C Annealed	132000 lbf/in ² / 270 HB	1.1223	1060	1.0535	1055
		P.1.5	< 0.75 % C Tempered	146500 lbf/in ² / 300 HB	1.1223	1060	1.1274	1095
	Low-alloy steel	P.2.1	Annealed	88500 lbf/in ² / 180 HB	1.7131	5115	1.6523	8620
		P.2.2	Tempered	134900 lbf/in ² / 275 HB	1.7131	5115	1.6582	4340
		P.2.3	Tempered	146500 lbf/in ² / 300 HB	1.7225	4142	1.7131	5115
		P.2.4	Tempered	174000 lbf/in ² / 375 HB	1.7225	4142	1.7223	4140
	High-alloy steel and high-alloy tool steel	P.3.1	Annealed	98600 lbf/in ² / 200 HB	1.4021	420	1.2379	D2
		P.3.2	Hardened and tempered	159500 lbf/in ² / 300 HB	1.2343	H11	1.3343	M2
		P.3.3	Hardened and tempered	188500 lbf/in ² / 400 HB	1.2343	H11	1.2363	A2
	Stainless steel	P.4.1	Ferritic / martensitic Annealed	98600 lbf/in ² / 200 HB	1.4016	430	1.4125	440C
		P.4.2	Martensitic Tempered	117500 lbf/in ² / 250 HB	1.4112	S44003	1.4021	420
M	Stainless steel	M.1.1	Austenitic / austenitic-ferritic Quenched	88500 lbf/in ² / 200 HB	1.4301	304	1.4401	316
		M.2.1	Austenitic Tempered	300 HB	1.4841	314	1.4568	17-7 PH
		M.3.1	Austenitic / ferritic (Duplex)	113100 lbf/in ² / 230 HB	1.4462	S32205	1.4410	S32750
K	Grey cast iron	K.1.1	Pearlitic / ferritic	88500 lbf/in ² / 180 HB	0.6010	A48-20B	0.6025	A48-40 B
		K.1.2	Pearlitic (martensitic)	127600 lbf/in ² / 260 HB	0.6030	A48-45B	0.6040	A48-60 B
	Spherulitic graphite cast iron	K.2.1	Ferritic	78300 lbf/in ² / 160 HB	0.7040	60-40-18	0.7050	65-45-12
		K.2.2	Pearlitic	122600 lbf/in ² / 250 HB	0.7070	100-70-03	0.7660	A439 Type D2
	Malleable iron	K.3.1	Ferritic	63800 lbf/in ² / 130 HB	0.8035	GTW-35-04		
		K.3.2	Pearlitic	113100 lbf/in ² / 230 HB	0.8170	70003		
N	Aluminium wrought alloy	N.1.1	Non-hardenable	60 HB	3.0255	A91060	3.0255	A91060
		N.1.2	Hardenable	49300 lbf/in ² / 100 HB	3.1355	2024	3.1355	2024
	Cast aluminium alloy	N.2.1	≤ 12 % Si, non-hardenable	36300 lbf/in ² / 75 HB	3.2581	A04130 / A413-0	3.2581	A04130 / A413-0
		N.2.2	≤ 12 % Si, hardenable	43500 lbf/in ² / 90 HB	3.2134	G-AISi5Cu1Mg		
		N.2.3	> 12 % Si, non-hardenable	63800 lbf/in ² / 130 HB		G-AISi17Cu4Mg		
	Copper and copper alloys (bronze/brass)	N.3.1	Free-machining alloys, PB > 1 %	54400 lbf/in ² / 110 HB	2.0380	CuZn39Pb2 (Ms58)	2.0380	C37700
		N.3.2	CuZn, CuSnZn	43500 lbf/in ² / 90 HB	2.0331	CuZn15	2.0331	C34000
		N.3.3	CuSn, lead-free copper and electrolytic copper	49300 lbf/in ² / 100 HB	2.0060	E-Cu57		
	Magnesium alloys	N.4.1	Magnesium and magnesium alloys	70 HB	3.5612	MgAl6Zn		
	S	Heat-resistant alloys	S.1.1	Fe - basis Annealed	98600 lbf/in ² / 200 HB	1.4864	X12NiCrSi 36-16	1.4864
S.1.2			Fe - basis	137800 lbf/in ² / 280 HB	1.4980	X6NiCrTiMoVB25-15-2	1.4980	S66286
S.2.1			Ni or Co basis Annealed	121800 lbf/in ² / 250 HB	2.4856	Inconel 625	2.4812	Hastelloy C
S.2.2			Ni or Co basis	171100 lbf/in ² / 350 HB	2.4952	Nimonic 80A	2.4668	Inconel 718
S.2.3			Cast	156600 lbf/in ² / 320 HB	2.4674	Nimocast PK24	2.4670	Nimocast 713
Titanium alloys		S.3.1	Pure titanium	5800 lbf/in ²	3.7025	Ti99,8		
		S.3.2	Alpha + beta alloys	152300 lbf/in ²	3.7165	TiAl6V4		
		S.3.3	Beta alloys	203100 lbf/in ² / 410 HB	Ti555.3	Ti-5Al-5V-5Mo-3Cr		
H	Hardened steel	H.1.1	Hardened and tempered	46-55 HRC				
		H.1.2	Hardened and tempered	56-60 HRC				
		H.1.3	Hardened and tempered	61-65 HRC				
		H.1.4	Hardened and tempered	66-70 HRC				
	Chilled iron	H.2.1	Cast	400 HB				
	Hardened cast iron	H.3.1	Hardened and tempered	55 HRC				
O	Non-metal materials	O.1.1	Plastics, duroplastic	≤ 21800 lbf/in ²				
		O.1.2	Plastics, thermoplastic	≤ 14500 lbf/in ²				
		O.2.1	Aramid fibre-reinforced	≤ 145000 lbf/in ²				
		O.2.2	Glass/carbon-fibre reinforced	≤ 145000 lbf/in ²				
		O.3.1	Graphite					

* Tensile Strength at Rupture (Rm)

Cutting Data – P220 – End Milling Cutter, short – long

59 003 ...												
Ø DC =			1/8"	3/16"	1/4–5/16"	3/8"	1/2"	5/8"	3/4"	● 1st choice ○ suitable		
			$a_{p1} \times DC$	$a_{p1} \times DC$	$a_{p1} \times DC$	$a_{p1} \times DC$	$a_{p1} \times DC$	$a_{p1} \times DC$	$a_{p1} \times DC$			
Index	V_c ft/min	$a_{pmax} \times DC$	f_z inch	f_z inch	f_z inch	f_z inch	f_z inch	f_z inch	f_z inch	Emulsion	Compressed air	MMS
P.1.1												
P.1.2												
P.1.3												
P.1.4												
P.1.5												
P.2.1												
P.2.2												
P.2.3												
P.2.4												
P.3.1												
P.3.2												
P.3.3												
P.4.1												
P.4.2												
M.1.1												
M.2.1												
M.3.1												
K.1.1												
K.1.2												
K.2.1												
K.2.2												
K.3.1												
K.3.2												
N.1.1	1970	1.0	0.0015	0.0019	0.0029	0.0036	0.0050	0.0053	0.0060	●	○	○
N.1.2	1970	1.0	0.0015	0.0019	0.0029	0.0036	0.0050	0.0053	0.0060	●	○	○
N.2.1	1180	1.0	0.0012	0.0015	0.0025	0.0031	0.0044	0.0047	0.0054	●	○	○
N.2.2	1180	1.0	0.0012	0.0015	0.0025	0.0031	0.0044	0.0047	0.0054	●	○	○
N.2.3	790	1.0	0.0012	0.0015	0.0025	0.0031	0.0044	0.0047	0.0054	●	○	○
N.3.1	790	1.0	0.0010	0.0013	0.0020	0.0026	0.0036	0.0039	0.0044	●	○	○
N.3.2	790	1.0	0.0010	0.0013	0.0020	0.0026	0.0036	0.0039	0.0044	●	○	○
N.3.3	560	1.0	0.0010	0.0013	0.0020	0.0026	0.0036	0.0039	0.0044	●	○	○
N.4.1	720	1.0	0.0012	0.0015	0.0025	0.0031	0.0044	0.0047	0.0054	●	○	○
S.1.1												
S.1.2												
S.2.1												
S.2.2												
S.2.3												
S.3.1												
S.3.2												
S.3.3												
H.1.1												
H.1.2												
H.1.3												
H.1.4												
H.2.1												
H.3.1												
O.1.1												
O.1.2												
O.2.1												
O.2.2												
O.3.1												

Cutting Data – S142 – End Milling Cutter, short – extra long

59 053 ... / 59 054 ...													
		Ø DC =									● 1st choice		
		5/32"	3/16"	1/4–5/16"	11/32–3/8"	1/2"	5/8"	3/4"	1"	○ suitable			
		a_p 1 x DC	a_p 1 x DC	a_p 1 x DC	a_p 1 x DC	a_p 1 x DC	a_p 1 x DC	a_p 1 x DC	a_p 1 x DC	a_p 1 x DC	Emulsion	Compressed air	MMS
Index	V_c ft/min	a_{pmax} x DC	f_z inch	f_z inch	f_z inch	f_z inch	f_z inch	f_z inch	f_z inch	f_z inch			
P.1.1													
P.1.2													
P.1.3													
P.1.4													
P.1.5													
P.2.1													
P.2.2													
P.2.3													
P.2.4													
P.3.1													
P.3.2													
P.3.3													
P.4.1													
P.4.2													
M.1.1													
M.2.1													
M.3.1													
K.1.1													
K.1.2													
K.2.1													
K.2.2													
K.3.1													
K.3.2													
N.1.1	980	1.0	0.0015	0.0019	0.0029	0.0036	0.0050	0.0053	0.0060	0.0069	●	○	○
N.1.2	980	1.0	0.0015	0.0019	0.0029	0.0036	0.0050	0.0053	0.0060	0.0069	●	○	○
N.2.1	590	1.0	0.0012	0.0015	0.0025	0.0031	0.0044	0.0047	0.0054	0.0062	●	○	○
N.2.2	590	1.0	0.0012	0.0015	0.0025	0.0031	0.0044	0.0047	0.0054	0.0062	●	○	○
N.2.3	390	1.0	0.0012	0.0015	0.0025	0.0031	0.0044	0.0047	0.0054	0.0062	●	○	○
N.3.1	390	1.0	0.0010	0.0013	0.0020	0.0026	0.0036	0.0039	0.0044	0.0050	●	○	○
N.3.2	390	1.0	0.0010	0.0013	0.0020	0.0026	0.0036	0.0039	0.0044	0.0050	●	○	○
N.3.3	280	1.0	0.0010	0.0013	0.0020	0.0026	0.0036	0.0039	0.0044	0.0050	●	○	○
N.4.1	360	1.0	0.0012	0.0015	0.0025	0.0031	0.0044	0.0047	0.0054	0.0062	●	○	○
S.1.1													
S.1.2													
S.2.1													
S.2.2													
S.2.3													
S.3.1													
S.3.2													
S.3.3													
H.1.1													
H.1.2													
H.1.3													
H.1.4													
H.2.1													
H.3.1													
O.1.1													
O.1.2													
O.2.1													
O.2.2													
O.3.1													

Cutting Data – P109 – End Milling Cutter, extra short – extra long

59 027 ...															
		Ø DC =													
		1/8–5/32"	3/16"	7/32"	1/4–9/32– 5/16"	3/8"	7/16"	1/2"	9/16–5/8"	3/4"	1"	● 1st choice	○ suitable		
		a_p 1 x DC	a_p 1 x DC	a_p 1 x DC	a_p 1 x DC	a_p 1 x DC	a_p 1 x DC	a_p 1 x DC	a_p 1 x DC	a_p 1 x DC	a_p 1 x DC	Emulsion	Compressed air	MMS	
Index	V_c ft/min	a_{pmax} x DC	f_z inch	f_z inch	f_z inch	f_z inch	f_z inch	f_z inch	f_z inch	f_z inch	f_z inch				
P.1.1															
P.1.2															
P.1.3															
P.1.4															
P.1.5															
P.2.1															
P.2.2															
P.2.3															
P.2.4															
P.3.1															
P.3.2															
P.3.3															
P.4.1															
P.4.2															
M.1.1															
M.2.1															
M.3.1															
K.1.1															
K.1.2															
K.2.1															
K.2.2															
K.3.1															
K.3.2															
N.1.1	1380	1.0	0.0012	0.0015	0.0019	0.0025	0.0031	0.0038	0.0044	0.0047	0.0054	0.0062	●	○	○
N.1.2	1380	1.0	0.0012	0.0015	0.0019	0.0025	0.0031	0.0038	0.0044	0.0047	0.0054	0.0062	●	○	○
N.2.1	830	1.0	0.0011	0.0014	0.0017	0.0023	0.0029	0.0035	0.0040	0.0043	0.0049	0.0056	●	○	○
N.2.2	830	1.0	0.0011	0.0014	0.0017	0.0023	0.0029	0.0035	0.0040	0.0043	0.0049	0.0056	●	○	○
N.2.3	550	1.0	0.0011	0.0014	0.0017	0.0023	0.0029	0.0035	0.0040	0.0043	0.0049	0.0056	●	○	○
N.3.1	550	1.0	0.0008	0.0011	0.0013	0.0017	0.0022	0.0026	0.0031	0.0033	0.0037	0.0043	●	○	○
N.3.2	550	1.0	0.0008	0.0011	0.0013	0.0017	0.0022	0.0026	0.0031	0.0033	0.0037	0.0043	●	○	○
N.3.3	390	1.0	0.0008	0.0011	0.0013	0.0017	0.0022	0.0026	0.0031	0.0033	0.0037	0.0043	●	○	○
N.4.1	510	1.0	0.0011	0.0014	0.0017	0.0023	0.0029	0.0035	0.0040	0.0043	0.0049	0.0056	●	○	○
S.1.1															
S.1.2															
S.2.1															
S.2.2															
S.2.3															
S.3.1															
S.3.2															
S.3.3															
H.1.1															
H.1.2															
H.1.3															
H.1.4															
H.2.1															
H.3.1															
O.1.1															
O.1.2															
O.2.1															
O.2.2															
O.3.1															

Cutting Data – P362 – End Milling Cutter, short – extra long

59 004 ...												
		Ø DC =								● 1st choice ○ suitable		
		3/16"	1/4"	3/8"	1/2"	5/8"	3/4"	1"				
		a_p 1 x DC	a_p 1 x DC	a_p 1 x DC	a_p 1 x DC	a_p 1 x DC	a_p 1 x DC	a_p 1 x DC				
Index	V_c ft/min	a_{pmax} x DC	f_z inch	f_z inch	f_z inch	f_z inch	f_z inch	f_z inch	f_z inch	Emulsion	Compressed air	MMS
P.1.1												
P.1.2												
P.1.3												
P.1.4												
P.1.5												
P.2.1												
P.2.2												
P.2.3												
P.2.4												
P.3.1												
P.3.2												
P.3.3												
P.4.1												
P.4.2												
M.1.1												
M.2.1												
M.3.1												
K.1.1												
K.1.2												
K.2.1												
K.2.2												
K.3.1												
K.3.2												
N.1.1	1970	1.0	0.0015	0.0025	0.0031	0.0044	0.0047	0.0054	0.0062	●	○	○
N.1.2	1970	1.0	0.0015	0.0025	0.0031	0.0044	0.0047	0.0054	0.0062	●	○	○
N.2.1	1180	1.0	0.0014	0.0023	0.0029	0.0040	0.0043	0.0049	0.0056	●	○	○
N.2.2	1180	1.0	0.0014	0.0023	0.0029	0.0040	0.0043	0.0049	0.0056	●	○	○
N.2.3	790	1.0	0.0014	0.0023	0.0029	0.0040	0.0043	0.0049	0.0056	●	○	○
N.3.1	790	1.0	0.0011	0.0017	0.0022	0.0031	0.0033	0.0037	0.0043	●	○	○
N.3.2	790	1.0	0.0011	0.0017	0.0022	0.0031	0.0033	0.0037	0.0043	●	○	○
N.3.3	560	1.0	0.0011	0.0017	0.0022	0.0031	0.0033	0.0037	0.0043	●	○	○
N.4.1	720	1.0	0.0014	0.0023	0.0029	0.0040	0.0043	0.0049	0.0056	●	○	○
S.1.1												
S.1.2												
S.2.1												
S.2.2												
S.2.3												
S.3.1												
S.3.2												
S.3.3												
H.1.1												
H.1.2												
H.1.3												
H.1.4												
H.2.1												
H.3.1												
O.1.1												
O.1.2												
O.2.1												
O.2.2												
O.3.1												

Cutting Data – P376 – End Milling Cutter, short – extra long

59 005 ...											
		Ø DC =							<input checked="" type="radio"/> 1st choice <input type="radio"/> suitable		
		1/4–5/16"	3/8"	1/2"	5/8"	3/4"	1"				
		a_p 1 x DC	a_p 1 x DC	a_p 1 x DC	a_p 1 x DC	a_p 1 x DC	a_p 1 x DC				
Index	V_c ft/min	a_{pmax} x DC	f_z inch	f_z inch	f_z inch	f_z inch	f_z inch	f_z inch	Emulsion	Compressed air	MMS
P.1.1											
P.1.2											
P.1.3											
P.1.4											
P.1.5											
P.2.1											
P.2.2											
P.2.3											
P.2.4											
P.3.1											
P.3.2											
P.3.3											
P.4.1											
P.4.2											
M.1.1											
M.2.1											
M.3.1											
K.1.1											
K.1.2											
K.2.1											
K.2.2											
K.3.1											
K.3.2											
N.1.1	1640	1.0	0.0012	0.0015	0.0020	0.0022	0.0024	0.0028	●	○	○
N.1.2	1640	1.0	0.0012	0.0015	0.0020	0.0022	0.0024	0.0028	●	○	○
N.2.1	980	1.0	0.0009	0.0012	0.0017	0.0018	0.0020	0.0023	●	○	○
N.2.2	980	1.0	0.0009	0.0012	0.0017	0.0018	0.0020	0.0023	●	○	○
N.2.3	690	1.0	0.0009	0.0012	0.0017	0.0018	0.0020	0.0023	●	○	○
N.3.1	690	1.0	0.0009	0.0012	0.0017	0.0018	0.0020	0.0023	●	○	○
N.3.2	690	1.0	0.0009	0.0012	0.0017	0.0018	0.0020	0.0023	●	○	○
N.3.3	490	1.0	0.0009	0.0012	0.0017	0.0018	0.0020	0.0023	●	○	○
N.4.1	660	1.0	0.0009	0.0012	0.0017	0.0018	0.0020	0.0023	●	○	○
S.1.1											
S.1.2											
S.2.1											
S.2.2											
S.2.3											
S.3.1											
S.3.2											
S.3.3											
H.1.1											
H.1.2											
H.1.3											
H.1.4											
H.2.1											
H.3.1											
O.1.1											
O.1.2											
O.2.1											
O.2.2											
O.3.1											

Cutting Data – S642 – End Milling Cutter, extra short – extra long

59 068... / 59 069 ...																	
Ø DC =			1/16"	3/32"	1/8–5/32"	3/16"	7/32"	1/4–9/32–5/16"	3/8"	1/2"	5/8"	3/4"	1"	● 1st choice	○ suitable		
			a_p 1 x DC	a_p 1 x DC	a_p 1 x DC	a_p 1 x DC	a_p 1 x DC	a_p 1 x DC	a_p 1 x DC	a_p 1 x DC	a_p 1 x DC	a_p 1 x DC	a_p 1 x DC	Emulsion	Compressed air	MMS	
Index	v_c ft/min	a_{pmax} x DC	f_z inch	f_z inch	f_z inch	f_z inch	f_z inch	f_z inch	f_z inch	f_z inch	f_z inch	f_z inch	f_z inch				
P.1.1	220	1.0	0.0006	0.0007	0.0008	0.0010	0.0011	0.0014	0.0017	0.0023	0.0024	0.0027	0.0031	●	○	○	
P.1.2	180	1.0	0.0004	0.0005	0.0007	0.0008	0.0009	0.0012	0.0015	0.0020	0.0022	0.0024	0.0028	●	○	○	
P.1.3	180	1.0	0.0004	0.0005	0.0007	0.0008	0.0009	0.0012	0.0015	0.0020	0.0022	0.0024	0.0028	●	○	○	
P.1.4	160	1.0	0.0004	0.0005	0.0007	0.0008	0.0009	0.0012	0.0015	0.0020	0.0022	0.0024	0.0028	●	○	○	
P.1.5	160	1.0	0.0004	0.0005	0.0007	0.0008	0.0009	0.0012	0.0015	0.0020	0.0022	0.0024	0.0028	●	○	○	
P.2.1	180	1.0	0.0004	0.0005	0.0007	0.0008	0.0009	0.0012	0.0015	0.0020	0.0022	0.0024	0.0028	●	○	○	
P.2.2	140	1.0	0.0004	0.0005	0.0007	0.0008	0.0009	0.0012	0.0015	0.0020	0.0022	0.0024	0.0028	●	○	○	
P.2.3	140	1.0	0.0004	0.0005	0.0007	0.0008	0.0009	0.0012	0.0015	0.0020	0.0022	0.0024	0.0028	●	○	○	
P.2.4	110	1.0	0.0004	0.0005	0.0007	0.0008	0.0009	0.0012	0.0015	0.0020	0.0022	0.0024	0.0028	●	○	○	
P.3.1																	
P.3.2																	
P.3.3																	
P.4.1	98	1.0	0.0003	0.0004	0.0006	0.0007	0.0008	0.0011	0.0013	0.0018	0.0019	0.0022	0.0025	●			
P.4.2	79	1.0	0.0003	0.0004	0.0006	0.0007	0.0008	0.0011	0.0013	0.0018	0.0019	0.0022	0.0025	●			
M.1.1	79	1.0	0.0003	0.0004	0.0006	0.0007	0.0008	0.0011	0.0013	0.0018	0.0019	0.0022	0.0025	●			
M.2.1	98	1.0	0.0003	0.0004	0.0006	0.0007	0.0008	0.0011	0.0013	0.0018	0.0019	0.0022	0.0025	●			
M.3.1	98	1.0	0.0003	0.0004	0.0006	0.0007	0.0008	0.0011	0.0013	0.0018	0.0019	0.0022	0.0025	●			
K.1.1	260	1.0	0.0009	0.0011	0.0013	0.0016	0.0018	0.0023	0.0028	0.0037	0.0039	0.0044	0.0050	●	○	○	
K.1.2	240	1.0	0.0009	0.0011	0.0013	0.0016	0.0018	0.0023	0.0028	0.0037	0.0039	0.0044	0.0050	●	○	○	
K.2.1	260	1.0	0.0006	0.0008	0.0009	0.0011	0.0013	0.0016	0.0019	0.0025	0.0026	0.0030	0.0033	●	○	○	
K.2.2	240	1.0	0.0006	0.0008	0.0009	0.0011	0.0013	0.0016	0.0019	0.0025	0.0026	0.0030	0.0033	●	○	○	
K.3.1	260	1.0	0.0009	0.0011	0.0013	0.0016	0.0018	0.0023	0.0028	0.0037	0.0039	0.0044	0.0050	●	○	○	
K.3.2	240	1.0	0.0009	0.0011	0.0013	0.0016	0.0018	0.0023	0.0028	0.0037	0.0039	0.0044	0.0050	●	○	○	
N.1.1																	
N.1.2																	
N.2.1																	
N.2.2																	
N.2.3																	
N.3.1	390	1.0	0.0006	0.0008	0.0010	0.0012	0.0014	0.0018	0.0022	0.0030	0.0031	0.0035	0.0040	●	○	○	
N.3.2	390	1.0	0.0006	0.0008	0.0010	0.0012	0.0014	0.0018	0.0022	0.0030	0.0031	0.0035	0.0040	●	○	○	
N.3.3	280	1.0	0.0006	0.0008	0.0010	0.0012	0.0014	0.0018	0.0022	0.0030	0.0031	0.0035	0.0040	●	○	○	
N.4.1																	
S.1.1	59	1.0	0.0002	0.0003	0.0004	0.0005	0.0006	0.0008	0.0010	0.0014	0.0015	0.0017	0.0019	●			
S.1.2	59	1.0	0.0002	0.0003	0.0004	0.0005	0.0006	0.0008	0.0010	0.0014	0.0015	0.0017	0.0019	●			
S.2.1	59	1.0	0.0002	0.0003	0.0004	0.0005	0.0006	0.0008	0.0010	0.0014	0.0015	0.0017	0.0019	●			
S.2.2	59	1.0	0.0002	0.0003	0.0004	0.0005	0.0006	0.0008	0.0010	0.0014	0.0015	0.0017	0.0019	●			
S.2.3	59	1.0	0.0002	0.0003	0.0004	0.0005	0.0006	0.0008	0.0010	0.0014	0.0015	0.0017	0.0019	●			
S.3.1	98	1.0	0.0003	0.0004	0.0006	0.0007	0.0008	0.0011	0.0013	0.0018	0.0019	0.0022	0.0025	●			
S.3.2	39	1.0	0.0003	0.0004	0.0006	0.0007	0.0008	0.0011	0.0013	0.0018	0.0019	0.0022	0.0025	●			
S.3.3																	
H.1.1																	
H.1.2																	
H.1.3																	
H.1.4																	
H.2.1																	
H.3.1																	
O.1.1																	
O.1.2																	
O.2.1																	
O.2.2																	
O.3.1																	

Cutting Data – S643 – End-Milling-Cutter, extra short – extra long

59 070... / 59 071 ...																	
Ø DC =			1/16– 5/64"	3/32"	1/8– 5/32"	3/16"	7/32"	1/4–9/32 –5/16"	3/8"	1/2"	5/8"	3/4"	1"	● 1st choice	○ suitable		
			a _e 1 x DC	a _e 1 x DC	a _e 1 x DC	a _e 1 x DC	a _e 1 x DC	a _e 1 x DC	a _e 1 x DC	a _e 1 x DC	a _e 1 x DC	a _e 1 x DC	a _e 1 x DC	Emulsion	Compressed air	MMS	
Index	V _c ft/min	a _{pmax} x DC	f _z inch	f _z inch	f _z inch	f _z inch	f _z inch	f _z inch	f _z inch	f _z inch	f _z inch	f _z inch	f _z inch				
P.1.1	220	1.0	0.0004	0.0005	0.0007	0.0008	0.0009	0.0012	0.0015	0.0020	0.0022	0.0024	0.0028	●	○	○	
P.1.2	180	1.0	0.0003	0.0004	0.0006	0.0007	0.0008	0.0011	0.0013	0.0018	0.0019	0.0022	0.0025	●	○	○	
P.1.3	180	1.0	0.0003	0.0004	0.0006	0.0007	0.0008	0.0011	0.0013	0.0018	0.0019	0.0022	0.0025	●	○	○	
P.1.4	160	1.0	0.0003	0.0004	0.0006	0.0007	0.0008	0.0011	0.0013	0.0018	0.0019	0.0022	0.0025	●	○	○	
P.1.5	160	1.0	0.0003	0.0004	0.0006	0.0007	0.0008	0.0011	0.0013	0.0018	0.0019	0.0022	0.0025	●	○	○	
P.2.1	180	1.0	0.0003	0.0004	0.0006	0.0007	0.0008	0.0011	0.0013	0.0018	0.0019	0.0022	0.0025	●	○	○	
P.2.2	140	1.0	0.0003	0.0004	0.0006	0.0007	0.0008	0.0011	0.0013	0.0018	0.0019	0.0022	0.0025	●	○	○	
P.2.3	140	1.0	0.0003	0.0004	0.0006	0.0007	0.0008	0.0011	0.0013	0.0018	0.0019	0.0022	0.0025	●	○	○	
P.2.4	110	1.0	0.0003	0.0004	0.0006	0.0007	0.0008	0.0011	0.0013	0.0018	0.0019	0.0022	0.0025	●	○	○	
P.3.1																	
P.3.2																	
P.3.3																	
P.4.1	100	1.0	0.0002	0.0003	0.0004	0.0005	0.0006	0.0008	0.0010	0.0014	0.0015	0.0017	0.0019	●			
P.4.2	80	1.0	0.0002	0.0003	0.0004	0.0005	0.0006	0.0008	0.0010	0.0014	0.0015	0.0017	0.0019	●			
M.1.1	79	1.0	0.0002	0.0003	0.0004	0.0005	0.0006	0.0008	0.0010	0.0014	0.0015	0.0017	0.0019	●			
M.2.1	98	1.0	0.0002	0.0003	0.0004	0.0005	0.0006	0.0008	0.0010	0.0014	0.0015	0.0017	0.0019	●			
M.3.1	98	1.0	0.0002	0.0003	0.0004	0.0005	0.0006	0.0008	0.0010	0.0014	0.0015	0.0017	0.0019	●			
K.1.1	260	1.0	0.0007	0.0009	0.0011	0.0013	0.0015	0.0020	0.0024	0.0033	0.0035	0.0039	0.0045	●	○	○	
K.1.2	240	1.0	0.0007	0.0009	0.0011	0.0013	0.0015	0.0020	0.0024	0.0033	0.0035	0.0039	0.0045	●	○	○	
K.2.1	260	1.0	0.0006	0.0007	0.0008	0.0010	0.0011	0.0014	0.0017	0.0023	0.0024	0.0027	0.0031	●	○	○	
K.2.2	240	1.0	0.0006	0.0007	0.0008	0.0010	0.0011	0.0014	0.0017	0.0023	0.0024	0.0027	0.0031	●	○	○	
K.3.1	260	1.0	0.0007	0.0009	0.0011	0.0013	0.0015	0.0020	0.0024	0.0033	0.0035	0.0039	0.0045	●	○	○	
K.3.2	240	1.0	0.0007	0.0009	0.0011	0.0013	0.0015	0.0020	0.0024	0.0033	0.0035	0.0039	0.0045	●	○	○	
N.1.1																	
N.1.2																	
N.2.1																	
N.2.2																	
N.2.3																	
N.3.1	390	1.0	0.0004	0.0006	0.0007	0.0010	0.0012	0.0016	0.0020	0.0028	0.0030	0.0033	0.0039	●	○	○	
N.3.2	390	1.0	0.0004	0.0006	0.0007	0.0010	0.0012	0.0016	0.0020	0.0028	0.0030	0.0033	0.0039	●	○	○	
N.3.3	280	1.0	0.0004	0.0006	0.0007	0.0010	0.0012	0.0016	0.0020	0.0028	0.0030	0.0033	0.0039	●	○	○	
N.4.1																	
S.1.1	59	1.0	0.0002	0.0003	0.0004	0.0005	0.0006	0.0008	0.0010	0.0014	0.0015	0.0017	0.0019	●			
S.1.2	59	1.0	0.0002	0.0003	0.0004	0.0005	0.0006	0.0008	0.0010	0.0014	0.0015	0.0017	0.0019	●			
S.2.1	59	1.0	0.0002	0.0003	0.0004	0.0005	0.0006	0.0008	0.0010	0.0014	0.0015	0.0017	0.0019	●			
S.2.2	59	1.0	0.0002	0.0003	0.0004	0.0005	0.0006	0.0008	0.0010	0.0014	0.0015	0.0017	0.0019	●			
S.2.3	59	1.0	0.0002	0.0003	0.0004	0.0005	0.0006	0.0008	0.0010	0.0014	0.0015	0.0017	0.0019	●			
S.3.1	98	1.0	0.0002	0.0003	0.0004	0.0005	0.0006	0.0008	0.0010	0.0014	0.0015	0.0017	0.0019	●			
S.3.2	39	1.0	0.0002	0.0003	0.0004	0.0005	0.0006	0.0008	0.0010	0.0014	0.0015	0.0017	0.0019	●			
S.3.3																	
H.1.1																	
H.1.2																	
H.1.3																	
H.1.4																	
H.2.1																	
H.3.1																	
O.1.1																	
O.1.2																	
O.2.1																	
O.2.2																	
O.3.1																	

Cutting Data – P645 – End Milling Cutter, short – extra long

59 074 ... / 59 075 ...															
Ø DC =			1/8–5/32"	3/16"	7/32"	1/4–5/16"	3/8"	1/2"	5/8"	3/4"	1"	● 1st choice	○ suitable		
			a _p 1 x DC	a _p 1 x DC	a _p 1 x DC	a _p 1 x DC	a _p 1 x DC	a _p 1 x DC	a _p 1 x DC	a _p 1 x DC	a _p 1 x DC	Emulsion	Compressed air	MMS	
Index	V _c ft/min	a _{pmax} x DC	f _z inch	f _z inch	f _z inch	f _z inch	f _z inch	f _z inch	f _z inch	f _z inch	f _z inch				
P.1.1	410	1.0	0.0007	0.0010	0.0012	0.0016	0.0020	0.0028	0.0030	0.0033	0.0039	●	○	○	
P.1.2	390	1.0	0.0007	0.0010	0.0012	0.0016	0.0020	0.0028	0.0030	0.0033	0.0039	●	○	○	
P.1.3	390	1.0	0.0007	0.0010	0.0012	0.0016	0.0020	0.0028	0.0030	0.0033	0.0039	●	○	○	
P.1.4	370	1.0	0.0007	0.0010	0.0012	0.0016	0.0020	0.0028	0.0030	0.0033	0.0039	●	○	○	
P.1.5	370	1.0	0.0007	0.0010	0.0012	0.0016	0.0020	0.0028	0.0030	0.0033	0.0039	●	○	○	
P.2.1	390	1.0	0.0007	0.0010	0.0012	0.0016	0.0020	0.0028	0.0030	0.0033	0.0039	●	○	○	
P.2.2	370	1.0	0.0006	0.0007	0.0009	0.0012	0.0015	0.0022	0.0023	0.0026	0.0030	●	○	○	
P.2.3	350	1.0	0.0007	0.0010	0.0012	0.0016	0.0020	0.0028	0.0030	0.0033	0.0039	●	○	○	
P.2.4	330	1.0	0.0006	0.0007	0.0009	0.0012	0.0015	0.0022	0.0023	0.0026	0.0030	●	○	○	
P.3.1	350	1.0	0.0007	0.0010	0.0012	0.0016	0.0020	0.0028	0.0030	0.0033	0.0039	●	○	○	
P.3.2	330	1.0	0.0007	0.0010	0.0012	0.0016	0.0020	0.0028	0.0030	0.0033	0.0039	●	○	○	
P.3.3	280	1.0	0.0007	0.0010	0.0012	0.0016	0.0020	0.0028	0.0030	0.0033	0.0039	●	○	○	
P.4.1	200	1.0	0.0005	0.0006	0.0007	0.0010	0.0013	0.0019	0.0020	0.0023	0.0026	●			
P.4.2	160	1.0	0.0005	0.0006	0.0007	0.0010	0.0013	0.0019	0.0020	0.0023	0.0026	●			
M.1.1	200	1.0	0.0005	0.0006	0.0007	0.0010	0.0013	0.0019	0.0020	0.0023	0.0026	●			
M.2.1	200	1.0	0.0005	0.0006	0.0007	0.0010	0.0013	0.0019	0.0020	0.0023	0.0026	●			
M.3.1	200	1.0	0.0005	0.0006	0.0007	0.0010	0.0013	0.0019	0.0020	0.0023	0.0026	●			
K.1.1	390	1.0	0.0009	0.0012	0.0014	0.0019	0.0023	0.0032	0.0034	0.0039	0.0044	●	○	○	
K.1.2	350	1.0	0.0009	0.0012	0.0014	0.0019	0.0023	0.0032	0.0034	0.0039	0.0044	●	○	○	
K.2.1	370	1.0	0.0007	0.0010	0.0012	0.0016	0.0020	0.0028	0.0030	0.0033	0.0039	●	○	○	
K.2.2	330	1.0	0.0007	0.0010	0.0012	0.0016	0.0020	0.0028	0.0030	0.0033	0.0039	●	○	○	
K.3.1	350	1.0	0.0007	0.0010	0.0012	0.0016	0.0020	0.0028	0.0030	0.0033	0.0039	●	○	○	
K.3.2	310	1.0	0.0007	0.0010	0.0012	0.0016	0.0020	0.0028	0.0030	0.0033	0.0039	●	○	○	
N.1.1															
N.1.2															
N.2.1															
N.2.2															
N.2.3															
N.3.1															
N.3.2															
N.3.3															
N.4.1															
S.1.1															
S.1.2															
S.2.1															
S.2.2															
S.2.3															
S.3.1															
S.3.2															
S.3.3															
H.1.1															
H.1.2															
H.1.3															
H.1.4															
H.2.1															
H.3.1															
O.1.1															
O.1.2															
O.2.1															
O.2.2															
O.3.1															

Cutting Data – P007 – High Performance End Milling Cutter, short – extra long

59 002 ...													
Ø DC =			1/8"	3/16"	1/4–5/16"	3/8"	1/2"	5/8"	3/4"	1"	● 1st choice	○ suitable	
			a_p 1 x DC	a_p 1 x DC	a_p 1 x DC	a_p 1 x DC	a_p 1 x DC	a_p 1 x DC	a_p 1 x DC	a_p 1 x DC			
Index	V_c ft/min	a_{pmax} x DC	f_z inch	f_z inch	f_z inch	f_z inch	f_z inch	f_z inch	f_z inch	f_z inch	Emulsion	Compressed air	MMS
P.1.1	750	1.0	0.0009	0.0012	0.0019	0.0023	0.0032	0.0034	0.0039	0.0044	●	○	○
P.1.2	720	1.0	0.0009	0.0012	0.0019	0.0023	0.0032	0.0034	0.0039	0.0044	●	○	○
P.1.3	720	1.0	0.0009	0.0012	0.0019	0.0023	0.0032	0.0034	0.0039	0.0044	●	○	○
P.1.4	690	1.0	0.0009	0.0012	0.0019	0.0023	0.0032	0.0034	0.0039	0.0044	●	○	○
P.1.5	690	1.0	0.0009	0.0012	0.0019	0.0023	0.0032	0.0034	0.0039	0.0044	●	○	○
P.2.1	720	1.0	0.0009	0.0012	0.0019	0.0023	0.0032	0.0034	0.0039	0.0044	●	○	○
P.2.2	690	1.0	0.0007	0.0010	0.0016	0.0020	0.0028	0.0030	0.0033	0.0039	●	○	○
P.2.3	660	1.0	0.0009	0.0012	0.0019	0.0023	0.0032	0.0034	0.0039	0.0044	●	○	○
P.2.4	620	1.0	0.0007	0.0010	0.0016	0.0020	0.0028	0.0030	0.0033	0.0039	●	○	○
P.3.1	660	1.0	0.0009	0.0012	0.0019	0.0023	0.0032	0.0034	0.0039	0.0044	●	○	○
P.3.2	620	1.0	0.0009	0.0012	0.0019	0.0023	0.0032	0.0034	0.0039	0.0044	●	○	○
P.3.3	520	1.0	0.0009	0.0012	0.0019	0.0023	0.0032	0.0034	0.0039	0.0044	●	○	○
P.4.1	360	1.0	0.0005	0.0006	0.0010	0.0013	0.0019	0.0020	0.0023	0.0026	●		
P.4.2	300	1.0	0.0005	0.0006	0.0010	0.0013	0.0019	0.0020	0.0023	0.0026	●		
M.1.1	360	1.0	0.0005	0.0006	0.0010	0.0013	0.0019	0.0020	0.0023	0.0026	●		
M.2.1	360	1.0	0.0005	0.0006	0.0010	0.0013	0.0019	0.0020	0.0023	0.0026	●		
M.3.1	360	1.0	0.0005	0.0006	0.0010	0.0013	0.0019	0.0020	0.0023	0.0026	●		
K.1.1	720	1.0	0.0012	0.0015	0.0025	0.0031	0.0044	0.0047	0.0054	0.0062	●	○	○
K.1.2	660	1.0	0.0012	0.0015	0.0025	0.0031	0.0044	0.0047	0.0054	0.0062	●	○	○
K.2.1	690	1.0	0.0009	0.0012	0.0019	0.0023	0.0032	0.0034	0.0039	0.0044	●	○	○
K.2.2	620	1.0	0.0009	0.0012	0.0019	0.0023	0.0032	0.0034	0.0039	0.0044	●	○	○
K.3.1	660	1.0	0.0009	0.0012	0.0019	0.0023	0.0032	0.0034	0.0039	0.0044	●	○	○
K.3.2	590	1.0	0.0009	0.0012	0.0019	0.0023	0.0032	0.0034	0.0039	0.0044	●	○	○
N.1.1													
N.1.2													
N.2.1													
N.2.2													
N.2.3													
N.3.1	1150	1.0	0.0012	0.0015	0.0025	0.0031	0.0044	0.0047	0.0054	0.0062	●	○	○
N.3.2	1150	1.0	0.0012	0.0015	0.0025	0.0031	0.0044	0.0047	0.0054	0.0062	●	○	○
N.3.3	920	1.0	0.0012	0.0015	0.0025	0.0031	0.0044	0.0047	0.0054	0.0062	●	○	○
N.4.1													
S.1.1	98	1.0	0.0004	0.0005	0.0008	0.0010	0.0014	0.0015	0.0017	0.0019	●		
S.1.2	98	1.0	0.0004	0.0005	0.0008	0.0010	0.0014	0.0015	0.0017	0.0019	●		
S.2.1	98	1.0	0.0004	0.0005	0.0008	0.0010	0.0014	0.0015	0.0017	0.0019	●		
S.2.2	98	1.0	0.0004	0.0005	0.0008	0.0010	0.0014	0.0015	0.0017	0.0019	●		
S.2.3	98	1.0	0.0004	0.0005	0.0008	0.0010	0.0014	0.0015	0.0017	0.0019	●		
S.3.1	300	1.0	0.0007	0.0010	0.0016	0.0020	0.0028	0.0030	0.0033	0.0039	●		
S.3.2													
S.3.3													
H.1.1													
H.1.2													
H.1.3													
H.1.4													
H.2.1													
H.3.1													
O.1.1													
O.1.2													
O.2.1													
O.2.2													
O.3.1													

Cutting Data – P556 – High Performance End milling cutter, short – extra long

59 006 ...											
Ø DC =			1/4"	3/8"	1/2"	5/8"	3/4"	1"	● 1st choice ○ suitable		
			a_p 1 x DC	a_p 1 x DC	a_p 1 x DC	a_p 1 x DC	a_p 1 x DC	a_p 1 x DC	Emulsion	Compressed air	MMS
Index	V_c ft/min	a_{pmax} x DC	f_z inch	f_z inch	f_z inch	f_z inch	f_z inch	f_z inch			
P.1.1	690	1.0	0.0016	0.0020	0.0028	0.0030	0.0033	0.0039	●	○	○
P.1.2	660	1.0	0.0016	0.0020	0.0028	0.0030	0.0033	0.0039	●	○	○
P.1.3	660	1.0	0.0016	0.0020	0.0028	0.0030	0.0033	0.0039	●	○	○
P.1.4	620	1.0	0.0016	0.0020	0.0028	0.0030	0.0033	0.0039	●	○	○
P.1.5	620	1.0	0.0016	0.0020	0.0028	0.0030	0.0033	0.0039	●	○	○
P.2.1	660	1.0	0.0016	0.0020	0.0028	0.0030	0.0033	0.0039	●	○	○
P.2.2	620	1.0	0.0012	0.0015	0.0022	0.0023	0.0026	0.0030	●	○	○
P.2.3	590	1.0	0.0016	0.0020	0.0028	0.0030	0.0033	0.0039	●	○	○
P.2.4	560	1.0	0.0012	0.0015	0.0022	0.0023	0.0026	0.0030	●	○	○
P.3.1	590	1.0	0.0016	0.0020	0.0028	0.0030	0.0033	0.0039	●	○	○
P.3.2	560	1.0	0.0016	0.0020	0.0028	0.0030	0.0033	0.0039	●	○	○
P.3.3	460	1.0	0.0016	0.0020	0.0028	0.0030	0.0033	0.0039	●	○	○
P.4.1	330	1.0	0.0010	0.0013	0.0019	0.0020	0.0023	0.0026	●		
P.4.2	260	1.0	0.0010	0.0013	0.0019	0.0020	0.0023	0.0026	●		
M.1.1	330	1.0	0.0010	0.0013	0.0019	0.0020	0.0023	0.0026	●		
M.2.1	330	1.0	0.0010	0.0013	0.0019	0.0020	0.0023	0.0026	●		
M.3.1	330	1.0	0.0010	0.0013	0.0019	0.0020	0.0023	0.0026	●		
K.1.1	660	1.0	0.0019	0.0023	0.0032	0.0034	0.0039	0.0044	●	○	○
K.1.2	590	1.0	0.0019	0.0023	0.0032	0.0034	0.0039	0.0044	●	○	○
K.2.1	620	1.0	0.0016	0.0020	0.0028	0.0030	0.0033	0.0039	●	○	○
K.2.2	560	1.0	0.0016	0.0020	0.0028	0.0030	0.0033	0.0039	●	○	○
K.3.1	590	1.0	0.0016	0.0020	0.0028	0.0030	0.0033	0.0039	●	○	○
K.3.2	520	1.0	0.0016	0.0020	0.0028	0.0030	0.0033	0.0039	●	○	○
N.1.1											
N.1.2											
N.2.1											
N.2.2											
N.2.3											
N.3.1											
N.3.2											
N.3.3											
N.4.1											
S.1.1	180	1.0	0.0012	0.0015	0.0022	0.0023	0.0026	0.0030	●		
S.1.2	180	1.0	0.0012	0.0015	0.0022	0.0023	0.0026	0.0030	●		
S.2.1	180	1.0	0.0012	0.0015	0.0022	0.0023	0.0026	0.0030	●		
S.2.2	180	1.0	0.0012	0.0015	0.0022	0.0023	0.0026	0.0030	●		
S.2.3	180	1.0	0.0012	0.0015	0.0022	0.0023	0.0026	0.0030	●		
S.3.1	390	1.0	0.0019	0.0023	0.0032	0.0034	0.0039	0.0044	●		
S.3.2	260	1.0	0.0012	0.0015	0.0022	0.0023	0.0026	0.0030	●		
S.3.3											
H.1.1											
H.1.2											
H.1.3											
H.1.4											
H.2.1											
H.3.1											
O.1.1											
O.1.2											
O.2.1											
O.2.2											
O.3.1											

Cutting Data – P160 / P161 – Multi-flute milling cutter, short – extra long

59 041 ... / 59 042 ...											
Ø DC =			1/4"	3/8"	1/2"	5/8"	3/4"	1"	● 1st choice ○ suitable		
			a_p 1 x DC	a_p 1 x DC	a_p 1 x DC	a_p 1 x DC	a_p 1 x DC	a_p 1 x DC	Emulsion	Compressed air	MMS
Index	v_c ft/min	a_{pmax} x DC	f_z inch	f_z inch	f_z inch	f_z inch	f_z inch	f_z inch			
P.1.1	850	1.0	0.0016	0.0020	0.0028	0.0030	0.0033	0.0039	●	○	○
P.1.2	820	1.0	0.0016	0.0020	0.0028	0.0030	0.0033	0.0039	●	○	○
P.1.3	820	1.0	0.0016	0.0020	0.0028	0.0030	0.0033	0.0039	●	○	○
P.1.4	750	1.0	0.0016	0.0020	0.0028	0.0030	0.0033	0.0039	●	○	○
P.1.5	750	1.0	0.0016	0.0020	0.0028	0.0030	0.0033	0.0039	●	○	○
P.2.1	820	1.0	0.0016	0.0020	0.0028	0.0030	0.0033	0.0039	●	○	○
P.2.2	750	1.0	0.0012	0.0015	0.0022	0.0023	0.0026	0.0030	●	○	○
P.2.3	720	1.0	0.0016	0.0020	0.0028	0.0030	0.0033	0.0039	●	○	○
P.2.4	690	1.0	0.0012	0.0015	0.0022	0.0023	0.0026	0.0030	●	○	○
P.3.1	720	1.0	0.0016	0.0020	0.0028	0.0030	0.0033	0.0039	●	○	○
P.3.2	690	1.0	0.0016	0.0020	0.0028	0.0030	0.0033	0.0039	●	○	○
P.3.3	570	1.0	0.0016	0.0020	0.0028	0.0030	0.0033	0.0039	●	○	○
P.4.1	390	1.0	0.0010	0.0013	0.0019	0.0020	0.0023	0.0026	●		
P.4.2	330	1.0	0.0010	0.0013	0.0019	0.0020	0.0023	0.0026	●		
M.1.1	390	1.0	0.0010	0.0013	0.0019	0.0020	0.0023	0.0026	●		
M.2.1	390	1.0	0.0010	0.0013	0.0019	0.0020	0.0023	0.0026	●		
M.3.1	390	1.0	0.0010	0.0013	0.0019	0.0020	0.0023	0.0026	●		
K.1.1	820	1.0	0.0019	0.0023	0.0032	0.0034	0.0039	0.0044	●	○	○
K.1.2	720	1.0	0.0019	0.0023	0.0032	0.0034	0.0039	0.0044	●	○	○
K.2.1	750	1.0	0.0016	0.0020	0.0028	0.0030	0.0033	0.0039	●	○	○
K.2.2	690	1.0	0.0016	0.0020	0.0028	0.0030	0.0033	0.0039	●	○	○
K.3.1	720	1.0	0.0016	0.0020	0.0028	0.0030	0.0033	0.0039	●	○	○
K.3.2	660	1.0	0.0016	0.0020	0.0028	0.0030	0.0033	0.0039	●	○	○
N.1.1											
N.1.2											
N.2.1											
N.2.2											
N.2.3											
N.3.1	1410	1.0	0.0019	0.0023	0.0032	0.0034	0.0039	0.0044	●	○	○
N.3.2	1410	1.0	0.0019	0.0023	0.0032	0.0034	0.0039	0.0044	●	○	○
N.3.3	1150	1.0	0.0019	0.0023	0.0032	0.0034	0.0039	0.0044	●	○	○
N.4.1											
S.1.1	130	1.0	0.0008	0.0010	0.0014	0.0015	0.0017	0.0019	●		
S.1.2	130	1.0	0.0008	0.0010	0.0014	0.0015	0.0017	0.0019	●		
S.2.1	130	1.0	0.0008	0.0010	0.0014	0.0015	0.0017	0.0019	●		
S.2.2	130	1.0	0.0008	0.0010	0.0014	0.0015	0.0017	0.0019	●		
S.2.3	130	1.0	0.0008	0.0010	0.0014	0.0015	0.0017	0.0019	●		
S.3.1	660	1.0	0.0016	0.0020	0.0028	0.0030	0.0033	0.0039	●		
S.3.2	410	1.0	0.0010	0.0013	0.0019	0.0020	0.0023	0.0026	●		
S.3.3											
H.1.1											
H.1.2											
H.1.3											
H.1.4											
H.2.1											
H.3.1											
O.1.1											
O.1.2											
O.2.1											
O.2.2											
O.3.1											

Cutting Data – P130 – Chamfer milling cutter

59 029 ... / 59 030 ...															
		Ø DC =													
		1/8–5/32"	3/16"	7/32"	1/4–3/32 –5/16"	3/8"	7/16"	1/2"	3/16–5/8"	3/4"	1"				
		$a_{p1 \times DC}$	$a_{p1 \times DC}$	$a_{p1 \times DC}$	$a_{p1 \times DC}$	$a_{p1 \times DC}$	$a_{p1 \times DC}$	$a_{p1 \times DC}$	$a_{p1 \times DC}$	$a_{p1 \times DC}$	$a_{p1 \times DC}$				
Index	V_c ft/min	$a_{pmax} \times DC$	f_z inch	f_z inch	f_z inch	f_z inch	f_z inch	f_z inch	f_z inch	f_z inch	f_z inch	f_z inch	Emulsion	Compressed air	MMS
P.1.1															
P.1.2															
P.1.3															
P.1.4															
P.1.5															
P.2.1															
P.2.2															
P.2.3															
P.2.4															
P.3.1															
P.3.2															
P.3.3															
P.4.1															
P.4.2															
M.1.1															
M.2.1															
M.3.1															
K.1.1															
K.1.2															
K.2.1															
K.2.2															
K.3.1															
K.3.2															
N.1.1	1970	1.0	0.0012	0.0015	0.0019	0.0025	0.0031	0.0038	0.0044	0.0047	0.0054	0.0062	●	○	○
N.1.2	1970	1.0	0.0012	0.0015	0.0019	0.0025	0.0031	0.0038	0.0044	0.0047	0.0054	0.0062	●	○	○
N.2.1	1180	1.0	0.0011	0.0014	0.0017	0.0023	0.0029	0.0035	0.0040	0.0043	0.0049	0.0056	●	○	○
N.2.2	1180	1.0	0.0011	0.0014	0.0017	0.0023	0.0029	0.0035	0.0040	0.0043	0.0049	0.0056	●	○	○
N.2.3	790	1.0	0.0011	0.0014	0.0017	0.0023	0.0029	0.0035	0.0040	0.0043	0.0049	0.0056	●	○	○
N.3.1	790	1.0	0.0008	0.0011	0.0013	0.0017	0.0022	0.0026	0.0031	0.0033	0.0037	0.0043	●	○	○
N.3.2	790	1.0	0.0008	0.0011	0.0013	0.0017	0.0022	0.0026	0.0031	0.0033	0.0037	0.0043	●	○	○
N.3.3	560	1.0	0.0008	0.0011	0.0013	0.0017	0.0022	0.0026	0.0031	0.0033	0.0037	0.0043	●	○	○
N.4.1	720	1.0	0.0011	0.0014	0.0017	0.0023	0.0029	0.0035	0.0040	0.0043	0.0049	0.0056	●	○	○
S.1.1															
S.1.2															
S.2.1															
S.2.2															
S.2.3															
S.3.1															
S.3.2															
S.3.3															
H.1.1															
H.1.2															
H.1.3															
H.1.4															
H.2.1															
H.3.1															
O.1.1															
O.1.2															
O.2.1															
O.2.2															
O.3.1															

Cutting Data – P117 – Rough-Finishing Cutter with corner radius, short – long

59 028 ...													
Ø DC =			1/8"	3/16"	1/4–5/16"	3/8"	7/16"	1/2"	5/8"	3/4"	● 1st choice	○ suitable	
			a _p 1 x DC	a _p 1 x DC	a _p 1 x DC	a _p 1 x DC	a _p 1 x DC	a _p 1 x DC	a _p 1 x DC	a _p 1 x DC	Emulsion	Compressed air	MMS
Index	V _c ft/min	a _{pmax} x DC	f _z inch	f _z inch	f _z inch	f _z inch	f _z inch	f _z inch	f _z inch	f _z inch			
P.1.1	360	1.0	0.0007	0.0008	0.0012	0.0015	0.0018	0.0020	0.0022	0.0024	●	○	○
P.1.2	300	1.0	0.0006	0.0007	0.0011	0.0013	0.0016	0.0018	0.0019	0.0022	●	○	○
P.1.3	300	1.0	0.0006	0.0007	0.0011	0.0013	0.0016	0.0018	0.0019	0.0022	●	○	○
P.1.4	260	1.0	0.0006	0.0007	0.0011	0.0013	0.0016	0.0018	0.0019	0.0022	●	○	○
P.1.5	260	1.0	0.0006	0.0007	0.0011	0.0013	0.0016	0.0018	0.0019	0.0022	●	○	○
P.2.1	300	1.0	0.0006	0.0007	0.0011	0.0013	0.0016	0.0018	0.0019	0.0022	●	○	○
P.2.2	230	1.0	0.0006	0.0007	0.0011	0.0013	0.0016	0.0018	0.0019	0.0022	●	○	○
P.2.3	230	1.0	0.0006	0.0007	0.0011	0.0013	0.0016	0.0018	0.0019	0.0022	●	○	○
P.2.4	180	1.0	0.0006	0.0007	0.0011	0.0013	0.0016	0.0018	0.0019	0.0022	●	○	○
P.3.1													
P.3.2													
P.3.3													
P.4.1	160	1.0	0.0004	0.0005	0.0008	0.0010	0.0012	0.0014	0.0015	0.0017	●		
P.4.2	130	1.0	0.0004	0.0005	0.0008	0.0010	0.0012	0.0014	0.0015	0.0017	●		
M.1.1	130	1.0	0.0004	0.0005	0.0008	0.0010	0.0012	0.0014	0.0015	0.0017	●		
M.2.1	160	1.0	0.0004	0.0005	0.0008	0.0010	0.0012	0.0014	0.0015	0.0017	●		
M.3.1	160	1.0	0.0004	0.0005	0.0008	0.0010	0.0012	0.0014	0.0015	0.0017	●		
K.1.1	430	1.0	0.0011	0.0013	0.0020	0.0024	0.0028	0.0033	0.0035	0.0039	●	○	○
K.1.2	400	1.0	0.0011	0.0013	0.0020	0.0024	0.0028	0.0033	0.0035	0.0039	●	○	○
K.2.1	420	1.0	0.0008	0.0010	0.0014	0.0017	0.0020	0.0023	0.0024	0.0027	●	○	○
K.2.2	400	1.0	0.0008	0.0010	0.0014	0.0017	0.0020	0.0023	0.0024	0.0027	●	○	○
K.3.1	430	1.0	0.0011	0.0013	0.0020	0.0024	0.0028	0.0033	0.0035	0.0039	●	○	○
K.3.2	400	1.0	0.0011	0.0013	0.0020	0.0024	0.0028	0.0033	0.0035	0.0039	●	○	○
N.1.1													
N.1.2													
N.2.1													
N.2.2													
N.2.3													
N.3.1	660	1.0	0.0007	0.0010	0.0016	0.0020	0.0024	0.0028	0.0030	0.0033	●	○	○
N.3.2	660	1.0	0.0007	0.0010	0.0016	0.0020	0.0024	0.0028	0.0030	0.0033	●	○	○
N.3.3	460	1.0	0.0007	0.0010	0.0016	0.0020	0.0024	0.0028	0.0030	0.0033	●	○	○
N.4.1													
S.1.1	98	1.0	0.0004	0.0005	0.0008	0.0010	0.0012	0.0014	0.0015	0.0017	●		
S.1.2	98	1.0	0.0004	0.0005	0.0008	0.0010	0.0012	0.0014	0.0015	0.0017	●		
S.2.1	98	1.0	0.0004	0.0005	0.0008	0.0010	0.0012	0.0014	0.0015	0.0017	●		
S.2.2	98	1.0	0.0004	0.0005	0.0008	0.0010	0.0012	0.0014	0.0015	0.0017	●		
S.2.3	98	1.0	0.0004	0.0005	0.0008	0.0010	0.0012	0.0014	0.0015	0.0017	●		
S.3.1	160	1.0	0.0004	0.0005	0.0008	0.0010	0.0012	0.0014	0.0015	0.0017	●		
S.3.2	66	1.0	0.0004	0.0005	0.0008	0.0010	0.0012	0.0014	0.0015	0.0017	●		
S.3.3													
H.1.1													
H.1.2													
H.1.3													
H.1.4													
H.2.1													
H.3.1													
O.1.1													
O.1.2													
O.2.1													
O.2.2													
O.3.1													

Cutting Data – P120 – Roughing-Finishing cutter with corner radius, extra short – extra long

			59 031 ... / 59 032 ...																						
			Ø DC = 1/8–5/32"		3/16"		7/32"		1/4–9/32", 5/16"		11/32–3/8"		7/16"		1/2"		9/16–5/8"		3/4"		1"		● 1st choice ○ suitable		
			$a_{p1 \times DC}$		$a_{p1 \times DC}$		$a_{p1 \times DC}$		$a_{p1 \times DC}$		$a_{p1 \times DC}$		$a_{p1 \times DC}$		$a_{p1 \times DC}$		$a_{p1 \times DC}$		$a_{p1 \times DC}$		$a_{p1 \times DC}$				
Index	V_c ft/min	$a_{pmax} \times DC$	f_z inch	f_z inch	f_z inch	f_z inch	f_z inch	f_z inch	f_z inch	f_z inch	f_z inch	f_z inch	f_z inch	f_z inch	f_z inch	f_z inch	f_z inch	f_z inch	f_z inch	f_z inch	f_z inch	Emulsion	Compressed air	MMS	
P.1.1	310	1.0	0.0007	0.0008	0.0009	0.0012	0.0015	0.0018	0.0020	0.0022	0.0024	0.0028	●	○	○										
P.1.2	260	1.0	0.0006	0.0007	0.0008	0.0011	0.0013	0.0016	0.0018	0.0019	0.0022	0.0025	●	○	○										
P.1.3	260	1.0	0.0006	0.0007	0.0008	0.0011	0.0013	0.0016	0.0018	0.0019	0.0022	0.0025	●	○	○										
P.1.4	230	1.0	0.0006	0.0007	0.0008	0.0011	0.0013	0.0016	0.0018	0.0019	0.0022	0.0025	●	○	○										
P.1.5	230	1.0	0.0006	0.0007	0.0008	0.0011	0.0013	0.0016	0.0018	0.0019	0.0022	0.0025	●	○	○										
P.2.1	250	1.0	0.0006	0.0007	0.0008	0.0011	0.0013	0.0016	0.0018	0.0019	0.0022	0.0025	●	○	○										
P.2.2	200	1.0	0.0006	0.0007	0.0008	0.0011	0.0013	0.0016	0.0018	0.0019	0.0022	0.0025	●	○	○										
P.2.3	200	1.0	0.0006	0.0007	0.0008	0.0011	0.0013	0.0016	0.0018	0.0019	0.0022	0.0025	●	○	○										
P.2.4	180	1.0	0.0006	0.0007	0.0008	0.0011	0.0013	0.0016	0.0018	0.0019	0.0022	0.0025	●	○	○										
P.3.1																									
P.3.2																									
P.3.3																									
P.4.1																									
P.4.2																									
M.1.1																									
M.2.1																									
M.3.1																									
K.1.1	390	1.0	0.0011	0.0013	0.0015	0.0020	0.0024	0.0028	0.0033	0.0035	0.0039	0.0045	●	○	○										
K.1.2	330	1.0	0.0011	0.0013	0.0015	0.0020	0.0024	0.0028	0.0033	0.0035	0.0039	0.0045	●	○	○										
K.2.1	390	1.0	0.0008	0.0010	0.0011	0.0014	0.0017	0.0020	0.0023	0.0024	0.0027	0.0031	●	○	○										
K.2.2	330	1.0	0.0008	0.0010	0.0011	0.0014	0.0017	0.0020	0.0023	0.0024	0.0027	0.0031	●	○	○										
K.3.1	390	1.0	0.0011	0.0013	0.0015	0.0020	0.0024	0.0028	0.0033	0.0035	0.0039	0.0045	●	○	○										
K.3.2	330	1.0	0.0011	0.0013	0.0015	0.0020	0.0024	0.0028	0.0033	0.0035	0.0039	0.0045	●	○	○										
N.1.1																									
N.1.2																									
N.2.1																									
N.2.2																									
N.2.3																									
N.3.1																									
N.3.2																									
N.3.3																									
N.4.1																									
S.1.1																									
S.1.2																									
S.2.1																									
S.2.2																									
S.2.3																									
S.3.1																									
S.3.2																									
S.3.3																									
H.1.1																									
H.1.2																									
H.1.3																									
H.1.4																									
H.2.1																									
H.3.1																									
O.1.1																									
O.1.2																									
O.2.1																									
O.2.2																									
O.3.1																									

Cutting Data – P121 – Roughing-Finishing cutter with corner radius, short – extra long

59 035 ...							
Ø DC =			3/4"	1"	● 1st choice		
			a_e 1 x DC	a_e 1 x DC	○ suitable		
Index	V_c ft/min	a_{pmax} x DC	f_z inch	f_z inch	Emulsion	Compressed air	MMS
P.1.1	480	1.0	0.0033	0.0039	●	○	○
P.1.2	460	1.0	0.0033	0.0039	●	○	○
P.1.3	460	1.0	0.0033	0.0039	●	○	○
P.1.4	440	1.0	0.0033	0.0039	●	○	○
P.1.5	440	1.0	0.0033	0.0039	●	○	○
P.2.1	460	1.0	0.0033	0.0039	●	○	○
P.2.2	440	1.0	0.0026	0.0030	●	○	○
P.2.3	410	1.0	0.0033	0.0039	●	○	○
P.2.4	390	1.0	0.0026	0.0030	●	○	○
P.3.1	410	1.0	0.0033	0.0039	●	○	○
P.3.2	390	1.0	0.0033	0.0039	●	○	○
P.3.3	320	1.0	0.0033	0.0039	●	○	○
P.4.1	230	1.0	0.0023	0.0026	●		
P.4.2	180	1.0	0.0023	0.0026	●		
M.1.1	230	1.0	0.0023	0.0026	●		
M.2.1	230	1.0	0.0023	0.0026	●		
M.3.1	230	1.0	0.0023	0.0026	●		
K.1.1	460	1.0	0.0039	0.0044	●	○	○
K.1.2	410	1.0	0.0039	0.0044	●	○	○
K.2.1	440	1.0	0.0033	0.0039	●	○	○
K.2.2	390	1.0	0.0033	0.0039	●	○	○
K.3.1	410	1.0	0.0033	0.0039	●	○	○
K.3.2	370	1.0	0.0033	0.0039	●	○	○
N.1.1							
N.1.2							
N.2.1							
N.2.2							
N.2.3							
N.3.1							
N.3.2							
N.3.3							
N.4.1							
S.1.1	130	1.0	0.0026	0.0030	●		
S.1.2	130	1.0	0.0026	0.0030	●		
S.2.1	130	1.0	0.0026	0.0030	●		
S.2.2	130	1.0	0.0026	0.0030	●		
S.2.3	130	1.0	0.0026	0.0030	●		
S.3.1	280	1.0	0.0039	0.0044	●		
S.3.2	180	1.0	0.0026	0.0030	●		
S.3.3							
H.1.1							
H.1.2							
H.1.3							
H.1.4							
H.2.1							
H.3.1							
O.1.1							
O.1.2							
O.2.1							
O.2.2							
O.3.1							

Cutting Data – P102 –Rough milling cutter with corner radius, short – extra long

59 023 ... / 59 024 ... / 59 025 ... / 59 026 ...													
		Ø DC =									● 1st choice ○ suitable		
		3/16"	1/4–5/16"	3/8"	7/16"	1/2"	3/16–5/8"	3/4"	1"				
		a_p 1 x DC	a_p 1 x DC	a_p 1 x DC	a_p 1 x DC	a_p 1 x DC	a_p 1 x DC	a_p 1 x DC	a_p 1 x DC				
Index	v_c ft/min	a_{pmax} x DC	f_z inch	f_z inch	f_z inch	f_z inch	f_z inch	f_z inch	f_z inch	f_z inch	Emulsion	Compressed air	MMS
P.1.1													
P.1.2													
P.1.3													
P.1.4													
P.1.5													
P.2.1													
P.2.2													
P.2.3													
P.2.4													
P.3.1													
P.3.2													
P.3.3													
P.4.1													
P.4.2													
M.1.1													
M.2.1													
M.3.1													
K.1.1													
K.1.2													
K.2.1													
K.2.2													
K.3.1													
K.3.2													
N.1.1	1970	1.0	0.0015	0.0025	0.0031	0.0038	0.0044	0.0047	0.0054	0.0062	●	○	○
N.1.2	1970	1.0	0.0015	0.0025	0.0031	0.0038	0.0044	0.0047	0.0054	0.0062	●	○	○
N.2.1	1180	1.0	0.0014	0.0023	0.0029	0.0035	0.0040	0.0043	0.0049	0.0056	●	○	○
N.2.2	1180	1.0	0.0014	0.0023	0.0029	0.0035	0.0040	0.0043	0.0049	0.0056	●	○	○
N.2.3	790	1.0	0.0014	0.0023	0.0029	0.0035	0.0040	0.0043	0.0049	0.0056	●	○	○
N.3.1	790	1.0	0.0011	0.0017	0.0022	0.0026	0.0031	0.0033	0.0037	0.0043	●	○	○
N.3.2	790	1.0	0.0011	0.0017	0.0022	0.0026	0.0031	0.0033	0.0037	0.0043	●	○	○
N.3.3	560	1.0	0.0011	0.0017	0.0022	0.0026	0.0031	0.0033	0.0037	0.0043	●	○	○
N.4.1	720	1.0	0.0014	0.0023	0.0029	0.0035	0.0040	0.0043	0.0049	0.0056	●	○	○
S.1.1													
S.1.2													
S.2.1													
S.2.2													
S.2.3													
S.3.1													
S.3.2													
S.3.3													
H.1.1													
H.1.2													
H.1.3													
H.1.4													
H.2.1													
H.3.1													
O.1.1													
O.1.2													
O.2.1													
O.2.2													
O.3.1													

Cutting Data – P190 / P191 – Rough milling cutter, short – extra long

59 059 ... / 59 061 ...												
Index	V _c ft/min	a _{9max} x DC	Ø DC =							● 1st choice ○ suitable		
			3/16"	1/4–5/16"	3/8"	1/2"	5/8"	3/4"	1"	Emulsion	Compressed air	MMS
			a _p 1 x DC	a _p 1 x DC	a _p 1 x DC	a _p 1 x DC	a _p 1 x DC	a _p 1 x DC	a _p 1 x DC			
P.1.1	310	1.0	0.0007	0.0012	0.0015	0.0020	0.0022	0.0024	0.0028	●	○	○
P.1.2	260	1.0	0.0006	0.0011	0.0013	0.0018	0.0019	0.0022	0.0025	●	○	○
P.1.3	260	1.0	0.0006	0.0011	0.0013	0.0018	0.0019	0.0022	0.0025	●	○	○
P.1.4	230	1.0	0.0006	0.0011	0.0013	0.0018	0.0019	0.0022	0.0025	●	○	○
P.1.5	230	1.0	0.0006	0.0011	0.0013	0.0018	0.0019	0.0022	0.0025	●	○	○
P.2.1	250	1.0	0.0006	0.0011	0.0013	0.0018	0.0019	0.0022	0.0025	●	○	○
P.2.2	200	1.0	0.0006	0.0011	0.0013	0.0018	0.0019	0.0022	0.0025	●	○	○
P.2.3	200	1.0	0.0006	0.0011	0.0013	0.0018	0.0019	0.0022	0.0025	●	○	○
P.2.4	180	1.0	0.0006	0.0011	0.0013	0.0018	0.0019	0.0022	0.0025	●	○	○
P.3.1												
P.3.2												
P.3.3												
P.4.1												
P.4.2												
M.1.1												
M.2.1												
M.3.1												
K.1.1	390	1.0	0.0011	0.0020	0.0024	0.0033	0.0035	0.0039	0.0045	●	○	○
K.1.2	330	1.0	0.0011	0.0020	0.0024	0.0033	0.0035	0.0039	0.0045	●	○	○
K.2.1	390	1.0	0.0008	0.0014	0.0017	0.0023	0.0024	0.0027	0.0031	●	○	○
K.2.2	330	1.0	0.0008	0.0014	0.0017	0.0023	0.0024	0.0027	0.0031	●	○	○
K.3.1	390	1.0	0.0011	0.0020	0.0024	0.0033	0.0035	0.0039	0.0045	●	○	○
K.3.2	330	1.0	0.0011	0.0020	0.0024	0.0033	0.0035	0.0039	0.0045	●	○	○
N.1.1												
N.1.2												
N.2.1												
N.2.2												
N.2.3												
N.3.1												
N.3.2												
N.3.3												
N.4.1												
S.1.1												
S.1.2												
S.2.1												
S.2.2												
S.2.3												
S.3.1												
S.3.2												
S.3.3												
H.1.1												
H.1.2												
H.1.3												
H.1.4												
H.2.1												
H.3.1												
O.1.1												
O.1.2												
O.2.1												
O.2.2												
O.3.1												

Cutting Data – P100 – Rough milling cutter with corner radius, short – extra long

59 011 ... / 59 012 ... / 59 013 ... / 59 014 ...													
Ø DC =			3/16"	1/4–5/16"	3/8"	7/16"	1/2"	9/16–5/8"	3/4"	1"	● 1st choice ○ suitable		
			a_p 1 x DC	a_p 1 x DC	a_p 1 x DC	a_p 1 x DC	a_p 1 x DC	a_p 1 x DC	a_p 1 x DC	a_p 1 x DC	Emulsion	Compressed air	MMS
Index	V_c ft/min	a_{pmax} x DC	f_z inch	f_z inch	f_z inch	f_z inch	f_z inch	f_z inch	f_z inch	f_z inch			
P.1.1	312	1.0	0.0008	0.0012	0.0015	0.0018	0.0020	0.0022	0.0024	0.0028	●	○	○
P.1.2	262	1.0	0.0007	0.0011	0.0013	0.0016	0.0018	0.0019	0.0022	0.0025	●	○	○
P.1.3	262	1.0	0.0007	0.0011	0.0013	0.0016	0.0018	0.0019	0.0022	0.0025	●	○	○
P.1.4	230	1.0	0.0007	0.0011	0.0013	0.0016	0.0018	0.0019	0.0022	0.0025	●	○	○
P.1.5	230	1.0	0.0007	0.0011	0.0013	0.0016	0.0018	0.0019	0.0022	0.0025	●	○	○
P.2.1	246	1.0	0.0007	0.0011	0.0013	0.0016	0.0018	0.0019	0.0022	0.0025	●	○	○
P.2.2	197	1.0	0.0007	0.0011	0.0013	0.0016	0.0018	0.0019	0.0022	0.0025	●	○	○
P.2.3	197	1.0	0.0007	0.0011	0.0013	0.0016	0.0018	0.0019	0.0022	0.0025	●	○	○
P.2.4	180	1.0	0.0007	0.0011	0.0013	0.0016	0.0018	0.0019	0.0022	0.0025	●	○	○
P.3.1													
P.3.2													
P.3.3													
P.4.1													
P.4.2													
M.1.1													
M.2.1													
M.3.1													
K.1.1	390	1.0	0.0013	0.0020	0.0024	0.0028	0.0033	0.0035	0.0039	0.0045	●	○	○
K.1.2	330	1.0	0.0013	0.0020	0.0024	0.0028	0.0033	0.0035	0.0039	0.0045	●	○	○
K.2.1	390	1.0	0.0010	0.0014	0.0017	0.0020	0.0023	0.0024	0.0027	0.0031	●	○	○
K.2.2	330	1.0	0.0010	0.0014	0.0017	0.0020	0.0023	0.0024	0.0027	0.0031	●	○	○
K.3.1	390	1.0	0.0013	0.0020	0.0024	0.0028	0.0033	0.0035	0.0039	0.0045	●	○	○
K.3.2	330	1.0	0.0013	0.0020	0.0024	0.0028	0.0033	0.0035	0.0039	0.0045	●	○	○
N.1.1													
N.1.2													
N.2.1													
N.2.2													
N.2.3													
N.3.1													
N.3.2													
N.3.3													
N.4.1													
S.1.1													
S.1.2													
S.2.1													
S.2.2													
S.2.3													
S.3.1													
S.3.2													
S.3.3													
H.1.1													
H.1.2													
H.1.3													
H.1.4													
H.2.1													
H.3.1													
O.1.1													
O.1.2													
O.2.1													
O.2.2													
O.3.1													

Cutting Data – P101 – Rough milling cutter with corner radius, short – extra long

59 015 ... / 59 016 ... / 59 017 ... / 59 022 ...													
Index	V _c ft/min	a _{9max} x DC	Ø DC =								<input checked="" type="radio"/> 1st choice <input type="radio"/> suitable		
			3/16"	1/4–5/16"	3/8"	7/16"	1/2"	9/16–5/8"	3/4"	1"	Emulsion	Compressed air	MMS
			a _p 1 x DC	a _p 1 x DC	a _p 1 x DC	a _p 1 x DC	a _p 1 x DC	a _p 1 x DC	a _p 1 x DC	a _p 1 x DC			
			f _z inch	f _z inch	f _z inch	f _z inch	f _z inch	f _z inch	f _z inch	f _z inch			
P.1.1	310	1.0	0.0008	0.0012	0.0015	0.0018	0.0020	0.0022	0.0024	0.0028	●	○	○
P.1.2	260	1.0	0.0007	0.0011	0.0013	0.0016	0.0018	0.0019	0.0022	0.0025	●	○	○
P.1.3	260	1.0	0.0007	0.0011	0.0013	0.0016	0.0018	0.0019	0.0022	0.0025	●	○	○
P.1.4	230	1.0	0.0007	0.0011	0.0013	0.0016	0.0018	0.0019	0.0022	0.0025	●	○	○
P.1.5	230	1.0	0.0007	0.0011	0.0013	0.0016	0.0018	0.0019	0.0022	0.0025	●	○	○
P.2.1	250	1.0	0.0007	0.0011	0.0013	0.0016	0.0018	0.0019	0.0022	0.0025	●	○	○
P.2.2	200	1.0	0.0007	0.0011	0.0013	0.0016	0.0018	0.0019	0.0022	0.0025	●	○	○
P.2.3	200	1.0	0.0007	0.0011	0.0013	0.0016	0.0018	0.0019	0.0022	0.0025	●	○	○
P.2.4	180	1.0	0.0007	0.0011	0.0013	0.0016	0.0018	0.0019	0.0022	0.0025	●	○	○
P.3.1													
P.3.2													
P.3.3													
P.4.1													
P.4.2													
M.1.1													
M.2.1													
M.3.1													
K.1.1	390	1.0	0.0013	0.0020	0.0024	0.0028	0.0033	0.0035	0.0039	0.0045	●	○	○
K.1.2	330	1.0	0.0013	0.0020	0.0024	0.0028	0.0033	0.0035	0.0039	0.0045	●	○	○
K.2.1	390	1.0	0.0010	0.0014	0.0017	0.0020	0.0023	0.0024	0.0027	0.0031	●	○	○
K.2.2	330	1.0	0.0010	0.0014	0.0017	0.0020	0.0023	0.0024	0.0027	0.0031	●	○	○
K.3.1	390	1.0	0.0013	0.0020	0.0024	0.0028	0.0033	0.0035	0.0039	0.0045	●	○	○
K.3.2	330	1.0	0.0013	0.0020	0.0024	0.0028	0.0033	0.0035	0.0039	0.0045	●	○	○
N.1.1													
N.1.2													
N.2.1													
N.2.2													
N.2.3													
N.3.1													
N.3.2													
N.3.3													
N.4.1													
S.1.1													
S.1.2													
S.2.1													
S.2.2													
S.2.3													
S.3.1													
S.3.2													
S.3.3													
H.1.1													
H.1.2													
H.1.3													
H.1.4													
H.2.1													
H.3.1													
O.1.1													
O.1.2													
O.2.1													
O.2.2													
O.3.1													

Cutting Data – P662 – Ball nosed Cutter, extra short – extra long

59 074 ... / 59 075 ...												
Ø DC =			1/16"	1/8"	3/16"	1/4–5/16"	3/8"	1/2"	5/8"	3/4"	1"	● 1st choice ○ suitable
			a_p 1 x DC	a_p 1 x DC	a_p 1 x DC	a_p 1 x DC	a_p 1 x DC	a_p 1 x DC	a_p 1 x DC	a_p 1 x DC	a_p 1 x DC	Emulsion Compressed air MMS
Index	V_c ft/min	a_{pmax} x DC	f_z inch	f_z inch	f_z inch	f_z inch	f_z inch	f_z inch	f_z inch	f_z inch	f_z inch	
P.1.1	350	1.0	0.0003	0.0006	0.0007	0.0011	0.0013	0.0018	0.0019	0.0022	0.0025	● ○ ○
P.1.2	310	1.0	0.0003	0.0006	0.0007	0.0011	0.0013	0.0018	0.0019	0.0022	0.0025	● ○ ○
P.1.3	310	1.0	0.0003	0.0006	0.0007	0.0011	0.0013	0.0018	0.0019	0.0022	0.0025	● ○ ○
P.1.4	300	1.0	0.0003	0.0006	0.0007	0.0011	0.0013	0.0018	0.0019	0.0022	0.0025	● ○ ○
P.1.5	300	1.0	0.0003	0.0006	0.0007	0.0011	0.0013	0.0018	0.0019	0.0022	0.0025	● ○ ○
P.2.1	330	1.0	0.0003	0.0006	0.0007	0.0011	0.0013	0.0018	0.0019	0.0022	0.0025	● ○ ○
P.2.2	280	1.0	0.0003	0.0006	0.0007	0.0011	0.0013	0.0018	0.0019	0.0022	0.0025	● ○ ○
P.2.3	280	1.0	0.0003	0.0006	0.0007	0.0011	0.0013	0.0018	0.0019	0.0022	0.0025	● ○ ○
P.2.4	260	1.0	0.0003	0.0006	0.0007	0.0011	0.0013	0.0018	0.0019	0.0022	0.0025	● ○ ○
P.3.1												
P.3.2												
P.3.3												
P.4.1	200	1.0	0.0002	0.0004	0.0005	0.0008	0.0010	0.0014	0.0015	0.0017	0.0019	● ○ ○
P.4.2	80	1.0	0.0002	0.0004	0.0005	0.0008	0.0010	0.0014	0.0015	0.0017	0.0019	● ○ ○
M.1.1	98	1.0	0.0002	0.0004	0.0005	0.0008	0.0010	0.0014	0.0015	0.0017	0.0019	● ○ ○
M.2.1	98	1.0	0.0002	0.0004	0.0005	0.0008	0.0010	0.0014	0.0015	0.0017	0.0019	● ○ ○
M.3.1	98	1.0	0.0002	0.0004	0.0005	0.0008	0.0010	0.0014	0.0015	0.0017	0.0019	● ○ ○
K.1.1	240	1.0	0.0007	0.0011	0.0013	0.0020	0.0024	0.0033	0.0035	0.0039	0.0045	● ○ ○
K.1.2	160	1.0	0.0007	0.0011	0.0013	0.0020	0.0024	0.0033	0.0035	0.0039	0.0045	● ○ ○
K.2.1	240	1.0	0.0006	0.0008	0.0010	0.0014	0.0017	0.0023	0.0024	0.0027	0.0031	● ○ ○
K.2.2	390	1.0	0.0006	0.0008	0.0010	0.0014	0.0017	0.0023	0.0024	0.0027	0.0031	● ○ ○
K.3.1	240	1.0	0.0007	0.0011	0.0013	0.0020	0.0024	0.0033	0.0035	0.0039	0.0045	● ○ ○
K.3.2	200	1.0	0.0007	0.0011	0.0013	0.0020	0.0024	0.0033	0.0035	0.0039	0.0045	● ○ ○
N.1.1												
N.1.2												
N.2.1												
N.2.2												
N.2.3												
N.3.1	390	1.0	0.0004	0.0008	0.0011	0.0017	0.0022	0.0031	0.0033	0.0037	0.0043	● ○ ○
N.3.2	390	1.0	0.0004	0.0008	0.0011	0.0017	0.0022	0.0031	0.0033	0.0037	0.0043	● ○ ○
N.3.3	280	1.0	0.0004	0.0008	0.0011	0.0017	0.0022	0.0031	0.0033	0.0037	0.0043	● ○ ○
N.4.1												
S.1.1	59	1.0	0.0002	0.0004	0.0005	0.0008	0.0010	0.0014	0.0015	0.0017	0.0019	● ○ ○
S.1.2	59	1.0	0.0002	0.0004	0.0005	0.0008	0.0010	0.0014	0.0015	0.0017	0.0019	● ○ ○
S.2.1	59	1.0	0.0002	0.0004	0.0005	0.0008	0.0010	0.0014	0.0015	0.0017	0.0019	● ○ ○
S.2.2	59	1.0	0.0002	0.0004	0.0005	0.0008	0.0010	0.0014	0.0015	0.0017	0.0019	● ○ ○
S.2.3	59	1.0	0.0002	0.0004	0.0005	0.0008	0.0010	0.0014	0.0015	0.0017	0.0019	● ○ ○
S.3.1	98	1.0	0.0002	0.0004	0.0005	0.0008	0.0010	0.0014	0.0015	0.0017	0.0019	● ○ ○
S.3.2	39	1.0	0.0002	0.0004	0.0005	0.0008	0.0010	0.0014	0.0015	0.0017	0.0019	● ○ ○
S.3.3												
H.1.1												
H.1.2												
H.1.3												
H.1.4												
H.2.1												
H.3.1												
O.1.1												
O.1.2												
O.2.1												
O.2.2												
O.3.1												

Cutting Data – S663 – Ball nosed Cutter, extra short – extra long

59 078 ... / 59 079 ...													
Index	V _c ft/min	a _{pmax} x DC	Ø DC =								● 1st choice ○ suitable		
			1/8"	3/16"	1/4–5/16"	3/8"	1/2"	5/8"	3/4"	1"	Emulsion	Compressed air	MMS
			a _p 1 x DC	a _p 1 x DC	a _p 1 x DC	a _p 1 x DC	a _p 1 x DC	a _p 1 x DC	a _p 1 x DC	a _p 1 x DC			
			f _z inch	f _z inch	f _z inch	f _z inch	f _z inch	f _z inch	f _z inch	f _z inch			
P.1.1	590	1.0	0.0006	0.0007	0.0011	0.0013	0.0018	0.0019	0.0022	0.0025	●	○	○
P.1.2	520	1.0	0.0006	0.0007	0.0011	0.0013	0.0018	0.0019	0.0022	0.0025	●	○	○
P.1.3	520	1.0	0.0006	0.0007	0.0011	0.0013	0.0018	0.0019	0.0022	0.0025	●	○	○
P.1.4	490	1.0	0.0006	0.0007	0.0011	0.0013	0.0018	0.0019	0.0022	0.0025	●	○	○
P.1.5	490	1.0	0.0006	0.0007	0.0011	0.0013	0.0018	0.0019	0.0022	0.0025	●	○	○
P.2.1	560	1.0	0.0006	0.0007	0.0011	0.0013	0.0018	0.0019	0.0022	0.0025	●	○	○
P.2.2	460	1.0	0.0006	0.0007	0.0011	0.0013	0.0018	0.0019	0.0022	0.0025	●	○	○
P.2.3	460	1.0	0.0006	0.0007	0.0011	0.0013	0.0018	0.0019	0.0022	0.0025	●	○	○
P.2.4	430	1.0	0.0006	0.0007	0.0011	0.0013	0.0018	0.0019	0.0022	0.0025	●	○	○
P.3.1													
P.3.2													
P.3.3													
P.4.1	330	1.0	0.0004	0.0005	0.0008	0.0010	0.0014	0.0015	0.0017	0.0019	●		
P.4.2	130	1.0	0.0004	0.0005	0.0008	0.0010	0.0014	0.0015	0.0017	0.0019	●		
M.1.1	160	1.0	0.0004	0.0005	0.0008	0.0010	0.0014	0.0015	0.0017	0.0019	●		
M.2.1	160	1.0	0.0004	0.0005	0.0008	0.0010	0.0014	0.0015	0.0017	0.0019	●		
M.3.1	160	1.0	0.0004	0.0005	0.0008	0.0010	0.0014	0.0015	0.0017	0.0019	●		
K.1.1	390	1.0	0.0011	0.0013	0.0020	0.0024	0.0033	0.0035	0.0039	0.0045	●	○	○
K.1.2	260	1.0	0.0011	0.0013	0.0020	0.0024	0.0033	0.0035	0.0039	0.0045	●	○	○
K.2.1	390	1.0	0.0008	0.0010	0.0014	0.0017	0.0023	0.0024	0.0027	0.0031	●	○	○
K.2.2	660	1.0	0.0008	0.0010	0.0014	0.0017	0.0023	0.0024	0.0027	0.0031	●	○	○
K.3.1	390	1.0	0.0011	0.0013	0.0020	0.0024	0.0033	0.0035	0.0039	0.0045	●	○	○
K.3.2	330	1.0	0.0011	0.0013	0.0020	0.0024	0.0033	0.0035	0.0039	0.0045	●	○	○
N.1.1													
N.1.2													
N.2.1													
N.2.2													
N.2.3													
N.3.1	660	1.0	0.0008	0.0011	0.0017	0.0022	0.0031	0.0033	0.0037	0.0043	●	○	○
N.3.2	660	1.0	0.0008	0.0011	0.0017	0.0022	0.0031	0.0033	0.0037	0.0043	●	○	○
N.3.3	460	1.0	0.0008	0.0011	0.0017	0.0022	0.0031	0.0033	0.0037	0.0043	●	○	○
N.4.1													
S.1.1	98	1.0	0.0004	0.0005	0.0008	0.0010	0.0014	0.0015	0.0017	0.0019	●		
S.1.2	98	1.0	0.0004	0.0005	0.0008	0.0010	0.0014	0.0015	0.0017	0.0019	●		
S.2.1	98	1.0	0.0004	0.0005	0.0008	0.0010	0.0014	0.0015	0.0017	0.0019	●		
S.2.2	98	1.0	0.0004	0.0005	0.0008	0.0010	0.0014	0.0015	0.0017	0.0019	●		
S.2.3	98	1.0	0.0004	0.0005	0.0008	0.0010	0.0014	0.0015	0.0017	0.0019	●		
S.3.1	160	1.0	0.0004	0.0005	0.0008	0.0010	0.0014	0.0015	0.0017	0.0019	●		
S.3.2	66	1.0	0.0004	0.0005	0.0008	0.0010	0.0014	0.0015	0.0017	0.0019	●		
S.3.3													
H.1.1													
H.1.2													
H.1.3													
H.1.4													
H.2.1													
H.3.1													
O.1.1													
O.1.2													
O.2.1													
O.2.2													
O.3.1													

Cutting Data – P157 – Ball nosed cutter, short – extra long

59 055 ...															
Ø DC =			1/8–5/32"	3/16"	7/32"	1/4–5/16"	3/8"	1/2"	9/16"	3/4"	1"	● 1st choice	○ suitable		
Index	V _c ft/min	a _{9max} x DC	a _p 1 x DC										Emulsion	Compressed air	MMS
			f _z inch	f _z inch	f _z inch	f _z inch	f _z inch	f _z inch	f _z inch	f _z inch	f _z inch	f _z inch			
P.1.1	430	1.0	0.0007	0.0008	0.0009	0.0012	0.0015	0.0020	0.0022	0.0024	0.0028	●	○	○	
P.1.2	360	1.0	0.0006	0.0007	0.0008	0.0011	0.0013	0.0018	0.0019	0.0022	0.0025	●	○	○	
P.1.3	360	1.0	0.0006	0.0007	0.0008	0.0011	0.0013	0.0018	0.0019	0.0022	0.0025	●	○	○	
P.1.4	310	1.0	0.0006	0.0007	0.0008	0.0011	0.0013	0.0018	0.0019	0.0022	0.0025	●	○	○	
P.1.5	310	1.0	0.0006	0.0007	0.0008	0.0011	0.0013	0.0018	0.0019	0.0022	0.0025	●	○	○	
P.2.1	360	1.0	0.0006	0.0007	0.0008	0.0011	0.0013	0.0018	0.0019	0.0022	0.0025	●	○	○	
P.2.2	280	1.0	0.0006	0.0007	0.0008	0.0011	0.0013	0.0018	0.0019	0.0022	0.0025	●	○	○	
P.2.3	280	1.0	0.0006	0.0007	0.0008	0.0011	0.0013	0.0018	0.0019	0.0022	0.0025	●	○	○	
P.2.4	210	1.0	0.0006	0.0007	0.0008	0.0011	0.0013	0.0018	0.0019	0.0022	0.0025	●	○	○	
P.3.1															
P.3.2															
P.3.3															
P.4.1	200	1.0	0.0004	0.0005	0.0006	0.0008	0.0010	0.0014	0.0015	0.0017	0.0019	●			
P.4.2	160	1.0	0.0004	0.0005	0.0006	0.0008	0.0010	0.0014	0.0015	0.0017	0.0019	●			
M.1.1	160	1.0	0.0004	0.0005	0.0006	0.0008	0.0010	0.0014	0.0015	0.0017	0.0019	●			
M.2.1	200	1.0	0.0004	0.0005	0.0006	0.0008	0.0010	0.0014	0.0015	0.0017	0.0019	●			
M.3.1	200	1.0	0.0004	0.0005	0.0006	0.0008	0.0010	0.0014	0.0015	0.0017	0.0019	●			
K.1.1	510	1.0	0.0011	0.0013	0.0015	0.0020	0.0024	0.0033	0.0035	0.0039	0.0045	●	○	○	
K.1.2	480	1.0	0.0011	0.0013	0.0015	0.0020	0.0024	0.0033	0.0035	0.0039	0.0045	●	○	○	
K.2.1	510	1.0	0.0008	0.0010	0.0011	0.0014	0.0017	0.0023	0.0024	0.0027	0.0031	●	○	○	
K.2.2	480	1.0	0.0008	0.0010	0.0011	0.0014	0.0017	0.0023	0.0024	0.0027	0.0031	●	○	○	
K.3.1	510	1.0	0.0011	0.0013	0.0015	0.0020	0.0024	0.0033	0.0035	0.0039	0.0045	●	○	○	
K.3.2	480	1.0	0.0011	0.0013	0.0015	0.0020	0.0024	0.0033	0.0035	0.0039	0.0045	●	○	○	
N.1.1															
N.1.2															
N.2.1															
N.2.2															
N.2.3															
N.3.1	790	1.0	0.0008	0.0011	0.0013	0.0017	0.0022	0.0031	0.0033	0.0037	0.0043	●	○	○	
N.3.2	790	1.0	0.0008	0.0011	0.0013	0.0017	0.0022	0.0031	0.0033	0.0037	0.0043	●	○	○	
N.3.3	560	1.0	0.0008	0.0011	0.0013	0.0017	0.0022	0.0031	0.0033	0.0037	0.0043	●	○	○	
N.4.1															
S.1.1															
S.1.2															
S.2.1															
S.2.2															
S.2.3															
S.3.1															
S.3.2															
S.3.3															
H.1.1															
H.1.2															
H.1.3															
H.1.4															
H.2.1															
H.3.1															
O.1.1															
O.1.2															
O.2.1															
O.2.2															
O.3.1															

Cutting Data – S664 – Ball nosed Cutter, extra short – extra long

59 080... / 59 081 ...																	
		Ø DC =													● 1st choice		
		1/32"	3/64"	1/16"	3/32"	1/8–5/32"	3/16"	1/4–5/16"	3/8"	1/2"	5/8"	3/4"	1"	○ suitable			
		a_p 1 x DC	a_p 1 x DC	a_p 1 x DC	a_p 1 x DC	a_p 1 x DC	a_p 1 x DC	a_p 1 x DC	a_p 1 x DC	a_p 1 x DC	a_p 1 x DC	a_p 1 x DC	a_p 1 x DC				
Index	V_c ft/min	$a_{p,max}$ x DC	f_z inch	f_z inch	f_z inch	f_z inch	f_z inch	f_z inch	f_z inch	f_z inch	f_z inch	f_z inch	f_z inch	Emulsion	Compressed air	MMS	
P.1.1	260	1.0	0.0003	0.0003	0.0004	0.0005	0.0007	0.0008	0.0012	0.0015	0.0020	0.0022	0.0024	0.0028	●	○	○
P.1.2	220	1.0	0.0002	0.0002	0.0003	0.0004	0.0006	0.0007	0.0011	0.0013	0.0018	0.0019	0.0022	0.0025	●	○	○
P.1.3	220	1.0	0.0002	0.0002	0.0003	0.0004	0.0006	0.0007	0.0011	0.0013	0.0018	0.0019	0.0022	0.0025	●	○	○
P.1.4	190	1.0	0.0002	0.0002	0.0003	0.0004	0.0006	0.0007	0.0011	0.0013	0.0018	0.0019	0.0022	0.0025	●	○	○
P.1.5	190	1.0	0.0002	0.0002	0.0003	0.0004	0.0006	0.0007	0.0011	0.0013	0.0018	0.0019	0.0022	0.0025	●	○	○
P.2.1	220	1.0	0.0002	0.0002	0.0003	0.0004	0.0006	0.0007	0.0011	0.0013	0.0018	0.0019	0.0022	0.0025	●	○	○
P.2.2	170	1.0	0.0002	0.0002	0.0003	0.0004	0.0006	0.0007	0.0011	0.0013	0.0018	0.0019	0.0022	0.0025	●	○	○
P.2.3	170	1.0	0.0002	0.0002	0.0003	0.0004	0.0006	0.0007	0.0011	0.0013	0.0018	0.0019	0.0022	0.0025	●	○	○
P.2.4	130	1.0	0.0002	0.0002	0.0003	0.0004	0.0006	0.0007	0.0011	0.0013	0.0018	0.0019	0.0022	0.0025	●	○	○
P.3.1																	
P.3.2																	
P.3.3																	
P.4.1	120	1.0	0.0001	0.0001	0.0002	0.0003	0.0004	0.0005	0.0008	0.0010	0.0014	0.0015	0.0017	0.0019	●		
P.4.2	100	1.0	0.0001	0.0001	0.0002	0.0003	0.0004	0.0005	0.0008	0.0010	0.0014	0.0015	0.0017	0.0019	●		
M.1.1	98	1.0	0.0001	0.0001	0.0002	0.0003	0.0004	0.0005	0.0008	0.0010	0.0014	0.0015	0.0017	0.0019	●		
M.2.1	120	1.0	0.0001	0.0001	0.0002	0.0003	0.0004	0.0005	0.0008	0.0010	0.0014	0.0015	0.0017	0.0019	●		
M.3.1	120	1.0	0.0001	0.0001	0.0002	0.0003	0.0004	0.0005	0.0008	0.0010	0.0014	0.0015	0.0017	0.0019	●		
K.1.1	310	1.0	0.0004	0.0006	0.0007	0.0009	0.0011	0.0013	0.0020	0.0024	0.0033	0.0035	0.0039	0.0045	●	○	○
K.1.2	290	1.0	0.0004	0.0006	0.0007	0.0009	0.0011	0.0013	0.0020	0.0024	0.0033	0.0035	0.0039	0.0045	●	○	○
K.2.1	310	1.0	0.0004	0.0005	0.0006	0.0007	0.0008	0.0010	0.0014	0.0017	0.0023	0.0024	0.0027	0.0031	●	○	○
K.2.2	290	1.0	0.0004	0.0005	0.0006	0.0007	0.0008	0.0010	0.0014	0.0017	0.0023	0.0024	0.0027	0.0031	●	○	○
K.3.1	310	1.0	0.0004	0.0006	0.0007	0.0009	0.0011	0.0013	0.0020	0.0024	0.0033	0.0035	0.0039	0.0045	●	○	○
K.3.2	290	1.0	0.0004	0.0006	0.0007	0.0009	0.0011	0.0013	0.0020	0.0024	0.0033	0.0035	0.0039	0.0045	●	○	○
N.1.1																	
N.1.2																	
N.2.1																	
N.2.2																	
N.2.3																	
N.3.1	470	1.0	0.0002	0.0003	0.0004	0.0006	0.0008	0.0011	0.0017	0.0022	0.0031	0.0033	0.0037	0.0043	●	○	○
N.3.2	470	1.0	0.0002	0.0003	0.0004	0.0006	0.0008	0.0011	0.0017	0.0022	0.0031	0.0033	0.0037	0.0043	●	○	○
N.3.3	330	1.0	0.0002	0.0003	0.0004	0.0006	0.0008	0.0011	0.0017	0.0022	0.0031	0.0033	0.0037	0.0043	●	○	○
N.4.1																	
S.1.1																	
S.1.2																	
S.2.1																	
S.2.2																	
S.2.3																	
S.3.1																	
S.3.2																	
S.3.3																	
H.1.1																	
H.1.2																	
H.1.3																	
H.1.4																	
H.2.1																	
H.3.1																	
O.1.1																	
O.1.2																	
O.2.1																	
O.2.2																	
O.3.1																	

Cutting Data – P250 – Ball Nosed Cutter, medium long – extra long

59 063 ...										
Ø DC =			1/8"	3/16"	1/4"	3/8"	1/2"	● 1st choice ○ suitable		
			a_p 1 x DC	a_p 1 x DC	a_p 1 x DC	a_p 1 x DC	a_p 1 x DC	Emulsion	Compressed air	MMS
Index	V_c ft/min	a_{pmax} x DC	f_z inch	f_z inch	f_z inch	f_z inch	f_z inch			
P.1.1	350	1.0	0.0006	0.0007	0.0011	0.0013	0.0018	●	○	○
P.1.2	310	1.0	0.0006	0.0007	0.0011	0.0013	0.0018	●	○	○
P.1.3	310	1.0	0.0006	0.0007	0.0011	0.0013	0.0018	●	○	○
P.1.4	300	1.0	0.0006	0.0007	0.0011	0.0013	0.0018	●	○	○
P.1.5	300	1.0	0.0006	0.0007	0.0011	0.0013	0.0018	●	○	○
P.2.1	330	1.0	0.0006	0.0007	0.0011	0.0013	0.0018	●	○	○
P.2.2	280	1.0	0.0006	0.0007	0.0011	0.0013	0.0018	●	○	○
P.2.3	280	1.0	0.0006	0.0007	0.0011	0.0013	0.0018	●	○	○
P.2.4	260	1.0	0.0006	0.0007	0.0011	0.0013	0.0018	●	○	○
P.3.1										
P.3.2										
P.3.3										
P.4.1	200	1.0	0.0004	0.0005	0.0008	0.0010	0.0014	●		
P.4.2	80	1.0	0.0004	0.0005	0.0008	0.0010	0.0014	●		
M.1.1	100	1.0	0.0004	0.0005	0.0008	0.0010	0.0014	●		
M.2.1	100	1.0	0.0004	0.0005	0.0008	0.0010	0.0014	●		
M.3.1	100	1.0	0.0004	0.0005	0.0008	0.0010	0.0014	●		
K.1.1	240	1.0	0.0011	0.0013	0.0020	0.0024	0.0033	●	○	○
K.1.2	160	1.0	0.0011	0.0013	0.0020	0.0024	0.0033	●	○	○
K.2.1	240	1.0	0.0008	0.0010	0.0014	0.0017	0.0023	●	○	○
K.2.2	390	1.0	0.0008	0.0010	0.0014	0.0017	0.0023	●	○	○
K.3.1	240	1.0	0.0011	0.0013	0.0020	0.0024	0.0033	●	○	○
K.3.2	200	1.0	0.0011	0.0013	0.0020	0.0024	0.0033	●	○	○
N.1.1										
N.1.2										
N.2.1										
N.2.2										
N.2.3										
N.3.1	390	1.0	0.0008	0.0011	0.0017	0.0022	0.0031	●	○	○
N.3.2	390	1.0	0.0008	0.0011	0.0017	0.0022	0.0031	●	○	○
N.3.3	280	1.0	0.0008	0.0011	0.0017	0.0022	0.0031	●	○	○
N.4.1										
S.1.1	59	1.0	0.0004	0.0005	0.0008	0.0010	0.0014	●		
S.1.2	59	1.0	0.0004	0.0005	0.0008	0.0010	0.0014	●		
S.2.1	59	1.0	0.0004	0.0005	0.0008	0.0010	0.0014	●		
S.2.2	59	1.0	0.0004	0.0005	0.0008	0.0010	0.0014	●		
S.2.3	59	1.0	0.0004	0.0005	0.0008	0.0010	0.0014	●		
S.3.1	98	1.0	0.0004	0.0005	0.0008	0.0010	0.0014	●		
S.3.2	39	1.0	0.0004	0.0005	0.0008	0.0010	0.0014	●		
S.3.3										
H.1.1										
H.1.2										
H.1.3										
H.1.4										
H.2.1										
H.3.1										
O.1.1										
O.1.2										
O.2.1										
O.2.2										
O.3.1										

Cutting Data – P251, P251, P253, P254 – Ball nosed cutter, extra long

59 064 ... / 59 065 ... / 59 066 ... / 59 067 ...										
Ø DC =			1/32"	.060"	3/32"	1/8"	3/16"	● 1st choice	○ suitable	
			a_p 1 x DC	a_p 1 x DC	a_p 1 x DC	a_p 1 x DC	a_p 1 x DC	Emulsion	Compressed air	MMS
Index	V_c ft/min	a_{pmax} x DC	f_z inch	f_z inch	f_z inch	f_z inch	f_z inch			
P.1.1	300	1.0	0.0002	0.0003	0.0004	0.0006	0.0007	●	○	○
P.1.2	260	1.0	0.0002	0.0003	0.0004	0.0006	0.0007	●	○	○
P.1.3	260	1.0	0.0002	0.0003	0.0004	0.0006	0.0007	●	○	○
P.1.4	250	1.0	0.0002	0.0003	0.0004	0.0006	0.0007	●	○	○
P.1.5	250	1.0	0.0002	0.0003	0.0004	0.0006	0.0007	●	○	○
P.2.1	280	1.0	0.0002	0.0003	0.0004	0.0006	0.0007	●	○	○
P.2.2	230	1.0	0.0002	0.0003	0.0004	0.0006	0.0007	●	○	○
P.2.3	230	1.0	0.0002	0.0003	0.0004	0.0006	0.0007	●	○	○
P.2.4	210	1.0	0.0002	0.0003	0.0004	0.0006	0.0007	●	○	○
P.3.1										
P.3.2										
P.3.3										
P.4.1	160	1.0	0.0001	0.0002	0.0003	0.0004	0.0005	●		
P.4.2	70	1.0	0.0001	0.0002	0.0003	0.0004	0.0005	●		
M.1.1	82	1.0	0.0001	0.0002	0.0003	0.0004	0.0005	●		
M.2.1	82	1.0	0.0001	0.0002	0.0003	0.0004	0.0005	●		
M.3.1	82	1.0	0.0001	0.0002	0.0003	0.0004	0.0005	●		
K.1.1	200	1.0	0.0004	0.0007	0.0009	0.0011	0.0013	●	○	○
K.1.2	130	1.0	0.0004	0.0007	0.0009	0.0011	0.0013	●	○	○
K.2.1	200	1.0	0.0004	0.0006	0.0007	0.0008	0.0010	●	○	○
K.2.2	330	1.0	0.0004	0.0006	0.0007	0.0008	0.0010	●	○	○
K.3.1	200	1.0	0.0004	0.0007	0.0009	0.0011	0.0013	●	○	○
K.3.2	160	1.0	0.0004	0.0007	0.0009	0.0011	0.0013	●	○	○
N.1.1										
N.1.2										
N.2.1										
N.2.2										
N.2.3										
N.3.1	330	1.0	0.0002	0.0004	0.0006	0.0008	0.0011	●	○	○
N.3.2	330	1.0	0.0002	0.0004	0.0006	0.0008	0.0011	●	○	○
N.3.3	230	1.0	0.0002	0.0004	0.0006	0.0008	0.0011	●	○	○
N.4.1										
S.1.1	49	1.0	0.0001	0.0002	0.0003	0.0004	0.0005	●		
S.1.2	49	1.0	0.0001	0.0002	0.0003	0.0004	0.0005	●		
S.2.1	49	1.0	0.0001	0.0002	0.0003	0.0004	0.0005	●		
S.2.2	49	1.0	0.0001	0.0002	0.0003	0.0004	0.0005	●		
S.2.3	49	1.0	0.0001	0.0002	0.0003	0.0004	0.0005	●		
S.3.1	82	1.0	0.0001	0.0002	0.0003	0.0004	0.0005	●		
S.3.2	33	1.0	0.0001	0.0002	0.0003	0.0004	0.0005	●		
S.3.3										
H.1.1										
H.1.2										
H.1.3										
H.1.4										
H.2.1										
H.3.1										
O.1.1										
O.1.2										
O.2.1										
O.2.2										
O.3.1										

Cutting Data – P504, P506 – Micro end milling cutter, short

59 009 ... / 59 010...												
Ø DC =			0.005–015"	0.015–031"	0.031–047"	0.047–062"	0.062–078"	0.078–093"	0.093–0120"	● 1st choice	○ suitable	
Index	V _c ft/min	a _{p,max} x DC	a _e	a _e	a _e	a _e	a _e	a _e	a _e	Emulsion	Compressed air	MMS
			0.30 x DC	0.30 x DC	0.30 x DC	0.60 x DC	0.60 x DC	0.60 x DC	0.60 x DC			
			f _z inch	f _z inch	f _z inch	f _z inch	f _z inch	f _z inch	f _z inch			
P.1.1	600	1.0	0.00007	0.00014	0.00021	0.00024	0.00031	0.00036	0.00049	●		
P.1.2	600	1.0	0.00007	0.00014	0.00021	0.00024	0.00031	0.00036	0.00049	●		
P.1.3	200	1.0	0.00006	0.00013	0.00019	0.00022	0.00028	0.00033	0.00045	●		
P.1.4	200	1.0	0.00006	0.00013	0.00019	0.00022	0.00028	0.00033	0.00045	●		
P.1.5	200	1.0	0.00006	0.00013	0.00019	0.00022	0.00028	0.00033	0.00045	●		
P.2.1	200	1.0	0.00006	0.00013	0.00019	0.00022	0.00028	0.00033	0.00045	●		
P.2.2	200	1.0	0.00006	0.00013	0.00019	0.00022	0.00028	0.00033	0.00045	●		
P.2.3	200	1.0	0.00006	0.00013	0.00019	0.00022	0.00028	0.00033	0.00045	●		
P.2.4	100	1.0	0.00003	0.00006	0.00010	0.00011	0.00014	0.00017	0.00022	●		
P.3.1	150	1.0	0.00004	0.00008	0.00012	0.00014	0.00017	0.00021	0.00028	●		
P.3.2	150	1.0	0.00004	0.00008	0.00012	0.00014	0.00017	0.00021	0.00028	●		
P.3.3	90	1.0	0.00002	0.00004	0.00006	0.00007	0.00009	0.00012	0.00018	●		
P.4.1	450	1.0	0.00007	0.00014	0.00021	0.00024	0.00031	0.00036	0.00049	●		
P.4.2	450	1.0	0.00007	0.00014	0.00021	0.00024	0.00031	0.00036	0.00049	●		
M.1.1	200	1.0	0.00006	0.00013	0.00019	0.00022	0.00028	0.00033	0.00045	●		
M.2.1	200	1.0	0.00003	0.00006	0.00010	0.00011	0.00014	0.00017	0.00022	●		
M.3.1	100	1.0	0.00003	0.00006	0.00010	0.00011	0.00014	0.00017	0.00022	●		
K.1.1	400	1.0	0.00007	0.00014	0.00021	0.00024	0.00031	0.00036	0.00049	●		
K.1.2	400	1.0	0.00007	0.00014	0.00021	0.00024	0.00031	0.00036	0.00049	●		
K.2.1	300	1.0	0.00007	0.00014	0.00021	0.00024	0.00031	0.00036	0.00049	●		
K.2.2	300	1.0	0.00007	0.00014	0.00021	0.00024	0.00031	0.00036	0.00049	●		
K.3.1	250	1.0	0.00007	0.00014	0.00021	0.00024	0.00031	0.00036	0.00049	●		
K.3.2	250	1.0	0.00007	0.00014	0.00021	0.00024	0.00031	0.00036	0.00049	●		
N.1.1	1000	1.0	0.00022	0.00045	0.00068	0.00078	0.00099	0.00118	0.00158	●		
N.1.2	1000	1.0	0.00022	0.00045	0.00068	0.00078	0.00099	0.00118	0.00158	●		
N.2.1	750	1.0	0.00022	0.00045	0.00068	0.00078	0.00099	0.00118	0.00158	●		
N.2.2	750	1.0	0.00022	0.00045	0.00068	0.00078	0.00099	0.00118	0.00158	●		
N.2.3												
N.3.1	500	1.0	0.00017	0.00036	0.00055	0.00063	0.00079	0.00094	0.00127	●		
N.3.2	800	1.0	0.00017	0.00036	0.00055	0.00063	0.00079	0.00094	0.00127	●		
N.3.3	400	1.0	0.00017	0.00036	0.00055	0.00063	0.00079	0.00094	0.00127	●		
N.4.1	1500	1.0	0.00022	0.00045	0.00068	0.00078	0.00099	0.00118	0.00158	●		
S.1.1	70	1.0	0.00004	0.00008	0.00012	0.00014	0.00017	0.00021	0.00028	●		
S.1.2	50	1.0	0.00002	0.00004	0.00006	0.00007	0.00009	0.00012	0.00018	●		
S.2.1	70	1.0	0.00004	0.00008	0.00012	0.00014	0.00017	0.00021	0.00028	●		
S.2.2	50	1.0	0.00002	0.00004	0.00006	0.00007	0.00009	0.00012	0.00018	●		
S.2.3	50	1.0	0.00002	0.00004	0.00006	0.00007	0.00009	0.00012	0.00018	●		
S.3.1	200	1.0	0.00004	0.00008	0.00012	0.00014	0.00017	0.00021	0.00028	●		
S.3.2	150	1.0	0.00004	0.00008	0.00012	0.00014	0.00017	0.00021	0.00028	●		
S.3.3	75	1.0	0.00002	0.00004	0.00006	0.00007	0.00009	0.00012	0.00018	●		
H.1.1												
H.1.2												
H.1.3												
H.1.4												
H.2.1												
H.3.1												
O.1.1												
O.1.2												
O.2.1												
O.2.2												
O.3.1												

Cutting Data – P501, P503 – Micro End Milling Cutter, long

59 007 ... / 59 008 ...												
Ø DC =			0.005–015"		0.015–031"		0.031–047"		0.047–062"		0.062–078"	
			a_e 0.13 x DC	a_e 0.25 x DC	a_e 0.13 x DC	a_e 0.25 x DC	a_e 0.13 x DC	a_e 0.25 x DC	a_e 0.13 x DC	a_e 0.25 x DC	a_e .13 x DC	a_e 0.25 x DC
Index	V_c ft/min	a_{pmax} x DC	f_z inch	f_z inch	f_z inch	f_z inch	f_z inch	f_z inch	f_z inch	f_z inch	f_z inch	f_z inch
P.1.1	600	3.0	0.00005		0.00010		0.00015			0.00170		0.00021
P.1.2	600	3.0	0.00005		0.00010		0.00015			0.00170		0.00021
P.1.3	200	3.0	0.00004		0.00009		0.00013			0.00020		0.00025
P.1.4	200	3.0	0.00004		0.00009		0.00013			0.00020		0.00025
P.1.5	200	3.0	0.00004		0.00009		0.00013			0.00020		0.00025
P.2.1	200	3.0	0.00004		0.00009		0.00013			0.00015		0.00019
P.2.2	200	3.0	0.00004		0.00009		0.00013			0.00015		0.00019
P.2.3	200	3.0	0.00004		0.00009		0.00013			0.00015		0.00019
P.2.4	100	3.0	0.00002		0.00004		0.00007			0.00008		0.00100
P.3.1	150	3.0	0.00003		0.00006		0.00008			0.00010		0.00012
P.3.2	150	3.0	0.00003		0.00006		0.00008			0.00010		0.00012
P.3.3	90	3.0	0.00001		0.00003		0.00004			0.00005		0.00006
P.4.1	450	3.0	0.00005		0.00010		0.00015			0.00017		0.00021
P.4.2	450	3.0	0.00005		0.00010		0.00015			0.00017		0.00021
M.1.1	200	3.0	0.00004		0.00009		0.00013			0.00015		0.00019
M.2.1	200	3.0	0.00002		0.00004		0.00007			0.00008		0.00100
M.3.1	100	3.0	0.00002		0.00004		0.00007			0.00008		0.00100
K.1.1	400	3.0	0.00005		0.00010		0.00015			0.00017		0.00021
K.1.2	400	3.0	0.00005		0.00010		0.00015			0.00017		0.00021
K.2.1	300	3.0	0.00005		0.00010		0.00015			0.00017		0.00021
K.2.2	300	3.0	0.00005		0.00010		0.00015			0.00017		0.00021
K.3.1	250	3.0	0.00005		0.00010		0.00015			0.00017		0.00021
K.3.2	250	3.0	0.00005		0.00010		0.00015			0.00017		0.00021
N.1.1	1000	3.0	0.00015		0.00031		0.00047			0.00055		0.00069
N.1.2	1000	3.0	0.00015		0.00031		0.00047			0.00055		0.00069
N.2.1	750	3.0	0.00015		0.00031		0.00047			0.00055		0.00069
N.2.2	750	3.0	0.00015		0.00031		0.00047			0.00055		0.00069
N.2.3												
N.3.1	500	3.0	0.00012		0.00025		0.00038		0.00044		0.00055	
N.3.2	800	3.0	0.00015		0.00031		0.00048		0.00055		0.00069	
N.3.3	400	3.0	0.00012		0.00025		0.00038		0.00044		0.00055	
N.4.1	1500	3.0	0.00015		0.00031		0.00048		0.00055		0.00069	
S.1.1	70	3.0	0.00003		0.00006		0.00009			0.00010		0.00012
S.1.2	50	3.0	0.00001		0.00003		0.00004			0.00005		0.00006
S.2.1	70	3.0	0.00003		0.00006		0.00009			0.00010		0.00012
S.2.2	50	3.0	0.00003		0.00006		0.00009			0.00010		0.00012
S.2.3	50	3.0	0.00001		0.00003		0.00004			0.00005		0.00006
S.3.1	200	3.0	0.00003		0.00006		0.00008			0.00010		0.00012
S.3.2	150	3.0	0.00003		0.00006		0.00008			0.00010		0.00012
S.3.3	75	3.0	0.00001		0.00003		0.00004			0.00005		0.00006
H.1.1												
H.1.2												
H.1.3												
H.1.4												
H.2.1												
H.3.1												
O.1.1												
O.1.2												
O.2.1												
O.2.2												
O.3.1												

		59 007 ... / 59 008 ...						
		0.078-093"		0.093-0120"		●	1st choice	
		0.13 x DC		0.25 x DC		○	suitable	
		a_p	a_p	a_p	a_p	Emulsion	Compressed air	MMS
		0.13 x DC	0.25 x DC	0.13 x DC	0.25 x DC			
Index	f_z	f_z	f_z	f_z	f_z			
	inch	inch	inch	inch	inch			
P.1.1			0.00025		0.00034	●		
P.1.2			0.00025		0.00034	●		
P.1.3			0.00030		0.00040	●		
P.1.4			0.00030		0.00040	●		
P.1.5			0.00030		0.00040	●		
P.2.1			0.00023		0.00031	●		
P.2.2			0.00023		0.00031	●		
P.2.3			0.00023		0.00031	●		
P.2.4			0.00012		0.00016	●		
P.3.1			0.00014		0.00019	●		
P.3.2			0.00014		0.00019	●		
P.3.3			0.00007		0.00010	●		
P.4.1			0.00025		0.00034	●		
P.4.2			0.00025		0.00034	●		
M.1.1			0.00023		0.00031	●		
M.2.1			0.00012		0.00016	●		
M.3.1			0.00012		0.00016	●		
K.1.1			0.00025		0.00034	●		
K.1.2			0.00025		0.00034	●		
K.2.1			0.00025		0.00034	●		
K.2.2			0.00025		0.00034	●		
K.3.1			0.00025		0.00034	●		
K.3.2			0.00025		0.00034	●		
N.1.1			0.00082		0.00110	●		
N.1.2			0.00082		0.00110	●		
N.2.1			0.00082		0.00110	●		
N.2.2			0.00082		0.00110	●		
N.2.3								
N.3.1	0.00065			0.00088		●		
N.3.2	0.00082			0.00110		●		
N.3.3	0.00065			0.00088		●		
N.4.1	0.00082			0.00110		●		
S.1.1			0.00014		0.00019	●		
S.1.2			0.00007		0.00010	●		
S.2.1			0.00014		0.00019	●		
S.2.2			0.00014		0.00019	●		
S.2.3			0.00007		0.00010	●		
S.3.1			0.00014		0.00019	●		
S.3.2			0.00014		0.00019	●		
S.3.3			0.00007		0.00010	●		
H.1.1								
H.1.2								
H.1.3								
H.1.4								
H.2.1								
H.3.1								
O.1.1								
O.1.2								
O.2.1								
O.2.2								
O.3.1								

Cutting Data – P137 – Profile milling cutter

59 049 ... / 59 050 ...									
Ø DC =			1/8"	3/16"	1/4–5/16"	3/8"	● 1st choice ○ suitable		
			a_p 1 x DC	a_p 1 x DC	a_p 1 x DC	a_p 1 x DC	Emulsion	Compressed air	MMS
Index	V_c ft/min	a_{pmax} x DC	f_z inch	f_z inch	f_z inch	f_z inch			
P.1.1	310	1.0	0.0006	0.0007	0.0011	0.0013	●	○	○
P.1.2	260	1.0	0.0006	0.0007	0.0011	0.0013	●	○	○
P.1.3	260	1.0	0.0006	0.0007	0.0011	0.0013	●	○	○
P.1.4	230	1.0	0.0006	0.0007	0.0011	0.0013	●	○	○
P.1.5	230	1.0	0.0006	0.0007	0.0011	0.0013	●	○	○
P.2.1	250	1.0	0.0006	0.0007	0.0011	0.0013	●	○	○
P.2.2	200	1.0	0.0006	0.0007	0.0011	0.0013	●	○	○
P.2.3	200	1.0	0.0006	0.0007	0.0011	0.0013	●	○	○
P.2.4	180	1.0	0.0006	0.0007	0.0011	0.0013	●	○	○
P.3.1									
P.3.2									
P.3.3									
P.4.1									
P.4.2									
M.1.1									
M.2.1									
M.3.1									
K.1.1	390	1.0	0.0011	0.0013	0.0020	0.0024	●	○	○
K.1.2	330	1.0	0.0011	0.0013	0.0020	0.0024	●	○	○
K.2.1	390	1.0	0.0008	0.0010	0.0014	0.0017	●	○	○
K.2.2	330	1.0	0.0008	0.0010	0.0014	0.0017	●	○	○
K.3.1	390	1.0	0.0011	0.0013	0.0020	0.0024	●	○	○
K.3.2	330	1.0	0.0011	0.0013	0.0020	0.0024	●	○	○
N.1.1									
N.1.2									
N.2.1									
N.2.2									
N.2.3									
N.3.1									
N.3.2									
N.3.3									
N.4.1									
S.1.1									
S.1.2									
S.2.1									
S.2.2									
S.2.3									
S.3.1									
S.3.2									
S.3.3									
H.1.1									
H.1.2									
H.1.3									
H.1.4									
H.2.1									
H.3.1									
O.1.1									
O.1.2									
O.2.1									
O.2.2									
O.3.1									

Cutting Data – P139 – Profile milling cutter

		59 051 ... / 59 052 ...								
		Ø DC =		3/16"	1/4"	3/8"	1/2"	● 1st choice		
				a_p 1 x DC	a_p 1 x DC	a_p 1 x DC	a_p 1 x DC	○ suitable		
Index	V_c ft/min	a_{pmax} x DC	f_z inch	f_z inch	f_z inch	f_z inch	Emulsion	Compressed air	MMS	
P.1.1	310	1.0	0.0007	0.0011	0.0013	0.0018	●	○	○	
P.1.2	260	1.0	0.0007	0.0011	0.0013	0.0018	●	○	○	
P.1.3	260	1.0	0.0007	0.0011	0.0013	0.0018	●	○	○	
P.1.4	230	1.0	0.0007	0.0011	0.0013	0.0018	●	○	○	
P.1.5	230	1.0	0.0007	0.0011	0.0013	0.0018	●	○	○	
P.2.1	250	1.0	0.0007	0.0011	0.0013	0.0018	●	○	○	
P.2.2	200	1.0	0.0007	0.0011	0.0013	0.0018	●	○	○	
P.2.3	200	1.0	0.0007	0.0011	0.0013	0.0018	●	○	○	
P.2.4	180	1.0	0.0007	0.0011	0.0013	0.0018	●	○	○	
P.3.1										
P.3.2										
P.3.3										
P.4.1										
P.4.2										
M.1.1										
M.2.1										
M.3.1										
K.1.1	390	1.0	0.0013	0.0020	0.0024	0.0033	●	○	○	
K.1.2	330	1.0	0.0013	0.0020	0.0024	0.0033	●	○	○	
K.2.1	390	1.0	0.0010	0.0014	0.0017	0.0023	●	○	○	
K.2.2	330	1.0	0.0010	0.0014	0.0017	0.0023	●	○	○	
K.3.1	390	1.0	0.0013	0.0020	0.0024	0.0033	●	○	○	
K.3.2	330	1.0	0.0013	0.0020	0.0024	0.0033	●	○	○	
N.1.1										
N.1.2										
N.2.1										
N.2.2										
N.2.3										
N.3.1										
N.3.2										
N.3.3										
N.4.1										
S.1.1										
S.1.2										
S.2.1										
S.2.2										
S.2.3										
S.3.1										
S.3.2										
S.3.3										
H.1.1										
H.1.2										
H.1.3										
H.1.4										
H.2.1										
H.3.1										
O.1.1										
O.1.2										
O.2.1										
O.2.2										
O.3.1										

Cutting Data – P132/P134 – Chamfer milling cutter

59 041 ... / 59 042 ... / 59 045 ... / 59 046 ...										
Ø DC =			1/8"	3/16"	1/4"	3/8"	1/2"	● 1st choice ○ suitable		
			a_p 1 x DC	a_p 1 x DC	a_p 1 x DC	a_p 1 x DC	a_p 1 x DC	Emulsion	Compressed air	MMS
Index	V_c ft/min	a_{pmax} x DC	f_z inch	f_z inch	f_z inch	f_z inch	f_z inch			
P.1.1	310	1.0	0.0006	0.0007	0.0011	0.0013	0.0018	●	○	○
P.1.2	260	1.0	0.0006	0.0007	0.0011	0.0013	0.0018	●	○	○
P.1.3	260	1.0	0.0006	0.0007	0.0011	0.0013	0.0018	●	○	○
P.1.4	230	1.0	0.0006	0.0007	0.0011	0.0013	0.0018	●	○	○
P.1.5	230	1.0	0.0006	0.0007	0.0011	0.0013	0.0018	●	○	○
P.2.1	250	1.0	0.0006	0.0007	0.0011	0.0013	0.0018	●	○	○
P.2.2	200	1.0	0.0006	0.0007	0.0011	0.0013	0.0018	●	○	○
P.2.3	200	1.0	0.0006	0.0007	0.0011	0.0013	0.0018	●	○	○
P.2.4	180	1.0	0.0006	0.0007	0.0011	0.0013	0.0018	●	○	○
P.3.1										
P.3.2										
P.3.3										
P.4.1										
P.4.2										
M.1.1										
M.2.1										
M.3.1										
K.1.1	390	1.0	0.0011	0.0013	0.0020	0.0024	0.0033	●	○	○
K.1.2	330	1.0	0.0011	0.0013	0.0020	0.0024	0.0033	●	○	○
K.2.1	390	1.0	0.0008	0.0010	0.0014	0.0017	0.0023	●	○	○
K.2.2	330	1.0	0.0008	0.0010	0.0014	0.0017	0.0023	●	○	○
K.3.1	390	1.0	0.0011	0.0013	0.0020	0.0024	0.0033	●	○	○
K.3.2	330	1.0	0.0011	0.0013	0.0020	0.0024	0.0033	●	○	○
N.1.1										
N.1.2										
N.2.1										
N.2.2										
N.2.3										
N.3.1										
N.3.2										
N.3.3										
N.4.1										
S.1.1										
S.1.2										
S.2.1										
S.2.2										
S.2.3										
S.3.1										
S.3.2										
S.3.3										
H.1.1										
H.1.2										
H.1.3										
H.1.4										
H.2.1										
H.3.1										
O.1.1										
O.1.2										
O.2.1										
O.2.2										
O.3.1										

Cutting Data – P130 – Chamfer milling cutter

		59 037 ... / 59 038 ...						
		Ø DC =						
		1/4"	3/8"	1/2"	● 1st choice	○ suitable		
		a_p 1 x DC	a_p 1 x DC	a_p 1 x DC	Emulsion	Compressed air	MMS	
Index	V_c ft/min	a_{pmax} x DC	f_z inch	f_z inch				f_z inch
P.1.1	310	1.0	0.0011	0.0013	0.0018	●	○	○
P.1.2	260	1.0	0.0011	0.0013	0.0018	●	○	○
P.1.3	260	1.0	0.0011	0.0013	0.0018	●	○	○
P.1.4	230	1.0	0.0011	0.0013	0.0018	●	○	○
P.1.5	230	1.0	0.0011	0.0013	0.0018	●	○	○
P.2.1	250	1.0	0.0011	0.0013	0.0018	●	○	○
P.2.2	200	1.0	0.0011	0.0013	0.0018	●	○	○
P.2.3	200	1.0	0.0011	0.0013	0.0018	●	○	○
P.2.4	180	1.0	0.0011	0.0013	0.0018	●	○	○
P.3.1								
P.3.2								
P.3.3								
P.4.1								
P.4.2								
M.1.1								
M.2.1								
M.3.1								
K.1.1	390	1.0	0.0020	0.0024	0.0033	●	○	○
K.1.2	330	1.0	0.0020	0.0024	0.0033	●	○	○
K.2.1	390	1.0	0.0014	0.0017	0.0023	●	○	○
K.2.2	330	1.0	0.0014	0.0017	0.0023	●	○	○
K.3.1	390	1.0	0.0020	0.0024	0.0033	●	○	○
K.3.2	330	1.0	0.0020	0.0024	0.0033	●	○	○
N.1.1								
N.1.2								
N.2.1								
N.2.2								
N.2.3								
N.3.1								
N.3.2								
N.3.3								
N.4.1								
S.1.1								
S.1.2								
S.2.1								
S.2.2								
S.2.3								
S.3.1								
S.3.2								
S.3.3								
H.1.1								
H.1.2								
H.1.3								
H.1.4								
H.2.1								
H.3.1								
O.1.1								
O.1.2								
O.2.1								
O.2.2								
O.3.1								

Cutting Data – P133 – Chamfer milling cutter

59 043 ... / 59 044 ...								
Ø DC =			1/8"	3/16"	1/4"	● 1st choice	○ suitable	
			a_p 1 x DC	a_p 1 x DC	a_p 1 x DC	Emulsion	Compressed air	MMS
Index	V_c ft/min	a_{pmax} x DC	f_z inch	f_z inch	f_z inch			
P.1.1	310	1.0	0.0011	0.0013	0.0018	●	○	○
P.1.2	260	1.0	0.0011	0.0013	0.0018	●	○	○
P.1.3	260	1.0	0.0011	0.0013	0.0018	●	○	○
P.1.4	230	1.0	0.0011	0.0013	0.0018	●	○	○
P.1.5	230	1.0	0.0011	0.0013	0.0018	●	○	○
P.2.1	250	1.0	0.0011	0.0013	0.0018	●	○	○
P.2.2	200	1.0	0.0011	0.0013	0.0018	●	○	○
P.2.3	200	1.0	0.0011	0.0013	0.0018	●	○	○
P.2.4	180	1.0	0.0011	0.0013	0.0018	●	○	○
P.3.1								
P.3.2								
P.3.3								
P.4.1								
P.4.2								
M.1.1								
M.2.1								
M.3.1								
K.1.1	390	1.0	0.0020	0.0024	0.0033	●	○	○
K.1.2	330	1.0	0.0020	0.0024	0.0033	●	○	○
K.2.1	390	1.0	0.0014	0.0017	0.0023	●	○	○
K.2.2	330	1.0	0.0014	0.0017	0.0023	●	○	○
K.3.1	390	1.0	0.0020	0.0024	0.0033	●	○	○
K.3.2	330	1.0	0.0020	0.0024	0.0033	●	○	○
N.1.1								
N.1.2								
N.2.1								
N.2.2								
N.2.3								
N.3.1								
N.3.2								
N.3.3								
N.4.1								
S.1.1								
S.1.2								
S.2.1								
S.2.2								
S.2.3								
S.3.1								
S.3.2								
S.3.3								
H.1.1								
H.1.2								
H.1.3								
H.1.4								
H.2.1								
H.3.1								
O.1.1								
O.1.2								
O.2.1								
O.2.2								
O.3.1								

Cutting Data – P131/P135 – Chamfer milling cutter

		59 039 ... / 59 040 ... / 59 047 ... / 59 048 ...							
		Ø DC =		1/4"	3/8"	1/2"	● 1st choice	○ suitable	
				a_p 1 x DC	a_p 1 x DC	a_p 1 x DC	Emulsion	Compressed air	MMS
Index	V_c ft/min	a_{pmax} x DC	f_z inch	f_z inch	f_z inch				
P.1.1	310	1.0	0.0011	0.0013	0.0018	●	○	○	
P.1.2	260	1.0	0.0011	0.0013	0.0018	●	○	○	
P.1.3	260	1.0	0.0011	0.0013	0.0018	●	○	○	
P.1.4	230	1.0	0.0011	0.0013	0.0018	●	○	○	
P.1.5	230	1.0	0.0011	0.0013	0.0018	●	○	○	
P.2.1	250	1.0	0.0011	0.0013	0.0018	●	○	○	
P.2.2	200	1.0	0.0011	0.0013	0.0018	●	○	○	
P.2.3	200	1.0	0.0011	0.0013	0.0018	●	○	○	
P.2.4	180	1.0	0.0011	0.0013	0.0018	●	○	○	
P.3.1									
P.3.2									
P.3.3									
P.4.1									
P.4.2									
M.1.1									
M.2.1									
M.3.1									
K.1.1	390	1.0	0.0020	0.0024	0.0033	●	○	○	
K.1.2	330	1.0	0.0020	0.0024	0.0033	●	○	○	
K.2.1	390	1.0	0.0014	0.0017	0.0023	●	○	○	
K.2.2	330	1.0	0.0014	0.0017	0.0023	●	○	○	
K.3.1	390	1.0	0.0020	0.0024	0.0033	●	○	○	
K.3.2	330	1.0	0.0020	0.0024	0.0033	●	○	○	
N.1.1									
N.1.2									
N.2.1									
N.2.2									
N.2.3									
N.3.1									
N.3.2									
N.3.3									
N.4.1									
S.1.1									
S.1.2									
S.2.1									
S.2.2									
S.2.3									
S.3.1									
S.3.2									
S.3.3									
H.1.1									
H.1.2									
H.1.3									
H.1.4									
H.2.1									
H.3.1									
O.1.1									
O.1.2									
O.2.1									
O.2.2									
O.3.1									

Technical references

Feedrate Adjustment

If the rpm indicated in the tables cannot be obtained by the machine spindle, the feed rate is to be reduced proportionally to the max rpm.

Example:

according to table = n 50000/min. and v_f 40 inch/min.,
maximum machine rpm = 40000/min.

Calculation of feed rate which can be applied:

$40000 = 80\%$ of 50000/min. accordingly 80% of 40 = 32 inch/min.

Feed rate which can be applied = **32 inch/min.**

Angled ramping with solid carbide cutters

Angled ramping with solid carbide cutters is possible at an angle of 3° to 6° depending on the cutter type.

A protective edge chamfer or corner radius is an advantage.

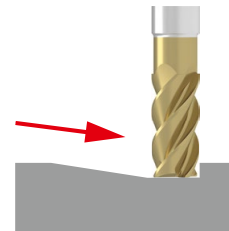

S.F.M./R.P.M. CONVERSION CHART															
DIAMETER															
S.F.M.	1/16	3/32	1/8	5/32	3/16	7/32	1/4	5/16	3/8	7/16	1/2	5/8	3/4	7/8	1
50	3.050	2.040	1.530	1.220	1.020	875	765	610	510	440	380	310	250	220	190
75	4.580	3.060	2.290	1.830	1.530	1.310	1.150	920	760	660	570	460	380	330	285
100	6.100	4.080	3.050	2.450	2.040	1.750	1.530	1.220	1.020	870	760	610	510	440	385
125	7.630	5.100	3.820	3.050	2.550	2.180	1.920	1.530	1.270	1.100	950	770	630	550	475
150	9.150	6.120	4.570	3.670	3.060	2.620	2.290	1.83	1.530	1.310	1.140	920	760	660	575
175	10.680	7.140	5.350	4.270	3.570	3.060	2.680	2.140	1.780	1.540	1.330	1.080	880	770	665
200	12.200	8.150	6.100	4.900	4.070	3.500	3.100	2.450	2.00	1.750	1.500	1.200	1.000	875	750
300	18.500	12.200	9.200	7.300	6.100	5.250	4.600	3.700	3.100	2.600	2.300	1.800	1.500	1.300	1.100
400	24.500	16.300	12.200	9.800	8.150	7.000	6.100	4.900	4.100	3.500	3.050	2.450	2.050	1.750	1.525
500	30.500	20.400	15.300	12.200	10.200	8.700	7.600	6.100	5.100	4.400	3.800	3.100	2.500	2.200	1.900
750	45.800	36.700	22.900	18.300	15.300	13.100	11.500	9.200	7.600	6.550	5.700	4.600	3.800	3.700	2.850
1.000	-	40.800	30.600	24.500	20.400	17.500	15.300	12.200	103200	8.750	7.650	6.100	5.100	4.400	3.800
1.500	-	-	45.900	36.700	30.600	26.200	22.900	18.300	15.300	13.150	11.300	9.200	7.600	6.500	5.700
2.000	-	-	-	49.000	40.800	35.000	30.600	24.400	20.400	17.500	15.300	12.200	10.200	8.700	7.600
3.000	-	-	-	-	-	52.500	45.900	36.600	30.600	26.250	22.900	18.300	15.300	13.100	11.400
4.000	-	-	-	-	-	-	-	48.800	40.800	35.000	30.600	24.400	20.400	17.500	15.200
5.000	-	-	-	-	-	-	-	-	-	43.700	38.200	30.600	25.500	21.800	19.000

General formula for calculating the cutting parameters

Designation	Abbreviation	Unit	Formula	Example
Number of revolutions	n	min ⁻¹	$n = \frac{v_c \times 12}{DC \times \pi}$	$v_c = 80 \text{ ft/min}$ $DC = 0.75 \text{ inch}$ $n = \frac{80 \times 12}{0.75 \times \pi} = 408 \text{ min}^{-1}$
Cutting speed	v_c	ft/min	$v_c = \frac{DC \times \pi \times n}{12}$	$n = 400 \text{ min}^{-1}$ $DC = 0.75 \text{ inch}$ $v_c = \frac{0.75 \times \pi \times 400}{12} = 78 \text{ ft/min}$
Feed per tooth	f_z	inch	$f_z = \frac{v_f}{Z\text{EFP} \times n}$	$v_f = 12.8 \text{ inch/min}$ $n = 400 \text{ min}^{-1}$ $Z\text{EFP} = 4$ $f_z = \frac{12.8}{4 \times 400} = 0.008 \text{ inch}$
Feed per revolution	f	inch/rev	$f = f_z \times Z\text{EFP}$	$f_z = 0.008 \text{ inch}$ $Z\text{EFP} = 4$ $f = 0.008 \times 4 = 0.032 \text{ inch/rev}$
Feed rate	v_f	inch/min.	$v_f = f_z \times Z\text{EFP} \times n$	$f_z = 0.008$ $Z\text{EFP} = 4$ $n = 400 \text{ min}^{-1}$ $v_f = 0.008 \times 4 \times 400 = 12.8 \text{ inch/min}$
Average chip thickness	h_m	inch	$h_m = f_z \times \sqrt{\frac{a_e}{DC}}$	$f_z = 0.008 \text{ inch}$ $a_e = 0.012 \text{ inch}$ $DC = 0.75$ $h_m = 0.008 \times \sqrt{\frac{0.012}{0.75}} = 0.001 \text{ inch}$

ZEFP = Number of flutes
 a_e = cutting width

Calculation of the feed rate on the midpoint path of the milling cutter (v_{fM})

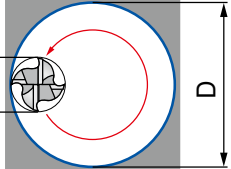
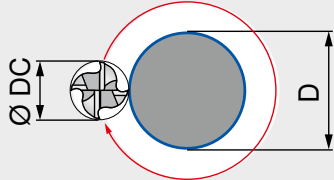
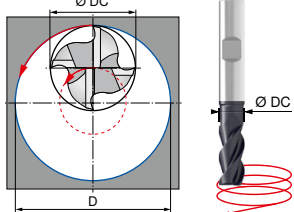
Designation	Abbreviation	Unit	Formula	Example
Internal contour	v_{fM}	inch/min.	$v_{fM} = \frac{v_f \times (D - DC)}{D}$	
Outside profile	v_{fM}	inch/min.	$v_{fM} = \frac{v_f \times (D + DC)}{D}$	
Helical ramping	v_{fM}	inch/min.	$v_{fM} = \frac{n \times f_z \times Z\text{EFP} \times (D - D_c)}{D}$	

Tips for Tool Selection

Rake and helix angles combined with the coating are decisive factors for the operational area.

Characteristics	Benefits
Helix angle with slow spiral	
<ul style="list-style-type: none"> ▲ For materials with high tensile strength ▲ For high material removal rates ▲ For slot milling, pocket milling, rough milling 	<ul style="list-style-type: none"> ▲ High edge stability ▲ Low tendency to edge chipping
Helix angle with quick spiral	
<ul style="list-style-type: none"> ▲ For soft steels, non ferrous metals, etc. ▲ For low material removal rates ▲ Typical for finishing processes 	<ul style="list-style-type: none"> ▲ Soft cut ▲ Low cutting forces
Small rake angles are applied	
<ul style="list-style-type: none"> ▲ For hard, brittle materials ▲ For high material removal rates ▲ For rough machining 	<ul style="list-style-type: none"> ▲ High edge stability ▲ Low tendency to edge chipping
Large rake angles are applied	
<ul style="list-style-type: none"> ▲ For soft materials ▲ For low material removal rates ▲ For finishing 	<ul style="list-style-type: none"> ▲ Soft cut ▲ Low cutting forces ▲ Favorable chip flow ▲ Low tendency to stick

Correction factor for solid carbide milling cutters

Factors for cutting speed (v_c) and feed rate (f_z) in relation to the overhang length (LPR)

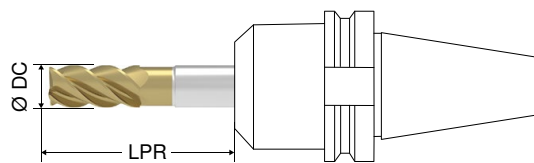

Length					
Overhang length (LPR)	1.5 x DC	4 x DC	8 x DC	12 x DC	> 12 x DC
Factor for v_c ($K_f v_c$)	1.0	1.0	0.9	0.85	0.7
Factor for f_z ($K_f f_z$)	1.2	1.0	0.8	0.7	0.5

Factors for cutting speed (v_c) and feed rate (f_z) in relation to the cutting depth (a_p) and cutting width (a_e)

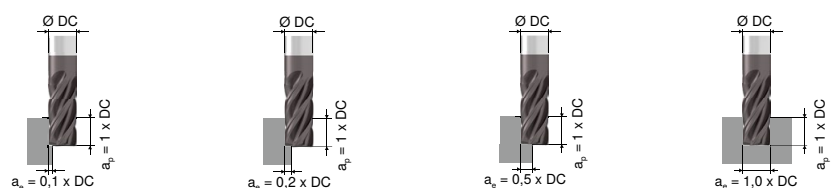

Factor for v_c ($K_f v_c$)	1.3	1.1	1.0	0.85
Factor for f_z ($K_f f_z$)	1.5	1.3	1.0	0.8

Calculation aid for copy milling

Theoretical surface roughness (R_{th}) and step over (b_r)

$$R_{th} = r - \sqrt{\frac{(r \times 2)^2 - b_r^2}{4}}$$

$$b_r = 2 \times \sqrt{R_{th} \times (r \times 2 - R_{th})}$$

$$R_{th} \approx R_a / 0.1$$

$$R_a \approx 0.1 \times R_{th}$$

When copy milling, in order to achieve as smooth a surface as possible, the step over b_r should be adapted to the cutter diameter DC. The smaller the cutter diameter DC is, the smaller the step over b_r must be.

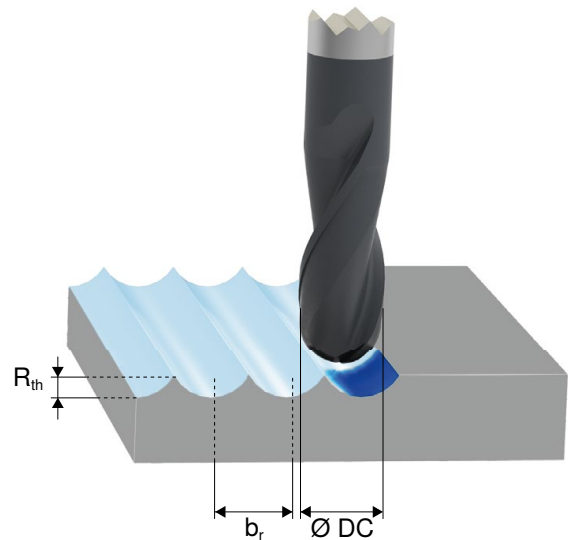

RPM correction factor (Kf n) for copy milling

$$n = \frac{v_c \times 12}{DC \times \pi} \times Kf n$$

Rough machining

	Peripheral and ball nose copy milling	Ball nose copy milling	
Axial milling depth a_p	0.5 x DC	> 0.5 x DC	0.2 x DC - 0.5 x DC
Step over b_r	1 x DC	0.2 x DC - 0.5 x DC	0.2 x DC - 0.5 x DC
Correction factor (Kf n)	1	1	1.1

Finish milling

	Ball nose copy milling		
Axial milling depth a_p	< 0.2 x DC	0.2 x DC - 0.5 x DC	> 0.5 x DC
Step over b_r	< 0.2 x DC	< 0.2 x DC	< 0.2 x DC
Correction factor (Kf n)	2	1.3	1

Calculation aid for copy milling

For peripheral milling or ball nosed copy milling at cutting depths of $a_p \geq 0.5 \times DC$ and $a_e = 0.2 \text{ to } 0.5 \times DC$ the rpm can be calculated with the following formula:

$$n = \frac{v_c \times 12}{DC \times \pi}$$

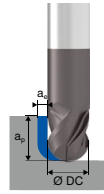

When ball milling the effective milling diameter d_{eff} must be determined using the following formula:

Ball nose milling cutters

$$d_{eff} = 2 \times \sqrt{a_p \times (DC - a_p)}$$

$$d_{eff} = DC \times \sin \left(\beta \pm \arccos \left(\frac{DC - 2a_p}{DC} \right) \right)$$

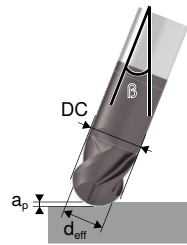
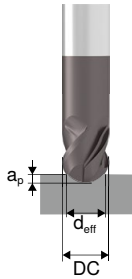

Torus end milling cutters

$$d_{eff} = (DC - 2RE) + 2 \times \sqrt{a_p \times (2RE - a_p)}$$

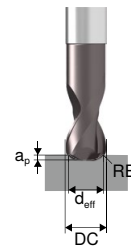

Information concerning plunge and draw milling

- ① When machining the profile flanks relatively high feed rates are possible as the cutting depth is relatively low (area highlighted in blue).
- ② A large increase in cutting depth occurs when the base of the profile is reached. Here the feed rate must be reduced as otherwise tool breakage can occur due to vibrations, misalignment or chattering.
- ③ As soon as the cutting depth decreases during the machining of the profile base, the feed rate can be increased again.

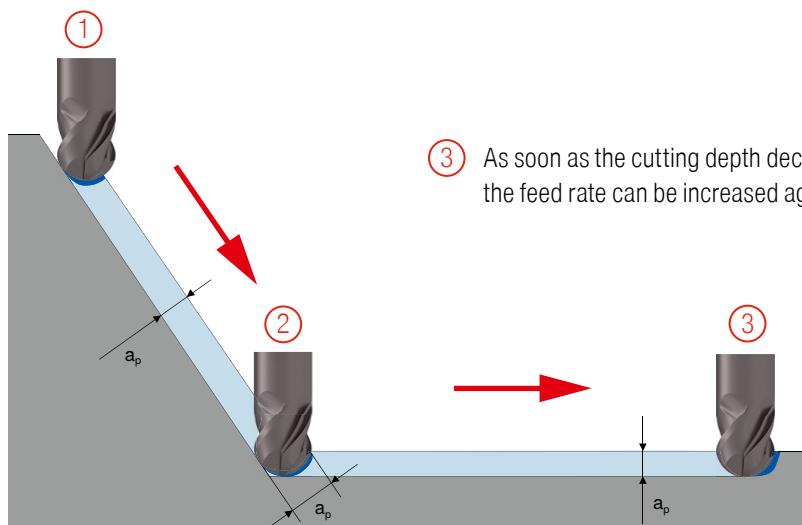

Rule:

The steeper the angle, the lower the feed rate.
The shallower the angle, the larger the feed rate.

ⓘ When plunge or draw milling dies, the feed rate has to be adapted to the various milling positions. Otherwise the cutting edge can be damaged due to overload (vibrations, misalignment or chattering).

Tool types

AL	Aluminium and Non-Ferrous Material
ST	Steel and Steel Alloys

Ti	Titanium and Titanium Alloys
UN	Universal

Coatings

ALTiN	<ul style="list-style-type: none"> ▲ Monolayer coating ▲ HV0.05 = 3500 ▲ Coefficient of friction (against steel) = 0.30 ▲ Maximum application temperature: 1000°C
ZrN	<ul style="list-style-type: none"> ▲ Monolayer coating ▲ HV0.05 = 2500 ▲ Coefficient of friction (against steel) = 0.30 ▲ Maximum application temperature: 650°C

DPAU72S DRAGONSKIN	<ul style="list-style-type: none"> ▲ Monolayer coating ▲ HV0.05 = 3800 ▲ Coefficient of friction (against steel) = 0.35 ▲ Maximum application temperature: 1100°C
DPXU72S DRAGONSKIN	<ul style="list-style-type: none"> ▲ ALCrN/SiN Nano Composite coating ▲ HV0.05 = 3700 ▲ Coefficient of friction (against steel) = 0.30 ▲ Maximum application temperature: 1100°C